

ASUS[®]

RS720Q-E7 / RS12

RS724Q-E7 / RS12

RS726Q-E7 / RS12

*2U Rackmount Server
User Guide*



E7559

Revised Edition V2

September 2012

Copyright © 2012 ASUSTeK COMPUTER INC. All Rights Reserved.

No part of this manual, including the products and software described in it, may be reproduced, transmitted, transcribed, stored in a retrieval system, or translated into any language in any form or by any means, except documentation kept by the purchaser for backup purposes, without the express written permission of ASUSTeK COMPUTER INC. ("ASUS").

ASUS provides this manual "as is" without warranty of any kind, either express or implied, including but not limited to the implied warranties or conditions of merchantability or fitness for a particular purpose. In no event shall ASUS, its directors, officers, employees, or agents be liable for any indirect, special, incidental, or consequential damages (including damages for loss of profits, loss of business, loss of use or data, interruption of business and the like), even if ASUS has been advised of the possibility of such damages arising from any defect or error in this manual or product.

Specifications and information contained in this manual are furnished for informational use only, and are subject to change at any time without notice, and should not be construed as a commitment by ASUS. ASUS assumes no responsibility or liability for any errors or inaccuracies that may appear in this manual, including the products and software described in it.

Product warranty or service will not be extended if: (1) the product is repaired, modified or altered, unless such repair, modification or alteration is authorized in writing by ASUS; or (2) the serial number of the product is defaced or missing.

Products and corporate names appearing in this manual may or may not be registered trademarks or copyrights of their respective companies, and are used only for identification or explanation and to the owners' benefit, without intent to infringe.

Contents

Safety information	vii
About this guide	viii
Chapter 1: Product introduction	
1.1 System package contents	1-2
1.2 Serial number label	1-3
1.3 System specifications	1-4
1.4 Front panel features.....	1-6
1.5 Rear panel features.....	1-6
1.6 Internal features	1-8
1.7 LED information	1-9
1.7.1 Front panel LEDs	1-9
1.7.2 LAN (RJ-45) LEDs	1-10
1.7.3 HDD status LED.....	1-10
Chapter 2: Hardware setup	
2.1 Chassis cover.....	2-2
2.2 Central Processing Unit (CPU)	2-4
2.2.1 Installing the CPU	2-4
2.2.2 Installing the CPU heatsink and airduct.....	2-9
2.3 System memory	2-11
2.3.1 Overview	2-11
2.3.2 Memory Support List.....	2-11
2.3.3 Memory Configurations.....	2-13
2.3.4 Installing a DIMM on a single clip DIMM socket	2-14
2.4 Hard disk drives	2-15
2.5 Expansion slot.....	2-17
2.5.1 Installing an expansion card to the riser card bracket... 2-17	
2.5.2 Configuring an expansion card	2-18
2.6 Cable connections	2-19
2.7 Removable/optional components.....	2-20
2.7.1 System fans	2-20
2.7.2 Power supply module.....	2-21
2.7.3 Installing ASMB6 series management board.....	2-23
2.7.4 Installing ASUS PIKE Riser Card (optional).....	2-24

Contents

Chapter 3: Installation options

3.1	Installing friction rail kit items	3-2
3.1.1	Attaching the fixing latches to the server	3-2
3.1.2	Mounting the server to the rack	3-5

Chapter 4: Motherboard information

4.1	Motherboard layouts.....	4-2
4.2	Jumpers	4-6
4.3	Internal connectors.....	4-10
4.4	Internal LEDs.....	4-19

Chapter 5: BIOS setup

5.1	Managing and updating your BIOS	5-2
5.1.1	ASUS CrashFree BIOS 3 utility	5-2
5.1.2	ASUS EZ Flash 2 Utility	5-3
5.1.3	BUPDATER utility.....	5-4
5.2	BIOS setup program	5-6
5.2.1	BIOS menu screen.....	5-7
5.2.2	Menu bar.....	5-7
5.2.3	Menu items	5-8
5.2.4	Submenu items	5-8
5.2.5	Navigation keys.....	5-8
5.2.6	General help	5-8
5.2.7	Configuration fields	5-8
5.2.8	Pop-up window	5-8
5.2.9	Scroll bar.....	5-8
5.3	Main menu	5-9
5.3.1	System Date	5-9
5.3.2	System Time	5-9
5.4	Advanced menu	5-10
5.4.1	CPU Configuration	5-10
5.4.2	CPU Power Management Configuration.....	5-12
5.4.3	Chipset Configuration	5-14
5.4.4	PCH SATA Configuration	5-19
5.4.5	PCH SCU Configuration	5-21
5.4.6	PCI Subsystem Settings	5-21
5.4.7	Intel TXT(LT-SX) Configuration	5-24

Contents

5.4.8	USB Configuration	5-25
5.4.9	Trusted Computing.....	5-26
5.4.10	ACPI Settings.....	5-27
5.4.11	WHEA Configuration	5-28
5.4.12	APM setting.....	5-28
5.4.13	Onboard LAN Configuration.....	5-29
5.4.14	Serial Port Console Redirection.....	5-30
5.4.15	ME Subsystem	5-33
5.4.16	Legacy Devices Configuration	5-33
5.4.17	Runtime Error Logging.....	5-34
5.5	Server Mgmt menu.....	5-35
5.5.1	System Event Log.....	5-36
5.5.2	BMC network configuration.....	5-37
5.6	Event Logs menu	5-38
5.6.1	Change Smbios Event Log Settings	5-38
5.7	Boot menu	5-40
5.8	Monitor menu	5-42
5.9	Security menu	5-43
5.10	Tool menu	5-44
5.11	Exit menu.....	5-45
 Chapter 6: RAID configuration		
6.1	Setting up RAID.....	6-2
6.1.1	RAID definitions	6-2
6.1.2	Installing hard disk drives.....	6-3
6.1.3	Setting the RAID item in BIOS	6-3
6.1.4	RAID configuration utilities.....	6-3
6.2	LSI Software RAID Configuration Utility	6-4
6.2.1	Creating a RAID set.....	6-5
6.2.2	Adding or viewing a RAID configuration	6-11
6.2.3	Initializing the virtual drives	6-12
6.2.4	Rebuilding failed drives.....	6-16
6.2.5	Checking the drives for data consistency	6-18
6.2.6	Deleting a RAID configuration.....	6-21
6.2.7	Selecting the boot drive from a RAID set.....	6-22
6.2.8	Enabling WriteCache	6-23

Contents

- 6.3 Intel® Rapid Storage Technology enterprise SCU/SATA Option ROM Utility 6-24**
 - 6.3.1 Creating a RAID set 6-26
 - 6.3.2 Creating a Recovery set 6-27
 - 6.3.3 Deleting a RAID set 6-29
 - 6.3.4 Resetting disks to Non-RAID 6-30
 - 6.3.5 Exiting the Intel® Rapid Storage Technology utility..... 6-31
 - 6.3.6 Rebuilding the RAID 6-31
 - 6.3.7 Setting the Boot array in the BIOS Setup Utility..... 6-33
- 6.4 Intel® Rapid Storage Technology enterprise Utility (Windows)6-34**
 - 6.4.1 Creating a RAID set 6-35
 - 6.4.2 Change Volume Type..... 6-37
 - 6.4.3 Delete volume 6-38
 - 6.4.4 Preferences..... 6-39

Chapter 7: Driver installation

- 7.1 RAID driver installation 7-2**
 - 7.1.1 Creating a RAID driver disk 7-2
 - 7.1.2 Installing the RAID controller driver 7-5
- 7.2 Intel® Chipset Device Software installation 7-15**
- 7.3 Intel® Network Connections Software installation..... 7-17**
- 7.4 VGA driver installation..... 7-20**
- 7.5 Intel® C600 Series Chipset SATA RAID Drivers 7-23**
- 7.6 Intel® Rapid Storage Technology enterprise 3.0 installation . 7-24**
- 7.7 Intel® PRO/1000 Gigabit Adapters Driver installation 7-27**
- 7.8 Management applications and utilities installation 7-31**
 - 7.8.1 Running the support DVD 7-31
 - 7.8.2 Drivers menu..... 7-31
 - 7.8.3 Utilities menu 7-32
 - 7.8.4 Make disk menu..... 7-32
 - 7.8.5 Contact information..... 7-32
- 7.9 Mellanox ConnectX-3 Infiniband driver installation 7-33**

Appendix: Reference information

- Notices..... A-2**
- ASUS contact information A-4**

Safety information

Electrical Safety

- Before installing or removing signal cables, ensure that the power cables for the system unit and all attached devices are unplugged.
- To prevent electrical shock hazard, disconnect the power cable from the electrical outlet before relocating the system.
- When adding or removing any additional devices to or from the system, ensure that the power cables for the devices are unplugged before the signal cables are connected. If possible, disconnect all power cables from the existing system before you add a device.
- If the power supply is broken, do not try to fix it by yourself. Contact a qualified service technician or your dealer.

Operation Safety

- Any mechanical operation on this server must be conducted by certified or experienced engineers.
- Before operating the server, carefully read all the manuals included with the server package.
- Before using the server, ensure all cables are correctly connected and the power cables are not damaged. If any damage is detected, contact your dealer as soon as possible.
- To avoid short circuits, keep paper clips, screws, and staples away from connectors, slots, sockets and circuitry.
- Avoid dust, humidity, and temperature extremes. Place the server on a stable surface.
- If you encounter technical problems with the product, contact a qualified service technician or your retailer.



This product is equipped with a three-wire power cable and plug for the user's safety. Use the power cable with a properly grounded electrical outlet to avoid electrical shock.

Lithium-Ion Battery Warning

CAUTION! Danger of explosion if battery is incorrectly replaced. Replace only with the same or equivalent type recommended by the manufacturer. Dispose of used batteries according to the manufacturer's instructions.

CD-ROM Drive Safety Warning

CLASS 1 LASER PRODUCT

Heavy System

CAUTION! This server system is heavy. Ask for assistance when moving or carrying the system.

About this guide

Audience

This user guide is intended for system integrators, and experienced users with at least basic knowledge of configuring a server.

Contents

This guide contains the following parts:

1. **Chapter 1: Product Introduction**

This chapter describes the general features of the server, including sections on front panel and rear panel specifications.

2. **Chapter 2: Hardware setup**

This chapter lists the hardware setup procedures that you have to perform when installing or removing system components.

3. **Chapter 3: Installation options**

This chapter describes how to install optional components into the barebone server.

4. **Chapter 4: Motherboard information**

This chapter gives information about the motherboard that comes with the server. This chapter includes the motherboard layout, jumper settings, and connector locations.

5. **Chapter 5: BIOS setup**

This chapter tells how to change system settings through the BIOS Setup menus and describes the BIOS parameters.

6. **Chapter 6: RAID configuration**

This chapter tells how to change system settings through the BIOS Setup menus. Detailed descriptions of the BIOS parameters are also provided.

7. **Chapter 7: Driver installation**

This chapter provides instructions for installing the necessary drivers for different system components.

Conventions

To ensure that you perform certain tasks properly, take note of the following symbols used throughout this manual.



DANGER/WARNING: Information to prevent injury to yourself when trying to complete a task.



CAUTION: Information to prevent damage to the components when trying to complete a task.



IMPORTANT: Instructions that you **MUST** follow to complete a task.



NOTE: Tips and additional information to help you complete a task.

Typography

Bold text

Indicates a menu or an item to select.

Italics

Used to emphasize a word or a phrase.

<Key>

Keys enclosed in the less-than and greater-than sign means that you must press the enclosed key.

Example: <Enter> means that you must press the Enter or Return key.

<Key1+Key2+Key3>

If you must press two or more keys simultaneously, the key names are linked with a plus sign (+).

Example: <Ctrl+Alt+Del>

Command

Means that you must type the command exactly as shown, then supply the required item or value enclosed in brackets.

Example: At the DOS prompt, type the command line: `format A:/S`

References

Refer to the following sources for additional information, and for product and software updates.

1. **ASUS Server Web-based Management (ASWM) user guide**

This manual tells how to set up and use the proprietary ASUS server management utility.

2. **ASUS websites**

The ASUS websites worldwide provide updated information for all ASUS hardware and software products. Refer to the ASUS contact information.

Chapter 1

This chapter describes the general features of the chassis kit. It includes sections on front panel and rear panel specifications.

Product introduction

1.1 System package contents

Check your system package for the following items.

Model Name	RS720Q-E7/RS12; RS724Q-E7/RS12; RS726Q-E7/RS12
Chassis	ASUS R21A 2U Rackmount Chassis
Motherboard	ASUS Z9PH-D16 Server Board (RS720Q-E7/RS12) ASUS Z9PH-D16/QDR Server Board (RS724Q-E7/RS12) ASUS Z9PH-D16/FDR Server Board (RS726Q-E7/RS12)
Component	2 x 1620W Power Supply 4 x PCIe Riser Card (RE16R-R12B) 2 x Front I/O Board (LED Board, FPB-R21A) 2 x Power Supply Distribution Board (PDB-R21A) 1 x Power Connection Board (PSB-R21A) 4 x Backplane Board (BP3LX-R21A-M) 1 x Backplane Board (BP3LX-R21A-S) 1 x Midplane Board (MP8LX-R21A-M) 4 x Connection Board (CB-R21A) 4 x System Fans (80mm x 38mm) 12 x Hot-swappable 3.5" HDD trays*
Accessories	1 x RS72xQ-E7/RS12 User's Guide 1 x ASWM Enterprise User's Guide 1 x RS72xQ-E7/RS12 Support CD 1 x ASUS Web-based Management (ASWM) Enterprise Supplier CD 1 x ASMB6-iKVM Support DVD 1 x ASMB6-iKVM User Guide 8 x CPU Heatsinks* 1 x Mellanox driver disc (RS726Q-E7/RS12 and RS724Q-E7/RS12 only**) 1 x Bag of Screws 2 x AC Power Cables 1 x Friction Rail Kit
Optional Items	1 x PIKE Riser Card (RE16R-R12B-PIKE) 1 x ASUS PIKE RAID Card

* May vary with different regions or territory.

** The Mellanox driver is included in the motherboard support DVD or in an individual driver disc, depending on the shipping sequence. This is subjected to change without notice.



If any of the above items is damaged or missing, contact your retailer.

1.2 Serial number label

Before requesting support from the ASUS Technical Support team, you must take note of the product's serial number containing 14 characters such as xxS0xxxxxxxxxx. See the figure below.

With the correct serial number of the product, ASUS Technical Support team members can then offer a quicker and satisfying solution to your problems.



1.3 System specifications

The ASUS RS720Q-E7/RS12 is a 2U barebone server system featuring the ASUS Z9PH-D16 server boards; the ASUS RS724Q-E7/RS12 is a 2U barebone server system featuring the ASUS Z9PH-D16/QDR server boards and the ASUS RS726Q-E7/RS12 is a 2U barebone server system featuring the ASUS Z9PH-D16/FDR server boards. The server supports Intel® Socket-R LGA2011 Xeon® series processors with EM64T technology, plus other latest technologies through the chipsets onboard.

Model Name		RS726Q-E7/RS12	RS724Q-E7/RS12	RS720Q-E7/RS12
Processor / System Bus		2 x Socket-R LGA2011 per Node		
		8/6/4 Core Intel® Xeon E5-2600 Series (Up to TDP=115W)		
		QPI 6.4 / 7.2 / 8.0 GT/s		
Core Logic		- Intel® C602-A - Mellanox ConnectX-3 FDR 56Gbps controller	- Intel® C602-A - Mellanox ConnectX-3 QDR 40Gbps controller	- Intel® C602-A
ASUS Features	Smart Fan	√		
	ASWM Enterprise	√		
Memory	Total Slots	16 per Node (4-channel per CPU, 8 DIMMs per CPU)		
	Capacity	Maximum up to 512GB (RDIMM) Maximum up to 128GB (UDIMM) Maximum up to 512GB (LRDIMM)		
	Memory Type	DDR3 800 / 1066 / 1333 / 1600 RDIMM DDR3 1066 / 1333 ECC UDIMM DDR3 1066 / 1333 LR-DIMM		
	Memory Size	2GB, 4GB, 8GB, 16GB and 32GB (RDIMM) 2GB, 4GB and 8GB (UDIMM) 8GB, 16GB, 32GB (LRDIMM)		
Expansion Slots	Total PCI/PCI-X/ PCI-E Slots	1 per Node		
	Slot Type and Additional Slot	1 x PCI-E 3.0 x16 slot (x16 link) (Low profile / HL) per Node or 1 x PIKE Riser Card Slot for Storage Enhancement (Optional)		
Storage	SATA Controller	Intel® C602-A: <AHCI> 2 x SATA 3Gb/s ports, 2 x SATA 6Gb/s ports Intel® RSTe (for Windows only) (Support software RAID 0, 1, 10 & 5) LSI MegaRAID (for Linux / Windows) (Support software RAID 0, 1 & 10) <SCU> 4 x SATA 3Gb/s ports Intel® RSTe (for Windows only) (Supports software RAID 0, 1, 10 & 5 for all SATA ports)		
	SAS Controller	Optional kits(PIKE Riser card is necessary): ASUS PIKE 2008 8-port SAS 6G RAID card ASUS PIKE 2008/IMR 8-port SAS 6G RAID card ASUS PIKE 2108 8-port SAS 6G HW RAID card		

(continued on the next page)

Model Name		RS726Q-E7/RS12	RS724Q-E7/RS12	RS720Q-E7/RS12
HDD Bays	I = internal A or S will be hot- swappable	3 x Hot-swap 3.5" HDD Bays per Node (Total 12 x 3.5" HDD in 2U)		
Networking	LAN	- 2 x Intel® 82574L + 1 x Mgmt LAN per Node - 1 x Single Port Mellanox ConnectX-3 FDR InfiniteBand with QSFP interface per Node	- 2 x Intel® 82574L + 1 x Mgmt LAN per Node - 1 x Single Port Mellanox ConnectX-3 QDR InfiniteBand with QSFP interface per Node	- 2 x Intel® 82574L + 1 x Mgmt LAN per Node
Graphic	VGA	Aspeed AST2300 + 16MB VRAM		
Onboard I/O		Per Node: - 1 x External Serial Port - 3 x RJ-45 ports (1 for ASMB6-iKVM) - 2 x USB 2.0 ports - 1 x VGA port - 1 x Internal A Type USB Port - 1 x QSFP Port for Infiniband FDR	Per Node: - 1 x External Serial Port - 3 x RJ-45 ports (1 for ASMB6-iKVM) - 2 x USB 2.0 ports - 1 x VGA port - 1 x Internal A Type USB Port - 1 x QSFP Port for Infiniband QDR	Per Node: - 1 x External Serial Port - 3 x RJ-45 ports (1 for ASMB6-iKVM) - 2 x USB 2.0 ports - 1 x VGA port - 1 x Internal A Type USB Port
OS Support		Windows® Server 2008 Enterprise 32 / 64-bit Windows® Server 2003 R2 Enterprise 32 / 64-bit RedHat® Enterprise Linux AS5.0 32 / 64-bit SuSE® Linux Enterprise Server 10 32 / 64-bit (Subject to change without any notice)		
Management Solution	Out of Band Remote Hardware	Default ASMB6-iKVM for KVM-over-IP support Intel Node Management		
	Software	ASUS ASWM Enterprise		
Dimension (HH x WW x DD)		756mm x 444mm x 88mm (2U)		
Net Weight Kg (CPU, DRAM & HDD not inclu ded)		25 Kg		
Power Supply		2 fixed power for 100-140Vac, 50-60Hz, 12-9.5A 1+1 Redundant 1620W power for 180-240Vac, 50-60Hz, 9.6-7A		
Power Rating		Input: 1000W: 100–120Vac, 12–10A, 50–60Hz, Class I 1200W: 120–140Vac, 12–10A, 50–60Hz, Class I 1620W: 180–240Vac, 10.5–8A, 50–60Hz, Class I		
Environment		Operation temperature: 10°C–35°C Non operation temperature: -40°C–70°C Non operation humidity: 20%–90% (Non-condensing)		

*Specifications are subject to change without notice.

1.4 Front panel features

The barebone server displays a simple yet stylish front panel with easily accessible features. The power and reset buttons, LED indicators, optical drive, and two USB ports are located on the front panel.

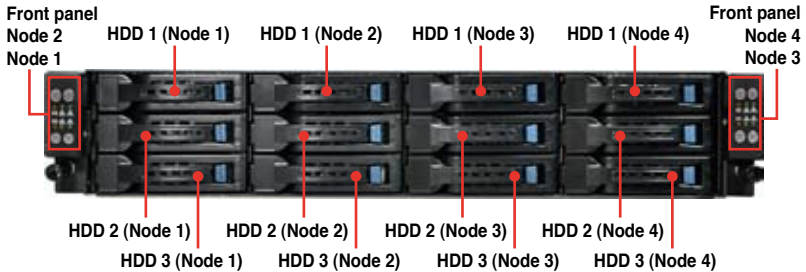

Refer to section 1.7.1 **Front panel LEDs** for the LED descriptions.

1.5 Rear panel features

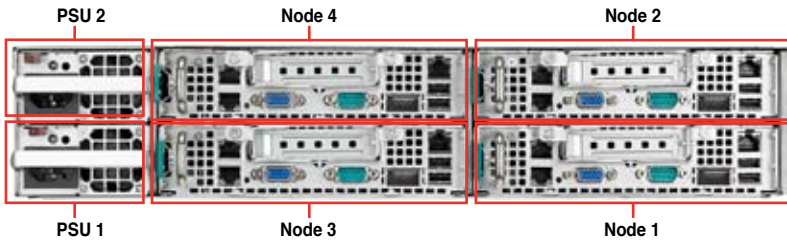

When installing only two nodes, install the nodes to node slot number 1 and 3 or number 2 and 4.

RS720Q-E7/RS12

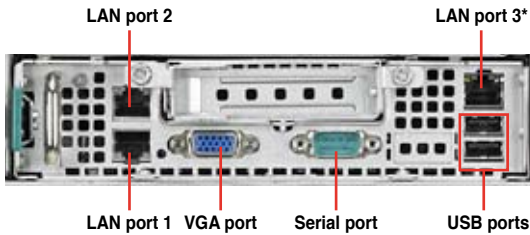

* This port is for ASUS ASMB6-iKVM controller card only.

RS726Q-E7/RS12; RS724Q-E7/RS12

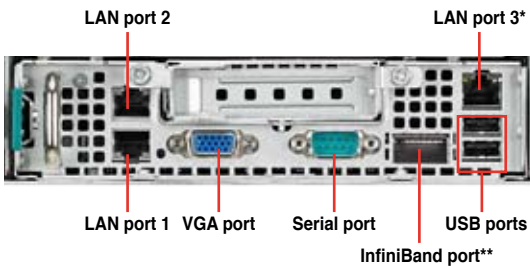

* This port is for ASUS ASMB6-iKVM controller card only.

** This port allows connection with a QSFP cable to an InfiniBand switch.

Infiniband (MQSFP1) indications

Activity LED	Link LED	Description
Off	Off	No device
Orange	Green	Device plugged in; Ready
Orange Blinking	Green	Device plugged in; Data transmitting

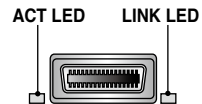

1.6 Internal features

The barebone server includes the basic components as shown.

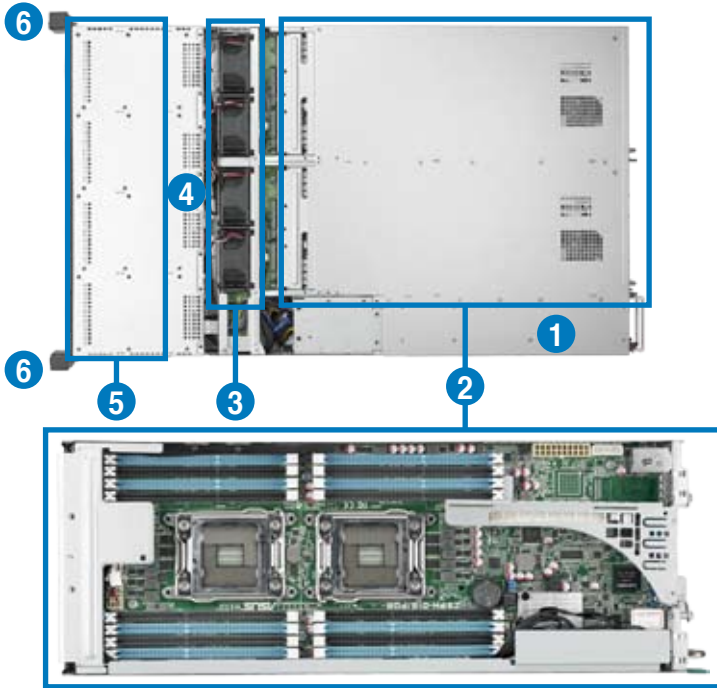

1. Power supply and power fan
2. ASUS Z9PH-D16/FDR (for RS726Q-E7/RS12 use); ASUS Z9PH-D16/QDR (for RS724Q-E7/RS12 use); Z9PH-D16 (for RS720Q-E7/RS12 use) Server Boards
3. System fans
4. SATA/SAS backplane (hidden)
5. Hot-swap HDD trays (SAS and SATA)
6. Front LED Boards



Turn off the system power and detach the power supply before removing or replacing any system component.



The barebone server does not include a floppy disk drive. Connect a USB floppy disk drive to any of the USB ports on the front or rear panel if you need to use a floppy disk.

***WARNING**
HAZARDOUS MOVING PARTS
KEEP FINGERS AND OTHER BODY PARTS AWAY

1.7 LED information

1.7.1 Front panel LEDs

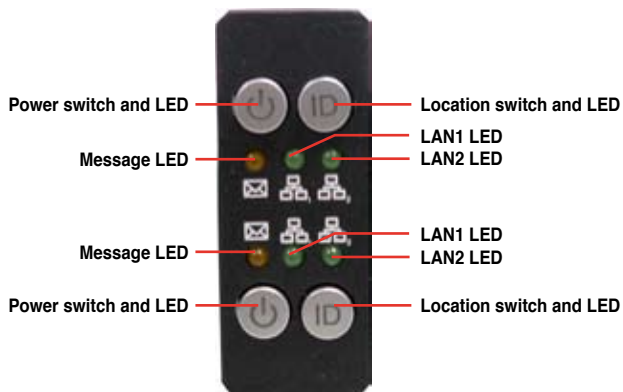

LED	Icon	Display status	Description
Power LED		ON	System power ON
Message LED		OFF	System is normal; no incoming event
		ON	1. Without ASMB6-iKVM installed: CPU over-heated 2. With ASMB6-iKVM installed: a hardware monitor event is indicated
Location LED	ID	OFF	Normal status
		ON	Location switch is pressed (Press the location switch again to turn off)
LAN LEDs	 	OFF	No LAN connection
		Blinking	LAN is transmitting or receiving data
		ON	LAN connection is present

1.7.2 LAN (RJ-45) LEDs

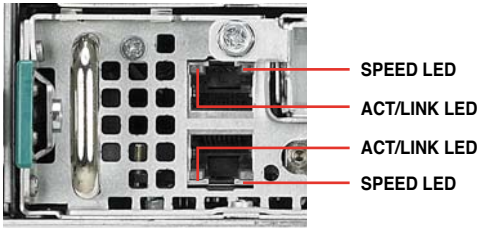

ACT/LINK LED		SPEED LED	
Status	Description	Status	Description
OFF	No link	OFF	10 Mbps connection
GREEN	Linked	ORANGE	100 Mbps connection
BLINKING	Data activity	GREEN	1 Gbps connection

1.7.3 HDD status LED



SATAII/SAS HDD LED Description		
HDD Activity LED (Green)	OFF	HDD not present
	ON	HDD present, no activity
	Blinking	1. Read/write data from/into the SATAII/SAS HDD 2. Locating (blinking with the HDD status LED)
HDD Status LED (Red)	OFF	HDD not present
	ON	HDD has failed and should be swapped immediately
	Blinking	1. RAID rebuilding 2. Locating (blinking with the HDD activity LED)

Chapter 2

This chapter lists the hardware setup procedures that you have to perform when installing or removing system components.

Hardware setup

2.1 Chassis cover

Removing the top cover

1. Loosen the six screws on the top and the two sides of the top cover, as shown in the following figures.

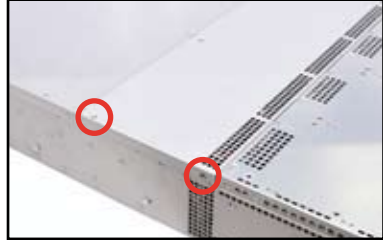
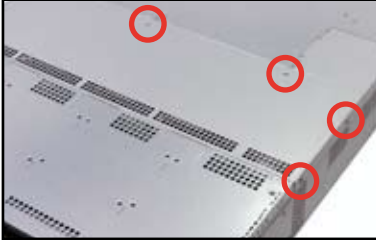

2. Lift the rear end of the top cover, and follow the direction of the arrow in the right figure to slide the cover toward the rear panel until it is disengaged from the chassis.

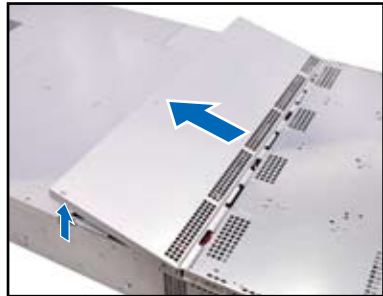

Removing the server node

1. Remove the screw located on the node latch.



2. Hold the server node lever and press the node latch.



3. Firmly pull the server node out of the server chassis.



When installing only two nodes, install the nodes to node slot number 1 and 3 or number 2 and 4. Refer to section **1.5 Rear panel features** for details.

2.2 Central Processing Unit (CPU)

The motherboard comes with a surface mount LGA2011 socket designed for the Intel® Xeon E5-2600 family processor.



- Upon purchase of the motherboard, ensure that the PnP cap is on the socket and the socket contacts are not bent. Contact your retailer immediately if the PnP cap is missing, or if you see any damage to the PnP cap/socket contacts/motherboard components. ASUS will shoulder the cost of repair only if the damage is shipment/transit-related.
- Keep the cap after installing the motherboard. ASUS will process Return Merchandise Authorization (RMA) requests only if the motherboard comes with the cap on the LGA2011 socket.
- The product warranty does not cover damage to the socket contacts resulting from incorrect CPU installation/removal, or misplacement/loss/incorrect removal of the PnP cap.

2.2.1 Installing the CPU

To install a CPU:

1. Locate the CPU socket on the motherboard.

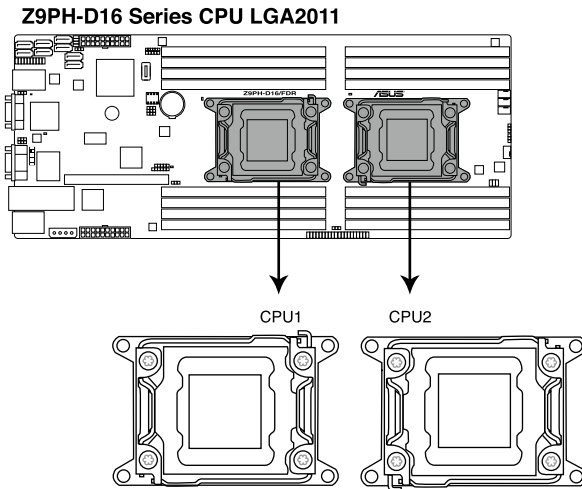

Before installing the CPU, ensure that the socket box is facing toward you and the load lever is on your left.

2. Press the left load lever with your thumb (A), then move it to the left (B) until it is released from the retention tab.



To prevent damage to the socket pins, do not remove the PnP cap unless you are installing a CPU.

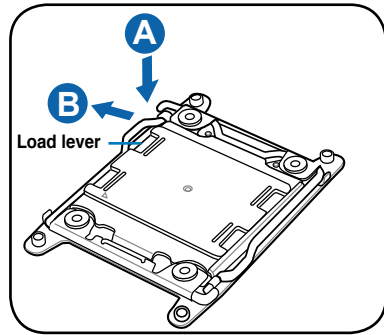

3. Slightly lift the load lever in the direction of the arrow.

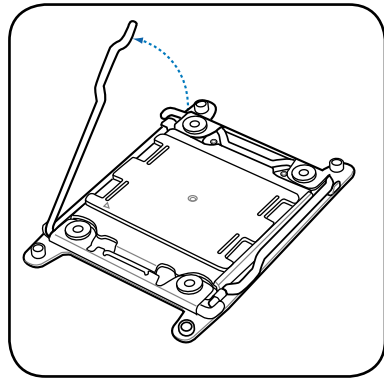

4. Press the right load lever with your thumb (C), then move it to the right (D) until it is released from the retention tab. Lift the load lever in the direction of the arrow (E).

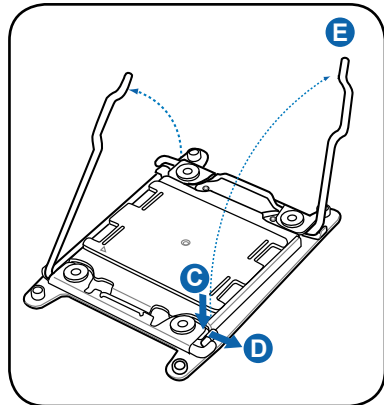

5. Push the left load lever (F) to lift the load plate (G).

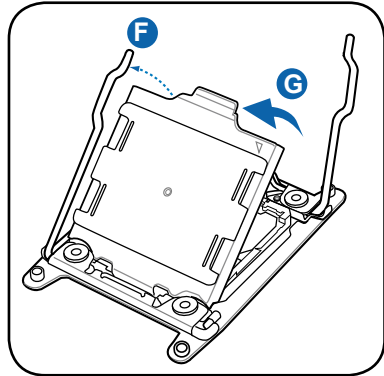

6. Position the CPU over the socket, ensuring that the triangle mark is on the top-right corner of the socket.

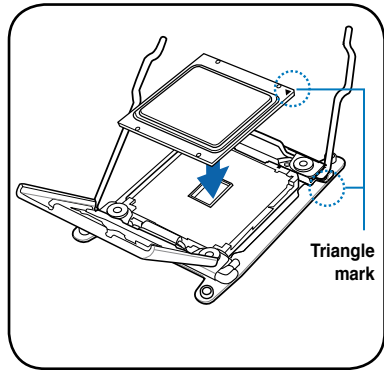

The CPU fits in only one correct orientation. **DO NOT** force the CPU into the socket to prevent bending the connectors on the socket and damaging the CPU!

7. Remove the PnP cap (H) from the CPU socket and close the load plate (I).

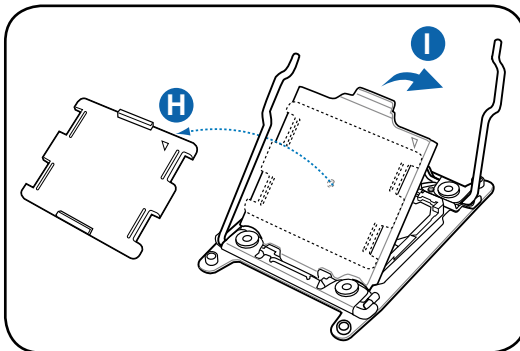

8. Push down the right load lever (J), ensuring that the edge of the load plate is fixed by the lever (K).

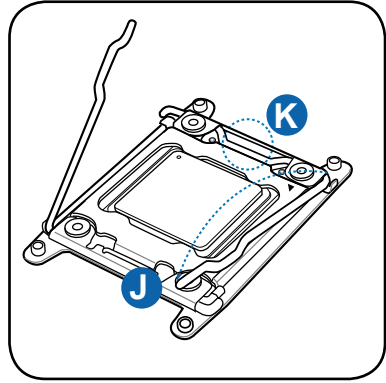

9. Insert the right load lever under the retention tab.

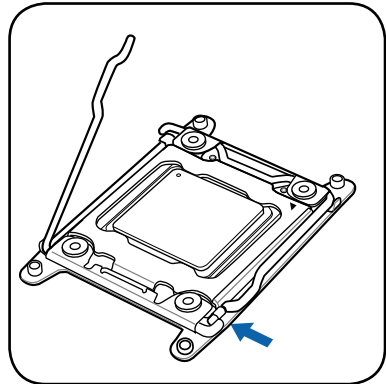

10. Push down the left load lever (L), and then insert the lever under the retention tab (M).

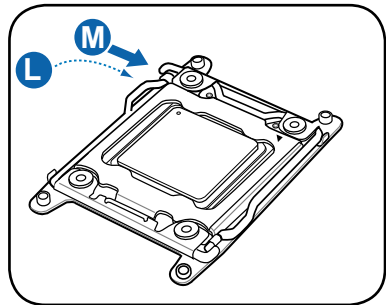

11. Apply some Thermal Interface Material to the exposed area of the CPU that the heatsink will be in contact with, ensuring that it is spread in an even thin layer.



Some heatsinks come with pre-applied thermal paste. If so, skip this step.

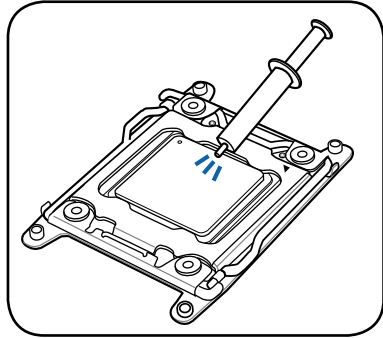

The Thermal Interface Material is toxic and inedible. DO NOT eat it. If it gets into your eyes or touches your skin, wash it off immediately, and seek professional medical help.

2.2.2 Installing the CPU heatsink and airduct

To install the CPU heatsink:

1. Place the heatsink on top of the installed CPU, ensuring that the four fasteners match the holes on the motherboard.

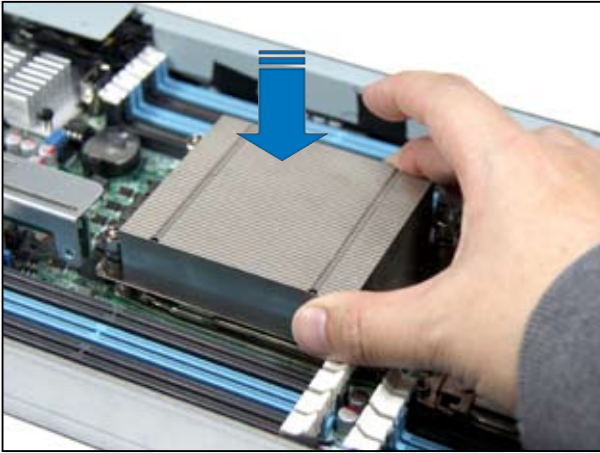

2. Twist each of the four screws with a Philips (cross) screwdriver just enough to attach the heatsink to the motherboard. When the four screws are attached, tighten them one by one to completely secure the heatsink.

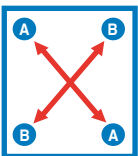
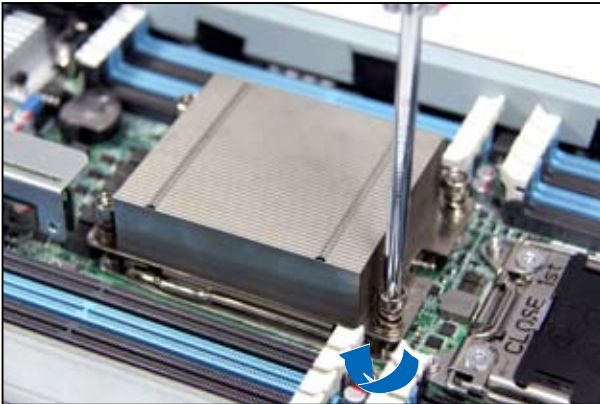

Tighten the four heatsink screws in a diagonal sequence.

To install the airduct:

1. Position the airduct on top of the heatsink.

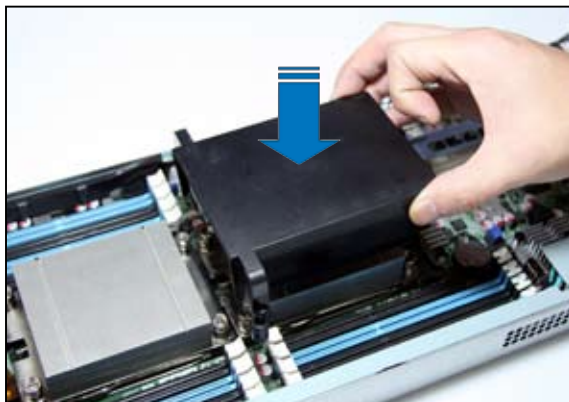

2. Twist each of the two screws with a slotted screwdriver just enough to attach the airduct to the motherboard.

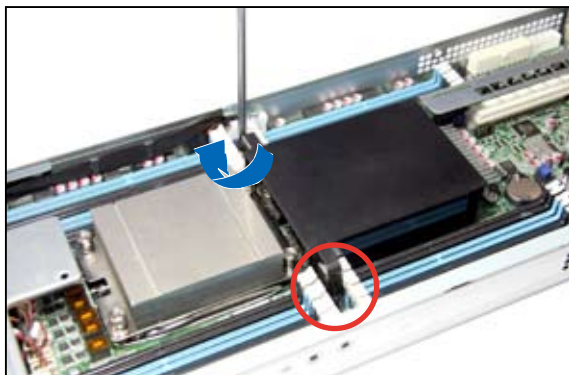

2.3 System memory

2.3.1 Overview

The motherboard comes with sixteen (16) Double Data Rate 3 (DDR3) Dual Inline Memory Modules (DIMM) sockets.

The figure illustrates the location of the DDR3 DIMM sockets:

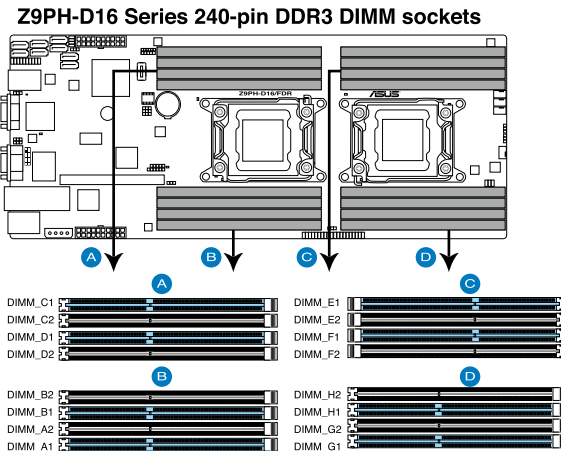

2.3.2 Memory Support List

Intel Xeon E5-2600 Series Processor UDIMM Memory Support List

Ranks Per DIMM and Data Width	Memory Capacity Per DIMM			Speed (MT/s) and Voltage Validated by Slot Per Channel (SPC) and DIMM Per Channel (DPC)			
				2 Slots Per Channel			
				1DPC		2DPC	
				1.35V	1.5V	1.35V	1.5V
SRx8 Non-ECC	1GB	2GB	4GB	N/A	1066, 1333,	N/A	1066, 1333,
DRx8 Non-ECC	2GB	4GB	8GB	N/A	1066, 1333,	N/A	1066, 1333,
SRx16 Non-ECC	512MB	1GB	2GB	N/A	1066, 1333,	N/A	1066, 1333,
SRx8 ECC	1GB	2GB	4GB	1066, 1333,	1066, 1333,	1066	1066, 1333,
DRx8 ECC	2GB	4GB	8GB	1066, 1333,	1066, 1333,	1066	1066, 1333,

Intel Xeon E5-2600 Series Processor RDIMM Memory Support List

Ranks Per DIMM and Data Width	Memory Capacity Per DIMM			Speed (MT/s) and Voltage Validated by Slot Per Channel (SPC) and DIMM Per Channel (DPC)			
				2 Slots Per Channel			
				1DPC		2DPC	
				1.35V	1.5V	1.35V	1.5V
SRx8	1GB	2GB	4GB	1066, 1333	1066, 1333, 1600	1066, 1333	1066, 1333, 1600
DRx8	2GB	4GB	8GB	1066, 1333	1066, 1333, 1600	1066, 1333	1066, 1333, 1600
SRx4	2GB	4GB	8GB	1066, 1333	1066, 1333, 1600	1066, 1333	1066, 1333, 1600
DRx4	4GB	8GB	16GB	1066, 1333	1066, 1333, 1600	1066, 1333	1066, 1333, 1600
QRx4	8GB	16GB	32GB	800	1066	800	800
QRx8	4GB	8GB	16GB	800	1066	800	800

Intel Xeon E5-2600 Series Processor LRDIMM Memory Support List

Ranks Per DIMM and Data Width	Memory Capacity Per DIMM		Speed (MT/s) and Voltage Validated by Slot Per Channel (SPC) and DIMM Per Channel (DPC)	
			2 Slots Per Channel	
			1DPC and 2DPC	
			1.35V	1.5V
QRx4 (DDP)*	16GB	32GB	1066	1066, 1333
QRx8 (P)**	8GB	16GB	1066	1066, 1333

* DDP-Dual Die Package DRAM stacking.

** P-Planer monolithic DRAM die.

2.3.3 Memory Configurations

You may install 2GB, 4GB, 8GB, 16GB and 32GB* RDIMMs or 2GB, 4GB and 8GB* with ECC/Non-ECC UDIMMs or 8GB, 16GB and 32GB* LR-DIMMs into the DIMM sockets using the memory configurations in this section.

1 CPU Configuration (must on CPU1)								
	DIMM_A2	DIMM_A1	DIMM_B2	DIMM_B1	DIMM_C2	DIMM_C1	DIMM_D2	DIMM_D1
1 DIMMs		X						
2 DIMMs		X		X				
4 DIMMs		X		X		X		X
8 DIMMs	X	X	X	X	X	X	X	X



- *Refer to ASUS Server AVL for latest update.
- Start installing the DIMMs from slot A1 and B1 (light blue).
- Always install DIMMs with the same CAS latency. For optimum compatibility, it is recommended that you obtain memory modules from the same vendor.

2 CPU Configuration								
	DIMM_A2	DIMM_A1	DIMM_B2	DIMM_B1	DIMM_C2	DIMM_C1	DIMM_D2	DIMM_D1
1 DIMMs		X						
2 DIMMs		X						
4 DIMMs		X		X				
8 DIMMs		X		X		X		X
12 DIMMs	X	X	X	X		X		X
16 DIMMs	X	X	X	X	X	X	X	X

2 CPU Configuration								
	DIMM_E2	DIMM_E1	DIMM_F2	DIMM_F1	DIMM_G2	DIMM_G1	DIMM_H2	DIMM_H1
1 DIMMs								
2 DIMMs		X						
4 DIMMs		X		X				
8 DIMMs		X		X		X		X
12 DIMMs	X	X	X	X		X		X
16 DIMMs	X	X	X	X	X	X	X	X

2.3.4 Installing a DIMM on a single clip DIMM socket

1. Unlock a DIMM socket by pressing the retaining clip outward.
2. Align a DIMM on the socket such that the notch on the DIMM matches the DIMM slot key on the socket.

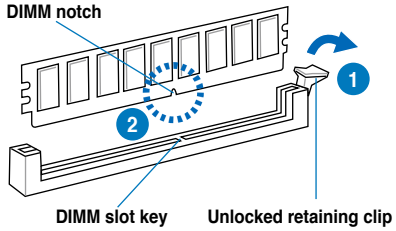

A DIMM is keyed with a notch so that it fits in only one direction. DO NOT force a DIMM into a socket in the wrong direction to avoid damaging the DIMM.

3. Hold the DIMM by both of its ends, then insert the DIMM vertically into the socket. Apply force to both ends of the DIMM simultaneously until the retaining clip snaps back into place, and the DIMM cannot be pushed in any further to ensure proper sitting of the DIMM.

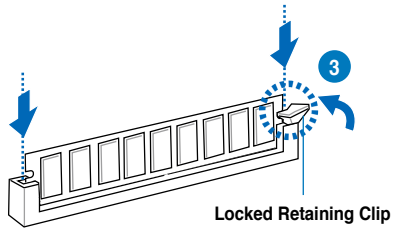

Always insert the DIMM into the socket VERTICALLY to prevent DIMM notch damage.



- To install two or more DIMMs, refer to the user guide bundled in the motherboard package.
- Refer to the user guide for qualified vendor lists of the memory modules.

Removing a DIMM from a single clip DIMM socket

1. Press the retaining clip outward to unlock the DIMM.
2. Remove the DIMM from the socket.

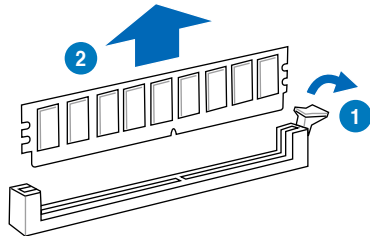

Support the DIMM lightly with your fingers when pressing the retaining clips. The DIMM might get damaged when it flips out with extra force.

2.4 Hard disk drives

The system supports three hot-swap SATAII/SAS hard disk drives per node (available only when an optional ASUS PIKE SAS RAID card is installed) or three hot-swap SATAII hard disk drives per node. The hard disk drive installed on the drive tray connects to the motherboard SATAII/SAS ports via the SATAII/SAS backplane.

To install a hot-swap SATAII/SAS HDD

1. Release a drive tray by pushing the spring lock to the right, then pulling the tray lever outward. The drive tray ejects slightly after you pull out the lever.

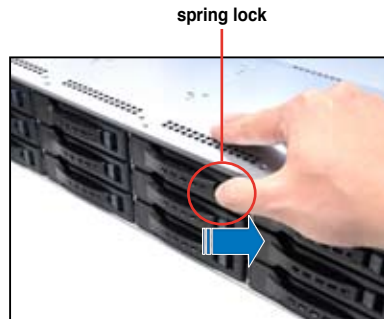

2. Firmly hold the tray lever and pull the drive tray out of the bay.



3. Take note of the drive tray holes. Each side has three holes to fit different types of hard disk drives. Use two screws on each side to secure the hard disk drive.



4. Place a SATAII/SAS hard disk drive on the tray, then secure it with four screws.



- Carefully insert the drive tray and push it all the way to the depth of the bay until just a small fraction of the tray edge protrudes.



When installed, the SATAII/SAS connector on the drive connects to the SATAII/SAS interface on the backplane.

- Push the tray lever until it clicks, and secures the drive tray in place. The drive tray is correctly placed when its front edge aligns with the bay edge.
- Repeat steps 1 to 6 if you wish to install other SATAII/SAS drive(s).



2.5 Expansion slot

2.5.1 Installing an expansion card to the riser card bracket

The barebone server comes with a riser card bracket. You need to remove the bracket if you want to install PCI Express x16 expansion cards.

To install a PCI Express x16 card

1. Remove the three screws on the riser card bracket, as shown in the right figure.



2. Firmly hold the riser card bracket, and then pull it up to detach it from the PCI Express x16 slot on the motherboard.

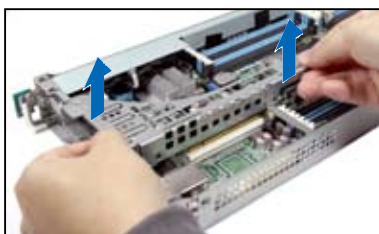

3. Place the riser card bracket on a flat and stable surface, and then remove the screw from the slot bay.

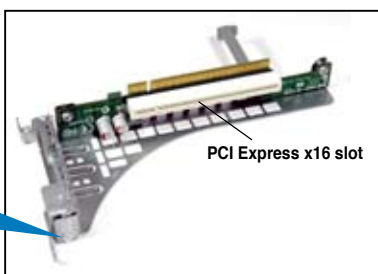

4. Install a PCI Express x16 card to the bracket as shown, and then secure the card with a screw.

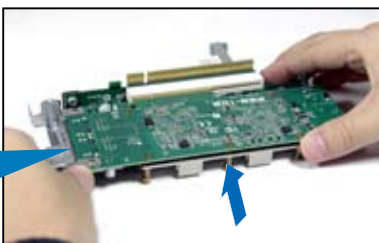

5. Press the riser card bracket until the golden connectors completely fit the slot and the bracket aligns with the rear panel.
6. Connect the cable(s) to the card, if applicable.

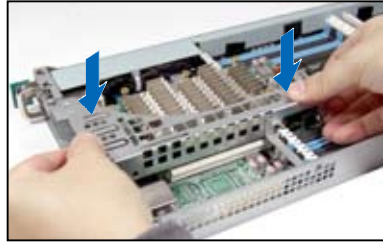

2.5.2 Configuring an expansion card

After installing the expansion card, configure it by adjusting the software settings.

1. Turn on the system and change the necessary BIOS settings, if any. See Chapter 5 for information on BIOS setup.
2. Assign an IRQ to the card. Refer to the following tables.
3. Install the software drivers for the expansion card.

Standard Interrupt assignments

IRQ	Priority	Standard function
0	1	System Timer
1	2	Keyboard Controller
2	-	Programmable Interrupt
4*	12	Communications Port (COM1)
5*	13	--
6	14	Floppy Disk Controller
7*	15	--
8	3	System CMOS/Real Time Clock
9*	4	ACPI Mode when used
10*	5	IRQ Holder for PCI Steering
11*	6	IRQ Holder for PCI Steering
12*	7	PS/2 Compatible Mouse Port
13	8	Numeric Data Processor
14*	9	Primary IDE Channel
15*	10	Secondary IDE Channel

* These IRQs are usually available for ISA or PCI devices.

2.6 Cable connections



- The bundled system cables are pre-connected before shipment. You do not need to disconnect these cables unless you will remove pre-installed components to install additional devices.
- Refer to Chapter 4 for detailed information on the connectors.

RS720Q-E7/RS12 (Z9PH-D16)

RS726Q-E7/RS12 (Z9PH-D16/FDR) RS724Q-E7/RS12 (Z9PH-D16/QDR)

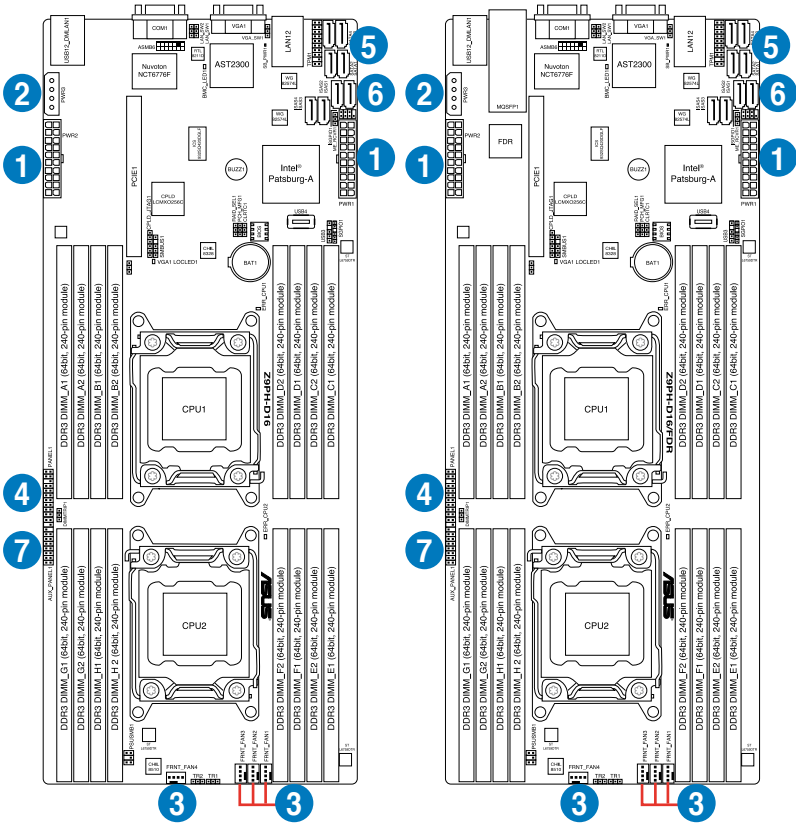

Pre-connected system cables

- 20-pin proprietary power connector (from connection board to motherboard)
- 4-pin proprietary power connector (from connection board to motherboard)
- System fan connectors (FRNT_FAN1, FRNT_FAN2, and FRNT_FAN3)
- Panel connector (from motherboard to connection board)
- SATA connectors (from motherboard to SATAII/SAS connection board)
- ISAS connectors (from motherboard to SATAII/SAS connection board)
- Auxiliary panel connector (from motherboard to connection board)

2.7 Removable/optional components

You may need to remove previously installed system components when installing or removing system devices. Or you may need to install the optional components into the system. This section tells how to remove/install the following components:



1. System fans
2. Power supply module
3. ASUS PIKE RAID card (optional)
4. ASUS ASMB6-iKVM



Ensure that the system is turned off before removing any components.

2.7.1 System fans

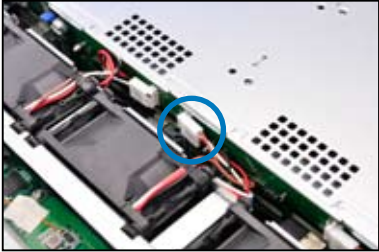
To uninstall the system fans

1. Disconnect the system fan cable from the fan connector on the HDD backplane.

2. Lift the fan, and then set aside.
3. Repeat step 1 to 2 to uninstall the other system fans.

2.7.2 Power supply module

To install a second power supply module

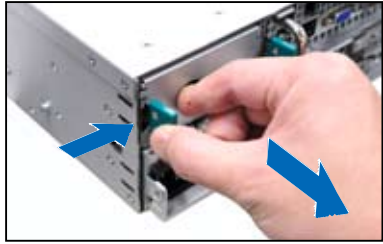
1. Press and hold the latch on the dummy cover and pull out the cover from the server chassis.



2. Take out the second power supply module from its package. Firmly push the power supply module into the chassis until the latch locks to the server chassis.



To replace a failed power supply module

1. Lift up the power supply module lever.



2. Hold the power supply module lever and press the PSU latch.



3. Firmly pull the power supply module out of the system chassis.



4. Firmly push the new power supply module into the chassis until the latch locks to the server chassis.



- If you install two or more nodes, please install both the power supply modules.
- The system automatically combines the two power supply modules as a single one. The combined output power varies with input voltages. Refer to the table below for details.

Input Voltage	Max. Output Power (Watt) per PSU
100–120Vac, 12–10A, 50–60Hz	1000W
120–140Vac, 12–10A, 50–60Hz	1200W
180–240Vac, 10.5–8A, 50–60Hz	1620W

- To enable the hot-swap feature (redundant mode), keep the total power consumption of the installed nodes under the maximum output power of an individual power supply module.
- For steady power input, use only the power cables that come with the server system package.

2.7.3 Installing ASMB6 series management board

Follow the steps below to install an optional ASMB6 series management board on your motherboard.

1. Locate the ASMB6 header on the motherboard.

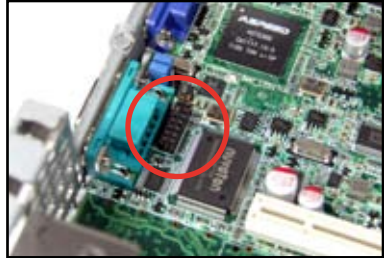

2. Orient and press the ASMB6 management card in place.



3. Insert the LAN cable plug to the LAN3 port for server management.



2.7.4 Installing ASUS PIKE Riser Card (optional)

Follow the steps below to install the optional ASUS PIKE SAS RAID card to the ASUS PIKE riser card.

1. Remove the three screws on the riser card bracket, as shown in the right figure.



2. Firmly hold the riser card bracket, and then pull it up to detach it from the PCI Express x16 slot on the motherboard.

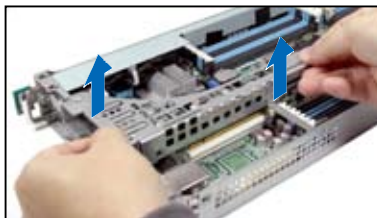

3. Locate the two screws on the riser card bracket, then remove the screws from the bracket.

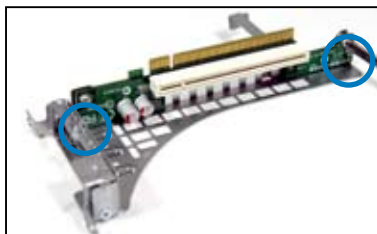

4. Locate the two screw holes on the PIKE riser card.



5. Secure the PIKE riser card to the riser card bracket with two screws.

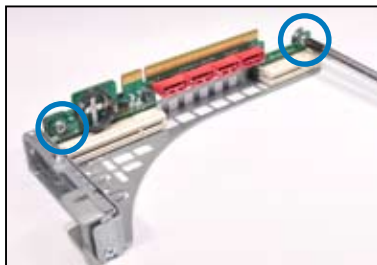

6. Align and insert the golden fingers of the PIKE SAS RAID card into the card slot on the PIKE riser card. Ensure the card is completely seated on the slot.

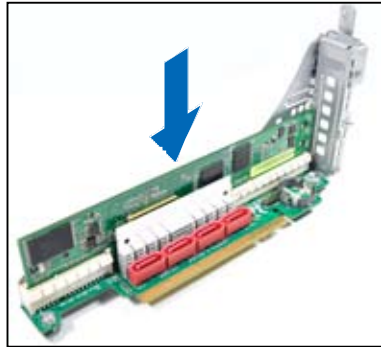

7. Locate the SGPIO connector on the side of the server chassis.



8. Connect the SGPIO cable to the SGPIO connector on the PIKE Riser card.

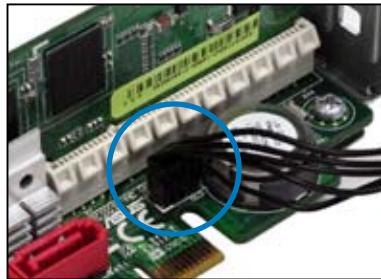

9. Remove the two (2) screws that secures the metal plate covering the SATA and ISAS connectors.

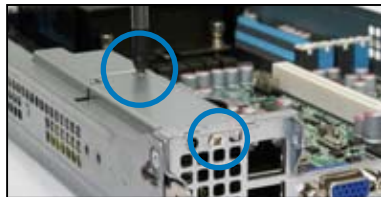

10. Remove the SATA/SAS cables from the onboard SATA1–3 connectors.

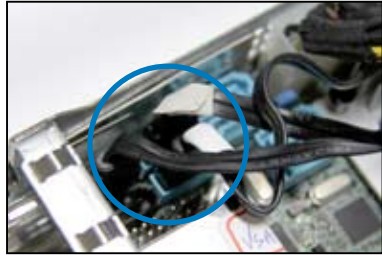

11. Connect the SATA/SAS cables to the SAS1–3 connectors on the PIKE riser card.

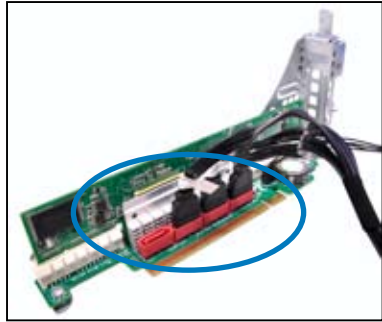

12. Align the riser card bracket to the PCI Express x16 slot on the motherboard.
13. Press the riser card bracket until the golden fingers completely fit the slot and the bracket aligns with the rear panel.

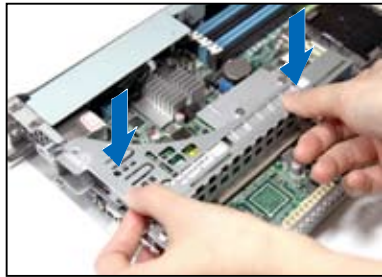

14. Move the **SGPIO_SEL** jumper in front of the server node from pin 1–2 to pin 2–3.

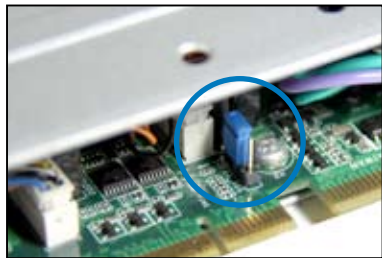

Chapter 3

This chapter describes how to install the optional components and devices into the barebone server.

Installation options

3.1 Installing friction rail kit items

Your friction rail kit package contains:

- One pair of rack rails
- One pair of fixing latches
- 4 latch screws, 4 rail screws and 4 rail washers

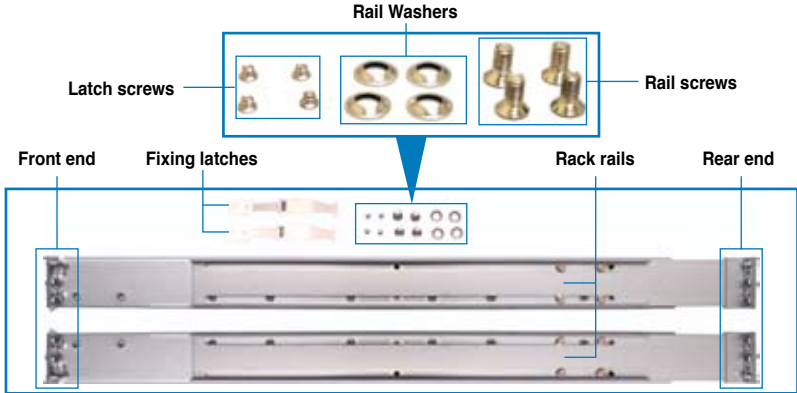

3.1.1 Attaching the fixing latches to the server

Refer to the figures below for the locations to attach the two fixing latches to the two sides of the server with four screws.

1. Remove the two screws on the side of the server chassis.
2. Secure the fixing latch with the two screws you removed in step 1.
3. Repeat step 1 to 2 to secure another fixing latch to the other side of the server.

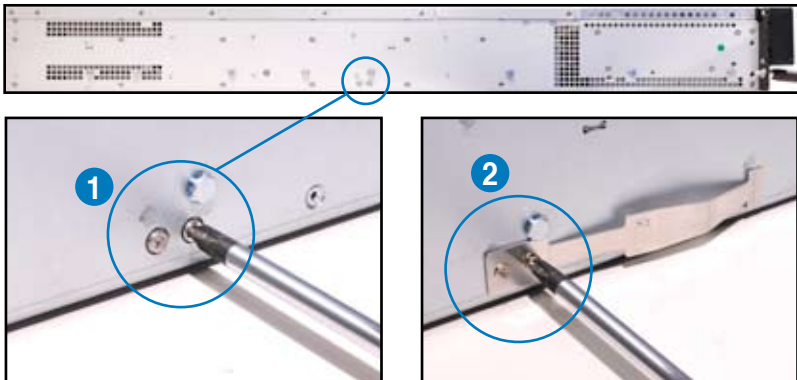

4. Select a 1U space on the rack where you want to install the rack rail. A 1U space consists of three square mounting holes with two thin lips on the top and the bottom, as shown in the right figure.
5. Adjust the rack rail to fit the depth of the rack.

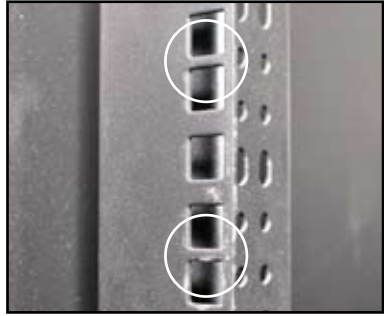

6. From inside the rack, place the rear rail hook on the bottom thin lip of the rear mounting hole, and then place the front rail hook on the bottom thin lip of the front mounting hole, as shown in the right figure.



7. Secure the front and rear ends of the rail with two rack screws and washers.
8. Repeat step 4 to 7 to attach the rack rail on the other side of the rack.



9. When mounting the server to the rack, ensure to include the side knots on the two sides of the server in the rack rail holders, as shown in the right figure.

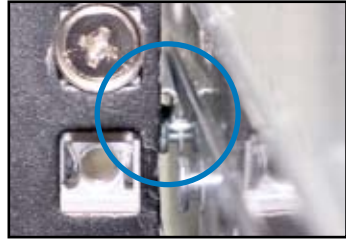

Do not install the rail kit in the following situation:

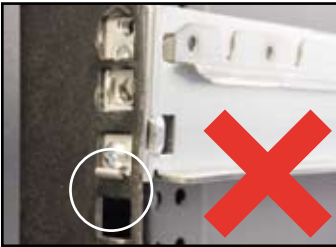

DO NOT place the rail hook on a thick lip of the mounting hole.



DO NOT install the rail to the outer side of the server rack.

3.1.2 Mounting the server to the rack

To mount the server to the rack

1. Place the server on the rack rails, and then push the server all the way to the depth of the rack.



2. Tighten the two rack screws to secure the server in place.



To uninstall the server from the rack

1. Loosen the rack screws that secured the server to the rack.
2. Pull the server from the rack.



Remember to press the latches on both sides to release the server from the rack.

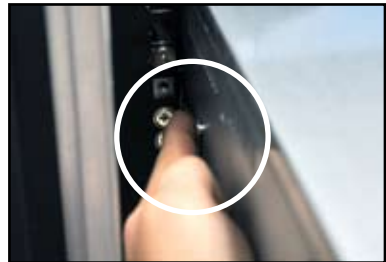

Chapter 4

This chapter includes the motherboard layout, and brief descriptions of the jumpers and internal connectors.

Motherboard info

4.1 Motherboard layouts

Z9PH-D16 (For RS720Q-E7/RS12)

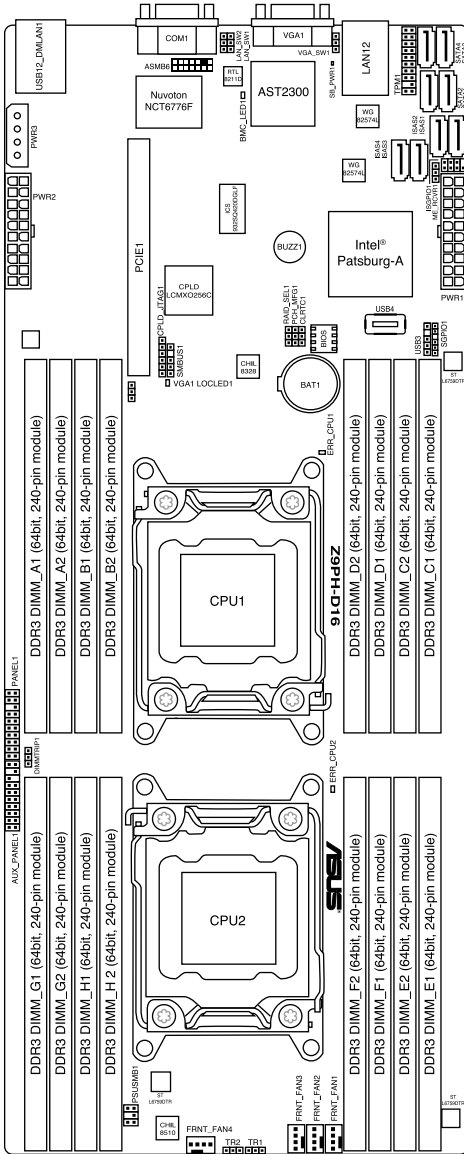

Z9PH-D16/QDR (For RS724Q-E7/RS12)

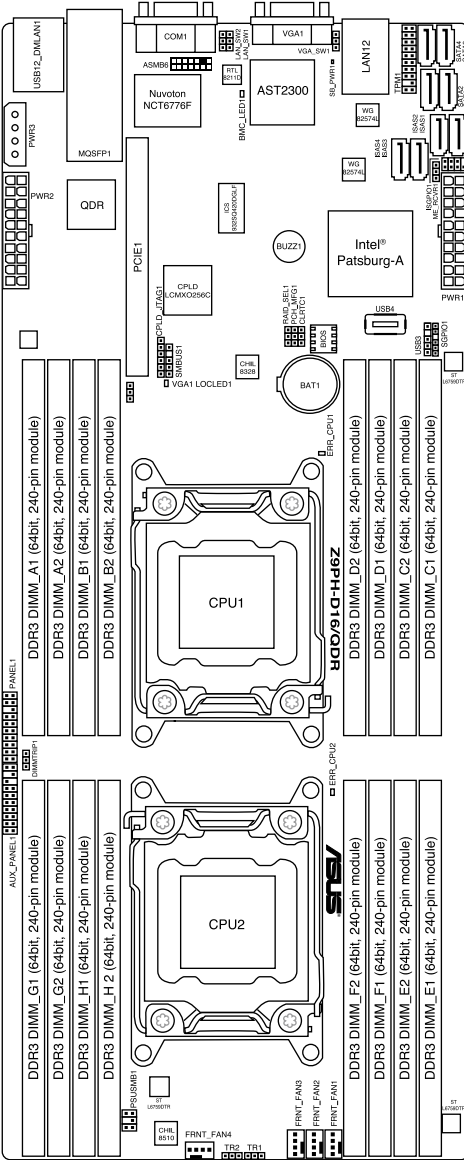

Z9PH-D16/FDR (For RS726Q-E7/RS12)

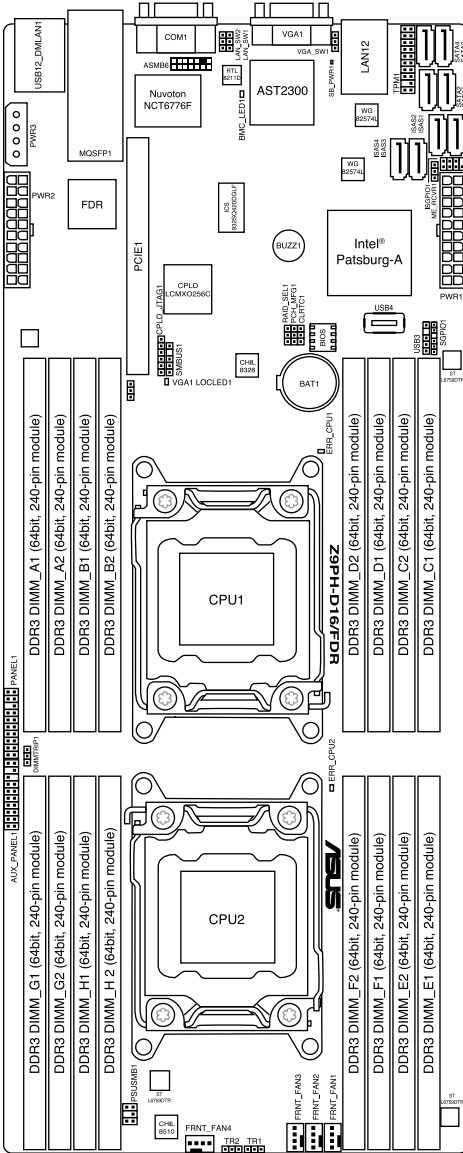

Layout contents

Jumpers		Page
1.	Clear RTC RAM (CLRTC1)	4-6
2.	VGA controller setting (3-pin VGA_SW1)	4-7
3.	LAN controller setting (3-pin LAN_SW1, LAN_SW2)	4-7
4.	LSI MegaRAID or Intel RSTe selection jumper (3-pin RAID_SEL1)	4-8
5.	ME firmware force recovery setting (3-pin ME_RCVR1)	4-8
6.	DIMM thermal event Setting (3-pin DIMMTRIP1)	4-9

Internal connectors		Page
1.	Serial ATA connectors (7-pin SATA1-2 [Lght blue], SATA3-4 [Black])	4-10
2.	ISAS connectors (7-pin ISAS1-4 [Light Blue])	4-11
3.	USB connector (5-1 pin USB3; A-Type USB4)	4-11
4.	Front fan connectors (4-pin FRNT_FAN1, FRNT_FAN2, FRNT_FAN3, FRNT_FAN4)	4-12
5.	Serial General Purpose Input/Output connector (6-1 pin SGPIO1)	4-13
6.	Serial General Purpose Input/Output connector (8-1 pin ISGPIO1)	4-13
7.	ASMB6 header (ASMB6)	4-14
8.	Thermal sensor cable connectors (3-pin TR1, TR2)	4-14
9.	TPM connector (20-1 pin TPM)	4-15
10.	Power Supply SMBus connector (6-1 pin PSUSMB1)	4-15
11.	Proprietary power connectors (20-pin PWR1, 20-pin PWR2, 4-pin PWR3)	4-16
12.	System panel connector (20-pin PANEL1 [White])	4-17
13.	Auxiliary panel connector (20-pin AUX_PANEL1 [Black])	4-18

Internal LEDs		Page
1.	CPU warning LED (ERR_CPU1, ERR_CPU2)	4-19
2.	BMC LED (BMC_LED)	4-19
3.	Standby power LED	4-20

4.2 Jumpers

1. Clear RTC RAM (CLRRTC1)

This jumper allows you to clear the Real Time Clock (RTC) RAM in CMOS. You can clear the CMOS memory of date, time, and system setup parameters by erasing the CMOS RTC RAM data. The onboard button cell battery powers the RAM data in CMOS, which include system setup information such as system passwords.

To erase the RTC RAM:

1. Turn OFF the computer and unplug the power cord.
2. Move the jumper cap from pins 1–2 (default) to pins 2–3. Keep the cap on pins 2–3 for about 5–10 seconds, then move the cap back to pins 1–2.
3. Plug the power cord and turn ON the computer.
4. Hold down the key during the boot process and enter BIOS setup to re-enter data.



Except when clearing the RTC RAM, never remove the cap on CLRRTC jumper default position. Removing the cap will cause system boot failure!



If the steps above do not help, remove the onboard battery and move the jumper again to clear the CMOS RTC RAM data. After the CMOS clearance, reinstall the battery.

Z9PH-D16 Series Clear RTC RAM

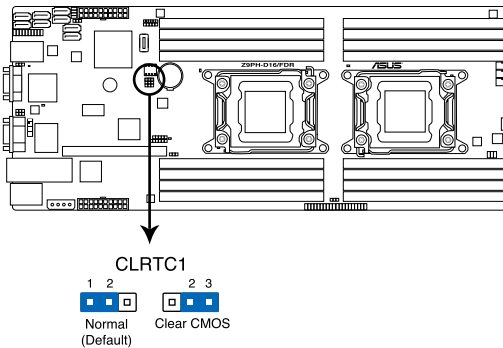

2. VGA controller setting (3-pin VGA_SW1)

This jumper allows you to enable or disable the onboard VGA controller. Set to pins 1–2 to activate the VGA feature.

Z9PH-D16 Series VGA setting

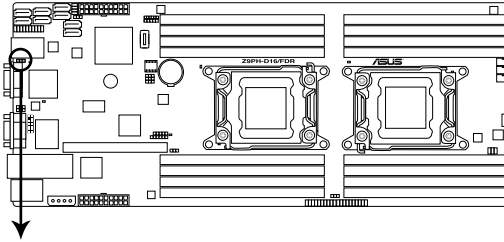

VGA_SW1

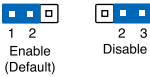

3. LAN controller setting (3-pin LAN_SW1, LAN_SW2)

These jumpers allow you to enable or disable the onboard Intel® Intel 82574L Gigabit LAN controllers. Set to pins 1–2 to activate the Gigabit LAN feature.

Z9PH-D16 Series LAN setting

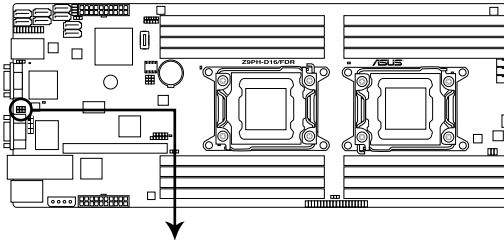

LAN_SW1
LAN_SW2

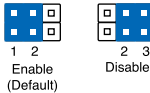

4. LSI MegaRAID or Intel RSTe selection jumper (3-pin RAID_SEL1)

This jumper allows you to select the PCH SATA RAID mode to use LSI MegaRAID software or Intel® Rapid Storage Technology enterprise 3.0 RAID. Place the jumper caps over pins 1–2 if you want to use the LSI MegaRAID software RAID Utility (default); otherwise, place the jumper caps to pins 2–3 to use the Intel® Rapid Storage Technology Enterprise Option ROM Utility.

Z9PH-D16 Series RAID setting

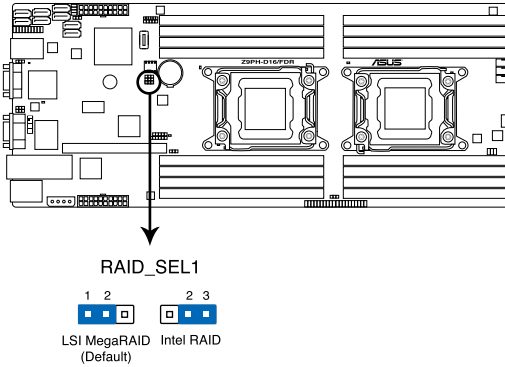

5. ME firmware force recovery setting (3-pin ME_RCVR1)

This jumper allows you to quickly recover the Intel Management Engine (ME) firmware when it becomes corrupted.

Z9PH-D16 Series ME_RCVR setting

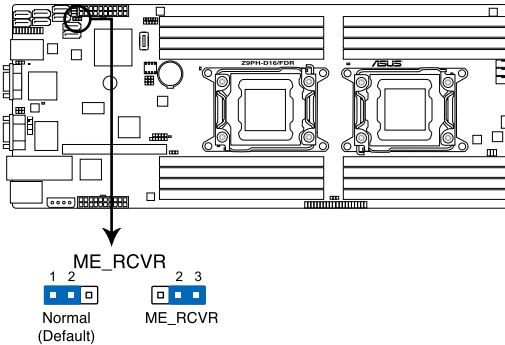

6. DIMM thermal trip Setting (3-pin DIMMTRIP1)

This jumper allows you to enable(default) or disable DIMM thermal trip.

Z9PH-D16 Series DIMM Thermaltrip setting

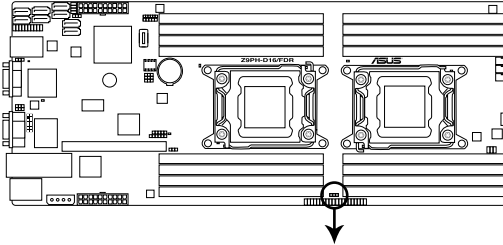

DIMMTRIP1



4.3 Internal connectors

1. **Serial ATA connectors (7-pin SATA1-2 [Light blue], SATA3-4 [Black])**
(SATA 6Gb/s: 7-pin SATA1-2 [Light blue])
(SATA 3Gb/s: 7-pin SATA3-4 [Black])

These connectors, controlled by Intel® C602 chipset, are for the Serial ATA signal cables for Serial ATA hard disk drives.

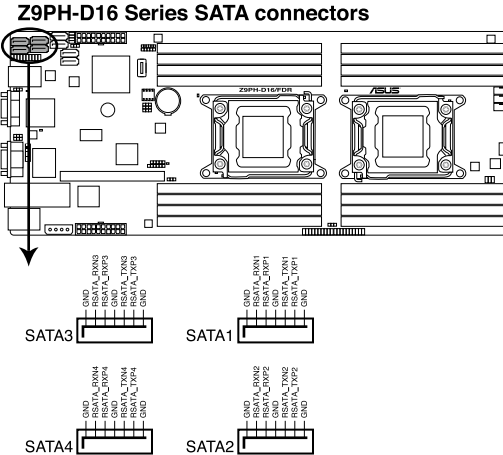

The actual data transfer rate depends on the speed of Serial ATA hard disks installed.

2. SATA connector - ISAS connectors (7-pin ISAS1-4 [Gray])

Supported by the Intel® C602 PCH. ISAS 1-4 connectors can connect to serial ATA 3Gb/s hard disk drives.

Z9PH-D16 Series Intel® ISAS connectors

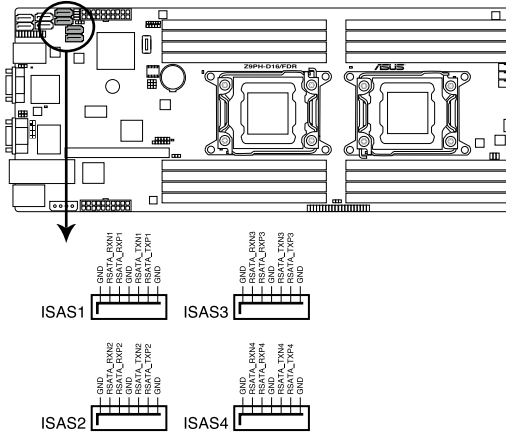

The actual data transfer rate depends on the speed of SATA hard disks installed.

For details on the Intel® Rapid Storage Technology utility, please refer to **Chapter 6 RAID Configuration**

3. USB connector (5-1 pin USB3; A-Type USB4)

These connectors are for USB 2.0 ports. Connect the USB module cables to connectors USB3, then install the modules to a slot opening at the back of the system chassis. These USB connectors comply with USB 2.0 specification that supports up to 480 Mbps connection speed.

Z9PH-D16 Series USB 2.0 connectors

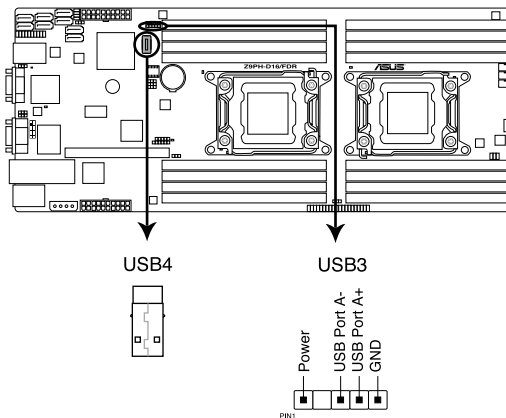

4. Front fan connectors (4-pin FRNT_FAN1, FRNT_FAN2, FRNT_FAN3, FRNT_FAN4)

The fan connectors support cooling fans of 350 mA–740 mA (8.88 W max.) or a total of 3.15 A–6.66 A (53.28 W max.) at +12V. Connect the fan cables to the fan connectors on the motherboard, ensuring that the black wire of each cable matches the ground pin of the connector.



- DO NOT forget to connect the fan cables to the fan connectors. Insufficient air flow inside the system may damage the motherboard components.
- These are not jumpers! DO NOT place jumper caps on the fan connectors!
- All fans feature the ASUS Smart Fan technology.

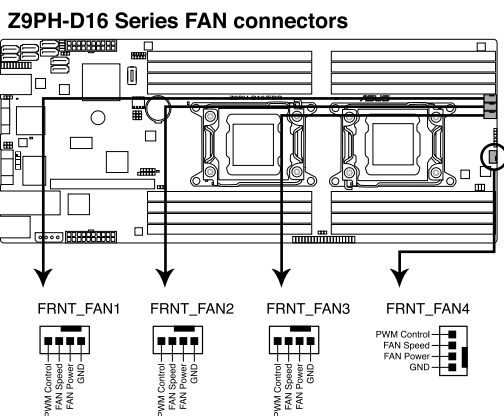

5. Serial General Purpose Input/Output connector (6-1 pin SGPIO1)

This connector is used for the SGPIO peripherals for the LSI MegaRAID and Intel Matrix RAID SATA LED.

Z9PH-D16 Series SGPIO1 connector

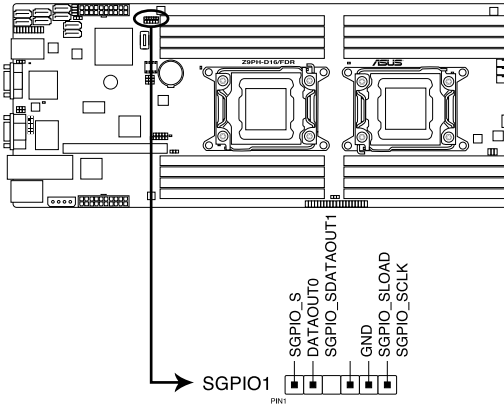

6. Serial General Purpose Input/Output connector (8-1 pin ISGPIO1)

This connector is used for the SGPIO peripherals for the LSI MegaRAID and Intel Matrix RAID SATA LED. This connector is used for SCU.

Z9PH-D16 Series ISGPIO1 connector

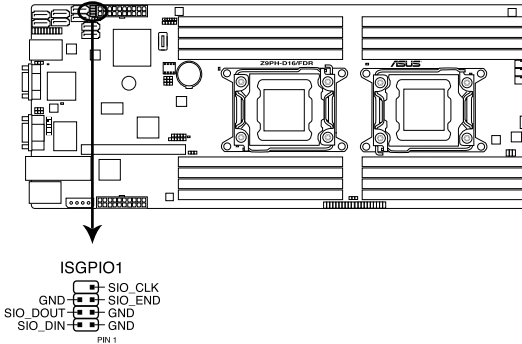

7. ASMB6 header (ASMB6)

The ASMB6 connector on the motherboard supports an ASUS® Server Management Board 6 Series.

Z9PH-D16 Series ASMB connector

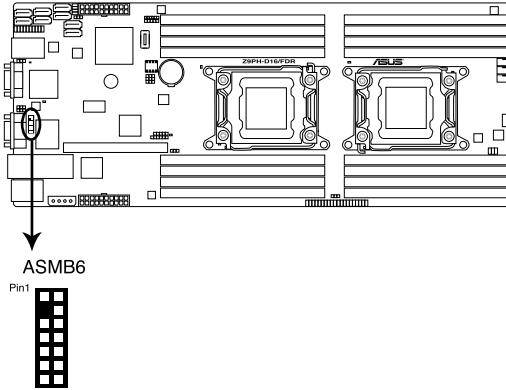

8. Thermal sensor cable connectors (3-pin TR1, TR2)

These connectors are for temperature monitoring. Connect the thermal sensor cables to these connectors and place the other ends to the devices, which you want to monitor temperature. Please go to BIOS setup to change the default setting of TR1/TR2 from “disabled” to “enabled” before using the thermal sensor cable.

Z9PH-D16 Series Thermal sensor cable connectors

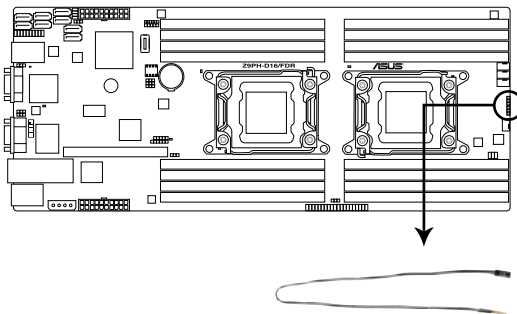

9. TPM connector (20-1 pin TPM)

This connector supports a Trusted Platform Module (TPM) system, which can securely store keys, digital certificates, passwords, and data. A TPM system also helps enhance network security, protects digital identities, and ensures platform integrity.

Z9PH-D16 Series TPM Connector

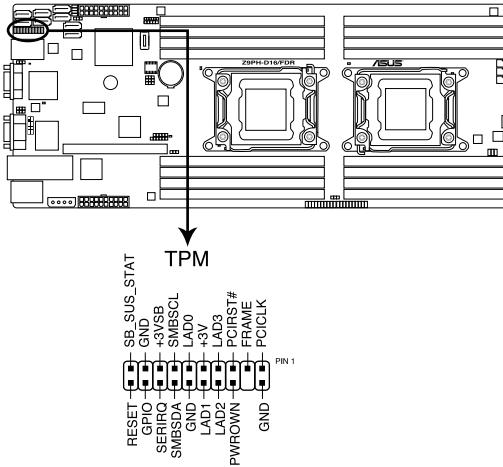

10. Power Supply SMBus connector (6-1 pin PSUSMB1)

This connector allows you to connect SMBus (System Management Bus) to the power supply unit to read PSU information. Devices communicate with an SMBus host and/or other SMBus devices using the SMBus interface.

Z9PH-D16 Series Power supply SMBus connector

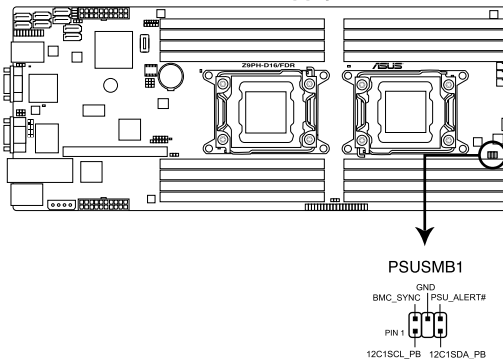

11. Proprietary power connectors (20-pin PWR1, 20-pin PWR2, 4-pin PWR3)

These connectors are for Proprietary power supply plugs. The power supply plugs are designed to fit these connectors in only one orientation. Orient the connectors and push down firmly until they completely fit.

The 4-pin PWR3 is designed for hard disk drives power supply. **DO NOT** connect other 4-pin power connectors of the power supply unit (PSU) to this connector.



- Connect either one of the 20-pin power connectors to boot the system.
- Use of a PSU with a higher power output is recommended when configuring a system with more power-consuming devices. The system may become unstable or may not boot up if the power is inadequate.
- **USE THE PROPRIETARY POWER SUPPLY ONLY** and ensure that your PSU can provide at least the minimum power required by your system.

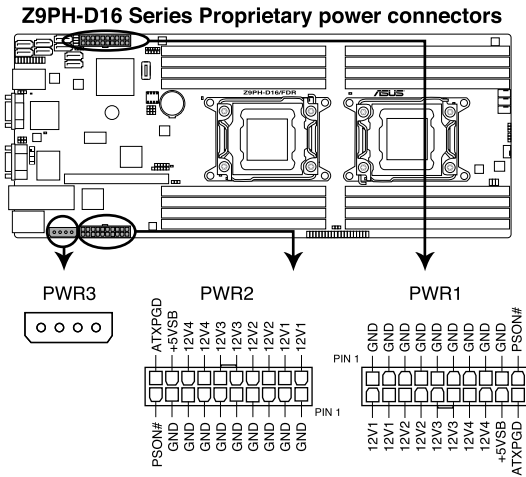

12. System panel connector (20-pin PANEL1 [White])

This connector supports several chassis-mounted functions.

Z9PH-D16 Series System panel connector

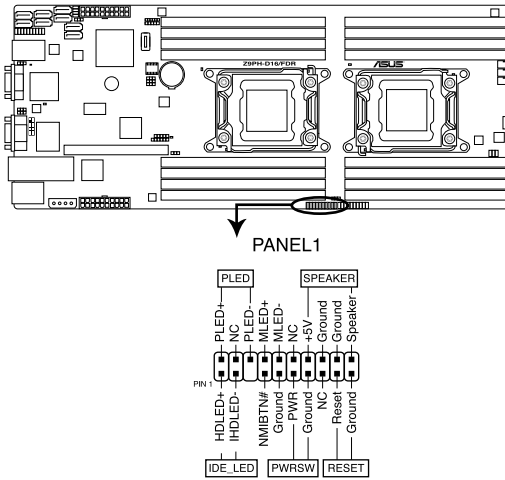

* Requires an ATX power supply

- **System power LED (3-pin PLED)**
This 3-pin connector is for the system power LED. Connect the chassis power LED cable to this connector. The system power LED lights up when you turn on the system power, and blinks when the system is in sleep mode.
- **Message LED (2-pin MLED)**
This 2-pin connector is for the message LED cable that connects to the front message LED. The message LED is controlled by Hardware monitor to indicate an abnormal event occurrence.
- **System warning speaker (4-pin SPEAKER)**
This 4-pin connector is for the chassis-mounted system warning speaker. The speaker allows you to hear system beeps and warnings.
- **Hard disk drive activity LED (2-pin HDDLED)**
This 2-pin connector is for the HDD Activity LED. Connect the HDD Activity LED cable to this connector. The IDE LED lights up or flashes when data is read from or written to the HDD.
- **Proprietary power button/soft-off button (2-pin PWRSW)**
This connector is for the system power button. Pressing the power button turns the system on or puts the system in sleep or soft-off mode depending on the BIOS settings. Pressing the power switch for more than four seconds while the system is ON turns the system OFF.
- **Reset button (2-pin RESET)**
This 2-pin connector is for the chassis-mounted reset button for system reboot without turning off the system power.

13. Auxiliary panel connector (20-pin AUX_PANEL1 [Black])

This connector is for additional front panel features including front panel SMB, locator LED and switch, chassis intrusion, and LAN LEDs.

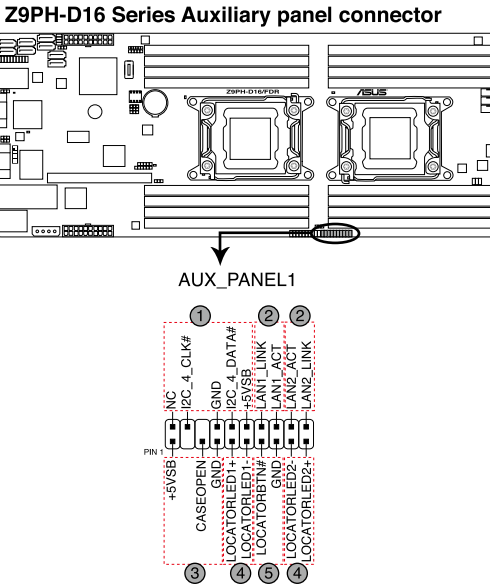

1. Front panel SMB (6-1 pin FPSMB)

These leads connect the front panel SMBus cable.

2. LAN activity LED (2-pin LAN1_LED, LAN2_LED)

These leads are for Gigabit LAN activity LEDs on the front panel.

3. Chassis intrusion (4-1 pin CHASSIS)

These leads are for the intrusion detection feature for chassis with intrusion sensor or microswitch. When you remove any chassis component, the sensor triggers and sends a high-level signal to these leads to record a chassis intrusion event. The default setting is short CASEOPEN and GND pin by jumper cap to disable the function.

4. Locator LED (2-pin LOCATORLED1 and 2-pin LOCATORLED2)

These leads are for the locator LED1 and LED2 on the front panel. Connect the Locator LED cables to these 2-pin connector. The LEDs will light up when the Locator button is pressed.

5. Locator Button/Switch (2-pin LOCATORBTN)

These leads are for the locator button on the front panel. This button queries the state of the system locator.

4.4 Internal LEDs

1. CPU warning LED (ERR_CPU1, ERR_CPU2)

The CPU warning LEDs light up to indicate an impending failure of the corresponding CPU.

Z9PH-D16 Series ERR CPU LED

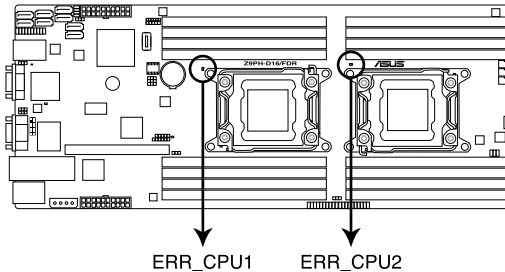

The warning LEDs function only when you install the ASUS ASMB6.

2. BMC LED(BMC_LED1)

The green heartbeat LED blinks per second to indicate that the ASMB6 is working normally.

Z9PH-D16 Series BMC LED

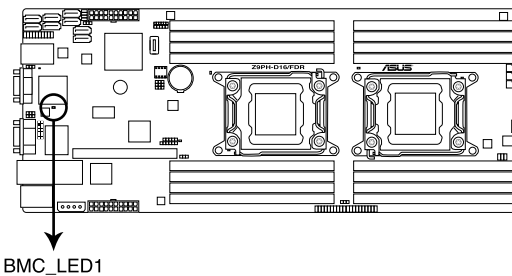

- The heartbeat LED functions only when you install the ASUS ASMB6
- Everytime after the AC power is replugged, you have to wait for about 30 seconds for the system to power up.

3. Standby Power LED (SB_PWR1)

The motherboard comes with a standby power LED. The green LED lights up to indicate that the system is ON, in sleep mode, or in soft-off mode. This is a reminder that you should shut down the system and unplug the power cable before removing or plugging in any motherboard component. The illustration below shows the location of the onboard LED.

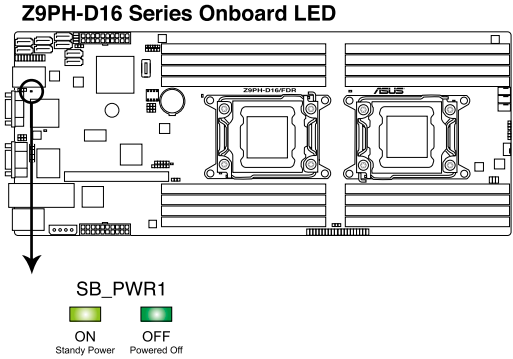

Chapter 5

This chapter tells how to change the system settings through the BIOS Setup menus. Detailed descriptions of the BIOS parameters are also provided.

BIOS setup

5.1 Managing and updating your BIOS

The following utilities allow you to manage and update the motherboard Basic Input/Output System (BIOS) setup:

1. **ASUS CrashFree BIOS 3** (To recover the BIOS using a bootable USB flash disk drive when the BIOS file fails or gets corrupted.)
2. **ASUS EZ Flash 2** (Updates the BIOS using a USB flash disk.)
3. **BUPDATER utility** (Updates the BIOS in DOS mode using a bootable USB flash disk drive.)

Refer to the corresponding sections for details on these utilities.



Save a copy of the original motherboard BIOS file to a bootable USB flash disk drive in case you need to restore the BIOS in the future. Copy the original motherboard BIOS using the BUPDATER utility.

5.1.1 ASUS CrashFree BIOS 3 utility

The ASUS CrashFree BIOS 3 is an auto recovery tool that allows you to restore the BIOS file when it fails or gets corrupted during the updating process. You can update a corrupted BIOS file using a USB flash drive that contains the updated BIOS file.



Prepare a USB flash drive containing the updated motherboard BIOS before using this utility.

Recovering the BIOS from a USB flash drive

To recover the BIOS from a USB flash drive:

1. Insert the USB flash drive with the original or updated BIOS file to one USB port on the system.
2. The utility will automatically recover the BIOS. It resets the system when the BIOS recovery finished.



DO NOT shut down or reset the system while recovering the BIOS! Doing so would cause system boot failure!



The recovered BIOS may not be the latest BIOS version for this motherboard. Visit the ASUS website at www.asus.com to download the latest BIOS file.

5.1.2 ASUS EZ Flash 2 Utility

The ASUS EZ Flash 2 Utility feature allows you to update the BIOS without having to use a DOS-based utility.



Before you start using this utility, download the latest BIOS from the ASUS website at www.asus.com.

To update the BIOS using EZ Flash 2 Utility

1. Insert the USB flash disk that contains the latest BIOS file to the USB port.
2. Enter the BIOS setup program. Go to the **Tool** menu to select **ASUS EZ Flash 2 Utility** and press <Enter> to enable it.

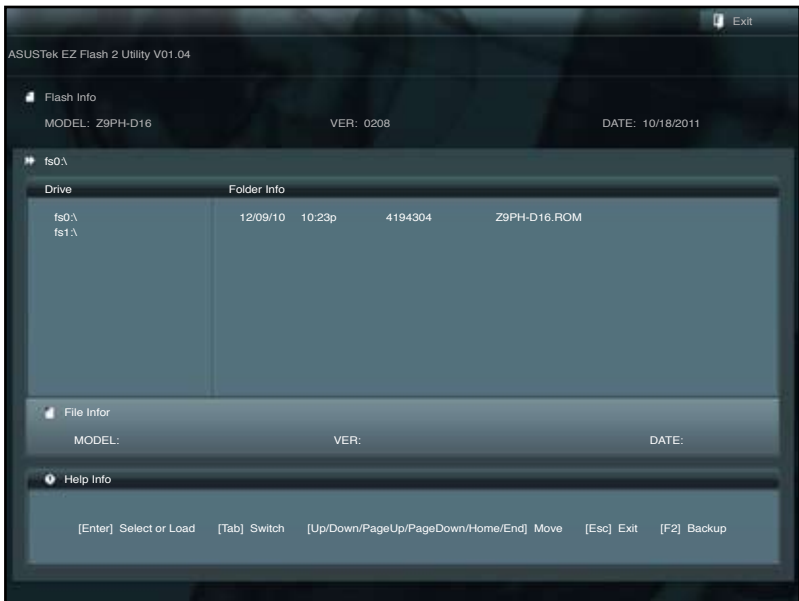

3. Press <Tab> to switch to the **Drive** field.
4. Press the Up/Down arrow keys to find the USB flash disk that contains the latest BIOS, and then press <Enter>.
5. Press <Tab> to switch to the **Folder Info** field.
6. Press the Up/Down arrow keys to find the BIOS file, and then press <Enter> to perform the BIOS update process. Reboot the system when the update process is done.



-
- This function can support devices such as a USB flash disk with FAT 32/16 format and single partition only.
 - DO NOT shut down or reset the system while updating the BIOS to prevent system boot failure!
-



Ensure to load the BIOS default settings to ensure system compatibility and stability. Press <F5> and select **Yes** to load the BIOS default settings.

5.1.3 BUPDATER utility



The succeeding BIOS screens are for reference only. The actual BIOS screen displays may not be the same as shown.

The BUPDATER utility allows you to update the BIOS file in DOS environment using a bootable USB flash disk drive with the updated BIOS file.

Updating the BIOS file

To update the BIOS file using the BUPDATER utility:

1. Visit the ASUS website at www.asus.com and download the latest BIOS file for the motherboard. Save the BIOS file to a bootable USB flash disk drive.
2. Copy the BUPDATER utility (BUPDATER.exe) from the ASUS support website at support.asus.com to the bootable USB flash disk drive you created earlier.
3. Boot the system in DOS mode, then at the prompt, type:

```
BUPDATER /i [filename] .ROM
```

where [filename] is the latest or the original BIOS file on the bootable USB flash disk drive, then press <Enter>.

```
A:\>BUPDATER /i[file name].ROM
```

- The utility verifies the file, then starts updating the BIOS file.

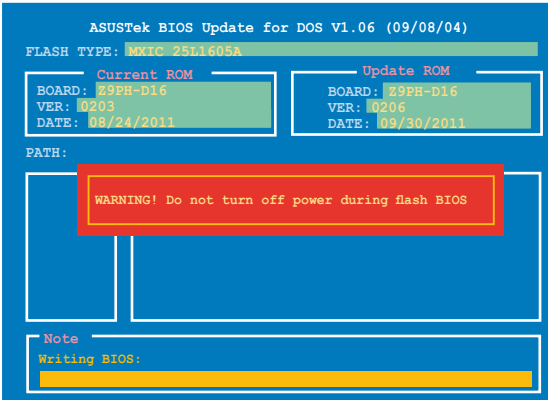

DO NOT shut down or reset the system while updating the BIOS to prevent system boot failure!

- The utility returns to the DOS prompt after the BIOS update process is completed. Reboot the system from the hard disk drive.

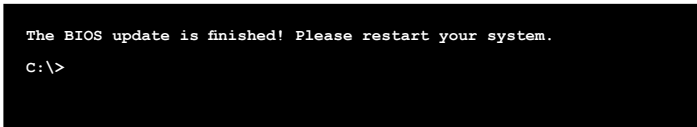

5.2 BIOS setup program

This motherboard supports a programmable firmware chip that you can update using the provided utility described in section 5.1 **Managing and updating your BIOS**.

Use the BIOS Setup program when you are installing a motherboard, reconfiguring your system, or prompted to “Run Setup.” This section explains how to configure your system using this utility.

Even if you are not prompted to use the Setup program, you can change the configuration of your computer in the future. For example, you can enable the security password feature or change the power management settings. This requires you to reconfigure your system using the BIOS Setup program so that the computer can recognize these changes and record them in the CMOS RAM of the firmware chip.

The firmware chip on the motherboard stores the Setup utility. When you start up the computer, the system provides you with the opportunity to run this program. Press during the Power-On Self-Test (POST) to enter the Setup utility; otherwise, POST continues with its test routines.

If you wish to enter Setup after POST, restart the system by pressing <Ctrl+Alt+Delete>, or by pressing the reset button on the system chassis. You can also restart by turning the system off and then back on. Do this last option only if the first two failed.

The Setup program is designed to make it as easy to use as possible. Being a menu-driven program, it lets you scroll through the various sub-menus and make your selections from the available options using the navigation keys.



-
- The default BIOS settings for this motherboard apply for most conditions to ensure optimum performance. If the system becomes unstable after changing any BIOS settings, load the default settings to ensure system compatibility and stability. Press <F5> and select **Yes** to load the BIOS default settings.
 - The BIOS setup screens shown in this section are for reference purposes only, and may not exactly match what you see on your screen.
 - Visit the ASUS website (www.asus.com) to download the latest BIOS file for this motherboard.
-

5.2.1 BIOS menu screen

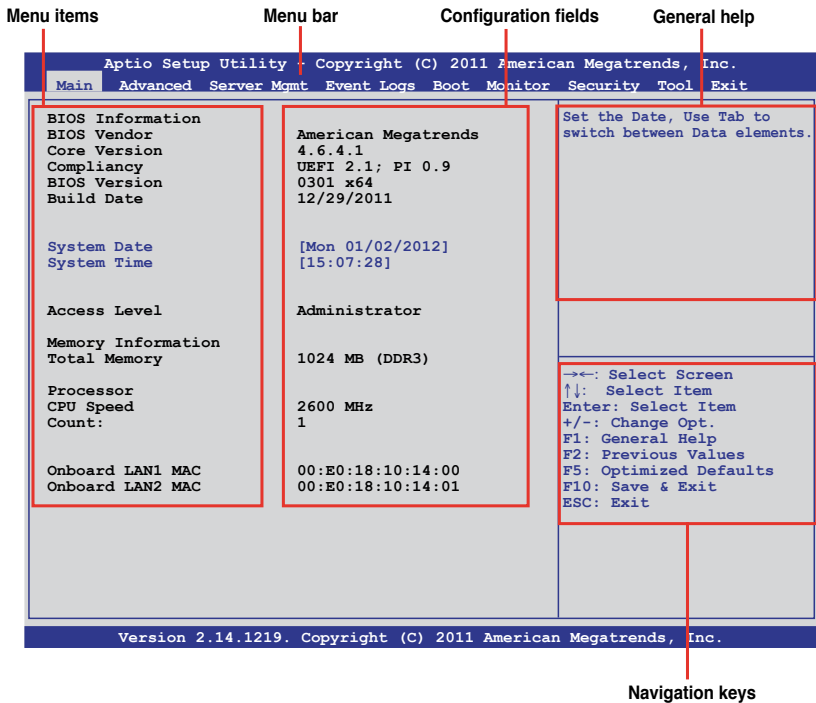

5.2.2 Menu bar

The menu bar on top of the screen has the following main items:

- | | |
|--------------------|--|
| Main | For changing the basic system configuration |
| Advanced | For changing the advanced system settings |
| Server Mgmt | For changing the Server Mgmt settings |
| Event Logs | For changing the event log settings |
| Monitor | For displaying the system temperature, power status, and changing the fan settings |
| Security | For changing the security settings |
| Boot | For changing the system boot configuration |
| Tool | For configuring options for special functions |
| Exit | For selecting the exit options |

To select an item on the menu bar, press the right or left arrow key on the keyboard until the desired item is highlighted.

5.2.3 Menu items

The highlighted item on the menu bar displays the specific items for that menu. For example, selecting **Main** shows the Main menu items.

The other items (Event Logs, Advanced, Monitor, Boot, Tool, and Exit) on the menu bar have their respective menu items.

5.2.4 Submenu items

A solid triangle before each item on any menu screen means that the item has a submenu. To display the submenu, select the item and press <Enter>.

5.2.5 Navigation keys

At the bottom right corner of a menu screen are the navigation keys for the BIOS setup program. Use the navigation keys to select items in the menu and change the settings.

5.2.6 General help

At the top right corner of the menu screen is a brief description of the selected item.

5.2.7 Configuration fields

These fields show the values for the menu items. If an item is user-configurable, you can change the value of the field opposite the item. You cannot select an item that is not user-configurable.

A configurable field is enclosed in brackets, and is highlighted when selected. To change the value of a field, select it and press <Enter> to display a list of options.

5.2.8 Pop-up window

Select a menu item and press <Enter> to display a pop-up window with the configuration options for that item.

5.2.9 Scroll bar

A scroll bar appears on the right side of a menu screen when there are items that do not fit on the screen. Press the Up/Down arrow keys or <Page Up> /<Page Down> keys to display the other items on the screen.

5.3 Main menu

When you enter the BIOS Setup program, the Main menu screen appears. The Main menu provides you an overview of the basic system information, and allows you to set the system date, time settings.

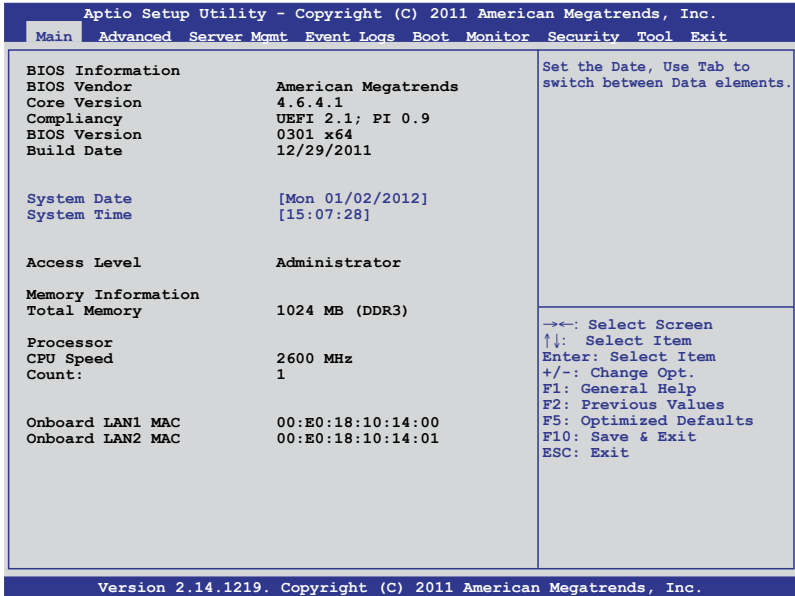

5.3.1 System Date [Day xx/xx/xxxx]

Allows you to set the system date.

5.3.2 System Time [xx:xx:xx]

Allows you to set the system time.

Socket 1 CPU Information

Enter to view socket soecific CPU Information.

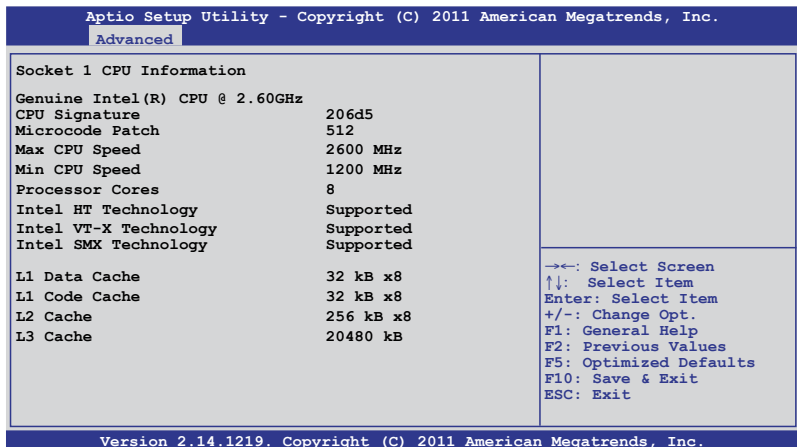

The screenshot shows the Aptio Setup Utility interface. At the top, it says 'Aptio Setup Utility - Copyright (C) 2011 American Megatrends, Inc.' and 'Advanced'. The main content area is titled 'Socket 1 CPU Information' and contains a table of CPU details. A legend on the right side of the table lists navigation keys: ← for 'Select Screen', ↑↓ for 'Select Item', Enter for 'Select Item', +/- for 'Change Opt.', F1 for 'General Help', F2 for 'Previous Values', F5 for 'Optimized Defaults', F10 for 'Save & Exit', and ESC for 'Exit'.

Socket 1 CPU Information	
Genuine Intel(R) CPU @ 2.60GHz	
CPU Signature	206d5
Microcode Patch	512
Max CPU Speed	2600 MHz
Min CPU Speed	1200 MHz
Processor Cores	8
Intel HT Technology	Supported
Intel VT-X Technology	Supported
Intel SMX Technology	Supported
L1 Data Cache	32 kB x8
L1 Code Cache	32 kB x8
L2 Cache	256 kB x8
L3 Cache	20480 kB

→←: Select Screen
↑↓: Select Item
Enter: Select Item
+/-: Change Opt.
F1: General Help
F2: Previous Values
F5: Optimized Defaults
F10: Save & Exit
ESC: Exit

Version 2.14.1219. Copyright (C) 2011 American Megatrends, Inc.

Hyper Threading [Enabled]

This item allows you to enable or disable the Intel® Hyper-Threading Technology function. When disabled, only one thread per activated core is enabled.

Configuration options: [Disabled] [Enabled]

Active Processor Cores [All]

Configuration options: [All] [1] [2] [3] [4] [5] [6] [7]

Limit CPUID Maximum [Disabled]

Setting this item to [Enabled] allows legacy operating system to boot even without support for CPUs with extended CPUID functions.

Configuration options: [Disabled] [Enabled]

Execute Disable Bit [Enabled]

XP can prevent certain classes of malicious buffer overflow attacks when combined with a supporting OS (Windows Server 2003 SP1, Windows XP SP2, SuSE Linux 9.2, Redhat Enterprise 3 Update 3).

Configuration options: [Disabled] [Enabled]

Server Class [Custom]

Use Intel recommended prefetch settings.

Configuration options: [Enterprise] [High Performance(HPC)] [Custom]

Hardware Prefetcher [Enabled]

This Item allows you to turn on/off the mid level cache(L2) streamer prefetcher.

Configuration options: [Disabled] [Enabled]

Adjacent Cache Line Prefetch [Enabled]

This Item allows you to turn on/off prefetching of adjacent cache lines.
Configuration options: [Disabled] [Enabled]

DCU Streamer Prefetcher [Enabled]

This Item allows you to enable or disable L1 data prefetcher.
Configuration options: [Disabled] [Enabled]

DCU IP Prefetcher [Enabled]

This Item allows you to enable or disable prefetch of next L1 line based upon sequential load history.
Configuration options: [Disabled] [Enabled]

Intel Virtualization Technology [Enabled]

When enabled this item, a VMM can utilize the additional hardware capabilities provided by Vanderpool Technology.
Configuration options: [Disabled] [Enabled]

Local APIC Mode [Disabled]

Select Local APIC mode. If Auto, use x2APIC if required. Otherwise, use xAPIC mode. xAPIC will disable CPUs with APIC IDs greater than 254. Some OS do not support x2APIC mode. Configuration options: [Disabled] [Enabled]

5.4.2 CPU Power Management Configuration

Aptio Setup Utility - Copyright (C) 2011 American Megatrends, Inc.	
Advanced	
<pre> CPU Power Management Configuration Power Technology [Custom] EIST [Enabled] Turbo Mode [Enabled] P-STATE Coordination [HW ALL] CPU C3 Report [Disabled] CPU C6 Report [Enabled] CPU C7 Report [Disabled] Package C State limit [C6] Energy Performance [Balanced Performance] Factory long duration power limit 115 Watts Long duration power limit 0 Factory long duration maintained 1000 ms Long duration maintained 0 Recommended short duration power 1 1.2 * Long Duration Short duration power limit 0 </pre>	<p>This item allows you to enabled power management features.</p> <p>→←: Select Screen ↑↓: Select Item Enter: Select Item +/-: Change Opt. F1: General Help F2: Previous Values F5: Optimized Defaults F10: Save & Exit ESC: Exit</p>
Version 2.14.1219. Copyright (C) 2011 American Megatrends, Inc.	

P-STATE Coordination [HW_ALL]

This item allows you to enable or disable Intel SpeedStep.

Configuration options: [HW_ALL] [SW_ALL] [SW_ANY]

CPU C3 Report [Disabled]

This item allows you to enable or disable CPU C3(ACPI C2) report.

Configuration options: [Disabled] [Enabled]

CPU C6 Report [Enabled]

This item allows you to enable or disable CPU C6(ACPI C3) report.

Configuration options: [Disabled] [Enabled]

CPU C7 Report [Disabled]

This item allows you to enable or disable CPU C7(ACPI C3) report.

Configuration options: [Disabled] [Enabled]

Package C State limit [C6]

This item allows you to set package C State limit.

Configuration options: [C0] [C2] [C6] [C7] [No Limit]

Energy Performance [Balanced Performance]

Optimize between performance and power savings. Windows 2008 and later OSes overrides this value according to this power plan.

Configuration options: [Performance] [Balanced Performance] [Balanced Energy] [Energy Efficient]

Factory long duration power limit 115 Watts

Long duration power limit 0

Allows you to set long duration power limit in watts. Use the <+> and <-> keys to adjust the value.

Factory long duration maintained 1000 ms

Long duration maintained 0

Allows you to set time window which the long duration power is maintained. Use the <+> and <-> keys to adjust the value.

Recommended short duration power limitation 1.2 * Long Duration

Short duration power limit 0

Allows you to set short duration power limit in watts. Use the <+> and <-> keys to adjust the value.

5.4.3 Chipset Configuration

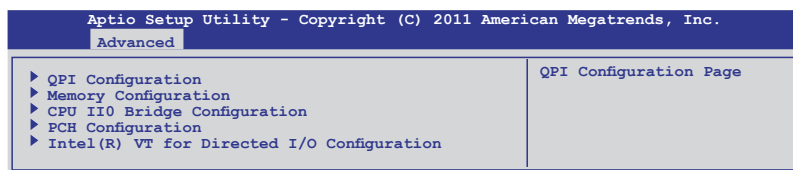

QPI Configuration

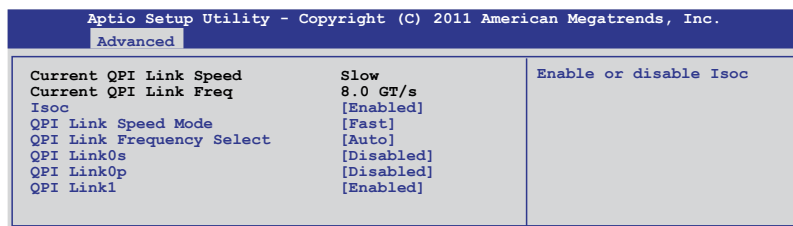

Isoc [Enabled]

Configuration options: [Disabled] [Enabled]

QPI Link Speed Mode [Fast]

This item allows you to select the QPI link speed as either the fast mode or slow mode.

Configuration options: [Slow] [Fast]

QPI Link Frequency Select [Auto]

This item allows for selecting the QPI link frequency

Configuration options: [Auto] [6.4 GT/s] [7.2 GT/s (Fast Mode Only)] [8.0 GT/s (Fast Mode Only)]

QPI Link0s [Disabled]

Configuration options: [Disabled] [Enabled]

QPI Link0p [Disabled]

Configuration options: [Disabled] [Enabled]

QPI Link1 [Enabled]

Configuration options: [Disabled] [Enabled]

Memory Configuration

Aptio Setup Utility - Copyright (C) 2011 American Megatrends, Inc.		
Advanced		
Compatibility RID	[Enabled]	Support for compatibility Revision ID(CRID) functionality mentioned in Sandybridge bios spec.
Memory Configuration		
Total Memory	1024 MB (DDR3)	
Current Memory Mode	Independent	
Currently Memory Speed	1066 MHz	
Mirroring	Not Possible	
Sparing	Not Possible	
Memory Mode	[Independent]	
Numa	[Enabled]	
DDR Speed	[Auto]	
Channel Interleaving	[Auto]	
Rank Interleaving	[Auto]	
Patrol Scrub	[Disabled]	
Demand Scrub	[Enabled]	
Data Scrambling	[Enabled]	
Device Tagging	[Disabled]	
Thermal Throttling	[CLTT]	
Enable High Temp.	[Disabled]	
Allow 2x Refresh	[Enabled]	
Altitude	[300 M]	
Memory HOT sensor support	[Enabled]	
▶ DIMM Information		
		→←: Select Screen ↑↓: Select Item Enter: Select Item +/-: Change Opt. F1: General Help F2: Previous Values F5: Optimized Defaults F10: Save & Exit ESC: Exit

Compatibility RID [Enabled]

Support for compatibility revision ID (CRID) functionality mentioned in Sandybridge BIOS spec. Configuration options: [Enabled] [Disabled]

Memory Mode [Independent]

Select the mode for memory initializer.

Configuration options: [Independent] [Mirroring] [Lock Step] [Sparing]

Numa [Enabled]

Enable or Disable Non uniform Memory Access (NUMA).

Configuration options: [Disabled] [Enabled]

DDR Speed [Auto]

Force DDR speed. Configuration options: [Auto] [Force DDR3 800] [Force DDR3 1066] [Force DDR3 1333] [Force DDR3 1600] [Force DDR3 1866]

Channel Interleaving [Auto]

Select different channel interleaving setting.

Configuration options: [Auto] [1 Way] [2 Way] [3 Way] [4 Way]

Rank Interleaving [Auto]

Select different rank interleaving setting.

Configuration options: [Auto] [1 Way] [2 Way] [4 Way] [8 Way]

Patrol Scrub [Disabled]

Allows you to enable or disable Patrol Scrub. Configuration options: [Disabled] [Enabled]

Demand Scrub [Enabled]

Allows you to enable or disable demand scrubbing feature.

Configuration options: [Disabled] [Enabled]

Data Scrambling [Enabled]

Allows you to enable or disable data scrambling.

Configuration options: [Disabled] [Enabled]

Device Tagging [Disabled]

Allows you to enable or disable device tagging.

Configuration options: [Disabled] [Enabled]

Thermal Throtting [CLTT]

Configuration options: [Disabled] [OLTT] [CLTT]

Enable High Temp. [Disabled]

Configuration options: [Disabled] [Enabled]

Allow 2x Refresh [Enabled]

Configuration options: [Disabled] [Enabled]

Altitude [300 M]

The system altitude above the sea level in meters.

Configuration options: [Auto] [300 M] [900 M] [1500 M] [3000 M]

Memory Hot sensor support [Enabled]

Configuration options: [Disabled] [Enabled]

DIMM Information

Aptio Setup Utility - Copyright (C) 2011 American Megatrends, Inc.	
Advanced	
CPU1 DIMM Information	
Node 0 Ch0 Dimm A1	Present 1024 MB (DDR3)
Node 0 Ch0 Dimm A2	Not Present
Node 0 Ch1 Dimm B1	Not Present
Node 0 Ch1 Dimm B2	Not Present
Node 0 Ch2 Dimm C1	Not Present
Node 0 Ch2 Dimm C2	Not Present
Node 0 Ch3 Dimm D1	Not Present
Node 0 Ch3 Dimm D2	Not Present
CPU2 DIMM Information	

CPU IIO Bridge Configuration

Aptio Setup Utility - Copyright (C) 2011 American Megatrends, Inc.		
Advanced		
Intel(R) I/OAT	[Disabled]	Enables/Disables Intel(R) I/O Acceleration Technology (I/OAT).
DCA Support	[Enabled]	
VGA Priority	[Offboard]	
TargetVGA	VGA From CPU 0	
→←: Select Screen ↑↓: Select Item Enter: Select Item +/-: Change Opt. F1: General Help F2: Previous Values F5: Optimized Defaults F10: Save & Exit ESC: Exit		

Version 2.14.1219. Copyright (C) 2011 American Megatrends, Inc.

Intel(R) I/OAT [Disabled]

Allows you to enable or disable Intel I/O acceleration technology.
Configuration options: [Disabled] [Enabled]

DCA Support [Enabled]

Allows you to enable or disable direct cache access support.
Configuration options: [Disabled] [Enabled]

VGA Priority [Offboard]

Allows you to decide priority between onboard and 1st offboard video device found.
Configuration options: [Onboard] [Offboard]

PCH Configuration

Aptio Setup Utility - Copyright (C) 2011 American Megatrends, Inc.		
Advanced		
Name	Patsburg	Support for PCH Compatibility Revision ID (CRID) functionality.
Stepping	04 (B0 Stepping)	
SB Chipset Configuration		
PCH Compatibility RID	[Disabled]	
Deep Sx	[Disabled]	
SCU devices	[Enabled]	
Onboard SATA RAID Oprom	[Enabled]	
High Precision Event Timer Configuration		→←: Select Screen ↑↓: Select Item Enter: Select Item +/-: Change Opt. F1: General Help F2: Previous Values F5: Optimized Defaults F10: Save & Exit ESC: Exit
High Precision Timer	[Enabled]	

Version 2.14.1219. Copyright (C) 2011 American Megatrends, Inc.

PCH Compatibility RID [Disabled]

Support for PCH compatibility. Configuration options: [Disabled] [Enabled]

Deep Sx [Disabled]

Configuration options: [Disabled] [Enabled in S5] [Enabled in S4 and S5]

SCU devices [Enabled]

Allows you to enable or disable Patsburg SCU devices.

Configuration options: [Enabled] [Disabled]

Onboard SATA RAID Oprom [Enabled]

Allows you to enable or disable onboard SATA RAID option rom if Launch Storage Oprom is enabled. Configuration options: [Disabled] [Enabled]

High Precision Event Timer Configuration

High Precision Timer [Enabled]

Allows you to enable or disable High Precision Event Timer.

Configuration options: [Disabled] [Enabled]

Intel(R) VT for Directed I/O Configuration

Aptio Setup Utility - Copyright (C) 2011 American Megatrends, Inc.		
Advanced		
Intel(R) VT-d	[Disabled]	Enables or Disables BIOS ACPI Auto Configuration.

Intel(R) VT-d [Disabled]

Allows you to enable or disable Intel VT-d.
 Configuration options: [Disabled] [Enabled]



The following item appears only when you set **Intel(R) VT-d** to [Enabled].

Coherency Support [Disabled]

Allows you to enable or disable VT-d Engine Coherency support.
 Configuration options: [Disabled] [Enabled]

ATS Support [Disabled]

Allows you to enable or disable VT-d Engine address translation services (ATS) support. Configuration options: [Disabled] [Enabled]

5.4.4 PCH SATA Configuration

Aptio Setup Utility - Copyright (C) 2011 American Megatrends, Inc.		
Advanced		
SATA Port1	Not Present	(1)IDE Mode. (2)AHCI Mode. (3)RAID Mode.
SATA Port2	ASUS DWR ATAPI	
SATA Port3	WDC WD800JD (80.0GB)	
SATA Port4	Not Present	
SATA Mode	[AHCI Mode]	→←: Select Screen ↑↓: Select Item Enter: Select Item +/-: Change Opt. F1: General Help F2: Previous Values F5: Optimized Defaults F10: Save & Exit ESC: Exit
SATA Controller 1	[Enhanced]	
SATA Controller 2	[Enhanced]	
S.M.A.R.T. Status Check	[Enabled]	
Port 1 Staggered Spin-up	[Disabled]	
Port 2 Staggered Spin-up	[Disabled]	
Port 3 Staggered Spin-up	[Disabled]	
Port 4 Staggered Spin-up	[Disabled]	

Version 2.14.1219. Copyright (C) 2011 American Megatrends, Inc.

SATA Mode [AHCI Mode]

Allows you to set the SATA configuration.

Configuration options: [Disabled] [IDE Mode] [AHCI Mode] [RAID Mode]



- If you want to use the Serial ATA hard disk drives as Parallel ATA physical storage devices, set this item to [IDE Mode].
- If you want the Serial ATA hard disk drives to use the Advanced Host Controller Interface (AHCI), keep the default setting [AHCI Mode]. The AHCI allows the onboard storage driver to enable advanced Serial ATA features that increases storage performance on random workloads by allowing the drive to internally optimize the order of commands.
- If you want to create RAID sets with LSI MegaRAID utility, or Intel® Rapid Storage Technology Enterprise from the Serial ATA hard disk drives, set this item to [RAID Mode].

SATA Controller 1 [Enhanced]

This item appears only when you set the **SATA Mode** item to [IDE Mode]. Set to [Enhanced] to support two SATA 6.0 Gb/s and two SATA 3.0 Gb/s devices. Set to [Compatible] when using Windows 98/NT/2000/MS-DOS. Up to four SATA devices are supported under these operating systems.

Configuration options: [Disabled] [Enhanced] [Compatible]

S.M.A.R.T. Status Check [Enabled]

S.M.A.R.T. (Self-Monitoring, Analysis and Reporting Technology) is a monitor system. When read/write of your hard disk errors occur, this feature allows the hard disk to report warning messages during the POST.

Configuration options: [Disabled] [Enabled]

Staggered Spin-up [Disabled]

Staggered spin-up is a feature defined in the Serial ATA Specifications. It enables an HBA to individually spin-up attached SATA devices to avoid maximum current charged by applying all attached SATA devices at the same time.

Configuration options: [Disabled] [Enabled]

5.4.5 PCH SCU Configuration

This menu automatically detects and displays Device 1-4

Aptio Setup Utility - Copyright (C) 2011 American Megatrends, Inc.		
Advanced		
Device1	Not Present	
Device2	Not Present	
Device3	Not Present	
Device4	Not Present	
		→←: Select Screen ↑↓: Select Item Enter: Select Item +/-: Change Opt. F1: General Help F2: Previous Values F5: Optimized Defaults F10: Save & Exit ESC: Exit

5.4.6 PCI Subsystem Settings

Aptio Setup Utility - Copyright (C) 2011 American Megatrends, Inc.		
Advanced		
PCI Bus Driver Version	V 2.05.00	In case of multiple Option ROMs (Legacy and EFI Compatible), specifies what PCI option ROM to lanuch.
PCI Option ROM Handling		
PCI ROM Priority	[EFI Compatible ROM]	
PCI Common Setting		
PCI Latency Timer	[32 PCI Bus Clocks]	
VGA Palette Snoop	[Disabled]	
PERR# Generation	[Disabled]	
SERR# Generation	[Disabled]	
Load RT32 Image	[Enabled]	
▶ PCI Express Settings		
▶ PCIe Slot Option Rom Configuration		
		→←: Select Screen ↑↓: Select Item Enter: Select Item +/-: Change Opt. F1: General Help F2: Previous Values F5: Optimized Defaults F10: Save & Exit ESC: Exit

Version 2.14.1219. Copyright (C) 2011 American Megatrends, Inc.

PCI ROM Priority [EFI Compatible ROM]

In case of multiple option roms (Legacy and EFI Compatible), specifies what PCI option rom to launch. Configuration options: [Legacy ROM] [EFI Compatible ROM]

PCI Latency Timer [32 PCI Bus Clocks]

Value to be programmed into PCI latency timer register

Configuration options: [32 PCI Bus Clocks] [64 PCI Bus Clocks] [96 PCI Bus Clocks] [128 PCI Bus Clocks] [160 PCI Bus Clocks] [192 PCI Bus Clocks] [224 PCI Bus Clocks] [248 PCI Bus Clocks]

VGA Palette Snoop [Disabled]

Enables or disables VGA palette registers snooping.

Configuration options: [Disabled] [Enabled]

PERR# Generation [Disabled]

Enables or disables PCI device to generate PERR#.

Configuration options: [Disabled] [Enabled]

SERR# Generation [Disabled]

Enables or disables PCI device to generate SERR#.

Configuration options: [Disabled] [Enabled]

Load RT32 Image [Enabled]

Enables or disables Load RT32 Image.

Configuration options: [Disabled] [Enabled]

PCI Express Settings

Aptio Setup Utility - Copyright (C) 2011 American Megatrends, Inc.	
Advanced	
PCI Express Link Register Settings ASPM Support [Disabled] WARNING: Enabling ASPM may cause some PCI-E device to fail	Set the ASPM Level: Force L0s - Force all links to L0s State: AUTO - BIOS auto configure: DISABLE: Disables ASPM.
	→←: Select Screen ↑↓: Select Item Enter: Select Item +/-: Change Opt. F1: General Help F2: Previous Values F5: Optimized Defaults F10: Save & Exit ESC: Exit
Version 2.14.1219. Copyright (C) 2011 American Megatrends, Inc.	

PCI Express Link Register Settings

ASPM Support [Disabled]

Allows you to set the ASPM level. Configuration options: [Disabled] [Auto] [Force L0s]

- [Force L0s] Force all links to L0s state.
- [Auto] BIOS auto configure.
- [Disabled] Disabled ASPM.

PCIe Slot Option Rom Configuration

Aptio Setup Utility - Copyright (C) 2011 American Megatrends, Inc.	
Advanced	
Legacy OpROM Support Launch Storage OpROM [Enabled] PCIe1 Option Rom [Enabled]	Enables or disables Boot Option for Legacy Mass Storage Device with Option ROM. →←: Select Screen ↑↓: Select Item Enter: Select Item +/-: Change Opt. F1: General Help F2: Previous Values F5: Optimized Defaults F10: Save & Exit ESC: Exit
Version 2.14.1219. Copyright (C) 2011 American Megatrends, Inc.	

Launch Storage OpROM [Enabled]

Allows you to enable or disable Boot Option for Legacy Mass Storage Devices with Option ROM. Configuration options: [Disabled] [Enabled]

PCIe1 Option Rom [Enabled]

Allows you to enable or disable PCIe1 Option Rom. Configuration options: [Disabled] [Enabled]

5.4.7 Intel TXT(LT-SX) Configuration

The Intel TXT(LT-SX) configuration automatically detects and displays the Intel TXT(LT-SX) hardware support.

Aptio Setup Utility - Copyright (C) 2011 American Megatrends, Inc.	
Advanced	
Intel TXT(LT-SX) Hardware Support CPU: TXT Feature Supported Chipset: TXT Feature Supported Intel TXT(LT-SX) Configuration TXT Support Disabled Intel TXT(LT-SX) Dependencies The following must be supported and enabled. VT-d Support Enabled VT Support Enabled TPM Support Enabled TPM State Disabled	→←: Select Screen ↑↓: Select Item Enter: Select Item +/-: Change Opt. F1: General Help F2: Previous Values F5: Optimized Defaults F10: Save & Exit ESC: Exit
Version 2.14.1219. Copyright (C) 2011 American Megatrends, Inc.	

5.4.8 USB Configuration

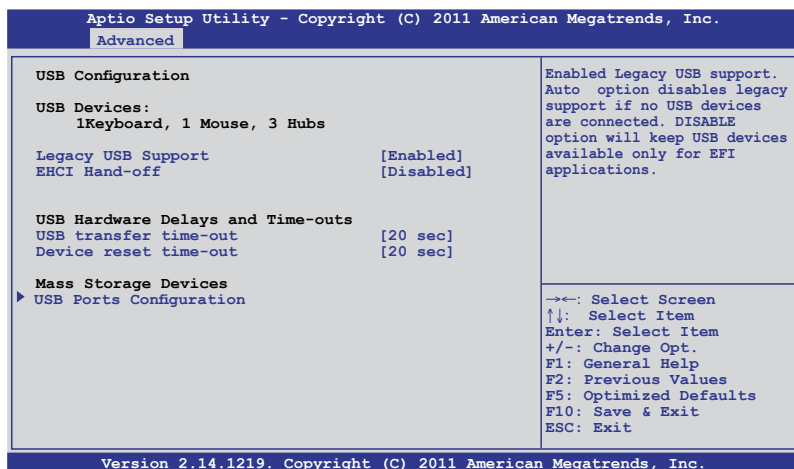

Legacy USB Support [Enabled]

Enables or disables Legacy USB device support. Auto option disables legacy support if no USB devices are connected. DISABLE option will keep USB device available only for EFI applications.

Configuration options: [Enabled] [Disabled] [Auto]

EHCI Hand-off [Disabled]

This is a workaround for Oses without EHCI ownership change should be claimed by EHCI driver. Configuration options: [Disabled] [Enabled]

USB Hardware Delays and Time-outs

USB transfer time-out [20 sec]

The time-out value for control, bulk, and interrupt transfer.

Configuration options: [1 sec] [5 sec] [10 sec] [20 sec]

Device reset time-out [20 sec]

USB mass storage device start unit command time-out.

Configuration options: [10 sec] [20 sec] [30 sec] [40 sec]

USB Ports Configuration

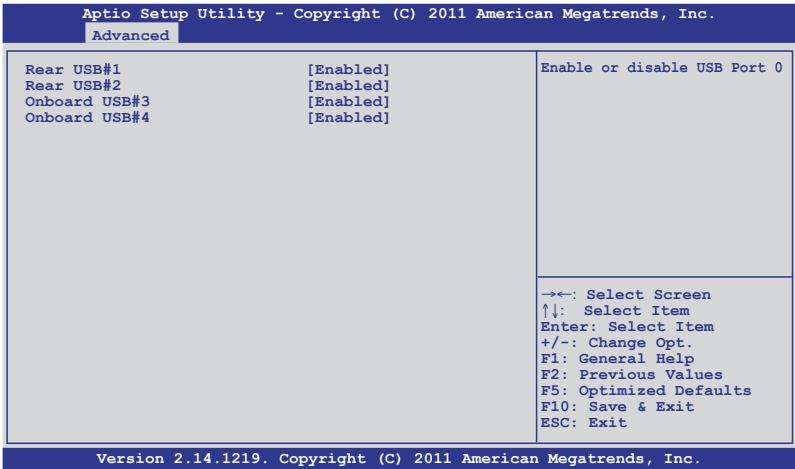

Rear / Onboard USB Port [Enabled]

Allows you to enable or disable Rear/Onboard USB port.

Configuration options: [Disabled] [Enabled]

5.4.9 Trusted Computing

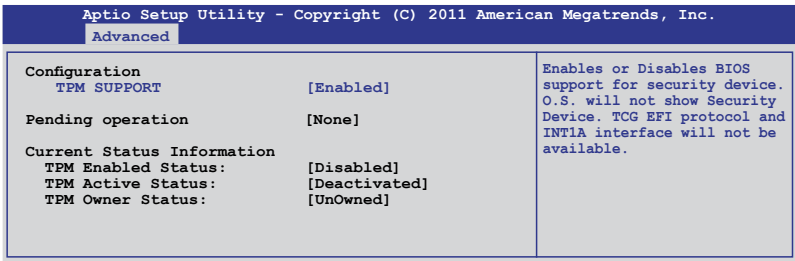

TPM Support [Enabled]

Allows you to enable or disable the TPM support.

Configuration options: [Disabled] [Enabled]

Pending operation [None]

Configuration options: [None] [Enable Take Owership] [Disable Take Ownership] [TPM Clear]

5.4.10 ACPI Settings

Aptio Setup Utility - Copyright (C) 2011 American Megatrends, Inc.	
Advanced	
ACPI Settings	Enables or Disables BIOS ACPI Auto Configuration.
Enable ACPI Auto Configuration [Disabled]	
Enabled Hibernation [Enabled]	
ACPI Sleep State [S1 (CPU Stop Clock)]	
Lock Legacy Resources [Disabled]	

Enable ACPI Auto Configuration [Disabled]

Allows you to enable or disable BIOS ACPI Auto Configuration.

Configuration options: [Disabled] [Enabled]



The following item appears only when you set **Enabled ACPI Auto Configuration** to [Disabled].

Enable Hibernation [Enabled]

Enables or disables system ability to Hibernate (OS/S4 sleep state). This option may be not effective with some OS.

Configuration options: [Disabled] [Enabled]

ACPI Sleep State [S1 (CPU Stop Clock)]

Allows you to set the ACPI Sleep State.

Configuration options: [Suspend Disabled] [S1 (CPU Stop Clock)]

Lock Legacy Resources [Disabled]

Allows you to enable or disable Lock Legacy Resources.

Configuration options: [Disabled] [Enabled]

5.4.11 WHEA Configuration

Aptio Setup Utility - Copyright (C) 2011 American Megatrends, Inc.		
Advanced		
WHEA Support	[Enabled]	Enable or disable Windows Hardware Error Architecture.

WHEA Support [Enabled]

Allows you to enable or disable the Windows Hardware Error Architecture support.
Configuration options: [Disabled] [Enabled]

5.4.12 APM setting

Aptio Setup Utility - Copyright (C) 2011 American Megatrends, Inc.		
Advanced		
Restrore AC Power Loss	[Last State]	Specify what state to go to when power is re-applied after a power failure (G3 state).
Power On By PCIE	[Disabled]	
Power On By Ring	[Disabled]	
Power On By RTC	[Disabled]	

Restore AC Power Loss [Last State]

When set to [Power Off], the system goes into off state after an AC power loss.
When set to [Power On], the system will reboot after an AC power loss. When set to [Last State], the system goes into either off or on state, whatever the system state was before the AC power loss.
Configuration options: [Power Off] [Power On] [Last State]

Power On By PCIE [Disabled]

[Disabled] Disables the PCIE devices to generate a wake event.
[Enabled] Enables the PCIE devices to generate a wake event.

Resume On By Ring [Disabled]

When set to [Enabled], the system will generate a wake event when the external modem receives a call while the computer is in Soft-off mode.
Configuration options: [Disabled] [Enabled]

Power On By RTC [Disabled]

[Disabled] Disables RTC to generate a wake event.
[Enabled] When set to [Enabled], the items **RTC Alarm Date (Days)** and **Hour/Minute/Second** will become user-configurable with set values.

5.4.13 Onboard LAN Configuration

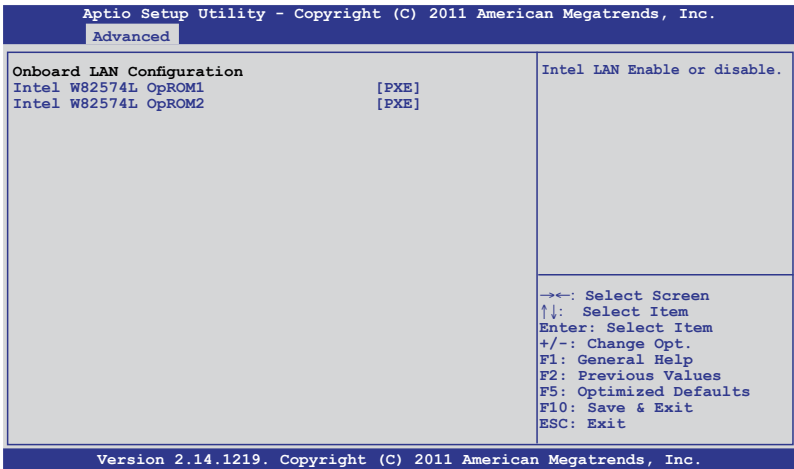

Intel W82574L OpROM1 [PXE]

Allows you to launch Intel W82574L OpROM1 boot mode. Configuration options:
[Disabled] [PXE] [iSCSI]

Intel W82574L OpROM2 [PXE]

llows you to launch Intel W82574L OpROM2 boot mode. Configuration options:
[Disabled] [PXE] [iSCSI]

5.4.14 Serial Port Console Redirection

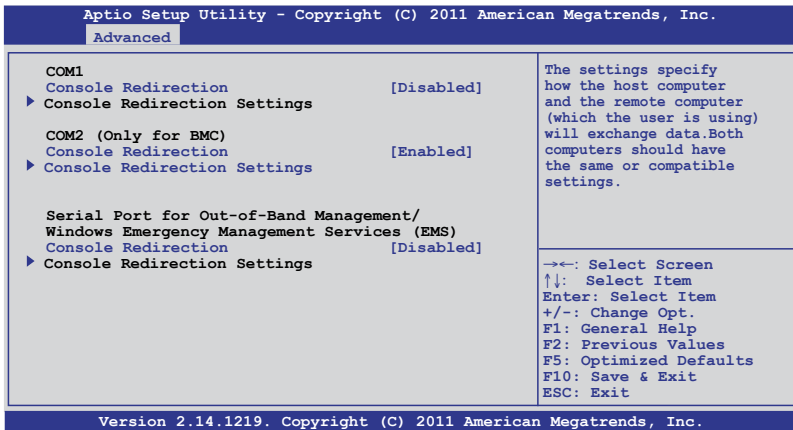

COM1

Console Redirection [Disabled]

Enables or disables the console redirection feature.

Configuration options: [Disabled] [Enabled]



The following item appears only when you set **Console Redirection** to [Enabled].

Console Redirection Settings

This item becomes configurable only when you enable the **Console Redirection** item. The settings specify how the host computer and the remote computer (which the user is using) will exchange data. Both computers should have the same or compatible settings.

Terminal Type [VT-UTF8]

Allows you to set the terminal type.

[VT100] ASCII char set.

[VT100+] Extends VT100 to support color, function keys, et.

[VT-UTF8] Uses UTF8 encoding to map Unicode chars onto 1 or more bytes

[ANSI] Extended ASCII char set

Bits per second [57600]

Selects serial port transmission speed. The speed must be matched on the other side. Long or noisy lines may require lower speeds.

Configuration options: [9600] [19200] [38400] [57600] [115200]

Data Bits [8]

Configuration options: [7] [8]

Parity [None]

A parity bit can be sent with the data bits to detect some transmission errors. [Mark] and [Space] parity do not allow for error detection.

[None] none

[Even] parity bit is 0 if the num of 1's in the data bits is even

[Odd] parity bit is 0 if num of 1's in the data bits is odd

[Mark] parity bit is always 1

[Space] parity bit is always 0

Stop Bits [1]

Stop bits indicate the end of a serial data packet. (A start bit indicates the beginning.) The standard setting is 1 stop bit. Communication with slow devices may require more than 1 stop bit. Configuration options: [1] [2]

Flow Control [Hardware RTS/CTS]

Flow control can prevent data loss from buffer overflow. When sending data, if the receiving buffers are full, a "stop" signal can be sent to stop the data flow. Once the buffers are empty, a "start" signal can be sent to re-start the flow. Hardware flow control uses two wires to send start/stop signals. Configuration options: [None] [Hardware RTS/CTS]

Recorder Mode [Disabled]

With this mode enabled only text will be sent. This is to capture Terminal data.

Configuration options: [Disabled] [Enabled]

Legacy OS Redirection Resolution [80x24]

Configures the number of rows and columns supported on legacy OS. Configuration options: [80x24] [80x25]

COM2

Console Redirection [Enabled]

Enables or disables the console redirection feature.

Configuration options: [Disabled] [Enabled]

Console Redirection Settings

Please refer to the description of the **Console Redirection Settings** item under COM1 for details.

Serial Port for Out-of-Band Management/ Windows Emergency Management Services (EMS) Console Redirection [Disabled]

Enables or disables the console redirection feature.
Configuration options: [Disabled] [Enabled]



The following item appears only when you set **Cinsloe Redirection** to [Enabled].

Console Redirection Settings

Out-of-Band Mgmt Port [COM1]

Microsoft Windows Emergency Management Services (EMS) allow for remote management of a Windows Server OS through a serial port.
Configuration options: [COM1] [COM2 (Only for BMC)]

Terminal Type [VT-UTF8]

Microsoft Windows Emergency Management Services (EMS) allow for remote management of a Windows Server OS through a serial port.
Configuration options: [VT100] [VT100+] [VT-UTF8] [ANSI]

Bits per second [115200]

Microsoft Windows Emergency Management Services (EMS) allow for remote management of a Windows Server OS through a serial port.
Configuration options: [9600] [19200] [57600] [115200]

Flow Control [None]

Microsoft Windows Emergency Management Services (EMS) allow for remote management of a Windows Server OS through a serial port.
Configuration options: [None] [Hardware RTS/CTS] [Software Xon/Xoff]

5.4.15 ME Subsystem

Aptio Setup Utility - Copyright (C) 2011 American Megatrends, Inc.

Advanced

<pre> Intel ME Subsystem Configuration ME BIOS Interface Version 0.0 ME Version 0.0.0.0 ME FW Status Value : 0x0 ME FW State : SPS ME FW Active ME FW Operation State: M0 without UMA ME FW Error Code: No Error ME Ext FW Status value: 0x0 BIOS Booting Mode: Performance ptimized Cores Disabled: 0 ME FW SKU Information: SiEn NM </pre>	<pre> ME Subsystem Help. -><-: Select Screen ↑↓: Select Item Enter: Select Item +/-: Change Opt. F1: General Help F2: Previous Values F5: Optimized Defaults F10: Save & Exit ESC: Exit </pre>
--	---

Version 2.14.1219. Copyright (C) 2011 American Megatrends, Inc.

5.4.16 Legacy Devices Configuration

Aptio Setup Utility - Copyright (C) 2011 American Megatrends, Inc.

Advanced

<pre> ▶ Serial Port 1 Configuration ▶ Serial Port 2 Configuration </pre>	<pre> Set Parameters of serial Port 1(COM1). </pre>
--	---

Serial Port 1/2 Configuration

Aptio Setup Utility - Copyright (C) 2011 American Megatrends, Inc.

Advanced

<pre> Serial Port Configuration Serial Port [Enabled] Device Settings I0=3F8h; IRQ=4 Device Mode [Standard Serial Po...] </pre>	<pre> Enable or Disable Serial Port(COM). </pre>
--	--

Serial Port [Enabled]

Allows you to enable or disable the serial port.
Configuration options: [Disabled] [Enabled]

Device Mode [Standard Serial Port Mode]

Allows you to change the serial port mode.
Configuration options: [Standard Serial Port Mode]

5.4.17 Runtime Error Logging

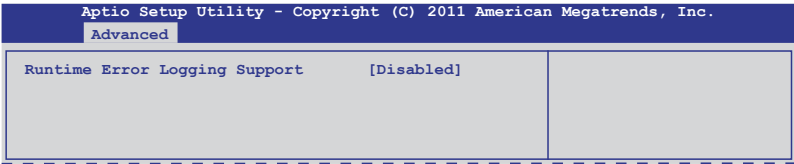

Runtime Error Logging Support [Disabled]

This item allows you to enable or disable Runtime Error Logging Support.
Configuration options: [Disabled] [Enabled]



The following item appears only when you set **Runtime Error Logging Support** to [Enabled].

PCI Error Logging Support [Disabled]

Allows you to enable or disable PCI Error Logging.
Configuration options: [Disabled] [Enabled].

5.5 Server Mgmt menu

The Server Mgmt menu displays the server mgmt status, and allows you to change the settings.



The Server Mgmt menu appears only when you install ASMB card on the motherboard.

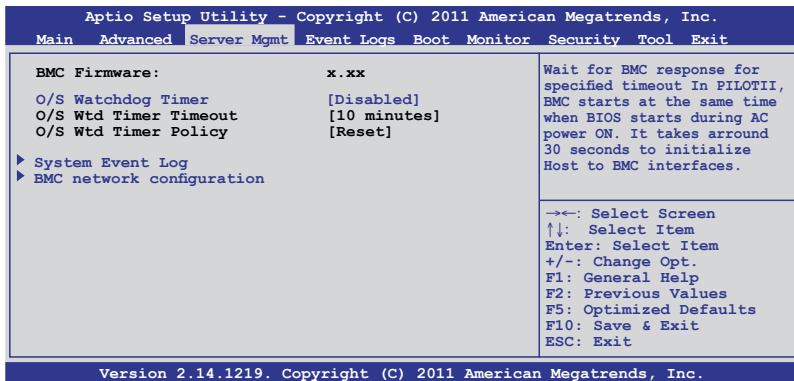

O/S Watchdog Timer [Disabled]

If enabled, starts a BIOS timer which can only be shut off by Intel Management Software after the OS loads. Helps determine that the OS successfully loaded or follows the **O/S Boot Watchdog Timer Policy**.

Configuration options: [Enabled] [Disabled]

O/S Wtd Timer Timeout [10 minutes]

Allows you to configure the length of the O/S Boot Watchdog Timer. Not available if **O/S Boot Watchdog Timer** is disabled.

Configuration options: [5 minutes] [10 minutes] [15 minutes] [20 minutes]

O/S Wtd Timer Policy [Reset]

Allows you to configure how the system should respond if the **OS Boot Watchdog Timer** expires. Not available if **O/S Boot Watchdog Timer** is disabled.

Configuration options: [Do Nothing] [Reset] [Power Down]

5.5.1 System Event Log

Aptio Setup Utility - Copyright (C) 2011 American Megatrends, Inc.	
Server Mgmt	
Enabling/Disabling Options	Change this to enable or disable all features of system Event Logging during boot.
SEL Components [Disabled]	
Erasing Settings	
Erase SEL [No]	
When SEL is Full [Do Nothing]	
Custom EFI Logging Options	
Note: All values changed here do not take effect until computer is restarted.	
	→←: Select Screen ↑↓: Select Item Enter: Select Item +/-: Change Opt. F1: General Help F2: Previous Values F5: Optimized Defaults F10: Save & Exit ESC: Exit

SEL Components [Disabled]

Allows you to enable or disable all features of system Event Logging during boot.
Configuration options: [Disabled] [Enabled]



- The following items appears only when you set **SEL Components** to [Enabled].
- All values changed here do not take effect until computer is restarted.

Erase SEL [No]

Allows you to choose options for erasing SEL.
Configuration options: [No] [Yes, On next reset] [Yes, On every reset]

When SEL is Full [Do Nothing]

Allows you to choose options for reactions to a full SEL.
Configuration options: [Do Nothing] [Erase Immediately]

Custom EFI Logging Options

5.5.2 BMC network configuration

Aptio Setup Utility - Copyright (C) 2011 American Megatrends, Inc.

Server Mgmt

BMC network configuration	Select to configure LAN channel parameters statically or dynamically (by BIOS or BMC). Unspecified option will not modify any BMC network parameters during BIOS phase
DM_LAN1	
DM_LAN1 IP Address in BMC:	192.168.001.001
DM_LAN1 Subnet Mask in BMC:	255.255.255.000
DM_LAN1 Gateway Address in BMC:	000.000.000.000
DM_LAN1 MAC Address in BMC:	00.CE.01.87.72.A0
DM_LAN1 Address Source in BMC:	Static Mode
Configuration Address source	[Previous State]
Lan1	
Lan1 IP Address in BMC:	192.168.001.002
Lan1 Subnet Mask in BMC:	255.255.255.000
Lan1 Gateway Address in BMC:	000.000.000.000
Lan1 MAC Address in BMC:	00.CE.01.87.72.A0
Lan1 Address Source in BMC:	Static Mode
Configuration Address source	[Previous State]

→←: Select Screen
↑↓: Select Item
Enter: Select Item
+/-: Change Opt.
F1: General Help
F2: Previous Values
F5: Optimized Defaults
F10: Save & Exit
ESC: Exit

Version 2.14.1219. Copyright (C) 2011 American Megatrends, Inc.

Configuration Address source [Previous State]

Select to configure LAN channel parameters statically or dynamically (by BIOS or BMC). Unspecified option will not modify any BMC network parameters during BIOS phase.

Configuration options: [Previous State] [Static Mode] [DHCP Mode]



The following items appears only when you set **Configuration Address source** to [Static Mode].

Station IP address [0.0.0.0]

Allows you to input Station IP address.

Subnet mask [0.0.0.0]

Allows you to input Subnet mask.

Gateway IP address [0.0.0.0]

Allows you to input Gateway IP address.

5.6 Event Logs menu

The Event Logs allows you to change or view the event log settings.

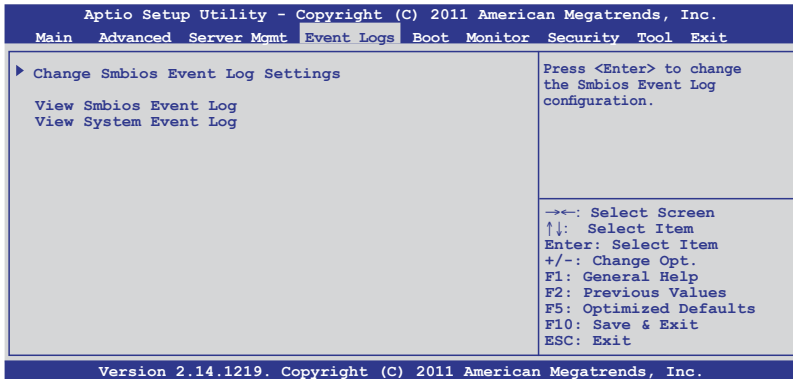

5.6.1 Change Smbios Event Log Settings

Press <Enter> to change the Smbios Event Log configuration.

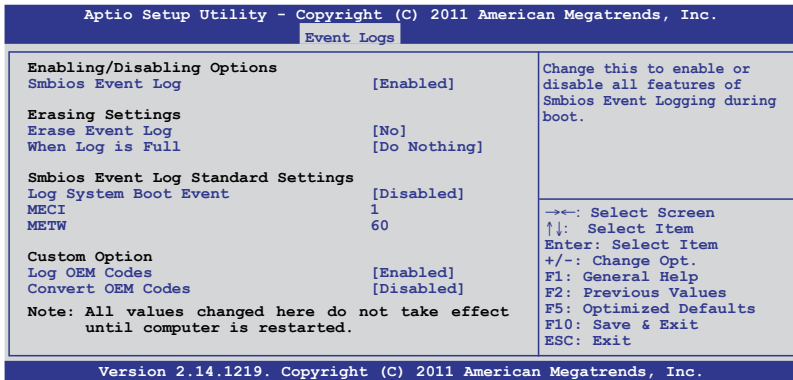

All values changed here do not take effect until computer is restarted.

Enabling/Disabling Options Smbios Event Log [Enabled]

Change this to enable or disable all features of Smbios Event Logging during boot. Configuration options: [Disabled] [Enabled]

Erasing Settings Erase Event Log [No]

Choose options for erasing Smbios Event Log. Erasing is done prior to any logging activation during reset. Configuration options: [No] [Yes, Next reset] [Yes, Every reset]

When Log is Full [Do Nothing]

Allows you to choose options for reactions to a full Smbios Event Log.
Configuration options: [Do Nothing] [Erase Immediately]

Smbios Event Log Standard Settings

Log System Boot Event [Disabled]

Allows you to choose options to enable or disable logging of System boot event.

Configuration options: [Enabled] [Disabled]

MECI [1]

Multiple Event Count Increment (MECI). The number of occurrences of a duplicate event that must pass before the multipt-event counter associated with the log entry is updated, specified as a numeric value in the range 1 to 255.

METW [60]

Multiple Event Time Windows (METW). The number of minutes which must pass between duplicate log entries which utilize a multiple-event counter. The value ranges from 0 to 99 minutes.

Custom Option

Log OEM Codes [Enabled]

Enable or disable the logging of EFI Status Codes as OEM Codes (if not already converted to legacy).

Configuration options: [Disabled] [Enabled]

Convert OEM Codes [Disabled]

Enable or disable the converting of EFI Status Codes to Standard Smbios Types (Not all may be translated).

Configuration options: [Disabled] [Enabled]

View Smbios Event Log

Press <Enter> to view all smbios event logs.

View System Event Log

Press <Enter> to view all system event logs.

5.7 Boot menu

The Boot menu items allow you to change the system boot options.

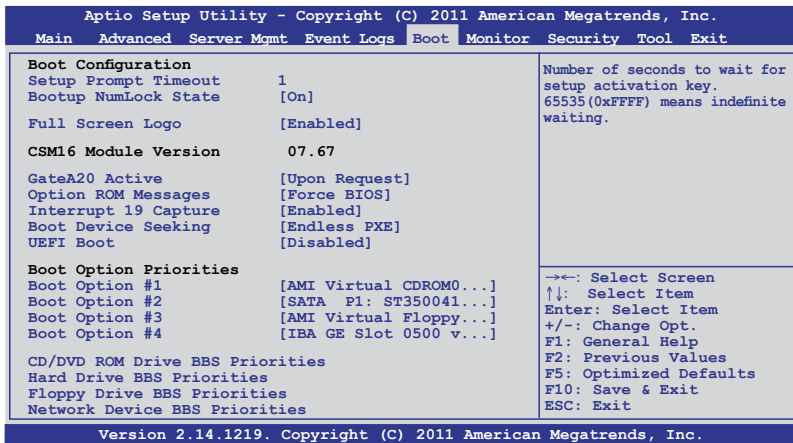

Setup Prompt Timeout [xx]

Use the <+> and <-> keys to adjust the number of seconds to wait for setup activation key.

Bootup NumLock State [On]

Allows you to select the power-on state for the NumLock.
Configuration options: [Off] [On]

Full Screen Logo [Enabled]

Allows you to enable or disable the full screen logo display feature.
Configuration options: [Disabled] [Enabled]



Set this item to [Enabled] to use the ASUS MyLogo2™ feature.

CSM16 Module Version

GateA20 Active [Upon Request]

[Upon Request] GA20 can be disabled using BIOS services.

[Always] Do not allow disable GA20; this option is useful when any RT code is executed above 1MB.

Option ROM Messages [Force BIOS]

Allows you to set the display mode for Options ROM.
Configuration options: [Force BIOS] [Keep Current]

Interrupt 19 Capture [Enabled]

Allows Option ROMs to trap interrupt 19.
Configuration options: [Disabled] [Enabled]

Boot Device Seeking [Endless PXE]

[Endless PXE] Continuous seek remote boot image until boot image found or user abort (press Ctrl+Alt+Del).

[Normal] Seek remote boot image once then stop.

UEFI Boot [Disabled]

Enables or disables UEFI Boot.

Configuration options: [Disabled] [Enabled]

Boot Option Priorities

These items specify the boot device priority sequence from the available devices. The number of device items that appears on the screen depends on the number of devices installed in the system.



-
- To select the boot device during system startup, press <F8> when ASUS Logo appears.
 - To access Windows OS in Safe Mode, please press <F8> after POST.
-

Set the booting order of network devices.

Boot Option #1/#2/#3/#4 [AMI Virtual CDROM0...]

Configuration options: [SATA P1: ST3500...] [AMI Virtual CDROM...]
[AMI Virtual Floppy...] [IBA GE Slot 0500 v...]

Hard Drive BBS Priorities

CD/DVD ROM Drive BBS Priorities

Floppy Drive BBS Priorities

Network Device BBS Priorities

These items appear only when you connect SATA ODD or hard drive to the SATA ports and allow you to set the booting order of the SATA devices.

5.8 Monitor menu

The Monitor menu displays the system temperature/power status, and allows you to change the fan settings.

Aptio Setup Utility - Copyright (C) 2011 American Megatrends, Inc.		
Main Advanced Server Mgmt Event Logs Boot Monitor Security Tool Exit		
TR Function	[Disabled]	Disable: Voltage monitor. Enabled: Temperature monitor.
CPU1 Temperature	60.0°C/140.0°F	
CPU2 Temperature	N/A	
MB Temperature	68.0°C/154.4°F	
TR1 Temperature	N/A	
TR2 Temperature	N/A	
FRNT FAN1 Speed	7031 RPM	
FRNT FAN2 Speed	3948 RPM	
FRNT FAN3 Speed	4005 RPM	
FRNT FAN4 Speed	6818 RPM	
+VTT_CPU	+1.026 V	
VCORE1	+1.010 V	
VCORE2	N/A	
+VDDQ_AB_CPU1	+1.510 V	
+VDDQ_CD_CPU1	+1.526 V	
+VDDQ_EF_CPU2	N/A	
+VDDQ_GH_CPU2	N/A	
+5VSB	+4.921 V	
+5V	+5.036 V	
+12V	+11.592 V	
+3.3V	+3.276 V	
VBAT	+3.168 V	
+3.3VSB	+3.234 V	
FAN Speed Control	[Generic Node]	
→←: Select Screen ↑↓: Select Item Enter: Select Item +/-: Change Opt. F1: General Help F2: Previous Values F5: Optimized Defaults F10: Save & Exit ESC: Exit		
Version 2.14.1219. Copyright (C) 2011 American Megatrends, Inc.		

TR Function [Disabled]

[Disabled] Voltage monitor.

[Enabled] Temperature monitor.



The **TR1/TR2 Temperature** items appears only when you set **TR Function** to [Enabled] and restart the system.

CPU 1/2; MB; TR1/TR2 Temperature [xxx°C/xxx°F]

The onboard hardware monitor automatically detects and displays the CPU and motherboard component temperatures. Select **Ignore** if you do not wish to display the detected temperatures.

FRNT FAN1–4 Speed; [xxxx RPM] or [Ignore] / [N/A]

The onboard hardware monitor automatically detects and displays the speed of CPU fans, front fans, and rear fan in rotations per minute (RPM). If the fan is not connected to the motherboard, the field shows **N/A**.

+VTT_CPU Voltage, VCORE1/2 Voltage, +VDDQ_AB_CPU1 Voltage, +VDDQ_CD_CPU1 Voltage, +VDDQ_EF_CPU2 Voltage, +VDDQ_GH_CPU2 Voltage, +5VSB Voltage, +5V Voltage, +12V Voltage, +3.3V Voltage, VBAT Voltage, +3.3VSB Voltage

The onboard hardware monitor automatically detects the voltage output through the onboard voltage regulators.

FAN Speed Control [Generic Mode]

Allows you to configure the ASUS Smart Fan feature that smartly adjusts the fan speeds for more efficient system operation.

Configuration options: [Generic Mode] [High Speed Mode] [Full Speed Mode]

5.9 Security menu

The Security menu items allow you to change the system security settings.

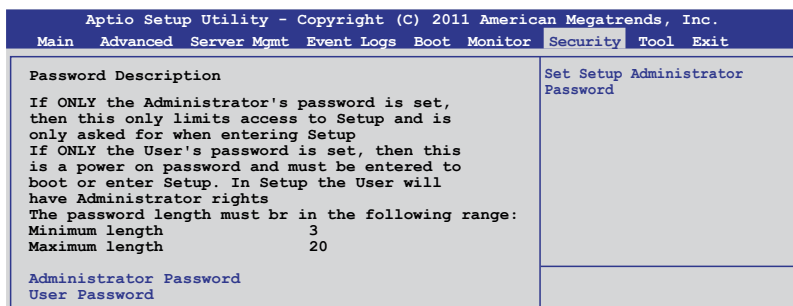

- If you have forgotten your BIOS password, erase the CMOS Real Time Clock (RTC) RAM to clear the BIOS password. See section **2.6 Jumpers** for information on how to erase the RTC RAM.
- The **Administrator** or **User Password** items on top of the screen show the default **Not Installed**. After you set a password, these items show **Installed**.

Administrator Password

If you have set an administrator password, we recommend that you enter the administrator password for accessing the system. Otherwise, you might be able to see or change only selected fields in the BIOS setup program.

To set an administrator password:

1. Select the **Administrator Password** item and press <Enter>.
2. From the **Create New Password** box, key in a password, then press <Enter>.
3. Confirm the password when prompted.

To change an administrator password:

1. Select the **Administrator Password** item and press <Enter>.
2. From the **Enter Current Password** box, key in the current password, then press <Enter>.
3. From the **Create New Password** box, key in a new password, then press <Enter>.
4. Confirm the password when prompted.

To clear the administrator password, follow the same steps as in changing an administrator password, but press <Enter> when prompted to create/confirm the password. After you clear the password, the **Administrator Password** item on top of the screen shows **Not Installed**.

User Password

If you have set a user password, you must enter the user password for accessing the system. The **User Password** item on top of the screen shows the default **Not Installed**. After you set a password, this item shows **Installed**.

To set a user password:

1. Select the **User Password** item and press <Enter>.
2. From the **Create New Password** box, key in a password, then press <Enter>.
3. Confirm the password when prompted.

To change a user password:

1. Select the **User Password** item and press <Enter>.
2. From the **Enter Current Password** box, key in the current password, then press <Enter>.
3. From the **Create New Password** box, key in a new password, then press <Enter>.
4. Confirm the password when prompted.

To clear the user password, follow the same steps as in changing a user password, but press <Enter> when prompted to create/confirm the password. After you clear the password, the **User Password** item on top of the screen shows **Not Installed**.

5.10 Tool menu

The Tool menu items allow you to configure options for special functions. Select an item then press <Enter> to display the submenu.

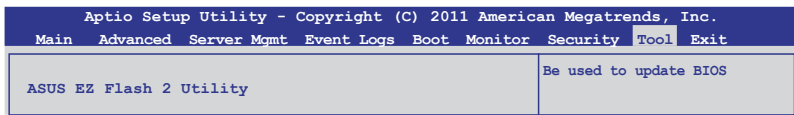

ASUS EZ Flash 2 Utility

Allows you to run ASUS EZ Flash BIOS ROM Utility when you press <Enter>. Check section **5.1.2 ASUS EZ Flash 2 Utility** for details.

5.11 Exit menu

The Exit menu items allow you to save or discard your changes to the BIOS items.

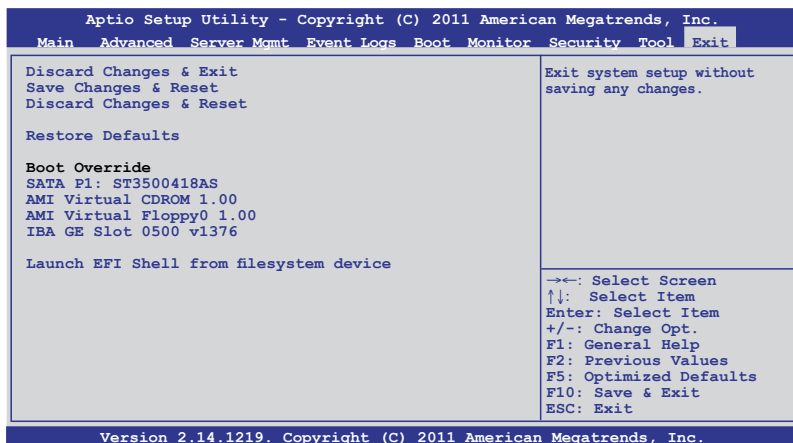

Pressing <Esc> does not immediately exit this menu. Select one of the options from this menu or <F10> from the legend bar to exit.

Discard Changes & Exit

This option allows you to exit the Setup program without saving your changes. When you select this option or if you press <Esc>, a confirmation window appears. Select **Yes** to discard changes and exit.

Save Changes & Reset

Once you are finished making your selections, choose this option from the Exit menu to ensure the values you selected are saved. When you select this option or if you press <F10>, a confirmation window appears. Select **Yes** to save changes and exit.

Discard Changes & Reset

This option allows you to reset the Setup program without saving your changes. When you select this option, a confirmation window appears. Select **Yes** to discard changes and reset.

Restore Defaults

This option allows you to restore/load defaults values for all the setup options. When you select this option, a confirmation window appears. Select **Yes** to load optimized defaults.

Boot Override

These items displays the available devices. The device items that appears on the screen depends on the number of devices installed in the system. Click an item to start booting from the selected device.

Launch EFI Shell from filesystem device

Attempts to launch EFI Shell application (shellx64.efi) from one of the available filesystem devices.

Chapter 6

This chapter provides instructions for setting up, creating and configuring RAID sets using the available utilities.

RAID configuration

6.1 Setting up RAID

The motherboard supports the following SATA RAID solutions:

- **LSI MegaRAID software RAID Configuration Utility** with RAID 0, RAID 1, and RAID 10 support (for both Linux and Windows OS).
- **Intel Rapid Storage Technology enterprise SCU / SATA Option ROM Utility** with RAID 0, RAID 1, RAID 10, and RAID 5 support (for Windows OS only).

6.1.1 RAID definitions

RAID 0 (*Data striping*) optimizes two identical hard disk drives to read and write data in parallel, interleaved stacks. Two hard disks perform the same work as a single drive but at a sustained data transfer rate, double that of a single disk alone, thus improving data access and storage. Use of two new identical hard disk drives is required for this setup.

RAID 1 (*Data mirroring*) copies and maintains an identical image of data from one drive to a second drive. If one drive fails, the disk array management software directs all applications to the surviving drive as it contains a complete copy of the data in the other drive. This RAID configuration provides data protection and increases fault tolerance to the entire system. Use two new drives or use an existing drive and a new drive for this setup. The new drive must be of the same size or larger than the existing drive.

RAID 1E (*Enhanced RAID 1*) has a striped layout with each stripe unit having a secondary (or alternate) copy stored on a different disk. You can use three or more hard disk drives for this configuration.

RAID 10 is data striping and data mirroring combined without parity (redundancy data) having to be calculated and written. With the RAID 10 configuration you get all the benefits of both RAID 0 and RAID 1 configurations. Use four new hard disk drives or use an existing drive and three new drives for this setup.

RAID 5 stripes both data and parity information across three or more hard disk drives. Among the advantages of RAID 5 configuration include better HDD performance, fault tolerance, and higher storage capacity. The RAID 5 configuration is best suited for transaction processing, relational database applications, enterprise resource planning, and other business systems. Use a minimum of three identical hard disk drives for this setup.



-
- If you want to boot the system from a hard disk drive included in a created RAID set, copy first the RAID driver from the support DVD to a floppy disk before you install an operating system to the selected hard disk drive.
 - Please refer to chapter 2 for how to select the RAID configuration utility. Move the jumper to choose between LSI MegaRAID and Intel® Rapid RAID.
-

6.1.2 Installing hard disk drives

The motherboard supports Serial ATA for RAID set configuration. For optimal performance, install identical drives of the same model and capacity when creating a disk array.

To install the SATA hard disks for RAID configuration:

1. Install the SATA hard disks into the drive bays following the instructions in the system user guide.
2. Connect a SATA signal cable to the signal connector at the back of each drive and to the SATA connector on the motherboard.
3. Connect a SATA power cable to the power connector on each drive.

6.1.3 Setting the RAID item in BIOS

You must set the RAID item in the BIOS Setup before you can create a RAID set from SATA hard disk drives attached to the SATA connectors supported by Intel® C602 chipset. To do this:

1. Enter the BIOS Setup during POST.
2. Go to the **Advanced** Menu > **PCH SATA Configuration**, then press <Enter>.
3. Set **SATA Mode** to [RAID Mode]
4. Press <F10> to save your changes and exit the BIOS Setup.



Refer to Chapter 4 for details on entering and navigating through the BIOS Setup.

6.1.4 RAID configuration utilities

Depending on the RAID connectors that you use, you can create a RAID set using the utilities embedded in each RAID controller. For example, use the **LSI Logic Embedded SATA RAID Setup Utility** or the **Intel® Rapid Storage Technology** if you installed Serial ATA hard disk drives on the Serial ATA connectors supported by the Intel® C602 chipset.

Refer to the succeeding section for details on how to use the RAID configuration utility.

6.2 LSI Software RAID Configuration Utility

The LSI MegaRAID software RAID configuration utility allows you to create RAID 0, RAID 1, or RAID 10 set(s) from SATA hard disk drives connected to the SATA connectors supported by the motherboard southbridge chip.

To enter the LSI MegaRAID software RAID configuration utility:

1. Turn on the system after installing all the SATA hard disk drives.
2. During POST, the LSI MegaRAID software RAID configuration utility automatically detects the installed SATA hard disk drives and displays any existing RAID set(s). Press <Ctrl> + <M> to enter the utility.

```
LSI MegaRAID Software RAID BIOS Version A.10 09231523R
LSI SATA RAID Found at PCI Bus No.00 Dev No.1F
Device present at Port 0      ST3160812AS      152114MB
Device present at Port 1      ST3160812AS      152114MB
Device present at Port 2      ST3160812AS      152114MB
Device present at Port 3      ST3160812AS      152114MB
Press Ctrl-M or Enter to run LSI Software RAID Setup Utility.
```



- The LSI MegaRAID software RAID configuration utility automatically configures to RAID 1 when the SATA to RAID Mode is enabled.
- The RAID setup screens shown in this section are for reference only and may not exactly match the items on your screen due to the controller version difference.
- When you create RAID sets with the LSI MegaRAID software RAID configuration utility, the boot priority of the SATA optical drive has to be manually adjusted. Otherwise, the system will not boot from the connected SATA ODD.

3. The utility main window appears. Use the arrow keys to select an option from the **Management Menu** and then press <Enter>. Refer to the Management Menu descriptions on the next page.

At the bottom of the screen is the legend box. The keys on the legend box allow you to navigate through the setup menu options or execute commands. The keys on the legend box vary according to the menu level.

```
LSI Software RAID Configuration Utility Ver C.05 Sep 17, 2010
BIOS Version A.10.09231523R

Management Menu
Configure
Initialize
Objects
Rebuild
Check Consistency

Configure VD(s)

Use Cursor Keys to Navigate Between Items And Press Enter To Select An Option
```

Menu	Description
Configure	Allows you to create RAID 0, RAID 1 or RAID 10 set using the Easy Configuration or the New Configuration command. This menu also allows you to view, add, or clear RAID configurations or select the boot drive
Initialize	Allows you to initialize the virtual drives of a created RAID set
Objects	Allows you to initialize virtual drives or change the virtual drive parameters
Rebuild	Allows you to rebuild failed drives
Check Consistency	Allows you to check the data consistency of the virtual drives of a created RAID set

6.2.1 Creating a RAID set

The LSI Software RAID Configuration Utility allows you to create a RAID 0, RAID 1, or RAID 10 set using two types of configurations: **Easy** and **New**.

In **Easy Configuration**, the virtual drive parameters are set automatically.

In **New Configuration**, you manually set the virtual drive parameters.

Using Easy Configuration

To create a RAID set using the **Easy Configuration** option:

1. From the **Management Menu**, select **Configure > Easy Configuration**, and then press <Enter>.

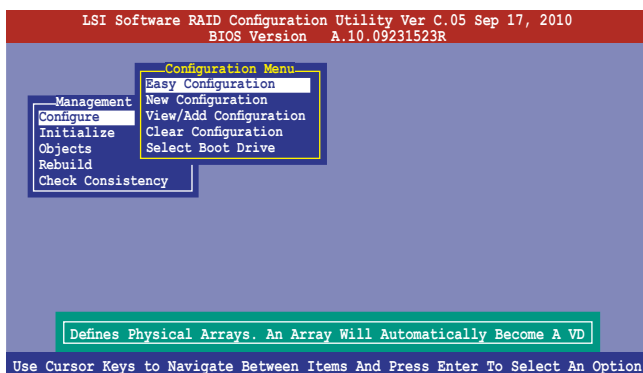

- The **ARRAY SELECTION MENU** displays the available drives connected to the SATA ports. Use the up/down arrow keys to select the drives you want to include in the RAID set, and then press <Space>. When selected, the drive indicator changes from **READY** to **ONLIN A[X]-[Y]**, where X is the array number, and Y is the drive number.

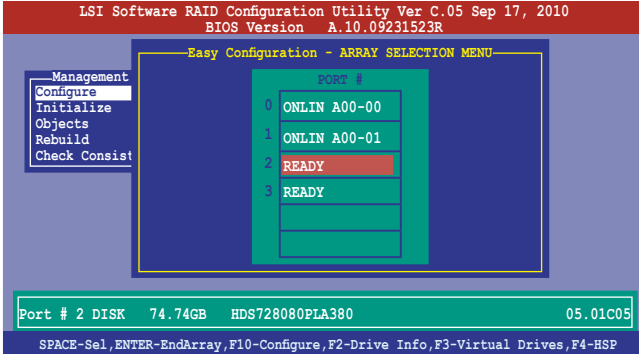

- The information of the selected hard disk drive displays at the bottom of the screen.
- You need at least two identical hard disk drives when creating a RAID 1 set.
- You need at least four identical hard disk drives when creating a RAID 10 set.

- Select all the drives required for the RAID set, and then press <F10> to configure array setting.
- Press <Space> to select the configurable array.

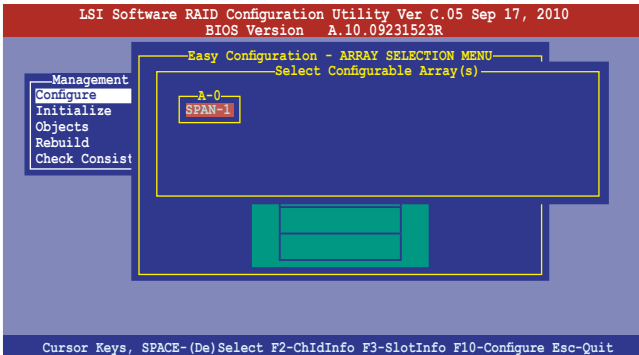

- Press <F10> again, the virtual drive information appears including a **Virtual Drive** menu that allows you to change the virtual drive parameters.

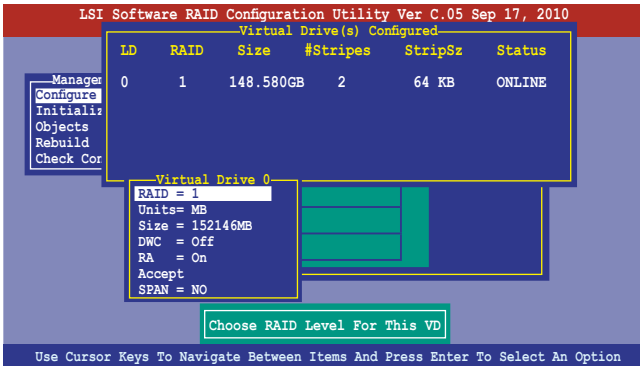

- Select **RAID** from the **Virtual Drive** sub-menu, and then press <Enter>.
- Select the **RAID level** from the menu, and then press <Enter>.

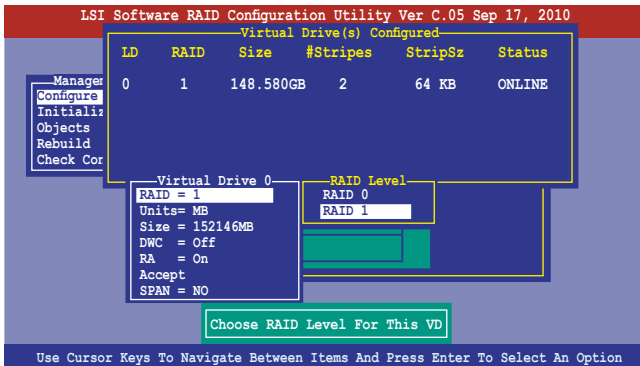

8. Select **Units** from the **Virtual Drive** sub-menu, and then press <Enter>.
9. Select the units for virtual drive size from the menu, and then press <Enter>.

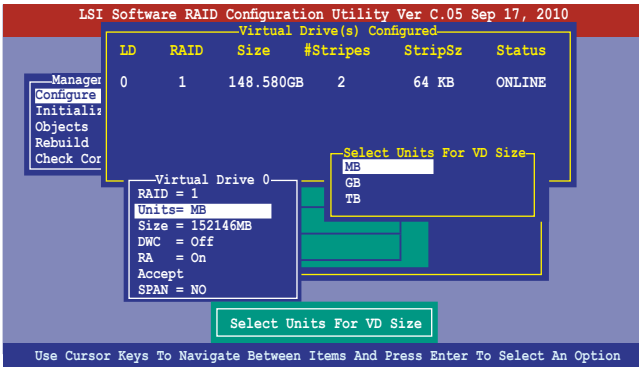

10. When creating a **RAID 1** or a **RAID 10** set, select **DWC** from the **Virtual Drive** menu, and then press <Enter>.
- When creating a **RAID 0** set, proceed to step 12.
11. Select **On** to enable the **Disk Write Cache** setting, and then press <Enter>.

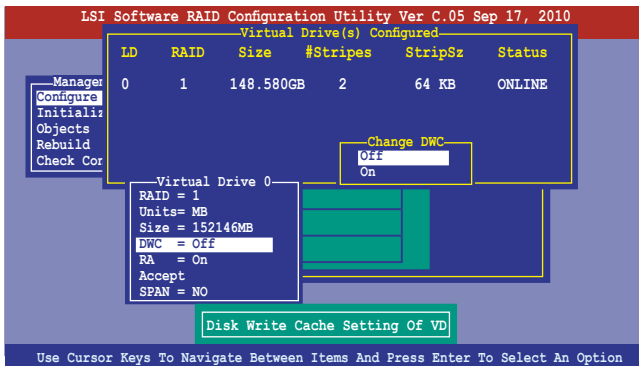

Enabling DWC can improve the performance, but with the risk of data loss.

12. When finished setting the selected virtual drive configuration, select **Accept** from the menu, and then press <Enter>.

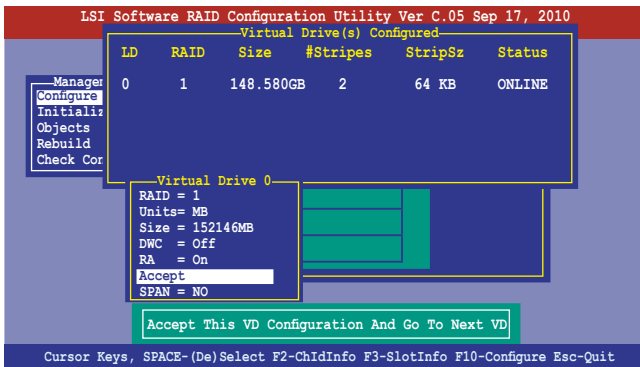

13. Follow step 2 to 12 to configure additional virtual drives.
14. Press <Esc> to finish RAID configuration. When prompted to save configuration, select **Yes** from the menu, and then press <Enter>.

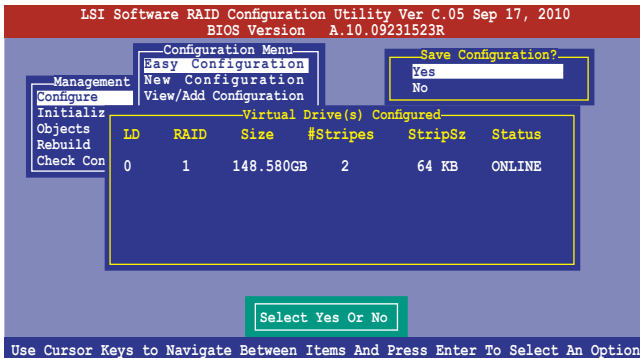

Using New Configuration



When a RAID set already exists, using the **New Configuration** command erases the existing RAID configuration data. If you do not want to delete the existing RAID set, use the **View/Add Configuration** command to view or create another RAID configuration.

To create a RAID set using the **New Configuration** option

1. From the **Management Menu**, select **Configure > New Configuration**, and then press <Enter>.

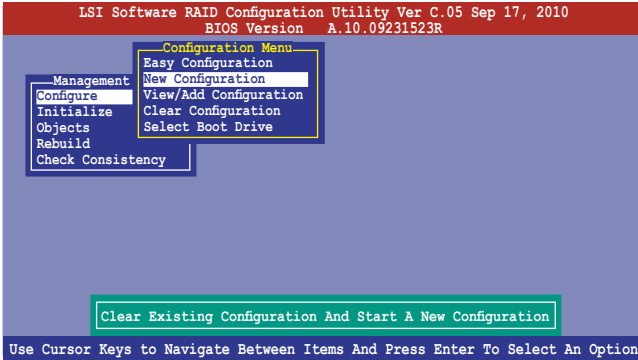

2. Follow step 2 to 9 of the previous section: **Using Easy Configuration**.
3. Select **Size** from the **Virtual Drive** menu, and then press <Enter>.
4. Key-in the desired virtual drive size, and then press <Enter>.

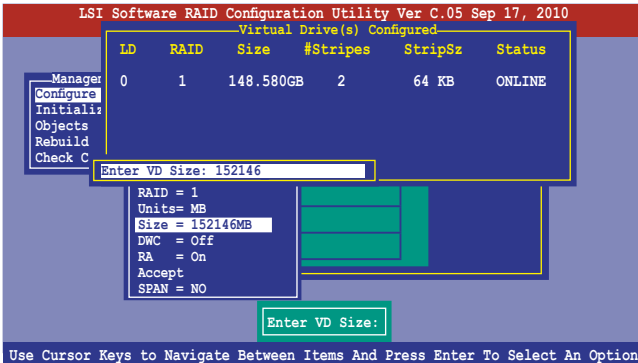

5. Follow step 10 to 14 of the previous section: **Using Easy Configuration** to create the RAID set.

6.2.2 Adding or viewing a RAID configuration

You can add a new RAID configuration or view an existing configuration using the **View/Add Configuration** command.

Adding a new RAID configuration

To add a new RAID configuration:

1. From the **Management Menu**, select **Configure > View/Add Configuration**, and then press <Enter>.

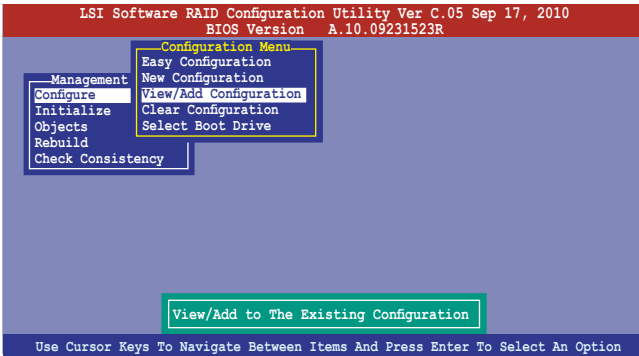

2. The **ARRAY SELECTION MENU** displays the available drives connected to the SATA ports. Select the drive(s) you want to include in the RAID set, then press <Space>. When selected, the drive indicator changes from **READY** to **ONLIN A[X]-[Y]**, where X is the array number, and Y is the drive number.

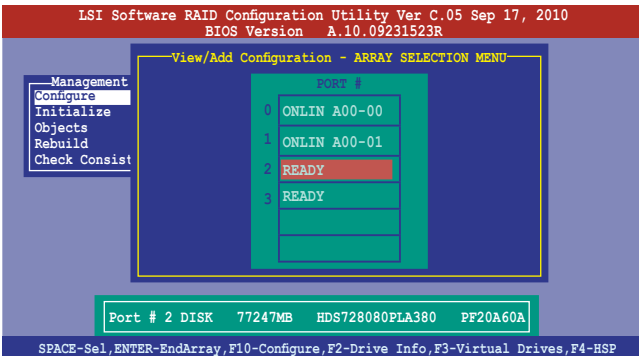

The information of the selected hard disk drive displays at the bottom of the screen.

3. Follow step 3 to 12 of section **6.2.1 Creating a RAID set: Using Easy Configuration** to add a new RAID set.

6.2.3 Initializing the virtual drives

After creating the RAID set(s), you must initialize the virtual drives. You may initialize the virtual drives of a RAID set(s) using the **Initialize** or **Objects** command on the **Management Menu**.

Using the Initialize command

To initialize the virtual drive using the Initialize command

1. From the **Management Menu**, select **Initialize**, and then press <Enter>.

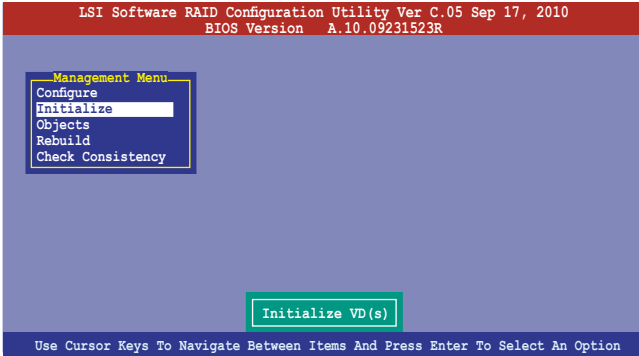

2. The screen displays the available RAID set(s) and prompts you to select the virtual drive to initialize. Use the arrow keys to select the virtual drive from the **Virtual Drive** selection, and then press <Space>.

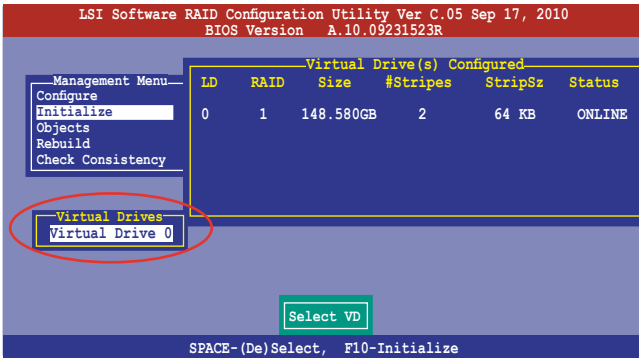

3. Press <F10> to start initialization. When prompted, select **Yes** from the **Initialize?** dialog box, and then press <Enter>.

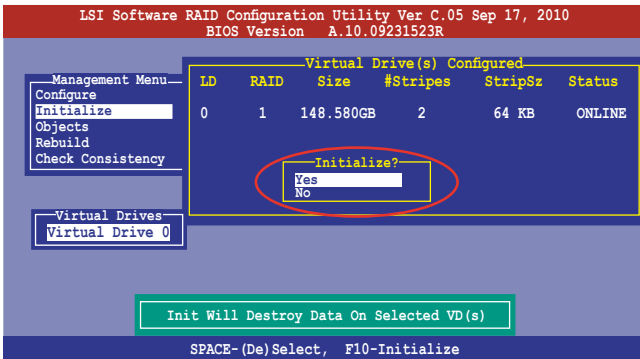

Initializing a virtual drive erases all data on the drive.

4. A progress bar appears on screen. If desired, press <Esc> to abort initialization. When initialization is completed, press <Esc>.

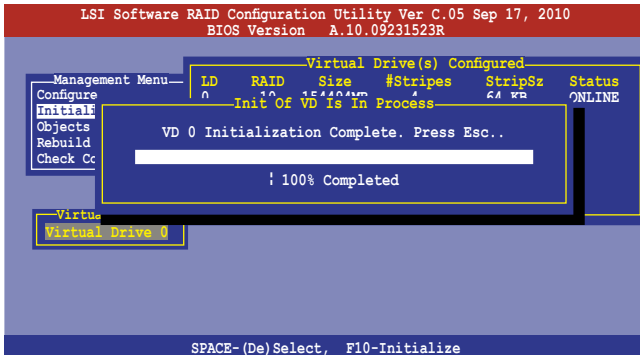

Using the Objects command

To initialize the virtual drives using the **Objects** command

1. From the **Management Menu**, select **Objects > Virtual Drive**, and then press <Enter>.

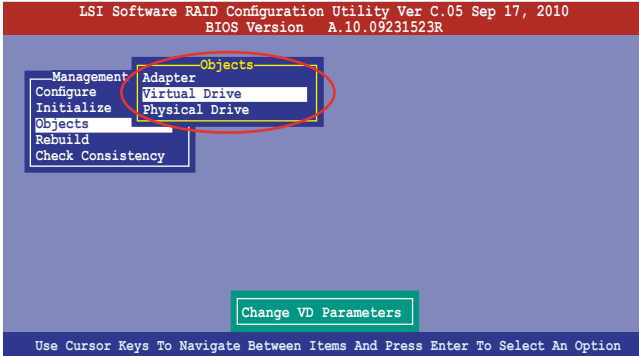

2. Select the virtual drive to initialize from the **Virtual Drives** sub-menu, and then press <Enter>.

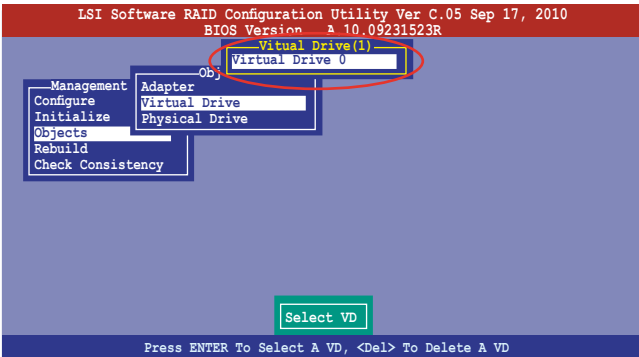

3. Select **Initialize** from the pop-up menu, and then press <Enter> to start initialization.

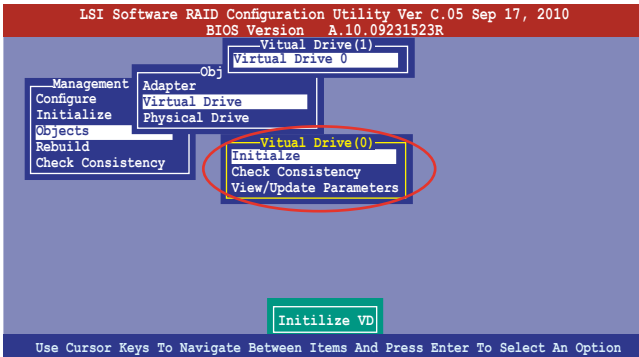

4. When prompted, press the <Space> to select **Yes** from the **Initialize?** dialog box, and then press <Enter>.

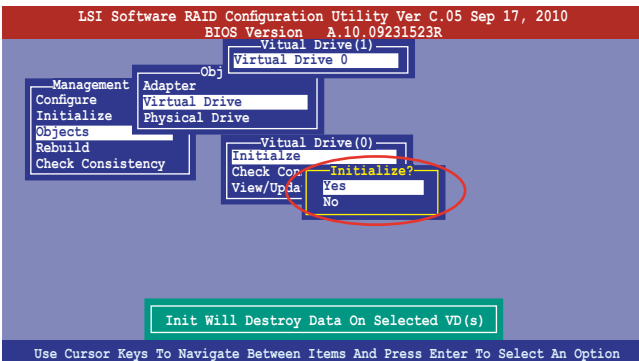

5. A progress bar appears on screen. If desired, press <Esc> to abort initialization. When initialization is completed, press <Esc>.

6.2.4 Rebuilding failed drives

You can manually rebuild failed hard disk drives using the **Rebuild** command in the **Management Menu**.

To rebuild a failed hard disk drive

1. From the **Management Menu**, select **Rebuild**, and then press <Enter>.

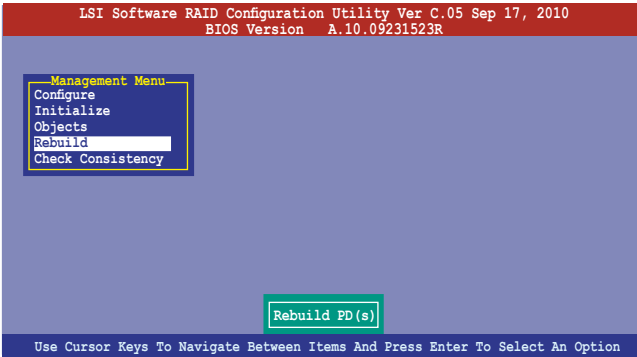

2. The **PHYSICAL DRIVES SELECTION MENU** displays the available drives connected to the SATA ports. Select the drive you want to rebuild, and then press <Space>.

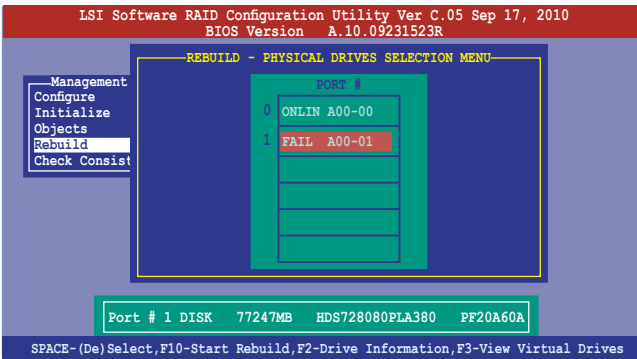

3. After selecting the drive to rebuild, press <F10>. When prompted, press <Y> to rebuild the drive.

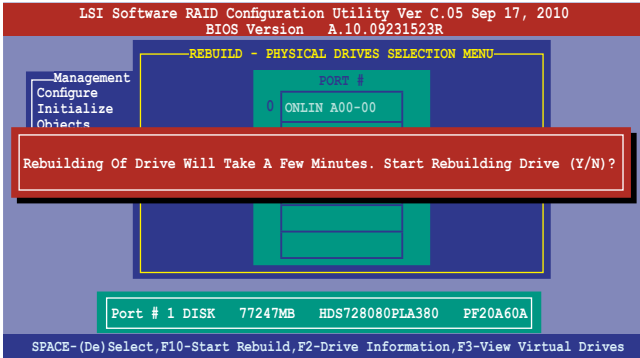

4. When rebuild is complete, press any key to continue.

6.2.5 Checking the drives for data consistency

You can check and verify the accuracy of data redundancy in the selected virtual drive. The utility can automatically detect and/or detect and correct any differences in data redundancy depending on the selected option in the **Objects > Adapter** menu.



The **Check Consistency** command is available only for virtual drives included in a RAID 1 or RAID 10 set.

Using the Check Consistency Command

To check data consistency using the **Check Consistency** command

1. From the **Management Menu**, select **Check Consistency**, and then press <Enter>.

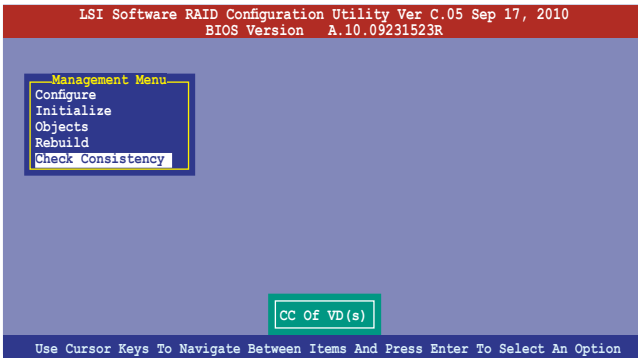

2. The screen displays the available RAID set(s) and prompts you to select the virtual drive to check. Press <Space> to select the virtual drive from the **Virtual Drive** sub-menu, and then press <F10>.

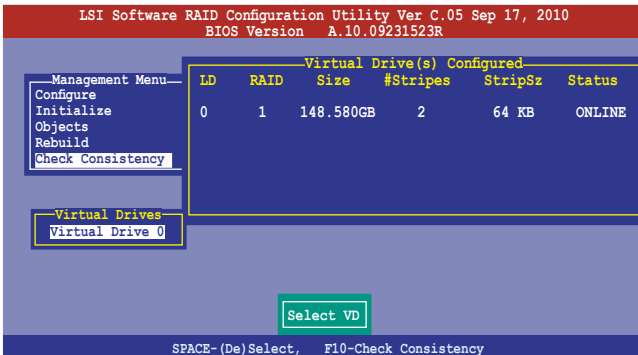

3. When prompted, use the arrow keys to select **Yes** from the **Consistency Check?** dialog box, and then press <Enter>.

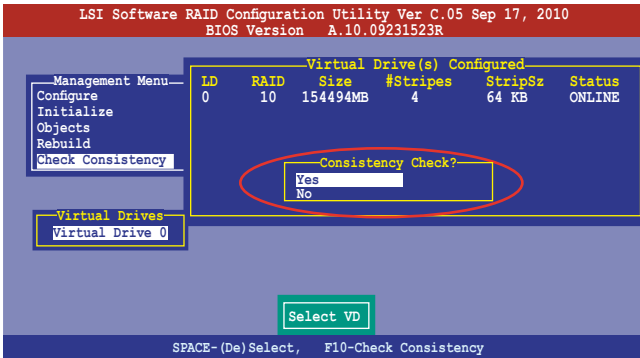

A progress bar appears on screen.

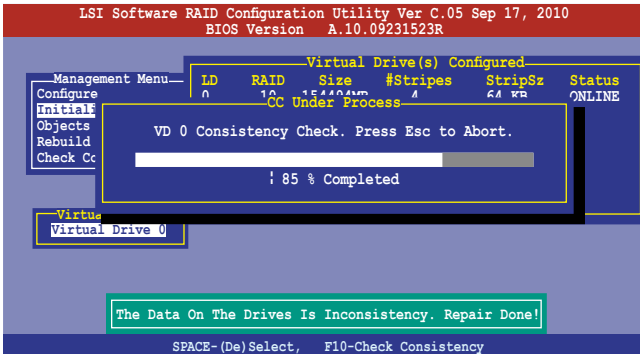

4. While checking the disk consistency, press <Esc> to display the following options.
- **Stop** - Stops the consistency check. The utility stores the percentage of disk checked, and when you restart checking, it continues from the last percentage completed rather than from zero percent.
 - **Continue** - Continues the consistency check.
 - **Abort** - Aborts the consistency check. When you restart checking, it continues from zero percent.
5. When checking is complete, press any key to continue.

Using the Objects command

To check data consistency using the **Objects** command

1. From the **Management Menu**, select **Objects**, and then select **Virtual Drive** from the sub-menu.
2. Use the arrow keys to select the virtual drive you want to check, and then press <Enter>.
3. Select **Check Consistency** from the pop-up menu, and then press <Enter>.
4. When prompted, use the arrow keys to select **Yes** from the dialog box to check the drive.
5. When checking is complete, press any key to continue.

6.2.6 Deleting a RAID configuration

To delete a RAID configuration

1. From the **Management Menu**, select **Configure > Clear Configuration**, and then press <Enter>.

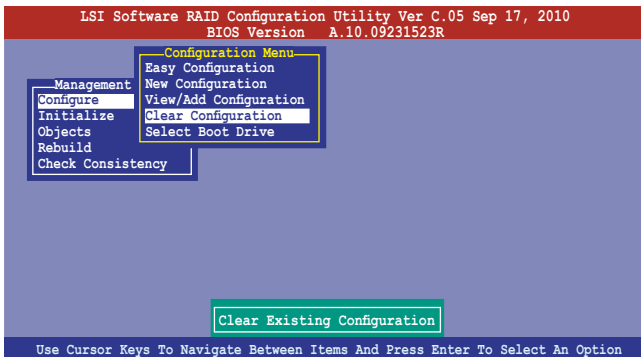

2. When prompted, use the arrow keys to select **Yes** from the **Clear Configuration?** dialog box, and then press <Enter>.

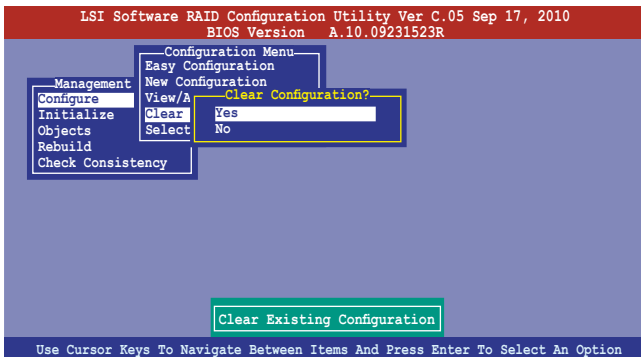

The utility clears all the current array(s).

3. Press any key to continue.

6.2.7 Selecting the boot drive from a RAID set

You must have created a new RAID configuration before you can select the boot drive from a RAID set. See section 5.2.1 **Creating a RAID set: Using New Configuration** for details.

To select the boot drive from a RAID set

1. From the **Management Menu**, select **Configure > Select Boot Drive**, and then press <Enter>.

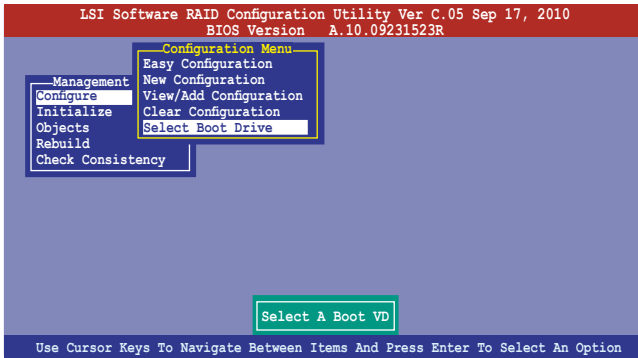

2. When prompted, use the arrow keys to select the bootable virtual drive from the list, then press <Enter>.

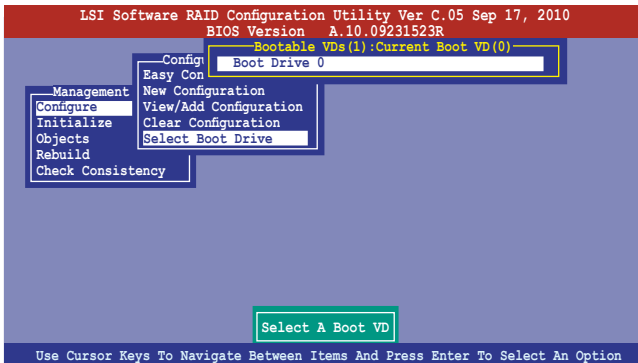

3. The virtual drive is selected as boot drive. Press any key to continue.

6.2.8 Enabling WriteCache

You may manually enable the RAID controller's WriteCache option after creating a RAID set to improve the data transmission performance.



When you enable WriteCache, you may lose data when a power interruption occurs while transmitting or exchanging data among the drives.



The WriteCache function is recommended for RAID 1 and RAID 10 sets.

To enable WriteCache

1. From the **Management Menu**, select **Objects > Adapter**, select an existing adapter, and then press <Enter> to display the adapter properties.
2. Select **Disk WC**, and then press <Enter> to turn on the option.

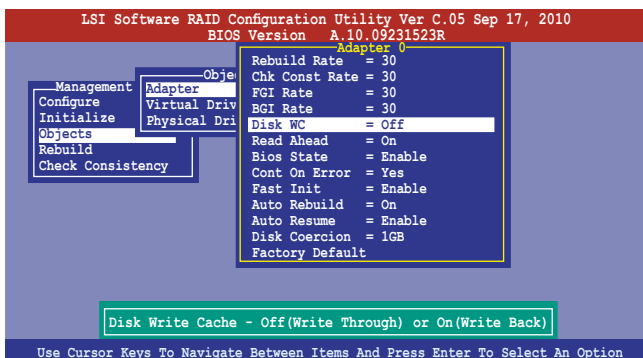

3. From the **Management Menu**, select **Objects > Virtual Drive**, select an existing adapter and press <Enter>. Select **View/Update Parameters** and press <Enter> to display the adapter properties.
4. Select **Disk WC**, and then press <Enter> to turn on the option.

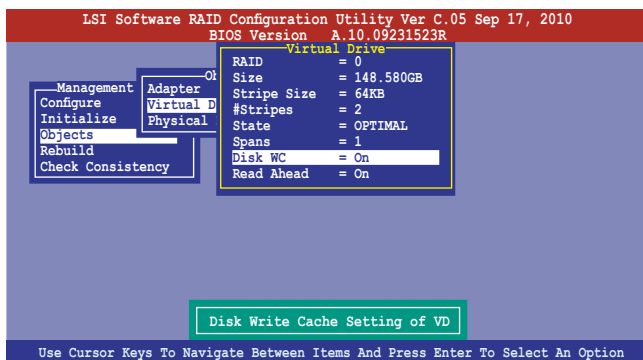

5. When finished, press any key to continue.

6.3 Intel® Rapid Storage Technology enterprise SCU/SATA Option ROM Utility

The Intel® Rapid Storage Technology enterprise SCU / SATA Option ROM utility allows you to create RAID 0, RAID 1, RAID 10 (RAID 1+0), and RAID 5 set(s) from Serial ATA hard disk drives that are connected to the Serial ATA connectors supported by the Southbridge.

You can create RAID mode by use of onboard AHCI SATA ports.

To use onboard SATA ports:

1. Install all the Serial ATA hard disk drives.
2. Turning on the system. During POST, press,Del. to enter BIOS. Go to **Advanced Menu > PCH SATA Configuration > SATA Mode**, then press <Enter>.
3. Set **SATA Mode** to **RAID Mode** and save, then reboot system.
4. During POST, press <Ctrl+I> to display the utility main menu.

To use SCU SATA ports:

1. Install all the hard disk drives.
2. Turn on the system.
3. Confirm all the SATA hard disk drives you installed are correctly displayed, then reboot system.
4. During POST, press <Ctrl+I> to display the utility main menu.

To enter the Intel® Rapid Storage Technology enterprise SCU option ROM utility:

1. Install all the Serial ATA hard disk drives.
2. Turn on the system.
3. During POST, press <Ctrl+I> to display the utility main menu.

```
Intel(R) Rapid Storage Technology enterprise - SCU Option ROM - 3.0.0.1104
Copyright(C) 2003-11 Intel Corporation. All Rights Reserved.

[ MAIN MENU ]
1. Create RAID Volume
2. Delete RAID Volumes
3. Reset Disks to Non-RAID
4. Exit

[ DISK/VOLUME INFORMATION ]

RAID Volumes:
None defined.

Physical Disks:
ID Drive Model Serial # Size Type/Status (Vol ID)
0 ST3300656SS HWAS0000991753TR 279.3GB Non-RAID Disk
1 ST3300656SS 37VN00009846RAJ1 279.3GB Non-RAID Disk
2 ST3300656SS 397600009846UEDY 279.3GB Non-RAID Disk
3 ST3300656SS GWC50000991756G6 279.3GB Non-RAID Disk

[↑↓]-Select [ESC]-Exit [ENTER]-Select Menu
```

The navigation keys at the bottom of the screen allow you to move through the menus and select the menu options.



The RAID BIOS setup screens shown in this section are for reference only and may not exactly match the items on your screen.



The utility supports maximum four hard disk drives for RAID configuration.

6.3.1 Creating a RAID set

To create a RAID set

1. From the utility main menu, select **1. Create RAID Volume** and press <Enter>. The following screen appears.

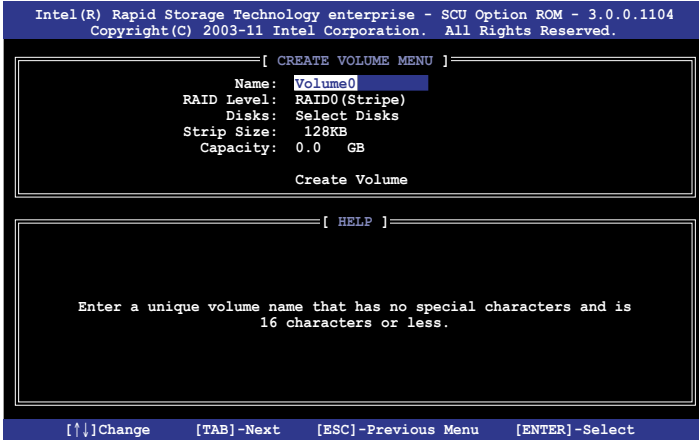

2. Enter a name for the RAID set and press <Enter>.
3. When the **RAID Level** item is selected, press the up/down arrow key to select a RAID level to create, and then press <Enter>.
4. When the **Disks** item is selected, press <Enter> to select the hard disk drives you want to include in the RAID set. The **SELECT DISKS** screen appears.

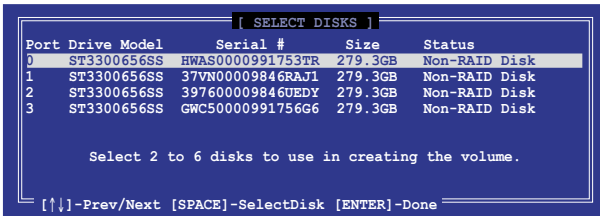

5. Use the up/down arrow key to select a drive, and then press <Space> to select. A small triangle marks the selected drive. Press <Enter> after completing your selection.

- Use the up/down arrow keys to select the stripe size for the RAID array (for RAID 0, 10 and 5 only), and then press <Enter>. The available stripe size values range from 4 KB to 128 KB. The following are typical values:
RAID 0: 128KB
RAID 10: 64KB
RAID 5: 64KB



We recommend a lower stripe size for server systems, and a higher stripe size for multimedia computer systems used mainly for audio and video editing.

- When the **Capacity** item is selected, enter the RAID volume capacity that you want and press <Enter>. The default value indicates the maximum allowed capacity.
- When the **Create Volume** item is selected, press <Enter>. The following warning message appears.



- Press <Y> to create the RAID volume and return to the main menu, or <N> to go back to the **CREATE VOLUME** menu.

6.3.2 Creating a Recovery set

To create a recovery set:

- From the utility main menu, select **1. Create RAID Volume** and press <Enter>. The following screen appears.

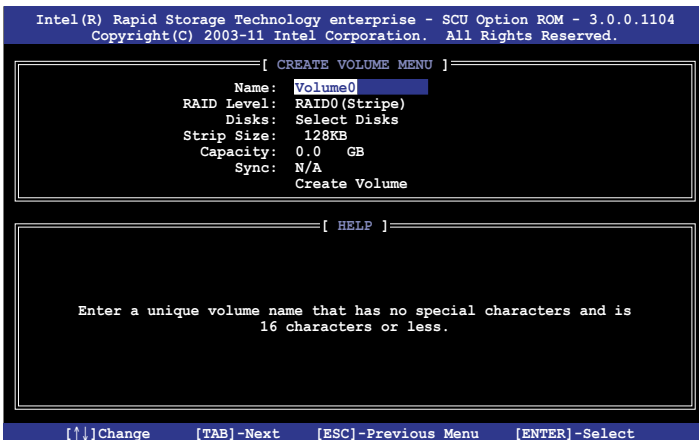

2. Enter a name for the recovery set and press <Enter>.
3. When the **RAID Level** item is selected, press the up/down arrow keys to select **Recovery**, and then press <Enter>.
4. When the **Disks** item is selected, press <Enter> to select the hard disk drives you want to include in the recovery set. The **SELECT DISKS** screen appears.

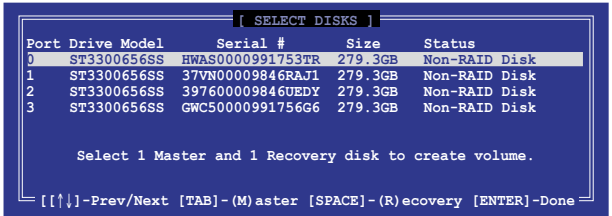

5. Use the up/down arrow keys to select a drive, press <TAB> to select a Master disk, and then press <SPACE> to select a Recovery disk. A small triangle marks the selected drive. Press <Enter> after completing your selection.
6. When the **Sync** item is selected, use the up/down arrow keys to select a sync option that you want and press <Enter>.
7. When the **Create Volume** item is selected, press <Enter>. The following warning message appears.



8. Press <Y> to create the recovery set and return to the main menu, or <N> to go back to the **CREATE VOLUME** menu.



If a recovery set is created, you cannot add more RAID sets even when you have more non-RAID disks installed in your system.

6.3.3 Deleting a RAID set



Take caution when deleting a RAID set. You will lose all data on the hard disk drives when you delete a RAID set.

To delete a RAID set:

1. From the utility main menu, select **2. Delete RAID Volume** and press <Enter>. The following screen appears.

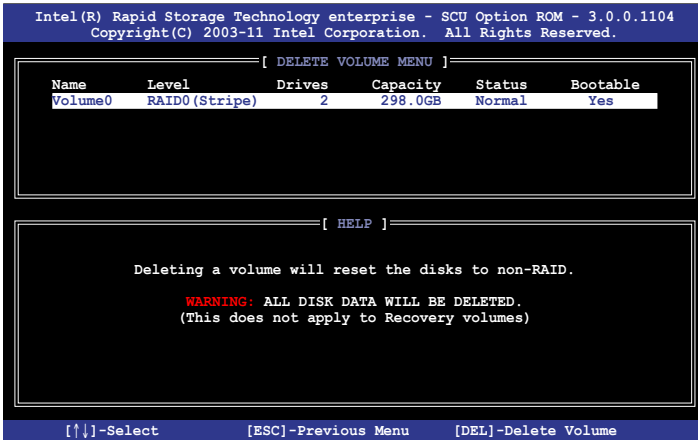

2. Use the up/down arrow keys to select the RAID set you want to delete, and then press . The following warning message appears.



3. Press <Y> to delete the RAID set and return to the utility main menu, or press <N> to return to the **DELETE VOLUME** menu.

6.3.4 Resetting disks to Non-RAID



Take caution before you reset a RAID volume hard disk drive to non-RAID. Resetting a RAID volume hard disk drive deletes all internal RAID structure on the drive.

To reset a RAID set hard disk drive:

1. From the utility main menu, select **3. Reset Disks to Non-RAID** and press <Enter>. The following screen appears.

```
[ RESET RAID DATA ]
Resetting RAID disk will remove its RAID structures
and revert it to a non-RAID disk.
WARNING: Resetting a disk causes all data on the disk to be lost.
(This does not apply to Recovery volumes)
Port Drive Model      Serial #      Size  Status
0  ST3300656SS  HWA0000991753TR  279.3GB  Member Disk
1  ST3300656SS  37VN00009846RAJ1  279.3GB  Member Disk
Select the disks that should be reset.
[Left/Right]-Previous/Next [SPACE]-Selects [ENTER]-Selection Complete
```

2. Use the up/down arrow keys to select the RAID set drive(s) you want to reset, and then press <Space> to select.
3. Press <Enter> to reset the RAID set drive(s). A confirmation message appears.
4. Press <Y> to reset the drive(s) or press <N> to return to the utility main menu.

6.3.5 Exiting the Intel® Rapid Storage Technology utility

To exit the utility:

1. From the utility main menu, select **4. Exit**, and then press <Enter>. The following warning message appears.

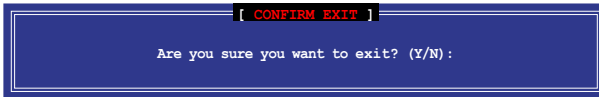

2. Press <Y> to exit or press <N> to return to the utility main menu.

6.3.6 Rebuilding the RAID



This option is only for the RAID 1 set.

Rebuilding the RAID with other non-RAID disk

If any of the SATA hard disk drives included in the RAID 1 array failed, the system displays the status of the RAID volume as **"Degraded"** during POST. You can rebuild the RAID array with other installed non-RAID disks.

To rebuild the RAID with other non-RAID disk:

1. At the prompt, press <Ctrl> + <I> to enter the Intel Rapid Storage Technology option ROM utility.
2. If there is a non-RAID SATA Hard Disk available, the utility will prompt to rebuild the RAID. Press <Enter>, and then use up/down arrow keys to select the destination disk or press <ESC> to exit.



Select a destination disk with the same size as the original hard disk.

- The utility immediately starts rebuilding after the disk is selected. The status of the degraded RAID volume is changed to **“Rebuild”**.

```

Intel(R) Rapid Storage Technology enterprise - SCU Option ROM - 3.0.0.1104
Copyright(C) 2003-11 Intel Corporation. All Rights Reserved.

----- [ MAIN MENU ] -----
1. Create RAID Volume          3. Reset Disks to Non-RAID
2. Delete RAID Volume        4. Exit

----- [ DISK/VOLUME INFORMATION ] -----

RAID Volumes:
ID  Name      Level      Strip      Size      Status      Bootable
0   Volume0   RAID1(Mirror)  N/A      149.0GB   Rebuild     Yes

Physical Devices:
Port Drive Model      Serial #      Size      Type/Status(Vol ID)
1   ST3160812AS        9LS0F4HL     149.0GB   Member Disk(0)
2   ST3160812AS        3LS0JYL8     149.0GB   Member Disk(0)

Volumes with "Rebuild" status will be rebuilt within the operating system.

[↑]-Select      [ESC]-Exit      [ENTER]-Select Menu

```

- Exit Intel Rapid Storage Technology and reboot the system.
- Under Microsoft® Windows OS, select **Start > Programs > Intel Rapid Storage > Intel Rapid Storage Console** or click the **Intel Rapid Storage Technology** tray icon to load the Intel Rapid Storage Manager utility.
- From the **View** menu, select **Advanced Mode** to display the details of the Intel Rapid Storage Console.
- From the **Volumes view** option, select **RAID volume** to view the rebuilding status. When finished, the status is changed to **“Normal”**.

Rebuilding the RAID with a new hard disk

If any of the SATA hard disk drives included in the RAID array failed, the system displays the status of the RAID volume as **“Degraded”** during POST. You may replace the disk drive and rebuild the RAID array.

To rebuild the RAID with a new hard disk:

- Remove the failed SATA hard disk and install a new SATA hard disk of the same specification into the same SATA Port.



Select a destination disk with the same size as the original hard disk.

- Reboot the system and then follow the steps in section **Rebuilding the RAID with other non-RAID disk**.

6.3.7 Setting the Boot array in the BIOS Setup Utility

You can set the boot priority sequence in the BIOS for your RAID arrays when creating multi-RAID using the Intel® Rapid Storage Technology.

To set the boot array in the BIOS:



Set at least one of the arrays bootable to boot from the hard disk.

1. Reboot the system and press to enter the BIOS setup utility during POST.
2. Go to the **Boot** menu and select the boot option priority.
3. Use up/down arrow keys to select the boot priority and press <Enter>. See section **5.7 Boot menu** for details.
4. From the **Exit** menu, select **Save Changes & Exit**, then press <Enter>.
5. When the confirmation window appears, select **Yes**, then press <Enter>.

6.4 Intel® Rapid Storage Technology enterprise Utility (Windows)

The Intel® Rapid Storage Technology enterprise utility allows you to create RAID 0, RAID 1, RAID 10 (RAID 1+0), and RAID 5 set(s) from Serial ATA hard disk drives that are connected to the Serial ATA connectors supported by the Southbridge.

To enter the Intel® Rapid Storage Technology enterprise SCU option ROM utility under Windows operating system:

1. Turn on the system to windows desktop.
2. Click the **Intel® Rapid Storage Technology enterprise** icon to display the main menu.

Your storage system is configured for data protection, increased performance and optimal data storage capacity. You can further optimize your storage system by creating additional volumes.

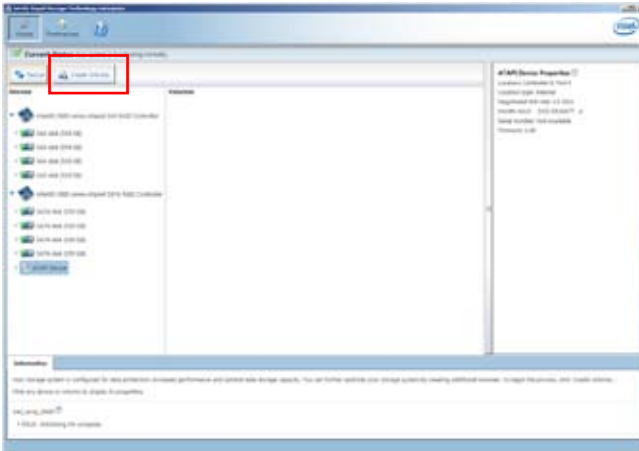

You can click **Rescan** to re-scan any attached hard disks.

6.4.1 Creating a RAID set

To create a RAID set

1. From the utility main menu, select **Create Volume** and select volume type.
2. Then click **Next**.



3. Enter a name for the RAID set, then select the array disks.
4. Select **Volume Size** tab, you can drag the bar to decide the volume size.
5. Then click **Next**.



- If you hard disk with existing data and you don't want to keep data from one of the selected disks, choose **NO** in next column (If displayed).
- If you want to **Enable volume write-back cache** or **Initialize volume**, you can click **Advanced** tab to select.

6. Confirm volume creation, then click **Create Volume** to continue.



This process could take a while depending on the number and size of the disks. You can continue using other applications during this time.

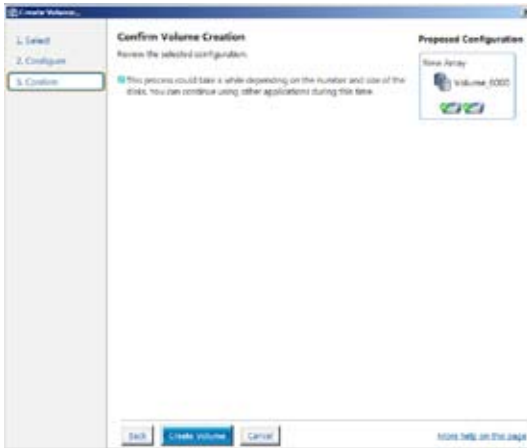

When display **Volume Creation Complete** message, you can click **OK** to finish.



You still need to partition your new volume using Windows Disk Management before adding any data.

When you are finished, you will see the following screen in **Volumes** field and you can change related items in the **Volume Properties** field.

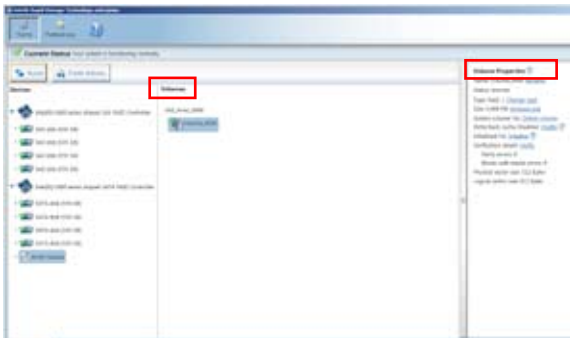

6.4.2 Change Volume Type

When you are finished to create a RAID set, you can view or change related items in the **Volume Properties** field.

According to the following steps to change the type in **Volume Properties**:

1. Click the SAS array items you want to change in **Volumes** field.
2. From the **Volume Properties** field, select **Type:RAID 1 Change type**.

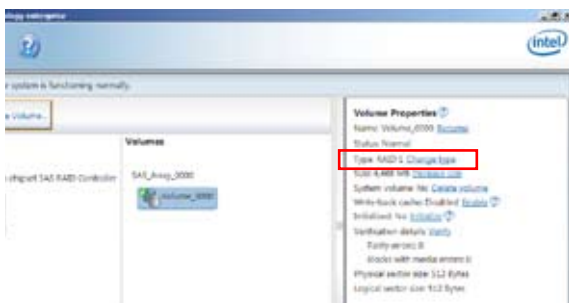

3. You can change the **Name**, **Select the new volume type**, and **Select additional disks to include in the new volume** if needed.
4. Then select the **Data stripe size** for the RAID array (for RAID 0, 10 and 5 only), and then click **OK**. The available stripe size values range from 4 KB to 128 KB. The following are typical values:

RAID 0: 128KB

RAID 10: 64KB

RAID 5: 64KB

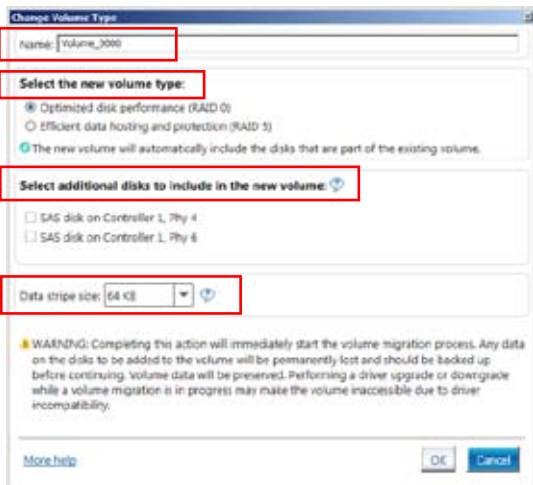

We recommend a lower stripe size for server systems, and a higher stripe size for multimedia computer systems used mainly for audio and video editing.

6.4.3 Delete volume



Take caution when deleting a volume. You will lose all data on the hard disk drives. Back up data before continuing.

To delete a volume:

1. From the utility main menu, select the volume (exp. Volume_0000) in **Volumes** field you want to delete.

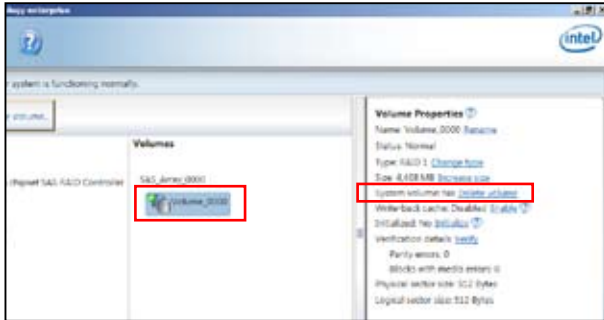

2. Then select **Delete volume** in **Volume Properties** field. The following screen appears.



3. Click **Yes** to delete the volume and return to the utility main menu, or click **No** to return to the main menu.

6.4.4 Preferences

System Preferences

Allow you set to show the notification area icon and show system information, warning, or errors here.

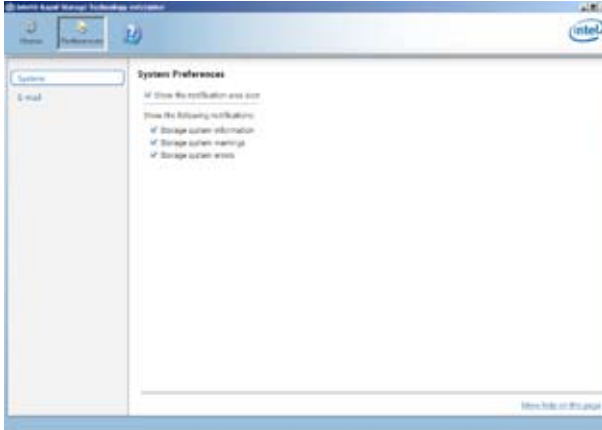

E-Mail Preferences

Allow you set to sent e-mail of the following events:

Storage system information

Storage system warnings

Storage system errors



Chapter 7

This chapter provides instructions for installing the necessary drivers for different system components.

Driver installation

7.1 RAID driver installation

After creating the RAID sets for your server system, you are now ready to install an operating system to the independent hard disk drive or bootable array. This part provides the instructions on how to install the RAID controller drivers during OS installation.

7.1.1 Creating a RAID driver disk



The system does not include a floppy drive. You have to use a USB floppy drive when creating a SATA RAID driver disk.



If you have created RAID sets with the LSI Software RAID configuration utility, the boot priority of the SATA optical disk drive has to be manually adjusted. Otherwise, the system will not boot from the connected SATA ODD.

A floppy disk with the RAID driver is required when installing Windows® XP / Server 2003 or Linux operating system on a hard disk drive that is included in a RAID set. You can create a RAID driver disk in DOS (using the Makedisk application in the support DVD).

To create a RAID driver disk in DOS environment

1. Place the motherboard support DVD in the optical drive.
2. Restart the computer, and then enter the BIOS Setup.
3. Select the optical drive as the first boot priority to boot from the support DVD. Save your changes, and then exit the BIOS Setup.
4. Restart the computer. The Makedisk menu appears.



5. Use the arrow keys to select the type of RAID driver disk you want to create and press <Enter> to enter the sub-menu.

C60x INTEL RAID Driver

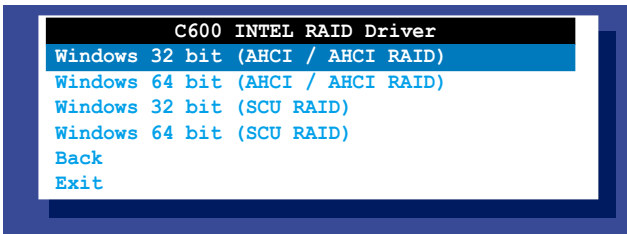

LSI 2008 SAS2 Driver

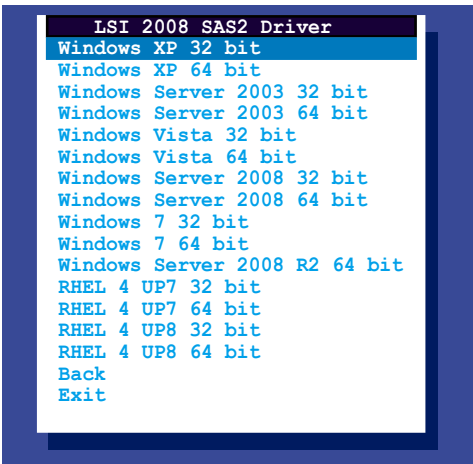

6. Locate the RAID driver and place a blank, high-density floppy disk to the floppy disk drive.
7. Press <Enter>.
8. Follow screen instructions to create the driver disk.

To create a RAID driver disk in Windows® environment

1. Start Windows®.
2. Place the motherboard support DVD into the optical drive.
3. Go to the **Make disk** menu, and then select the type of RAID driver disk you want to create.
4. Insert a floppy disk into the USB floppy disk drive.
5. Follow succeeding screen instructions to complete the process.



Write-protect the floppy disk to avoid computer virus infection.

To create a RAID driver disk in Red Hat® Enterprise Linux server environment

1. Insert a blank formatted high-density floppy disk to the USB floppy disk drive.
2. Type `dd if=XXX.img of=/dev/fd0` to decompress the file into the floppy disk from the following path in the support DVD:
For LSI MegaRAID Driver
\Drivers\C60x LSI RAID\Driver\makedisk\Linux
3. Eject the floppy disk.

7.1.2 Installing the RAID controller driver

During Windows® Server 2008 OS installation

To install the RAID controller driver when installing Windows® Server 2008 OS

1. Boot the computer using the Windows® Server 2008 OS installation disc. Follow the screen instructions to start installing Windows Server 2008.
2. When prompted to choose a type of installation, click **Custom (advanced)**.



3. Click **Load Driver**.

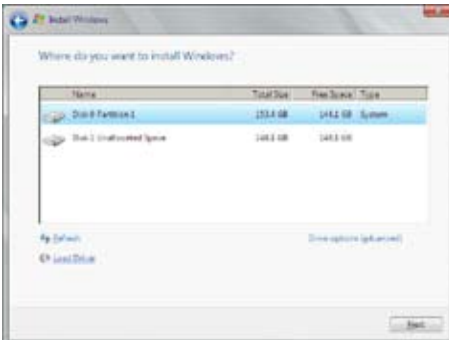

4. A message appears, reminding you to insert the installation media containing the driver of the RAID controller driver. If you have only one optical drive installed in your system, eject the Windows OS installation disc and replace with the motherboard Support DVD into the optical drive. Click **Browse** to continue.



5. Locate the driver in the corresponding folder of the Support DVD, and then click **OK** to continue.
6. Select the RAID controller driver you need from the list and click **Next**.
7. When the system finishes loading the RAID driver, replace the motherboard Support DVD with the Windows Server installation disc. Select the drive to install Windows and click **Next**.

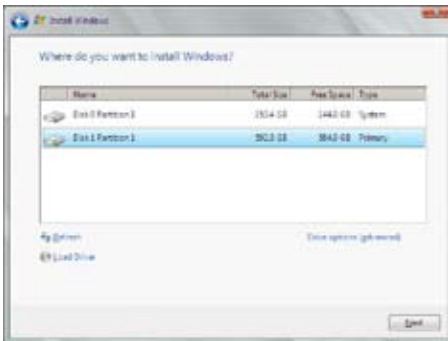

8. Setup then proceeds with the OS installation. Follow screen instructions to continue.

Red Hat® Enterprise Linux OS 5.6

To install the LSI MegaRAID controller driver when installing Red Hat® Enterprise OS:

1. Boot the system from the Red Hat® OS installation CD.
2. At the `boot:`, type `linux dd noprobe=ata1 noprobe=ata2...`, then press <Enter>.



The number of ata varies with the hard disk drive number you have when building a RAID set. For example, if you want to build a RAID set with 6 hard disk drives, type command line: `linux dd noprobe=ata1 noprobe=ata2 noprobe=ata3 noprobe=ata4 noprobe=ata5 noprobe=ata6`.

```
- To install or upgrade in graphical mode, press the <ENTER> key.
- To install or upgrade in text mode, type: linux text <ENTER>.
- Use the function keys listed below for more information.
[F1-Main] [F2-Options] [F3-General] [F4-Kernel] [F5-Rescue]
boot: linux dd noprobe=ata1 noprobe=ata2
```

3. Select **Yes** using the <Tab> key when asked if you have the driver disk, then press <Enter>.

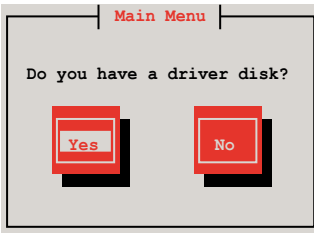

4. Insert the Red Hat® Enterprise RAID driver disk to the USB floppy disk drive, select **OK**, then press <Enter>.

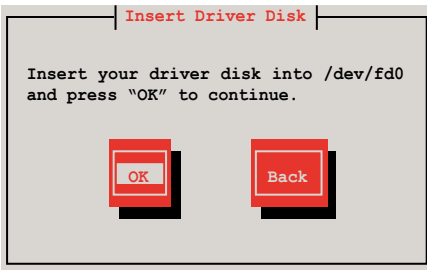

The drivers for the RAID card are installed to the system.

- When asked if you will load additional RAID controller drivers, select **No**, then press <Enter>.

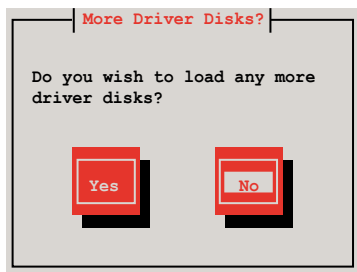

- Follow the onscreen instructions to finish the OS installation.
- When the installation is completed, DO NOT click **Reboot**. Press <Ctrl> + <Alt> + <F2> to switch to the command-line interface from graphic user interface.
- Type the following commands when using a Legacy floppy.

```
mkdir /mnt/driver
mount /dev/fd0 /mnt/driver
cd /mnt/driver
sh replace_ahci.sh
reboot
```

Red Hat® Enterprise Linux OS 6.1

To install the LSI MegaRAID controller driver when installing Red Hat® Enterprise OS:

1. Boot the system from the Red Hat® OS installation CD.
2. Press <Tab> to edit options.



3. Enter the following command at the boot: `Linux dd blacklist=isci blacklist=ahci nodmraid`, then press <ENTER>.



4. Select **Yes** using the <Tab> key when asked if you have the driver disk, then press <Enter>.

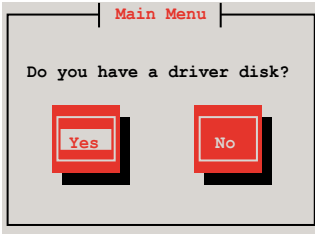

5. You have multiple devices which could serve as source for a driver disk. Choose one you like to use and select **OK**, then press <Enter>.

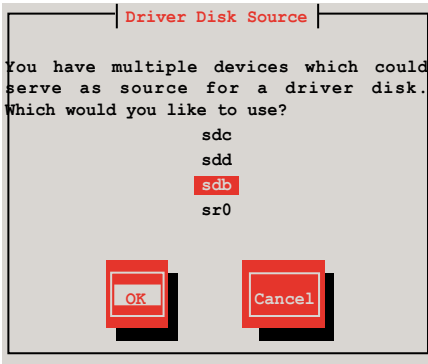

6. Insert the Red Hat® Enterprise RAID driver disk to the USB floppy disk drive, select **OK**, then press <Enter>.

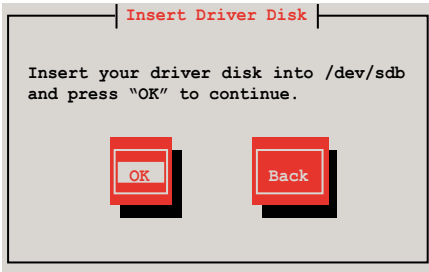

The drivers for the RAID card are installed to the system.

7. When asked if you will load additional RAID controller drivers, select **No**, then press <Enter>.

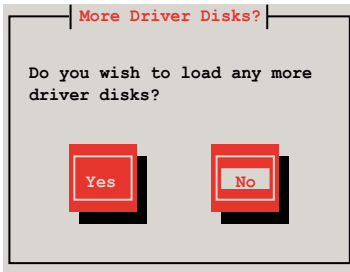

8. Follow the onscreen instructions to finish the OS installation.

Preparing the Linux Driver

Ensure that there is another computer with a Linux-based OS to create the RAID driver. When creating the RAID driver, you may refer to the examples below which uses a 64bit SUSE Linux system to create a 64bit RAID driver for SUSE11 sp1.

1. Copy the image file into the Linux system.

Example: `megasr-15.00.0120.2012-1-sles11-ga-x86_64.img`

2. Create a folder.

Example: `image`

3. Mount the image file into the image folder using this command format:

`mount -o loop [image file name] image`

Example: `mount -o loop megasr-15-15.00.0120.2012-1-sles11-ga-x86_64.img image`



4. Copy the contents of the image directory, labeled as **01**, into a FAT32 USB drive.



5. Rename the **01** folder to **CD Image**.



Installing SUSE 11 Linux OS

To install the LSI MegaRAID controller driver when installing SUSE Linux Enterprise Server OS:

1. Boot the system from the SUSE OS installation CD.
2. Use the arrow keys to select **Installation** from the **Boot Options** menu.



3. Press <F6>, then select **Yes** from the menu. Press <Enter>.



4. Use the USB drive to provide the third-party driver during the OS installation. Type the command `brokenmodules=ahci` in **Boot Options** field, and press <Enter>.



5. When below screen appears, select the USB floppy disk drive (sda) as the driver update medium. Select **OK**, then press <Enter>.

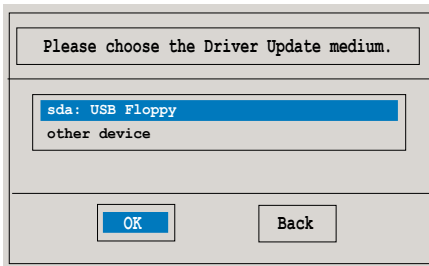

6. Select **Back** and follow the onscreen instructions to finish the installation.

7.2 Intel® Chipset Device Software installation

This section provides the instructions on how to install the Intel® chipset device software on the system.

You need to manually install the Intel® chipset device software on a Windows operating system.

To install the Intel® chipset device software:

1. Restart the computer, and then log on with **Administrator** privileges.
2. Insert the motherboard/system support DVD to the optical drive. The support DVD automatically displays the **Drivers** menu if Autorun is enabled in your computer.



If Autorun is NOT enabled in your computer, browse the contents of the support DVD to locate the file **ASSETUP.EXE** from the **BIN** folder. Double-click the **ASSETUP.EXE** to run the support DVD.

3. Click the item **Intel Chipset Device Software** from the menu.



4. The **Intel(R) Chipset Device Software** window appears. Click **Next** to start installation.



5. Select **Yes** to accept the terms of the **License Agreement** and continue the process.



6. Read the **Readme File Information** and press **Next** to continue the installation.



7. Toggle **Yes, I want to restart the computer now** and click **Finish** to complete the setup process.



7.3 Intel® Network Connections Software installation

This section provides the instructions on how to install the Intel® Network Connections Software on the system.

You need to manually install the Intel® Network Connections Software on a Windows® operating system. To install the Intel® Network Connections Software:

1. Restart the computer, and then log on with **Administrator** privileges.
2. Insert the motherboard/system support DVD to the optical drive. The support DVD automatically displays the **Drivers** menu if Autorun is enabled in your computer.



- Windows® automatically detects the LAN controllers and displays a New Hardware Found window. Click **Cancel** to close this window.
- If Autorun is NOT enabled in your computer, browse the contents of the support DVD to locate the file **ASSETUP.EXE** from the **BIN** folder. Double-click the **ASSETUP.EXE** to run the DVD.

3. Click the **Intel® Network Connections Software** to begin installation.



4. Click **Install Drivers and Software** option to begin installation.



5. Click **Next** when the **Intel(R) Network Connections–InstallShield Wizard** window appears.



6. Toggle **I accept the terms in the license agreement** and click **Next** to continue.



7. Click the **Intel(R) PROSet for Windows Device Manager** box, and then click **Next** to start the installation.



8. Follow the screen instructions to complete installation.

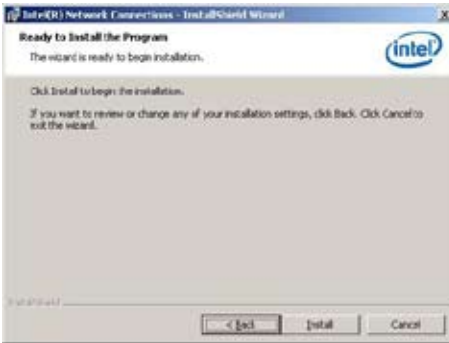

9. When finished, press **Finish** to continue.



7.4 VGA driver installation

This section provides the instructions on how to install the ASPEED Video Graphics Adapter (VGA) driver.

You need to manually install the ASPEED VGA driver on a Windows® operating system.

To install the ASPEED VGA driver:

1. Restart the computer, and then log on with **Administrator** privileges.
2. Insert the motherboard/system support DVD to the optical drive. The support DVD automatically displays the **Drivers** menu if Autorun is enabled in your computer.



If Autorun is NOT enabled in your computer, browse the contents of the support DVD to locate the file **ASSETUP.EXE** from the **BIN** folder. Double-click the **ASSETUP.EXE** to run the support DVD.

3. Click the **ASPEED AST2300 Display Driver** to begin installation.



4. When the **ASPEED Graphics** installation wizard appears, click **Next** to start the installation.



5. Toggle **I accept the terms in the license agreement** and click **Next** to continue.

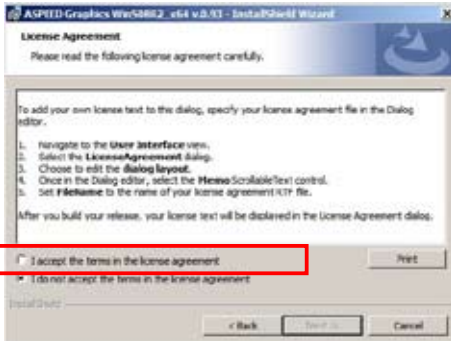

6. Enter the user information and click **Next** to continue.



7. Select a setup type and click **Next** to continue.

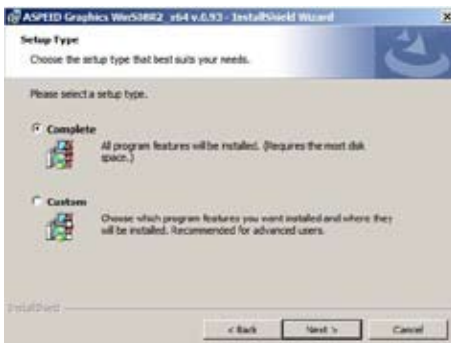

- Click **Install** to start driver installation.

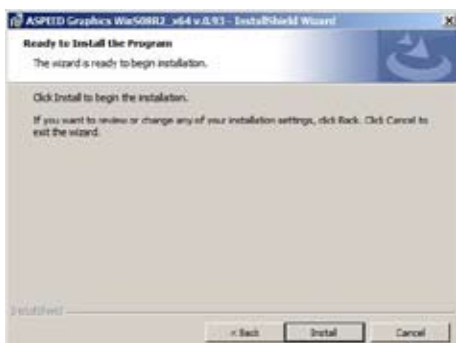

- When the installation completes, click **Finish** to restart your computer before using the program.

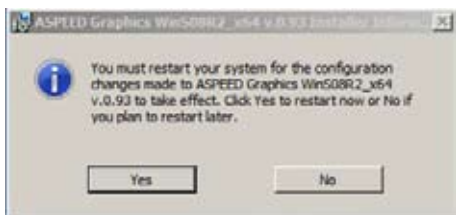

7.5 Intel® C600 Series Chipset SATA RAID Drivers

This section provides the instructions on how to install the **Intel® C600 Series Chipset SATA RAID Drivers** on the system.

You need to manually install the Intel® C600 Series Chipset SATA RAID Drivers on a Windows operating system.

To install the drivers:

1. Restart the computer, and then log on with **Administrator** privileges.
2. Insert the motherboard/system support DVD to the optical drive. The support DVD automatically displays the **Drivers** menu if Autorun is enabled in your computer.



If Autorun is NOT enabled in your computer, browse the contents of the support DVD to locate the file **ASSETUP.EXE** from the **BIN** folder. Double-click the **ASSETUP.EXE** to run the support DVD.

3. Click the item **Intel® C600 Series Chipset RAID Drivers** from the menu, and then follow the onscreen instructions to complete the installation.



7.6 Intel® Rapid Storage Technology enterprise 3.0 installation

This section provides the instructions on how to install the Intel® Rapid Storage Technology enterprise 3.0 on the system.

You need to manually install the Intel® Rapid Storage Technology enterprise 3.0 utility on a Windows® operating system.

To install the Intel® Rapid Storage Technology enterprise 3.0 utility:

1. Restart the computer, and then log on with **Administrator** privileges.
2. Insert the motherboard/system support DVD to the optical drive. The support DVD automatically displays the **Drivers** menu if Autorun is enabled in your computer.



If Autorun is NOT enabled in your computer, browse the contents of the support DVD to locate the file **ASSETUP.EXE** from the **BIN** folder. Double-click the **ASSETUP.EXE** to run the support DVD.

3. Click the **Intel® Rapid Storage Technology enterprise 3.0** to begin installation.



5. Read the **Warning** message and click **Next** to continue.



6. Read the **License Agreement** and click **Yes** to continue.



7. Read the **Readme File Information** and click **Next** to continue.



8. After completing the installation, click **Next** to complete the setup process.



9. Select **Yes, I want to restart my computer now** and click **Finish** to restart your computer before using the program.



7.7 Intel® PRO/1000 Gigabit Adapters Driver installation

This section provides the instructions on how to install Intel® PRO/1000 Gigabit Adapters Driver.

To install the Intel® PRO/1000 Gigabit Adapters Driver on a Windows® OS:

1. Restart the computer, and then log on with **Administrator** privileges.
2. Insert the motherboard/system support DVD to the optical drive. The DVD automatically displays the **Drivers** menu if Autorun is enabled in your computer.



If **Autorun** is NOT enabled in your computer, browse the contents of the support DVD to locate the file **AUTORUN.EXE** and double-click the **AUTORUN.EXE** and follow step 4 to run the installation.

3. Click **Intel® PRO/1000 Gigabit Adapters Driver**.



- When the **Intel® PRO Network Connections – InstallShield Wizard** window appears, click **Next** to start the installation.



- Click **I accept the terms in the license agreement** and then click **Next** to continue.

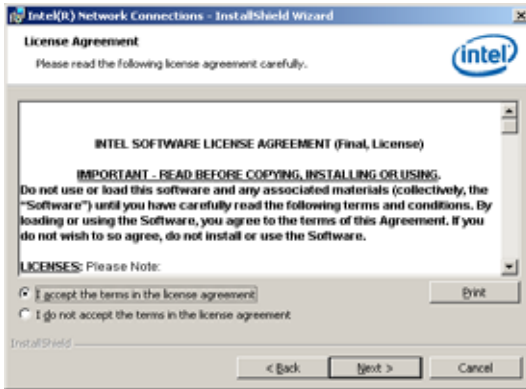

6. Select the programs you want to install and click **Next** to continue.

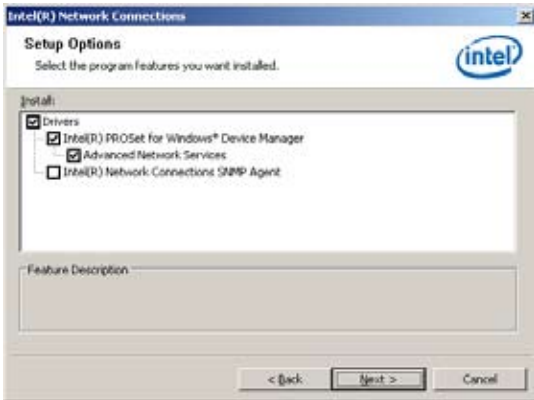

7. Click **Install** to start the installation.

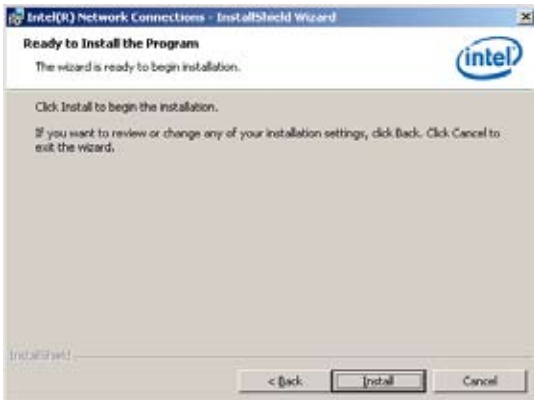

8. The programs you select are being installed.



9. Click **Finish** to finish the installation.

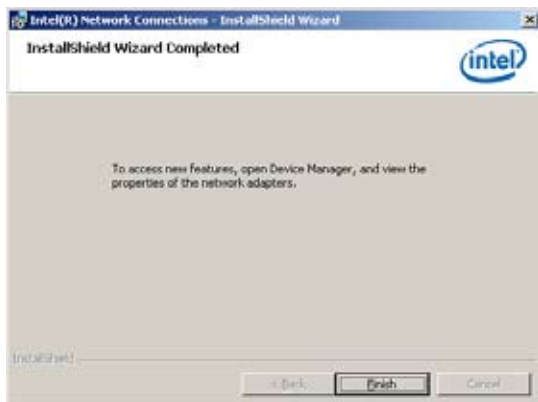

7.8 Management applications and utilities installation

The support DVD that came with the motherboard package contains the drivers, management applications, and utilities that you can install to avail all motherboard features.



The contents of the support DVD are subject to change at any time without notice. Visit the ASUS website (www.asus.com) for updates.

7.8.1 Running the support DVD

Place the support DVD to the optical drive. The DVD automatically displays the Drivers menu if Autorun is enabled in your computer.



If Autorun is NOT enabled in your computer, browse the contents of the support DVD to locate the file **ASSETUP.EXE** from the **BIN** folder. Double-click the **ASSETUP.EXE** to run the support DVD.

7.8.2 Drivers menu

The Drivers menu shows the available device drivers if the system detects installed devices. Install the necessary drivers to activate the devices.



The screen display and driver options vary under different operating system versions.



7.8.3 Utilities menu

The Utilities menu displays the software applications and utilities that the motherboard supports. Click an item to install.



7.8.4 Make disk menu

The Make disk menu contains items to create the Intel RAID driver disks.



7.8.5 Contact information

Click the Contact tab to display the ASUS contact information. You can also find this information on the inside front cover of this user guide.



7.9 Mellanox ConnectX-3 Infiniband driver installation (RS724Q-E7/RS12 and RS726Q-E7/RS12)

This section provides instructions on how to install the Mellanox driver.

7.9.1 Windows operating system

You need to manually install the Mellanox driver on a Windows® operating system. To install the Mellanox driver:

1. Restart the computer, then log on with Administrator privileges.
2. Insert the **Mellanox Infiniband support DVD** to the optical drive. The support DVD automatically displays the Drivers menu if Autorun is enabled in your computer.
3. Click **Mellanox ConnectX Virtual Channel Adapter Driver**.



4. Click **Next** to start installing the driver.



5. Click **I accept the terms in the license agreement** and click **Next** to continue.

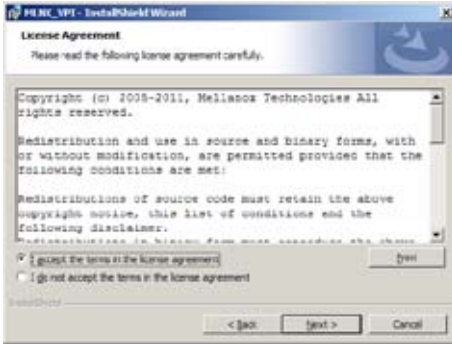

6. Click **Change** to select your desired destination folder and click **Next** to continue.

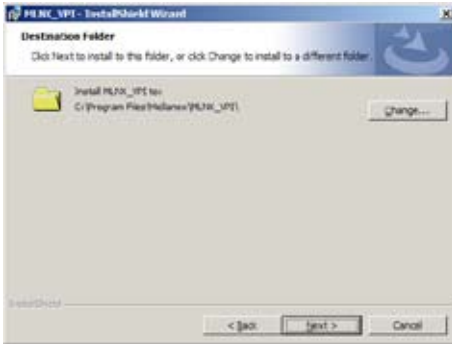

7. Check the box and click **Next** to continue.

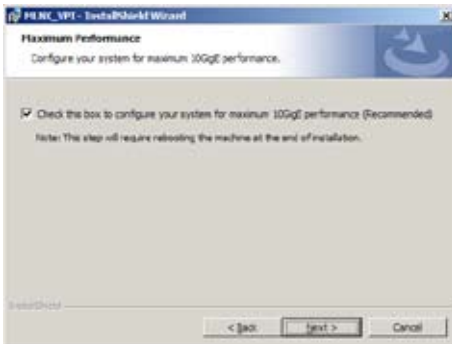

- Click **Install** to begin the installation.

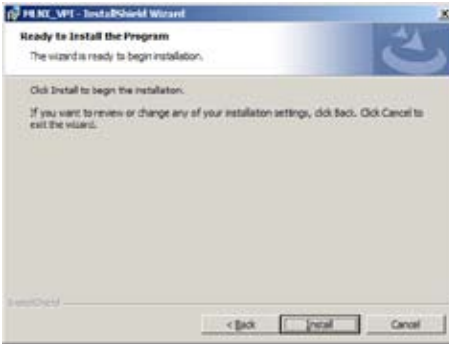

- Click your preferred options and click **Finish** to exit the wizard.



- Click **Yes** to restart your system for the configuration changes made to MLNX_VPI to take effect.

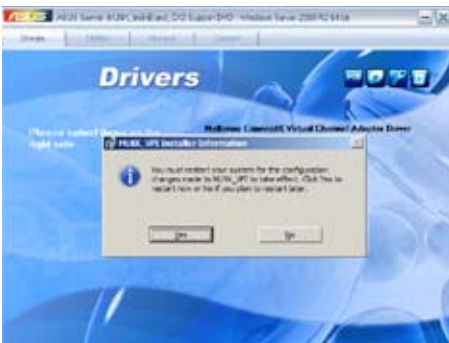

7.9.2 Red Hat® Enterprise Linux OS

You need to manually mount the Mellanox driver on a Red Hat® Enterprise Linux OS.



For users using SUSE Linux Enterprise Server OS, follow the general instructions in this section to mount the Mellanox driver on your system.

To mount the Mellanox driver:

1. Log in to the system as root.
2. Create a folder on the desktop and copy the latest Mellanox driver into the same folder. Rename the folder according to your preference, then type the following commands:

```
cd /
```

```
mkdir [folder name]
```

```
root@localhost:~# cd /
root@localhost:~# mkdir test
root@localhost:~/#
```

3. Type the command line: `mount -o ro,loop /tmp/[image file name] /[/folder name]` then mount the driver into the system.



The driver version and the OS label may vary. Ensure that the command line matches your driver version and operating system.

```
root@localhost:~# mount -o ro,loop /tmp/MAD_070_0200=1.0.0.0-00001.0000
0.00.0000
root@localhost:~#
```

- 4. Type the following commands before you install the driver:

```
cd /[folder name]
./mlnxofedinstall
```



- 5. All other Mellanox, OEM, OFED, or distribution IB packages will be removed. Press <Y> to continue.

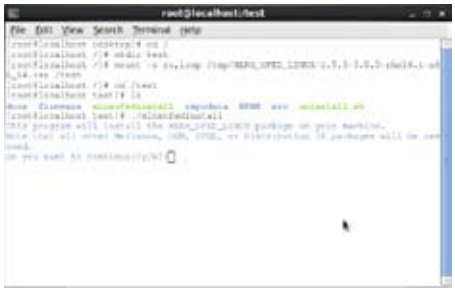

- 6. The system starts uninstalling the previous version of OFED.



Appendix

This appendix includes additional information that you may refer to when configuring the motherboard.

Notices

Federal Communications Commission Statement

This device complies with Part 15 of the FCC Rules. Operation is subject to the following two conditions:

- This device may not cause harmful interference.
- This device must accept any interference received including interference that may cause undesired operation.

This equipment has been tested and found to comply with the limits for a Class A digital device, pursuant to Part 15 of the FCC Rules. These limits are designed to provide reasonable protection against harmful interference in a residential installation. This equipment generates, uses and can radiate radio frequency energy and, if not installed and used in accordance with manufacturer's instructions, may cause harmful interference to radio communications. However, there is no guarantee that interference will not occur in a particular installation. If this equipment does cause harmful interference to radio or television reception, which can be determined by turning the equipment off and on, the user is encouraged to try to correct the interference by one or more of the following measures:

- Reorient or relocate the receiving antenna.
- Increase the separation between the equipment and receiver.
- Connect the equipment to an outlet on a circuit different from that to which the receiver is connected.
- Consult the dealer or an experienced radio/TV technician for help.



The use of shielded cables for connection of the monitor to the graphics card is required to assure compliance with FCC regulations. Changes or modifications to this unit not expressly approved by the party responsible for compliance could void the user's authority to operate this equipment.

Canadian Department of Communications Statement

This digital apparatus does not exceed the Class B limits for radio noise emissions from digital apparatus set out in the Radio Interference Regulations of the Canadian Department of Communications.

This class A digital apparatus complies with Canadian ICES-003.

REACH

Complying with the REACH (Registration, Evaluation, Authorisation, and Restriction of Chemicals) regulatory framework, we published the chemical substances in our products at ASUS REACH website at <http://csr.asus.com/english/REACH.htm>.



DO NOT throw the motherboard in municipal waste. This product has been designed to enable proper reuse of parts and recycling. This symbol of the crossed out wheeled bin indicates that the product (electrical and electronic equipment) should not be placed in municipal waste. Check local regulations for disposal of electronic products.



DO NOT throw the mercury-containing button cell battery in municipal waste. This symbol of the crossed out wheeled bin indicates that the battery should not be placed in municipal waste.

ASUS Recycling/Takeback Services

ASUS recycling and takeback programs come from our commitment to the highest standards for protecting our environment. We believe in providing solutions for you to be able to responsibly recycle our products, batteries, other components as well as the packaging materials. Please go to <http://csr.asus.com/english/Takeback.htm> for detailed recycling information in different regions.

Australia statement notice

From 1 January 2012 updated warranties apply to all ASUS products, consistent with the Australian Consumer Law. For the latest product warranty details please visit <http://support.asus.com>. Our goods come with guarantees that cannot be excluded under the Australian Consumer Law. You are entitled to a replacement or refund for a major failure and compensation for any other reasonably foreseeable loss or damage. You are also entitled to have the goods repaired or replaced if the goods fail to be of acceptable quality and the failure does not amount to a major failure.

If you require assistance please call ASUS Customer Service 1300 2787 88 or visit us at <http://support.asus.com>.

ASUS contact information

ASUSTeK COMPUTER INC.

Address 15 Li-Te Road, Peitou, Taipei, Taiwan 11259
Telephone +886-2-2894-3447
Fax +886-2-2890-7798
E-mail info@asus.com.tw
Web site <http://www.asus.com>

ASUSTeK COMPUTER INC. (Taiwan)

Address 15 Li-Te Road, Peitou, Taipei, Taiwan 11259
Telephone +886-2-2894-3447
Fax +886-2-2890-7798
E-mail info@asus.com.tw
Web site <http://tw.asus.com>

Technical Support

Telephone +886-2-2894-3447 (0800-093-456)
Online Support <http://support.asus.com/techserv/techserv.aspx>

ASUSTeK COMPUTER INC. (China)

Address No.508, Chundong Road, Minhang District,
Shanghai, 201108 China
Telephone +86-21-5442-1616
Fax +86-21-5442-0099
Web site <http://cn.asus.com>

Technical Support

Telephone +86-20-2804-7506 (800-820-6655)
Online Support <http://support.asus.com/techserv/techserv.aspx>

ASUS contact information

ASUS COMPUTER INTERNATIONAL (America)

Address 800 Corporate Way, Fremont, CA 94539, USA
Fax +1-510-608-4555
Web site <http://usa.asus.com>

Technical Support

Support fax +1-812-284-0883
General support +1-812-282-2787
Online support <http://support.asus.com/techserv/techserv.aspx>

ASUS COMPUTER GmbH (Germany and Austria)

Address Harkort Str. 21-23, 40880 Ratingen, Germany
Fax +49-2102-959911
Web site <http://www.asus.de>
Online contact <http://www.asus.de/sales>

Technical Support

Telephone +49-1805-010923
Support Fax +49-2102-959911
Online support <http://support.asus.com/techserv/techserv.aspx>

ASUS Czech Service s.r.o. (Europe)

Address Na Rovince 887, 720 00 Ostrava – Hrabová, Czech Republic
Telephone +420-596766888
Web site <http://www.asus.cz>

Technical Support

Telephone +420-596-766-891
Fax +420-596-766-329
E-mail advance.rma.eu@asus.com
Online Support <http://support.asus.com/techserv/techserv.aspx>

ASUS contact information

ASUS Holland BV (The Netherlands)

Address Marconistraat 2, 7825GD EMMEN, The Netherlands
Web site <http://www.asus.com>

Technical Support

Telephone +31-(0)591-5-70292
Fax +31-(0)591-666853
E-mail advance.rma.eu@asus.com
Online Support <http://support.asus.com/techserv/techserv.aspx>

ASUS Polska Sp. z o.o. (Poland)

Address Ul. Postępu 6, 02-676 Warszawa, Poland
Web site <http://pl.asus.com>

Technical Support

Telephone +48-225718033
Online Support <http://support.asus.com/techserv/techserv.aspx>

ASK-Service (Russia and CIS)

Address г.Москва, ул. Орджоникидзе, д.10, Россия
Telephone (495) 640-32-75
Web site <http://ru.asus.com>

Technical Support

Telephone 008-800-100-ASUS (008-800-100-2787)
Online Support <http://vip.asus.com/eservice/techserv.aspx?SLanguage=ru>

Free Manuals Download Website

<http://myh66.com>

<http://usermanuals.us>

<http://www.somanuals.com>

<http://www.4manuals.cc>

<http://www.manual-lib.com>

<http://www.404manual.com>

<http://www.luxmanual.com>

<http://aubethermostatmanual.com>

Golf course search by state

<http://golfingnear.com>

Email search by domain

<http://emailbydomain.com>

Auto manuals search

<http://auto.somanuals.com>

TV manuals search

<http://tv.somanuals.com>