

# Z11PA-D8C Series

## User Guide



**Copyright © 2020 ASUSTeK COMPUTER INC. All Rights Reserved.**

No part of this manual, including the products and software described in it, may be reproduced, transmitted, transcribed, stored in a retrieval system, or translated into any language in any form or by any means, except documentation kept by the purchaser for backup purposes, without the express written permission of ASUSTeK COMPUTER INC. ("ASUS").

Product warranty or service will not be extended if: (1) the product is repaired, modified or altered, unless such repair, modification or alteration is authorized in writing by ASUS; or (2) the serial number of the product is defaced or missing.

ASUS PROVIDES THIS MANUAL "AS IS" WITHOUT WARRANTY OF ANY KIND, EITHER EXPRESS OR IMPLIED, INCLUDING BUT NOT LIMITED TO THE IMPLIED WARRANTIES OR CONDITIONS OF MERCHANTABILITY OR FITNESS FOR A PARTICULAR PURPOSE. IN NO EVENT SHALL ASUS, ITS DIRECTORS, OFFICERS, EMPLOYEES OR AGENTS BE LIABLE FOR ANY INDIRECT, SPECIAL, INCIDENTAL, OR CONSEQUENTIAL DAMAGES (INCLUDING DAMAGES FOR LOSS OF PROFITS, LOSS OF BUSINESS, LOSS OF USE OR DATA, INTERRUPTION OF BUSINESS AND THE LIKE), EVEN IF ASUS HAS BEEN ADVISED OF THE POSSIBILITY OF SUCH DAMAGES ARISING FROM ANY DEFECT OR ERROR IN THIS MANUAL OR PRODUCT.

SPECIFICATIONS AND INFORMATION CONTAINED IN THIS MANUAL ARE FURNISHED FOR INFORMATIONAL USE ONLY, AND ARE SUBJECT TO CHANGE AT ANY TIME WITHOUT NOTICE, AND SHOULD NOT BE CONSTRUED AS A COMMITMENT BY ASUS. ASUS ASSUMES NO RESPONSIBILITY OR LIABILITY FOR ANY ERRORS OR INACCURACIES THAT MAY APPEAR IN THIS MANUAL, INCLUDING THE PRODUCTS AND SOFTWARE DESCRIBED IN IT.

Products and corporate names appearing in this manual may or may not be registered trademarks or copyrights of their respective companies, and are used only for identification or explanation and to the owners' benefit, without intent to infringe.

# Contents

<b>Notices</b> .....	<b>viii</b>
Federal Communications Commission Statement .....	viii
Canadian Department of Communications Statement.....	viii
REACH .....	viii
<b>Safety information</b> .....	<b>ix</b>
Electrical safety .....	ix
Operation safety.....	ix
Australia statement notice.....	x
How this guide is organized .....	xi
Where to find more information.....	xi
<b>Z11PA-D8C Series specifications summary</b> .....	<b>xiii</b>

## Chapter 1: Product Introduction

<b>1.1</b>	<b>Welcome!</b> .....	<b>1-2</b>
<b>1.2</b>	<b>Package contents</b> .....	<b>1-2</b>
<b>1.3</b>	<b>Serial number label</b> .....	<b>1-3</b>
<b>1.4</b>	<b>Special features</b> .....	<b>1-3</b>
1.4.1	Product highlights.....	1-3
1.4.2	Innovative ASUS features .....	1-4

## Chapter 2: Hardware Information

<b>2.1</b>	<b>Before you proceed</b> .....	<b>2-2</b>
<b>2.2</b>	<b>Motherboard overview</b> .....	<b>2-3</b>
2.2.1	Placement direction.....	2-3
2.2.2	Screw holes.....	2-3
2.2.3	Motherboard layout .....	2-4
<b>2.3</b>	<b>Central Processing Unit (CPU)</b> .....	<b>2-6</b>
2.3.1	Installing the CPU .....	2-6
<b>2.4</b>	<b>System memory</b> .....	<b>2-8</b>
2.4.1	Overview .....	2-8
2.4.2	Memory Configurations.....	2-8
2.4.3	Installing a DIMM on a single clip DIMM socket.....	2-10
2.4.4	Removing a DIMM from a single clip DIMM socket .....	2-10

# Contents

- 2.5 Expansion slots.....2-11**
  - 2.5.1 Installing an expansion card.....2-11
  - 2.5.2 Configuring an expansion card .....2-11
  - 2.5.3 Interrupt assignments.....2-12
  - 2.5.4 PCI Express x16 slot (x16 link) .....2-12
  - 2.5.5 PCI Express x8 slot (x8 link) .....2-12
- 2.6 Jumpers .....2-14**
- 2.7 Onboard LEDs.....2-20**
- 2.8 Connectors .....2-24**
  - 2.8.1 Rear panel connectors.....2-24
  - 2.8.2 Internal connectors.....2-25

## Chapter 3: Powering Up

- 3.1 Starting up for the first time.....3-2**
- 3.2 Powering off the computer.....3-3**
  - 3.2.1 Using the OS shut down function.....3-3
  - 3.2.2 Using the dual function power switch.....3-3

## Chapter 4: BIOS Setup

- 4.1 Managing and updating your BIOS .....4-2**
  - 4.1.1 ASUS CrashFree BIOS 3 utility.....4-2
  - 4.1.2 ASUS EZ Flash Utility .....4-3
  - 4.1.3 BUPDATER utility .....4-4
- 4.2 BIOS setup program .....4-6**
  - 4.2.1 BIOS menu screen.....4-7
  - 4.2.2 Menu bar.....4-7
  - 4.2.3 Menu items.....4-8
  - 4.2.4 Submenu items .....4-8
  - 4.2.5 Navigation keys.....4-8
  - 4.2.6 General help.....4-8
  - 4.2.7 Configuration fields .....4-8
  - 4.2.8 Pop-up window.....4-8
  - 4.2.9 Scroll bar.....4-8
- 4.3 Main menu .....4-9**
  - 4.3.1 System Date [Day xx/xx/xxxx].....4-9
  - 4.3.2 System Time [xx:xx:xx] .....4-9
- 4.4 Performance Tuning menu.....4-10**

# Contents

<b>4.5</b>	<b>Advanced menu .....</b>	<b>4-11</b>
4.5.1	Trusted Computing.....	4-12
4.5.2	ACPI Settings.....	4-12
4.5.3	Smart Settings.....	4-13
4.5.4	Super IO Configuration .....	4-13
4.5.5	Serial Port Console Redirection.....	4-14
4.5.6	Onboard LAN Configuration .....	4-17
4.5.7	APM .....	4-18
4.5.8	PCI Subsystem Settings .....	4-19
4.5.9	USB Configuration .....	4-21
4.5.10	CSM Configuration.....	4-22
4.5.11	NVMe Configuration.....	4-23
4.5.12	Network Stack Configuration.....	4-23
4.5.13	iSCSI Configuration.....	4-24
<b>4.6</b>	<b>Platform Configuration menu .....</b>	<b>4-24</b>
4.6.1	PCH Configuration .....	4-25
4.6.2	Miscellaneous Configuration .....	4-27
4.6.3	Server ME Configuration.....	4-27
4.6.4	Runtime Error Logging Support .....	4-28
<b>4.7</b>	<b>Socket Configuration menu .....</b>	<b>4-28</b>
4.7.1	Processor Configuration.....	4-29
4.7.2	Common RefCode Configuration.....	4-30
4.7.3	UPI Configuration.....	4-31
4.7.4	Memory Configuration.....	4-32
4.7.5	IIO Configuration .....	4-34
4.7.6	Advanced Power Management Configuration.....	4-35
<b>4.8</b>	<b>Event Logs menu .....</b>	<b>4-37</b>
4.8.1	Change Smbios Event Log Settings .....	4-37
4.8.2	View Smbios Event Log .....	4-37
<b>4.9</b>	<b>Server Mgmt menu .....</b>	<b>4-38</b>
<b>4.10</b>	<b>Security menu .....</b>	<b>4-39</b>
<b>4.11</b>	<b>Boot menu .....</b>	<b>4-41</b>
<b>4.12</b>	<b>Tool menu.....</b>	<b>4-42</b>
<b>4.13</b>	<b>Save &amp; Exit menu.....</b>	<b>4-42</b>

# Contents

## Chapter 5: RAID Configuration

<b>5.1</b>	<b>Setting up RAID</b> .....	<b>5-2</b>
5.1.1	RAID definitions .....	5-2
5.1.2	Installing hard disk drives.....	5-3
5.1.3	Setting the RAID item in BIOS .....	5-3
<b>5.2</b>	<b>Intel® Rapid Storage Technology enterprise SATA Option ROM Utility</b> .....	<b>5-4</b>
5.2.1	Creating a RAID set .....	5-5
5.2.2	Deleting a RAID set.....	5-7
5.2.3	Resetting disks to Non-RAID .....	5-8
5.2.4	Exiting the Intel® Rapid Storage Technology enterprise SATA Option ROM utility.....	5-9
5.2.5	Rebuilding the RAID.....	5-9
5.2.6	Setting the Boot array in the BIOS Setup Utility.....	5-11
<b>5.3</b>	<b>Intel® Rapid Storage Technology enterprise (Windows)</b> .....	<b>5-12</b>
5.3.1	Creating a RAID set.....	5-13
5.3.2	Changing a Volume Type.....	5-15
5.3.3	Deleting a volume .....	5-16
5.3.4	Preferences.....	5-17
<b>5.4</b>	<b>Intel® Virtual Raid on CPU in BIOS</b> .....	<b>5-18</b>
5.4.1	Creating a RAID set.....	5-19
5.4.2	Deleting a RAID set.....	5-21
5.4.3	Installing the RAID controller driver during Windows® 10 OS installation .....	5-22

# Contents

## Chapter 6: Driver Installation

<b>6.1</b>	<b>RAID driver installation .....</b>	<b>6-2</b>
6.1.1	Creating a USB flash drive with RAID drive .....	6-2
6.1.2	Installing the RAID controller driver.....	6-2
<b>6.2</b>	<b>Management applications and utilities installation .....</b>	<b>6-5</b>
<b>6.3</b>	<b>Running the Support DVD.....</b>	<b>6-5</b>
<b>6.4</b>	<b>Intel® chipset device software installation.....</b>	<b>6-8</b>
<b>6.5</b>	<b>Installing the Intel® I210 Gigabit Adapters driver.....</b>	<b>6-10</b>
<b>6.6</b>	<b>VGA driver installation .....</b>	<b>6-13</b>
<b>6.7</b>	<b>Intel® Rapid Storage Technology enterprise 5.0 installation .....</b>	<b>6-15</b>

## Appendix

Z11PA-D8C Series block diagram .....	A-2
Q-Code table.....	A-3
Simplified EU Declaration of Conformity.....	A-5
ASUS contact information.....	A-6

# Notices

## Federal Communications Commission Statement

This device complies with Part 15 of the FCC Rules. Operation is subject to the following two conditions:

- This device may not cause harmful interference, and
- This device must accept any interference received including interference that may cause undesired operation.

This equipment has been tested and found to comply with the limits for a Class B digital device, pursuant to Part 15 of the FCC Rules. These limits are designed to provide reasonable protection against harmful interference in a residential installation. This equipment generates, uses and can radiate radio frequency energy and, if not installed and used in accordance with manufacturer's instructions, may cause harmful interference to radio communications. However, there is no guarantee that interference will not occur in a particular installation. If this equipment does cause harmful interference to radio or television reception, which can be determined by turning the equipment off and on, the user is encouraged to try to correct the interference by one or more of the following measures:

- Reorient or relocate the receiving antenna.
- Increase the separation between the equipment and receiver.
- Connect the equipment to an outlet on a circuit different from that to which the receiver is connected.
- Consult the dealer or an experienced radio/TV technician for help.



---

The use of shielded cables for connection of the monitor to the graphics card is required to assure compliance with FCC regulations. Changes or modifications to this unit not expressly approved by the party responsible for compliance could void the user's authority to operate this equipment.

---

## Canadian Department of Communications Statement

This digital apparatus does not exceed the Class B limits for radio noise emissions from digital apparatus set out in the Radio Interference Regulations of the Canadian Department of Communications.

This class B digital apparatus complies with Canadian ICES-003.

## REACH

Complying with the REACH (Registration, Evaluation, Authorization, and Restriction of Chemicals) regulatory framework, we publish the chemical substances in our products at ASUS REACH website at <http://csr.asus.com/english/REACH.htm>.



# Safety information

## Electrical safety

- To prevent electrical shock hazard, disconnect the power cable from the electrical outlet before relocating the system.
- When adding or removing devices to or from the system, ensure that the power cables for the devices are unplugged before the signal cables are connected. If possible, disconnect all power cables from the existing system before you add a device.
- Before connecting or removing signal cables from the motherboard, ensure that all power cables are unplugged.
- Seek professional assistance before using an adapter or extension cord. These devices could interrupt the grounding circuit.
- Make sure that your power supply is set to the correct voltage in your area. If you are not sure about the voltage of the electrical outlet you are using, contact your local power company.
- If the power supply is broken, do not try to fix it by yourself. Contact a qualified service technician or your retailer.

## Operation safety

- Before installing the motherboard and adding devices on it, carefully read all the manuals that came with the package.
- Before using the product, make sure all cables are correctly connected and the power cables are not damaged. If you detect any damage, contact your dealer immediately.
- To avoid short circuits, keep paper clips, screws, and staples away from connectors, slots, sockets and circuitry.
- Avoid dust, humidity, and temperature extremes. Do not place the product in any area where it may become wet.
- Place the product on a stable surface.
- If you encounter technical problems with the product, contact a qualified service technician or your retailer.



---

**DO NOT** throw the motherboard in municipal waste. This product has been designed to enable proper reuse of parts and recycling. This symbol of the crossed out wheeled bin indicates that the product (electrical and electronic equipment) should not be placed in municipal waste. Check local regulations for disposal of electronic products.

---



---

**DO NOT** throw the mercury-containing button cell battery in municipal waste. This symbol of the crossed out wheeled bin indicates that the battery should not be placed in municipal waste.

---

## **Australia statement notice**

From 1 January 2012 updated warranties apply to all ASUS products, consistent with the Australian Consumer Law. For the latest product warranty details please visit <https://www.asus.com/support>. Our goods come with guarantees that cannot be excluded under the Australian Consumer Law. You are entitled to a replacement or refund for a major failure and compensation for any other reasonably foreseeable loss or damage. You are also entitled to have the goods repaired or replaced if the goods fail to be of acceptable quality and the failure does not amount to a major failure.

If you require assistance please call ASUS Customer Service 1300 2787 88 or visit us at <https://www.asus.com/support>.

# About this guide

This user guide contains the information you need when installing and configuring the motherboard.

## How this guide is organized

This user guide contains the following parts:

- **Chapter 1: Product Introduction**  
This chapter describes the features of the motherboard and the new technologies it supports.
- **Chapter 2: Hardware Information**  
This chapter lists the hardware setup procedures that you have to perform when installing system components. It includes description of the switches, jumpers, and connectors on the motherboard.
- **Chapter 3: Powering Up**  
This chapter describes the power up sequence and ways of shutting down the system.
- **Chapter 4: BIOS Setup**  
This chapter tells how to change system settings through the BIOS Setup menus. Detailed descriptions of the BIOS parameters are also provided.
- **Chapter 5: RAID Configuration**  
This chapter provides instructions for setting up, creating, and configuring RAID sets using the available utilities.
- **Chapter 6: Driver Installation**  
This chapter provides instructions for installing the necessary drivers for different system components.
- **Appendix: Reference Information**  
This appendix includes additional information that you may refer to when configuring the motherboard.

## Where to find more information

Refer to the following sources for additional information and for product and software updates.

1. **ASUS websites**  
The ASUS website provides updated information on ASUS hardware and software products. Refer to the ASUS contact information.
2. **Optional documentation**  
Your product package may include optional documentation, such as warranty flyers, that may have been added by your dealer. These documents are not part of the standard package.

## Conventions used in this guide

To ensure that you perform certain tasks properly, take note of the following symbols used throughout this manual.



**DANGER/WARNING:** Information to prevent injury to yourself when trying to complete a task.



**CAUTION:** Information to prevent damage to the components when trying to complete a task.



**IMPORTANT:** Instructions that you **MUST** follow to complete a task.



**NOTE:** Tips and additional information to help you complete a task.

## Typography

**Bold text**

Indicates a menu or an item to select.

*Italics*

Used to emphasize a word or a phrase.

<Key>

Keys enclosed in the less-than and greater-than sign means that you must press the enclosed key.

Example: <Enter> means that you must press the Enter or Return key.

<Key1> + <Key2> + <Key3>

If you must press two or more keys simultaneously, the key names are linked with a plus sign (+).

Example: <Ctrl> + <Alt> + <Del>

**Command**

Means that you must type the command exactly as shown, then supply the required item or value enclosed in brackets.

Example: At DOS prompt, type the command line:

**format A: /S**

## Z11PA-D8C Series specifications summary

Model Name		Z11PA-D8C
Processor Support / System Bus		2 x 140W Socket P (LGA 3647) 1st Gen Intel® Xeon® Processor Scalable Family 2nd Gen Intel® Xeon® Processor Scalable Family
Core Logic		Intel® Lewisburg PCH (C621)
Form Factor		CEB
ASUS Features	Fan Speed Control	✓
	Rack Optimized (Dedicated for rack)	✓
	ASUS Control Center	✓
Memory	Total Slots	8 (4-channel per CPU, 4 DIMM per CPU)
	Voltage	1.2V
	Capacity	Maximum up to 4096GB
	Memory Type	DDR4 2933* (1 DIMM per Channel) DDR4 2666/2400/2133 RDIMM/LRDIMM/LRDIMM 3DS (2 DIMM per Channel) Intel® Optane™ DC persistent memory (DCPMM) * 2933MHz will drop to 2666MHz when using 2DPC configurations ** Refer to ASUS server AVL for the latest update
	Memory Size	4GB, 8GB, 16GB, 32GB (RDIMM) 32GB, 64GB, 128GB (LRDIMM) 64GB, 128GB (3DS) 128GB, 256GB, 512GB (DCPMM)
Expansion Slots (follow SSI Location number)	Total PCI/ PCI-X / PCI-E Slots	3
	Slot Location 1	PCI-E x8 (Gen3 x8 link) from CPU2
	Slot Location 2	-
	Slot Location 3	PCI-E x16 (Gen3 x16 link) from CPU1
	Slot Location 4	-
	Slot Location 5	PCI-E x16 (Gen3 x16 Link) from CPU1
	Slot Location 6	-
	Slot Location 7	-
	Additional Slot 1	-
Additional Slot 2	-	
Networking	LAN	2 x Intel I210AT 1 x Management Port
	Graphic	VGA
		Asped AST2500 64MB

(continued on the next page)

## Z11PA-D8C Series specifications summary

Model Name		Z11PA-D8C
Storage	SATA Controller	Intel® Lewisburg PCH - 8 x SATA3 6Gb/s ports (8 by 2 mini-SAS Connector) + 1 x M.2 connector (SATA 6Gb/s & PCI-E Gen3 x4 link)
	SAS Controller	Optional kits: ASUS PIKE II 3008 8-port SAS 12G HW RAID card ASUS PIKE II 3108 8-port SAS 12G HW RAID card
Onboard I/O Connectors	TPM Header	1
	PSU Connector	24-pin SSI power connector + 2 x 8-pin SSI 12V
	Management Connector	Onboard ASMB9-iKVM
	Fan Header	8 x 4 pin
	SMBus	1
	Chassis Intruder	1
	Front LAN LED	2
	Serial Port Header	1
	M.2 Connector	1 (NGFF Type 22110)
	Micro SD card	1
Rear I/O Connectors	VROC Key Header	1
	External USB Port	4 x USB 3.0
	VGA Port	1
Management Solution	RJ-45	2 x GbE LAN 1 x Mgmt LAN
	Out of Band Remote Management	ASMB9-iKVM for KVM-over-Internet
Monitoring	CPU Temperature	✓
	FAN RPM	✓
Environment		<b>Operating temperature:</b> 10°C ~ 35°C <b>Non operating temperature:</b> -40°C ~ 70°C <b>Non operating humidity:</b> 20% ~ 90% (Non condensing)

\* Specifications are subject to change without notice.

\*\* Refer to [www.asus.com](http://www.asus.com) for the complete list of supported PIKE cards.

# Product Introduction

# 1

This chapter describes the motherboard features and the new technologies it supports.

# 1.1 Welcome!

Congratulations and thank you for buying an ASUS® Z11PA-D8C Series motherboard!  
The motherboard delivers a host of new features and latest technologies, making it another standout in the long line of ASUS quality motherboards!  
Before you start installing the motherboard and hardware devices on it, check the items in your package with the list below.

# 1.2 Package contents

Check your motherboard package for the following items.

	Standard Gift Box Pack	Standard Bulk Pack
I/O Shield	1	1
Application CD Support DVD	1	1 piece per carton
Packaging Quantity	1 piece per carton	10 pieces per carton



If any of the above items is damaged or missing, contact your retailer.

Optional items	Description
PIKE 3008	LSI 8-port SAS 12G RAID card
PIKE 3108	LSI 8-port SAS 12G HW RAID card
ASMB9-iKVM	Remote management solution provides KVM over IP solution
PEM-FDR	Mellanox ConnectX-3 FDR card
PEB-10G/57840-2S	Dual port 10G SFP+ Ethernet Adapter
PEB-10G/57811-1S	Single port 10G SFP+ Ethernet Adapter
PEI-10G/82599-2S	10GbE SFP+ Network Adapter



The ASUS PIKE 3008, PIKE 3108, and PEM-FDR cards must be installed on PCI-E slot 2/3/4/5.



## 1.3 Serial number label

Before requesting support from the ASUS Technical Support team, you must take note of the motherboard's serial number containing 12 characters xxS2xxxxxxx shown in the figure below. With the correct serial number of the product, ASUS Technical Support team members can then offer a quicker and satisfying solution to your problems.



## 1.4 Special features

### 1.4.1 Product highlights

#### Latest Processor Technology

The motherboard supports Intel® Xeon® Scalable processor family which provides compelling IPC increases for legacy performance improvements, floating point improvement, easier multi-core programming, and with next-generation processor power management. Intel® Xeon® Scalable processor family also improve the I/O capabilities and support UPI link speed of up to 10.4GT/s.

#### Intel® AVX 512

Intel® AVX 2.0 extends 512-bit vector support for integer vector operations, doubles fixed point arithmetic throughput, adds support for new vector gather, permutes/blend, vector shifts resulting in fixed and floating-point algorithm improvements. Also, Intel's new microarchitecture doubles the cache bandwidth at L1/L2 to support higher FLOPS and contributes to greater performance in signal and image processing applications.

#### Next Generation of processor power management

Intel® Xeon® Scalable processor family enhances the processor power management with the features of Energy Efficient Turbo, Uncore Frequency Scaling, and Per-Core P-state. Also, the Integrated Voltage Regulator enables generational performance and power improvements that the standard VR solutions cannot provide.

#### DDR4 memory support

The motherboard supports DDR4 memory that features faster clock frequencies and higher data transfer rates of 2133 MT/s to 2666 MT/s (million transfers per second). DDR4 offers a lower voltage standard of 1.2V that reduces memory power demand and provides improved performance.

## **M.2 Support**

This motherboard features the M.2 slot, which shares bandwidth with the SATA 6Gb/s port and PCI-E Gen3 x4 and is dedicated to the operating system.

## **PCI Express 3.0**

PCI Express 3.0 (PCIe 3.0) is the PCI Express bus standard that provides twice the performance and speed of PCIe 2.0. It provides an optimal graphics performance, unprecedented data speed, and seamless transition with its complete backward compatibility to PCIe 2.0 devices.

## **Intel® I210AT LAN Solution**

The motherboard comes with four Gigabit LAN controllers and ports which provide a total solution for your networking needs. The onboard Intel® I210AT Gigabit LAN controllers use the PCI Express interface and could achieve network throughput close to Gigabit bandwidth.

## **Intel® C621 Series Chipset**

The Intel® C621 series chipset supports with enterprise class features which is targeted for Cloud and Storage applications. It is optimized and validated to work with the latest Intel® Xeon® Scalable processor family, compared with the last generation, it also reduces the TDP, supports USB 3.0 with up to 12 SATA III ports thus bringing more features and benefits to the target users.

## **Serial ATA III technology**

The motherboard supports the Serial ATA III technology through the Serial ATA interface and Intel® 621 chipset, delivering up to 6 Gb/s data transfer rates. It also provides enhanced scalability, faster data retrieval, and double the bandwidth of current bus systems.

## **Temperature, fan, and voltage monitoring**

The CPU temperature is monitored to prevent overheating and damage. The system fan rotations per minute (RPM) is monitored for timely failure detection. The chip monitors the voltage levels to ensure a stable supply of current for critical components.

## **1.4.2 Innovative ASUS features**

### **ASUS Fan Speed control technology**

The ASUS Fan Speed control technology smartly adjusts the fan speeds according to the system loading to ensure a quiet, cool, and efficient operation.

# Hardware Information

# 2

This chapter lists the hardware setup procedures that you have to perform when installing system components. It includes description of the jumpers and connectors on the motherboard.

## 2.1 Before you proceed

Take note of the following precautions before you install any motherboard component or change any motherboard settings.



- 
- Unplug the power cord from the wall socket before touching any component.
  - Use a grounded wrist strap or touch a safely grounded object or a metal object, such as the power supply case, before handling components to avoid damaging them due to static electricity.
  - Hold components by the edges to avoid touching the ICs on them.
  - Whenever you uninstall any component, place it on a grounded antistatic pad or in the bag that came with the component.
  - Before you install or remove any component, ensure that the power supply is switched off or the power cord is detached from the power supply. Failure to do so may cause severe damage to the motherboard, peripherals, and/or components.
-

## 2.2 Motherboard overview

Before you install the motherboard, study the configuration of your chassis to ensure that the motherboard fits into it.

To optimize the features of your motherboard, we highly recommend that you install it in an ATX 2.2 compliant chassis.



Ensure to unplug the chassis power cord before installing or removing the motherboard. Failure to do so can cause you physical injury and damage motherboard components!

### 2.2.1 Placement direction

When installing the motherboard, ensure that you place it into the chassis in the correct orientation. The edge with external ports goes to the rear part of the chassis as indicated in the image below.

### 2.2.2 Screw holes

Place nine (9) screws into the holes indicated by circles to secure the motherboard to the chassis.



DO NOT overtighten the screws! Doing so can damage the motherboard.

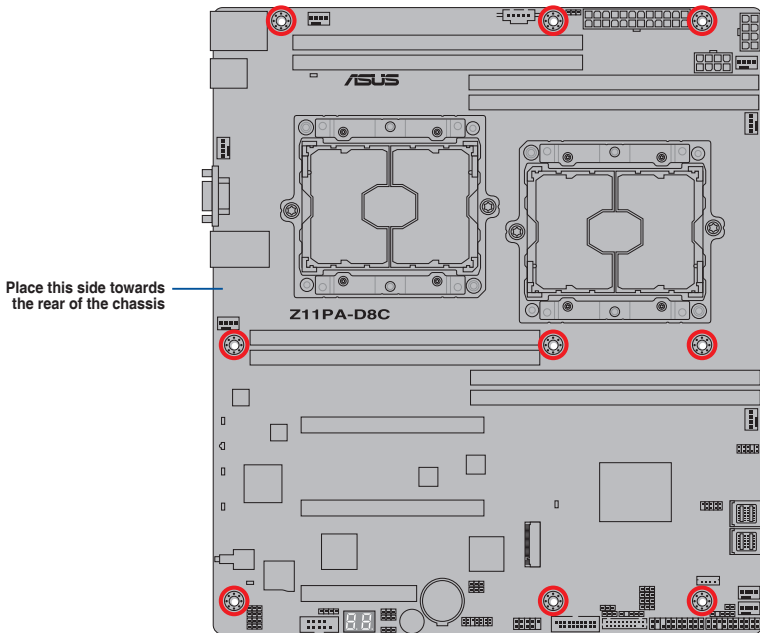

## 2.2.3 Motherboard layout

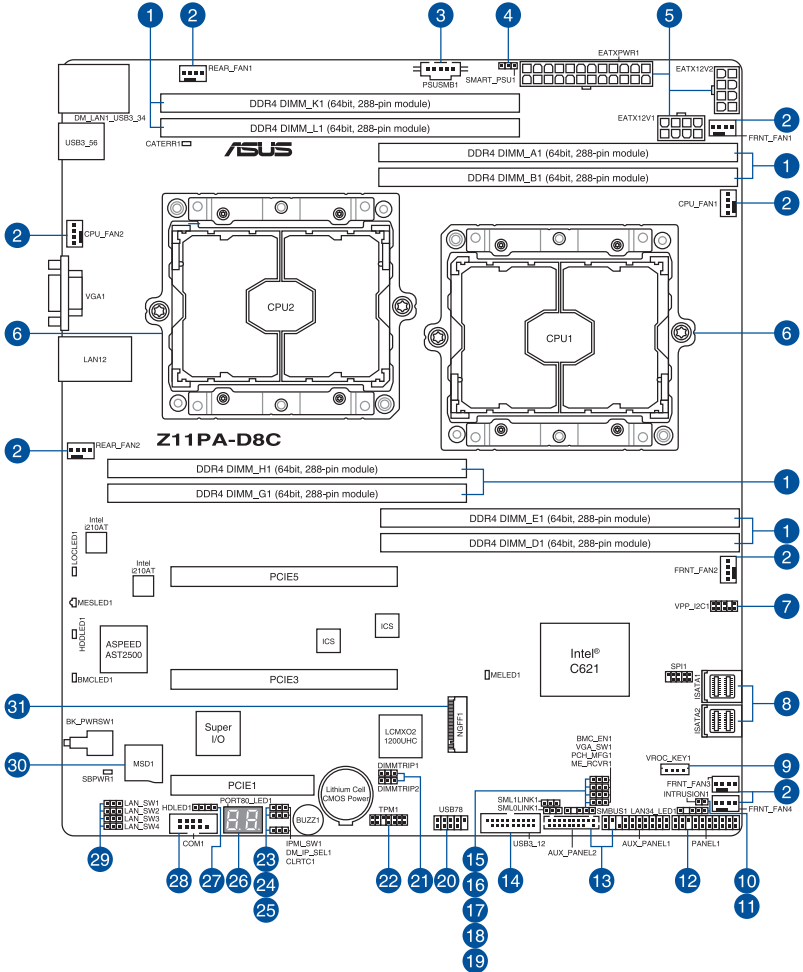

## Layout contents

Internal connectors / Sockets / Jumpers / LEDs	Page
1. DDR4 DIMM sockets	2-8
2. CPU, front, and rear fan connectors (4-pin CPU_FAN1-2; FRNT_FAN1-4; REAR_FAN1-2)	2-28
3. Power Supply SMBus connector (5-pin PSUSMB1)	2-26
4. PMBus 1.2 PSU select jumper (3-pin SMART_PSU1)	2-17
5. EATX power connectors (24-pin EATXPWR1; 8-pin EATX12V1-2)	2-30
6. CPU socket	2-6
7. Mini-SAS HD connector (ISATA1-2)	2-25
8. VPP_I2C1 connector (10-1 pin VPP_I2C1)	2-34
9. VROC KEY connector (4-pin VROC_KEY1)	2-29
10. Chassis Intrusion (2-pin INTRUSION1)	2-33
11. LAN Activity LED connector (5-1 pin LAN34_LED1)	2-35
12. System panel connector (20-1 pin PANEL1)	2-31
13. Auxiliary panel connector (20-2 pin AUX_PANEL1, 20-1 pin AUX_PANEL2)	2-32
14. USB 3.0 connector (20-1 pin USB3_12)	2-27
15. Baseboard Management Controller setting (3-pin BMC_EN1)	2-18
16. VGA controller setting (3-pin VGA_SW1)	2-15
17. PCH_MFG1 setting (3-pin PCH_MFG1)	2-19
18. ME firmware force recovery setting (3-pin ME_RCVR1)	2-16
19. System Management Bus (SMBUS) connector (5-1 pin SMBUS1)	2-34
20. USB 2.0 connector (10-1 pin USB78)	2-27
21. DDR4 thermal event setting (3-pin DIMMTRIP1-2)	2-16
22. Trusted Platform Module connector (14-1 pin TPM1)	2-29
23. IPMI SW setting (3-pin IPMI_SW1)	2-18
24. DMLAN setting (3-pin DM_IP_EN1)	2-17
25. Clear RTC RAM (3-pin CLRTC1)	2-14
26. Q-Code LEDs (PORT80_LED1)	2-23
27. Hard disk activity LED connector (4-pin HDLED1)	2-33
28. Serial port connector (10-1 pin COM1)	2-28
29. LAN controller setting (3-pin LAN_SW1-4)	2-15
30. Micro SD card slot (MSD1)	2-25
31. M.2 (NGFF) connector (NGFF1)	2-26

## 2.3 Central Processing Unit (CPU)

The motherboard comes with a surface mount LGA 3647 socket designed for the Intel® Xeon® Processor Scalable Family Series.



- Upon purchase of the motherboard, ensure that the PnP cap is on the socket and the socket contacts are not bent. Contact your retailer immediately if the PnP cap is missing, or if you see any damage to the PnP cap/socket contacts/motherboard components. ASUS will shoulder the cost of repair only if the damage is shipment/transit-related.
- Keep the cap after installing the motherboard. ASUS will process Return Merchandise Authorization (RMA) requests only if the motherboard comes with the cap on the LGA 3647 socket.
- The product warranty does not cover damage to the socket contacts resulting from incorrect CPU installation/removal, or misplacement/loss/incorrect removal of the PnP cap.

### 2.3.1 Installing the CPU

To install a CPU:

1. Locate the CPU socket on the motherboard.

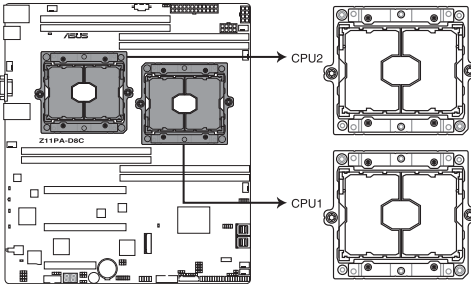

**Z11PA-D8C CPU LGA3647 Socket**

2. Remove the PnP caps from the CPU sockets.

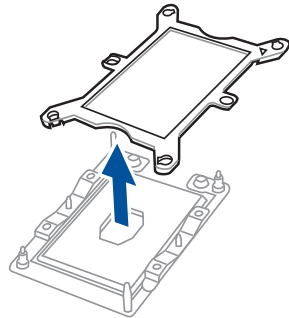



- Align the triangle mark on the CPU with the triangle mark on the CPU Carrier (A), then install the CPU into the CPU Carrier until it clicks firmly into place (B), and then install the CPU Carrier into the heatsink until it clicks firmly in place (C).



Ensure that the triangle mark on the CPU matches the triangle mark on the CPU Carrier.

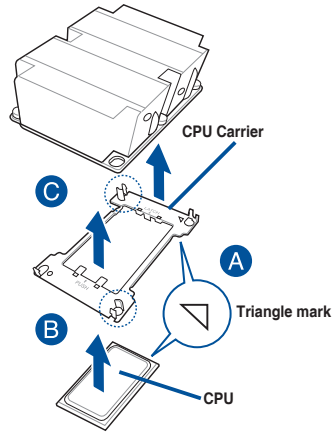

- Align the CPU and CPU Carrier in the correct orientation, and then place the heatsinks on top of the CPU sockets.



The CPU and CPU Carrier fits in only one correct orientation. DO NOT force the CPU and CPU Carrier into the socket to prevent damaging the CPU pins on the socket.

- Twist each of the four screws with a screwdriver just enough to attach the heatsink to the motherboard. When the four screws are attached, tighten them one by one in a diagonal sequence to completely secure the heatsink.



The heatsink screws are T30 models. A torque value of 12 inch-lbf is recommended.

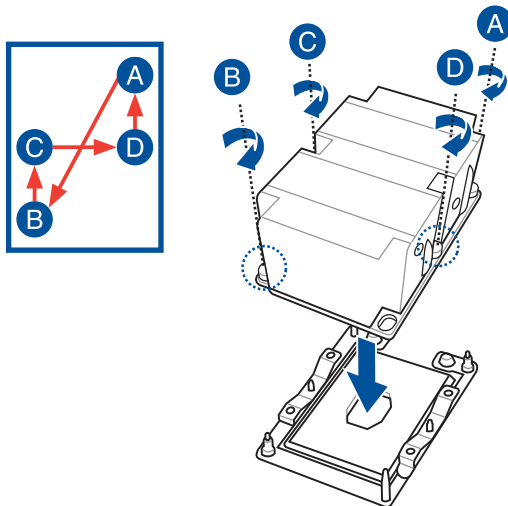

## 2.4 System memory

### 2.4.1 Overview

The motherboard comes with eight (8) Double Data Rate 4 (DDR4) Dual Inline Memory Modules (DIMM) sockets.

The figure illustrates the location of the DDR4 DIMM sockets:

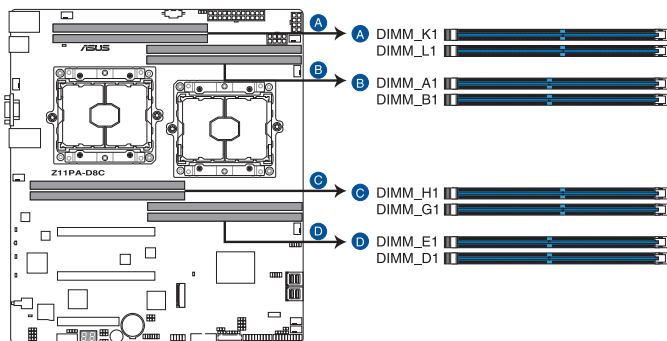

**Z11PA-D8C 288-pin DDR4 DIMM sockets**

### 2.4.2 Memory Configurations

You may install 4 GB, 8 GB, 16 GB, and 32 GB RDIMMs or 32 GB and 64 GB LR-DIMMs into the DIMM sockets using the memory configurations in this section.



- Refer to ASUS Server AVL for the updated list of compatible DIMMs.
- When installing DIMMs, always start from slot A1 (CPU1) and G1 (CPU2).
- Always install DIMMs with the same CAS latency. For optimum compatibility, it is recommended that you obtain memory modules from the same vendor.

## Single CPU configuration

You can refer to the following recommended memory population for a single CPU configuration.

Single CPU configuration (must be installed on CPU1)				
	DIMM			
	A1	B1	D1	E1
1 DIMM	✓			
2 DIMMs	✓	✓		
4 DIMMs	✓	✓	✓	✓

## Dual CPU configuration

You can refer to the following recommended memory population for a dual CPU configuration.

Dual CPU configuration								
	DIMM							
	A1	B1	D1	E1	G1	H1	K1	L1
2 DIMMs	✓				✓			
4 DIMMs	✓	✓			✓	✓		
8 DIMMs	✓	✓	✓	✓	✓	✓	✓	✓

### 2.4.3 Installing a DIMM on a single clip DIMM socket



Ensure to unplug the power supply before adding or removing DIMMs or other system components. Failure to do so may cause severe damage to both the motherboard and the components.

1. Unlock a DIMM socket by pressing the retaining clip outward.
2. Align a DIMM on the socket such that the notch on the DIMM matches the DIMM slot key on the socket.

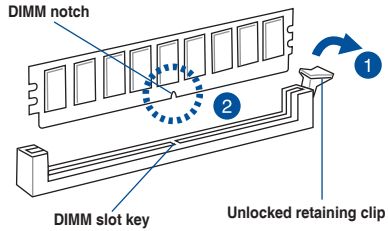

A DIMM is keyed with a notch so that it fits in only one direction. DO NOT force a DIMM into a socket in the wrong direction to avoid damaging the DIMM.

3. Hold the DIMM by both of its ends then insert the DIMM vertically into the socket. Apply force to both ends of the socket simultaneously until the retaining clip snaps back into place and the DIMM cannot be pushed in any further to ensure proper sitting of the DIMM.

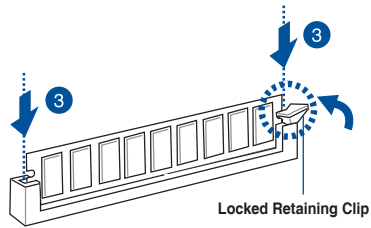

Always insert the DIMM into the socket vertically to prevent DIMM notch damage.

### 2.4.4 Removing a DIMM from a single clip DIMM socket

1. Press the retaining clip outward to unlock the DIMM.
2. Remove the DIMM from the socket.

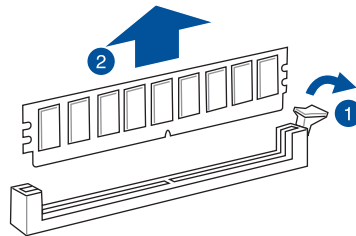

Support the DIMM lightly with your fingers when pressing the retaining clips. The DIMM might get damaged when it flips out with extra force.

## 2.5 Expansion slots

In the future, you may need to install expansion cards. The following subsections describe the slots and the expansion cards that they support.



---

Ensure to unplug the power cord before adding or removing expansion cards. Failure to do so may cause you physical injury and damage motherboard components.

---

### 2.5.1 Installing an expansion card

To install an expansion card:

1. Before installing the expansion card, read the documentation that came with it and make the necessary hardware settings for the card.
2. Remove the system unit cover (if your motherboard is already installed in a chassis).
3. Remove the bracket opposite the slot that you intend to use. Keep the screw for later use.
4. Align the card connector with the slot and press firmly until the card is completely seated on the slot.
5. Secure the card to the chassis with the screw you removed earlier.
6. Replace the system cover.

### 2.5.2 Configuring an expansion card

After installing the expansion card, configure it by adjusting the software settings.

1. Turn on the system and change the necessary BIOS settings, if any. See **Chapter 4** for information on BIOS setup.
2. Assign an IRQ to the card.



---

Refer to the table **Standard Interrupt assignments** in section **Interrupt assignments** for more information.

---

3. Install the software drivers for the expansion card.



---

When using PCI cards on shared slots, ensure that the drivers support “Share IRQ” or that the cards do not need IRQ assignments. Otherwise, conflicts may arise between the two PCI groups, making the system unstable and the card inoperable.

---

## 2.5.3 Interrupt assignments

### Standard Interrupt assignments

IRQ	Priority	Standard function
0	1	System Timer
1	2	Keyboard Controller
2	-	Programmable Interrupt
3*	11	Communications Port (COM2)
4*	12	Communications Port (COM1)
5*	13	--
6	14	Floppy Disk Controller
7*	15	--
8	3	System CMOS/Real Time Clock
9*	4	ACPI Mode when used
10*	5	IRQ Holder for PCI Steering
11*	6	IRQ Holder for PCI Steering
12*	7	PS/2 Compatible Mouse Port
13	8	Numeric Data Processor
14*	9	Primary IDE Channel
15*	10	Secondary IDE Channel

\* These IRQs are usually available for ISA or PCI devices.

## 2.5.4 PCI Express x16 slot (x16 link)

The onboard PCIE3 and PCIE5 slots provides one x16 Gen3 link to CPU1. This slot supports VGA cards and various server class high performance add-on cards.

## 2.5.5 PCI Express x8 slot (x8 link)

The onboard PCIE1 slot provides one x8 Gen3 link to CPU2. These slots support VGA cards and various server class high performance add-on cards.

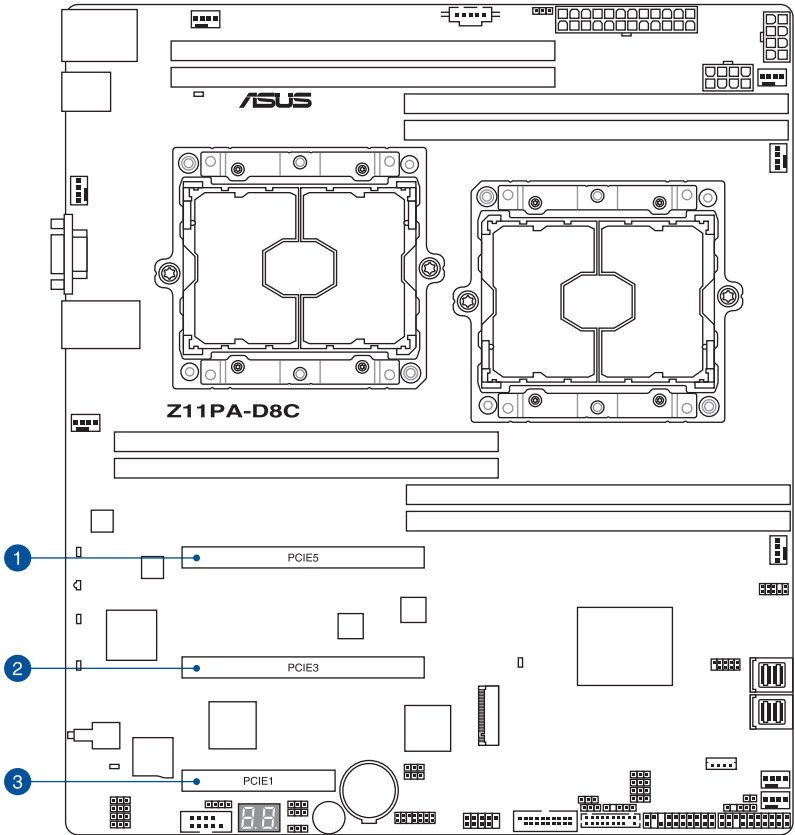

Slot	Short description
PCI-E5	PCI-E x16 (x16 Gen3 Link)
PCI-E3	PCI-E x16 (x16 Gen3 Link)
PCI-E1	PCI-E x8 (x8 Gen3 Link)

# 2.6 Jumpers

## 1. Clear RTC RAM (3-pin CLRTC1)

This jumper allows you to clear the Real Time Clock (RTC) RAM in CMOS. You can clear the CMOS memory of date, time, and system setup parameters by erasing the CMOS RTC RAM data. The onboard button cell battery powers the RAM data in CMOS which include system setup information such as system passwords.

To erase the RTC RAM:

1. Turn OFF the computer and unplug the power cord.
2. Move the jumper cap from the default pins 1–2 to pins 2–3. Keep the cap on pins 2–3 for about 5 to 10 seconds, then move the cap back to pins 1–2.
3. Plug the power cord and turn ON the computer.
4. Hold down the <Del> key during the boot process and enter BIOS setup to re-enter data.



DO NOT remove the cap on CLRTC jumper default position except when clearing the RTC RAM. Removing the cap will cause system boot failure!



If the steps above do not help, remove the onboard battery and move the jumper again to clear the CMOS RTC RAM data. After the CMOS clearance, reinstall the battery.

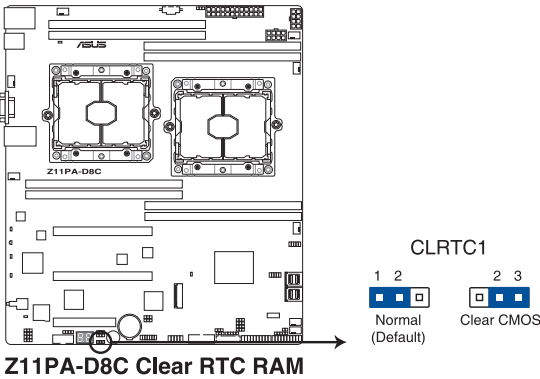



## 2. VGA controller setting (3-pin VGA\_SW1)

This jumper allows you to enable or disable the onboard VGA controller. Set to pins 1-2 to activate the VGA feature.

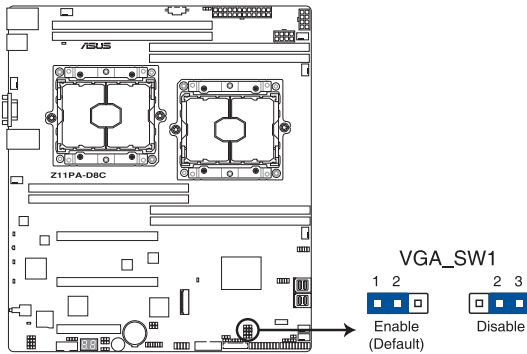

**Z11PA-D8C VGA setting**

## 3. LAN controller setting (3-pin LAN\_SW1-4)

These jumpers allow you to enable or disable the onboard LAN\_SW1-4. Set to pins 1-2 to activate the Gigabit LAN feature.

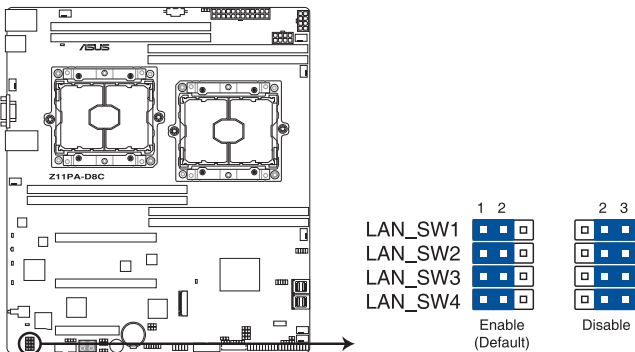

**Z11PA-D8C LAN setting**

**4. ME firmware force recovery setting (3-pin ME\_RCVR1)**

This jumper allows you to force Intel® Management Engine (ME) boot from recovery mode when ME becomes corrupted.

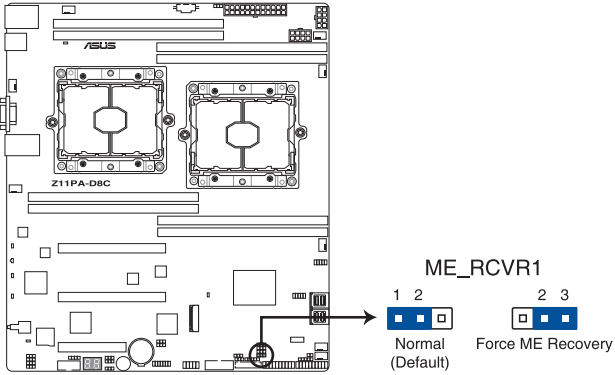

**Z11PA-D8C ME recovery setting**

**5. DDR4 thermal event setting (3-pin DIMMTRIP1-2)**

This jumper allows you to enable or disable DDR4 DIMM thermal sensing event pin.

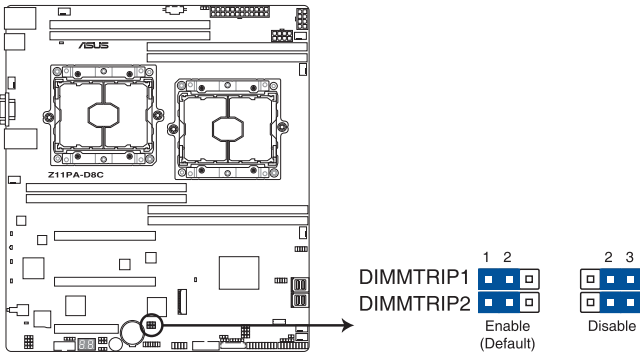

**Z11PA-D8C Thermaltrip setting**

## 6. PMBus 1.2 PSU select jumper (3-pin SMART\_PSU1)

This jumper allows you to select PSU PMBus version. Set to pins 1–2 for PMBus, set to pins 2–3 for others.

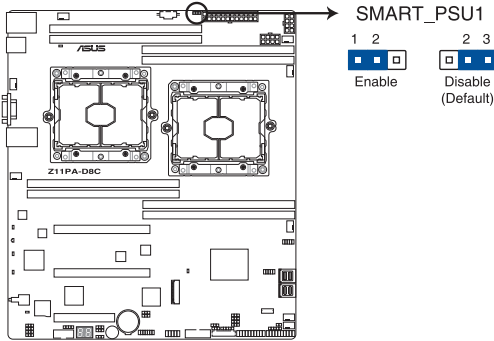

**Z11PA-D8C Smart Ride Through setting**

## 7. DMLAN setting (3-pin DM\_IP\_EN1)

This jumper allows you to select the DMLAN setting. Set to pins 2-3 to force the DMLAN IP to static mode (IP=10.10.10.10, submask=255.255.255.0).

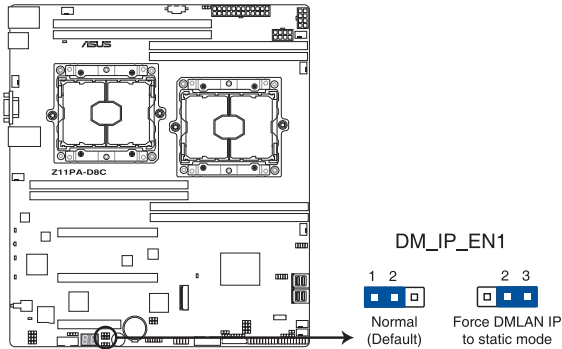

**Z11PA-D8C DM\_IP\_EN1 setting**

**8. IPMI SW setting (3-pin IPMI\_SW1)**

This jumper allows you to select which protocol in the GPU sensor to function.

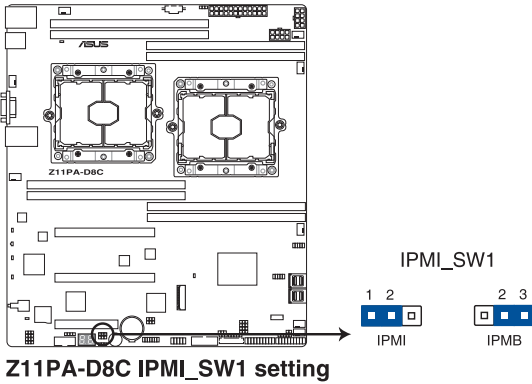

**9. Baseboard Management Controller setting (3-pin BMC\_EN1)**

This jumper allows you to enable (default) or disable on-board BMC. Ensure to set this BMC jumper to enabled to avoid system fan control and hardware monitor error.

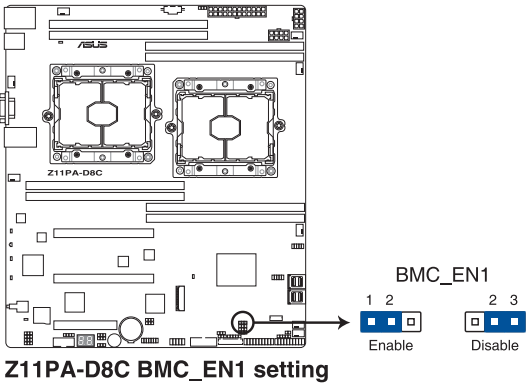

## 10. PCH\_MFG1 setting (3-pin PCH\_MFG1)

This jumper allows you to update the BIOS ME block.

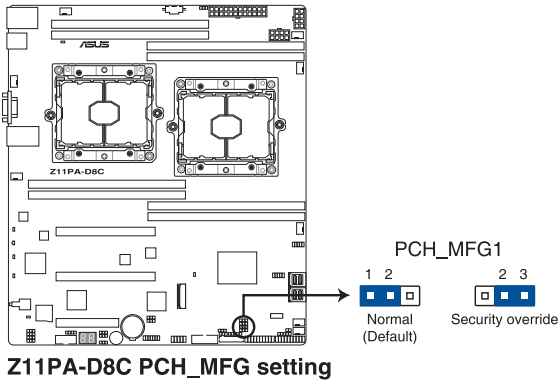

## 2.7 Onboard LEDs

### 1. Standby Power LED (SB\_PWR1)

The motherboard comes with a standby power LED. The green LED lights up to indicate that the system is ON, in sleep mode, or in soft-off mode. This is a reminder that you should shut down the system and unplug the power cable before removing or plugging in any motherboard component. The illustration below shows the location of the onboard LED.

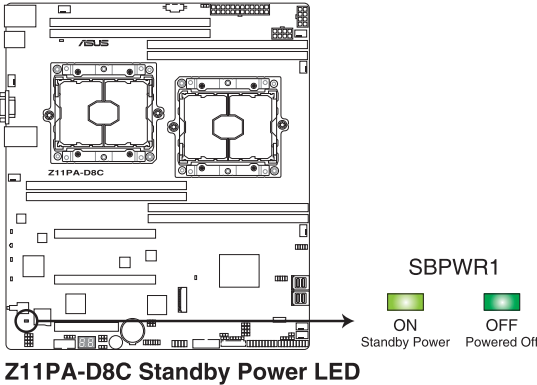

### 2. BMC LED (BMCLED1)

The BMC LED blinks to indicate that the on-board BMC is functional.

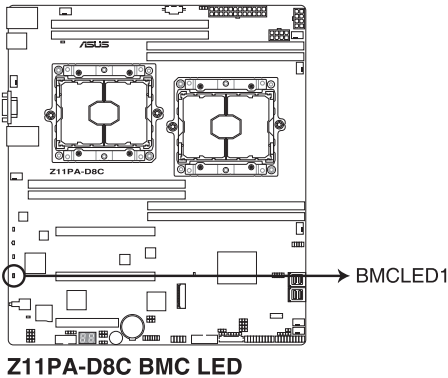

### 3. Storage device activity LED (HDDLED1)

This LED is for the storage devices connected to the onboard SATA, or SATA/SAS add-on card. The read or write activities of any device connected to the onboard SATA, or SATA/SAS add-on card causes the rear panel LED to light up.

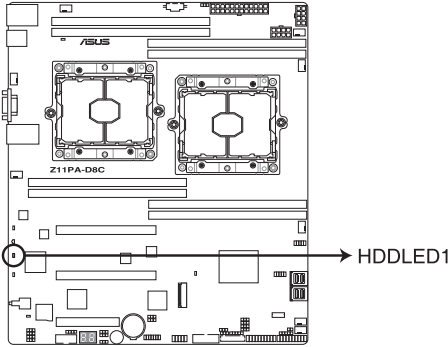

**Z11PA-D8C Storage device activity LED**

### 4. Location LED (LOCLEAD1)

This onboard LED lights up when the Location button on the server is pressed or when triggered by a system management software. The Location LED helps visually locate and quickly identify the server in error on a server rack.

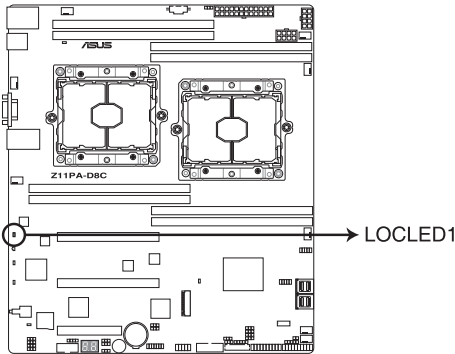

**Z11PA-D8C Location LED**

**5. Message LED (MESLED1)**

This onboard LED lights up to red when there is a BMC event log is generated.

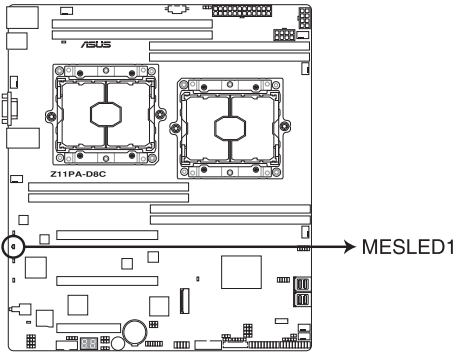

**Z11PA-D8C MESLED**

**6. CATTLED (CATTERR\_LED1)**

The CATTLED indicates that the system has experienced a fatal or catastrophic error and cannot continue to operate.

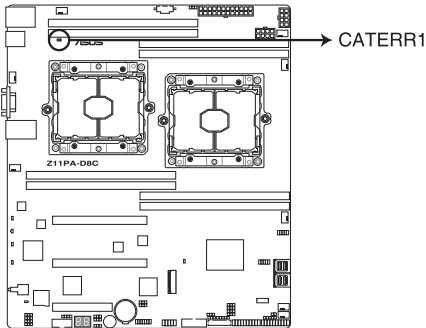

**Z11PA-D8C CATTERR LED**



## 7. Q-Code LEDs (PORT80\_LED1)

The Q-Code LED design provides you with a 2-digit error code that displays the system status.

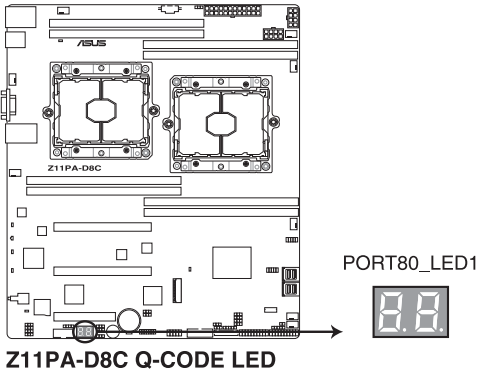

- 
- The Q-Code LEDs provide the most probable cause of an error code as a starting point for troubleshooting. The actual cause may vary from case to case.
  - Please refer to the Q-Code table in the **Appendix** section for more details.
-

## 2.8 Connectors

### 2.8.1 Rear panel connectors

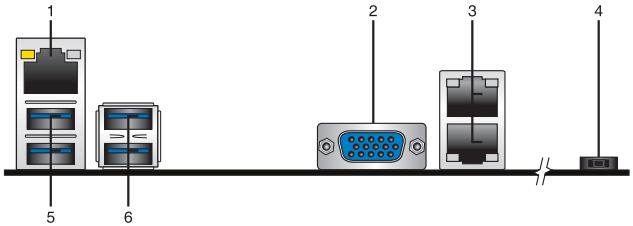

1. RJ-45 port for iKVM. This RJ-45 port functions only when you enable ASMB9 controller.
2. Video Graphics Adapter (VGA) port. This port is for a VGA monitor or other VGA-compatible devices.
3. RJ-45 ports 1 and 2 for LAN. These ports allows Gigabit connection to a LAN through a network hub. Refer to the **LAN port LED indications** table for more information.
4. Power-on Button. Press this button to turn on the system.
5. USB 3.0 ports 3 and 4. These two 4-pin Universal Serial Bus (USB) ports are available for connecting USB 3.0 devices.
6. USB 3.0 ports 5 and 6. These two 4-pin Universal Serial Bus (USB) ports are available for connecting USB 3.0 devices.

#### LAN port LED indications

Activity/Link LED		Speed LED	
Status	Description	Status	Description
OFF	No link	OFF	10 Mbps connection
GREEN	Linked	ORANGE	100 Mbps connection
BLINKING	Data activity	GREEN	1 Gbps connection

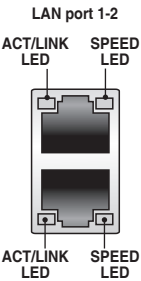

#### Management LAN port LED indications

Activity/Link LED		Speed LED	
Status	Description	Status	Description
OFF	No link	OFF	10 Mbps connection
ORANGE	Linked	ORANGE	100 Mbps connection
BLINKING	Data activity	GREEN	1 Gbps connection

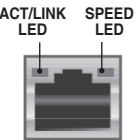

## 2.8.2 Internal connectors

### 1. Mini-SAS HD connector (ISATA1-2)

This motherboard comes with mini Serial Attached SCSI (SAS) HD connectors, the storage technology that supports Serial ATA. Each connector supports up to four devices.

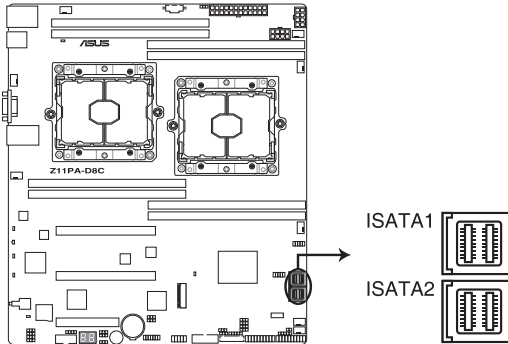

**Z11PA-D8C ISATA connectors**

### 2. Micro SD card slot (MSD1)

Your motherboard supports SD Memory Card v2.00 (SDHC) / v3.00 (SDXC).

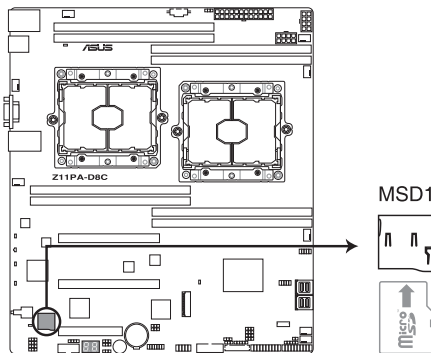

**Z11PA-D8C MSD1**



Disconnect all power (including redundant PSUs) from the existing system before you add or remove a Memory Card, then reboot the system to access the Memory Card.



Some memory cards may not be compatible with your motherboard. Ensure that you use only compatible memory cards to prevent loss of data, damage to your device, or memory card, or both.

### 3. Power Supply SMBus connector (5-pin PSUSMB1)

This connector allows you to connect SMBus (System Management Bus) to the PSU (power supply unit) to read PSU information. Devices communicate with an SMBus host and/or other SMBus devices using the SMBus interface.

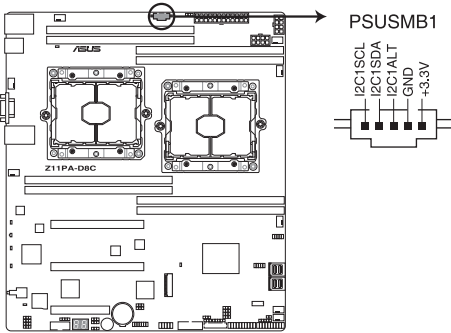

**Z11PA-D8C Power supply SMBus connector**



---

This connector functions only when you install the ASUS ASMB8.

---



---

Power supply is required to meet PMBus specification and customized BMC FW may be needed. Please contact ASUS if your need further support.

---

### 4. M.2 (NGFF) connector (NGFF1)

These connector allows you to install an M.2 device.

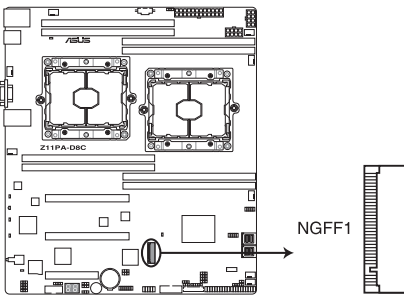

**Z11PA-D8C NGFF connectors**



---

This connector supports type 22110 devices on both PCI-E and SATA interface.

---



---

The M.2 (NGFF) device is purchased separately.

---

## 5. USB 2.0 connector (10-1 pin USB78)

This connector is for USB 2.0 ports. Connect the USB module cable to the connector, and then install the module to a slot opening at the back of the system chassis. The USB connectors comply with USB 2.0 specification that supports up to 480 Mbps connection speed.

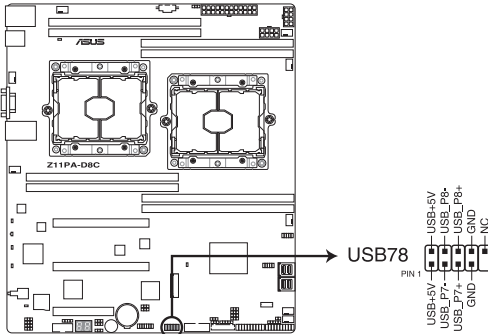

**Z11PA-D8C USB 2.0 connector**

## 6. USB 3.0 connector (20-1 pin USB3\_12)

This connector allows you to connect a USB 3.0 module for additional USB 3.0 front or rear panel ports. With an installed USB 3.0 module, you can enjoy all the benefits of USB 3.0 including faster data transfer speeds of up to 5Gbps, faster charging time for USB-chargeable devices, optimized power efficiency, and backward compatibility with USB 2.0.

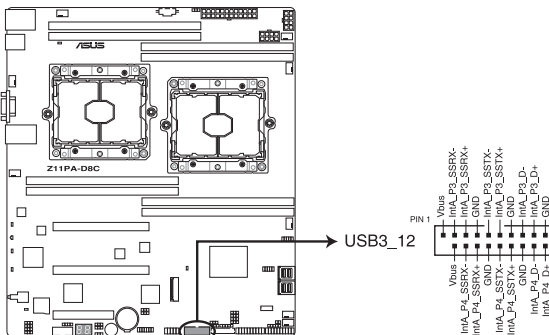

**Z11PA-D8C USB 3.0 connector**

## 7. CPU, front, and rear fan connectors (4-pin CPU\_FAN1-2; FRNT\_FAN1-4; REAR\_FAN1-2)

The fan connectors support cooling fans. Connect the fan cables to the fan connectors on the motherboard, ensuring that the black wire of each cable matches the ground pin of the connector.



- DO NOT forget to connect the fan cables to the fan connectors. Insufficient air flow inside the system may damage the motherboard components.
- These are not jumpers! DO NOT place jumper caps on the fan connectors!
- All fans feature the ASUS Smart Fan technology.

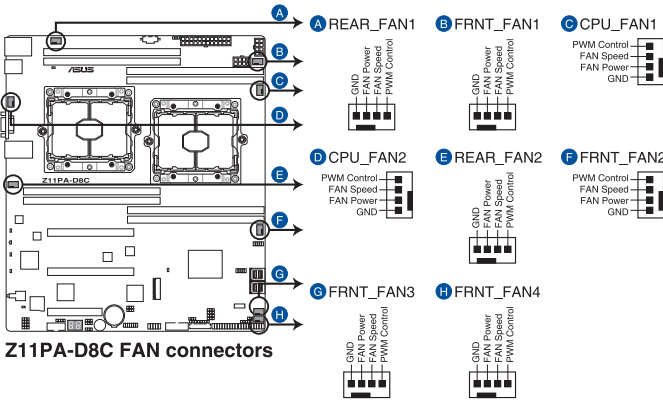

## 8. Serial port connector (10-1 pin COM1)

This connector is for the serial COM port. Connect the serial port module cable to one of these connectors, then install the module to a slot opening at the back of the system chassis.

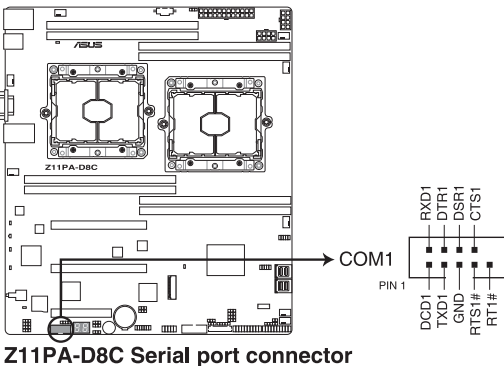

### 9. Trusted Platform Module connector (14-pin TPM1)

This connector supports a Trusted Platform Module (TPM) system, which can securely store keys, digital certificates, passwords, and data. A TPM system also helps enhance network security, protects digital identities, and ensures platform integrity.

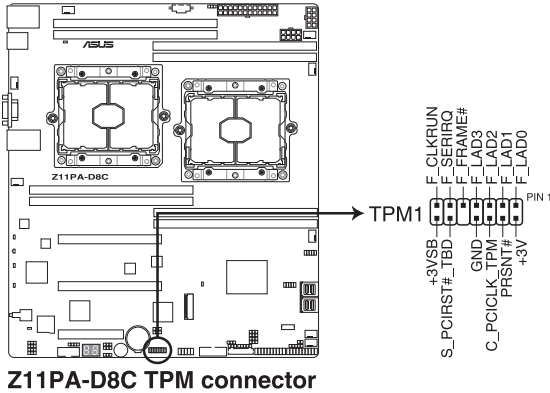

### 10. VROC KEY connector (4-pin VROC\_KEY1)

This connector allows you to connect a KEY module to enable additional CPU RAID functions with Intel® CPU RSTe.

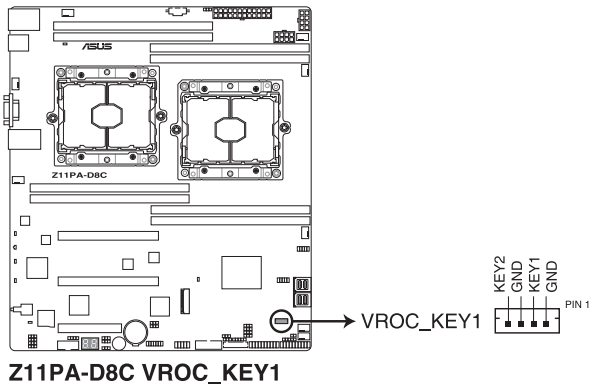

The KEY module is purchased separately.





## 12. System panel connector (20-1 pin PANEL1)

This connector supports several chassis-mounted functions.

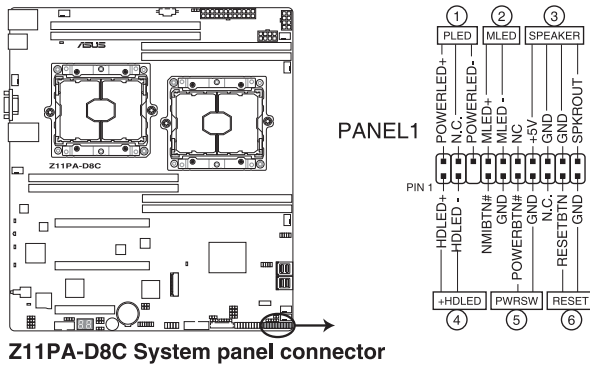

### 1. System power LED (3-pin PLED)

This 3-pin connector is for the system power LED. Connect the chassis power LED cable to this connector. The system power LED lights up when you turn on the system power, and blinks when the system is in sleep mode.

### 2. Message LED (2-pin MLED)

This 2-pin connector is for the message LED cable that connects to the front message LED. The message LED is controlled by Hardware monitor to indicate an abnormal event occurrence.

### 3. System warning speaker (4-pin SPEAKER)

This 4-pin connector is for the chassis-mounted system warning speaker. The speaker allows you to hear system beeps and warnings.

### 4. Hard disk drive activity LED (2-pin HDD LED)

This 2-pin connector is for the HDD Activity LED. Connect the HDD Activity LED cable to this connector. The HDD LED lights up or flashes when data is read from or written to the HDD.

### 5. Power button/soft-off button (2-pin PWRSW)

This connector is for the system power button. Pressing the power button turns the system on or puts the system in sleep or soft-off mode depending on the BIOS settings. Pressing the power switch for more than four seconds while the system is ON turns the system OFF.

### 6. Reset button (2-pin RESET)

This 2-pin connector is for the chassis-mounted reset button for system reboot without turning off the system power.



#### 14. Hard disk activity LED connector (4-pin HDLED1)

This LED connector is for the storage add-on card cable connected to the SATA or SAS add-on card. The read or write activities of any device connected to the SATA or SAS add-on card causes the front panel LED to light up.

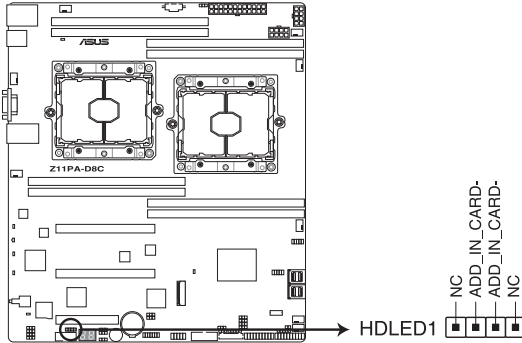

**Z11PA-D8C Storage device activity LED connector**

#### 15. Chassis Intrusion (2-pin INTRUSION1)

These leads are for the intrusion detection feature for chassis with intrusion sensor or microswitch. When you remove any chassis component, the sensor triggers and sends a high level signal to these leads to record a chassis intrusion event. The default setting is short CHASSIS# and GND pin by jumper cap to disable the function.

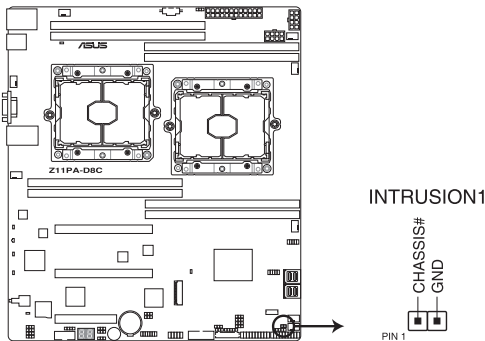

**Z11PA-D8C Chassis Intrusion connectors**

**16. System Management Bus (SMBUS) connector (5-1 pin SMBUS1)**

This connector controls the system and power management-related tasks. This connector processes the messages to and from devices rather than tripping the individual control lines.

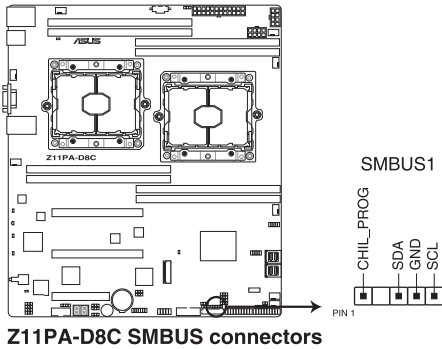

**17. VPP\_I2C1 connector (10-1 pin VPP\_I2C1)**

This connector is used for the Intel VMD function and sensor readings.

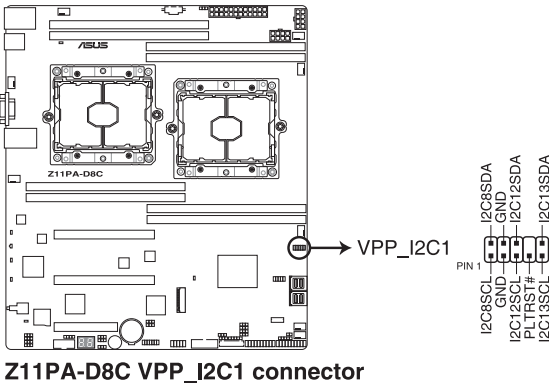

**18. LAN Activity LED connector (5-1 pin LAN34\_LED1)**

These leads are for LAN activity LEDs on the front panel. Connect the LAN LED cable to the backplane for LAN activity indication.

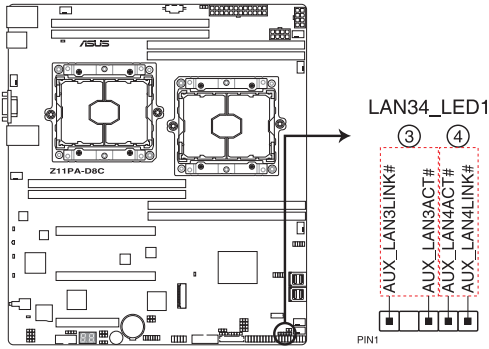

**Z11PA-D8C LAN3 & LAN4 LED**



# Powering Up

# 3

This chapter describes the power up sequence, and ways of shutting down the system.

### 3.1 Starting up for the first time

1. After making all the connections, replace the system case cover.
2. Be sure that all switches are off.
3. Connect the power cord to the power connector at the back of the system chassis.
4. Connect the power cord to a power outlet that is equipped with a surge protector.
5. Turn on the devices in the following order:
  - a. Monitor
  - b. External storage devices (starting with the last device on the chain)
  - c. System power
6. After applying power, the system power LED on the system front panel case lights up. For systems with ATX power supplies, the system LED lights up when you press the ATX power button. If your monitor complies with “green” standards or if it has a “power standby” feature, the monitor LED may light up or switch between orange and green after the system LED turns on.

The system then runs the power-on self-test or POST. While the tests are running, the BIOS beeps or additional messages appear on the screen. If you do not see anything within 30 seconds from the time you turned on the power, the system may have failed a power-on test. Check the jumper settings and connections or call your retailer for assistance.

The following shows the possible beep codes and its corresponding error condition

BIOS Beep codes	
Beep	Error condition
1 short	Power supply surges detected during the previous power on.
1 short	No Keyboard Detected.
1 short, 2 short	No DIMM Detected.
1 short, 8 short	No VGA Detected.
2 long	Chassis Intrusion.
2 long	BIOS-image Crash Detected.

7. At power on, hold down the <Del> key to enter the BIOS Setup. Follow the instructions in Chapter 4.



## 3.2 Powering off the computer

### 3.2.1 Using the OS shut down function

#### Using Windows® Server 2012 R2:

1. Press <Ctrl>+<Alt>+<Del>.
2. Click on the Power icon on the lower right side of the screen.
3. Select **Shut down**.
4. In the *Shutdown Event Tracker*, select the **Other (Planned)** option in the selection list. Otherwise, select the option that best describes why you want to shut down the computer.
5. Click **Continue**.

#### Using Windows® Server 2016:

1. Press <Alt>+<F4>.
2. In the *What do you want the computer to do?*, select **Shut down**.
3. In the *Shutdown Event Tracker*, select the **Other (Planned)** option in the selection list. Otherwise, select the option that best describes why you want to shut down the computer.
4. Click **OK**.

### 3.2.2 Using the dual function power switch

While the system is ON, press the power switch for less than four seconds to put the system to sleep mode or to soft-off mode, depending on the BIOS setting.



---

Pressing the power switch for more than four seconds lets the system enter the soft-off mode regardless of the BIOS setting.

---



# **BIOS Setup**

# 4

This chapter tells how to change the system settings through the BIOS Setup menus. Detailed descriptions of the BIOS parameters are also provided.

## 4.1 Managing and updating your BIOS

The following utilities allow you to manage and update the motherboard Basic Input/Output System (BIOS) setup:

1. **ASUS CrashFree BIOS 3**

To recover the BIOS using a bootable USB flash disk drive when the BIOS file fails or gets corrupted.

2. **ASUS EzFlash**

Updates the BIOS using a USB flash disk.

3. **BUPDATER**

Updates the BIOS in DOS mode using a bootable USB flash disk drive.

Refer to the corresponding sections for details on these utilities.



---

Save a copy of the original motherboard BIOS file to a bootable USB flash disk drive in case you need to restore the BIOS in the future. Copy the original motherboard BIOS using the BUPDATER utility.

---

### 4.1.1 ASUS CrashFree BIOS 3 utility

The ASUS CrashFree BIOS 3 is an auto recovery tool that allows you to restore the BIOS file when it fails or gets corrupted during the updating process. You can update a corrupted BIOS file using a USB flash drive that contains the updated BIOS file.



---

Prepare a USB flash drive containing the updated motherboard BIOS before using this utility.

---

### Recovering the BIOS from a USB flash drive

To recover the BIOS from a USB flash drive:

1. Insert the USB flash drive with the original or updated BIOS file to one USB port on the system.
2. The utility will automatically recover the BIOS. It resets the system when the BIOS recovery finished.



---

**DO NOT** shut down or reset the system while recovering the BIOS! Doing so would cause system boot failure!

---



---

The recovered BIOS may not be the latest BIOS version for this motherboard. Visit the ASUS website at [www.asus.com](http://www.asus.com) to download the latest BIOS file.

---

## 4.1.2 ASUS EZ Flash Utility

The ASUS EZ Flash Utility feature allows you to update the BIOS without having to use a DOS-based utility.



Before you start using this utility, download the latest BIOS from the ASUS website at [www.asus.com](http://www.asus.com).

To update the BIOS using EZ Flash Utility:

1. Insert the USB flash disk that contains the latest BIOS file into the USB port.
2. Enter the BIOS setup program. Go to the **Tool** menu then select **ASUS EZ Flash Utility**. Press <Enter>.

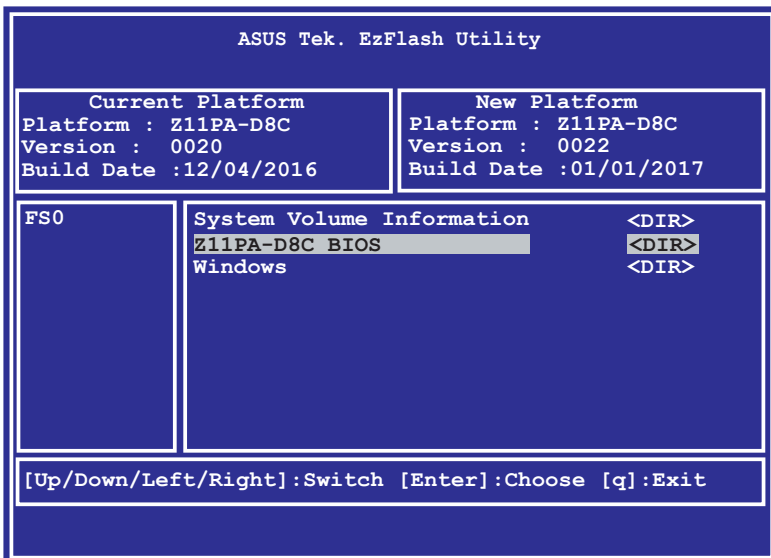

3. Press <Tab> to switch to the **Drive** field.
4. Press the Up/Down arrow keys to find the USB flash disk that contains the latest BIOS, then press <Enter>.
5. Press <Tab> to switch to the **Folder Info** field.

6. Press the Up/Down arrow keys to find the BIOS file, and then press <Enter> to perform the BIOS update process. Reboot the system when the update process is done.



- This function can support devices such as a USB flash disk with FAT 32/16 format and single partition only.
- DO NOT shut down or reset the system while updating the BIOS to prevent system boot failure!



Ensure to load the BIOS default settings to ensure system compatibility and stability. Press <F5> and select **Yes** to load the BIOS default settings.

### 4.1.3 BUPDATER utility



The succeeding BIOS screens are for reference only. The actual BIOS screen displays may not be the same as shown.

The BUPDATER utility allows you to update the BIOS file in the DOS environment using a bootable USB flash disk drive with the updated BIOS file.

#### Updating the BIOS file

To update the BIOS file using the BUPDATER utility:

1. Visit the ASUS website at [www.asus.com](http://www.asus.com) and download the latest BIOS file for the motherboard. Save the BIOS file to a bootable USB flash disk drive.
2. Copy the BUPDATER utility (BUPDATER.exe) from the ASUS support website at <https://www.asus.com/support> to the bootable USB flash disk drive you created earlier.
3. Boot the system in DOS mode, then at the prompt, type:

```
BUPDATER /i [filename] .CAP
```

where [filename] is the latest or the original BIOS file on the bootable USB flash disk drive, then press <Enter>.

```
A:\>BUPDATER /i[file name].CAP
```

- The utility verifies the file, then starts updating the BIOS file.

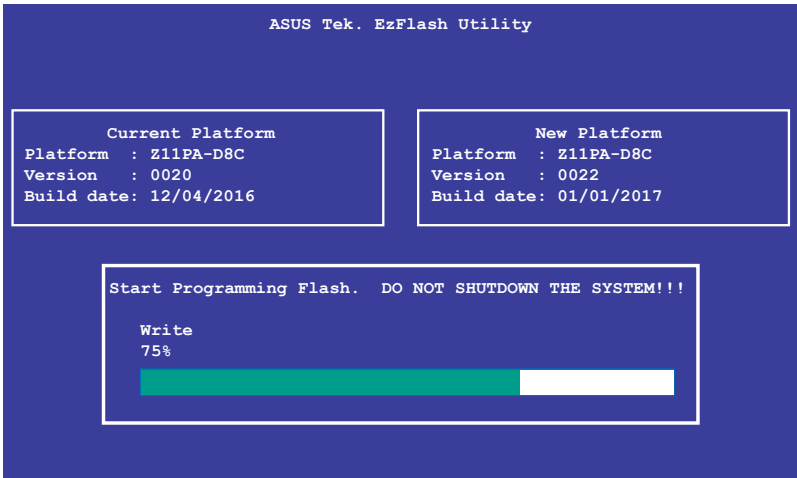

---

DO NOT shut down or reset the system while updating the BIOS to prevent system boot failure!

---

- The utility returns to the DOS prompt after the BIOS update process is completed. Reboot the system from the hard disk drive.

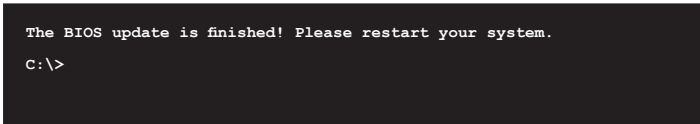

## 4.2 BIOS setup program

This motherboard supports a programmable firmware chip that you can update using the provided utility described in section **4.1 Managing and updating your BIOS**.

Use the BIOS Setup program when you are installing a motherboard, reconfiguring your system, or prompted to “Run Setup.” This section explains how to configure your system using this utility.

Even if you are not prompted to use the Setup program, you can change the configuration of your computer in the future. For example, you can enable the security password feature or change the power management settings. This requires you to reconfigure your system using the BIOS Setup program so that the computer can recognize these changes and record them in the CMOS RAM of the firmware chip.

The firmware chip on the motherboard stores the Setup utility. When you start up the computer, the system provides you with the opportunity to run this program. Press <Del> during the Power-On Self-Test (POST) to enter the Setup utility; otherwise, POST continues with its test routines.

If you wish to enter Setup after POST, restart the system by pressing <Ctrl>+<Alt>+<Delete>, or by pressing the reset button on the system chassis. You can also restart by turning the system off and then back on. Do this last option only if the first two failed.

The Setup program is designed to make it as easy to use as possible. Being a menu-driven program, it lets you scroll through the various sub-menus and make your selections from the available options using the navigation keys.



- 
- The default BIOS settings for this motherboard apply for most conditions to ensure optimum performance. If the system becomes unstable after changing any BIOS settings, load the default settings to ensure system compatibility and stability. Press <F5> and select **Yes** to load the BIOS default settings.
  - The BIOS setup screens shown in this section are for reference purposes only, and may not exactly match what you see on your screen.
  - Visit the ASUS website ([www.asus.com](http://www.asus.com)) to download the latest BIOS file for this motherboard.
-



## 4.2.1 BIOS menu screen

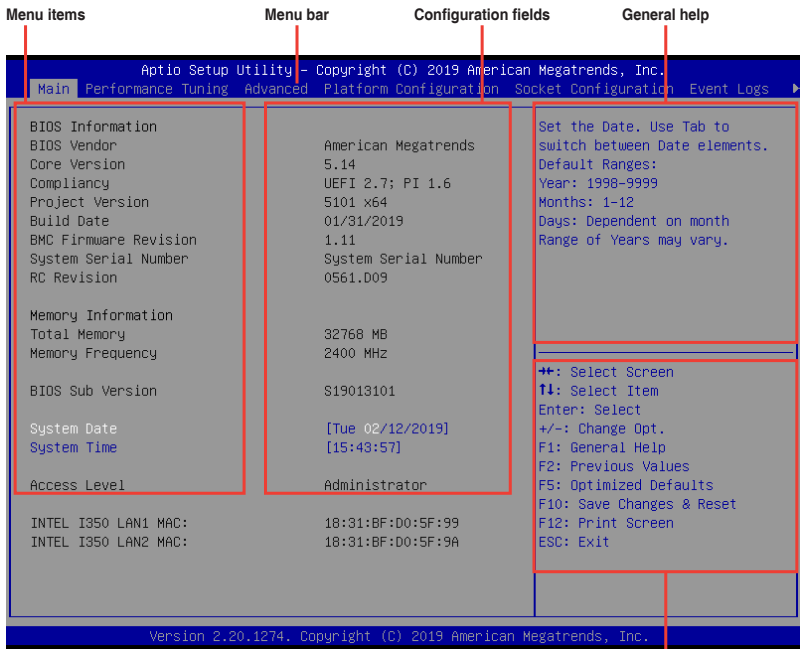

## 4.2.2 Menu bar

Navigation keys

The menu bar on top of the screen has the following main items:

<b>Main</b>	For changing the basic system configuration
<b>Performance Tuning</b>	For changing the performance settings
<b>Advanced</b>	For changing the advanced system settings
<b>Platform Configuration</b>	For changing the platform settings
<b>Socket Configuration</b>	For changing the socket settings
<b>Event Logs</b>	For changing the event log settings
<b>Server Mgmt</b>	For changing the Server Mgmt settings
<b>Security</b>	For changing the security settings
<b>Boot</b>	For changing the system boot configuration
<b>Tool</b>	For configuring options for special functions
<b>Save &amp; Exit</b>	For selecting the exit options

To select an item on the menu bar, press the right or left arrow key on the keyboard until the desired item is highlighted.

### **4.2.3 Menu items**

The highlighted item on the menu bar displays the specific items for that menu. For example, selecting **Main** shows the Main menu items.

The other items (such as **Advanced**) on the menu bar have their respective menu items.

### **4.2.4 Submenu items**

A solid triangle before each item on any menu screen means that the item has a submenu. To display the submenu, select the item then press <Enter>.

### **4.2.5 Navigation keys**

At the bottom right corner of a menu screen are the navigation keys for the BIOS setup program. Use the navigation keys to select items in the menu and change the settings.

### **4.2.6 General help**

At the top right corner of the menu screen is a brief description of the selected item.

### **4.2.7 Configuration fields**

These fields show the values for the menu items. If an item is user-configurable, you can change the value of the field opposite the item. You cannot select an item that is not user-configurable.

A configurable field is enclosed in brackets, and is highlighted when selected. To change the value of a field, select it and press <Enter> to display a list of options.

### **4.2.8 Pop-up window**

Select a menu item and press <Enter> to display a pop-up window with the configuration options for that item.

### **4.2.9 Scroll bar**

A scroll bar appears on the right side of a menu screen when there are items that do not fit on the screen. Press the Up/Down arrow keys or <Page Up> / <Page Down> keys to display the other items on the screen.

## 4.3 Main menu

When you enter the BIOS Setup program, the Main menu screen appears. The Main menu provides you an overview of the basic system information, and allows you to set the system date, time, language, and security settings.

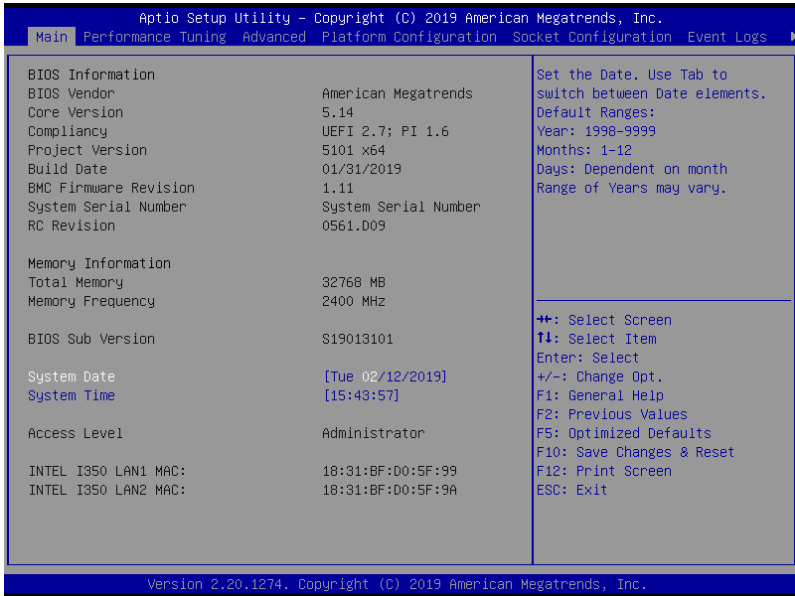

### 4.3.1 System Date [Day xx/xx/xxxx]

Allows you to set the system date.

### 4.3.2 System Time [xx:xx:xx]

Allows you to set the system time.

## 4.4 Performance Tuning menu

The Performance Tuning menu items allow you to change performance related settings for different scenarios.

Setting	Value	Description
Optimized Performance Setting	[Default]	The following setting shows the recommended BIOS setting to optimize for performance includes those performance-related BIOS
Core Optimizer	[Disabled]	
Engine Boost	[Disabled]	
Overclocking	[Disabled]	
Power Balancer	[Disabled]	

### Optimized Performance Setting [Default]

Allows you to select performance settings for different scenarios.

[Default] Default settings.

[By Benchmark] Optimize for different kinds of benchmarks. Select this option, then select a benchmark type from the >> list.

[By Workload] Optimize for different kinds of workloads. Select this option, then select a workload type from the >> list.

Configuration options:

**[Peak Frequency Optimized]** - Applies settings with performance and power consumption balance. Recommended for users that need higher performance.

**[Latency Optimized]** - Applies settings with low latency results. Recommended for latency-sensitive users.

**[Power Efficient Optimized]** - Applies settings with power efficiency. Recommended for general users.

**[HPC]** - Applies settings with optimized compute capability. Recommend for traditional HPC applications.



---

**Core Optimizer** and **Engine Boost** appear only when you set **Optimized Performance Setting** to **[Default]** or **[By Benchmark]**.

---

### Core Optimizer [Disabled]

Enable this item to keep the processor operating at the turbo frequency.

Configuration options: [Disabled] [Enabled]



---

Linux support may vary by version of the OS.

---

### Engine Boost [Disabled]

Enable this item to boost the CPU's frequency.

Configuration options: [Disabled] [Level1] [Level2] [Level3(Max)]

## Overclocking [Disabled]

Enable this item to increase the CPU's clock.

Configuration options: [Disabled] [Level1] [Level2] [Level3(Max)]



Operate with an ambient temperature of 25°C or lower for optimized performance.



Please note that overclocking might cause component damage or system crashes, which may reduce the lifespan of the system and the CPU. Use this tool at your own risk.

## Power Balancer [Disabled]

Select [Enable Auto] to dynamically adjust the frequency of all CPU cores based on the current utilization, delivering better performance per watt for improved system energy efficiency.

Configuration options: [Disabled] [Enable Auto] [Enable Manual]

## 4.5 Advanced menu

The Advanced menu items allow you to change the settings for the CPU and other system devices.



Take caution when changing the settings of the Advanced menu items. Incorrect field values can cause the system to malfunction.

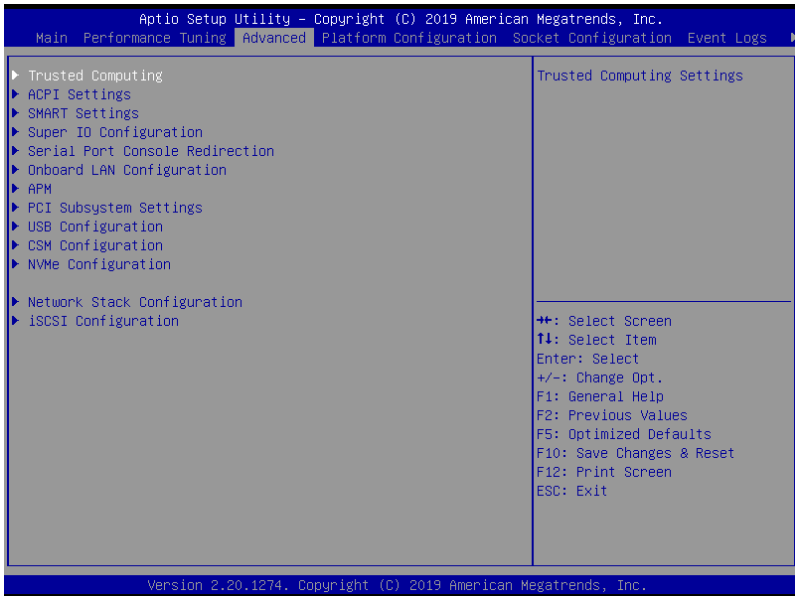

## 4.5.1 Trusted Computing

Aptio Setup Utility - Copyright (C) 2019 American Megatrends, Inc.	
Advanced	
Configuration	
Security Device Support [Enabled]	Enables or Disables BIOS support for security device. U.S. will not show Security Device. TCG EFI protocol and INTIA interface will not be available.
NO Security Device Found	

### Configuration

#### Security Device Support [Disabled]

Allows you to enable or disable the BIOS support for security device.

Configuration options: [Disabled] [Enabled]

## 4.5.2 ACPI Settings

Aptio Setup Utility - Copyright (C) 2019 American Megatrends, Inc.	
Advanced	
ACPI Settings	
Enable ACPI Auto Configuration [Disabled]	Enables or Disables BIOS ACPI Auto Configuration.
Enable Hibernation [Enabled]	

#### Enable ACPI Auto Configuration [Disabled]

Allows you to enable or disable the BIOS ACPI Auto Configuration.

Configuration options: [Disabled] [Enabled]

#### Enable Hibernation [Enabled]

Allows you to enable or disable the ability of the system to hibernate (OS/Sleep State).

Configuration options: [Disabled] [Enabled]



---

This option may be not effective with some OS.

---

## 4.5.3 Smart Settings

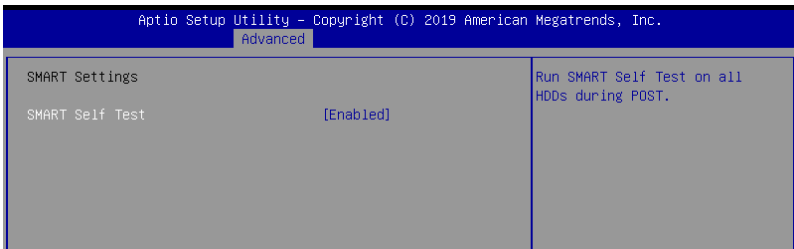

### SMART Self Test [Enabled]

Allows you to run SMART Self Test on all HDDs during POST.

Configuration options: [Disabled] [Enabled]

## 4.5.4 Super IO Configuration

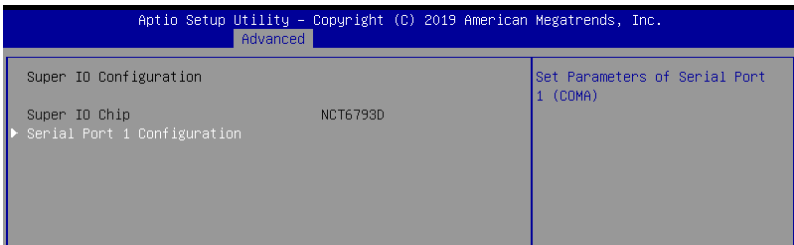

### Serial Port 1 Configuration

Allows you to set the parameters of Serial Port 1.

### Serial Port [Enabled]

Allows you to enable or disable Serial Port.

Configuration options: [Disabled] [Enabled]



The following item appears only when you set **Serial Port** to **[Enabled]**.

### Change Settings [Auto]

Allows you to choose the setting for Super IO device.

Configuration options: [Auto] [IO=3F8h; IRQ=4;]

[IO=3F8h; IRQ=3, 4, 5, 6, 7, 9, 10, 11, 12;]

[IO=2F8h; IRQ=3, 4, 5, 6, 7, 9, 10, 11, 12;]

[IO=3E8h; IRQ=3, 4, 5, 6, 7, 9, 10, 11, 12;]

[IO=2E8h; IRQ=3, 4, 5, 6, 7, 9, 10, 11, 12;]

## 4.5.5 Serial Port Console Redirection

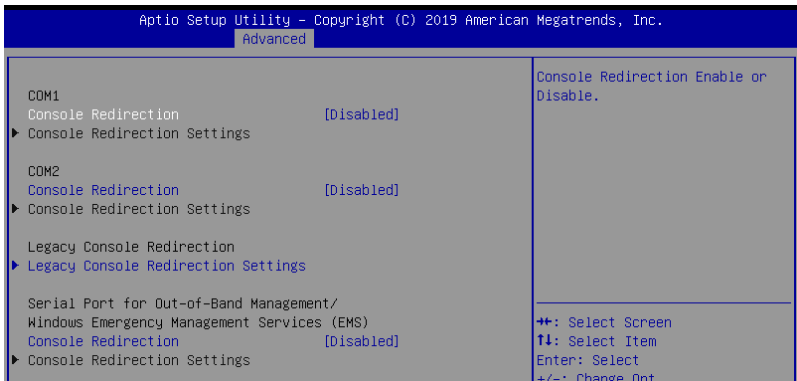

### COM1/COM2

#### Console Redirection [Disabled]

Allows you to enable or disable the console redirection feature.  
Configuration options: [Disabled] [Enabled]



The following item appears only when you set **Console Redirection** to **[Enabled]**.

#### Console Redirection Settings

These items become configurable only when you enable the **Console Redirection** item. The settings specify how the host computer and the remote computer (which the user is using) will exchange data. Both computers should have the same or compatible settings.

#### Terminal Type [VT-UTF8]

Allows you to set the terminal type.

- [VT100] ASCII char set.
- [VT100+] Extends VT100 to support color, function keys, etc.
- [VT-UTF8] Uses UTF8 encoding to map Unicode chars onto 1 or more bytes.
- [ANSI] Extended ASCII char set.

#### Bits per second [57600]

Selects serial port transmission speed. The speed must be matched on the other side.  
Long or noisy lines may require lower speeds.

Configuration options: [9600] [19200] [38400] [57600] [115200]

#### Data Bits [8]

Configuration options: [7] [8]



### **Parity [None]**

A parity bit can be sent with the data bits to detect some transmission errors. [Mark] and [Space] parity do not allow for error detection.

[None]	None
[Even]	parity bit is 0 if the num of 1's in the data bits is even
[Odd]	parity bit is 0 if num of 1's in the data bits is odd
[Mark]	parity bit is always 1
[Space]	parity bit is always 0

### **Stop Bits [1]**

Stop bits indicate the end of a serial data packet. (A start bit indicates the beginning.) The standard setting is 1 stop bit. Communication with slow devices may require more than 1 stop bit.

Configuration options: [1] [2]

### **Flow Control [Hardware RTS/CTS]**

Flow control can prevent data loss from buffer overflow. When sending data, if the receiving buffers are full, a "stop" signal can be sent to stop the data flow. Once the buffers are empty, a "start" signal can be sent to re-start the flow. Hardware flow control uses two wires to send start/stop signals.

Configuration options: [None] [Hardware RTS/CTS]

### **VT -UTF8 Combo Key Support [Enabled]**

This allows you to enable the VT -UTF8 Combination Key Support for ANSI/VT100 terminals.

Configuration options: [Disabled] [Enabled]

### **Recorder Mode [Disabled]**

With this mode enabled only text will be sent. This is to capture Terminal data.

Configuration options: [Disabled] [Enabled]

### **Legacy OS Redirection Resolution [80x24]**

This allows you to set the number of rows and columns supported on the Legacy OS.

Configuration options: [80x24] [80x25]

### **Putty Keypad [VT100]**

This allows you to select the FunctionKey and Keypad on Putty.

Configuration options: [VT100] [LINUX] [XTERMR6] [SCO] [ESCN] [VT400]

### **Redirection After BIOS POST [Always Enable]**

This setting allows you to specify if Bootloader is selected than Legacy console redirection.

Configuration options: [Always Enable] [Bootloader]

## **Legacy Console Redirection Settings**

### **Legacy Console Redirection Port [COM1]**

Allows you to select a COM port to display redirection of Legacy OS and Legacy OPROM Messages.

Configuration options: [COM1] [COM2]

## Serial Port for Out-of-Band Management/Windows Emergency Management Services (EMS)

### Console Redirection [Disabled]

Allows you to enable or disable the console redirection feature.

Configuration options: [Disabled] [Enabled]



---

The following item appears only when you set **Console Redirection** to **[Enabled]**.

---

### Console Redirection Settings

#### Out-of-Band Mgmt Port [COM1]

Microsoft Windows Emergency Management Services (EMS) allow for remote management of a Windows Server OS through a serial port.

Configuration options: [COM1] [COM2]

#### Terminal Type [VT-UTF8]

Microsoft Windows Emergency Management Services (EMS) allow for remote management of a Windows Server OS through a serial port.

Configuration options: [VT100] [VT100+] [VT-UTF8] [ANSI]

#### Bits per second [115200]

Microsoft Windows Emergency Management Services (EMS) allow for remote management of a Windows Server OS through a serial port.

Configuration options: [9600] [19200] [57600] [115200]

#### Flow Control [None]

Microsoft Windows Emergency Management Services (EMS) allow for remote management of a Windows Server OS through a serial port.

Configuration options: [None] [Hardware RTS/CTS] [Software Xon/Xoff]

## 4.5.6 Onboard LAN Configuration

Aptio Setup Utility - Copyright (C) 2019 American Megatrends, Inc.	
Advanced	
Onboard I350 LAN Configuration	Intel LAN Enable/Disable
INTEL I350 LAN1 MAC:	18:31:BF:D0:5F:99
INTEL I350 LAN2 MAC:	18:31:BF:D0:5F:9A
Intel LAN1 Enable	[Enabled]
Intel LAN1 ROM Type	[PXE]
Intel LAN2 Enable	[Enabled]
Intel LAN2 ROM Type	[Disabled]

### Onboard I350 LAN Configuration

#### Intel LAN1 Enable [Enabled]

Allows you to enable or disable the Intel LAN.

Configuration options: [Disabled] [Enabled]



---

The following items appear only when **Intel LAN1 Enable** is set to **[Enabled]**.

---

#### Intel LAN 1 ROM Type [PXE]

Allows you to select the Intel LAN ROM type.

Configuration options: [PXE] [iSCSI] [Disabled]

#### Intel LAN2 Enable [Enabled]

Allows you to enable or disable the Intel LAN.

Configuration options: [Disabled] [Enabled]



---

The following items appear only when **Intel LAN2 Enable** is set to **[Enabled]**.

---

#### Intel LAN 2 ROM Type [Disabled]

Allows you to select the Intel LAN ROM type.

Configuration options: [PXE] [iSCSI] [Disabled]

## 4.5.7 APM

Allows you to configure the Advance Power Management (APM) settings.

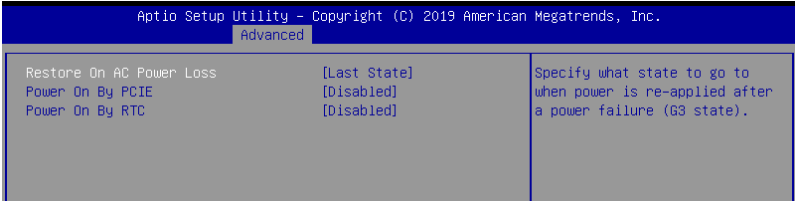

### Restore AC Power Loss [Last State]

When set to [Power Off], the system goes into off state after an AC power loss. When set to [Power On], the system will reboot after an AC power loss. When set to [Last State], the system goes into either off or on state, whatever the system state was before the AC power loss.

Configuration options: [Power Off] [Power On] [Last State]

### Power On By PCIE [Disabled]

[Disabled] Disables the PCIE devices to generate a wake event.

[Enabled] Enables the PCIE devices to generate a wake event.

### Power On By RTC [Disabled]

[Disabled] Disables RTC to generate a wake event.

[Enabled] When set to [Enabled], the items **RTC Alarm Date (Days)** and **Hour/Minute/Second** will become user-configurable with set values.

## 4.5.8 PCI Subsystem Settings

Allows you to configure PCI, PCI-X, and PCI Express Settings.

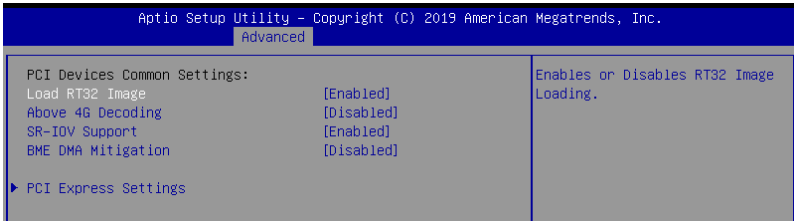

### Load RT32 Image [Enabled]

This option allows you to enable or disable RT32 Image Loading.

Configuration options: [Disabled] [Enabled]

### Above 4G Decoding [Disabled]

Allows you to enable or disable 64-bit capable devices to be decoded in above 4G address space. It only works if the system supports 64-bit PCI decoding.

Configuration options: [Disabled] [Enabled]

### SR-IOV Support [Enabled]

This option enables or disables Single Root IO Virtualization Support if the system has SR-IOV capable PCIe devices.

Configuration options: [Disabled] [Enabled]

### BME DMA Mitigation [Disabled]

This allows you to enable or disable re-enabling Bus Master Attribute disabled during PCI enumeration for PCI Bridges after SMM locked.

Configuration options: [Disabled] [Enabled]

## PCI Express Settings

### PCI Express Device Register Settings

#### Relaxed Ordering [Enabled]

Enables or disables PCI Express device relaxed ordering.

Configuration options: [Disabled] [Enabled]

#### Extended Tag [Disabled]

If Enable allows device is use 8-bit tag field as a requester.

Configuration options: [Disabled] [Enabled]

#### No Snoop [Enabled]

Enables or disables PCI Express device No snoop option.

Configuration options: [Disabled] [Enabled]

## PCI Express Link Register Settings

### ASPM Support [Disabled]

Allows to set the ASPM level. Configuration options: [Disabled] [Auot] [Force L0s]

[Force L0s] Force all links to L0s state.

[Auto] BIOS auto configure.

[Disabled] Disabled ASPM.

### Unpopulated Links [Keep Link ON]

In order to save power, software will disable unpopulated PCI Express links, if this option set to Disabled.

Configuration options: [Keep Link ON] [Disabled]

## PCIE OPROM Slot Options

### PCIE1-3 Slot OPROM [Enabled]

This option allows you to enable or disable the OPROM of the PCIe slots.

Configuration options: [Disabled] [Enabled]

### MEZZ1 Slot OPROM [Enabled]

This option allows you to enable or disable the OPROM of the MEZZ slot.

Configuration options: [Disabled] [Enabled]

## 4.5.9 USB Configuration

Aptio Setup Utility - Copyright (C) 2019 American Megatrends, Inc.	
Advanced	
USB Configuration	Enables Legacy USB support. AUTO option disables legacy support if no USB devices are connected. DISABLE option will keep USB devices available only for EFI applications.
USB Module Version	21
USB Controllers:	
1 XHCI	
USB Devices:	
5 Drives, 2 Keyboards, 1 Mouse, 1 Hub	
Legacy USB Support	[Enabled]
USB Mass Storage Driver Support	[Enabled]
Mass Storage Devices:	<b>++:</b> Select Screen <b>F1:</b> Select Item <b>Enter:</b> Select <b>+/-:</b> Change Opt. <b>F1:</b> General Help <b>F2:</b> Previous Values <b>F5:</b> Optimized Defaults <b>F10:</b> Save Changes & Reboot
JetFlashTranscend 4GB 8.07	[Auto]
AMI Virtual CDROM0 1.00	[Auto]
AMI Virtual Floppy0 1.00	[Auto]
AMI Virtual HDisk0 1.00	[Auto]
AMI Virtual HDisk1 1.00	[Auto]

### Legacy USB Support [Enabled]

Allows you to enable or disable Legacy USB device support.

Configuration options: [Enabled] [Disabled] [Auto]

### USB Mass Storage Driver Support [Enabled]

Allows you to enable or disable the USB Mass Storage driver support.

Configuration options: [Disabled] [Enabled]

### Mass Storage Devices

#### AMI Virtual CDROM0-2 / Floppy / HDisk0 1.00 [Auto]

Allows you to select the mass storage device emulation type.

Configuration options: [Auto] [Floppy] [Forced FDD] [Hard Disk] [CD-ROM]

## 4.5.10 CSM Configuration

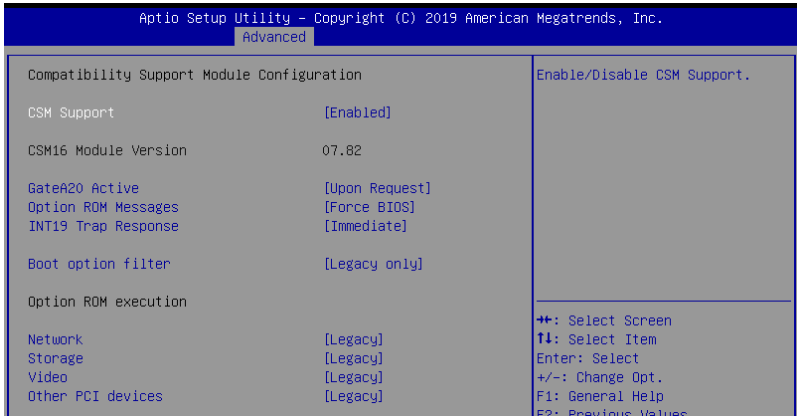

### CSM Support [Enabled]

This option allows you to enable or disable CSM Support.

Configuration options: [Disabled] [Enabled]



The following item appears only when **CSM Support** is set to **[Enabled]**.

#### GateA20 Active [Upon Request]

This allows you to set the GA20 option.

Configuration options: [Upon Request] [Always]

#### Option ROM Messages [Force BIOS]

This option allows you to set the display mode for option ROM.

Configuration options: [Force BIOS] [Keep Current]

#### INT19 Trap Response [Immediate]

[Immediate] Execute the trap right away.

[Postponed] Execute the trap during legacy boot.

#### Boot Option filter [Legacy only]

This option allows you to control the Legacy/UEFI ROMs priority.

Configuration options: [UEFI and Legacy] [Legacy only] [UEFI only]

#### Network / Storage / Video [Legacy]

This option allows you to control the execution of UEFI and Legacy PXE / Storage / Video OpROM.

Configuration options: [UEFI] [Legacy]

#### Other PCI devices [Legacy]

This item determines the OpROM execution policy for devices other than Network, Storage, or Video.

Configuration options: [UEFI] [Legacy]



## 4.5.11 NVMe Configuration

This page will display the NVMe controller and drive information.

Aptio Setup Utility – Copyright (C) 2019 American Megatrends, Inc.	
Advanced	
NVMe controller and Drive Information	
No NVMe Device Found	

## 4.5.12 Network Stack Configuration

Aptio Setup Utility – Copyright (C) 2019 American Megatrends, Inc.	
Advanced	
Network Stack	[Disabled]
	Enable/Disable UEFI Network Stack

### Network stack [Disabled]

Enables or disables the network stack feature.

Configuration options: [Disable] [Enable]



---

The following item appears only when **Network stack** is set to [Enabled].

---

### Ipv4 PXE Support [Disabled]

Enables or disables the Ipv4 PXE Boot Support. If disabled, Ipv4 PXE boot option will not be created.

Configuration options: [Disabled] [Enabled]

### Ipv4 HTTP Support [Disabled]

Enables or disables the Ipv4 HTTP Boot Support. If disabled, Ipv4 HTTP boot option will not be created.

Configuration options: [Disabled] [Enabled]

### Ipv6 PXE Support [Disabled]

Enables or disables the Ipv6 PXE Boot Support. If disabled, Ipv6 PXE boot option will not be created.

Configuration options: [Disabled] [Enabled]

### Ipv6 HTTP Support [Disabled]

Enables or disables the Ipv6 HTTP Boot Support. If disabled, Ipv6 HTTP boot option will not be created.

Configuration options: [Disabled] [Enabled]

### PXE boot wait time [0]

Wait time to press ESC key to abort the PXE boot.

### Media detect time [1]

Wait time (in seconds) to detect media.

### 4.5.13 iSCSI Configuration

Allows you to configure the iSCSi parameters.

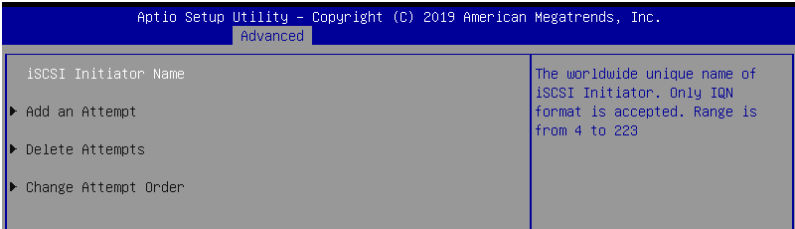

## 4.6 Platform Configuration menu

The IntelRCSetup menu items allow you to change the platform settings.

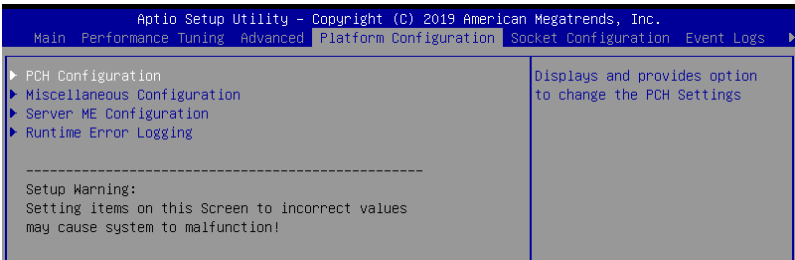

## 4.6.1 PCH Configuration

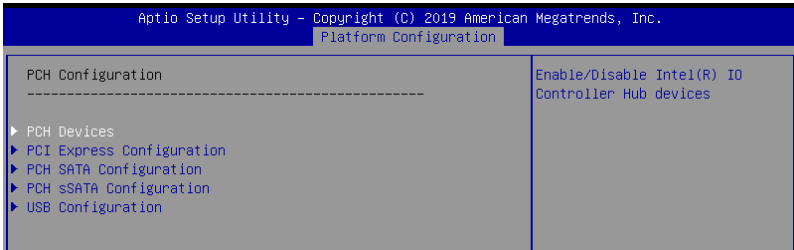

### PCH Devices

#### DeepSx Power Policies [Disabled]

Allows you to configure the DeepSx Mode configuration.

Configuration options: [Disabled] [Enabled in S5] [Enabled in S4 and S5]

#### GP27 Wake From DeepSx [Disabled]

Allows you to enable or disable GP27 Wake From DeepSx.

Configuration options: [Disabled] [Enabled]

### PCI Express Configuration

#### PCI-E ASPM Support (Global) [L1 Only]

Allows you to select ASPM support for all downstream devices.

Configuration options: [Per individual port] [L1 Only]

#### PCH DMI ASPM [Platform-POR]

Allows you to configure the PCH DMI ASPM.

Configuration options: [Platform-POR] [ASPM L1] [Disabled]

### PCH SATA Configuration

#### SATA Controller [Enabled]

Allows you to enable or disable the SATA Controller.

Configuration options: [Disabled] [Enabled]

#### Configure sSATA as [AHCI]

Allows you to identify the SATA port connected to Solid State Drive or Hard Disk Drive.

Configuration options: [IDE] [AHCI] [RAID]

#### Support Aggressive Link Power Management [Enabled]

Allows you to enable or disable the Support Aggressive Link Power (SALP) Management.

Configuration options: [Disabled] [Enabled]

## SATA Port 1-8

### **Port 1-8**

Allows you to enable or disable the SATA port.

Configuration options: [Disabled] [Enabled]

## PCH sSATA Configuration

### **sSATA Controller [Enabled]**

Allows you to enable or disable the sSATA Controller.

Configuration options: [Disabled] [Enabled]

### **Configure sSATA as [AHCI]**

Allows you to identify the SATA port connected to Solid State Drive or Hard Disk Drive.

Configuration options: [IDE] [AHCI] [RAID]

### **Support Aggressive Link Power Management [Enabled]**

Allows you to enable or disable the Support Aggressive Link Power (SALP) Management.

Configuration options: [Disabled] [Enabled]

### **sSATA Port 1-3**

#### **Port 1-3**

Allows you to enable or disable the SATA port.

Configuration options: [Disabled] [Enabled]

## USB Configuration

### **USB Precondition [Disabled]**

Allows you to enable or disable precondition work on USB host controller and root ports for faster enumeration.

Configuration options: [Disabled] [Enabled]

### **XHCI Manual Mode [Disabled]**

This option is used by validation.

Configuration options: [Disabled] [Enabled]



---

The following items appears only when the **XHCI Manual Mode** is set to **[Enabled]**.

---

### **Trunk Clock Gating (BTCCG) [Enabled]**

Allows you to enable or disable BTCCG.

Configuration options: [Disabled] [Enabled]

### **Enable USB 3.0 pins [Disable all pins]**

Allows you to enable or disable USB 3.0 pins or on a per pin basis.

Configuration options: [Select Per-Pin] [Disable all pins] [Enable all pins]

### **USB Per-Connector Disable [Disabled]**

Allows you to enable or disable each of the USB physical connectors. Once a connector is disabled, any USB devices plugged into the connector will not be detected by BIOS or OS.

Configuration options: [Disabled] [Enabled]



The following items appears only when the **USB Per-Connector Disable** is set to **[Enabled]**.

**USB\_1-8 [Enabled]**

Configuration options: [Disabled] [Enabled]

**USB3\_1-5 [Enabled]**

Configuration options: [Disabled] [Enabled]

### Security Configuration

**SMM BIOS Write Protect [Enabled]**

Allows you to enable or disable SMM BIOS Write Protect.

Configuration options: [Disabled] [Enabled]

## 4.6.2 Miscellaneous Configuration

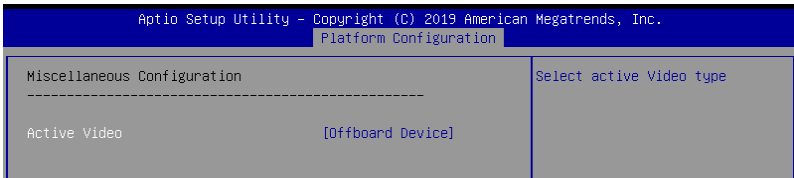

**Active Video [Offboard Device]**

Allows you to select the video type.

Configuration options: [Auto] [Onboard Device] [Offboard Device]

## 4.6.3 Server ME Configuration

Displays the Server ME Technology parameters on your system.

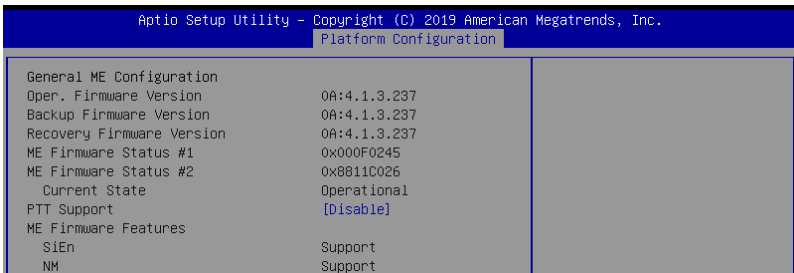

## 4.6.4 Runtime Error Logging Support

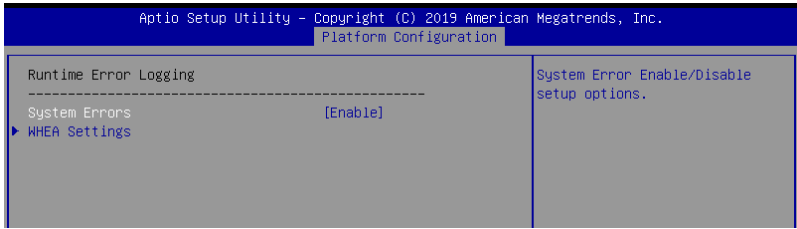

### Runtime Error Logging

#### System Errors [Enabled]

This item allows you to enable or disable System Errors.  
Configuration options: [Disabled] [Enabled]

#### Whea Settings

#### Whea Support [Disabled]

This item allows you to enable or disable the WHEA support.  
Configuration options: [Disabled] [Enabled]

## 4.7 Socket Configuration menu

The IntelRCSetup menu items allow you to change the socket settings.

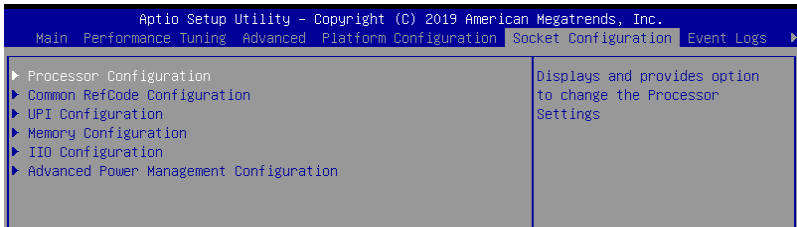

## 4.7.1 Processor Configuration

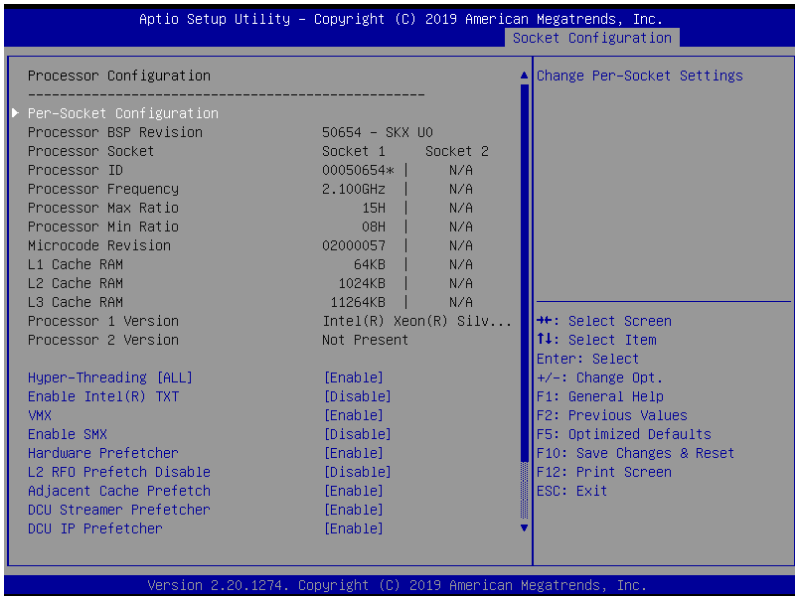

### Hyper Threading [ALL] [Enabled]

Allows you to enable or disable the Hyper-Threading Technology function. When disabled, only one thread per activated core is enabled.

Configuration options: [Disabled] [Enabled]

### Enable Intel(R) TXT Support [Disabled]

Forces the XD feature log to always return 0 when disabled.

Configuration options: [Disabled] [Enabled]

### VMX [Enabled]

Enables the Vanderpool Technology. Takes effect after reboot.

Configuration options: [Disabled] [Enabled]

### Enable SMX [Disabled]

Enables the Safer Mode Extensions.

Configuration options: [Disabled] [Enabled]

### Hardware Prefetcher [Enabled]

This Item allows you to turn on/off the mid level cache(L2) streamer prefetcher.

Configuration options: [Disabled] [Enabled]

### L2 RFO Prefetch Disable [Disabled]

This Item allows you to turn on/off L2 RFO prefetcher.

Configuration options: [Disabled] [Enabled]

**Adjacent Cache Prefetch [Enabled]**

This Item allows you to turn on/off prefetching of adjacent cache lines.  
Configuration options: [Disabled] [Enabled]

**DCU Streamer Prefetcher [Enabled]**

This Item allows you to enable or disable prefetcher of next L1 data line.  
Configuration options: [Disabled] [Enabled]

**DCU IP Prefetcher [Enabled]**

This Item allows you to enable or disable prefetch of next L1 line based upon sequential load history.  
Configuration options: [Disabled] [Enabled]

**LLC Prefetch [Disabled]**

This Item allows you to enable or disable LLC Prefetch on all threads.  
Configuration options: [Disabled] [Enabled]

**DCU Mode [32K 8Way Without ECC]**

Configuration options: [32K 8Way Without ECC] [16K 4Way With ECC]

**Extended APIC [Disabled]**

This Item allows you to enable or disable the extended APIC support.  
Configuration options: [Disabled] [Enabled]

**AES-NI [Enabled]**

This Item allows you to enable or disable the AES-NI support.  
Configuration options: [Disabled] [Enabled]

**4.7.2 Common RefCode Configuration**

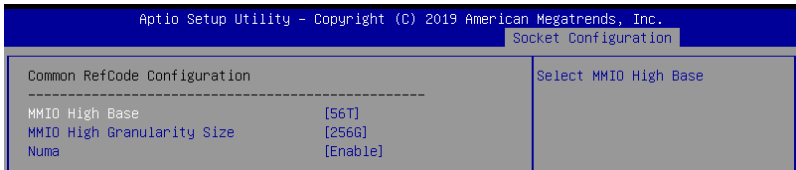

**MMIO High Base [56T]**

This item allows you to select the MMIO High Base.  
Configuration options: [56T] [40T] [24T] [16T] [4T] [1T]

**MMIO High Granularity Size [256G]**

This item allows you to select the allocation size used to assign MMIOH resources.  
Configuration options: [1G] [4G] [16G] [64G] [256G] [1024G]

**Numa [Enabled]**

This item enables or disables the Non uniform Memory Access (NUMA).  
Configuration options: [Disabled] [Enabled]



## 4.7.3 UPI Configuration

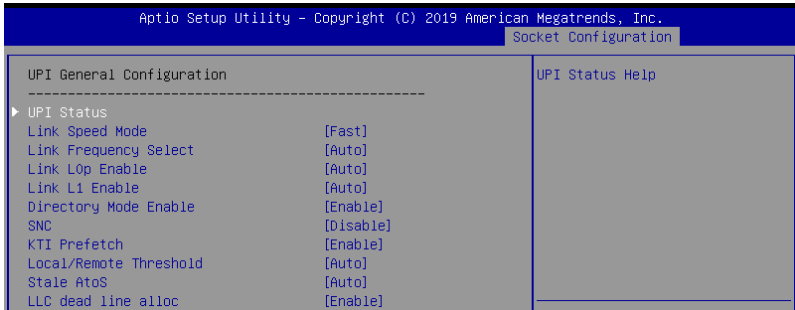

### UPI General Configuration

#### UPI Status

This item displays information about the UPI status.

#### Link Speed Mode [Fast]

This item allows you to select the UPI link speed as either the fast mode or slow mode.

Configuration options: [Slow] [Fast]

#### Link Frequency Select [Auto]

This item allows for selecting the UPI link frequency.

Configuration options: [Auto] [9.6 GB/s] [10.4 GB/s] [Use Per Link Setting]

#### UPI Link0p Enable [Enabled]

Configuration options: [Disabled] [Enabled] [Auto]

#### UPI Link1 Enable [Enabled]

Configuration options: [Disabled] [Enabled] [Auto]

#### Directory Mode Enable [Enabled]

Configuration options: [Disabled] [Enabled]

#### SNC [Disabled]

Configuration options: [Disabled] [Enabled] [Auto]

#### KTI Prefetch [Enabled]

Configuration options: [Disabled] [Enabled]

#### Local/Remote Threshold [Auto]

Configuration options: [Disabled] [Auto] [Low] [Medium] [High]

#### Stale AtoS [Disabled]

Configuration options: [Disabled] [Enabled] [Auto]

#### LLC dead line alloc [Enabled]

Configuration options: [Disabled] [Enabled] [Auto]

## 4.7.4 Memory Configuration

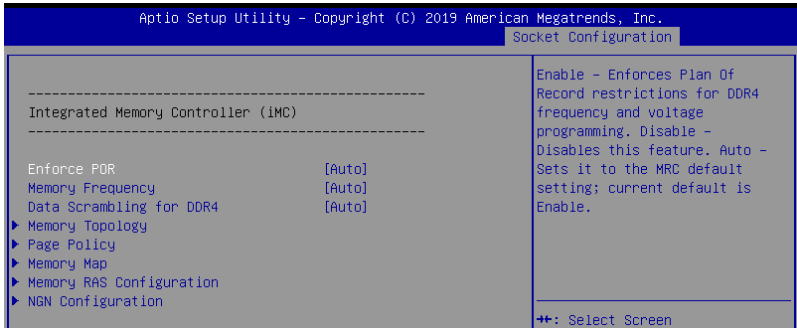

### Enforce POR [Auto]

Allows you to enforce POR restrictions for DDR4 frequency and voltage programming.  
Configuration options: [Auto] [POR] [Disabled]

### Memory Frequency [Auto]

Allows you to select the memory frequency setting.  
Configuration options: [Auto] [1800] - [3000-OvrClk]

### Data Scrambling for DDR4 [Auto]

Allows you to enable or disable data scrambling.  
Configuration options: [Auto] [Disabled] [Enabled]

### Memory Topology

Displays memory topology with DIMM population information.

### Page Policy

Allows you to configure Page Policy settings.

#### Page Policy [Disabled]

Configuration options: [Auto] [Closed] [Adaptive]

### Memory Map

#### IMC Interleaving [Auto]

Select different IMC interleaving setting.

Configuration options: [Auto] [1-way Interleave] [2-way Interleave]

#### Channel Interleaving [Auto]

Select different channel interleaving setting.

Configuration options: [Auto] [1-way Interleave] [2-way Interleave]  
[3-way Interleave]

**Rank Interleaving [Auto]**

Select different rank interleaving setting.

Configuration options: [Auto] [1-way Interleave] [2-way Interleave]  
[4-way Interleave] [8-way Interleave]

**Memory RAS Configuration****Mirror Mode [Disabled]**

Allows you to select Mirror Modes. Mirror Mode will set entire 1LM/2LM memory in system to be mirrored, consequently reducing the memory capacity by half. Enabling Mirror Mode will disable XPT Prefetch.

Configuration options: [Disabled] [Mirror Mode 1LM] [Mirror Mode 2LM]

**UEFI ARM Mirror [Disabled]**

Allows you to enable or disable UEFI ARM Mirror.

Configuration options: [Disabled] [Enabled]

**Memory Rank Sparing [Disabled]**

Allows you to enable or disable Memory Rank Sparing

Configuration options: [Disabled] [Enabled]

**Patrol Scrub [Enabled]**

Allows you to enable or disable Patrol Scrub.

Configuration options: [Disabled] [Enabled]

**NGN Configuration****Average Power Budget (in mW) [18000]**

Allows you to set the power management policy for average power in 250 mW increments.

Configuration options: [10000] - [18000]

## 4.7.5 IIO Configuration

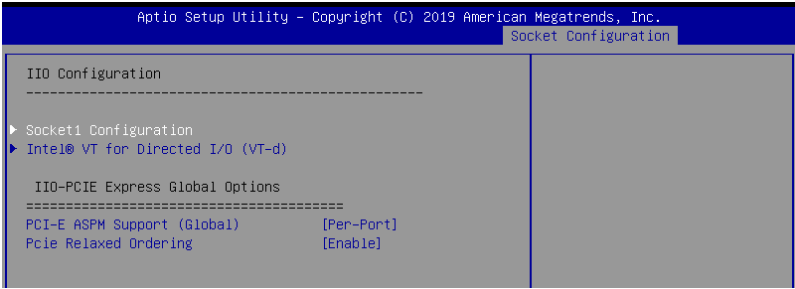

### Socket1 Configuration

This item allows you to configure settings related to the corresponding PCIe port.

### Intel(R) VT for Directed I/O (VT-d)

#### Intel(R) VT for Directed I/O (VT-d) [Disabled]

Allows you to enable or disable the Intel Virtualization Technology for Directed I/O.  
Configuration options: [Disabled] [Enabled]

### PCI Express Global Options

#### PCI-E ASPM Support (Global) [Per-Port]

Allows you to enable or disable ASPM support for all downstream devices.  
Configuration options: [Disabled] [Per-Port] [L1 Only]

#### PCIe relaxed Ordering [Enabled]

Allows you to enable or disable PCIe relaxed Ordering.  
Configuration options: [Disabled] [Enabled]

## 4.7.6 Advanced Power Management Configuration

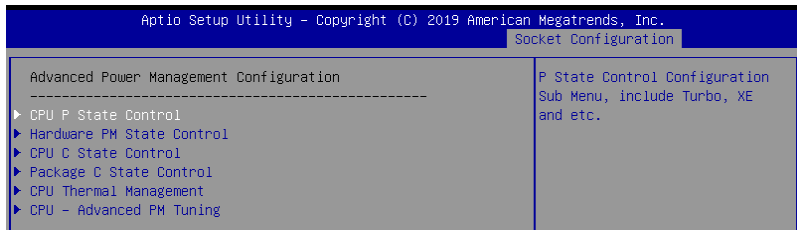

### CPU P State Control

#### Boot performance mode [Max Performance]

Allows you to switch between Boot performance mode.

Configuration options: [Max Performance] [Max Efficient] [Set by Intel Node Manager]

#### Energy Efficient Turbo [Enabled]

Allows you to enable or disable Energy Efficient Turbo.

Configuration options: [Disabled] [Enabled]

#### Turbo Mode [Enabled]

Allows you to enable or disable Turbo Mode.

Configuration options: [Disabled] [Enabled]

### Hardware PM State Control

#### Hardware P-States [Native Mode]

Allows you to switch between Hardware P-States mode.

Configuration options: [Disabled] [Native Mode] [Out of Band Mode] [Native Mode with no Legacy Support]

### CPU C State Control

#### Autonomous Core C-State [Disabled]

Allows you to enable or disable Autonomous Core C-State Report.

Configuration options: [Disabled] [Enabled]

#### CPU C6 Report [Auto]

Allows you to select CPU C6 Report.

Configuration options: [Disabled] [Enabled] [Auto]

#### OS ACPI Cx [ACPI C2]

Allows you to select OS ACPI Cx Report.

Configuration options: [ACPI C2] [ACPI C3]

### Package C State Control

#### Package C State [Auto]

Allows you to select Package C State.

Configuration options: [C0/C1 state] [C2 state] [C6(non Retention state)] [C6(Retention state)] [No Limit] [Auto]

## CPU Thermal Control

### CPU T-State Control

#### Software Controlled T-States [Disabled]

Allows you to enable or disable Software Controlled T-States.  
Configuration options: [Disabled] [Enabled]

## CPU - Advanced PM Tuning

### Energy Perf BIAS

#### Power Performance Tuning [OS Controls EPB]

Configuration options: [OS Controls EPB] [BIOS Controls EPB]



---

The following item appears only when you set **Power Performance Tuning** to **[OS Controls EPB]**.

---

#### PECI PCS EPB [OS Controls EPB]

This option controls whether Peci has control over EPB.  
Configuration options: [OS Controls EPB] [Peci Controls EPB using PCS]



---

The following item appears only when you set **Power Performance Tuning** to **[BIOS Controls EPB]**.

---

#### ENERGY\_PERF\_BIAS\_CFG Mode [Balanced Performance]

Configuration options: [Performance] [Balanced Performance] [Balanced Power] [Power]

#### Dynamic Loadline Switch [Enabled]

Configuration options: [Disabled] [Enabled]

#### Workload Configuration [UMA]

This option allows optimization for the workload characterization.  
Configuration options: [UMA] [NUMA]

#### Averaging Time Window [17]

This option is used to control the effective window of the average C0 an P0 time.  
Configuration options: [0] - [FF]

#### P0 TotalTimeThreshold Low [23]

The HW switching mechanism DISABLES the performance setting (0) when the total P0 time is less than the threshold set.  
Configuration options: [0] - [3F]

#### P0 TotalTimeThreshold High [3a]

The HW switching mechanism Enables the performance setting (0) when the total P0 time is greater than the threshold set.  
Configuration options: [0] - [3F]

## 4.8 Event Logs menu

The Event Logs menu items allow you to change the event log settings and view the system event logs.

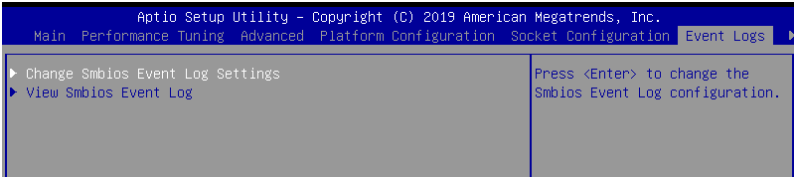

### 4.8.1 Change Smbios Event Log Settings

Press <Enter> to change the Smbios Event Log configuration.



---

All values changed here do not take effect until computer is restarted.

---

#### Enabling/Disabling Options

##### Smbios Event Log [Enabled]

Change this to enable or disable all features of Smbios Event Logging during boot.

Configuration options: [Disabled] [Enabled]

#### Erasing Settings

##### Erase Event Log [No]

Choose options for erasing Smbios Event Log. Erasing is done prior to any logging activation during reset.

Configuration options: [No] [Yes, Next reset] [Yes, Every reset]

### 4.8.2 View Smbios Event Log

Press <Enter> to view all smbios event logs.

## 4.9 Server Mgmt menu

The Server Management menu displays the server management status and allows you to change the settings.

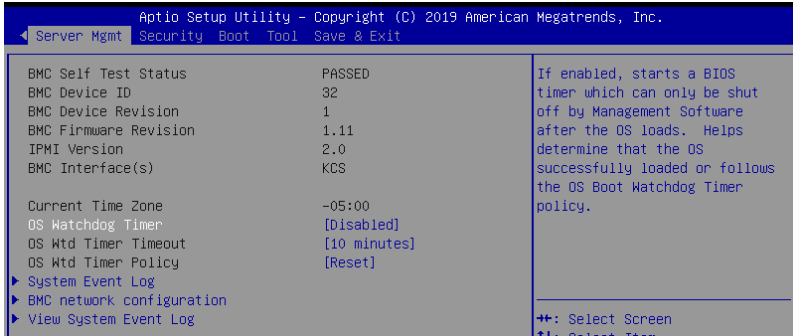

### OS Watchdog Timer [Disabled]

This item allows you to start a BIOS timer which can only be shut off by Intel Management Software after the OS loads.

Configuration options: [Disabled] [Enabled]



The following items is configurable only when the **OS Watchdog Timer** is set to **[Enabled]**.

### OS Wtd Timer Timeout [10 minutes]

Allows you to configure the length for the OS Boot Watchdog Timer.

Configuration options: [5 minutes] [10 minutes] [15 minutes] [20 minutes]

### OS Wtd Timer Policy [Reset]

This item allows you to configure how the system should respond if the OS Boot Watch Timer expires.

Configuration options: [Do Nothing] [Reset] [Power Down]

### System Event Log

Allows you to change the SEL event log configuration.

#### Erase SEL [No]

Allows you to choose options for erasing SEL.

Configuration options: [No] [Yes, On next reset] [Yes, On every reset]

#### When SEL is Full [Do Nothing]

Allows you to choose options for reactions to a full SEL.

Configuration options: [Do Nothing] [Erase Immediately]

### BMC network configuration

The sub-items in this configuration allow you to configure the BMC network parameters.

### View System Event Log

This item allows you to view the system event log records.



## 4.10 Security menu

This menu allows a new password to be created or a current password to be changed. The menu also enables or disables the Secure Boot state and lets the user configure the System Mode state.

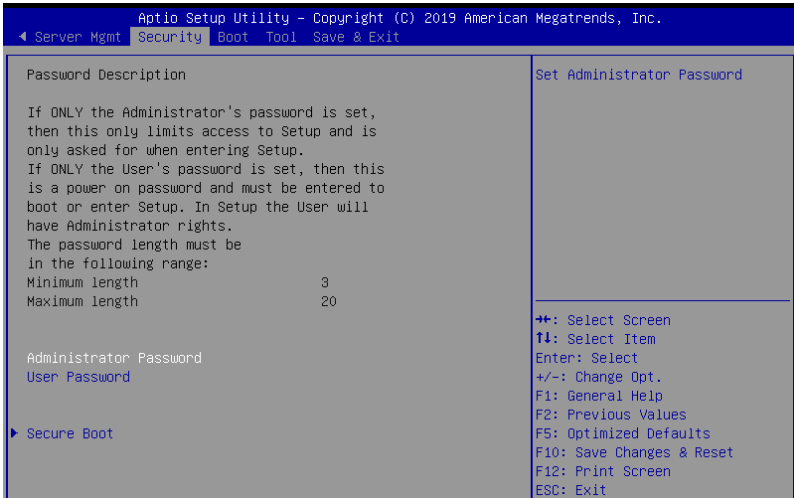

### Administrator Password

To set an administrator password:

1. Select the Administrator Password item and press <Enter>.
2. From the Create New Password box, key in a password, then press <Enter>.
3. Confirm the password when prompted.

To change an administrator password:

1. Select the Administrator Password item and press <Enter>.
2. From the Enter Current Password box, key in the current password, then press <Enter>.
3. From the Create New Password box, key in a new password, then press <Enter>.
4. Confirm the password when prompted.



To clear the administrator password, follow the same steps as in changing an administrator password, but press <Enter> when prompted to create/confirm the password.

## User Password

To set a user password:

1. Select the User Password item and press <Enter>.
2. From the Create New Password box, key in a password, then press <Enter>.
3. Confirm the password when prompted.

To change a user password:

1. Select the User Password item and press <Enter>.
2. From the Enter Current Password box, key in the current password, then press <Enter>.
3. From the Create New Password box, key in a new password, then press <Enter>.
4. Confirm the password when prompted.

To clear a user password:

1. Select the Clear User Password item and press <Enter>.
2. Select **Yes** from the Warning message window then press <Enter>.

## Secure Boot

This item allows you to customize the Secure Boot settings.

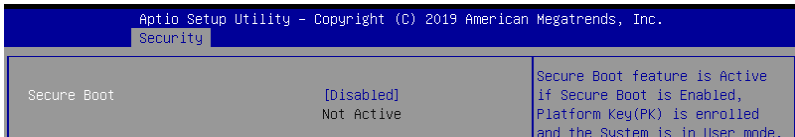

### Secure Boot

Allows you to enable or disable Secure Boot.

Configuration options: [Disabled] [Enabled]

## 4.11 Boot menu

The Boot menu items allow you to change the system boot options.

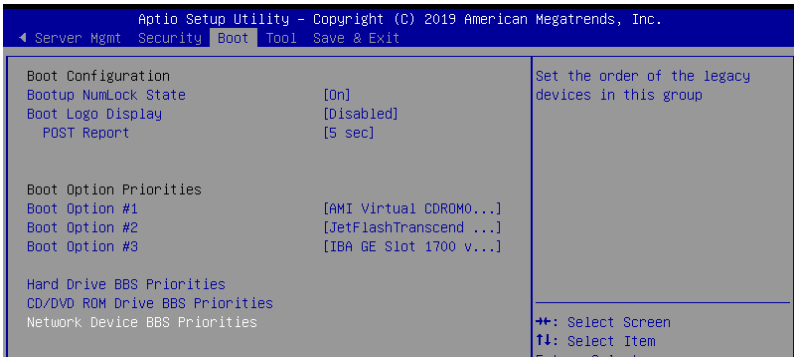

### Bootup NumLock State [On]

Allows you to select the power-on state for the NumLock.

Configuration options: [Off] [On]

### Boot Logo Display [Auto]

Allows you to enable or disable the full screen logo display feature.

Configuration options: [Auto] [Full Screen] [Disabled]

### POST Report [5 sec]

Allows you to set the desired POST Report waiting time from 1 to 10 seconds.

Configuration options: [1 sec] ~ [10 sec] [Until Press ESC]

### Boot Option Priorities

These items specify the boot device priority sequence from the available devices. The number of device items that appears on the screen depends on the number of devices installed in the system.



- To select the boot device during system startup, press <F8> when ASUS Logo appears.
- To access Windows OS in Safe Mode, please press <F8> after POST.

### Hard Drive / CD/DVD ROM Drive / Network Device BBS Priorities

These items appear allow you to set the order of the legacy devices in this group.

## 4.12 Tool menu

The Tool menu items allow you to configure options for special functions. Select an item then press <Enter> to display the submenu.



### IPMI Hardware Monitor

Allows you to run the IPMI hardware monitor.

### Start EZ Flash

Allows you to run ASUS EZ Flash BIOS ROM Utility when you press <Enter>. Refer to the ASUS EZ Flash Utility section for details.

## 4.13 Save & Exit menu

The Save & Exit menu items allow you to save or discard your changes to the BIOS items.

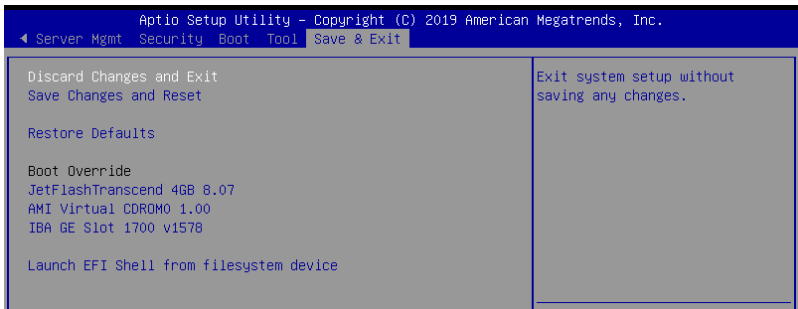

Pressing <Esc> does not immediately exit this menu. Select one of the options from this menu or <F10> from the legend bar to exit.

### Discard Changes & Exit

Exit System setup without saving any changes.

### Save Changes & Reset

Exit System setup after saving the changes.

### Restore Defaults

Restore/load default values for all the setup options.

### Boot Override

These items displays the available devices. The device items that appears on the screen depends on the number of devices installed in the system. Click an item to start booting from the selected device.

# **RAID Configuration**

# 5

This chapter provides instructions for setting up, creating, and configuring RAID sets using the available utilities.

## 5.1 Setting up RAID

The motherboard supports the Intel® Rapid Storage Technology enterprise Option ROM Utility with RAID 0, RAID 1, RAID 10, and RAID 5 support.

### 5.1.1 RAID definitions

**RAID 0** (*Data striping*) optimizes two identical hard disk drives to read and write data in parallel, interleaved stacks. Two hard disks perform the same work as a single drive but at a sustained data transfer rate, double that of a single disk alone, thus improving data access and storage. Use of two new identical hard disk drives is required for this setup.

**RAID 1** (*Data mirroring*) copies and maintains an identical image of data from one drive to a second drive. If one drive fails, the disk array management software directs all applications to the surviving drive as it contains a complete copy of the data in the other drive. This RAID configuration provides data protection and increases fault tolerance to the entire system. Use two new drives or use an existing drive and a new drive for this setup. The new drive must be of the same size or larger than the existing drive.

**RAID 10** is data striping and data mirroring combined without parity (redundancy data) having to be calculated and written. With the RAID 10 configuration you get all the benefits of both RAID 0 and RAID 1 configurations. Use four new hard disk drives or use an existing drive and three new drives for this setup.

**RAID 5** stripes both data and parity information across three or more hard disk drives. Among the advantages of RAID 5 configuration include better HDD performance, fault tolerance, and higher storage capacity. The RAID 5 configuration is best suited for transaction processing, relational database applications, enterprise resource planning, and other business systems. Use a minimum of three identical hard disk drives for this setup.



---

If you want to boot the system from a hard disk drive included in a created RAID set, copy first the RAID driver from the support DVD to a floppy disk before you install an operating system to the selected hard disk drive.

---

## 5.1.2 Installing hard disk drives

The motherboard supports Serial ATA for RAID set configuration. For optimal performance, install identical drives of the same model and capacity when creating a disk array.

To install the SATA hard disks for RAID configuration:

1. Install the SATA hard disks into the drive bays following the instructions in the system user guide.
2. Connect a SATA signal cable to the signal connector at the back of each drive and to the SATA connector on the motherboard.
3. Connect a SATA power cable to the power connector on each drive.

## 5.1.3 Setting the RAID item in BIOS

You must set the RAID item in the BIOS Setup before you can create a RAID set from SATA hard disk drives attached to the SATA connectors supported by Intel® C621 chipset.

To do this:

1. Enter the BIOS Setup during POST.
2. Go to the **Platform Configuration** Menu > **PCH Configuration**, then press <Enter>.
3. Set **Configure SATA as** to [RAID Mode].
4. Press <F10> to save your changes and exit the BIOS Setup.



---

Refer to Chapter 4 for details on entering and navigating through the BIOS Setup.

---

## 5.2 Intel® Rapid Storage Technology enterprise SATA Option ROM Utility

The Intel® Rapid Storage Technology enterprise SATA Option ROM utility allows you to create RAID 0, RAID 1, RAID 10 (RAID 1+0), and RAID 5 set from Serial ATA hard disk drives that are connected to the Serial ATA connectors supported by the Southbridge.



Before you proceed, ensure that you have installed the Serial ATA hard disk drives, and have set the correct SATA mode in the BIOS setup.

To launch the Intel® Rapid Storage Technology enterprise SATA Option ROM utility:

1. Turn on the system.
2. During POST, press <Ctrl>+<I> to display the utility main menu.

```
Intel(R) Rapid Storage Technology enterprise - SATA Option ROM - 3.6.0.1023
Copyright(C) 2003-12 Intel Corporation. All Rights Reserved.

[ MAIN MENU ]
1. Create RAID Volume
2. Delete RAID Volume
3. Reset Disks to Non-RAID
4. Exit

[ DISK/VOLUME INFORMATION ]

RAID Volumes:
None defined.

Physical Disks:
ID Drive Model Serial # Size Type/Status (Vol ID)
0 ST3300656SS HWAS0000991753TR 279.3GB Non-RAID Disk
1 ST3300656SS 37VN00009846RAJ1 279.3GB Non-RAID Disk
2 ST3300656SS 397600009846UEDY 279.3GB Non-RAID Disk
3 ST3300656SS GWC50000991756G6 279.3GB Non-RAID Disk

[↑↓]-Select [ESC]-Exit [ENTER]-Select Menu
```

The navigation keys at the bottom of the screen allow you to move through the menus and select the menu options.



The RAID BIOS setup screens shown in this section are for reference only and may not exactly match the items on your screen.



## 5.2.1 Creating a RAID set

To create a RAID set:

1. From the utility main menu, select **1. Create RAID Volume** and press <Enter>.
2. Key in a name for the RAID set and press <Enter>.

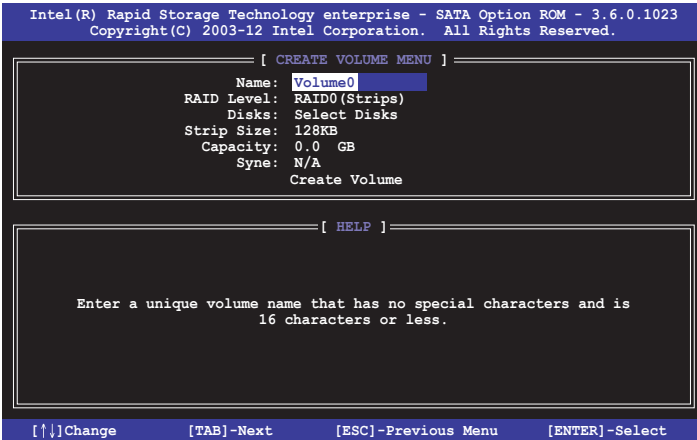

3. Press the up/down arrow keys to select a RAID Level that you wish to create then press <Enter>.
4. From the **Disks** item field, press <Enter> to select the hard disk drives that you want to include in the RAID set.

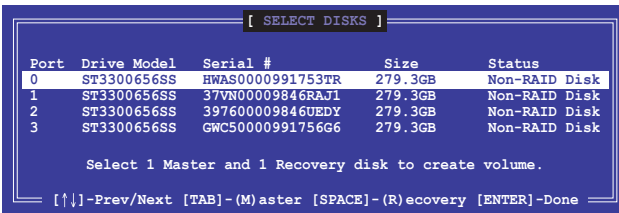

5. Use the up/down arrow keys to move the selection bar then press <Space> to select a disk. A small triangle before the Port number marks the selected drive. Press <Enter> when you are done.

- Use the up/down arrow keys to select the stripe size for the RAID array (for RAID 0, 10 and 5 only) then press <Enter>. The available stripe size values range from 4 KB to 128 KB. The following are typical values:  
RAID 0: 128KB  
RAID 10: 64KB  
RAID 5: 64KB



---

We recommend a lower stripe size for server systems, and a higher stripe size for multimedia computer systems used mainly for audio and video editing.

---

- In the **Capacity** field item, key in the RAID volume capacity that you want to use and press <Enter>. The default value field indicates the maximum allowed capacity.
- Press <Enter> to start creating the RAID volume.
- From the following warning message, press <Y> to create the RAID volume and return to the main menu, or press <N> to go back to the **CREATE VOLUME** menu.

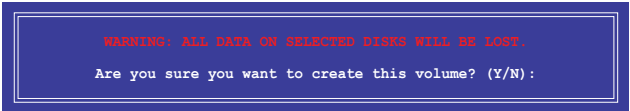

## 5.2.2 Deleting a RAID set



Take caution when deleting a RAID set. You will lose all data on the hard disk drives when you delete a RAID set.

To delete a RAID set:

1. From the utility main menu, select **2. Delete RAID Volume** and press <Enter>.
2. From the Delete Volume Menu, press the up/down arrow keys to select the RAID set you want to delete then press <Del>.

```
Intel(R) Rapid Storage Technology enterprise - SATA Option ROM - 3.6.0.1023
Copyright(C) 2003-12 Intel Corporation. All Rights Reserved.

----- [ DELETE VOLUME MENU ] -----

Name      Level      Drives    Capacity  Status    Bootable
Volume0   RAID0 (Stripe)  2         298.0GB   Normal    Yes

----- [ HELP ] -----

Deleting a volume will reset the disks to non-RAID

WARNING: ALL DISK DATA WILL BE DELETED.
(This does not apply to Recovery volumes)

[↑,↓]-Select      [ESC]-Previous Menu      [DEL]-Delete Volume
```

3. Press <Y> to confirm deletion of the selected RAID set and return to the utility main menu, or press <N> to return to the **DELETE VOLUME** menu.

```
----- [ DELETE VOLUME VERIFICATION ] -----

ALL DATA IN THE VOLUME WILL BE LOST!
(This does not apply to Recovery volumes)

Are you sure you want to delete volume "Volume0"? (Y/N):
```

## 5.2.3 Resetting disks to Non-RAID



Take caution before you reset a RAID volume hard disk drive to non-RAID. Resetting a RAID volume hard disk drive deletes all internal RAID structure on the drive.

To reset a RAID set:

1. From the utility main menu, select **3. Reset Disks to Non-RAID** and press <Enter>.
2. Press the up/down arrow keys to select the drive(s) or disks of the RAID set you want to reset, then press <Space>. A small triangle before the Port number marks the selected drive. Press <Enter> when you are done.

```
[ RESET RAID DATA ]
Resetting RAID disk will remove its RAID structures
and revert it to a non-RAID disk.

WARNING: Resetting a disk causes all data on the disk to be lost.
(This does not apply to Recovery volumes)

Port  Drive Model  Serial #      Size      Status
---  -
0     ST3300656SS    HWAS0000991753TR  279.3GB  Member Disk
1     ST3300656SS    37VN00009846RAJ1  279.3GB  Member Disk

Select the disks that should be reset.

[↑↓]-Previous/Next [SPACE]-Selects [ENTER]-Selection Complete
```

3. Press <Y> in the confirmation window to reset the drive(s) or press <N> to return to the utility main menu.

## 5.2.4 Exiting the Intel® Rapid Storage Technology enterprise SATA Option ROM utility

To exit the utility:

1. From the utility main menu, select **4. Exit** then press <Enter>.
2. Press <Y> to exit or press <N> to return to the utility main menu.

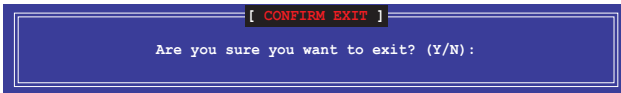

## 5.2.5 Rebuilding the RAID



---

This option is only for the RAID 1 set.

---

### Rebuilding the RAID with other non-RAID disk

If any of the SATA hard disk drives included in the RAID 1 array failed, the system displays the status of the RAID volume as **"Degraded"** during POST. You can rebuild the RAID array with other installed non-RAID disks.

To rebuild the RAID with other non-RAID disk:

1. During POST, press <Ctrl>+<I> at the prompt to enter the Intel Rapid Storage Technology option ROM utility.
2. If there is a non-RAID SATA Hard Disk available, the utility will prompt you to rebuild the RAID. Press the up/down arrow keys to select the destination disk then Press <Enter> to start the rebuilding process, or press <ESC> to exit.

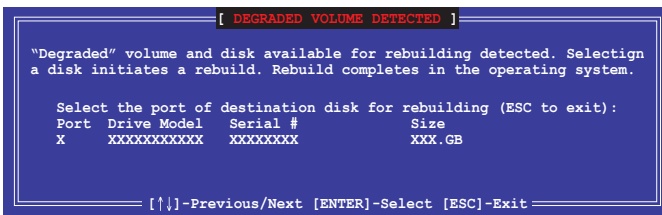

---

Select a destination disk with the same size as the original hard disk.

---

- The utility immediately starts rebuilding after the disk is selected. When done, the status of the degraded RAID volume is changed to **“Rebuild”**.

```

Intel(R) Rapid Storage Technology enterprise - SATA Option ROM - 3.6.0.1023
Copyright(C) 2003-12 Intel Corporation. All Rights Reserved.

[ MAIN MENU ]
1. Create RAID Volume
2. Delete RAID Volume
3. Reset Disks to Non-RAID
4. Exit

[ DISK/VOLUME INFORMATION ]

RAID Volumes:
ID Name Level Strip Size Status Bootable
1 Volume0 RAID1 (Mirror) N/A 149.0GB Rebuild Yes

Physical Devices:
Port Drive Model Serial # Size Type/Status (Vol ID)
1 ST3160812AS 9LS0F4HL 149.0GB Member Disk (0)
2 ST3160812AS 3LS0JYL8 149.0GB Member Disk (0)

Volumes with "Rebuild" status will be rebuilt within the operating system.

[↑↓]-Select [ESC]-Exit [ENTER]-Select Menu

```

- Press <Esc> to exit Intel Rapid Storage Technology and reboot the system.
- Select **Start > Programs > Intel Rapid Storage > Intel Rapid Storage Console** or click the **Intel Rapid Storage Technology** tray icon to load the Intel Rapid Storage Manager utility.
- From the **View** menu, select **Advanced Mode** to display the details of the Intel Rapid Storage Console.
- From the **Volumes view** option, select **RAID volume** to view the rebuilding status. When finished, the status is changed to **“Normal”**.

### Rebuilding the RAID with a new hard disk

If any of the SATA hard disk drives included in the RAID array failed, the system displays the status of the RAID volume as **“Degraded”** during POST. You may replace the disk drive and rebuild the RAID array.

To rebuild the RAID with a new hard disk:

- Remove the failed SATA hard disk and install a new SATA hard disk of the same specification into the same SATA Port.



---

Select a destination disk with the same size as the original hard disk.

---

- Reboot the system then follow the steps in section **Rebuilding the RAID with other non-RAID disk**.

## 5.2.6 Setting the Boot array in the BIOS Setup Utility

You can set the boot priority sequence in the BIOS for your RAID arrays when creating multi-RAID using the Intel® Rapid Storage Technology enterprise SATA Option ROM utility.

To set the boot array in the BIOS:



---

Set at least one of the arrays bootable to boot from the hard disk.

---

1. Reboot the system and press <Del> to enter the BIOS setup utility during POST.
2. Go to the **Boot** menu and select the boot option priority.
3. Use up/down arrow keys to select the boot priority and press <Enter>. See the **Boot menu** section of Chapter 4 for more details.
4. From the **Exit** menu, select **Save Changes & Exit**, then press <Enter>.
5. When the confirmation window appears, select **Yes**, then press <Enter>.

## 5.3 Intel® Rapid Storage Technology enterprise (Windows)

The Intel® Rapid Storage Technology enterprise allows you to create RAID 0, RAID 1, RAID 10 (RAID 1+0), and RAID 5 set(s) from Serial ATA hard disk drives that are connected to the Serial ATA connectors supported by the Southbridge.



You need to manually install the Intel® Rapid Storage Technology enterprise utility on a Windows® operating system. Please refer to the installation instructions in Chapter 6.

To enter the Intel® Rapid Storage Technology enterprise utility under Windows operating system:

1. Turn on the system and go to the windows desktop.
2. Click the **Intel® Rapid Storage Technology enterprise** icon to display the main menu.

Your storage system is configured for data protection, increased performance and optimal data storage capacity. You can create additional volumes to further optimize your storage system.

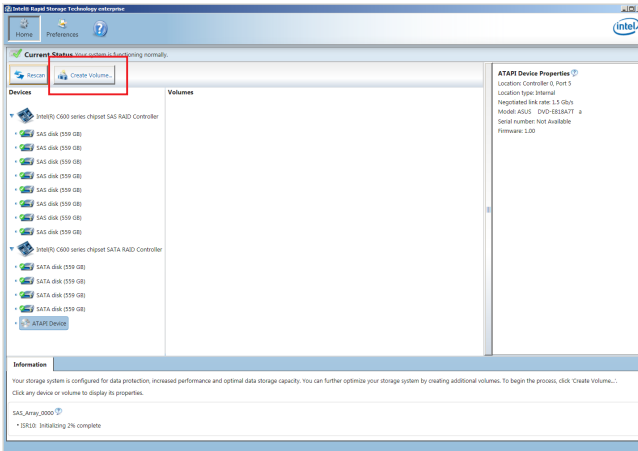

You can click **Rescan** to re-scan any attached hard disks.



## 5.3.1 Creating a RAID set

To create a RAID set:

1. From the utility main menu, select **Create Volume** and select volume type.
2. Click **Next**.

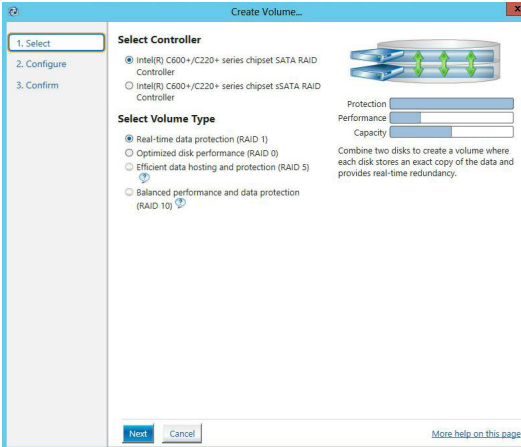

3. Enter a name for the RAID set, then select the array disks.
4. Select **Volume Size** tab, you can drag the bar to decide the volume size.
5. Click **Next**.

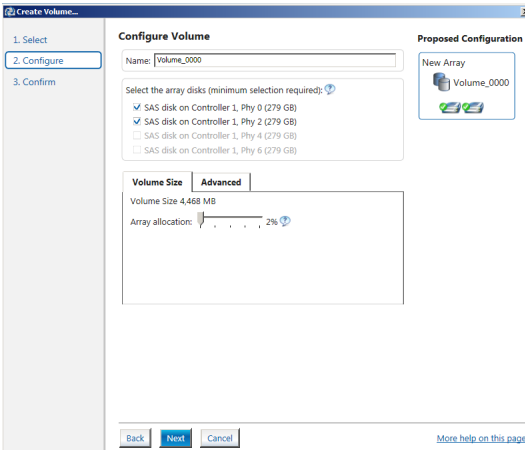

- If you do not want to keep the data on one of the selected disks, select **NO** when prompted.
- If you want to **Enable volume write-back cache** or **Initialize volume**, click **Advanced**.

6. Confirm the volume creation, then click **Create Volume** to continue.



This process could take a while depending on the number and size of the disks. You can continue using other applications during this time.

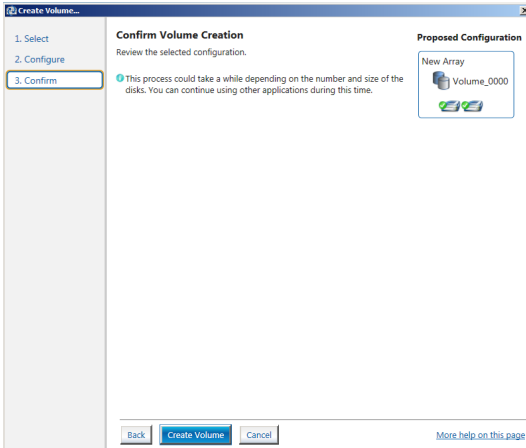

7. Wait until the process is completed, then click **OK** when prompted.

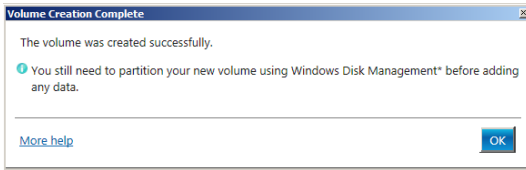

You still need to partition your new volume using Windows Disk Management before adding any data.

The RAID set is displayed in the **Volumes** list and you can change the settings in **Volume Properties**.

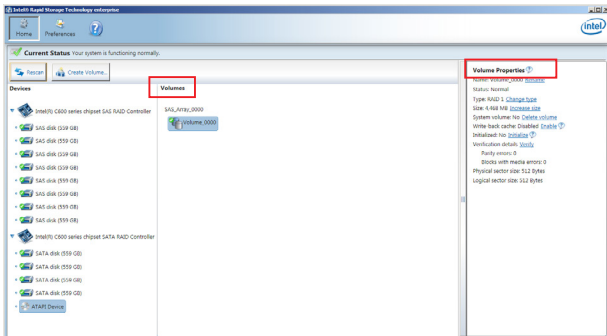

## 5.3.2 Changing a Volume Type

To change the volume type in **Volume Properties**:

1. Click the SATA array items you want to change in **Volumes** field.
2. From the **Volume Properties** field, select **Type:RAID 1 Change type**.

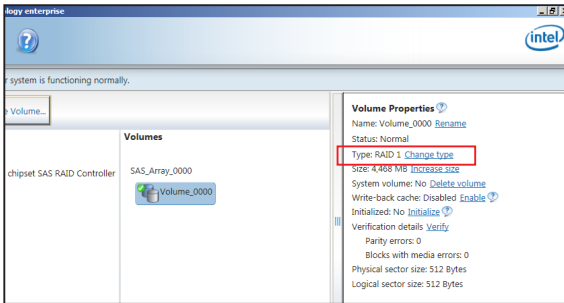

3. You can change the **Name**, **Select the new volume type**, and **Select additional disks to include in the new volume** if needed.
4. Select the **Data stripe size** for the RAID array (for RAID 0, 10 and 5 only), and click **OK**. The available stripe size values range from 4 KB to 128 KB. The following are typical values:

RAID 0:       128KB  
RAID 10:       64KB  
RAID 5:        64KB

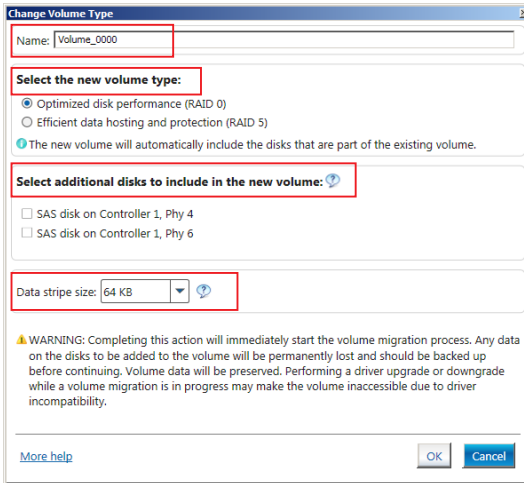

We recommend a lower stripe size for server systems, and a higher stripe size for multimedia computer systems used mainly for audio and video editing.

### 5.3.3 Deleting a volume



Be cautious when deleting a volume. You will lose all data on the hard disk drives. Before you proceed, ensure that you back up all your important data from your hard drives.

To delete a volume:

1. From the utility main menu, select the volume (exp. Volume\_0000) in **Volumes** field you want to delete.

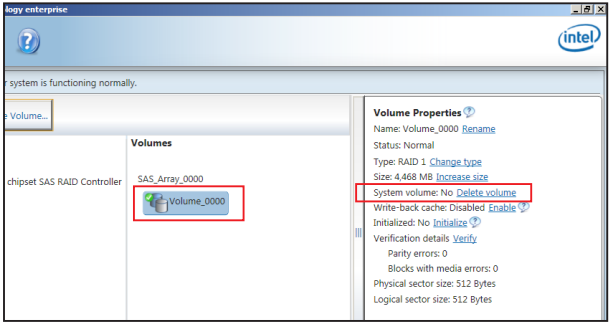

2. Select **Delete volume** in **Volume Properties** field. The following screen appears.

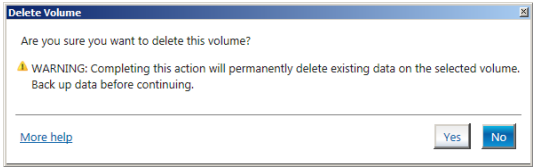

3. Click **Yes** to delete the volume and return to the utility main menu, or click **No** to return to the main menu.

## 5.3.4 Preferences

### System Preferences

Allow you to set to show the notification area icon and show system information, warning, or errors here.

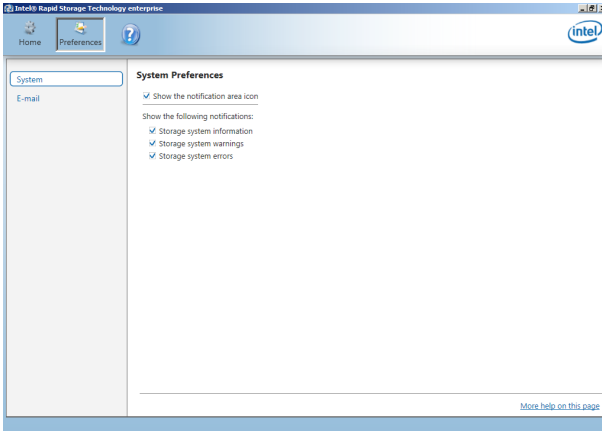

### E-Mail Preferences

Allow you to set to sent e-mail of the following events:

- Storage system information
- Storage system warnings
- Storage system errors

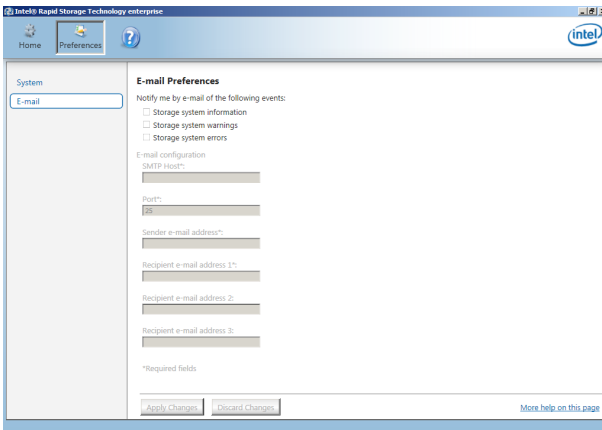

## 5.4 Intel® Virtual Raid on CPU in BIOS

This feature requires a KEY module to enable CPU RAID functions with Intel® CPU RSTe.



- The KEY module is purchased separately.
- Refer to section **2.8.2 Internal connectors** for the location of the VROC\_HW\_KEY connector.



Due to hardware design, your motherboard does not support CPU RAID configurations as OS drives.

To enter the Intel® Virtual Raid on CPU in BIOS:

1. Enter the BIOS Setup during POST.
2. Go to the **Advanced** menu > **Intel(R) Virtual Raid on CPU** > **All Intel VMD Controllers** then press <Enter> to display the Intel® Virtual Raid on CPU menu.



Refer to Chapter 4 for details on entering and navigating through the BIOS Setup.



Due to chipset limitation, when SATA ports are set to RAID mode, all SATA ports run at RAID mode together.

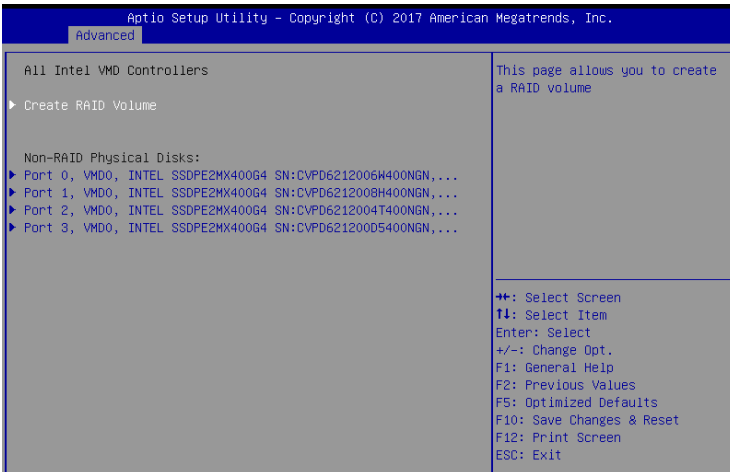

## 5.4.1 Creating a RAID set

To create a RAID set:

1. From the Intel® Virtual Raid on CPU menu, select **Create RAID Volume** and press <Enter>. The following screen appears:

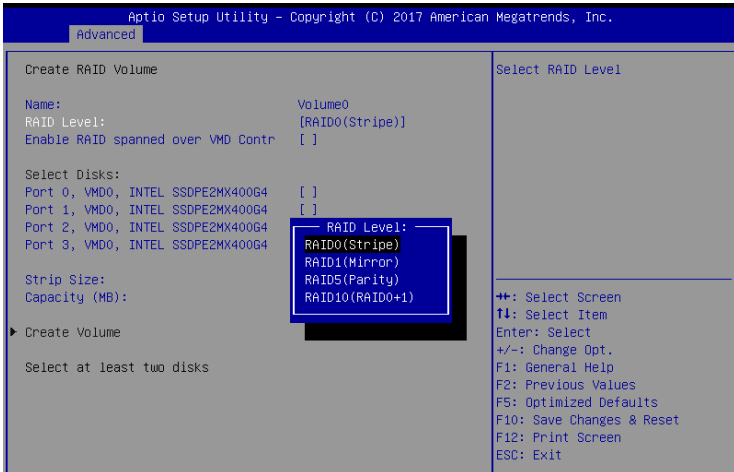

2. When the **Name** item is selected, enter a name for the RAID set and press <Enter>.
3. When the **RAID Level** item is selected, press <Enter> to select the RAID level to create, and then press <Enter>.
4. When the **Enable RAID spanned over VMD Controllers** item is selected, press <Enter> and select **X** to enable this function.
5. Under **Select Disks**, press <Enter> and select **X** for the disks you want to include in the RAID set.
6. When the **Strip Size** item is selected, press <Enter> to select strip size for the RAID array (for RAID 0, 10 and 5 only), and then press <Enter>. The available strip size values range from 4 KB to 128 KB. The following are typical values:
  - RAID 0: 128 KB
  - RAID 10: 64 KB
  - RAID 5: 64 KB



We recommend a lower strip size for server systems, and a higher strip size for multimedia computer systems used mainly for audio and video editing.

7. When the **Capacity (MB)** item is selected, enter the RAID volume capacity that you want and press <Enter>. The default value indicates the maximum allowed capacity.
8. When the **Create Volume** item is selected, press <Enter> to create the RAID volume and return to the Intel® Rapid Storage Technology menu.

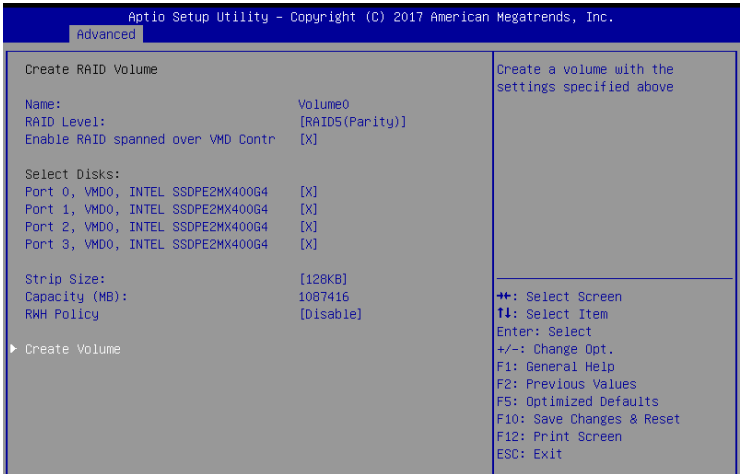



## 5.4.2 Deleting a RAID set



Be cautious when deleting a RAID set. You will lose all data on the hard disk drives when you delete a RAID set.

To delete a RAID set:

1. From the Intel® Virtual Raid on CPU menu, select the RAID volume you want to delete and press <Enter>. The following screen appears:

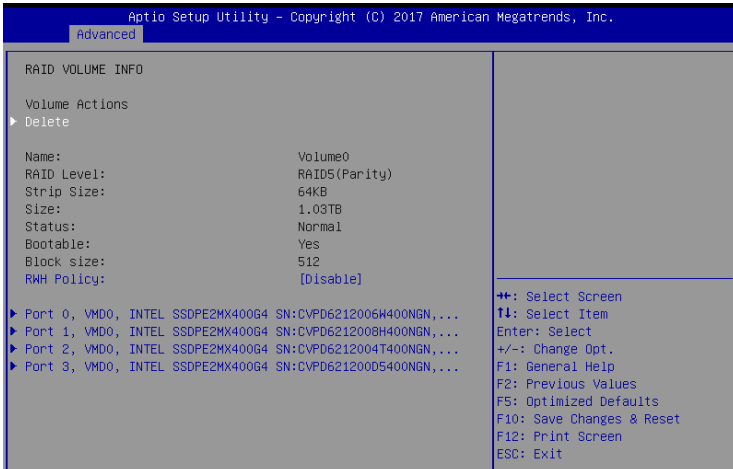

2. When the **Delete** item is selected, press <Enter>, then select **Yes** to delete the RAID volume and return to the Intel® Virtual Raid on CPU menu, or select **No** to cancel.

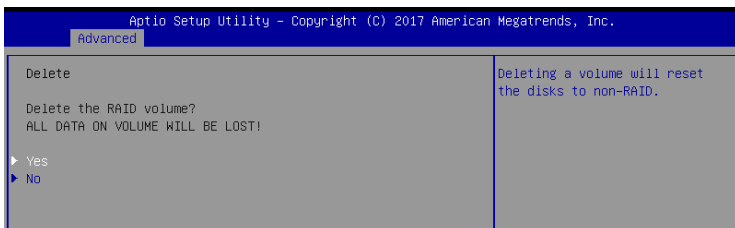

### 5.4.3 Installing the RAID controller driver during Windows® 10 OS installation

This part provides the instructions on how to install the RAID controller drivers during OS installation.

To install the RAID controller driver when installing Windows® 10 OS:

1. Boot the computer using the Windows® 10 OS installation disc. Follow the screen instructions to start installing Windows® 10.
2. When prompted to choose a type of installation, click **Custom: Install Windows only (advanced)**.

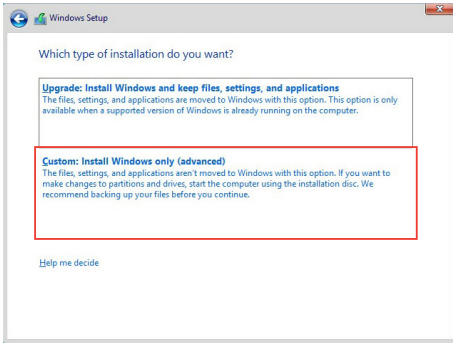

3. Click **Load Driver**.

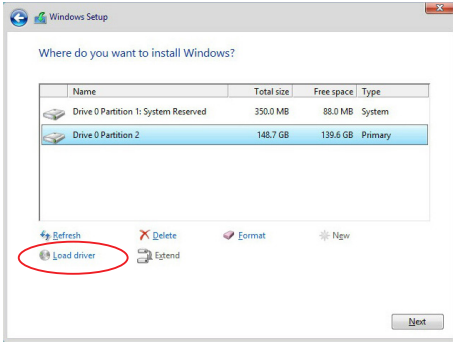

4. A message appears, reminding you to insert the installation media containing the driver of the RAID controller driver. If you have only one optical drive installed in your system, eject the Windows OS installation disc and replace with the motherboard Support DVD into the optical drive. Click **Browse** to continue.



5. Locate the driver in the corresponding folder of the support DVD then click **OK** to continue.
6. Select the RAID controller driver you need from the list and click **Next**.
7. When the system finishes loading the RAID driver, replace the motherboard Support DVD with the Windows Server installation disc. Select the drive to install Windows and click **Next**.

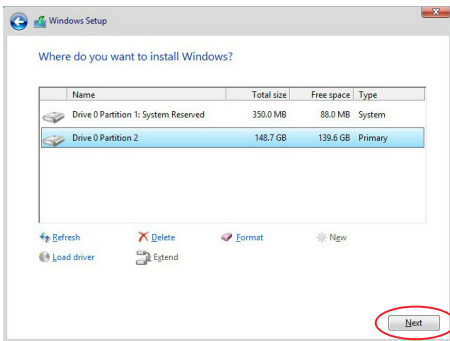

8. Setup then proceeds with the OS installation. Follow screen instructions to continue.



# Driver Installation

# 6

This chapter provides the instructions for installing the necessary drivers for different system components in both Linux<sup>®</sup> and Windows<sup>®</sup> Operating Systems.

## 6.1 RAID driver installation

After creating the RAID sets for your server system, you are now ready to install an operating system to the independent hard disk drive or bootable array. This part provides the instructions on how to install the RAID controller drivers during OS installation.

### 6.1.1 Creating a USB flash drive with RAID drive

When installing Windows® Server OS, you can load the RAID driver from a USB flash drive. You can create a USB flash drive with RAID driver in Windows by copying the files from the support DVD to the USB flash drive.

To copy the RAID driver to a USB flash drive in Windows environment:

1. Place the motherboard support DVD in the optical drive.
2. Connect a USB flash drive to your system.
3. Click on the optical drive to browse the contents of the support DVD.
4. Click **Drivers > C620 INTEL RAID > Windows > Driver** and then copy the RAID driver folder to the USB flash drive.

### 6.1.2 Installing the RAID controller driver

#### During Windows® Server 2012 R2 or 2016 OS installation

To install the RAID controller driver when installing Windows® Server OS:

1. Boot the computer using the Windows® Server installation disc. Follow the onscreen instructions to start installing Windows® Server.
2. When prompted to choose a type of installation, click **Custom: Install Windows only (advanced)**.

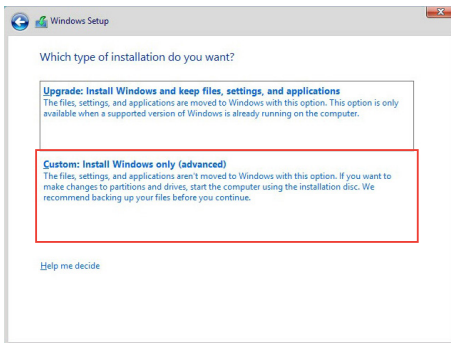

3. Click **Load Driver**.

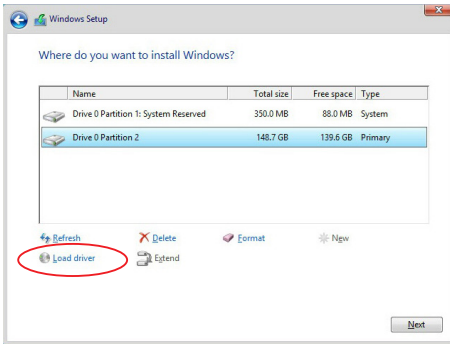

4. A message appears reminding you to insert the installation media containing the driver of the RAID controller driver (the installation media can be a CD, DVD, or USB flash drive).
- If you have only one optical drive installed in your system, eject the Windows OS installation disc and replace with the motherboard Support DVD into the optical drive.
  - Or you may connect a USB flash drive containing the RAID controller driver.

Click **Browse** to continue.

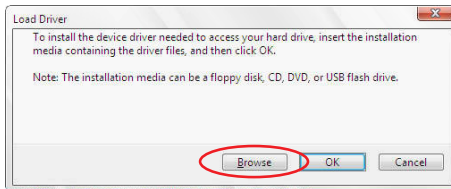

5. Locate the driver in the corresponding folder of the Support DVD or USB flash drive and then click **OK** to continue.
6. Select the RAID controller driver you need from the list and click **Next**.

7. When the system finishes loading the RAID driver,
  - Replace the motherboard Support DVD with the Windows Server installation disc.
  - Remove the USB flash drive.

Select the drive to install Windows and click **Next**.

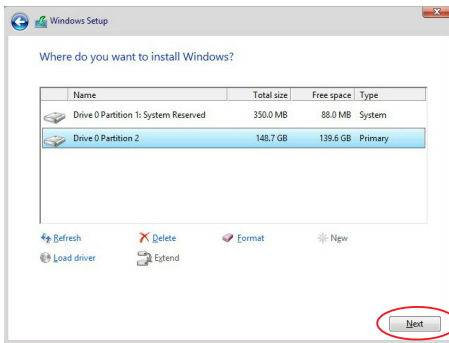

8. Setup then proceeds with the OS installation. Follow the onscreen instructions to continue.



## 6.2 Management applications and utilities installation

The support DVD that is bundled with your motherboard contains drivers, management applications, and utilities that you can install to maximize the features of your motherboard.



- The contents of the support DVD are subject to change at any time without notice. Visit the ASUS website ([www.asus.com](http://www.asus.com)) for the latest updates on software and utilities.
- The support DVD is supported on Windows® Server 2012 R2 and Windows® Server 2016.

## 6.3 Running the Support DVD

When you place the support DVD into the optical drive, the DVD automatically displays the main screen if Autorun is enabled in your computer. By default, the Drivers tab is displayed.



If Autorun is NOT enabled in your computer, browse the contents of the support DVD to locate the file **ASSETUP.EXE** from the **BIN** folder. Double-click the **ASSETUP.EXE** to run the support DVD.

The main screen of the Support DVD contains the following tabs:

1. Drivers
2. Utilities
3. Manual
4. Contact



- The main screen of the Support DVD looks exactly the same on the Windows® Server 2012 R2 and on the Windows® Server 2016 Operating System (OS).
- Onscreen display and content vary depending on the motherboard and chipset. The screenshots are provided for reference only.

### 6.3.1 Drivers menu tab

The Drivers Menu shows the available device drivers if the system detects installed devices. Install the necessary drivers to activate the devices.

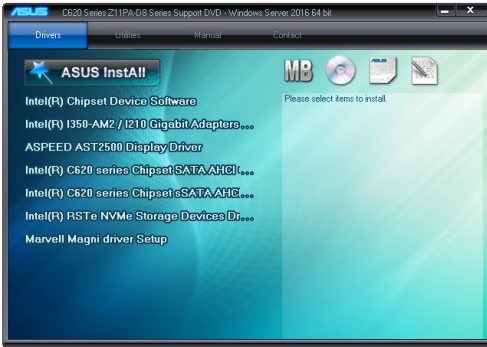

### 6.3.2 Utilities menu tab

The Utilities menu displays the software applications and utilities that the motherboard supports.



### 6.3.3 Manual menu

The Manual menu provides a list of supplementary user guides.



---

You need an internet browser installed in your OS to view the User Guide.

---



### 6.3.4 Contact information menu

The Contact menu displays the ASUS contact information, e-mail addresses, and useful links if you need more information or technical support for your motherboard.

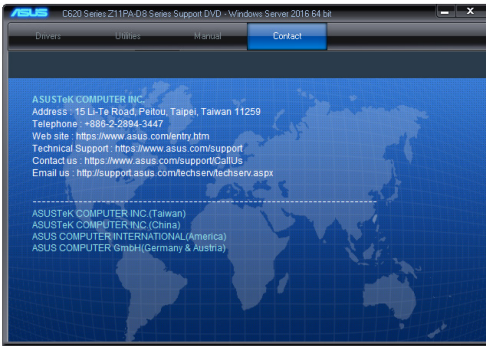

## 6.4 Intel® chipset device software installation

This section provides the instructions on how to install the Intel® chipset device software on the system.

You need to manually install the Intel® chipset device software on a Windows operating system.

To install the Intel® chipset device software:

1. Restart the computer, and then log on with **Administrator** privileges.
2. Insert the motherboard/system support DVD into the optical drive. The support DVD automatically displays the **Drivers** menu if Autorun is enabled in your computer.



If Autorun is NOT enabled in your computer, browse the contents of the support DVD to locate the file **ASSETUP.EXE** from the **BIN** folder. Double-click the **ASSETUP.EXE** to run the support DVD.

3. Click the item **Intel® Chipset Device Software** from the menu.



4. The **Intel® Chipset Device Software** window appears. Click **Next** to start the installation.

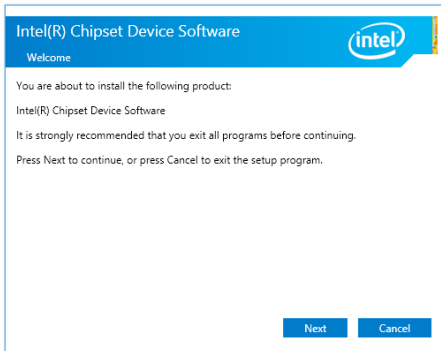

5. Read the **License Agreement** and click **Accept** to continue the process.

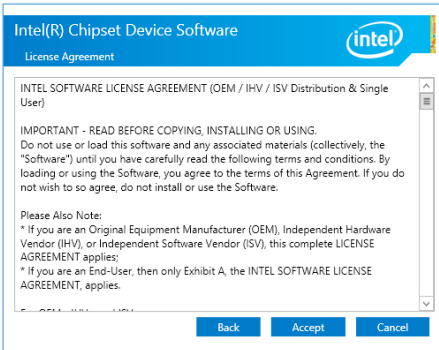

6. Read the **Readme File Information** and click **Install** to start the installation process.

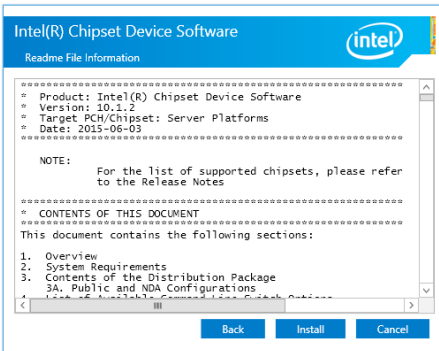

7. Click **Restart Now** to complete the setup process.

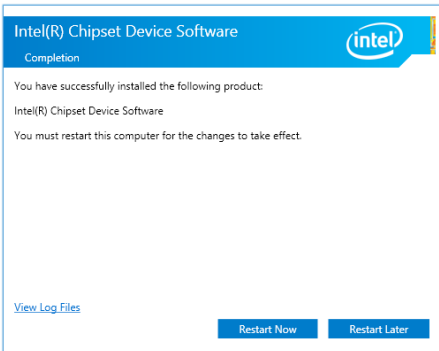

## 6.5 Installing the Intel® I210 Gigabit Adapters driver

This section provides the instructions on how to install the **Intel® I210 Gigabits Adapter Driver** on the system.

To install the **Intel® I210 Gigabit Adapters Driver** on the Windows® operating system:

1. Restart the computer.
2. Log on with **Administrator** privileges.
3. Insert the motherboard/system support DVD to the optical drive.



If Autorun is NOT enabled in your computer, browse the contents of the support DVD to locate the file **ASSETUP.EXE** from the **BIN** folder. Double-click the **ASSETUP.EXE** to run the support DVD.

4. Click **Intel® I350-AM2/I210 Gigabit Adapters Driver** in the **Drivers** menu of the main screen to start the installation.

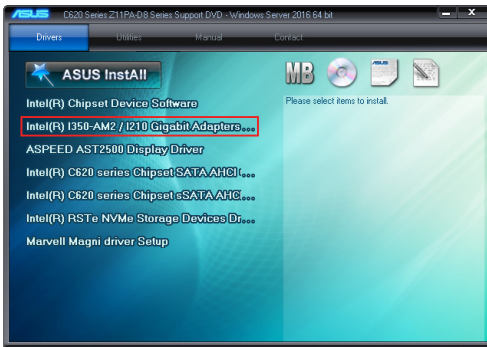

5. Click **Install Drivers and Software** option to begin installation.

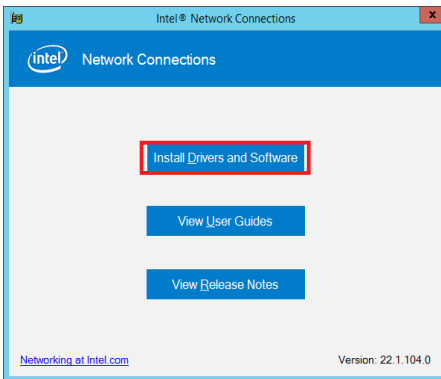

6. Click **Next** when the **Intel(R) Network Connections Install Wizard** window appears.

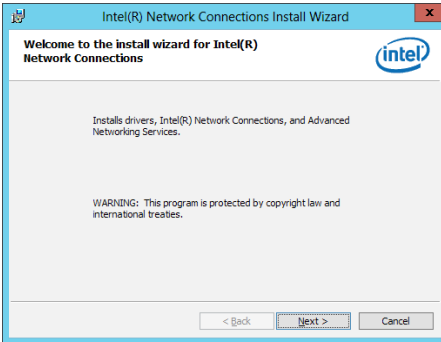

7. Tick **I accept the terms in the license agreement** and click **Next** to continue.

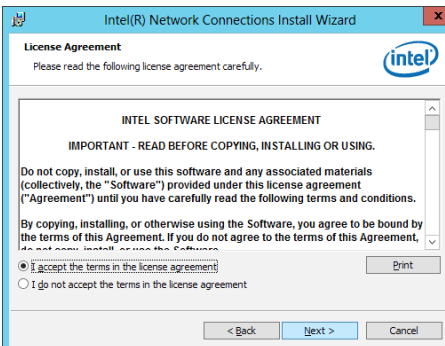

8. From the **Setup Options** window, click **Next** to start the installation.



By default, **Intel(R) PROSet for Windows Device Manager** and **Windows PowerShell Module** are ticked.

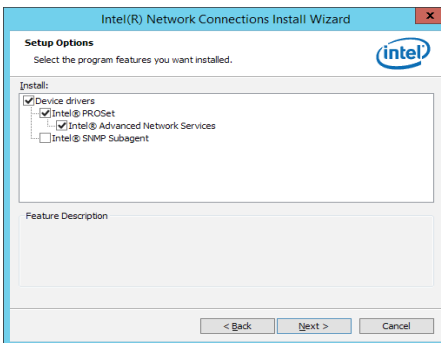

9. Click **Install** to start the installation.

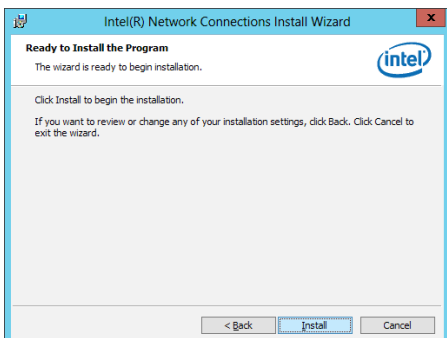

10. When the installation is done, press **Finish** to complete the installation.

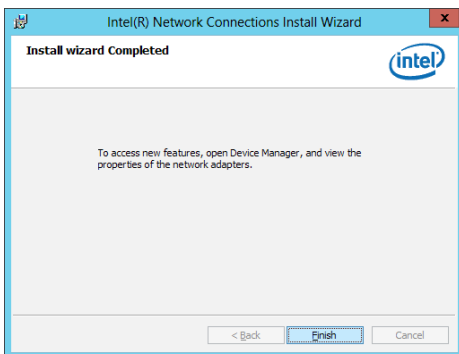



## 6.6 VGA driver installation

This section provides the instructions on how to install the ASPEED Video Graphics Adapter (VGA) driver.

You need to manually install the ASPEED VGA driver on a Windows® operating system.

To install the ASPEED VGA driver:

1. Restart the computer, and then log on with **Administrator** privileges.
2. Insert the motherboard/system support DVD into the optical drive. The support DVD automatically displays the **Drivers** menu if Autorun is enabled in your computer.



If Autorun is **NOT** enabled in your computer, browse the contents of the support DVD to locate the file **ASSETUP.EXE** from the **BIN** folder. Double-click the **ASSETUP.EXE** to run the support DVD.

3. Click the **ASPEED AST2500 Display Driver** to begin installation.

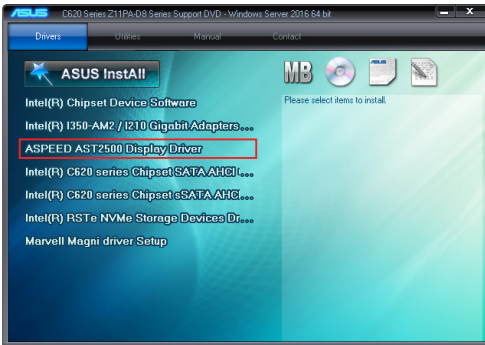

4. From the installation window, click **Next** to start the installation.

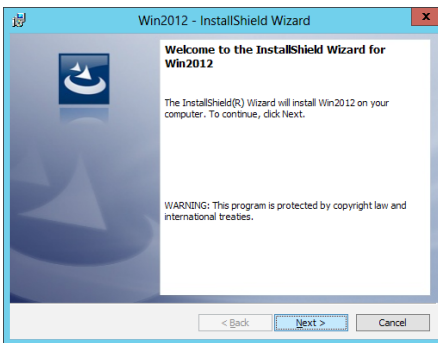

5. Click **Install** to start the installation process.

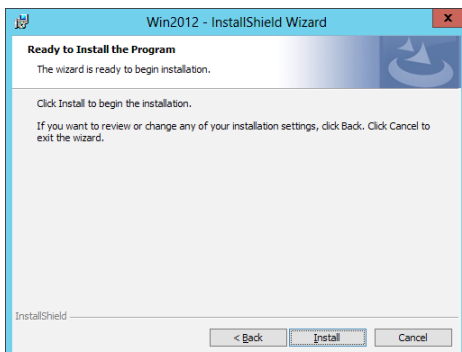

6. Click **Finish** to complete the installation.

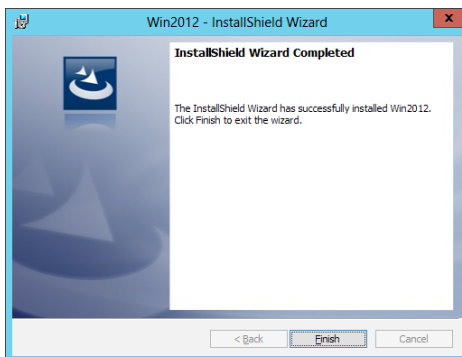

## 6.7 Intel® Rapid Storage Technology enterprise 5.0 installation

This section provides the instructions on how to install the Intel® Rapid Storage Technology enterprise 5.0 on the system.

You need to manually install the Intel® Rapid Storage Technology enterprise 5.0 utility on a Windows® operating system.

To install the Intel® Rapid Storage Technology enterprise 5.0 utility:

1. Restart the computer, and then log on with **Administrator** privileges.
2. Insert the motherboard/system support DVD into the optical drive, and navigate to the **Utilities** menu.
3. Click the **Intel® Rapid Storage Technology enterprise** to begin installation.



4. The **Intel® Rapid Storage Technology enterprise** window appears. Click **Next** to start the installation.

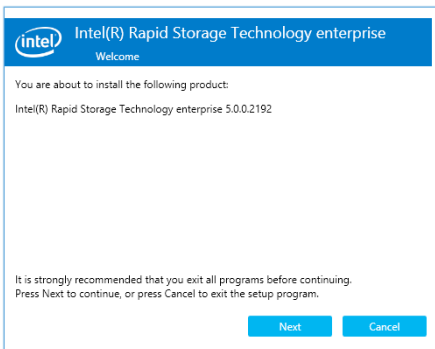

5. Read the **Warning** message and click **Next** to continue.

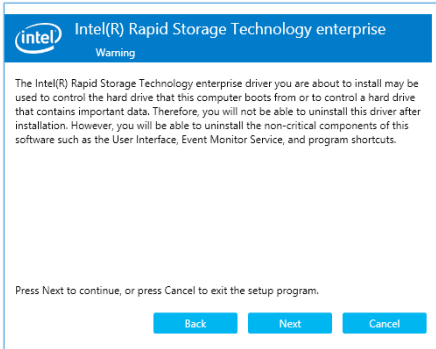

6. Read the **License Agreement** and click **Accept** to continue the process.

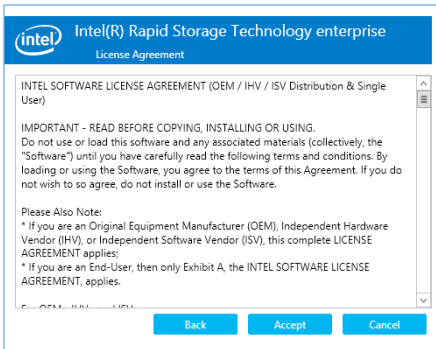

7. Select the destination folder and click **Next** to continue.

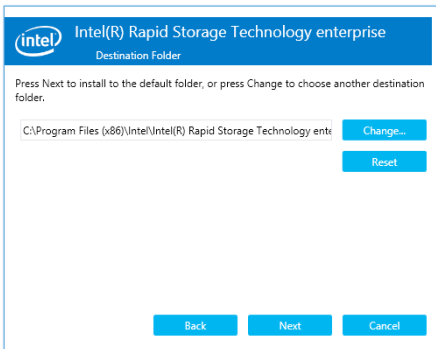

8. Tick the features that you would like to install and click **Next** to continue.

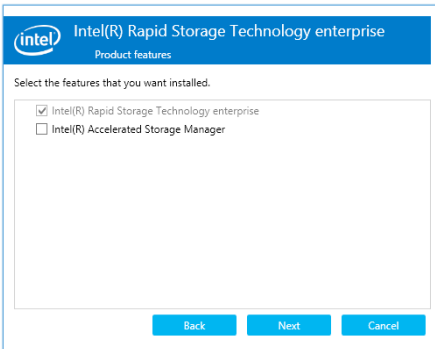

9. Click **Install** to start the installation process.

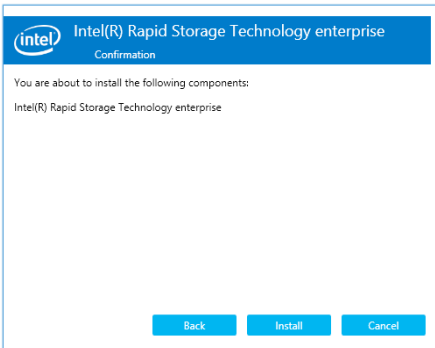

10. Click **Restart Now** to complete the setup process.

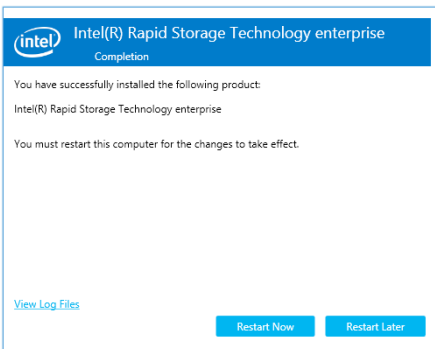



# Appendix



This appendix includes additional information that you may refer to when configuring the motherboard.

# Z11PA-D8C Series block diagram

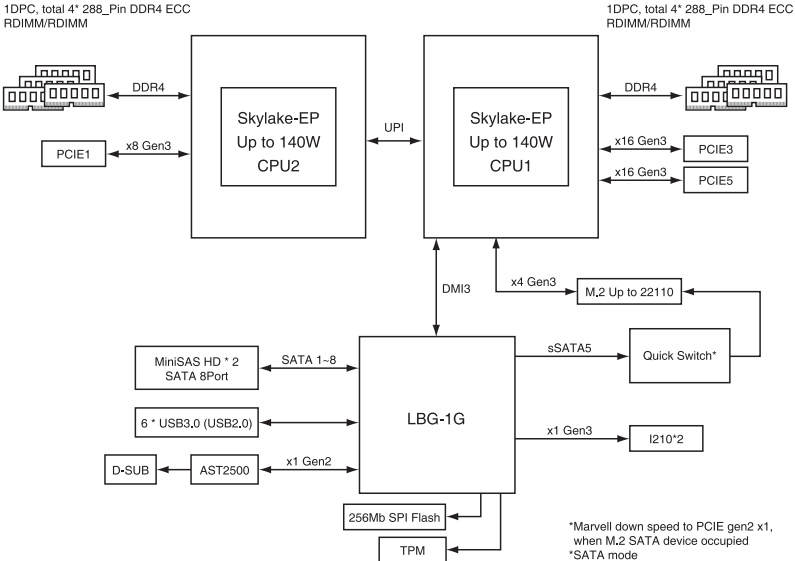



## Q-Code table

Action	PHASE	POST CODE	TYPE	DESCRIPTION
Normal boot	Security Phase	01	Progress	First post code(POWER_ON_POST_CODE)
		02	Progress	Load BSP microcode(MICROCODE_POST_CODE)
		03	Progress	Set cache as ram for PEI phase(CACHE_ENABLED_POST_CODE)
		06	Progress	CPU Early init.(CPU_EARLY_INIT_POST_CODE)
		04	Progress	initializes South bridge for PEI preparation
	PEI (Pre-EFI initialization) phase	10	Progress	PEI Core Entry
		15	Progress	NB initialize before installed memory
		19	Progress	SB initialize before installed memory
		78-00	Progress	Wait BMC ready(duration: 120 seconds)
		A1	MRC Progress	QPI initialization
		A3	MRC Progress	QPI initialization
		A7	MRC Progress	QPI initialization
		A8	MRC Progress	QPI initialization
		A9	MRC Progress	QPI initialization
		AA	MRC Progress	QPI initialization
		AB	MRC Progress	QPI initialization
		AC	MRC Progress	QPI initialization
		AD	MRC Progress	QPI initialization
		AE	MRC Progress	QPI initialization
		AF	MRC Progress	QPI initialization Complete
		2F	Progress	Memory Init.
		B0	MRC Progress	Memory Init.
		B1	MRC Progress	Memory Init.
		AF	MRC Progress	RC Reset if require
		B4	MRC Progress	Memory Init.
		B2	MRC Progress	Memory Init.
		B3	MRC Progress	Memory Init.
		B5	MRC Progress	Memory Init.
		B6	MRC Progress	Memory Init.
		B7	MRC Progress	Memory Init.
		B8	MRC Progress	Memory Init.
		B9	MRC Progress	Memory Init.
		BA	MRC Progress	Memory Init.
		BB	MRC Progress	Memory Init.
		BC	MRC Progress	Memory Init.
		BF	MRC Progress	Memory Init. Done
		5A	MRC Progress	Other config. After RC end
		31	Progress	Memory already installed
		32	Progress	CPU Init.
		34	Progress	CPU Init.
	36	Progress	CPU Init.	
	4F	Progress	DXE Initial Program Load(IPL)	

(continued on the next page)

# Q-Code table

Action	PHASE	POST CODE	TYPE	DESCRIPTION
Normal boot	DXE (Driver Execution Environment) phase	60	Progress	DXE Core Started
		61	Progress	DXE NVRAM Init.
		62	Progress	SB run-time init.
		63	Progress	DXE CPU Init
		68	Progress	NB Init.
		69	Progress	NB Init.
		6A	Progress	NB Init.
		70	Progress	SB Init.
		71	Progress	SB Init.
		72	Progress	SB Init.
	78	Progress	ACPI Init.	
	79	Progress	CSM Init.	
	90	Progress	BDS started	
	91	Progress	Connect device event	
	92	Progress	PCI Bus Enumeration.	
	93	Progress	PCI Bus Enumeration.	
	94	Progress	PCI Bus Enumeration.	
	95	Progress	PCI Bus Enumeration.	
	96	Progress	PCI Bus Enumeration.	
	97	Progress	Console outout connect event	
	98	Progress	Console input connect event	
	99	Progress	AMI Super IO start	
	9A	Progress	AMI USB Driver Init.	
	9B	Progress	AMI USB Driver Init.	
	9C	Progress	AMI USB Driver Init.	
	9D	Progress	AMI USB Driver Init.	
	b2	Progress	Legacy Option ROM Init.	
	b3	Progress	Reset system	
	b4	Progress	USB hotplug	
	b6	Progress	NVRAM clean up	
	b7	Progress	NVRAM configuration reset	
	A0	Progress	IDE, AHCI Init.	
	A1	Progress	IDE, AHCI Init.	
	A2	Progress	IDE, AHCI Init.	
	A3	Progress	IDE, AHCI Init.	
	A8	Progress	BIOS Setup Utility password verify	
	A9	Progress	BIOS Setup Utility start	
	AB	Progress	BIOS Setup Utility input wait	
	AD	Progress	Ready to boot event	
	AE	Progress	Legacy boot event	
	Operating system phase	AA	Progress	APIC mode
		AC	Progress	PIC mode

# Simplified EU Declaration of Conformity

**English** ASUSTeK Computer Inc. hereby declares that this device is in compliance with the essential requirements and other relevant provisions of related Directives. Full text of EU declaration of conformity is available at: [www.asus.com/support](http://www.asus.com/support)

**Français** ASUSTeK Computer Inc. déclare par la présente que cet appareil est conforme aux critères essentiels et autres clauses pertinentes des directives concernées. La déclaration de conformité de l'UE peut être téléchargée à partir du site Internet suivant : [www.asus.com/support](http://www.asus.com/support)

**Deutsch** ASUSTeK Computer Inc. erklärt hiermit, dass dieses Gerät mit den wesentlichen Anforderungen und anderen relevanten Bestimmungen der zugehörigen Richtlinien übereinstimmt. Der gesamte Text der EU-Konformitätserklärung ist verfügbar unter: [www.asus.com/support](http://www.asus.com/support)

**Italiano** ASUSTeK Computer Inc. con la presente dichiara che questo dispositivo è conforme ai requisiti essenziali e alle altre disposizioni pertinenti con le direttive correlate. Il testo completo della dichiarazione di conformità UE è disponibile all'indirizzo: [www.asus.com/support](http://www.asus.com/support)

**Русский** Компания ASUS заявляет, что это устройство соответствует основным требованиям и другим соответствующим условиям соответствующих директив. Подробную информацию, пожалуйста, смотрите на [www.asus.com/support](http://www.asus.com/support)

**Български** С настоящото ASUSTeK Computer Inc. декларира, че това устройство е в съответствие със съществените изисквания и другите приложни постановления на свързаните директиви. Пълният текст на декларацията за съответствие на ЕС е достъпна на адрес: [www.asus.com/support](http://www.asus.com/support)

**Hrvatski** ASUSTeK Computer Inc. ovim izjavljuje da je ovaj uređaj skladan s bitnim zahtjevima i ostalim odgovarajućim odredbama vezanih direktiva. Cijeli tekst EU izjave o sukladnosti dostupan je na: [www.asus.com/support](http://www.asus.com/support)

**Čeština** Společnost ASUSTeK Computer Inc. tímto prohlašuje, že toto zařízení splňuje základní požadavky a další příslušná ustanovení souvisejících směrnic. Plně znění prohlášení o shodě EU je k dispozici na adrese: [www.asus.com/support](http://www.asus.com/support)

**Dansk** ASUSTeK Computer Inc. erklærer hermed, at denne enhed er i overensstemmelse med hovedkravene og andre relevante bestemmelser i de relaterede direktiver. Hele EU-overensstemmelseserklæringen kan findes på: [www.asus.com/support](http://www.asus.com/support)

**Nederlands** ASUSTeK Computer Inc. verklaart hierbij dat dit apparaat voldoet aan de essentiële vereisten en andere relevante bepalingen van de verwante richtlijnen. De volledige tekst van de EU-verklaring van conformiteit is beschikbaar op: [www.asus.com/support](http://www.asus.com/support)

**Eesti** Käesolevaga kinnitab ASUSTeK Computer Inc, et see seade vastab asjakohaste direktiivide olulistele nõuetele ja teisteles asjaspeetuvatele sätetele. EL vastavusdeklaratsiooni täielik tekst on saadaval järgmisel aadressil: [www.asus.com/support](http://www.asus.com/support)

**Suomi** ASUSTeK Computer Inc. ilmoittaa täten, että tämä laite on asiaankuuluvien direktiivien olennaisten vaatimusten ja muiden tätä koskevien säädösten mukainen. EU-yhdenmukaisuusilmoituksen koko teksti on luettavissa osoitteessa: [www.asus.com/support](http://www.asus.com/support)

**Ελληνικά** Με το παρόν, η ASUSTeK Computer Inc. δηλώνει ότι αυτή η συσκευή συμμορφώνεται με τις θεμελιώδεις απαιτήσεις και άλλες σχετικές διατάξεις των Οδηγών της ΕΕ. Το πλήρες κείμενο της δήλωσης συμμόρφότητας είναι διαθέσιμο στη διεύθυνση: [www.asus.com/support](http://www.asus.com/support)

**Magyar** Az ASUSTeK Computer Inc. ezennel kijelenti, hogy ez az eszköz megfelel a kapcsolódó irányelvek lényeges követelményeinek és egyéb vonatkozó rendelkezéseinek. Az EU megfeleléségi nyilatkozat teljes szövege innen letölthető: [www.asus.com/support](http://www.asus.com/support)

**Latviski** ASUSTeK Computer Inc. ar šo paziņo, ka šī ierīce atbilst saistīto Direktīvu būtiskajām prasībām un citiem citiem saistītajiem nosacījumiem. Pilns ES atbilstības paziņojuma teksts pieejams šeit: [www.asus.com/support](http://www.asus.com/support)

**Lietuvių** ASUSTeK Computer Inc. šiuo tvirtina, kad šis įrenginys atitinka pagrindinius reikalavimus ir kitas svarbias susijusių direktyvų nuostatas. Visą ES atitikties deklaracijos tekstą galima rasti: [www.asus.com/support](http://www.asus.com/support)

**Norsk** ASUSTeK Computer Inc. erklærer herved at denne enheten er i samsvar med hovedsaklige krav og andre relevante forskrifter i relaterte direktiver. Fullstendig tekst for EU-samsvarserklæringen finnes på: [www.asus.com/support](http://www.asus.com/support)

**Polski** Firma ASUSTeK Computer Inc. niniejszym oświadczca, że urządzenie to jest zgodne z zasadniczymi wymogami i innymi właściwymi postanowieniami powiązanych dyrektyw. Pełny tekst deklaracji zgodności UE jest dostępny pod adresem: [www.asus.com/support](http://www.asus.com/support)

**Português** A ASUSTeK Computer Inc. declara que este dispositivo está em conformidade com os requisitos essenciais e outras disposições relevantes das Diretivas relacionadas. Texto integral da declaração da UE disponível em: [www.asus.com/support](http://www.asus.com/support)

**Română** ASUSTeK Computer Inc. declară că acest dispozitiv se conformează cerințelor esențiale și altor prevederi relevante ale directivelor conexe. Textul complet al declarației de conformitate a Uniunii Europene se găsește la: [www.asus.com/support](http://www.asus.com/support)

**Srpski** ASUSTeK Computer Inc. ovim izjavljuje da je ovaj uređaj u saglasnosti sa osnovnim zahtevima i drugim relevantnim odredbama povezanih Direktiva. Pun tekst EU deklaracije o usaglasnosti je dostupan da adres: [www.asus.com/support](http://www.asus.com/support)

**Slovensky** Spoločnosť ASUSTeK Computer Inc. týmto vyhlasuje, že toto zariadenie vyhovuje základným požiadavkám a ostatným príslušným ustanoveniam príslušných smerníc. Celý text vyhlásenia o zhode pre štáty EU je dostupný na adrese: [www.asus.com/support](http://www.asus.com/support)

**Slovenščina** Spoločnosť ASUSTeK Computer Inc. izjavlja, da je ta naprava skladna z bistvenimi zahtevami in drugimi ustreznimi določbami povezanih direktiv. Celotno besedilo EU-izjave o skladnosti je na voljo na spletnem mestu: [www.asus.com/support](http://www.asus.com/support)

**Español** Por la presente, ASUSTeK Computer Inc. declara que este dispositivo cumple los requisitos básicos y otras disposiciones pertinentes de las directivas relacionadas. El texto completo de la declaración de la UE de conformidad está disponible en: [www.asus.com/support](http://www.asus.com/support)

**Svenska** ASUSTeK Computer Inc. förklarar härmed att denna enhet överensstämmer med de grundläggande kraven och andra relevanta föreskrifter i relaterade direktiv. Fulltext av EU-försäkran om överensstämmelse finns på: [www.asus.com/support](http://www.asus.com/support)

**Українська** ASUSTeK Computer Inc. заявляє, що цей пристрій відповідає основним вимогам та іншим відповідним положенням відповідних Директив. Повний текст декларації відповідності стандартам СС доступний на: [www.asus.com/support](http://www.asus.com/support)

**Türkçe** ASUSTeK Computer Inc., bu aygıtın temel gereksinimlerle ve ilişkili Yönergelelerin diğer ilgili koşullarıyla uyumlu olduğunu beyan eder. AB uygunluk bildiriminin tam metni şu adreste bulunabilir: [www.asus.com/support](http://www.asus.com/support)

**Bosanski** ASUSTeK Computer Inc. ovim izjavljuje da je ovaj uređaj usklađen sa bitnim zahtjevima i ostalim odgovarajućim odredbama vezanih direktiva. Cijeli tekst EU izjave o usklađenosti dostupan je na: [www.asus.com/support](http://www.asus.com/support)

## ASUS contact information

### ASUSTeK COMPUTER INC.

Address 4F, No. 150, Li-Te Rd., Peitou, Taipei 112, Taiwan  
Telephone +886-2-2894-3447  
Fax +886-2-2890-7798  
Web site <https://www.asus.com>

#### **Technical Support**

Telephone +86-21-38429911  
Fax +86-21-58668722 ext: 9101  
Online Support <https://www.asus.com/support/Product/ContactUs/Services/questionform/?lang=en>

### ASUSTeK COMPUTER INC. (Taiwan)

Address 4F, No. 150, Li-Te Rd., Peitou, Taipei 112, Taiwan  
Telephone +886-2-2894-3447  
Fax +886-2-2890-7798  
Web site <https://www.asus.com/tw/>

#### **Technical Support**

Telephone +886-2-2894-3447 (0800-093-456)  
Online Support <https://www.asus.com/support/Product/ContactUs/Services/questionform/?lang=zh-tw>

### ASUSTeK COMPUTER INC. (China)

Address No. 5077, Jindu Road, Minhang District, Shanghai, China  
Telephone +86-21-5442-1616  
Fax +86-21-5442-0099  
Web site <https://www.asus.com.cn>

#### **Technical Support**

Telephone +86-20-2804-7506 (400-620-6655)  
Online Support <https://www.asus.com/support/Product/ContactUs/Services/questionform/?lang=zh-cn>

## ASUS contact information

### ASUS COMPUTER INTERNATIONAL (America)

Address 48720 Kato Rd., Fremont, CA 94538, USA  
Fax +1-510-608-4555  
Web site <https://www.asus.com/us/>

#### **Technical Support**

Support fax +1-812-284-0883  
General support +1-812-282-2787  
Online support <https://www.asus.com/support/Product/ContactUs/Services/questionform/?lang=en-us>

### ASUS COMPUTER GmbH (Germany and Austria)

Address Harkort Str. 21-23, 40880 Ratingen, Germany  
Fax +49-2102-959911  
Web site <https://www.asus.com/de/>

#### **Technical Support**

Telephone +49-1805-010923  
Support Fax +49-2102-959911  
Online support <https://www.asus.com/support/Product/ContactUs/Services/questionform/?lang=de-de>

### ASUS Czech Service s.r.o. (Europe)

Address Na Rovince 887, 720 00 Ostrava – Hrabová,  
Czech Republic  
Telephone +420-596766888  
Web site <https://www.asus.com/cz/>

#### **Technical Support**

Telephone +420-596-766-891  
Fax +420-596-766-329  
E-mail [advance.rma.eu@asus.com](mailto:advance.rma.eu@asus.com)  
Online Support <https://www.asus.com/support/Product/ContactUs/Services/questionform/?lang=cs-cz>

## ASUS contact information

### ASUS Holland BV (The Netherlands)

Address Marconistraat 2, 7825GD EMMEN, The Netherlands  
Web site <https://www.asus.com/nl/>

#### **Technical Support**

Telephone +31-(0)591-5-70292  
Fax +31-(0)591-666853  
E-mail [advance.rma.eu@asus.com](mailto:advance.rma.eu@asus.com)  
Online Support <https://www.asus.com/support/Product/ContactUs/Services/questionform/?lang=nl-nl>

### ASUS Polska Sp. z o.o. (Poland)

Address Ul. Postępu 6, 02-676 Warszawa, Poland  
Web site <https://www.asus.com/pl/>

#### **Technical Support**

Telephone +48-225718033  
Online Support <https://www.asus.com/support/Product/ContactUs/Services/questionform/?lang=pl-pl>

### ASK-Service (Russia and CIS)

Address г.Москва, ул. Орджоникидзе, д.10, Россия  
Telephone (495) 640-32-75  
Web site <https://www.asus.com/ru/>

#### **Technical Support**

Telephone 008-800-100-ASUS (008-800-100-2787)  
Online Support <https://www.asus.com/support/Product/ContactUs/Services/questionform/?lang=ru-ru>

# FCC COMPLIANCE INFORMATION

Per FCC Part 2 Section 2.1077(a)



**Responsible Party:** **Asus Computer International**

**Address:** **800 Corporate Way, Fremont, CA 94539.**

**Phone/Fax No:** **(510)739-3777/(510)608-4555**

**hereby declares that the product**

**Product Name :** **Motherboard**

**Model Number :** Z11PA-D8, Z11PA-D8C

**compliance statement:**

This device complies with part 15 of the FCC Rules. Operation is subject to the following two conditions: (1) This device may not cause harmful interference, and (2) this device must accept any interference received, including interference that may cause undesired operation.

Ver. 180125





## Free Manuals Download Website

<http://myh66.com>

<http://usermanuals.us>

<http://www.somanuals.com>

<http://www.4manuals.cc>

<http://www.manual-lib.com>

<http://www.404manual.com>

<http://www.luxmanual.com>

<http://aubethermostatmanual.com>

Golf course search by state

<http://golfingnear.com>

Email search by domain

<http://emailbydomain.com>

Auto manuals search

<http://auto.somanuals.com>

TV manuals search

<http://tv.somanuals.com>