

BOSCH 5000 SERIES WALL OVENS
Use and Care Manual

BOSCH

YOUR LIFE. OUR INSPIRATION.



Table of Contents

Important Safety Instructions	1	Convection Broil	10
Getting Started		Convection Roast	11
To Set the Clock:	2	Dehydrate.....	12
To Use the Oven Lights:.....	2	Self-Cleaning.....	13
Oven Parts and Accessories:	3	Maintenance	
Oven Control Panel.....	4	To Replace a Light Bulb	15
Command buttons.....	4	Cleaning	15
Display	4	Removing the Oven Door.....	16
Knobs.....	4	Do-It-Yourself Procedures	
Other Features.....	4	To Activate Sabbath Mode.....	17
General Oven Tips		To Change Clock Format	17
Suggestions for Use.....	5	To Change Temperature Format	17
Advantages of Convection Cooking	5	To Change Temperature Calibration	17
About Convection Cooking*	5	To Change Operating Voltage	17
Oven Operation Overview:	5	Self Help	
Preheating the Oven.....	5	Baking.....	18
Bakeware	5	Operation	19
Oven Racks.....	6	Problem Solving Steps	19
Selecting the Rack Position	6	Service Data Record	20
Using Multiple Racks.....	6	Obtaining Service	19
Condensation	7	Warranty	20
Temperature Sensor	7		
High Altitude Baking	7		
Food Serving Temperature Guidelines	7		
Setting the Oven			
To Set the Cooking Mode:	8		
To Set the Timer:	8		
To Set the Cooking Mode using Fast Preheat:	8		
Timed Cooking Modes	8		
To Set the Timed Mode:.....	8		
To Set the Delayed Mode:	8		
Oven Modes			
Bake	9		
Convection Bake	9		
Broil	10		



Important Safety Instructions

Please read all instructions before using this appliance.

When properly cared for, your new Bosch oven has been designed to be a safe, reliable appliance.

Read all instructions carefully before using this oven. These precautions will reduce the risk of burns, electric shock, fire and injury to persons. When using kitchen appliances, basic safety precautions must be followed, including the following:

- This appliance must be properly installed and grounded by a qualified technician. Connect only to properly grounded outlet. See electric preparation and connection instructions in the Installation Instructions.
- This appliance should be serviced only by a qualified service technician. Contact the nearest authorized service center for examination, repair or adjustment.
- Do not repair or replace any part of the oven unless specifically recommended. Refer service to an authorized service center.
- Do not operate this appliance if it is not working properly or if it has been damaged, until an authorized technician has examined it.
- Install or locate this appliance only in accordance with the Installation Instructions.
- Use this oven only as intended by the manufacturer. If you have any questions, contact the manufacturer.
- Do not cover or block any openings on this appliance.
- Use this appliance only for its intended use as described in this manual. Do not use corrosive chemicals, vapors, or nonfood products in this appliance. This type of oven is specifically designed to heat or cook. It is not designed for industrial or laboratory use. The use of corrosive chemicals in heating or cleaning will damage the appliance.
- In the event that personal clothing or hair catches fire, DROP AND ROLL IMMEDIATELY to extinguish flames.
- This oven is intended for residential use only. It is not approved for outdoor use.

- Do not allow children to use this appliance unless closely supervised by an adult. Children and pets should not be left alone or unattended in the area where the appliance is in use. Never allow children to sit or stand on any part of the oven.
- Do not store items of interest to children above the oven. If children should climb onto the appliance to reach these items, they could be seriously injured.

To reduce the risk of fire in the oven cavity:

1. Do not store flammable materials in or near the oven.
2. Do not use water on a grease fire. Smother fire or use a dry chemical or foam-type extinguisher.
3. Have a fire extinguisher readily available and highly visible next to any cooking appliance. Be sure you know how to use it.
4. Do not overcook food. Carefully attend oven if paper, plastic or other combustible materials are placed inside the oven.
5. Do not use the cavity for storage purposes. Do not leave paper products, cooking utensils or food in the cavity when not being used.
6. If materials inside the oven should ignite, keep oven door closed. Turn oven off and disconnect the circuit at the circuit breaker box.
7. Do not block any vent openings.
8. Be sure the blower fan runs when the oven is in operation. If the fan does not operate, do not use the oven. Call an authorized service center.
9. Never use the oven to warm or heat a room. This can damage the oven parts.
10. For personal safety, wear proper clothing. Loose fitting garments or garments with hanging sleeves should never be worn while using this appliance.



WARNING

The California Safe Drinking Water and Toxic Enforcement Act requires businesses to warn customers of potential exposure to substances which are known by the State of California to cause cancer or reproductive harm.

The elimination of soil during self-cleaning generates some by-products which are on this list of substances.

To minimize exposure to these substances, always operate this oven according to the instructions in this manual and provide good ventilation to the room during and immediately after self-cleaning the oven.

REGARDING PET BIRDS

Birds have very sensitive respiratory systems. Keep pet birds out of the kitchen or other rooms where kitchen fumes could reach them. During Self-Clean mode, fumes that may be harmful to birds are released. Other kitchen fumes, such as from overheating margarines and cooking oils, may also be harmful.

Continued on next page



Important Safety Instructions

Please read all instructions before using this appliance.

SAFETY PRECAUTIONS

- Tie long hair so that it doesn't hang loose.
- The heating elements may be hot even though they are dark in color. Interior surfaces of an oven become hot enough to cause burns.
- During and after use, do not press or let clothing or other flammable materials contact the heating elements or the interior surfaces of the oven until they have had sufficient time to cool.
- The trim on the top and sides of the oven door may become hot enough to cause burns.
- Use care when opening the door. Open the door slightly to let hot air or steam escape before removing or replacing food.
- Do not heat unopened food containers. Buildup of pressure may cause the container to burst and result in injury.
- Always place oven racks in desired location while oven is cool. If a rack must be moved while oven is hot, do not let potholder contact the heating elements.
- Use only dry potholders. Moist or damp potholders on hot surfaces may result in burns from steam. Do not let potholders touch hot heating elements. Do not use a towel or other bulky cloth.

SAFETY PRECAUTIONS WITH SELF-CLEANING OVEN

- Confirm that the door locks and will not open once the door lock icon appears. If door does not lock, press OVEN OFF and do not run Self-Clean. Phone 800-944-2904 for service (see page 19 for obtaining service).
- Note: During a normal Self-Clean and a Delayed Self-Clean cycle, the door locks within 25 to 30 seconds after start is pressed.
- Do not clean the door gasket. It is essential for a good seal. Care should be taken not to rub, damage, move or remove the door gasket.
- Do not use commercial oven cleaners or oven liner protective coatings of any kind in or around any part of the oven.
- Clean only oven parts listed in this manual.
- Before self-cleaning the oven, **remove the broiler pan, all oven racks, other utensils and excess soft spillage.**
- Listen for fan. If no fan is heard, call for service. See page 19.

Getting Started

To Set the Clock:

1. **Press SET CLOCK.** The hours flash and **CLOCK** appears in the display.
2. **Press +** or **-** to set hour.
3. **Press SET CLOCK.** The minutes flash.
4. **Press +** or **-** to set minutes.
5. **Press SET CLOCK**

The clock appears in the display at all times except when the timer or a timed cooking operation is running.

To Use the Oven Lights:

1. **Press LIGHT** to turn the oven lights on or off.
In double ovens, the lights in both ovens will turn on or off together. To control the lights in one oven only:
 1. **Press UPPER/LOWER** to select the oven
 2. **Press LIGHT** to turn lights on or off.

Oven lights turn on automatically when:

- the door is opened.
- the oven is turned on.

Oven lights will turn off automatically when:

- the oven is turned off.
- the oven mode is cancelled.

The lights do not operate in the Self-Clean mode.

Getting Started

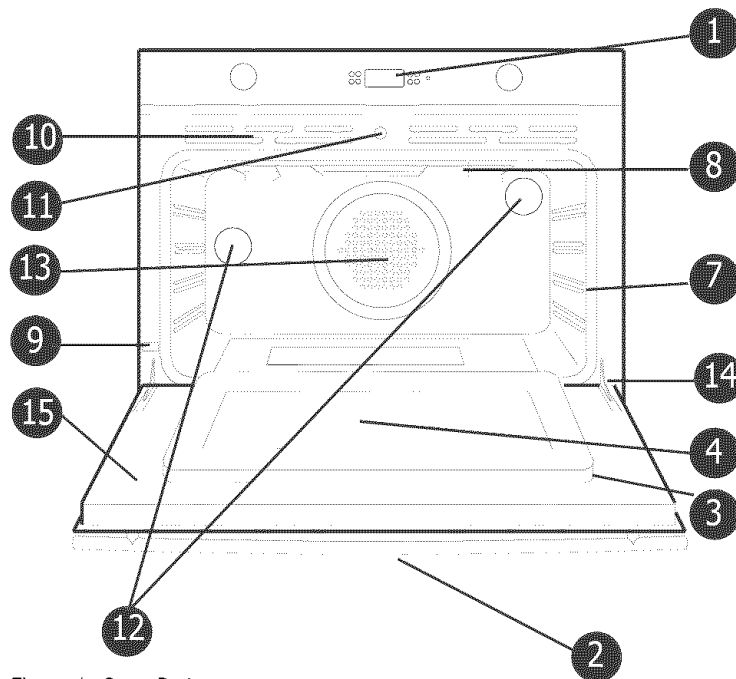

Figure 1: Oven Parts

Oven Parts and Accessories:

- | | |
|--|--|
| 1 Control Panel | 10 Oven Cooling Vents (both ovens) |
| 2 Door Handle | 11 Automatic Door Lock Latch (one per oven) |
| 3 Oven Door Gasket (one per oven) | 12 Halogen Oven Lights (2 in each oven) |
| 4 Window | 13 Convection Fan and Cover (one per oven) |
| 5 Removable Oven Racks; 2-5 depending on oven model (not shown) | 14 Door Hinge |
| 6 Broil Pan and Grid (not shown) | 15 Removable Oven Door |
| 7 Rack Position Guides (4 in each oven) | 16 Literature Pack |
| 8 Broil Element (one in each oven) | |
| 9 Data Plate | |

Getting Started

Oven Control Panel

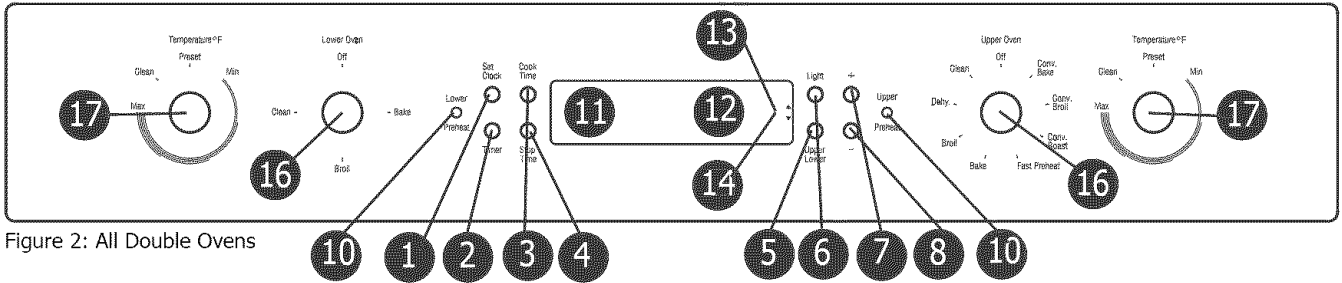

Figure 2: All Double Ovens

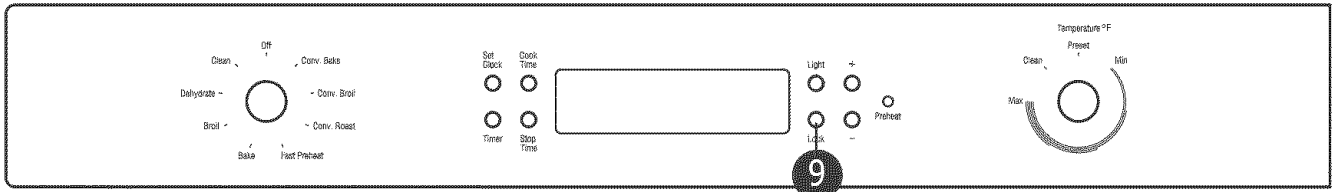

Figure 3: HBL504 and HBN54 Model Single Ovens

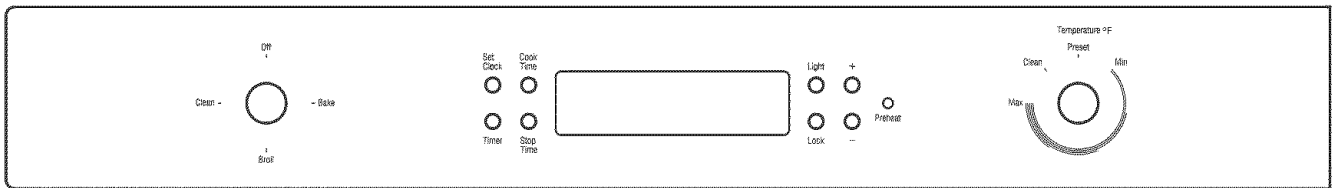

Figure 4: HBL503 Model Single Ovens

Command buttons

1. **SET CLOCK:** Press to set or change the time of day.
2. **TIMER:** Press to set or clear the timer.
3. **COOK TIME:** Press to set a timed cook mode.
4. **STOP TIME:** Press to set the stop time in a delayed cook mode.
5. **UPPER LOWER** (Double ovens only): Press to select upper or lower oven before setting lights, etc.
6. **LIGHT:** Press to turn oven lights on or off.
7. **+**: Press to increase the time in one of the above functions by one minute at a time. Press and hold to increase by 10 minutes at a time
8. **-**: Press to decrease the time in one of the above functions by one minute at a time. Press and hold to increase by 10 minutes at a time.
9. **LOCK:** For single ovens, press and hold lock and + buttons at same time to turn safety lock on or off. For double ovens, press and hold + and - buttons to turn safety lock on or off (use Upper Lower button to select oven first). This function locks the oven door for safety purposes.

Display

10. **PREHEAT LIGHT** (one for each oven): Lights up when oven is preheating
11. **TIME:** Green digits to left of display. Displays time of day and timer.
12. **TEMPERATURE:** Red digits to right of display. Displays the chosen temperature for the oven.

13. **BOX ICONS** (double ovens only): Green icon shows which oven is active.
14. **LOCK ICONS:** Red icons display inside box icons. Indicates that door is locked.
15. **DISPLAY TEXT:** Indicates active functions (steady) and functions awaiting user input (blinking).

Knobs

16. **MODE** (one for each oven): turn to choose cooking mode.
17. **TEMPERATURE** (one for each oven): turn to change oven temperature. When **PRESET** is selected, the default temperature is used.

Other Features

18. **BEEPS:** One beep signals that the entry is accepted, two beeps signals that the entry is invalid.
19. **F NUMBER CODES:** Appear in display when the control detects a problem in the oven or its electronics. See Self Help section, page 19, for more information.
20. **DEFAULT TEMPERATURES:** Each cooking mode has a default temperature that appears when the temperature knob is turned to **PRESET**. The default is the most common temperature for the mode.
21. **SABBATH MODE:** When activated, oven bakes for 72 hours before shutting off automatically. The mode is Sabbath compliant for religious faiths with "no work" requirements on the Sabbath.

General Oven Tips

Suggestions for Use

- Use the cooking charts as a guide.
- Do not set pans on an open oven door.
- Use the interior oven light to view the food through the oven door window rather than opening the door frequently.
- Place pans in center of oven.

Advantages of Convection Cooking

- Even baking.
- Juices and flavors are sealed in.
- Air-leavened foods such as cream puffs, souffles, meringues and yeast breads are higher and lighter.
- Multiple rack cooking with no flavor transfer.
- No special bakeware required.
- Broiling thicker cuts of meat is possible with convection broil.
- Saves time and energy.

About Convection Cooking*

Standard cooking modes (bake, broil, etc.) use heat radiated from one or more elements to cook food. Convection modes use both heat from the elements and a fan in the back of the oven to continuously circulate the heated air throughout the oven.

The result is faster, more even cooking. Convection modes seal in natural moisture and flavors and can also save time and energy since most foods can be cooked at lower temperatures and in less time (never reduce temperature when cooking meat).

Cook time is also reduced because multiple racks can be used at one time. Cook several sheets of cookies or several different dishes at the same time.

The oven also uses convection to dehydrate. The low heat from the elements is circulated through the oven by the convection fan to slowly remove moisture.

Refer to "Oven Modes" in this manual for further information on each convection mode.

Preheating the Oven

- Preheat the oven when using the bake and convection bake modes unless the recipe recommends otherwise.
- Use fast preheat mode to shorten preheat time.
- Selecting a higher temperature does not shorten the preheat time.
- Preheating is necessary for good results when baking cakes, cookies, pastries and breads.
- Place oven racks in their proper position before preheating.
- During preheat, the selected cooking temperature is displayed.
- A beep will confirm that the oven is preheated and the preheat light will turn off.
- When operating on 208 V, preheat time may be slightly longer.

Bakeware

- Glass baking dishes absorb heat. Reduce oven temperature 25° F when baking in glass.
- Use pans that give the desired browning. The type of finish on the pan will help determine the amount of browning that will occur.
- Shiny, smooth metal or light nonstick/anodized pans reflect heat, resulting in lighter, more delicate browning. Cakes and cookies require this type of bakeware.
- Dark, rough or dull pans will absorb heat resulting in a browner, crisper crust. Use this type for pies.
- For brown, crisp crusts, use dark nonstick/anodized or dark, dull metal utensils or glass bakeware
- Insulated baking pans may increase the length of cooking time.
- Do not cook with the empty broiler pan in the oven as this could change cooking performance. Store the broil pan outside of the oven.
- Use baking sheets that are 19"x14" or smaller for best results.

Oven Operation Overview:

Operation of the oven is through knobs and command buttons on the control panel.

Single oven models have one mode knob. Double oven models have two mode knobs (one for each oven).

Single oven models have one temperature knob. Double oven models have two temperature knobs.

The command buttons allow you to set the clock, the timer, the cook time (for timed and delayed cooking), the stop time (for delayed cooking) the oven lights and the child safety lock.

See the Control Panel/Display and Oven Operation sections for further details.

*HBL503 models do not have convection features.

General Oven Tips

Oven Racks

- The oven has rack guides at four levels as shown in the illustration on page 7. Rack positions are numbered from the bottom rack guide (#1) to the top (#4).
- Check cooking charts for best rack positions to use when cooking.
- Make sure that the racks are level once they are in position.
- The racks are designed to stop when pulled forward to their limit.
- CAUTION! Never use aluminum foil to cover the oven racks or to line the oven. Heat trapped under the foil can cause damage to the oven liner.



CAUTION: To avoid possible burns, place oven racks in desired positions before turning the oven on. Always use oven mitts when the oven is warm.

Removing from oven: Grasp rack firmly on both sides and pull rack toward you. When the stop is reached, tilt rack up and pull the rest of the way out.

Replacing in oven: Grasp rack firmly on both sides. Tilt rack up to allow stop into rack holder. Bring rack to a horizontal position and press the rest of the way in. Rack should be straight and flat, not crooked.

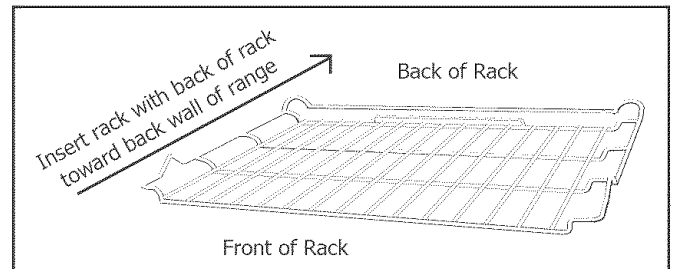

Figure 5: The Flat Rack

Selecting the Rack Position

See graphic at right.

Rack 4 - Highest position. Use for melting cheese quickly.

Rack 3 - Use for broiling most meats and for toasting bread.

Rack 2 - Use for pies, casseroles, breads, bundt or pound cakes, small roasts or poultry. Also use for broiling thicker cuts of meat.

Rack 1 - Lowest Position. Use for angel food cake, large roasts and turkey.

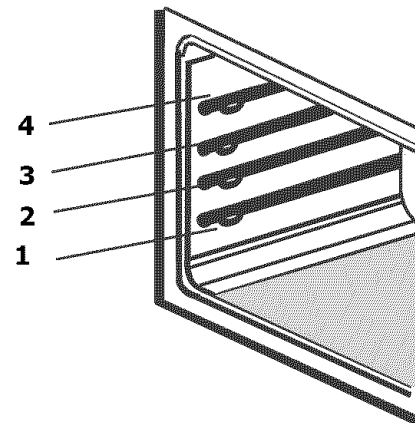

Figure 6: Rack Positions

Using Multiple Racks

2 Rack baking: Use positions 1 and 3.

3 rack baking: Use positions 2, 3 and 4.

When baking four cake layers at the same time, stagger pans so that one pan is not directly above another. For best results, place cakes on front of upper rack and back of lower rack (See graphic at right). Allow 1" - 1 1/2" air space around pans.

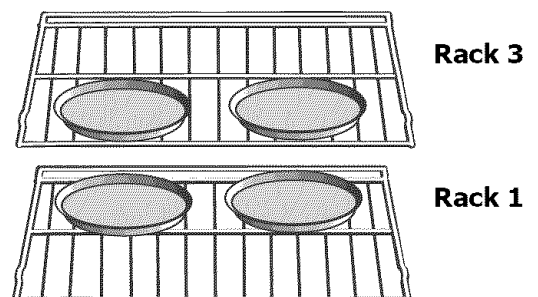

Figure 7: Multiple Rack Pan Placement

General Oven Tips

Condensation

The oven vent is located above the oven door. It is normal to see steam escaping from the vent and condensation may collect on areas above the vent such as the display.

Temperature Sensor

Your new oven has an electronic temperature sensor that accurately maintains the temperature selected. Your previous oven may have had a mechanical thermostat that drifted gradually to a higher temperature. As a result, you may need to adjust your favorite recipes when cooking in your new oven.

High Altitude Baking

When cooking at high altitude, recipes and cooking time will vary from the standard. For accurate information, write the Extension Service, Colorado State University, Fort Collins, Colorado 80521. There may be a charge for the bulletins.



CAUTION:

Many factors affect cooking performance.
Always check food for doneness before serving

Table 1: Food Temperature Guidelines

Food Serving Temperature Guidelines from FSIS (USDA Food Safety & Inspection Service)	
140° F (60° C) <ul style="list-style-type: none">• Ham, precooked (to reheat)	165° F (74° C) <ul style="list-style-type: none">• Ground Meat & Meat Mixtures (Turkey, Chicken)• Stuffing (cooked alone or in bird)• Leftovers & Casseroles
145° F (63° C) <ul style="list-style-type: none">• Fresh Beef, Veal, Lamb (medium rare)	170° F (77° C) <ul style="list-style-type: none">• Fresh Beef, Veal, Lamb (well done)• Poultry breasts• Fresh Pork (well done)
160° F (71° C) <ul style="list-style-type: none">• Ground Meat & Meat Mixtures (Beef, Pork, Veal, Lamb)• Fresh Beef, Veal, Lamb (medium)• Fresh Pork (medium)• Fresh Ham (raw)• Egg Dishes	180° F (82° C) <ul style="list-style-type: none">• Chicken and Turkey, (whole)• Poultry (thighs and wings)• Duck and Goose

Note: Eggs (alone, not used in a recipe) - cook until yolk & white are firm.

Setting the Oven

To Set the Cooking Mode:

1. Turn **mode knob** to select cooking mode.
2. Turn **temperature knob** to select temperature. Select **PRESET** to use the default temperature.

Red preheat light, oven light and oven fan turn on as oven preheats. When the preheat temperature is reached, the red preheat light goes out and the oven beeps.

To Set the Timer:

1. Press **TIMER**. **TIMER** appears in the display.
2. Press **TIMER** again. The hours flash.
3. Press **+** or **-** to set hours.
4. Press **TIMER**. The minutes flash.
5. Press **+** or **-** to set minutes.
6. Press **TIMER**.

Beeps sound when the time ends.

TIP:

Hold the **+** or **-** key down to change time by 10 minute increments.

To Set the Cooking Mode using Fast Preheat:

1. Turn **mode knob** to **FAST PREHEAT**.
2. Turn **temperature knob** to select temperature. Red preheat light, oven light and oven fan turn on as oven preheats. When the preheat temperature is reached, the red preheat light goes out and the oven beeps.
3. Turn **knob to select cooking mode**.
4. Place food in oven.

REMINDER!

When using **fast preheat**, you must **select the cooking mode** after preheat and before placing food in the oven.

Timed Cooking Modes

Use timed cook to turn the oven off automatically after cooking. Delayed cook also turns the oven on automatically.

- In double oven models, both ovens can be set to operate on independent timed modes.
- The clock is set to the correct time of day.
- The timed mode turns off the oven at the end of the cook time.

To Set the Timed Mode:

1. Turn **knobs** to select the mode and temperature.
2. Press **COOK TIME** twice. The hours flash.
3. Press **+** or **-** to set number of hours.
4. Press **COOK TIME** again. Minutes flash.
5. Press **+** or **-** to change the number of minutes.
6. Press **COOK TIME** to confirm cooking time.

Note: Time required for the oven to reach temperature must be included in the set cooking time.

At the end of the programmed cooking time, the oven will automatically turn off.

To Set the Delayed Mode:

1. Follow steps 1 through 6.
2. Press **STOP TIME** twice. **DELAY** appears in the display. **STOP TIME** and the **hours** flash.
3. Press **+** or **-** to change the hours.
4. Press **STOP TIME** again. Minutes flash.
5. Press **+** or **-** to change the minutes.
6. Press **STOP TIME** to confirm stop time.

The oven automatically calculates the time of day to start.

At the end of the programmed cooking time, the oven turns off. Display shows **END** and the oven beeps. Reminder beeps sound and **COKOK TIME** flashes.

TIP:

Press **COOK TIME** to view **timed mode** information.

Press **STOP TIME** to view **delayed mode** information.

Press **TIMER** to view **timer**.

Oven Modes

Bake

Baking is cooking with dry, heated air. Both the upper and lower elements cycle to maintain the oven temperature:

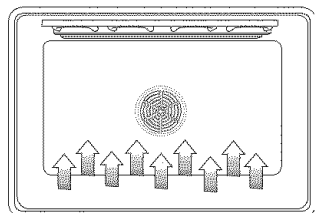

Figure 8: Bake

The bake mode can be used to prepare a variety of food items, from pastries to casseroles. It can also be used to roast meats.

For Best Results:

- When baking on two or more racks, use convection bake instead.

Convection Bake

Convection baking is similar to baking. In this case, heat comes from a third element behind the backwall. The main difference in convection baking is that the heat is circulated throughout the oven by the convection fan:

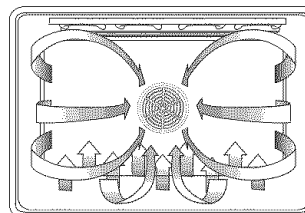

Figure 9: Convection Bake

The convection bake mode is well-suited for baking large quantities of food on multiple racks. It can be used to prepare cookies, pastries, breads, snack foods and appetizers among other items. **DO NOT** use convection bake for meats. Use convection roast instead.

The benefits of convection baking include:

- Slight decrease in cooking time
- Three rack cooking
- Higher volume (yeast items rise higher)
- More items cooked at once

For Best Results:

- Reduce recipe temperature by 25° F. Refer to the convection baking chart for examples.
- Place food in low-sided, uncovered pans such as cookie sheets without sides.
- Center baking pans side to side on the oven rack.
- Do not use convection bake for custards, quiches, pumpkin pie, or cheesecakes. These items do not benefit from the convection-heating process. Use standard bake instead.

Table 2: Convection Bake Chart

Food Item	Rack Position	Temp.* (preheated oven) (F°)	Convection Bake Time** (min)
Cake			
Cupcakes	2	325	17-19
Bundt Cake	1	325	37-43
Angel Food	1	325	35-39
Pie			
2 crust, fresh, 9"	2	350 - 400	45-55
2 crust, frozen fruit, 9"	2	350	68-78
Cookies			
Sugar	2	325 - 350	6-11
Chocolate Chip	2	325 - 350	8-13
Brownies	2	325	29-36
Breads			
Yeast bread, loaf, 9x5	2	350	
Yeast rolls	2	350 - 375	18-22
Quick Bread, loaf, 8x4	2	325 - 350	12-15
Biscuits	2	350 - 375	45-55
Muffins	2	400	11-15
Pizza			
Frozen	2	375 - 425	23-26
Fresh	2	400 - 425	12-15

* The convection bake temperature is 25° F less than recommended on packages or recipes. The temperature in this chart has been reduced 25° F.

** This chart is a guide. Actual times depend on the mixes or recipes baked. Follow recipe or package directions and reduce temperature appropriately.

*** When convection baking on two racks, use positions one and three. When using three racks, use positions two, three and four.

Quick Cooking Tips: Converting from standard bake to convection bake

- Reduce recipe temperature by 25° F.
- Check food for doneness early:

If recipe calls for ...	Check food ...
1 - 15 min.	3 min. early
16 - 30 min.	5 min. early
31 min. - 1 hr.	10 min. early

Oven Modes

Broil

Broiling uses intense heat radiated from the upper element:

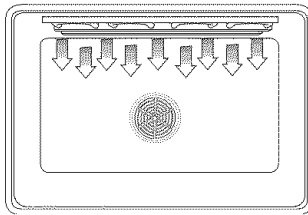

Figure 10: Broil

The broil mode is best suited to cooking thin, tender cuts of meat (1" or less), poultry and fish. It can also be used to brown breads and casseroles.

The benefits of Broiling include:

- Fast and efficient cooking.
- Cooking without the addition of fats or liquids.
- Browning as the food cooks.

For Best Results:

- Do not preheat oven.
- Steaks and chops should be at least 3/4" thick.
- Brush fish and poultry with butter or oil to prevent sticking.
- Use the broil pan and grid included with your oven.
- Do not cover the broiler grid with foil. It is designed to drain fats and oils away from the cooking surface to prevent smoking and spattering.
- Turn meats once halfway through the recommended cooking time (see broil chart for examples).
- When top browning casseroles, use only metal or glass ceramic dishes such as Corningware®.
- Never use heat-proof glass (Pyrex®); it cannot tolerate the high temperature.

ALWAYS BROIL WITH THE DOOR CLOSED

Table 3: Broil Chart

Food and Thickness	Rack Position	Broil Setting	Internal Temp. (°F)	Time Side 1 (min)*	Time Side 2 (min)*
Beef Steak (3/4" - 1")					
Medium Rare	3	5	145	5-7	4-6
Medium	3	5	160	6-8	5-7
Well	3	5	170	8-10	7-9
Hamburgers (3/4" - 1")					
Well	3	5	160	7-9	5-7
Poultry Breast (bone-in)	3	3	170	14-16	14-16
Thigh	3	3	180	14-16	11-13
Pork Pork Chops (1")	3	5	160	7-9	5-7
Sausage - fresh	3	5	160	5-7	3-5
Ham Slice (1/2")	3	5	160	3-5	4-6
Seafood Fish Filets, 1" Buttered	3	4	Cook until opaque & flakes easily with fork	10-14	Do not turn
Lamb Chops (1")					
Medium Rare	3	5	145	5-7	4-6
Medium	3	5	160	6-8	5-7
Well	3	5	170	8-10	7-9
Bread Garlic Bread, 1" slices	3	5		4-6	

Convection Broil

Convection broil is similar to broil. It combines the intense heat from the upper element with heat circulated by the convection fan:

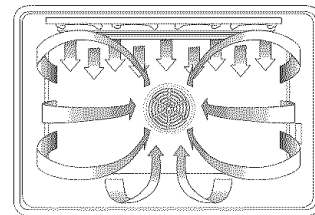

Figure 11: Convection Broil

The convection broil mode is well suited for cooking thicker, tender cuts of meat, poultry and fish. Convection Broil is typically not recommended for browning breads, casseroles and other foods.

The benefits of Convection Broiling, in addition to the benefits of standard broiling, include:

- Faster cooking than standard Broiling.

For Best Results:

- Do not preheat oven.
- Meats should be at least 1 1/2" thick.
- Turn meats once halfway through the cooking time (See Convection Broil Chart for examples).
- Use the broil pan and grid included with your oven.
- Do not cover the broiler grid with foil. It is designed to drain fats and oils away from the cooking surface to prevent smoking and spattering.
- Salt after cooking.

ALWAYS CONVECTION BROIL WITH THE DOOR CLOSED

Table 4: Convection Broil Chart

Food and Thickness	Rack Position	Broil Setting	Internal Temp. (°F)	Time Side 1 (min)*	Time Side 2 (min)*
Beef Steak (1-1/2" or more)					
Medium Rare	2	450	145	12-14	11-13
Medium	2	450	160	15-17	13-15
Well	2	450	170	18-20	16-17
Hamburgers (more than 1")					
Well	3	550	160	11-13	8-10
Poultry Chicken Quarters	3	450	180 (thigh)	13-15	10-12
Chicken Breasts	3	450	170	14-16	12-14
Pork Pork Chops (1 1/4" or more)	2	450	160	12-14	13-15
Sausage - fresh	3	450	160	4-6	3-5

*Broiling and convection broiling times are approximate and may vary slightly.

Oven Modes

Convection Roast

Convection roast uses heat from the top and bottom elements as well as heat circulated by the convection fan:

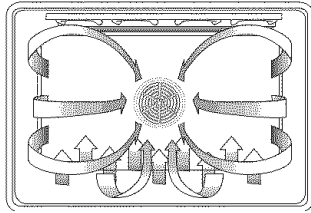

Figure 12: Convection Roast

The convection roast mode is well suited to preparing tender cuts of meat and poultry.

The benefits of convection roasting, include:

- As much as 25% faster cooking than standard Roasting/ Baking
- Rich, golden browning

For Best Results:

- Use the same temperature as indicated in the recipe.
- Check doneness early as roasting time may decrease by as much as 25%. Refer to convection roast chart for examples.
- Do not cover meat or use cooking bags.
- Use the broil pan and grid provided with the oven for roasting. A low-sided, uncovered pan can also be used.
- Use a meat thermometer to determine the internal temperature of the meat.
- If the meat is browned to your liking, but is not yet done, a small strip of foil can be placed over the meat to prevent overbrowning.
- Let meat stand covered with foil 10-15 minutes after removing from the oven.

Table 5: Convection Roast Chart

Meats	Weight (lb)	Oven Temp. (°F)	Rack Position	Roasting Time* (min per lb)	Internal Temp (°F)
Beef Rib Roast	4 - 6	325	2	24-30 27-33	145 (med rare) 160 (medium)
Rib Eye Roast, (boneless)	4 - 6	325	2	22-30 27-33	145 (med rare) 160 (medium)
Rump, Eye, Tip, Sirloin (boneless)	3 - 6	325	2	22-28 27-33	145 (med rare) 160 (medium)
Tenderloin Roast	2 - 3	425	2	15-25	145 (med rare)
Pork Loin Roast (boneless or bone-in)	5 - 8	350	2	20-30	160 (medium)
Shoulder	3 - 6	350	2	25-35	160 (medium)
Poultry Chicken - whole	3 - 4	375	2	12-18	180
Turkey, unstuffed**	12-15	325	1	10-14	180
Turkey, unstuffed**	16-20	325	1	9-11	180
Turkey, unstuffed**	21-25	325	1	6-10	180
Turkey Breast	3 - 8	325	1	15-20	170
Cornish Hen	1 - 1 ½	350	2	45-75 total	180
Lamb Half Leg	3 - 4	325	2	25-30 30-35	160 (medium) 170 (well)
Whole Leg	6 - 8	325	1	25-30 30-35	160 (medium) 170 (well)

*Roasting times are approximate and may vary depending on the shape of the meat. They are based on thawed meats.

**Stuffed turkey requires additional roasting time. The minimum safe temperature for stuffing in poultry is 165° F

Quick and Easy Cooking Tips: Converting from standard bake to convection roast

- DO NOT change recipe temperature.
- Use roasting times in chart at right.

Oven Modes

Dehydrate

Dehydrate dries foods with heat from a third element behind the back wall of the oven. The heat is circulated throughout the oven by the convection fan.

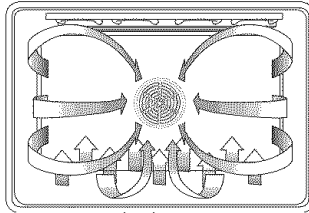

Figure 13: Dehydrate

Dehydrating is used to dry and/or preserve foods such as fruits, vegetables and herbs. This mode holds an optimum low temperature (120° F - 160° F) while circulating the heated air to slowly remove moisture.

For Best Results:

- Dry herbs at 120° F. Dry most fruits and vegetables at 140° F . (Refer to the dehydrate chart for examples).
- Drying times vary depending on the moisture and sugar content of the food, the size of the pieces, the amount being dried and the humidity in the air. Check food at the minimum drying time.
- Multiple racks can be used simultaneously. Contact your Bosch dealer for drying racks.
- Treat fruits with antioxidants to avoid discoloration.
- Consult a food preservation book, county Cooperative Extension Office or library for additional information.

Table 6: Dehydrate Chart

Food	Preparation	Approximate Drying Time*(hrs)	Test for Doneness
Fruit Apples	Dipped in ¼ cup lemon juice and 2 cups water; ¼" slices	11-15	Slightly pliable
Bananas	Dipped in ¼ cup lemon juice and 2 cups water; ¼" slices	11-15	Slightly pliable
Cherries	Wash and towel dry. For fresh cherries, remove pits	10-15	Pliable, leathery, chewy
Orange Peels and slices	½" slices of orange; orange part of skin thinly peeled from oranges	Peels: 2-4 Slices: 12-16	Orange peel: dry and brittle. Orange slices: skins are dry and brittle, fruit is slightly moist
Pineapple rings	Towel dried	Canned: 9-13 Fresh: 8-12	Soft and pliable
Strawberries	Wash and towel dry. Sliced ½" thick, skin (outside) down on rack	12-17	Dry, brittle
Vegetables Peppers	Wash and towel dry. Remove membrane of peppers, coarsely chopped about 1" pieces	16-20	Leathery with no moisture inside
Mushrooms	Wash and towel dry. Cut off stem end. Cut into 1/8" slices	7-12	Tough and leathery, dry
Tomatoes	Wash and towel dry. Cut thin slices, 1/8" thick, drain well.	16-23	Dry, brick red color
Herbs Oregano, sage parsley and thyme, and fennel	Rinse and dry with paper towel	Dry at 120°F 3-5 hrs	Crisp and brittle
Basil	Use basil leaves 3 to 4 inches from top. Spray with water, shake off moisture and pat dry	Dry at 120°F 3-5 hrs	Crisp and brittle

Oven will stay on for 48 hours before shutting off automatically.

Self-Cleaning

During self-clean, the oven uses a very high temperature to burn away food soil and grease.

- As a safety feature, the oven door locks during self-clean to protect from very high temperatures. Do not try to open the oven during self-clean mode.
- Only one oven can be self-cleaned at a time. The second oven can be used while the other is self-cleaning.
- It is common to see smoke and/or an occasional flame-up during the self-clean mode, depending on the content and amount of soil remaining in the oven. If a flame persists, turn off the oven and allow it to cool before opening the door to wipe up the excessive food soil.
- The oven light does not operate when the oven is in the self-clean mode.
- Do not use commercial oven cleaners as they may damage finish or parts.
- Heat and odors are normal during the self-clean cycle. Keep the kitchen well ventilated.

NOTE: Due to the high temperatures used for self-cleaning, fine lines or surface roughness may develop in oven cavity. This is a common condition and does not affect either the cooking or the cleaning performance of the oven.

Before You Self-Clean

1. Hand clean the oven door edge, window, oven front frame and oven cavity edges (see figures below). They do not get hot enough during the cleaning cycle for soil to burn away. Use a soapy sponge, plastic scrubber or S.O.S.[®] pad. **DO NOT RUB THE GASKET.**
2. Wipe up large overspills and grease with paper towels.
3. Remove broiler pan, all utensils and bakeware.
4. **Remove oven racks.** If the oven racks are left in the oven during a self-cleaning cycle, they will lose their shiny finish and will not glide smoothly in the rack guides. See "Cleaning Oven Surfaces, page 15 for proper care .
5. Be sure the light is turned off on the control panel and the bulb and glass cover are in place.

After Self-Clean

- The self-clean mode may produce ash which will settle in the oven. If this happens, remove ash with a damp cloth before using the oven.
- Wipe rack edges with cooking oil to allow for proper glide. Wipe off excess.

IMPORTANT: Be sure to let the inside window glass in the oven door cool completely before wiping up any ash left from the clean cycle.

Hand clean front frame

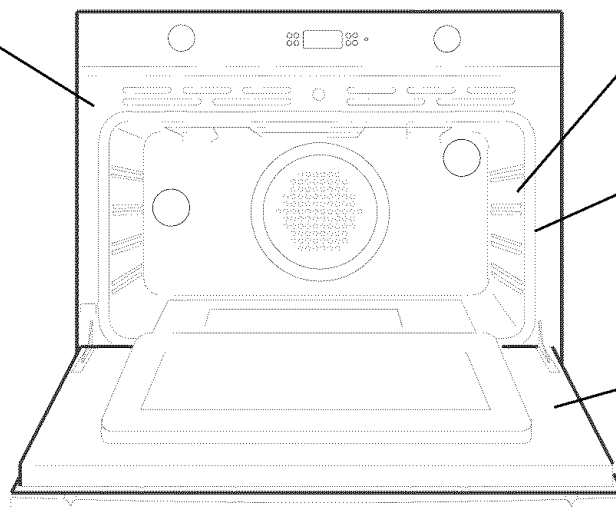

Figure 14: Before Self-Cleaning

Self-Cleaning

To Set the Self-Clean Mode:

1. Remove oven racks and close oven door.
2. **Turn both knobs to CLEAN.**

NOTE:

If the door is open when the self-clean mode is selected, the lock symbol will continue to flash. Self-clean will not start until the door is closed.

CLEAN and **TIME** appear in the display.

The oven will clean for three hours. At the end of the programmed cleaning time the oven will automatically turn off.

END will appear on the display. **CLEAN** and **TIME** will flash until any button is pressed or the knob is turned to **OFF**.

To Change the Clean Time

The preset clean time is three hours. For light soil, use two hours, for heavy soil use four hours.

1. Set self-clean mode as explained above.
2. **Press COOK TIME.**
3. **Press +** or **-** to change the number of hours.
4. **Press COOK TIME twice.**

To Delay the Start of the Clean

Note: The time of day must be accurate for the delay function to work properly.

1. Set self-clean mode as explained above.
2. Change clean time as explained above (if desired).
3. Set the time the oven will start self-cleaning:

Press STOP TIME twice.

Press + or **-** to set hours.

Press STOP TIME.

Press + or **-** to set minutes.

Press STOP TIME.

The oven door locks and **DELAY** appears in the display.

4. When the delay time ends, self-clean starts.

At the end of the programmed cleaning time, the oven will automatically turn off.

END will appear on the display. **CLEAN** and **TIME** will flash until any button is pressed or the knob is turned to **OFF**.

About the Door Lock:

Do not attempt to open the door while the door is locking.

Lock symbol will flash until the door is locked. When the lock symbol is displayed, the door cannot be opened.

Check that the door has been locked and will not open before starting self-clean mode.

If door does not lock, turn the mode knob to **OFF** position and do not start self-clean; phone 800-944-

TIP:

To check the **delayed clean time** press **COOK TIME**.

To check the **time remaining before the delayed mode starts**, press **STOP TIME**.

TO CANCEL:

To cancel the self-clean, turn knob to **OFF**. The oven door will remain locked until the oven has reached a safe temperature.

Cleaning Oven Surfaces

Table 7: Oven Surface Cleaning Methods

Surface	Cleaning Method
Racks pow(Oven) mode, rack	Wash with hot sudsy water. Rinse thoroughly and dry, or gently rub with cleansing der or soap filled pads as directed. If racks are cleaned in the oven during the self-clean they will lose their shiny finish and may not glide smoothly. If this happens, wipe the edges with a small amount of vegetable oil, then wipe off excess.
Fiberglass Knit (Gasket)	DO NOT HAND CLEAN GASKET.
Glass (Window, Display)	Wash with soap and water or glass cleaner. Use Fantastik® or Formula 409® to remove grease spatters and stubborn stains.
Painted paper (Exterior)	Clean with hot sudsy water or apply Fantastik® or Formula 409® to a clean sponge or towel and wipe clean. Avoid using powdered cleansers, steel wool pads and oven cleaners.
Porcelain (Interior)	Immediately wipe up acid spills like fruit juice, milk and tomatoes with a dry towel. Do not use a moistened sponge/towel on hot porcelain. When cool, clean with hot sudsy water or apply Bon-Ami® or Soft Scrub® to a damp sponge. Rinse and dry. For stubborn stains, gently use soap filled pads. It is normal for porcelain to craze (fine lines) with age due to exposure from heat and food soil.
Stainless Steel (Exterior)	Always wipe or rub with grain. Clean with a soapy sponge then rinse and dry, or wipe with Fantastik® or Formula 409® sprayed onto a paper towel. Protect and polish with Stainless Steel Magic® and a soft cloth. Remove water spots with a cloth dampened with white vinegar. Use Bar Keeper's Friend® to remove heat discoloration.
Plastic (Knobs, Controls)	When cool, clean with soapy water, rinse and dry.

Replacing the Oven Light

- Each oven is equipped with two halogen lights located in the back wall of the oven.
- The lights are switched on when the door is opened or when the oven is in a cooking cycle.
- The oven lights do not operate during self-clean.
- Each light assembly consists of a removable lens, a light bulb and a light socket housing that is fixed in place (see Figure 17, next page).

To replace a light bulb (see figure 17, next page):

1. Read WARNING on this page.
2. Turn off power at the main power supply (fuse or breaker box).
3. Unscrew lens and remove.
4. Pull straight out on light bulb to remove from socket.
5. Replace the bulb with a new one. Avoid pressing the bulb with fingers; Oils from hands can damage the bulb when it becomes hot
6. The bulb is halogen 12V - 20W.
7. Screw the lens back on.
8. Replace the fan cover (if applicable).
9. Turn power back on at the main power supply (fuse or breaker box).



WARNING

- Make sure the oven and lights are cool and power to the oven has been turned off before replacing the light bulb(s). Failure to do so could result in electrical shock or burns.
- The lenses must be in place when using the oven.
- The lenses serve to protect the light bulb from breaking.
- The lenses are made of glass. Handle carefully to avoid breaking. Broken glass could cause an injury.

Removing the Oven Door

WARNING

- Make sure oven is cool and power to the oven has been turned off before removing the door. Failure to do so could result in electrical shock or burns.
- The oven door is heavy and fragile. Use both hands to remove the oven door. The door front is glass. Handle carefully to avoid breaking.
- Grasp only the sides of the oven door. Do not grasp the handle as it may swing in your hand and cause damage or injury.
- Failure to grasp the oven door firmly and properly could result in personal injury or product damage.

WARNING

To avoid injury from hinge brackets snapping closed, be sure that both levers are securely in place before removing door. Also, do not force door open or closed - the hinge could be damaged and injury could result.

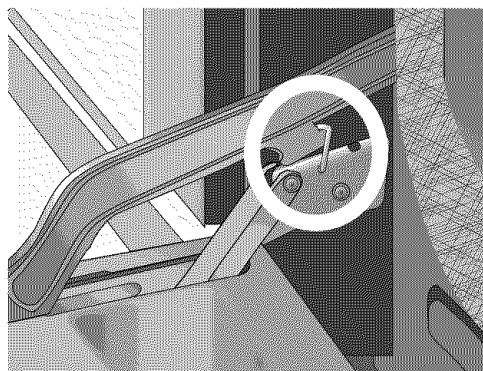

Figure 15: Hinge Bracket Locked Into Place

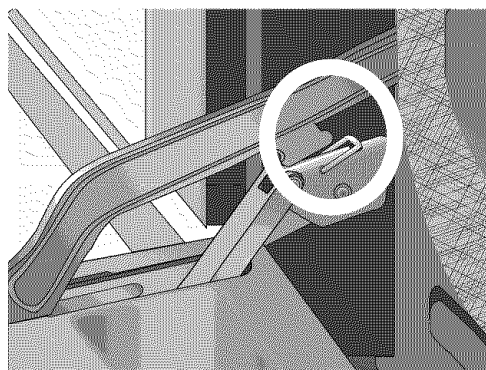

Figure 16: Hinge Bracket Released

To Remove The Oven Door:

1. Be sure to read the above WARNING before attempting to remove oven door.
2. Open door completely.
3. Lift hinge brackets (one on each side) into slots (see Figure 15).
4. Close door slightly until hinge brackets lock into place.
5. Close door about halfway (until it stops).
6. Grasp firmly on both sides.
7. Pull out and up. Place door in a stable location.

To Reinstall the Oven Door:

1. Holding door firmly on both sides, drop hinges down and into hinge slots.
2. Open door completely so that hinge brackets (one on each side) release.
3. Open and close the door slowly and completely to test the installation.

The door should close easily and be straight, not crooked.

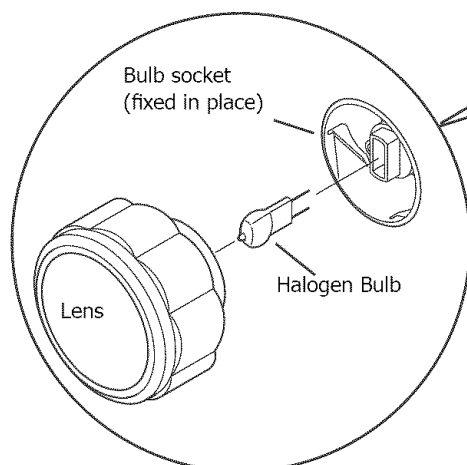
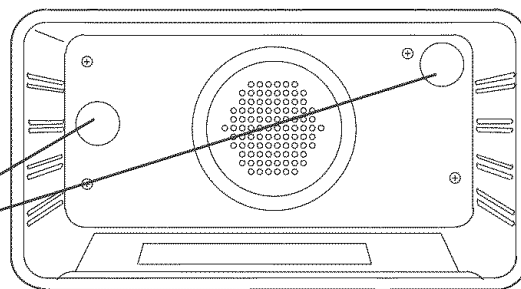

Figure 17: Oven Light



Do-It-Yourself Procedures

To Activate Sabbath Mode:

When activated, oven bakes for 72 hours before shutting off automatically. The mode is Sabbath compliant for religious faiths with "no work" requirements on the Sabbath.

1. **Touch and hold SET CLOCK** and **TIMER** until **SELE dEG** is shown.
2. **Press +** or **-** until **SAb** appears.
3. **Press SET CLOCK.**
4. **Press +** or **-** to select format (choose ON to activate Sabbath mode; choose OFF to turn it off).
5. **Hold SET CLOCK** until clock appears in display.
There is a five minute delay in which the following can be set:
6. **Turn knob** to **BAKE.**
7. **Turn knob** to set **TEMPERATURE.**
8. **Press LIGHT** to turn oven lights on or off.
9. Repeat steps 8-10 for second oven if desired (double ovens only).

After 5 minutes, the Sabbath mode is activated. The temperature no longer shows in the display. Only the time, "SAb" and the oven icon(s) are present. The preheat lights and all beeps are also disabled.

The oven lights cannot be changed after the Sabbath mode starts.

The Sabbath mode automatically cancels after 72 hours. To cancel the Sabbath mode early, turn the mode knob to **OFF.**

To Change Clock Format

The oven is preset with a 12-hour clock format; However, it can also display a 24-hour clock.

1. **Touch and hold SET CLOCK** and **TIMER** until **SELE dEG** is shown.
2. **Press +** or **-** until **Hr** appears.
3. **Press SET CLOCK.**
4. **Press +** or **-** to select format (choose 12 for 12-hour format; choose 24 for 24-hour format).
5. **Hold SET CLOCK** until clock appears in display.

To Change Temperature Format:

The oven has been preset to a Fahrenheit temperature format; However, it can also use a Celsius temperature format.

1. **Touch and hold SET CLOCK** and **TIMER** until **SELE dEG** appears.
2. **Press SET CLOCK.**
3. **Press +** or **-** to select format (choose °C for Celsius; choose °F for Fahrenheit).
4. **Hold SET CLOCK** until clock appears in display.

To Change Temperature Calibration:

The electronic thermostat has been carefully calibrated; However, if the browning results are too light or too dark for your preferences, you can raise or lower the setting.

1. **Touch and hold SET CLOCK** and **TIMER** until **SELE dEG** is shown.
2. **Press +** or **-** until **OFS** appears.
3. **Press SET CLOCK.**
4. **Press UPPER LOWER** to select oven (double ovens only).
5. **Press +** or **-** to set the number of degrees difference.
6. **Hold SET CLOCK** until clock appears in display.
NOTE: The available temperature offset range + or - 35°F. A change in the calibration affects all modes.

To Change Operating Voltage

The oven is preset for use with 240 VAC. If your residence has 208 VAC, the oven voltage can be changed.

208 V conversion must be done by a qualified technician. Contact your local appliance dealer or Bosch Service: 800-944-2904.

Self Help - Baking

Check the chart below for causes of the most common baking problems. Since the size, shape and material of baking utensils directly affect the baking results, the best solution may be to replace old baking utensils that have darkened and warped with age and use. Also check the convection baking chart on page 9, the rack position and the baking time.

Table 8: Self Help - Baking

Baking Problem	Cause
Food browns unevenly	<ul style="list-style-type: none"> - Oven not preheated - Aluminum foil on oven rack or oven bottom - Baking utensil too large for recipe - Pans touching each other or oven walls
Food too brown on bottom	<ul style="list-style-type: none"> - Oven not preheated - Using glass, dull or darkened metal pans - Incorrect rack position - Pans touching each other or oven walls
Food is dry or has shrunk excessively	<ul style="list-style-type: none"> - Oven temperature too high - Baking time too long - Oven door opened frequently - Pan size too large
Food is baking or roasting too slowly	<ul style="list-style-type: none"> - Oven temperature too low - Oven not preheated - Oven door opened frequently - Tightly sealed with aluminum foil - Pan size too small
Pie crusts do not brown on bottom or have soggy crust	<ul style="list-style-type: none"> - Baking time not long enough - Using shiny steel pans - Incorrect rack position - Oven temperature is too low
Cakes pale, flat and may not be done inside	<ul style="list-style-type: none"> - Oven temperature too low - Incorrect baking time - Cake tested too soon - Oven door opened too often - Pan size too large
Cakes high in middle with crack on top	<ul style="list-style-type: none"> - Baking temperature too high - Baking time too long - Pans touching each other or oven walls - Incorrect rack position - Pan size too small
Pie crust edges too brown	<ul style="list-style-type: none"> - Oven temperature too high - Edges of crust too thin

Self Help - Operation

Before calling for service, check the following:

Table 9: Self Help - Operation

Oven Problem	Problem Solving Steps
F03 or F04 Error appear in the display window.	A problem with the lock occurred. Turn power off and turn it back on again after a few seconds. The oven should run a latch auto-test. If condition persists, note the code number and call an authorized servicer.
Other F__ Error appears in the display window.	Turn power off and turn it back on again after a few seconds. If condition persists, note the code number and call an authorized servicer.
Cooling fan continues to run after oven is turned off	This is normal. The fan turns off automatically when the electronic components have cooled sufficiently.
Oven door is locked and will not release, even after cooling	Turn the oven off at the circuit breaker and wait a few seconds. Turn breaker back on. The oven should reset itself and will be operable.
Oven is not heating	Make sure the oven temperature has been selected. Check the circuit breaker or fuse box to your house. Make sure there is proper electrical power to the oven.
Oven is not cooking evenly	Check oven calibration. Adjust calibration if necessary (see Oven Offset, Page 17). Refer to cooking charts for recommended rack position. Always reduce recipe temperature by 25°F when baking with convention bake mode.
Oven temperature is too hot or too cold	The oven thermostat needs adjustment. See Calibrating Oven Temperature, Page 17.
Oven light is not working properly	Replace or reinsert the light bulb if loose or defective. See Page 15. Touching the bulb with fingers may cause the bulb to burn out.
Oven light stays on	Oven light comes on automatically when oven begins heating. Press LIGHT to turn oven light off. If oven is off, check for obstruction in oven door or check to see if hinge is bent.
Cannot remove lens cover on light	There may be soil build-up around the lens cover. Wipe lens cover area with a clean dry towel prior to attempting to remove the lens cover.
Oven will not self-clean properly	Allow the oven to cool before running self-clean. Always wipe out loose soil or heavy spill-over before running self-clean. If oven is badly soiled, set oven for a four-hour Self-Clean. See Self-Cleaning, Page 13.
Clock and timer are not working properly	Make sure there is proper electrical power to the oven. See the Clock and Timer sections on Pages 2 and 8.
Excessive moisture	When using bake mode, preheat the oven first. Convection bake will eliminate any moisture in oven (this is one of the advantages of convection).
Porcelain chips	When oven racks are removed and replaced, always tilt racks upward and do not force them to avoid chipping the porcelain.

HOW TO OBTAIN SERVICE

For authorized service or parts information call 800/ 944-2904.

We want you to remain a satisfied customer. If a problem occurs that is not resolved to your satisfaction, write to Bosch Customer Support, 5551 McFadden Avenue, Huntington Beach CA, 92649 or phone 800-944-2904.

Please include the Model Number, Serial Number and date of original purchase and installation.

Warranty

Statement of Limited Warranty

The warranties provided by BSH Home Appliances ("Bosch") in this Statement of Limited Warranty apply only to the Bosch Electric Built-In Ovens ("Built-In Oven") sold to you, the first using purchaser, provided that the Built-In Oven was purchased (1) for your use and not for resale and (2) in the United States or Canada and is located in the country of purchase. As used in this Statement of Limited Warranty, the term "Date of Installation" shall refer to the earlier of the date the Built-In Oven is installed or ten (10) business days after the date the Built-In Oven is sold to the first using purchaser. The warranties stated herein apply only to the first using purchaser and are not transferable.

Standard Limited Warranty

Bosch warrants that its Built-In Oven is free from defects in materials and workmanship for a period of twelve (12) months from the Date of installation. During the warranty period, Bosch or its authorized service center will repair or replace, at its sole option, any Built-In Oven that proves to have been defective under conditions of normal use without charge. All removed parts and components shall become the property of Bosch, at Bosch's option. All replaced and/or repaired parts shall assume the identity of the original part for purposes of this warranty and this warranty shall not be extended with respect to such parts.

Other Conditions of the Limited Warranties

The warranties provided in this Statement of Limited Warranty exclude defects or damage resulting from (1) use of the Built-In Oven in other than its normal and customary manner (commercial use of the Built-In Oven shall not be deemed normal or customary), (2) misuse, abuse, accidents or neglect, (3) improper operation, maintenance, installation or unauthorized service, (4) adjustment or alteration or modification of any kind, (5) a failure to comply with applicable state, local, city, and county electrical and/or building codes, (6) spills of food or liquid, and (7) external forces such as floods, fires, acts of God or other circumstances beyond Bosch's control. Also excluded from this warranty are scratches and damages on external surfaces and exposed parts or Built-In Ovens on which the serial numbers have been altered, defaced or removed.

To the extent allowed by law, this warranty sets out your exclusive remedies with respect to products covered by it, whether the claim arises in contract or tort (including strict liability, and negligence) or otherwise. Bosch will not be liable for consequential or incidental damages, losses, or expenses.

THIS WARRANTY IS IN LIEU OF ALL OTHER EXPRESS WARRANTIES. ANY WARRANTY IMPLIED BY LAW, WHETHER FOR MERCHANTABILITY OR FITNESS FOR A PARTICULAR PURPOSE OR OTHERWISE, SHALL BE EFFECTIVE ONLY FOR THE PERIOD THAT THIS EXPRESS WARRANTY IS EFFECTIVE. No attempt to alter, modify or amend this warranty shall be effective unless authorized in writing by an officer of BSH.

How to Obtain Warranty Service

To obtain warranty service for the Built-In Oven, you should contact the nearest Bosch authorized service center. BSH Home Appliances • 5551 McFadden Avenue, Huntington Beach, CA 92649 • 800-944-2904.

Service Data Record

The location of the serial tag on the product can be seen when the oven door is opened. It is located on the left side, centered vertically just inside the oven cavity. See page 3. Now is a good time to write this information in the space provided below. Keep your invoice for warranty validation. To obtain service see page 19.

Model number:
Serial Number:
Date of Installation or Occupancy:

BSH reserves the right to change specifications or design without notice. Some models are certified for use in Canada. BSH is not responsible for products which are transported from the United States for use in Canada. Check with your local Canadian distributor or dealer. BSH Home Appliances, Corporation, 5551 McFadden Avenue, Huntington Beach, CA 92649.
For the most up to date critical installation dimensions by fax, use your fax handset and call 702-833-3600. Use code #8030.

BOSCH

YOUR LIFE. OUR INSPIRATION.

5551 McFadden Avenue, Huntington Beach, CA 92649 • 800-944-2904
9000053250 • 10018 Rev. B • 02/05 © BSH Home Appliances Corporation 2005 • Litho U.S.A.

Free Manuals Download Website

<http://myh66.com>

<http://usermanuals.us>

<http://www.somanuals.com>

<http://www.4manuals.cc>

<http://www.manual-lib.com>

<http://www.404manual.com>

<http://www.luxmanual.com>

<http://aubethermostatmanual.com>

Golf course search by state

<http://golfingnear.com>

Email search by domain

<http://emailbydomain.com>

Auto manuals search

<http://auto.somanuals.com>

TV manuals search

<http://tv.somanuals.com>