

# PAVIRO Amplifier

PVA-2P500



**BOSCH**

**en** Operation manual



## Table of contents

<b>1</b>	<b>Safety</b>	<b>4</b>
<b>2</b>	<b>Short information</b>	<b>8</b>
<b>3</b>	<b>System overview</b>	<b>9</b>
3.1	Front panel	9
3.2	Rear panel	12
<b>4</b>	<b>Parts included</b>	<b>13</b>
<b>5</b>	<b>Installation</b>	<b>14</b>
<b>6</b>	<b>Connection</b>	<b>16</b>
6.1	Audio inputs	16
6.2	Audio output	18
6.3	Supply voltage	19
6.4	CAN BUS	20
<b>7</b>	<b>Configuration</b>	<b>23</b>
7.1	Setting the CAN address	23
7.2	Displaying the CAN baud rate	24
7.3	Configuring the CAN baud rate	24
<b>8</b>	<b>Operation</b>	<b>25</b>
8.1	Stand-alone mode	25
<b>9</b>	<b>Maintenance</b>	<b>27</b>
9.1	Firmware update	27
9.2	Resetting to factory default settings	27
<b>10</b>	<b>Technical data</b>	<b>28</b>
10.1	Standards	30
10.2	Power consumption	30
10.3	Dimensions	31
10.4	Circuit diagram	32

# 1 Safety

**Danger!**

**High risk:** This symbol indicates an imminently hazardous situation such as "Dangerous Voltage" inside the product.

If not avoided, this will result in an electrical shock, serious bodily injury, or death.

**Warning!**

**Medium risk:** Indicates a potentially hazardous situation.

If not avoided, this could result in minor or moderate bodily injury.

**Caution!**

**Low risk:** Indicates a potentially hazardous situation.

If not avoided, this could result in property damage or risk of damage to the unit.

1. **Read these instructions.** – All the safety and operating instructions should be read before the apparatus or system is operated.
2. **Keep these instructions.** – The important safety instructions and operating instructions should be retained for future reference.
3. **Heed all warnings.** – All warnings on the apparatus and in the operating instructions should be adhered to.
4. **Follow all instructions.** – All instructions for installation or use/operating should be followed.
5. **Do not use this apparatus near water.** – Do not use this apparatus near water or a moist environment - for example, near a bath tub, wash bowl, kitchen sink, or laundry tub, in a wet basement, near a swimming pool, in an unprotected outdoor installation, or any area which is classified as a wet location.
6. **Clean only with dry cloth.** – Unplug the apparatus from the outlet before cleaning. Do not use liquid cleaners or aerosol cleaners.
7. **Do not block any ventilation openings. Install in accordance with the manufacturer's instructions.** – Openings in the enclosure, if any, are provided for ventilation and to ensure reliable operation of the apparatus and to protect it from overheating. These openings must not be blocked or covered. This apparatus should not be placed in a built-in installation unless proper ventilation is provided or the manufacturer's instructions have been adhered to.
8. **Do not install near any heat sources such as radiators, heat registers, stoves, or other apparatus (including amplifiers) that produce heat or in direct sunlight.**
9. **No naked flame sources, such as lighted candles, should be placed on the apparatus.**
10. **Do not defeat the safety purpose of the polarized or ground-type plug.** – A polarized plug has two blades with one wider than the other. A grounding type plug has two blades and a third grounding prong. The wider blade or the third prong are provided for your safety. If the provided plug does not fit into your outlet, consult an electrician for replacement of the obsolete outlet.
11. **Protect the power cord from being walked on or pinched particularly at plug, convenience receptacles, and the point where they exit from the apparatus.**
12. **Only use attachments/accessories specified by the manufacturer.** – Any mounting of the apparatus should follow the manufacturer's instructions, and should use a mounting accessory recommended by the manufacturer.

13. **Use only with the cart, stand, tripod, bracket or table specified by the manufacturer, or sold with the apparatus.** – When a cart is used, use caution when moving the cart/apparatus combination to avoid injury from tip-over. Quick stops, excessive force, and uneven surfaces may cause the appliance and cart combination to overturn.
14. **Unplug this apparatus during lightning storms or when unused for long periods of time.** – Not applicable when special functions are to be maintained, such as evacuation systems.
15. **Refer all servicing to qualified service personnel.** – Servicing is required when the apparatus has been damaged in any way, such as power-supply cord or plug is damaged, liquid has been spilled or objects have fallen into the apparatus, the apparatus has been exposed to rain or moisture, does not operate normally, or has been dropped.
16. **The apparatus shall not be exposed to dripping or splashing and that no objects filled with liquid, such as vases, shall be placed on the apparatus.**
17. **Batteries (battery pack or batteries installed) shall not be exposed to excessive heat such as sunshine, fire or the like.**

**Caution!**

Danger of explosion if battery is incorrectly replaced. Replace only with the same or equivalent type. Dispose of used batteries according to the environmental law and procedures.

18. **Professional installation only** – Do not use this equipment in residential applications.
19. **Condensation** – In order to avoid condensation; wait a few hours before turning on the equipment when it is transported from a cold to a warm space.
20. **Hearing damage** – For apparatus with audio output, to prevent possible hearing damage, do not listen at high volume levels for long periods.
21. **Replacement parts** – When replacement parts are required, be sure the service technician has used replacement parts specified by the manufacturer or having the same characteristics as the original part. Unauthorized substitutions may result in fire, electric shock or other hazards.
22. **Safety check** – Upon completion of any service or repairs to this apparatus, ask the service technician to perform safety checks to determine that the apparatus is in proper operating condition.

**Danger!**

**Overloading** – Do not overload outlets and extension cords as this can result in a risk of fire or electric shock.

23. **Power sources** – This apparatus should be operated only from the type of power source indicated on the marking label. If you are not sure of the type of power supply you plan to use, consult your appliance dealer or local power company. For apparatuses intended to operate from battery power, or other sources, refer to the operating instructions.
24. **Power lines** – An outdoor system should not be located in the vicinity of overhead power lines or other electric light or power circuits, or where it can fall into such power lines or circuits. When installing an outdoor system, extreme care should be taken to keep from touching such power lines or circuits, as contact with them might be fatal. U.S.A. models only – refer to the National Electrical Code Article 820 regarding installation of CATV systems.

**Danger!**

**Object and Liquid entry** – Never push objects of any kind into this apparatus through openings as they may touch dangerous voltage points or short-out parts that could result in a fire or electric shock. Never spill liquid of any kind on the apparatus.

25. **Coax grounding** – If an outside cable system is connected to the apparatus, be sure the cable system is grounded. U.S.A. models only: Section 810 of the National Electrical Code, ANSI/NFPA No.70-1981, provides information with respect to proper grounding of the mount and supporting structure, grounding of the coax to a discharge apparatus, size of grounding conductors, location of discharge unit, connection to grounding electrodes, and requirements for the grounding electrode.
26. **Protective grounding** – An apparatus with class I construction shall be connected to a power outlet socket with a protective grounding connection.
- Protective earthing** – An apparatus with class I construction shall be connected to a mains socket outlet with a protective earthing connection.

**Note for power connections**

- For permanently connected equipment, a readily operable mains plug or all-pole mains switch shall be external to the equipment and in accordance with all applicable installation rules.
- For pluggable equipment, the socket-outlet shall be installed near the equipment and shall be easily accessible.



This label may appear on the bottom of the apparatus due to space limitations.

**Caution!**

To reduce the risk of electrical shock, DO NOT open covers. Refer servicing to qualified service personnel only.

**Warning!**

To prevent fire or shock hazard, do not expose units to rain or moisture.

**Warning!**

Installation should be performed by qualified service personnel only in accordance with the National Electrical Code or applicable local codes.

**Warning!**

**Power disconnect:** If the apparatus is mains powered and a power supply cord set is provided, the disconnect device is the mains plug of the power cord set.

If an AC-DC adapter is provided and the mains plug that is part of the direct plug-in device, the AC-DC adapter is the disconnect device.

The socket outlet shall be near the apparatus and shall be easily accessible.

**Warning!**

To avoid electric shock, do not connect safety extra-low voltage (SELV) circuits to telephone-network voltage (TNV) circuits. LAN ports contain SELV circuits, and WAN ports contain TNV circuits. Some LAN and WAN ports both use RJ-45 connectors. Use caution when connecting cables.

**Old electrical and electronic appliances**

Electrical or electronic devices that are no longer serviceable must be collected separately and sent for environmentally compatible recycling (in accordance with the European Waste Electrical and Electronic Equipment Directive).

To dispose of old electrical or electronic devices, you should use the return and collection systems put in place in the country concerned.

THIS CLASS B DIGITAL APPARATUS COMPLIES WITH CANADIAN ICES-003. CET APPAREIL NUMÉRIQUE DE LA CLASSE B EST CONFORME À LA NORME NMB-003 DU CANADA.



Only used at altitude not exceeding 2000m.



Only used in non-tropical climate regions.

## 2 Short information

The PVA-2P500 class-D amplifier is a 2 × 500 W professional audio amplifier for evacuation purposes. It can be operated from both the mains and a DC supply. The output voltage is galvanically insulated and is constantly monitored for ground fault. An energy-saving mode and temperature-controlled fans reduce energy consumption and noise levels. The control and monitoring functions are performed via CAN bus. This amplifier is designed for operation in an emergency evacuation system. It can be used as system amplifier or in stand-alone mode. The amplifiers are usually controlled via a controller and configured using IRIS-Net.

The power amplifier has the following features:

- Floating 100 V or 70 V power outputs
- High efficient amplifier blocks in class-D technology
- Outputs idling and short circuit-protected
- Mains operation 120–240 V (50/60 Hz) and/or 24 V DC emergency backup
- Electronically balanced inputs
- Temperature monitoring function
- Pilot tone and ground fault monitoring function via PVA-4CR12 controller or PVA-4R24 router
- Processor control of all functions
- Monitoring of the processor system via watchdog circuit
- Non-volatile FLASH memory for configuration data
- Internal monitoring function
- Integrated audio relays
- Line monitoring function

The power amplifier is processor-controlled and equipped with extensive monitoring functions. Line monitoring for the CAN bus and for audio transmission allows line interruptions and short-circuits to be detected and indicated to the user.





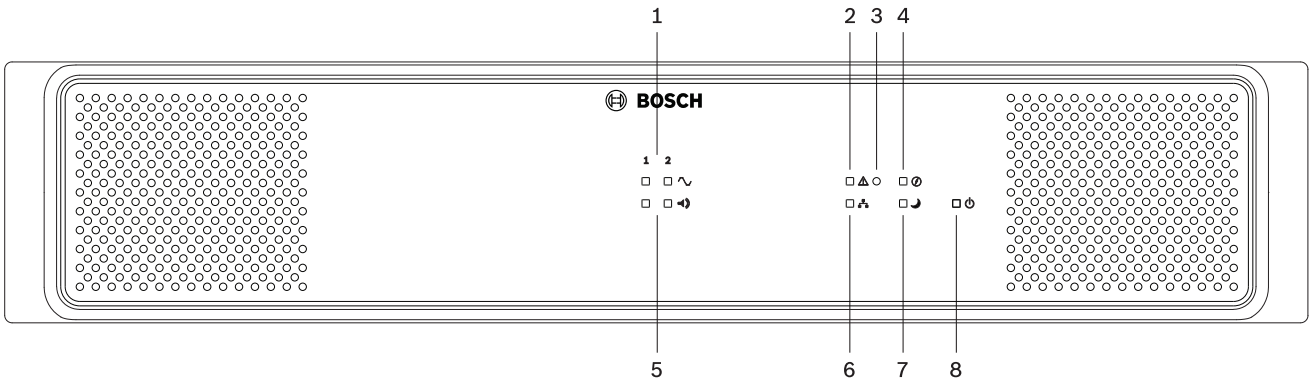

### 3 System overview

#### 3.1 Front panel



Number	Symbol	Element	Description
1	~	Signal clip indicator light	Indicates the signal level of the amplifier channel: <ul style="list-style-type: none"> <li>Green = The output signal is 18 dB below clip level</li> <li>Yellow = The output signal is clipping or the integrated limiter of the amplifier is limiting the output signal.</li> </ul>
2	⚠	General fault warning indicator light	This indicator lights up yellow when a fault has occurred in the device. The types of faults to be displayed via this indicator are configured in IRIS-Net. Please refer to section <i>Operation, page 25</i> .

Number	Symbol	Element	Description
3		Recessed button	<p>The button is protected to prevent it from being pressed accidentally. Use a pointed object (such as a ballpoint pen) to press the button.</p> <p>This button has the following functions if the CAN address of the device is <b>not</b> set to 00:</p> <ul style="list-style-type: none"> <li>– Find function: If the find function of the device is activated, press this button to deactivate the indicators.</li> <li>– Displaying the CAN baud rate: Press this button for at least one second. Please refer to section <i>Displaying the CAN baud rate, page 24</i>.</li> <li>– LED test: Press this button for at least three seconds to activate the LED test. All indicators at the front panel light up as long as the button is pressed.</li> </ul> <p>This button has the following functions if the CAN address of the device is set to 00 (stand-alone mode):</p> <ul style="list-style-type: none"> <li>– Resetting a ground fault or watchdog fault: Press the button briefly to confirm a watchdog fault or ground fault (stand-alone mode only, please refer to section <i>Stand-alone mode, page 25</i>)</li> <li>– Setting/displaying the CAN baud rate: Press this button for at least one second. Please refer to section <i>Configuring the CAN baud rate, page 24</i>.</li> <li>– Resetting to delivery condition: To reset all settings to their original configuration on delivery, press this button for at least three seconds to reset all device settings.</li> </ul>
4		Ground fault indicator light	<p>This indicator lights up yellow when a ground fault has occurred at least one output. The indicator remains illuminated even when the ground fault has been resolved. To deactivate the indicator, press the Recessed button (3) or use IRIS-Net. Please refer to section <i>Stand-alone mode, page 25</i>.</p>
5		Audio signal indicator light	<p>This indicator lights up green if an audio signal (signal level &gt; -36 dB) is present at the power amplifier input.</p>
6		Network indicator light	<p>This indicator lights up green in the event of successful data communication with the controller.</p>

Number	Symbol	Element	Description
7		Standby indicator light	This indicator lights up green when the device is in standby mode.
8		Power indicator light	This indicator lights up green when the power supply is OK.

### 3.2 Rear panel

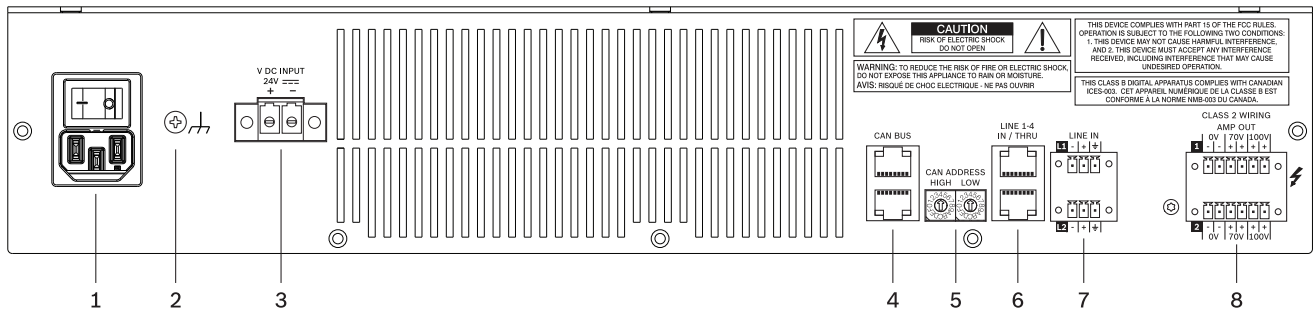

Number	Element	Description
1	AC power input and power switch	
2	Grounding screw	Ground connection for DC only systems.
3	DC power input	
4	CAN BUS port	Connection with CAN bus, e.g. controller.
5	CAN ADDRESS selector switch	HIGH-byte and LOW-byte for configuring the CAN address of the device.
6	LINE 1-4 IN / THRU audio input sockets (RJ-45)	Audio input (and through socket) for all channels. Please refer to section <i>Audio inputs</i> , page 16.
7	LINE IN L1 or L2 audio input sockets (Euroblock)	Balanced audio input for channels 1 or 2. Please refer to section <i>Audio inputs</i> , page 16.
8	Amplifier power output sockets (70 V or 100 V)	Power output for speaker zones. Please refer to section <i>Audio output</i> , page 18.

## 4 Parts included

Quantity	Component
1	PVA-2P500
1	Power cord 230 V AC
1	Power cord 120 V AC
1	Euroblock connector 2-pole (Phoenix, PC 5/2-STF-7,62, 1975697, F.01U.108.398) for 24 V DC
2	Euroblock connector 3-pole (Phoenix, MC 1,5/3-STF-3,81, Nr. 1827716, F.01U.104.680) for audio input
2	Euroblock connector 6-pole (Phoenix, MC 1,5/6-ST-3,81, 1827745, F.01U.104.179) for audio outputs
4	Foot stand (self-adhesive)
1	Operation manual
1	Important safety instructions

## 5 Installation

This device has been designed to be installed horizontally in a conventional 19" rack cabinet. In general, an installation location must be selected in which the device is protected from the following conditions:

- Dripping water or spray
- Direct sunlight
- High ambient temperatures or direct effect of sources of heat
- High level of humidity
- Heavy dust accumulation
- Strong vibrations

### Front attachment of the device

Refer to the following illustration to attach the front of the device, using four screws and washers. Because of painted surfaces the connection of the grounding screw at the rear panel of the device is recommended.

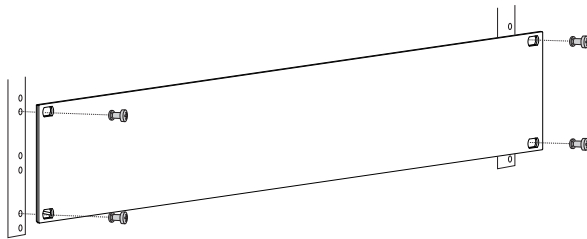
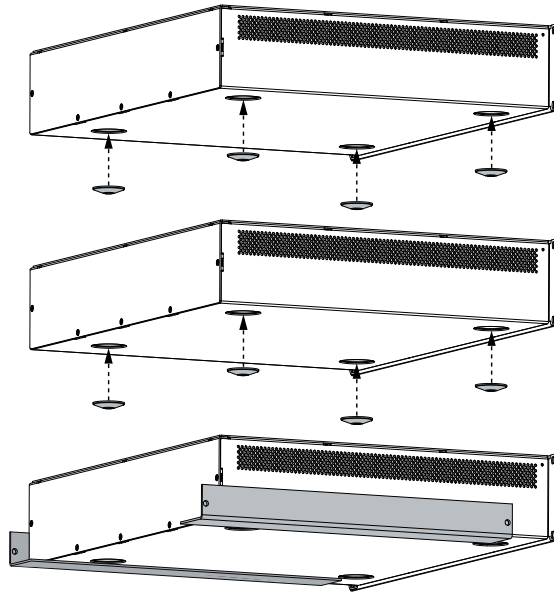

Figure 5.1: Installation of the device into a 19" rack



### Caution!

The use of rack mount rails is recommended when installing the device in a rack shelf or rack cabinet to prevent the front panel from twisting or warping. If devices should be stacked in the rack (e.g. using the self-adhesive foot stands supplied) the maximum permissible load of the mount rails must be considered. Please refer to the technical specifications provided by the rack rail manufacturer.



**Figure 5.2: Stacking of devices using the supplied foot stands (example with 3 devices, rack mount rails are used for the bottom device only)**

### **Heat development**

The table in chapter Specification can be used to determine the requirements for power supply and supply lines. The power drawn from the mains is converted into output power to feed the loudspeaker systems and heat. The difference between power consumption and power output is called power dissipation ( $P_{\text{loss}}$ ). The heat that is generated by losses might stay in the rack shelf and has to be dissipated by appropriate measures. The table can be used to calculate the thermal ratio inside of a rack shelf/cabinet or for dimensioning the perhaps required ventilation measures. The  $P_{\text{loss}}$  column lists the power dissipation for various operating conditions.

## 6 Connection

### 6.1 Audio inputs

The power amplifier has four audio input channels. With the help of integrated pilot tone monitoring, a missing or faulty input signal can be detected reliably. Please refer to section *Circuit diagram, page 32* for details about the internal audio routing of the device.

#### RJ-45

LINE 1-4  
IN / THRU

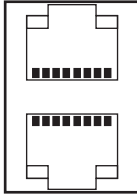

The pin assignment of the LINE 1-4 IN / THRU audio input sockets allows connecting the power amplifier to the RJ-45 audio output socket of a controller using standard RJ-45 patch cables. The two RJ-45 sockets are switched in parallel which allows looping through the audio signal.

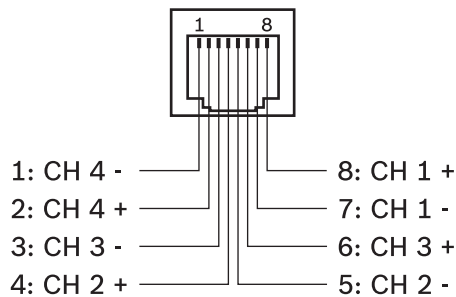

Figure 6.1: Pin assignment of LINE IN 1-4 socket



#### Notice!

Do not use Ethernet crossover cables to connect audio inputs. Only use high quality straight through Ethernet cables with shielding.



#### Notice!

Do not plug a CAN terminating resistor into the LINE IN 1-4 socket.



**Euroblock**

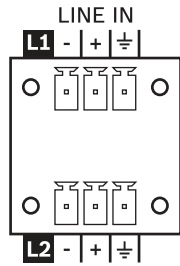

The L1 or L2 audio inputs allow to connect local audio sources, e.g. in stand-alone mode. The audio signal L1 is mixed with input signal LINE IN 4 (provided via RJ-45) and amplified by amplifier output channel 1. Audio signal L2 is mixed with input signal LINE IN 4 and amplified by amplifier output channel 2.



**Notice!**

If local audio sources should be used while full system supervision is required, a pilot tone must be available at LINE IN 4. Please refer to section *Circuit diagram*, page 32 and the documentation of IRIS-Net.

The audio inputs are electronically balanced. You must always use a balanced audio signal at the input of the device where this is possible. The scope of delivery for the device includes a 3-pin connector. Conductor cross-sections of 0.14 mm<sup>2</sup> (AWG26) to 1.5 mm<sup>2</sup> (AWG16) can be used.

Recommended connecting cable: balanced cable with shielded flexible 2 x 0.14 mm<sup>2</sup>.

**Balanced cabling**

The following illustration shows the balanced cabling of an audio input (or output) on the device.

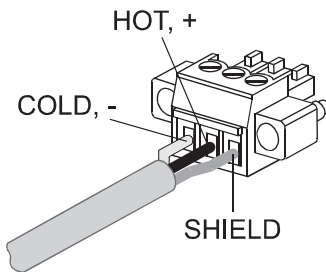

**Figure 6.2: Balanced cabling**

**Unbalanced cabling**

If the connecting cable(s) is/are very short and no interference signals are to be expected in the environment of the device, then an unbalanced signal can also be connected. In this case, it is imperative that a bridge in the connector between the shield and the inverting pin is switched (see diagram below), otherwise the level can drop by 6 dB. However, for reasons of immunity to external interference sources such as dimmers, mains supplies, HF control lines etc., balanced cabling is always preferable.

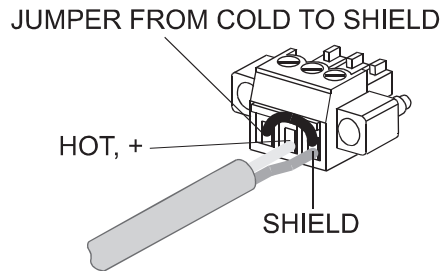
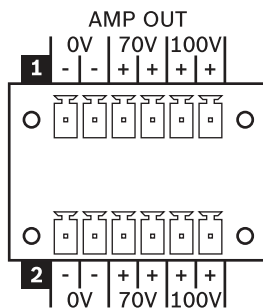

Figure 6.3: Unbalanced cabling

## 6.2

### Audio output



The audio outputs on the device are galvanically insulated and are constantly monitored for ground fault. For each output channel there are 6 pins, two pins for 0V, two pins for 70V and two pins for 100V speaker lines. The delivery for the device includes 6-pole connectors. Conductor cross-sections of 0.14 mm<sup>2</sup> (AWG26) to 1.5 mm<sup>2</sup> (AWG16) can be used. Recommended connecting cable: flexible CU strand, LiY, 0.75 mm<sup>2</sup>. For ease of installation, the connector can be removed. With regard to the maximum number of speakers that can be connected, speakers can be connected until the point at which the total power consumption of the speaker network corresponds to the nominal power value of the output stage, where the rated load resistance of the output stage outputs is not to be exceeded. The nominal power values and the rated load resistances of the outputs can be found in the section entitled Technical data.



#### Notice!

Conductor cross-section

The maximum voltage drop must be less than 10% to avoid alarm signal attenuation and ensure a sufficient signal level of the pilot tone for (optional) EOL modules.



#### Notice!

Do not use 70V and 100V outputs simultaneously.



#### Danger!

It is possible that during operation shock hazard voltages (> 140 V peak value) may be present at the outputs. Therefore, the connected loudspeaker zones have to be installed in accordance with applicable safety regulations. When installing and operating 100 V loudspeaker networks, compliance with the VDE regulation DIN VDE 0800 is mandatory. Especially, when 100 V loudspeaker networks in alarm system applications are concerned, all safety precautions have to be in accordance with the safety class 3 standard.

### 6.3 Supply voltage

The device is normally operated via the AC mains input (120–240 V). In addition, a battery input is available for emergency power operation (24 V DC).



**Notice!**

If the AC and DC power inputs are used, it is recommended to connect AC power first, then switch on the device, then connect the DC power source.



**Notice!**

A power-on delay can be programmed for the PVA-2P500 via IRIS-Net. Upon switching on the power supply the device does not start until the set delay time has elapsed. If several devices are operated on the same automatic circuit breaker (or battery), cascaded switch-on can be accomplish by programming individually different power-on delays for the devices. This also prevents the magnetic trip of an automatic circuit breaker from acting and thus disconnecting the devices from the mains supply, when various devices are switched on at the same time.

#### AC input and power switch

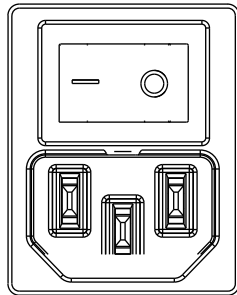

The power supply to the device is provided via the mains input using the supplied IEC cable only. During installation, always disconnect the device from all supply voltages. Connect the device only to a suitable power supply that meets the requirements specified on the type plate. The associated fuse is located on the inside of the amplifier and is not accessible from outside of the device.

The power switch at the rear separates the device from the power supply when the switch is in the off position (0). The device starts booting up when the switch is in the on position (I). A soft-start circuit limits in-rush current peaks occurring during this process. The speakers are switched on via the output relays after a time delay. This effectively suppresses any audible in-rush noises.

#### DC input

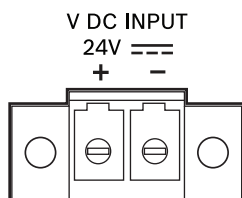

The device automatically switches to DC input in the event of failure of the mains supply voltage. For this input, connect a 24-volt DC source to the DC INPUT input. The scope of delivery for the device includes a 2-pin connector. Conductor cross-sections of 2 mm<sup>2</sup> to 6 mm<sup>2</sup> can be used.

Recommended connecting cable: flexible CU strand, LiY, 4 mm<sup>2</sup>.

The DC input is protected against incorrect polarity and overload. The associated fuse is located on the inside of the device and is not accessible from outside of the device. The threshold of the internal audio peak limiters are lowered by 3 dB if DC is connected only.



#### Notice!

The DC input cannot be switched off. The power switch can only be used to switch off the mains power supply.

## 6.4

### CAN BUS

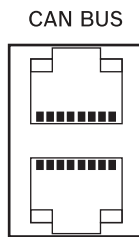

This section contains information about the connection of the device to the CAN BUS and the correct setting of the CAN address.

#### Connection

The device has two RJ-45 jacks for the CAN BUS. The jacks are connected in parallel, and act as an input and for daisy chaining the network. The CAN bus allows different data rates to be used, where the data rate is indirectly proportional to the bus length. If the network is small, data rates of up to 500 kbit/s are possible. In larger networks, the data rate must be decreased (down to the minimum data rate of 10 kbit/s), please refer to section Configuring the CAN baud rate.



#### Notice!

The data rate is preset to 10 kbit/s in the factory.

The following table explains the relationship between data rates and bus lengths/network size. Bus lengths of over 1,000 m must be implemented only with CAN repeaters.

Data rate (in kbit/s)	Bus length (in meters)
500	100
250	250
125	500
62.5	1000

**Table 6.1: Data rate and bus length of the CAN BUS**

The following diagrams show the assignment of the CAN port/CAN connector.

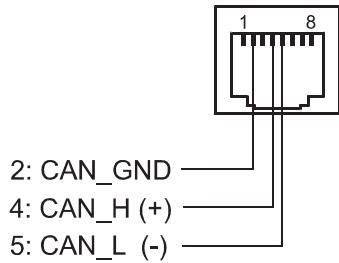

Figure 6.4: Assignment of the CAN port

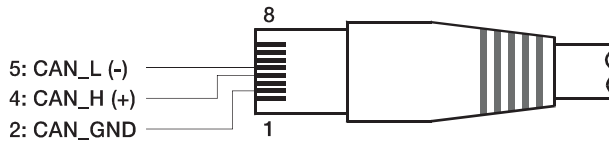

Figure 6.5: Assignment of the CAN connector

Pin	Designation	Cable color	
		T568A	T568B
2	CAN_GND	Green	Orange
4	CAN_H (+)	Blue	
5	CAN_L (-)	Blue stripes	

Table 6.2: Assignment of the CAN BUS interface

**Cable specification**

In accordance with the ISO 11898-2 standard, shielded twisted-pair cables with an impedance of 120 ohms must be used as the data transfer cable for the CAN bus. A terminating resistance of 120 ohms must be provided at both ends as the cable terminator. The maximum bus length depends on the data transmission rate, the type of data transmission cable, and the number of bus participants.

Bus length (in m)	Data transmission cable		Termination (in Ω)	Maximum data transmission rate
	Resistance per unit (in mΩ/m)	Cable cross-section		
0 to 40	< 70	0.25 to 0.34 mm <sup>2</sup> AWG23, AWG22	124	1000 kbit/s at 40 m
40 to 300	< 60	0.34 to 0.6 mm <sup>2</sup> AWG22, AWG20	127	500 kbit/s at 100 m
300 to 600	< 40	0.5 to 0.6 mm <sup>2</sup> AWG20	150 to 300	100 kbit/s at 500 m
600 to 1000	< 26	0.75 to 0.8 mm <sup>2</sup> AWG18	150 to 300	62.5 kbit/s at 1000 m

Table 6.3: Relationships for CAN networks with up to 64 participants

If there are long cables and several devices on the CAN bus, terminating resistors with ohm ratings higher than the specified 120 ohms are recommended in order to reduce the resistive load for the interface drivers, which in turn reduces the voltage loss from one cable end to another.

The following table allows initial estimates for the required cable cross-section for different bus lengths and various numbers of bus participants.

Bus length (in m)	Number of devices on the CAN Bus		
	32	64	100
100	0.25 mm <sup>2</sup> or AWG24	0.34 mm <sup>2</sup> or AWG22	0.34 mm <sup>2</sup> or AWG22
250	0.34 mm <sup>2</sup> or AWG22	0.5 mm <sup>2</sup> or AWG20	0.5 mm <sup>2</sup> or AWG20
500	0.75 mm <sup>2</sup> or AWG18	0.75 mm <sup>2</sup> or AWG18	1.0 mm <sup>2</sup> or AWG17

**Table 6.4: CAN BUS cable cross-section**

If a participant cannot be directly connected to the CAN bus, a stub line (branch line) must be used. Since there must always be precisely two terminating resistors on a CAN bus, a stub line cannot be terminated. This creates reflections, which impair the rest of the bus system. To minimize these reflections, these stub lines must not exceed a maximum individual length of 2 m at data transmission rates of up to 125 kbit/s, or a maximum length of 0.3 m at higher bit rates. The overall length of all branch lines must not exceed 30 m.

The following applies:

- In terms of rack wiring, standard RJ-45 patch cables with 100-ohm impedance (AWG 24/ AWG 26) can be used for short distances (up to 10 m).
- The guidelines specified above for the network cabling must be used when wiring the racks with each other and for the building installation.

**See also**

- *Configuring the CAN baud rate, page 24*

## 7 Configuration

### 7.1 Setting the CAN address

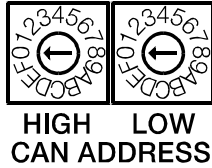

The CAN address of the device is set using the two address selector switches HIGH and LOW. Addresses 1 to 250 (01 hex to FA hex) can be used in a CAN network. The address is set using the hexadecimal numbering system. The LOW selector switch is for the low-order digit and the HIGH selector switch is for the high-order digit.



#### Notice!

Each address may only occur once in the system, otherwise network conflicts will occur.

The address 0 (00 hex, set on delivery) ensures that the device is disconnected from the remote communication. This means that the device does not appear in the system, even if it is connected to the CAN bus.

HIGH	LOW	Address
0	0	Stand-alone
0	1 to F	1 to 15
1	0 to F	16 to 31
2	0 to F	32 to 47
3	0 to F	48 to 63
4	0 to F	64 to 79
5	0 to F	80 to 95
6	0 to F	96 to 111
7	0 to F	112 to 127
8	0 to F	128 to 143
9	0 to F	144 to 159
A	0 to F	160 to 175
B	0 to F	176 to 191
C	0 to F	192 to 207
D	0 to F	208 to 223
E	0 to F	224 to 239

HIGH	LOW	Address
F	0 to A	240 to 250
F	B to F	Reserved

Table 7.1: CAN addresses

## 7.2 Displaying the CAN baud rate

To display the CAN baud rate, press the Recessed button and keep the button pressed down for at least one second. Three front panel indicator lights then display the set baud rate for two seconds. Please refer to the following table for details.

Baud rate (in kbit/s)	Audio signal indicator light of channel 1	Audio signal indicator light of channel 2	Network indicator light
10	Off	Off	On
20	Off	On	Off
62.5	Off	On	On
125	On	Off	Off
250	On	Off	On
500	On	On	Off

Table 7.2: Displaying the CAN baud rate via indicator lights on the front panel

## 7.3 Configuring the CAN baud rate

The CAN baud rate can be configured using a UCC1 USB-CAN CONVERTER or directly on the front of the device.

### Changing the CAN baud rate



#### Notice!

The CAN baud rate can only be changed if the CAN address is set to 00.

To change the CAN baud rate, perform the following steps:

1. Press the Recessed button and keep the button pressed down for at least one second. The CAN baud rate is indicated for two seconds, please refer to the section entitled “Displaying the CAN baud rate” for more information.
2. As soon as the CAN baud rate is displayed, release the Recessed button. Please note that if the button is pressed for more than 3 seconds, the device will be reset to factory settings.
3. Briefly press the Recessed button to switch to the next-higher CAN baud rate. The LEDs indicate the new setting.
4. Repeat step 3 until the desired baud rate has been set. (Example: To change the baud rate from 62.5 kbit/s to 20 kbit/s, press the Recessed button exactly five times, i.e. 62.5 > 125 > 250 > 500 > 10 > 20).
5. The new CAN baud rate is applied two seconds after the last time that the Recessed button is pressed.



## 8 Operation

### Fault monitoring

The following functions of the power amplifier can be monitored:

- Mains under-voltage
- Battery under-voltage
- Excessive temperature
- Overload
- Output voltage
- Output current
- Ground fault (in stand-alone mode only)
- Pilot tone monitoring when used in combination with PVA-4CR12 and PVA-4R24
- Monitoring of the microprocessor
- CAN BUS connection

Whenever a fault occurs in the power amplifier, this is always indicated by means of the General fault warning indicator light lighting up. IRIS-Net can be used to configure which power amplifier fault types are to be displayed. The monitoring of functions that are not being used (e.g. DC input) must be deactivated, otherwise a permanent fault is displayed.

### Standby mode

In standby mode the power consumption of the PVA-2P500 is below 2 W (AC or DC power supply). Following functions are available in standby mode:

- Remote control via CAN bus
- Supervision of the AC power input
- Supervision of the DC power input

The standby mode is activated or deactivated via CAN bus. The standby mode will be deactivated automatically if the CAN bus is disconnected or the CAN address is set to 0 (stand-alone mode).

## 8.1 Stand-alone mode

### Audio signals

In stand-alone mode (without CAN connection to a controller, e.g. CAN address set to 0) the audio input signal L1 (or L2) is mixed with audio input 4, amplified with 36 dB and provided by audio output 1 (or 2).

### Ground fault monitoring

The VDE specification DIN VDE 0800 must be observed when setting up and operating 100-volt speaker systems. Particularly with 100-volt speaker systems that are used for alarm purposes, all protective measures must be designed for measuring class 3. The integrated ground fault monitoring function in the power amplifier allows the insulation of the ungrounded speaker line network to be monitored in stand-alone mode. Any ground fault (e.g.  $R \leq 50\text{k}\Omega$ ) that occurs is an indication of either cable damage, which means that a line interruption may occur in the near future, or a wiring fault, which can result in malfunctions. A ground fault that has been present for at least five seconds is indicated on the front panel by the Ground fault indicator light lighting up yellow. The Ground fault indicator light lights up until the power supply to the output stage is disconnected or the error is reset by pressing the Recessed button.

To test the ground fault monitoring function, use a 22 kOhm resistor (the power amplifier must not be in STANDBY mode during the testing process). If the resistance is switched from a terminal of the power output socket to protective ground for approx. five seconds, the Ground fault indicator light must light. If the resistance is greater than 100 kOhms and the

capacity is less than 5  $\mu\text{F}$ , the Ground fault indicator light must not light up. After the resistor has been removed, the display and the malfunction message must continue to be shown. To reset the ground fault monitoring function, press the Recessed button.

## 9 Maintenance

### 9.1 Firmware update

IRIS-Net can be used to update the firmware on the device. Depending on the CAN data rate used, the update will take one or more minutes to complete. Since development work is always being performed in relation to all system software, it may be necessary to update the firmware on the controller. Any software incompatibilities are displayed in IRIS-Net. For more information on firmware updates, please refer to the IRIS-Net documentation.

### 9.2 Resetting to factory default settings

The device is programmed in the factory with the following functions and properties:

Parameter	Setting/description
CAN baud rate	10 kbit/s
Input routing	Line input L1 to CH 1 Line input L2 to CH 2 Line input 4 to CH 1 and CH 2 (in stand-alone mode)
Output relays	All closed

**Table 9.1: Device factory default settings**

The device settings can be reset to the default values manually or using IRIS-Net. To perform a manual reset, perform the following steps **with the device switched on**:

1. Disconnect the device from the CAN BUS.
2. Set the address to "00" using the CAN ADDRESS selector switch on the rear panel.
3. Press the Recessed button on the front panel and keep the button pressed down for three seconds.

The device has now been reset to the factory default settings.



#### **Caution!**

Before reconnecting the device to the CAN BUS, note the CAN baud rate, which may change under certain circumstances.

## 10 Technical data

### Specification

Rated load impedance (output power)	
- 100 V	20 $\Omega$ (500 W)
- 70 V	10 $\Omega$ (500 W)
Rated output power, 1 kHz, THD $\leq$ 1%	2 $\times$ 500 W <sup>1</sup>
Rated input voltage	+6 dBu
Max. RMS voltage swing, 1 kHz, THD $\leq$ 1%, without load	
- 100 V	110 V
- 70 V	78 V
Voltage gain, ref. 1 kHz, fixed	
- 70 V	33.2 dB
- 100 V	36.2 dB
Maximum load capacitance	2 $\mu$ F
Input level, max.	+18 dBu (9.75 V <sub>rms</sub> )
Frequency response, ref. 1 kHz, rated load, -3 dB	50 Hz to 25 kHz
Input impedance, active balanced	20 k $\Omega$
Signal-to-noise ratio (A-weighted)	> 104 dB
Output noise (A-weighted)	< -62 dBu
Crosstalk, ref. 1 kHz	< -85 dB
Output stage topology	Class-D, transformer, floating
Power requirements	
- AC	115-240 V (-10/+10%) <sup>2</sup>
- DC	21-32 V
Power consumption, AC and DC	See section "Power consumption" in operation manual
Inrush current	2 A
Inrush current, after five-second power cycle	1.3 A
Mains fuse	T6.3A (internally)
DC fuse	30A (internally)
Ground fault	R < 50 k $\Omega$
CAN BUS port	2 $\times$ RJ-45, 10 to 500 kbit/s

Protection	Audio input level limiter, RMS output power limiter, high temperature, DC, short circuit, mains undervoltage protection, DC supply undervoltage protection, inrush current limiter, ground fault
Cooling	Front-to-rear, temperature-controlled fans
Operating temperature	-5 °C to +45 °C
Safety class	Class I
Electromagnetic environment	E1, E2, E3
Product dimensions (Width × Height × Depth)	19", 2 HU, 483 × 88.2 × 391 mm
Net weight	16.5 kg
Shipping weight	19 kg

<sup>1</sup> In DC mode and in continuous alarm-signal operation, output signal limited by 3 dB max.

<sup>2</sup> Reduced output power at mains voltages below 115 V

## 10.1 Standards

- EN 50130-4
- EN 50581
- EN 55103-1/2
- EN 61000-3-2/3
- EN 61000-6-3
- IEC 60065
- EN 60945

## 10.2 Power consumption

### 230 V/50 Hz operation

	<b>I<sub>supply</sub></b>	<b>S<sub>supply</sub></b>	<b>P<sub>supply</sub></b>	<b>P<sub>out</sub></b>	<b>BTU/h</b>
Standby	0.14 A	33.0 VA	1.9 W	0.0 W	6.5
Idle (no audio)	0.20 A	47.0 VA	19.5 W	0.0 W	66.5
Announcement (-10 dB)	0.88 A	202 VA	175 W	100 W	255.8
Alert (-3 dB)	3.35 A	772 VA	745 W	500 W	835.5

### 120 V/60 Hz operation

	<b>I<sub>supply</sub></b>	<b>S<sub>supply</sub></b>	<b>P<sub>supply</sub></b>	<b>P<sub>out</sub></b>	<b>BTU/h</b>
Standby	0.09 A	9.0 VA	1.3 W	0.0 W	4.4
Idle (no audio)	0.27 A	29.0 VA	17.3 W	0.0 W	59.0
Announcement (-10 dB)	1.6 A	189 VA	175 W	100 W	255.8
Alert (-3 dB)	6.9 A	824 VA	800 W	500 W	1023

### 24 V DC operation

	<b>I<sub>supply</sub></b>	<b>S<sub>supply</sub></b>	<b>P<sub>supply</sub></b>	<b>P<sub>out</sub></b>	<b>BTU/h</b>
Standby	0.06 A	-	1.4 W	0.0 W	4.8
Idle (no audio)	0.65 A	-	15.6 W	0.0 W	53
Announcement (-10 dB)	7.0 A	-	168 W	100 W	232
Alert (-3 dB)	32.5 A	-	780 W	500 W	938

Description of table columns:

- $I_{\text{supply}}$  = RMS current drawn from mains (or DC supply)
- $S_{\text{supply}}$  = apparent power drawn from the mains line
- $P_{\text{supply}}$  = reactive power drawn from mains (or DC supply)
- $P_{\text{out}}$  = NF output power provided to the speaker lines
- $P_{\text{loss}}$  or BTU/h = thermal loss

### 10.3 Dimensions

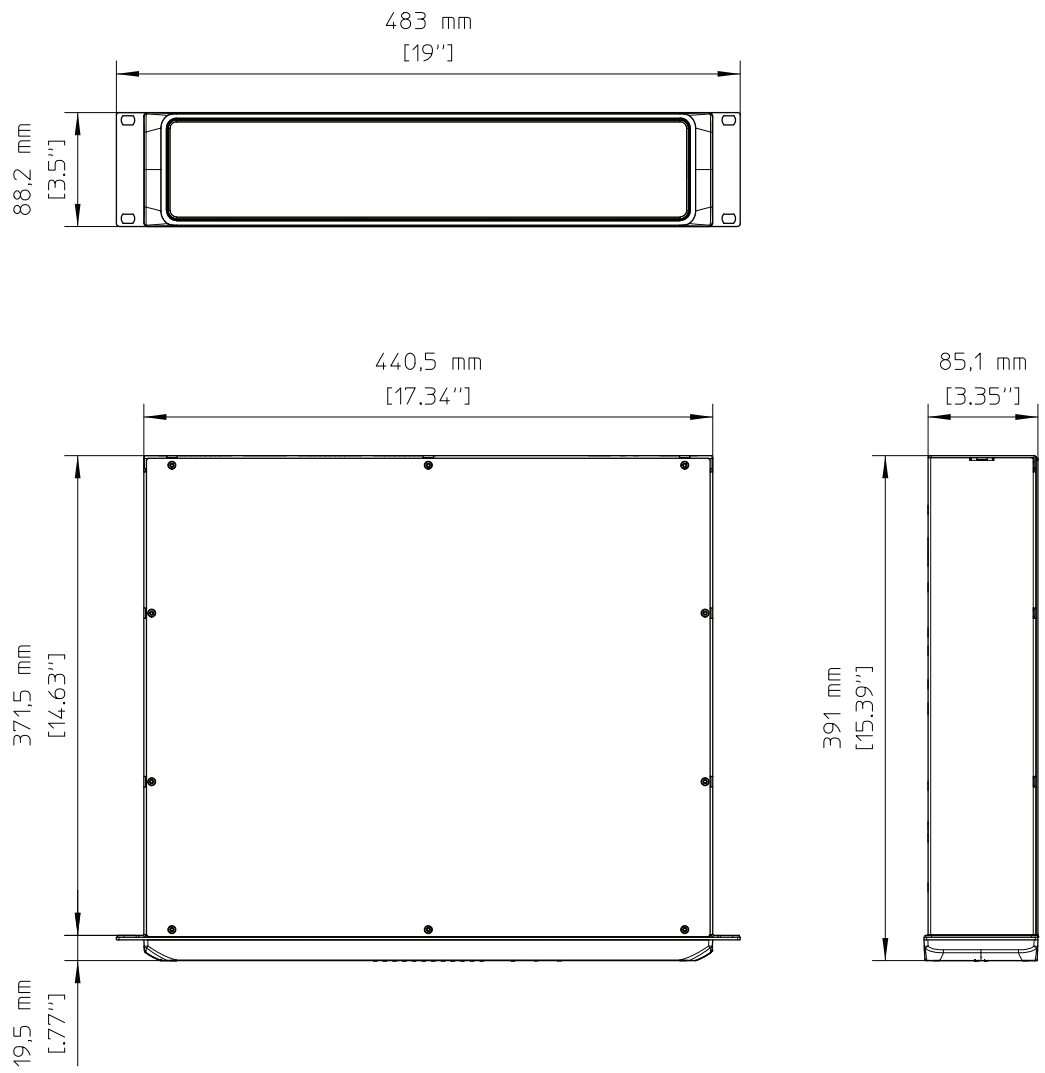

# 10.4 Circuit diagram

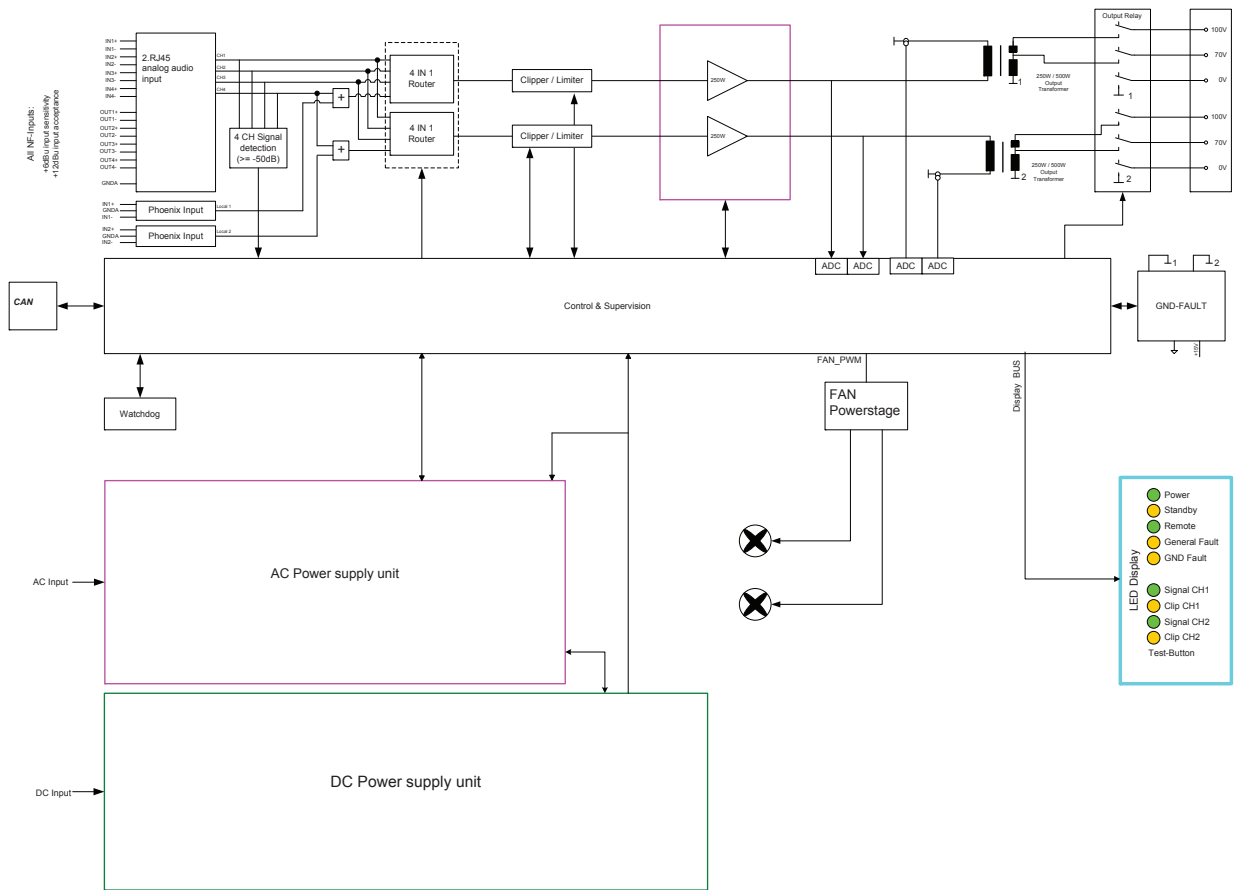





**Bosch Security Systems B.V.**

Torenallee 49

5617 BA Eindhoven

The Netherlands

**[www.boschsecurity.com](http://www.boschsecurity.com)**

© Bosch Security Systems B.V., 2015

## Free Manuals Download Website

<http://myh66.com>

<http://usermanuals.us>

<http://www.somanuals.com>

<http://www.4manuals.cc>

<http://www.manual-lib.com>

<http://www.404manual.com>

<http://www.luxmanual.com>

<http://aubethermostatmanual.com>

Golf course search by state

<http://golfingnear.com>

Email search by domain

<http://emailbydomain.com>

Auto manuals search

<http://auto.somanuals.com>

TV manuals search

<http://tv.somanuals.com>