



**BOSCH**



**Register** your  
new device on  
MyBosch now and  
get free benefits:  
**[bosch-home.com/  
welcome](https://bosch-home.com/welcome)**

# Tumble dryer

**WTR87T82GB**

**en** Installation and operating instructions

## Your new tumble dryer

You have opted for a tumble dryer manufactured by Bosch.

Please take a few minutes to read and become familiar with the advantages of your tumble dryer.

To meet the high quality demands required by Bosch, every tumble dryer that leaves our factory is carefully checked to ensure that it functions correctly and is in perfect condition.

For more information on our products, accessories, replacement parts and services, see our website [www.bosch-home.com](http://www.bosch-home.com) or contact our Customer Service centres.

If the operating and installation instructions describe different models, any differences will be pointed out at the relevant points in the text.



Read these operating and installation instructions before operating the tumble dryer.

## Display rules

### **Warning!**

This combination of symbol and signal word indicates a possibly dangerous situation. Not heeding the warning can cause death or injuries.

### **Caution!**

This signal word indicates a possibly dangerous situation. Not heeding the caution can cause property and/or environmental damage.

### **Note/tip**

Information about the optimum use of the appliance/any other useful information.





















### **1. 2. 3. / a) b) c)**

The steps are represented by numbers or letters.

■ / -

Lists are represented by a small box or a dash.

# Table of contents

 <b>Intended use</b> . . . . .	4	Changing the programme or adding more laundry . . . . .	29
 <b>Safety instructions</b> . . . . .	4	Cancelling the programme . . . . .	29
Children/people/pets . . . . .	4	End of programme . . . . .	29
Installation . . . . .	6	Removing laundry and switching off the appliance . . . . .	29
Operation . . . . .	8	Emptying the condensation container . . . . .	30
Cleaning/Maintenance . . . . .	11	Removing the fluff . . . . .	31
 <b>Energy-saving tips</b> . . . . .	12	 <b>Appliance settings</b> . . . . .	32
 <b>Installing and connecting the appliance</b> . . . . .	13	Childproof lock . . . . .	32
Included with the appliance . . . . .	13	Notification signal . . . . .	33
Installing the appliance . . . . .	13	Altering the appliance settings . . . . .	33
Connecting the appliance . . . . .	15	 <b>Draining the condensation water</b> . . . . .	36
Before using the appliance for the first time . . . . .	17	 <b>Cleaning and maintenance</b> . . . . .	38
Optional accessories . . . . .	17	Cleaning the appliance . . . . .	38
 <b>Quick reference guide</b> . . . . .	18	Cleaning the moisture sensor . . . . .	39
 <b>Familiarising yourself with your appliance</b> . . . . .	19	Cleaning the base unit . . . . .	39
Appliance overview . . . . .	19	 <b>Help with the appliance</b> . . . . .	43
Fascia . . . . .	20	 <b>Transporting the appliance</b> . . . . .	45
 <b>Display</b> . . . . .	21	 <b>Consumption values</b> . . . . .	46
 <b>Overview of programmes</b> . . . . .	23	Consumption values table . . . . .	46
 <b>Programme settings</b> . . . . .	25	Most efficient programme for cotton laundry . . . . .	46
 <b>Laundry</b> . . . . .	26	 <b>Technical data</b> . . . . .	47
Preparing laundry . . . . .	26	 <b>Disposal</b> . . . . .	47
Sorting laundry . . . . .	26	 <b>Customer Service</b> . . . . .	48
 <b>Operating the appliance</b> . . . . .	27		
Loading laundry and switching on the appliance . . . . .	27		
Setting a programme . . . . .	28		
Starting the programme . . . . .	28		
Programme progress . . . . .	28		



## Intended use

- This appliance is intended for private domestic use only.
- Do not install or operate this appliance anywhere that is liable to experience frost and/or outdoor conditions. There is a risk that the appliance will be damaged if residual water in it freezes. If hoses freeze up, they may crack/burst.
- This appliance must only be used for drying and freshening up domestic laundry, consisting of items that have been washed with water and are suitable for tumble drying (see label on item). Using the appliance for any other purpose is outside of the scope of its intended application and is forbidden.
- This appliance is intended for use up to a maximum height of 2000 metres above sea level.

### Before you switch on the appliance:

Check that there is no visible damage to the appliance. Do not operate the appliance if it is damaged. Should you have any problems, please contact your specialist dealer or our customer service.

Read and follow the operating and installation instructions and all other information provided with this appliance.

Retain the documents for subsequent use or for subsequent owners.



## Safety instructions

The following safety information and warnings are provided to protect you from injury and to prevent material damage to your surroundings.

It is nevertheless important to take the necessary precautions and to proceed with care when installing, maintaining, cleaning and operating the appliance.

### Children/people/pets



#### Warning Risk of death!

Children and other people who are unable to assess the risks involved when using the appliance may injure themselves or may find themselves in life-threatening situations. Therefore please note:

- The appliance may be used by children over the age of 8 years and by persons with reduced physical, sensory or mental capacity or by persons with a lack of experience or knowledge as long as they are supervised or have received instruction on how to use the appliance safely and they have understood the potential risks of using the appliance.
- Children must not play with this appliance.

- Do not allow children to clean or maintain this appliance unsupervised.
- Keep children under 3 years and pets away from this appliance.
- Do not leave the appliance unattended when children or other people who are unable to assess the risks are in the vicinity.

**⚠ Warning**  
**Risk of death!**

Children may lock themselves inside appliances and find themselves in a life-threatening situation.

- Do not position the appliance behind a door, as this may obstruct the appliance door or prevent it from opening completely.
- Once an appliance has reached the end of its life, pull the mains plug from the socket **before** severing the mains cable, and then destroy the lock on the appliance door.

**⚠ Warning**  
**Risk of suffocation!**

If allowed to play with the packaging/plastic film or packing components, children may become caught in these or pull them over their heads and suffocate.

Keep packaging, plastic film and packing components away from children.

**⚠ Warning**  
**Risk of poisoning!**

Detergents and care products may result in poisoning if consumed.

If accidentally swallowed, seek medical advice. Keep detergents and care products out of the reach of children.

**⚠ Warning**  
**Eye/skin irritation!**

Contact with detergents or care products may cause eye/skin irritation.

Rinse eyes/skin thoroughly if they/it come(s) into contact with detergents or care products. Keep detergents and care products out of the reach of children.

## Installation

### **Warning**

#### **Risk of electric shock/fire/ material damage/damage to the appliance!**

If the appliance is not installed properly, this may lead to a dangerous situation. Ensure the following:

- The mains voltage on your power socket must match the rated voltage specified on the appliance (identification plate). The connected loads and the required fuse protection are specified on the identification plate.
- The appliance must not be supplied through an external switching device, such as a timer, or connected to a circuit that is regularly switched on and off by a utility.
- The mains plug and the protective contact socket must match and the earthing system must be correctly installed.
- The installation must have an adequate cross section.

- The mains plug must be freely accessible at all times. If this is not possible, in order to comply with the relevant safety regulations, a switch (all pole disconnection) must be built into the permanent installation in accordance with electrical installation regulations.
- If using a residual current circuit breaker, only use one that bears the following mark: . The presence of this mark is the only way to be sure that it fulfils all the applicable regulations.

### **Warning**

#### **Risk of electric shock/fire/ material damage/damage to the appliance!**

If the appliance's mains cable is altered or damaged, this may result in electric shock, short circuiting or fire due to overheating.

The mains cable must not be kinked, crushed or altered, and must not come into contact with any heat sources.

**⚠ Warning****Risk of fire/material damage/  
damage to the appliance!**

The use of extension cords or power strips may result in fire due to overheating or short circuiting.

Connect the appliance directly to an earthed socket that has been correctly installed. Do not use extension cords, power strips or multi-way couplers.

**⚠ Warning****Risk of injury/material  
damage/damage to the  
appliance!**

- The appliance may vibrate or move when in operation, potentially resulting in injury or material damage.  
Place the appliance on a clean, even, solid surface and, using a spirit level to guide you, level it with the screw-in feet.

- Incorrectly placing (stacking) this appliance on top of a washing machine may result in injury, material damage and/or damage to the appliance.  
If this appliance is to be placed on top of a washing machine, the washing machine must be of at least the same depth and width as the appliance, and it must be secured in place with the appropriate connection set if available. → *Page 17*  
The appliance **MUST** be secured with this connection set. Stacking the appliance in any other way is forbidden.
- If you take hold of any of the appliance's protruding parts (e.g. the appliance door) in order to lift or move it, these parts may break off and cause injury.  
Do not take hold of any of the appliance's protruding parts in order to move the appliance.

**⚠ Warning**

**Risk of injury!**

- The appliance is very heavy. Lifting it may result in injury. Do not lift the appliance on your own.
- The appliance has sharp edges on which you could cut your hands. Do not take hold of the appliance by its sharp edges. Wear protective gloves to lift it.
- If the hoses and mains cables are not correctly routed, they may constitute a tripping hazard, which may result in injury. Route hoses and cables such that they do not constitute a tripping hazard.

**Operation**

**⚠ Warning**

**Risk of explosions/fire!**

Laundry that has come into contact with solvents, oil, wax, wax remover, paint, grease or stain remover may ignite when dried in the machine, or even cause the appliance to explode. Therefore please note:

- Rinse the laundry thoroughly with warm water and detergent before drying it in the machine.
- Do not place laundry in this appliance to be dried if the laundry has not been washed first.

- Do not use the appliance if industrial chemicals have been used to clean the laundry.

**⚠ Warning**

**Risk of explosions/fire!**

- If there is any residual material left in the fluff filter, this may ignite when drying is in progress, or even cause the appliance to catch fire or explode. Clean the fluff filter regularly.
- Certain objects may ignite when drying is in progress, or even cause the appliance to catch fire or explode. Remove any lighters or matches from pockets on items of clothing.
- If there is coal dust or flour in the air around the appliance, this may cause an explosion. Make sure that the area around the appliance is kept clean when it is in operation.

**⚠ Warning**

**Risk of fire/material damage/ damage to the appliance!**

The appliance contains R290, a refrigerant that is environmentally friendly but flammable. Keep open fire and ignition sources away from the appliance.





** Warning****Risk of fire/material damage/  
damage to the appliance!**

If a program is terminated before the drying cycle has finished, this prevents the laundry from cooling down sufficiently and may cause the laundry to ignite, or may result in material damage or damage to the appliance.

- During the last part of the drying cycle, the laundry in the drum is not heated (cooling cycle). This is to ensure that it remains at a temperature at which it will not be damaged.
- Do not switch off the appliance before the drying cycle has finished unless you remove all items of laundry from the drum immediately and spread them out (to dissipate the heat).

** Warning****Risk of poisoning/material  
damage!**

Condensation water is not suitable for drinking and may be contaminated with lint. Contaminated condensation water may be hazardous to health and may cause material damage.

Do not drink or reuse.

** Warning****Risk of poisoning!**

Poisonous fumes may be given off by cleaning agents that contain solvents, e.g. cleaning solvent.

Do not use cleaning agents that contain solvents.

## **Warning**

### **Risk of injury!**

- If you support your weight/sit on the appliance door when it is open, the appliance may tip over, which may result in injury.

Do not support your weight on the appliance door when it is open.

- If you climb onto the appliance, the worktop may break, which may result in injury.

Do not climb onto the appliance.

- If you reach into the drum while it is still rotating, you risk injuring your hands. Wait until the drum has stopped rotating.

### **Caution!**

#### **Material damage/damage to the appliance**

- If the amount of laundry in the appliance exceeds its maximum load capacity, it may not be able to operate properly, or this may result in material damage or damage to the appliance.

Do not exceed the maximum load capacity of dry laundry. Make sure you comply with the maximum load capacities specified for each of the programs. → *Page 23*

- If you operate the appliance without a fluff catcher (e.g. fluff filter, fluff depot, depending on appliance specifications), or if the fluff catcher is incomplete or defective, this may result in damage to the appliance. Do not operate the appliance without a fluff catcher, or with a fluff catcher that is incomplete or defective.
- Light objects such as hair and lint may be sucked into the air inlet when the appliance is in operation. Keep these away from the appliance.
- Foam and foam rubber may deform or melt if dried in the appliance. Do not dry laundry items that contain foam or foam rubber in the appliance.
- If you pour the wrong quantity of detergent or cleaning agent into the appliance, this may result in material damage or damage to the appliance. Use detergents/care products/cleaning agents and softeners in accordance with the manufacturers' instructions.

- If the appliance overheats, it may not be able to operate properly, or this may result in material damage or damage to the appliance. Make sure that the appliance's air inlet is never obstructed when the appliance is in operation, and that the area around the appliance is adequately ventilated.

## Cleaning/Maintenance

### **Warning** **Risk of death!**

The appliance is powered by electricity. There is a risk of electric shock if you come into contact with live components. Therefore please note:

- Switch off the appliance. Disconnect the appliance from the power supply (pull out the plug).
- Never take hold of the mains plug with wet hands.
- When removing the mains plug from the socket, always take hold of the plug itself and never the mains cable, otherwise this may damage the mains cable.
- Do not make any technical modifications to the appliance or its features.

- Repairs and any other work on the appliance must only be conducted by our customer service or by an electrician. The same applies for replacing the mains cable (when necessary).
- Spare mains cables can be ordered from our customer service.

### **Warning** **Risk of poisoning!**

Poisonous fumes may be given off by cleaning agents that contain solvents, e.g. cleaning solvent.

Do not use cleaning agents that contain solvents.

### **Warning** **Risk of electric shock/material damage/damage to the appliance!**

If moisture penetrates the appliance, this may cause it to short circuit.

Do not use a pressure washer, steam cleaner, hose or spray gun to clean your appliance.

## **Warning**

### **Risk of injury/material damage/damage to the appliance!**

The use of spare parts and accessories supplied by other brands is dangerous and may result in injury, material damage or damage to the appliance.

For safety reasons, use genuine spare parts and accessories only.

## **Caution!**

### **Material damage/damage to the appliance**

Cleaning agents and agents for pretreating laundry (e.g. stain removers, prewash sprays, etc.) may cause damage if they come into contact with the surfaces of the appliance. Therefore please note:

- Do not allow these agents to come into contact with the surfaces of the appliance.
- Clean the appliance with nothing but water and a soft, damp cloth.
- Remove any detergent, spray or other residues immediately.



## **Energy-saving tips**

- Spin the laundry before drying. The drier the laundry, the shorter the programme will be, in turn reducing energy consumption.
- Load the appliance with the maximum loads permitted for the programmes.

**Note:** If the maximum load is exceeded, this extends the programme duration and increases energy consumption.

- Operate the appliance in a ventilated room and make sure that the air inlet on the appliance is unobstructed so that air exchange can take place unhindered.
- Regularly remove the fluff from the appliance. If there is fluff in the appliance, this extends the programme duration and increases energy consumption.
- If you do not perform any actions on the appliance for an extended period before the programme starts or once the programme has ended, the appliance will automatically switch to energy-saving mode. The display and indicator lights go out after a few minutes and **Start/Reload** flashes. To end energy-saving mode, all you need to do is perform an action on the appliance, such as opening and closing the door.

## Installing and connecting the appliance

### Included with the appliance

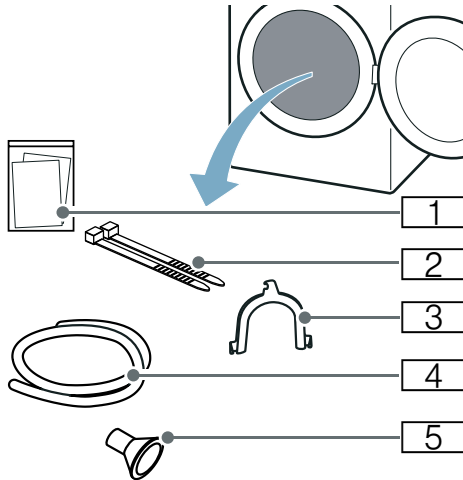

- 1 Accompanying documents (e.g. installation and operating instructions)
- 2 Fastening parts
- 3 U-piece for fixing the drain hose in place
- 4 Drain hose
- 5 Connection adapter

1. Remove any packaging and protective covers completely from the appliance.
2. Open the door.
3. Remove all the accessories from the drum.

You can now install and connect the appliance.

### **Caution!**

#### **Risk of material damage and damage to the appliance**

Objects remaining in the drum that are not designed for operation with the appliance may result in material damage and damage to the appliance. Remove these objects, along with all accessories, from the drum.

### Installing the appliance

#### **Warning** **Risk of death!**

Children may lock themselves inside appliances and find themselves in a life-threatening situation.

- Do not position the appliance behind a door, as this may obstruct the appliance door or prevent it from opening completely.
- Once an appliance has reached the end of its life, pull the mains plug from the socket **before** severing the mains cable, and then destroy the lock on the appliance door.

**en** Installing and connecting the appliance



### **Warning**

#### **Risk of explosions/fire!**

If there is coal dust or flour in the air around the appliance, this may cause an explosion.

Make sure that the area around the appliance is kept clean when it is in operation.



### **Warning**

#### **Risk of fire/material damage/damage to the appliance!**

The appliance contains R290, a refrigerant that is environmentally friendly but flammable.

Keep open fire and ignition sources away from the appliance.



### **Warning**

#### **Risk of injury/material damage/damage to the appliance!**

- The appliance may vibrate or move when in operation, potentially resulting in injury or material damage.

Place the appliance on a clean, even, solid surface and, using a spirit level to guide you, level it with the screw-in feet.

- Incorrectly placing (stacking) this appliance on top of a washing machine may result in injury, material damage and/or damage to the appliance.

If this appliance is to be placed on top of a washing machine, the washing machine must be of at least the same depth and width as the appliance, and it must be secured in place with the appropriate connection set if available.

→ *Page 17*

The appliance **MUST** be secured with this connection set. Stacking the appliance in any other way is forbidden.

- If you take hold of any of the appliance's protruding parts (e.g. the appliance door) in order to lift or move it, these parts may break off and cause injury.

Do not take hold of any of the appliance's protruding parts in order to move the appliance.



### **Warning**

#### **Risk of injury!**

- The appliance is very heavy. Lifting it may result in injury.  
Do not lift the appliance on your own.
- The appliance has sharp edges on which you could cut your hands.  
Do not take hold of the appliance by its sharp edges. Wear protective gloves to lift it.

### **Caution!**

#### **Material damage/damage to the appliance**

If the appliance overheats, it may not be able to operate properly, or this may result in material damage or damage to the appliance.

Make sure that the appliance's air inlet is never obstructed when the appliance is in operation, and that the area around the appliance is adequately ventilated.

### **Caution!**

#### **Risk of material damage and damage to the appliance**

The appliance underwent a function test before leaving the factory and therefore may contain residual water. This residual water may leak out if the appliance is tilted at an angle greater than 40°.

**Install the appliance as follows:**

1. Place the appliance on a clean, even, solid surface.
2. Check that the appliance is level using a spirit level.

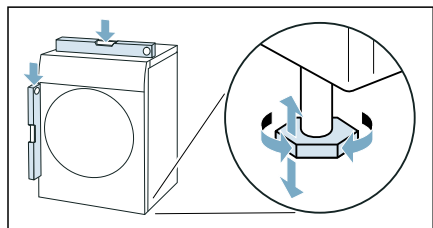

3. If necessary, turn the appliance feet to make sure it is level.

You can now connect the appliance.

**Notes**

- All appliance feet must stand firmly on the ground.
- If appliances are not aligned correctly, this may result in noises, vibrations, uneven drum operation and/or to residual water leaking out of the appliance.

**Connecting the appliance****⚠ Warning****Risk of electric shock/fire/material damage/damage to the appliance!**

If the appliance is not installed properly, this may lead to a dangerous situation. Ensure the following:

- The mains voltage on your power socket must match the rated voltage specified on the appliance (identification plate). The connected loads and the required fuse protection are specified on the identification plate.
- The appliance must not be supplied through an external switching device, such as a timer, or connected to a circuit that is regularly switched on and off by a utility.
- The mains plug and the protective contact socket must match and the earthing system must be correctly installed.
- The installation must have an adequate cross section.
- The mains plug must be freely accessible at all times. If this is not possible, in order to comply with the relevant safety regulations, a switch (all pole disconnection) must be built into the permanent installation in accordance with electrical installation regulations.
- If using a residual current circuit breaker, only use one that bears the following mark: . The presence of this mark is the only way to be sure that it fulfils all the applicable regulations.



**Warning**

**Risk of electric shock/fire/material damage/damage to the appliance!**

If the appliance's mains cable is altered or damaged, this may result in electric shock, short circuiting or fire due to overheating.

The mains cable must not be kinked, crushed or altered, and must not come into contact with any heat sources.



**Warning**

**Risk of fire/material damage/damage to the appliance!**

The use of extension cords or power strips may result in fire due to overheating or short circuiting. Connect the appliance directly to an earthed socket that has been correctly installed. Do not use extension cords, power strips or multi-way couplers.



**Warning**

**Risk of injury!**

If the hoses and mains cables are not correctly routed, they may constitute a tripping hazard, which may result in injury.

Route hoses and cables such that they do not constitute a tripping hazard.

**Connect the appliance as follows:**

1. Connecting the drain hose.

→ Page 36

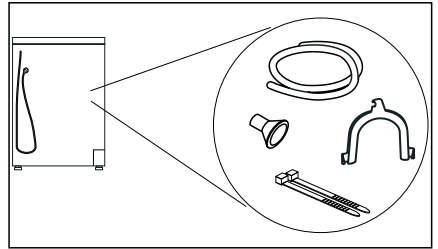

2. Plug the appliance's mains plug into the designated socket.
3. Check that the mains plug is in securely.

Your appliance is now ready to use.

**Caution!**

**Risk of material damage/damage to the appliance**

The appliance contains refrigerant and may be damaged if it is operated immediately after transportation. Allow the appliance to rest for two hours before initial use.

**Note:** If in doubt, have your appliance connected by a qualified professional.



## Before using the appliance for the first time

### Before you switch on the appliance:

Check that there is no visible damage to the appliance. Do not operate the appliance if it is damaged. Should you have any problems, please contact your specialist dealer or our customer service.

**Note:** Once the appliance has been properly installed and connected, it is ready to use. No further steps are necessary.

## Optional accessories

Order optional accessories\* from the after-sales service:







- **Basket for woollens:**  
Dry or air individual woollen items, sports shoes and soft toys in the basket for woollens.  
– Order number: **WMZ20600**.
- **Platform:**  
For easier loading and unloading, raise your dryer with a platform. You can transport laundry with the laundry basket integrated into the platform drawer.  
– Order number: -.
- **Washer-dryer stack connection kit:**  
To save space, the dryer can be placed on top of a suitable washing machine of the same width and depth.  
Only this connection kit may be used to secure the dryer to the washing machine.  
– Order number with pull-out worktop: **WTZ27400**  
– Order number without pull-out worktop: **WTZ27410**.

\* Depending on the appliance features

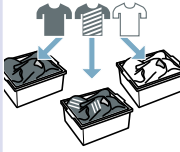
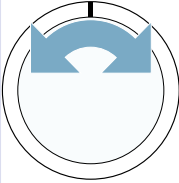
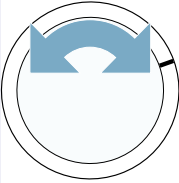

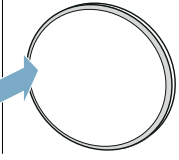
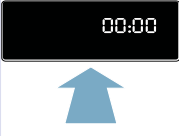
## Quick reference guide

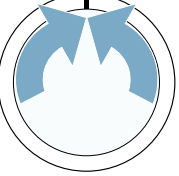
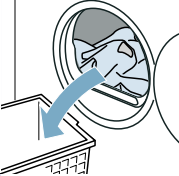
**Note:** The appliance must be correctly installed and connected. → Page 13

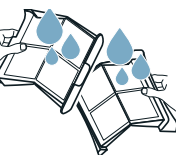
<b>1</b>	<b>Before the programme starts:</b>			
		Sort the laundry.	Switch on the appliance.	Select a programme.
<b>2</b>				
	Open the door and place the laundry in the drum.	Close the door.	If necessary: Adjust the programme settings.	Start the programme.
<b>3</b>	<b>Once the programme has ended:</b>			
		Switch off the appliance.	Open the door and remove the laundry.	Empty the condensation container.
<b>4</b>				
	Remove the fluff.			

## Familiarising yourself with your appliance

### Appliance overview

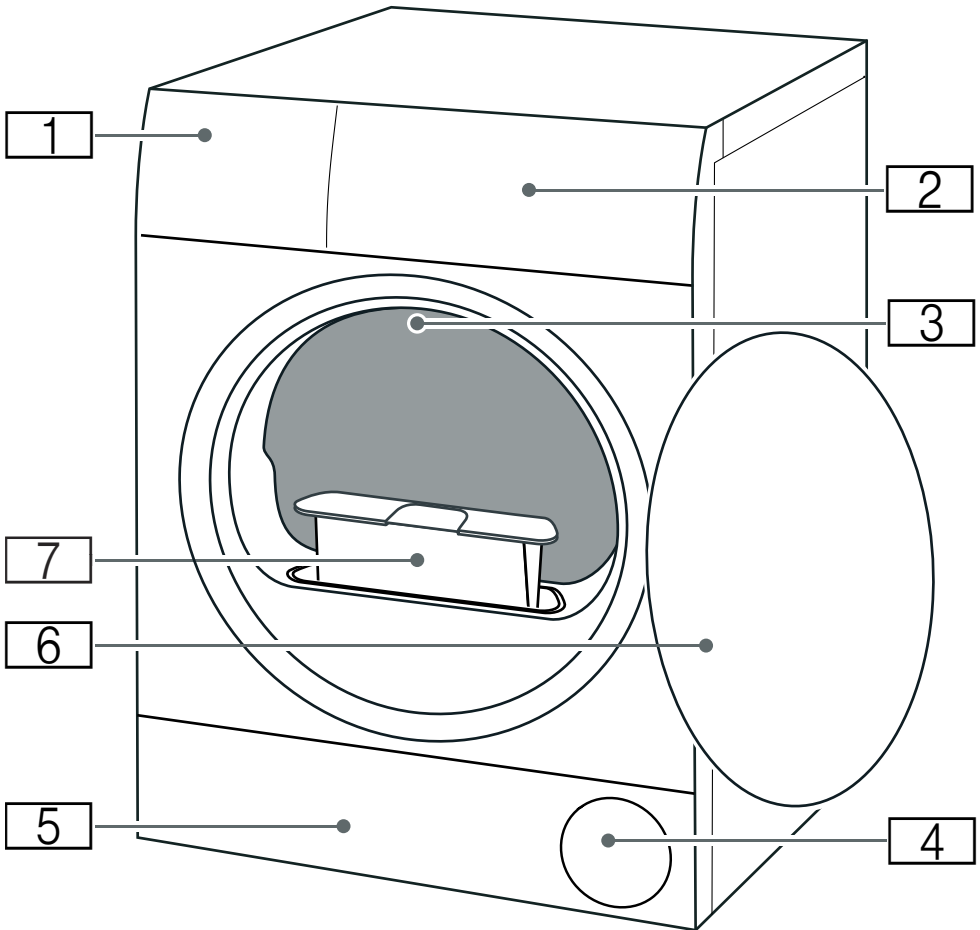

- 1** Condensation container
- 2** Control panel
- 3** Drum interior lighting (depending on the model)
- 4** Air inlet
- 5** Maintenance flap on the base unit
- 6** Door
- 7** Fluff filter

## Fascia

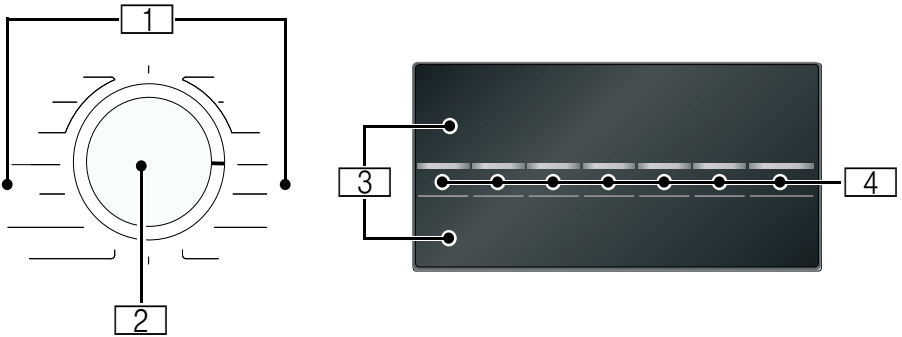

1

**Programmes**

2

**Programme selector**

- Switch the appliance on/off
- Set the programme/dryness level

3

**Display**

Displays settings and information

4







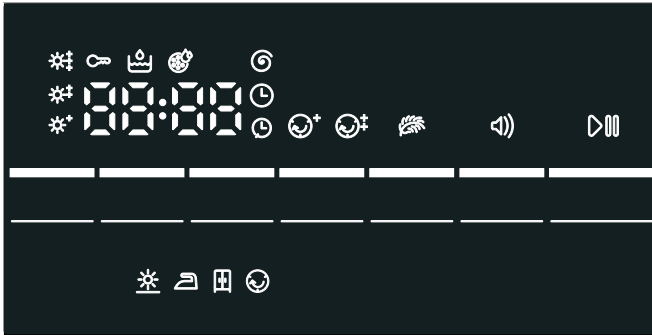

**Buttons**

for programme settings and additional functions/appliance settings



# Display









Indicator/ symbol	Description	Information
	<b>Programme status:</b>	<b>Lit:</b> Status indicator
	Drying	
	Iron Dry	
	Cupboard Dry	
	Anti-Crease	
	Pause	
<i>End</i>	End of programme	
<b>00:00</b>	Programme duration	Expected programme duration in hours and minutes.
e.g.  02:45	Programme delay	Appears when altering and activating the "Ready in" time
	Empty the condensation container → <i>Page 30</i>	<ul style="list-style-type: none"> <li>■ Empty the condensation container and then reinsert it. → <i>Page 30</i> Then press Start/Reload.</li> <li>■ If the optional drain hose* is installed, make sure that the drain hose: <ul style="list-style-type: none"> <li>- Is correctly connected. → <i>Page 36</i></li> <li>- Is not kinked or bent.</li> <li>- Is not blocked or clogged, e.g. by deposits.</li> </ul> </li> <li>■ Check that no debris has found its way into the base unit. Open the maintenance flap and remove any debris.</li> </ul>
	Fluff filter Base unit	Removing fluff → <i>Page 31</i> Cleaning the base unit → <i>Page 39</i>

<b>Hot</b>	CoolDown	<p>The appliance can reach high temperatures when drying. To cool the laundry, the CoolDown process reduces the temperature in the drum. If the door is not opened, the CoolDown process automatically starts after 30 seconds in the following cases:</p> <ul style="list-style-type: none"> <li>■ Pause the programme</li> <li>■ Cancel the programme</li> </ul> <p>You can continue to operate the appliance during the CoolDown process.</p> <p><b>Notes</b></p> <ul style="list-style-type: none"> <li>■ The drum continues to rotate during the CoolDown process, even if you have paused the programme.</li> <li>■ Do not change the programme during the CoolDown process.</li> <li>■ Temperature regulation can take up to 10 minutes.</li> </ul>
------------	----------	--



### Programme settings

For more information about the programme settings: → *Page 25*

Start/Reload	Start or pause/cancel the programme	<ul style="list-style-type: none"> <li>■ <b>Lit:</b> Programme started.</li> <li>■ <b>Flashing:</b> Programme paused.</li> </ul>
	Degree of dryness	Degree of dryness for a dryness level activated
		
		
	Anti-Crease	Anti-Crease 60 min activated
		Anti-Crease 120 min activated
	Timed programme	Timed programme activated
	Low-heat drying	Gentle drying for delicate fabrics activated

### Appliance settings

For more information about the appliance settings: → *Page 32*

	Childproof lock	<ul style="list-style-type: none"> <li>■ <b>Lights up:</b> The childproof lock is activated</li> <li>■ <b>Flashing:</b> The control panel cannot be used. Childproof lock is activated. → <i>Page 32</i></li> </ul>
	Notification signal	Notification signal at the end of programme activated
600 - 1800 	Spin speed (rpm)	Change the spin speed for the previously spun laundry

## Overview of programmes

Programme	Maximum load
<p><b>Programme name</b> Brief explanation of the programme and the items for which it is suitable.</p>	<p><b>Maximum load based on the dry weight of the items</b></p>
<p><b>Cotton</b> Hard-wearing items and heat-resistant items made of cotton or linen.</p>	<p><b>8 kg</b></p>
<p><b>Sportswear</b> Weatherproof and outdoor clothing with a membrane coating and water-repellent fabrics.</p>	<p><b>1.5 kg</b></p>
<p><b>Towels</b> Hard-wearing towels and dressing gowns made of cotton.</p>	<p><b>6 kg</b></p>
<p><b>Mixed Load</b> Mixed load consisting of items made from cotton and synthetic fabrics.</p>	<p><b>3 kg</b></p>
<p><b>Timed Programme Warm</b> Timed programme for all types of fabric except silk. Suitable for pre-dried or slightly damp laundry and for drying off multi-layered, thick laundry.</p> <p><b>Notes</b></p> <ul style="list-style-type: none"> <li>■ Dry woollens, sports shoes and soft toys only with the basket for woollens.</li> <li>■ In the timed programme, the laundry's remaining moisture is not automatically detected. If the laundry is still too damp when the drying programme has ended, repeat the programme and, if required, extend the programme duration. → "Programme settings" on page 25</li> </ul>	<p><b>3 kg</b> <b>Max. load for woollens/soft toys in the basket: 1 basket load</b> <b>Max. load for shoes in the basket: 1 pair</b></p>
<p><b>Timed Programme Cold</b> Timed programme for all types of fabric except for wool and silk. For freshening up or airing clothing that has hardly been worn.</p> <p><b>Note:</b> You can adjust the programme duration. → "Programme settings" on page 25</p>	<p><b>3 kg</b></p>
<p><b>Easy Care</b> Items made of synthetic or blended fabrics.</p>	<p><b>3.5 kg</b></p>
<p><b>Shirts</b> Shirts/blouses made of cotton, linen, or synthetic or blended fabrics.</p> <p><b>Note:</b> Once the laundry is dry, iron it or hang it up. This will allow the residual moisture to be distributed evenly.</p>	<p><b>1.5 kg</b></p>
<p><b>Super Quick 40'</b> Mixed load of synthetic fabrics and light cottons.</p>	<p><b>1 kg</b></p>

**Wool Finish**

**0.5 kg**

Machine-washable items made of wool or containing wool.

**Notes**

- Laundry becomes fluffier but not dry.
- Remove laundry once the programme has ended and allow to dry.





**Delicates**

**2 kg**

Delicate, washable items, e.g. made from satin, or synthetic or blended fabrics.



## **P+** Programme settings

Program setting	Function
<p><b>Note:</b> Not all settings can be activated in every programme. The activated settings are displayed on the programme selector (dryness level) or highlighted brightly in the display. You can change or deactivate the activated settings by turning the programme selector or pressing the relevant buttons repeatedly.</p>	
<b>Drying Target :</b>	<p>The dryness level defines how damp or dry the laundry is after the programme ends.</p> <p>Use the programme selector to select the dryness level that you require for the laundry you need to dry.</p>
<b>Cupboard Dry Plus</b>	Multi-layered, thick laundry that does not dry readily.
<b>Cupboard Dry</b>	Normal, single-layered laundry.
 <b>Iron Dry</b>	Normal, single-layered laundry that still needs to be damp after drying and is suitable for ironing or hanging up.
<b>Drying Level</b>	<p>If you think the laundry is still too damp when the drying programme has ended, you can adjust the degree of dryness to achieve a particular dryness level. To increase the dryness level, set the degree of dryness to between  and .</p> <p>This extends the programme duration but the temperature remains the same.</p> <p>Once you have adjusted the degree of dryness for a dryness level, this setting is retained even after the appliance is switched off.</p>
<b>Prog. Duration</b>	The drying time for <b>timed programmes</b> can be extended to up to three hours in 10-minute increments.
<b>Finished in</b>	<p><b>Before starting the programme,</b> you can delay the time at which the programme ends by up to 24 hours.</p> <p>The set time in hours, e.g. 8 h, is shown in the display and counts down until the programme starts. Once the programme has started, the programme duration is displayed.</p> <p><b>Note:</b> The programme duration is included in the "Ready in" time.</p>
<b>Reduced Ironing</b>	<p>The drum moves the laundry at regular intervals after drying to prevent creasing. You can activate or deactivate the automatic Anti-Crease function for 60 minutes () or for 120 minutes (.</p>
<b>Low Heat</b>	Reduced temperature for delicate fabrics, e.g. polyacrylic or elastane, may increase the drying time.



## Laundry

### Preparing laundry



#### Warning

#### Risk of explosions/fire!

Certain objects may ignite when drying is in progress, or even cause the appliance to catch fire or explode. Remove any lighters or matches from pockets on items of clothing.

#### Caution!

#### Risk of damage to the drum and laundry

Leaving objects in the pockets of your clothing can cause damage to the drum and laundry when the appliance is in operation. Remove all objects (e.g. metal items) from clothing pockets.

Prepare the laundry as follows:

- Tie cloth belts, apron strings, etc. together or use a laundry bag.
- Close zips, hooks, eyelets and buttons. Button up large items of laundry, such as covers.
- Always dry very small items of laundry, e.g. babies' socks, together with large items such as towels.
- Use timed programmes for single items.
- Knitted items, such as T-shirts and jerseys, often shrink slightly the first time they are tumble-dried. Use a gentle programme.

- Do not overdry easy-care laundry. This leads to increased creasing of your laundry.
- Some detergents and care products, e.g. starch or softeners, contain particles that may accumulate on the moisture sensor. This may impair the sensor's performance and, in turn, the drying result.

#### Notes

- When washing laundry to be tumble-dried, use the correct amount of detergent and care products as specified in the manufacturer's instructions.
- Clean the moisture sensor regularly → Page 39.

### Sorting laundry

**Note:** Load the laundry item by item into the appliance. For more effective drying, do not stuff an entire bundle of laundry into the dryer at once.

#### Caution!

#### Risk of material damage to the dryer or laundry

Laundry that is unsuitable for tumble-drying may damage the appliance and the laundry when it is dried. Before you dry it, sort the laundry according to the information given on the care label:

- Suitable for tumble drying
- Dry at normal temperature
- Dry at low temperature
- Do not tumble-dry

When sorting the laundry to be dried, take the following points into account:

- To achieve an even drying result, only dry laundry of the same type of fabric and texture together. If you dry thin, thick and multi-layered fabrics together, they will dry to differing degrees.
- Use the fabric descriptions given for the individual drying programmes to help you choose the most appropriate programme.  
→ "Overview of programmes" on page 23

**Note:** You can select a timed programme to add extra drying time for laundry that is still damp.

**Caution!**  
**Risk of material damage to the appliance and laundry**

Do **not** tumble-dry the following items or fabrics in the appliance:

- Laundry contaminated with solvents, wax or grease.
- Unwashed items.
- Items made from non-breathable fabrics (e.g. rubber-coated).
- Items made from delicate fabrics, such as silk and curtains made of synthetic material.

## Operating the appliance

### Loading laundry and switching on the appliance

**Note:** The appliance must be correctly installed and connected. → Page 13

1. Prepare and sort the laundry.
2. Turn the programme selector to switch on the appliance.

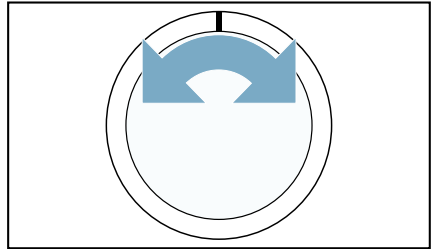

3. Open the door. Check that the drum has been completely emptied. Empty it if necessary.

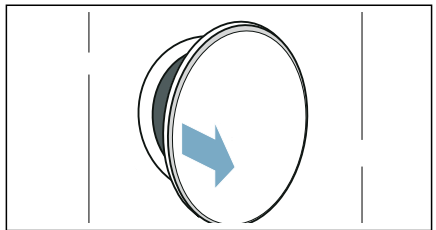

4. Load the laundry unfolded into the drum.

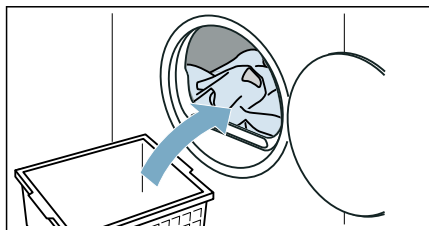

5. Close the appliance door.

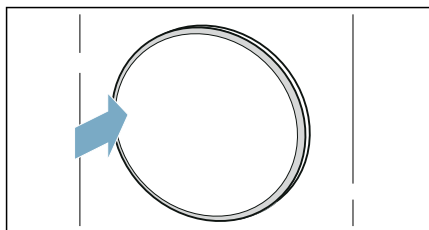

### Caution!

#### Risk of material damage to the appliance or laundry.

Make sure that laundry is not trapped in the door.

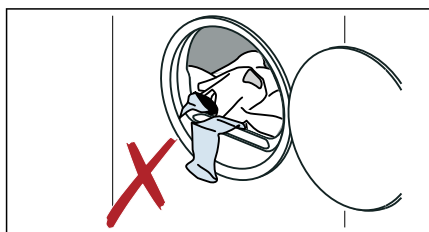

**Note:** The appliance's drum is lit up after the door is opened and closed and once the programme has started. The drum's interior light goes out on its own.

## Setting a programme

**Note:** If you have activated the childproof lock, you must deactivate it before you can set a programme.  
→ Page 32

1. Set the programme you require.

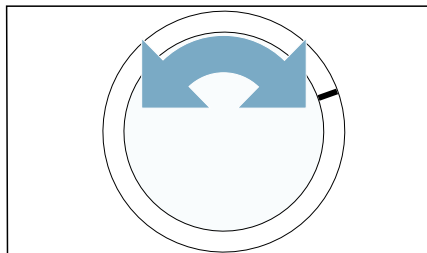

2. Adjust the programme settings, if required.  
→ "Programme settings" on page 25

## Starting the programme

Press **Start/Reload** .

**Note:** If you want to prevent the programme from being adjusted inadvertently, activate the childproof lock. → Page 32

## Programme progress

The programme status will be indicated on the display.

**Note:** When a programme is selected, the expected drying time for the maximum permitted load is displayed. The moisture sensor measures the residual moisture in the laundry as it is being dried. The programme duration and the remaining time indicated on the display are automatically adjusted as the programme progresses, depending on how damp the laundry is (exception: Timed programmes).

## Changing the programme or adding more laundry

You can remove or add laundry and change or adjust the programme at any time during drying.

1. Open the door or press **Start/Reload** to pause the programme.  
**Note:** The drum will continue to rotate when the CoolDown process is in progress, even if you have paused the programme. You can stop the CoolDown process at any time by opening the door.
2. Add or remove laundry.
3. If required, select a different programme or a different programme setting. → *"Overview of programmes" on page 23* → *"Programme settings" on page 25*  
**Note:** Do not change the programme during the CoolDown process.
4. Close the appliance door.
5. Press **Start/Reload**.

**Note:** The programme duration is updated on the display, depending on the load and on the residual moisture in the laundry. The values displayed may change when the programme or load is changed.

## Cancelling the programme

The programme can be cancelled at any time by opening the door or pressing **Start/Reload**.

### Caution!

#### Risk of fire. Laundry may catch fire.

If you cancel the programme, remove all items of laundry from the dryer and spread them out to allow the heat to dissipate.

## End of programme

The following message appears in the display: *End*

## Removing laundry and switching off the appliance

1. Remove the laundry.

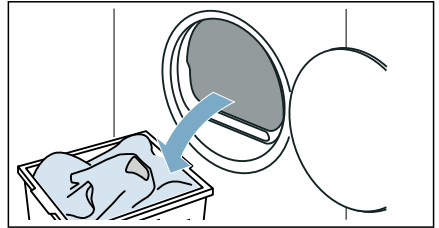

2. Turn the programme selector to switch off the appliance.

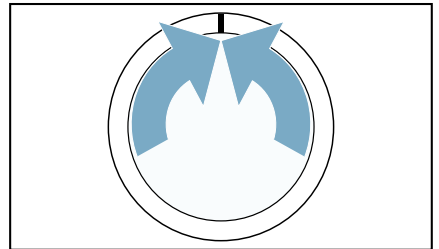

## Emptying the condensation container

By default, the condensation from the appliance runs into the condensation container.

Alternatively, you have the option of discharging the condensation water\* supplied depending on the model. If you choose to discharge the condensation water into the waste-water system, you will not need to empty the condensation container during the drying programme or after each time you use the dryer.

1. Pull out the condensation container horizontally.

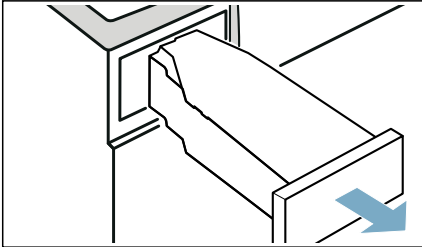

2. Pour out the condensation water.

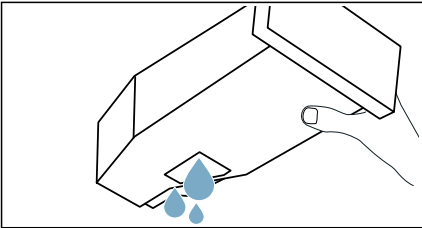

### Caution!

#### Risk of harm to health and material damage

Condensation water is not suitable for drinking and may be contaminated with fluff. Contaminated condensation water may be harmful to your health and cause material damage. Do not drink the condensation water or reuse it.

\* into the waste-water system via a drain hose

3. Push the condensation container back into the appliance until you feel it lock into place.

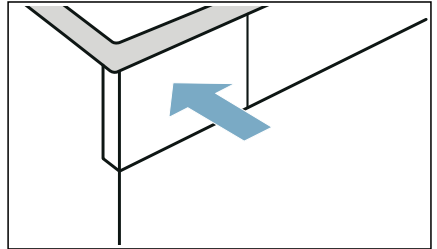

## Removing the fluff

**Note:** During drying, fluff and hair from the laundry is trapped by the fluff filter. If the fluff filter is clogged or dirty, this reduces the flow of air, preventing the appliance from achieving optimal drying results. Dirty fluff filters increase the power consumption and increase the required drying time.

### Clean the fluff filter after each drying cycle:

1. Open the door and remove all fluff from it.
2. Pull out the two-part fluff filter.

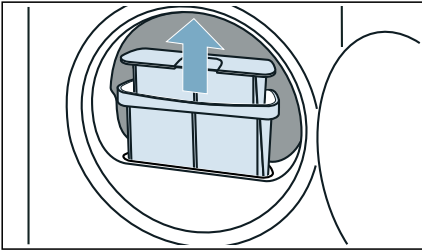

3. Remove the fluff from the fluff filter recess. Ensure that no fluff falls into the open shaft.

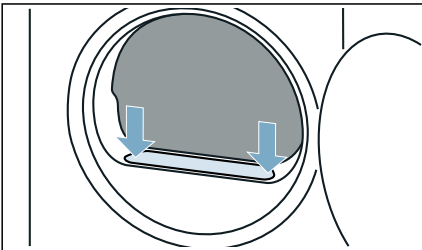

4. Pull the two-part fluff filter apart.

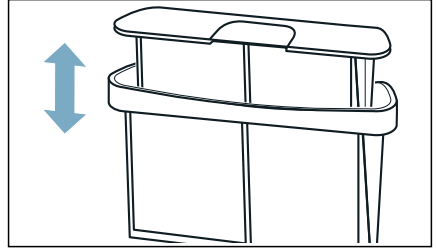

5. Open the two parts of the filter.

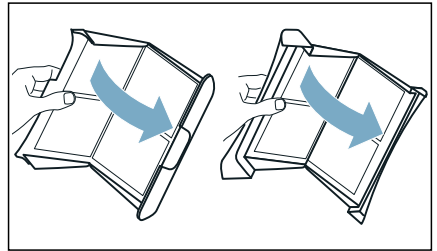

6. Remove all fluff from both parts of the filter.

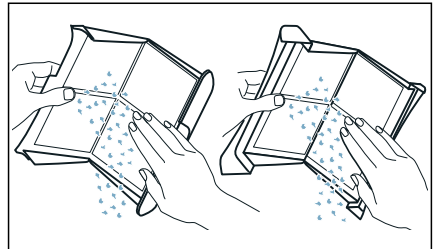

7. Rinse off fluff under warm, running water.

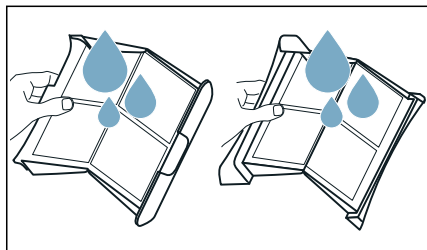

8. Dry the two parts of the fluff filter, snap them shut and reinsert the filter.

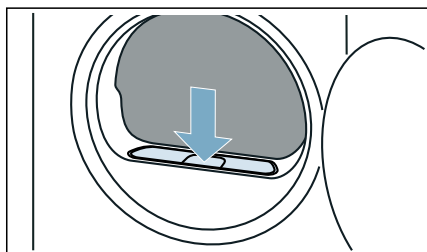

**Caution!**  
**Material damage/damage to the appliance**

If you operate the appliance without a fluff catcher (e.g. fluff filter, fluff depot, depending on appliance specifications), or if the fluff catcher is incomplete or defective, this may result in damage to the appliance.

Do not operate the appliance without a fluff catcher, or with a fluff catcher that is incomplete or defective.

---

 **Appliance settings**

You can activate/deactivate or change the appliance settings directly.

### Childproof lock

You can activate or deactivate the appliance's childproof lock. You can activate the childproof lock to prevent the control panel from accidentally being operated.

#### Activate/deactivate the appliance setting as follows:

Press and hold **Prog. Duration** and **Finished in** at the same time for approx. three seconds.

☞ is shown/hidden in the display.

The childproof lock is activated/deactivated.

#### Notes

- You can activate the childproof lock at any time after you switch on the appliance.
- The childproof lock remains active even after the appliance has been switched off. In order to operate the control panel when you turn on the appliance, you need to deactivate the childproof lock.



## Notification signal

You can activate or deactivate the notification signal at the end of the programme. If you activate this setting, an audible signal will sound once the programme has ended.

### Activate/deactivate the appliance setting as follows:

Press **Signal** .

🔊) is shown/hidden in the display.

The notification signal at the end of programme is activated/deactivated.

**Note:** If a signal does not sound when the programme ends even though the notification signal is activated, you can change the appliance setting.

→ Page 34

## Altering the appliance settings

You can call up and change the following appliance settings:

- Volume of the audible notification signals (e.g. at the end of a programme)
- Volume of the audible operating signals
- Spin speed used for spinning the laundry before drying

### Call up and change the appliance settings as follows:

1. Set the programme to position 1.

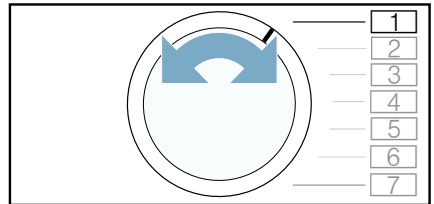

2. Press and hold **Start/Reload** . At the same time:
3. Set the programme to position 2.

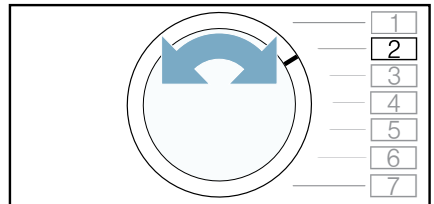

4. Release **Start/Reload** .

You can now alter the appliance settings.

### Adjusting the volume of the audible notification signals

You can adjust the volume of the notification signal emitted at the end of the programme.

**Adjust the appliance setting as follows:**

1. Set the programme to position 3.

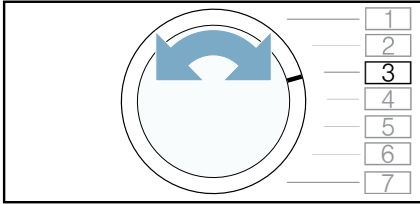

The current setting will appear on the display.

2. Press **Prog. Duration** or **Finished in** until the required setting appears on the display.

#### Settings:

- 0 Off
- 1 Low
- 2 Medium
- 3 High
- 4 Very high

3. Alter any additional appliance settings you require or save and exit the appliance settings.

### Adjusting the volume of the audible operating signals

You can adjust the volume of the buttons for operating the appliance.

**Adjust the appliance setting as follows:**

1. Set the programme to position 4.

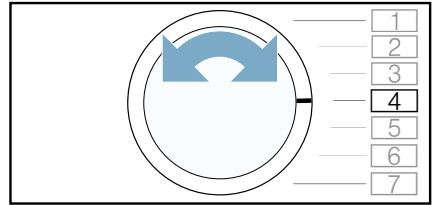

The current setting will appear on the display.

2. Press **Prog. Duration** or **Finished in** until the required setting appears on the display.

#### Settings:

- 0 Off
- 1 Low
- 2 Medium
- 3 High
- 4 Very high

3. Alter any additional appliance settings you require or save and exit the appliance settings.

## Changing the spin speed

If you have spun the laundry before drying it, you can set this spin speed on the appliance. The drying time is increased or decreased in accordance with the set spin speed.

**Note:** The set spin speed does not change the drying time for the time programme.

### Adjust the appliance setting as follows:

1. Set the programme to position 2.

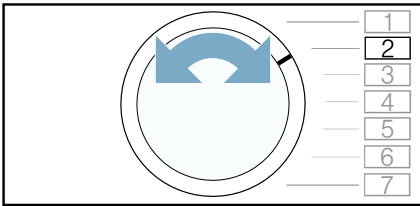

The current setting will appear on the display.

2. Press **Prog. Duration** or **Finished in** until the required setting appears on the display.

### Settings:

600 Ⓞ Low  
↓  
1800 Ⓞ High

3. Alter any additional appliance settings you require or save and exit the appliance settings.

## Saving and exiting the appliance settings

### Save and exit the appliance settings as follows:

1. Turn the programme selector to switch off the appliance.

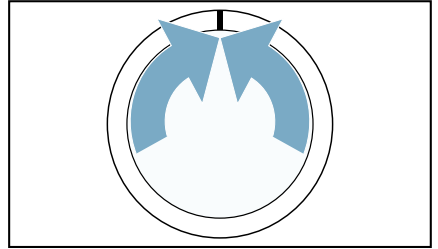

2. Wait 5 seconds.

**Note:** The selected settings are retained even after the appliance has been switched off.



## Draining the condensation water

Condensation will form in the appliance as it dries the laundry.

You must ensure that the drain hose is connected when you operate the appliance.

If there is no drain hose connected to the appliance, the condensation water from the appliance will run into the condensation container. In this case, you will need to empty the condensation container each time the dryer finishes drying the laundry, and also if it becomes full before drying is complete.

### Connect the drain hose as follows:

1. Remove any accessories from the drum.

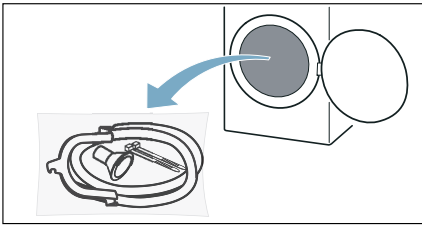

2. Remove all items from the bag.

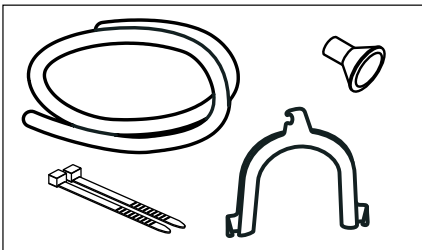

3. Detach the condensation hose from the connector.

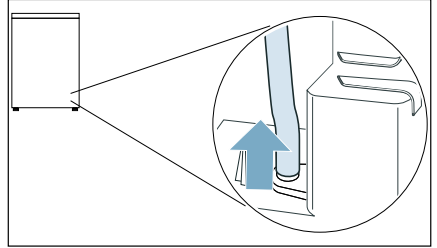

**Note:** The appliance comes delivered with the condensation hose already fitted to the connector.

4. Place the condensation hose in the "parked" position.

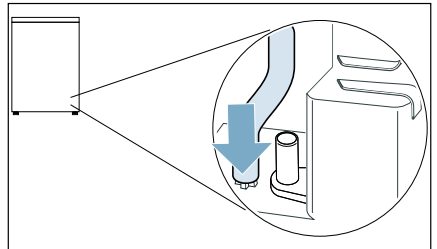

5. Take the drain hose from the accessories and push it fully onto the free connector.

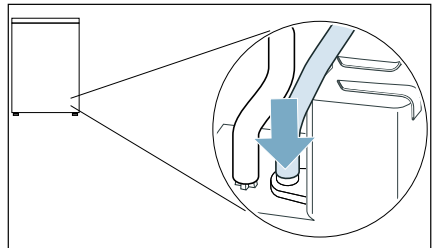

- Push the drain hose into the appliance's hose guide.

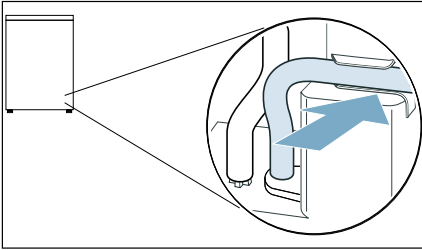

**Note:** Take care not to kink the drain hose when doing this.

- Secure the other side of the drain hose using the remaining accessories, depending on the connection situation.

**Washbasin:**

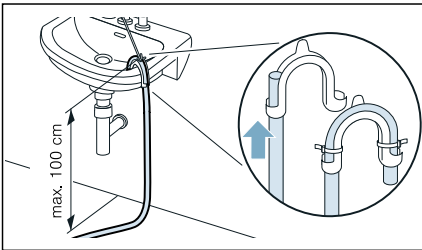

**Siphon:**

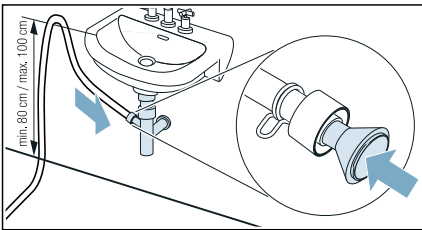

The connection point must be secured using a hose clamp (12-22 mm clamping range, available from specialist retailers). When connecting to a siphon, make sure that the drain hose is routed at a height of at least 80 cm, but no more than 100 cm.

**Floor drain:**

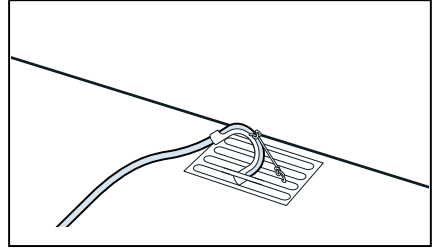

**Caution!**

**Risk of material damage due to leaks or draining water.**

Secure the drain hose to prevent it from slipping out. Do not kink or bend the drain hose. The height difference between the surface on which the appliance is installed and the drain hose must be no more than 100 cm.

**Caution!**

**Risk of accumulated water being drawn back into the appliance and causing material damage.**

Check that the water drains away quickly. The drain must not be sealed or blocked.

The condensation water is now discharged via the drain hose into the waste-water system or into a washbasin.

**Note:** If you want to drain the condensation water back into the condensation container, reverse these steps.

**Caution!**

**Risk of material damage/damage to the appliance**

If you are draining condensation water into the condensation container, liquid may leak out of the socket and cause material damage. Before operating the appliance, make sure that the condensation hose is secured to the socket.



## Cleaning and maintenance

### Cleaning the appliance



#### **Warning** **Risk of death!**

The appliance is powered by electricity. There is a risk of electric shock if you come into contact with live components. Therefore please note:

- Switch off the appliance. Disconnect the appliance from the power supply (pull out the plug).
- Never take hold of the mains plug with wet hands.
- When removing the mains plug from the socket, always take hold of the plug itself and never the mains cable, otherwise this may damage the mains cable.
- Do not make any technical modifications to the appliance or its features.
- Repairs and any other work on the appliance must only be conducted by our customer service or by an electrician. The same applies for replacing the mains cable (when necessary).
- Spare mains cables can be ordered from our customer service.



#### **Warning** **Risk of poisoning!**

Poisonous fumes may be given off by cleaning agents that contain solvents, e.g. cleaning solvent. Do not use cleaning agents that contain solvents.



#### **Warning** **Risk of electric shock/material damage/damage to the appliance!**

If moisture penetrates the appliance, this may cause it to short circuit. Do not use a pressure washer, steam cleaner, hose or spray gun to clean your appliance.

#### **Caution!** **Material damage/damage to the appliance**

Cleaning agents and agents for pretreating laundry (e.g. stain removers, prewash sprays, etc.) may cause damage if they come into contact with the surfaces of the appliance. Therefore please note:

- Do not allow these agents to come into contact with the surfaces of the appliance.
- Clean the appliance with nothing but water and a soft, damp cloth.
- Remove any detergent, spray or other residues immediately.

## Cleaning the moisture sensor

**Note:** The moisture sensor measures the amount of moisture in the laundry. After long periods of usage, the moisture sensor may become covered by a fine layer of limescale or detergent and care product residue. These deposits must be removed regularly, otherwise the drying results may not be optimal.

1. Open the door.

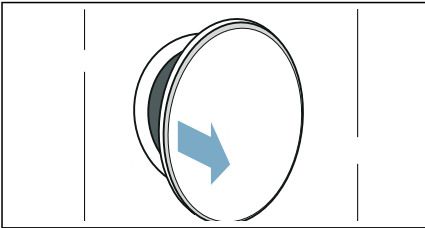

2. Clean the moisture sensor with a rough sponge.

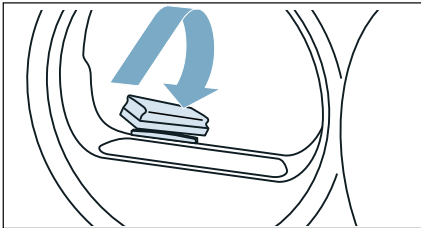

**Caution!**  
**Risk of damaging the moisture sensor.**

The moisture sensor is made from stainless steel. Do not clean the sensor with abrasive cleaning products or wire wool.

## Cleaning the base unit

Fluff and hair from the laundry collect in the base unit during drying. Clean the appliance's base unit if the following message appears in the display: ☹.

You can also clean the appliance's base unit even if this message does not appear in the display, e.g. if there is visible soiling.

**⚠ Warning**  
**Risk of injury!**

You could cut your hands on the sharp fins on the heat exchanger. Do not touch the fins on the heat exchanger with your hands.

**Note:** Allow the appliance to cool down for approximately 30 minutes after use before commencing cleaning.

**Clean the base unit as follows:**

1. Clean the fluff filter. → *Page 31*
2. Open the maintenance flap by the handle.

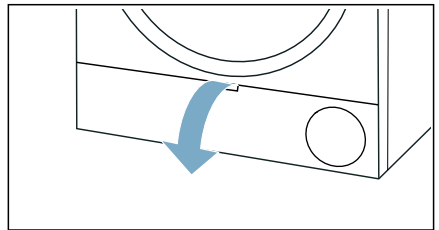

3. Unlock the levers on the heat exchanger cover.

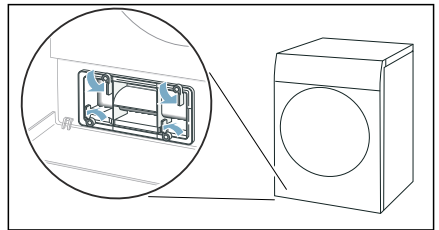

4. Pull the heat exchanger cover out by its grip.

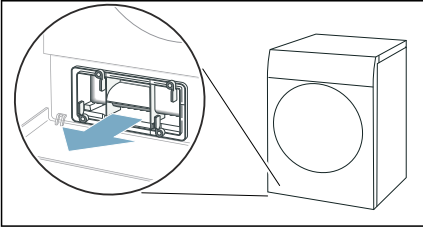

5. Carefully remove the filter mat from the heat exchanger cover.

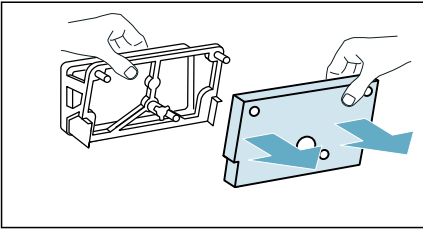

**Note:** Take care not to damage the filter mat when doing this.

6. Use a soft brush to clean the heat exchanger cover.

**Note:** Make sure that no dirt or debris is left on the seal.

7. Rinse the filter mat under running water and squeeze out the water with your hand.

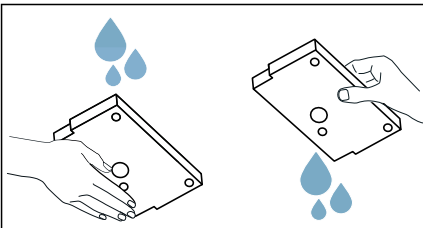

### Notes

- If there are heavy deposits, you can clean the filter mat carefully with a vacuum cleaner.
- Only clean with clear water; do not use cleaning products.

8. Position the filter mat fully on the retainers in the heat exchanger cover.

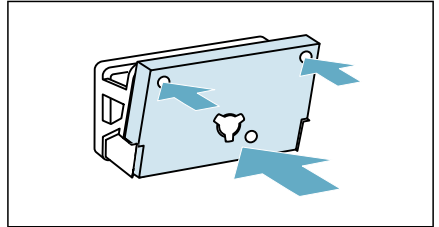

### Notes

- Ensure that the filter mat is clean and dry, and positioned on the retainers as shown.
  - The filter mat must not be put back if misshapen, damaged or reversed.
  - You can order a new filter mat from our after-sale services using the spare part number: **12022801**. Contact information for all countries can be found in the enclosed after-sales service directory.
9. If there is visible soiling, carry out the following steps (**optional**):
- a) Lift the middle tab on the insert slightly.

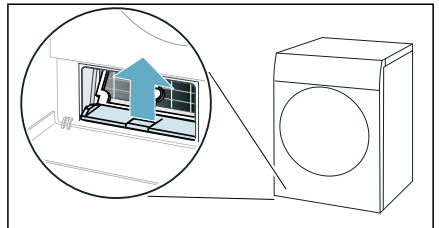



b) Pull the insert out horizontally.

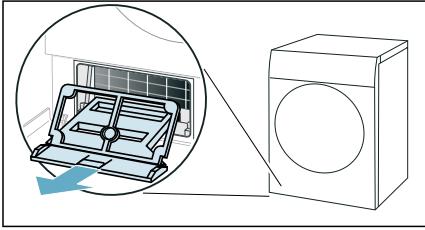

c) Rinse the insert under running water and dry it off.

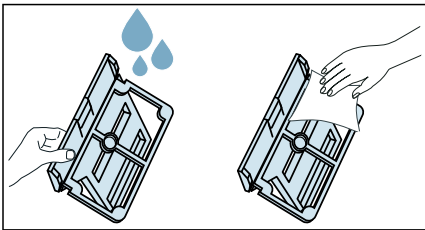

d) Clean the opening in the appliance with a soft, damp cloth.

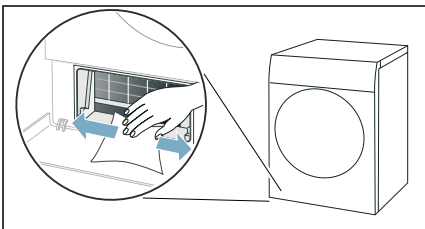

**Note:** Take care not to damage the heat exchanger, as it is exposed.

e) Carefully clean the fins on the heat exchanger with a vacuum cleaner and brush attachment.

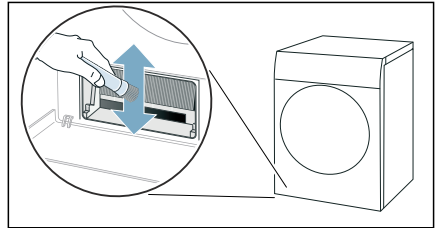

**Note:** Always clean the fins on the heat exchanger from top to bottom, taking care not to bend or damage them.

f) Push the insert in horizontally until you hear the tab click into place.

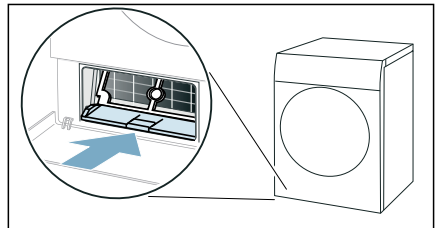

**10.** Slide the heat exchanger cover in by its grip.

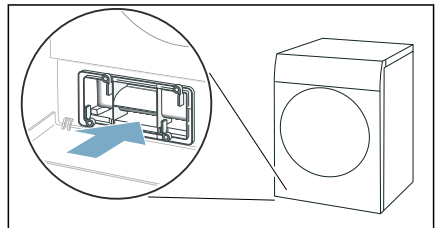

**Note:** You can only slide the heat exchanger cover in if the insert is in the appliance.

**en** Cleaning and maintenance

- 11.** Lock the levers on the heat exchanger cover.

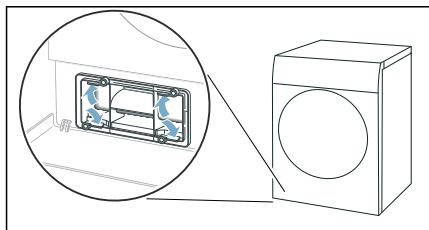

- 12.** Close the maintenance flap.

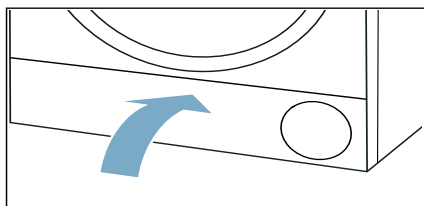

You have now finished cleaning the appliance's base unit.

## Help with the appliance

Faults	Cause/Remedy
Appliance does not start.	Check the mains plug and the fuses.
Creasing.	<ul style="list-style-type: none"> <li>■ Load exceeded or incorrect programme selected for a type of fabric. All the required information can be found in the programme table. → <i>Page 23</i></li> <li>■ Remove laundry from the drum as soon as the drying programme has finished. Creasing occurs when clothing is left in the drum.</li> </ul>
Water is leaking out.	<ul style="list-style-type: none"> <li>■ The appliance may be positioned at an angle. Level the appliance.</li> <li>■ In the base unit, make sure that:               <ul style="list-style-type: none"> <li>– The heat exchanger cover is properly locked.</li> <li>– There is no dirt or debris on the heat exchanger cover's seal.</li> </ul>               → <i>Page 39</i> </li> <li>■ If the optional drain hose* is installed, make sure that the drain hose is correctly connected. → <i>Page 36</i></li> </ul>
The appliance is paused but the drum is turning.	The appliance has detected a high temperature and has started the CoolDown process. Temperature regulation can take up to 10 minutes. You can cancel the CoolDown process at any time by opening the door.
The programme does not start	<p>Make sure that:</p> <ul style="list-style-type: none"> <li>■ The door is closed</li> <li>■ The  3 sec. (child lock 3 sec.) has been deactivated</li> <li>■ You have pressed Start/Reload</li> </ul> <p><b>Note:</b> If the programme has been delayed by setting <b>Finished in</b> , the programme starts at a later point.</p>
Programme duration displayed changes as drying progresses.	Not a fault. The moisture sensor measures the residual moisture in the laundry and adjusts the programme duration (with the exception of timed programmes).
Laundry is not dried properly or is still too damp.	<ul style="list-style-type: none"> <li>■ After the programme has ended, warm laundry feels damper than it actually is. Spread out the laundry and let it cool down.</li> <li>■ Adjust the drying time or increase the degree of dryness. This will extend the drying time but the temperature will remain the same.</li> <li>■ Select a timed programme to add extra drying time for laundry that is still damp.</li> <li>■ Select a timed programme for a small load.</li> <li>■ Do not exceed the maximum load for a programme. → <i>Page 23</i></li> <li>■ Clean the moisture sensor in the drum. The sensor may become covered in a fine layer of limescale or detergent and care product residue, which then impairs its performance. → <i>Page 39</i></li> <li>■ Drying has been interrupted as a result of a power cut, because the condensation container is full or because the maximum drying time has been exceeded.</li> </ul> <p><b>Note:</b> See also the laundry tips. → <i>Page 26</i></p>

Humidity in the room is increasing.	Make sure the room is sufficiently ventilated.
Unusual noises when drying.	When drying is in progress, the pump and compressor generate noise when operating normally. This does not indicate that the appliance is malfunctioning.
The appliance feels cold despite drying.	Not a fault. The appliance can dry effectively at low temperatures using a heat pump.
Drying programme is stopped.	If the drying programme is stopped due to a power failure, restart the programme or remove the laundry and spread it out.
Drying is taking too long.	<ul style="list-style-type: none"><li>■ The appliance may have fluff in it. This will increase the required drying time.<ul style="list-style-type: none"><li>- Remove the fluff. → <i>Page 31</i></li><li>- Clean the base unit. → <i>Page 39</i></li></ul></li><li>■ The heat exchanger may have fluff in it. If you can see fluff in the exposed heat exchanger, clean it carefully using a vacuum cleaner. → <i>Page 39</i></li><li>■ If the air inlet on the appliance is blocked or not fully open, this may increase the drying time. Make sure that the air inlet remains unobstructed.</li><li>■ If the ambient temperature is lower than 15 °C or higher than 30 °C, this may increase the drying time.</li><li>■ Inadequate air circulation in the room may increase the drying time. Make sure the room is adequately ventilated.</li></ul>

\* Depending on how the appliance is equipped or the available accessory

**Note:** If you cannot rectify the fault yourself by turning the appliance off and then on again, please contact our after-sales service. → *Page 48*



## Transporting the appliance

### Warning

#### **Risk of injury/material damage/damage to the appliance!**

If you take hold of any of the appliance's protruding parts (e.g. the appliance door) in order to lift or move it, these parts may break off and cause injury. Do not take hold of any of the appliance's protruding parts in order to move the appliance.

### Warning

#### **Risk of injury!**

- The appliance is very heavy. Lifting it may result in injury. Do not lift the appliance on your own.
- The appliance has sharp edges on which you could cut your hands. Do not take hold of the appliance by its sharp edges. Wear protective gloves to lift it.

#### **Prepare the appliance for transportation as follows:**

1. Pull out the condensation container horizontally and empty it.

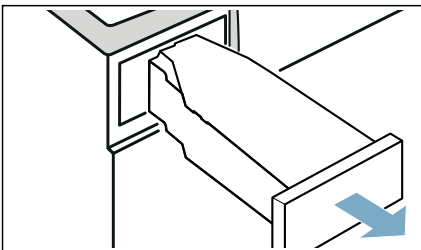

2. Push the condensation container back into the appliance until you feel it lock into place.

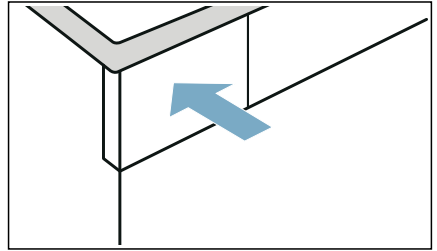

3. Switch on the appliance.
4. Set any programme.
5. Press **Start/Reload**.
6. Wait for 5 minutes. The condensation water will be drained.
7. Empty the condensation container again.
8. If installed, remove the drain hose from the washbasin, siphon or floor drain. → Page 36

#### **Caution!**

Secure the drain hose to the appliance to prevent it from slipping out. Do not kink the drain hose.

9. Switch off the appliance.
10. Disconnect the appliance's mains plug from the power supply.

The appliance is now ready to be transported.

#### **Caution!**

#### **Risk of material damage/damage to the appliance**

Despite draining, there will always be some residual water in the appliance. Any residual water may leak out and cause material damage.

The appliance should therefore be transported upright.

## Consumption values

### Consumption values table

Programme	Spin speed used for spinning the laundry (in rpm)	Duration** (in min)		Energy consumption** (in kWh)	
		8 kg	4 kg	8 kg	4 kg
<b>Cotton</b>		<b>8 kg</b>	<b>4 kg</b>	<b>8 kg</b>	<b>4 kg</b>
Cupboard Dry *	1400	177	111	1.62	1.00
	1000	200	125	1.86	1.13
	800	223	139	2.10	1.26
Iron Dry *	1400	135	78	1.22	0.70
	1000	158	92	1.46	0.83
	800	181	106	1.70	0.96
<b>Easy Care</b>		<b>3.5 kg</b>		<b>3.5 kg</b>	
Cupboard Dry *	800	67		0.57	
	600	78		0.67	

\* Programme setting for testing in accordance with the applicable EN 61121 standard.

\*\* The values may differ from those specified, depending on the type of fabric, composition of laundry to be dried, residual moisture in the laundry, the degree of dryness that has been set, the amount of laundry being loaded, the environmental conditions, and any additional functions that have been activated.

### Most efficient programme for cotton laundry

The "standard cottons programme" below (denoted by the ◻ symbol) is suitable for drying cotton laundry with a normal dampness level, and is the most efficient programme for drying damp cotton laundry in terms of combined energy consumption.

Standard programmes for cottons in accordance with current EU regulation 932/2012			
Programme + dryness level	Load (in kg)	Energy consumption (in kWh)	Programme duration (in min)
Cotton + ◻ Cupboard Dry	8/4	1.86/1.13	200/125

Programme setting for testing and energy labelling in accordance with Directive 2010/30/EU.



## Technical data

**Dimensions:**

850 x 600 x 640 mm  
(height x width x depth)

**Weight:**

56 kg (depending on the model)

**Mains connection:**

Mains voltage 220 - 240 V, 50 Hz

Nominal current 10 A

Nominal power 600 W

**Maximum load:**

8 kg

**Power consumption when switched off:**

0.10 W

**Power consumption when left on:**

0.75 W

**Drum interior light\*****Ambient temperature:**

5 - 35 °C



## Disposal



Dispose of packaging and the appliance in an environmentally responsible manner.

This appliance is labelled in accordance with the European Directive 2012/19/EU, which governs waste electrical and electronic equipment (WEEE). The directive provides a framework for the collection and recycling of old appliances, which is valid across the EU.

**Caution!****Risk of fire/risk of poisoning/risk of material damage and damage to the appliance**

The appliance contains R290, a refrigerant that is environmentally friendly but flammable. If it is not disposed of correctly, this may result in fire or poisoning.

Dispose of the appliance correctly and do not damage the pipes in the refrigerant circuit.

\* Depending on the appliance features



## Customer Service

If you cannot rectify the error yourself by turning the appliance off and then on again, please contact our after-sales service. → Enclosed after-sales service directory or cover page

We will always find an appropriate solution and, where possible, prevent the need for an engineer to visit.

Please provide the after-sales service with the product number (E no.) and the production number (FD) of the appliance.

E-Nr. _____	FD _____
-------------	----------

E no.      Product number  
FD        Production number

You can find this information,  
\*depending on the model:

On the inside of the door\*/open service flap\* and at the rear of the appliance.

**You can trust in the manufacturer's expertise.**

Contact us. This ensures that the repair is carried out by trained service engineers with genuine spare parts.











## Thank you for buying a Bosch Home Appliance!

Register your new device on MyBosch now and profit directly from:

- **Expert tips & tricks for your appliance**
- **Warranty extension options**
- **Discounts for accessories & spare-parts**
- **Digital manual and all appliance data at hand**
- **Easy access to Bosch Home Appliances Service**

Free and easy registration – also on mobile phones:

[www.bosch-home.com/welcome](http://www.bosch-home.com/welcome)



## Looking for help? You'll find it here.

Expert advice for your Bosch home appliances, need help with problems or a repair from Bosch experts.

Find out everything about the many ways Bosch can support you:

[www.bosch-home.com/service](http://www.bosch-home.com/service)

**Contact data of all countries are listed in the attached service directory.**

### **Robert Bosch Hausgeräte GmbH**

Carl-Wery-Straße 34

81739 München, GERMANY

[www.bosch-home.com](http://www.bosch-home.com)



**9001496092** (9910)

en

## Free Manuals Download Website

<http://myh66.com>

<http://usermanuals.us>

<http://www.somanuals.com>

<http://www.4manuals.cc>

<http://www.manual-lib.com>

<http://www.404manual.com>

<http://www.luxmanual.com>

<http://aubethermostatmanual.com>

Golf course search by state

<http://golfingnear.com>

Email search by domain

<http://emailbydomain.com>

Auto manuals search

<http://auto.somanuals.com>

TV manuals search

<http://tv.somanuals.com>