



BOSCH



Register your
new device on
MyBosch now and
get free benefits:
**[bosch-home.com/
welcome](https://bosch-home.com/welcome)**

Tumble dryer

WTX8HKP9SN

en Installation and operating instructions

Your new tumble dryer

You have opted for a tumble dryer manufactured by Bosch.

Please take a few minutes to read and become familiar with the advantages of your tumble dryer.

To meet the high quality demands required by Bosch, every tumble dryer that leaves our factory is carefully checked to ensure that it functions correctly and is in perfect condition.

For more information on our products, accessories, replacement parts and services, see our website www.bosch-home.com or contact our Customer Service centres.

If the operating and installation instructions describe different models, any differences will be pointed out at the relevant points in the text.



Read these operating and installation instructions before operating the tumble dryer.

Display rules

Warning!

This combination of symbol and signal word indicates a possibly dangerous situation. Not heeding the warning can cause death or injuries.

Caution!

This signal word indicates a possibly dangerous situation. Not heeding the caution can cause property and/or environmental damage.

Note/tip

Information about the optimum use of the appliance/any other useful information.







1. 2. 3. / a) b) c)











The steps are represented by numbers or letters.

■ / -

Lists are represented by a small box or a dash.

Table of contents

	Intended use	4		Operating the appliance	27
	Safety instructions	5		Loading laundry and switching on the appliance	27
	Children/people/pets	5		Setting a programme	28
	Installation	6		Starting the programme	28
	Operation	8		Programme progress	28
	Cleaning/Maintenance	11		Changing the programme or adding more laundry	29
	Energy-saving tips	12		Cancelling the programme	29
	Installing and connecting the appliance	13		End of programme	29
	Scope of delivery	13		Removing laundry and switching off the appliance	29
	Installing the appliance	13		Emptying the condensation container	30
	Connecting the appliance	15		Appliance settings	31
	Before using the appliance for the first time	16		Childproof lock	31
	Optional accessories	16		Notification signal	31
	Quick reference guide	17		Basic settings	31
	Familiarising yourself with your appliance	18		Home Connect	32
	Appliance overview	18		Calling up the Home Connect menu	33
	Fascia	19		Connecting to the home network and the Home Connect app	33
	Display	20		Activating/deactivating Wi-Fi	35
	Overview of programmes	22		Resetting your network settings	35
	Settings	24		Updating the software	36
	Laundry	26		Energy management	36
	Preparing laundry	26		Intelligent program recommendation	37
	Sorting laundry	27		Remote diagnostics	38
				Information on data protection	38
				Declaration of Conformity	39

	Crease-removal function	39
	Filling the water tank	39
	Programs for removing creases . . .	40
	Cleaning the filter in the water tank .	41
	Draining the condensation water	42
	Cleaning and maintenance . . .	45
	Cleaning the appliance	45
	Cleaning the base unit.	45
	Cleaning the moisture sensor	48
	Cleaning the filter in the condensation container	49
	Appliance care	50
	Preparing the appliance for appliance care.	50
	Running the basic appliance care programme	51
	Running the intensive appliance care programme	53
	Help with the appliance	56
	Transporting the appliance . . .	59
	Consumption values	60
	Consumption values table	60
	Most efficient programme for cotton laundry	60
	Technical data	61
	Disposal	61
	Customer Service	62

Intended use

- This appliance is intended for private domestic use only.
- Do not install or operate this appliance anywhere that is liable to experience frost and/or outdoor conditions. There is a risk that the appliance will be damaged if residual water in it freezes. If hoses freeze up, they may crack/burst.
- This appliance must only be used for drying and freshening up domestic laundry, consisting of items that have been washed with water and are suitable for tumble drying (see label on item). Using the appliance for any other purpose is outside of the scope of its intended application and is forbidden.
- This appliance is intended for use up to a maximum height of 2000 metres above sea level.

Before you switch on the appliance:

Check that there is no visible damage to the appliance. Do not operate the appliance if it is damaged. Should you have any problems, please contact your specialist dealer or our customer service.

Read and follow the operating and installation instructions and all other information provided with this appliance.

Retain the documents for subsequent use or for subsequent owners.

Safety instructions

The following safety information and warnings are provided to protect you from injury and to prevent material damage to your surroundings.

It is nevertheless important to take the necessary precautions and to proceed with care when installing, maintaining, cleaning and operating the appliance.

Children/people/pets

Warning **Risk of death!**

Children and other people who are unable to assess the risks involved when using the appliance may injure themselves or may find themselves in life-threatening situations. Therefore please note:

- The appliance may be used by children over the age of 8 years and by persons with reduced physical, sensory or mental capacity or by persons with a lack of experience or knowledge as long as they are supervised or have received instruction on how to use the appliance safely and they have understood the potential risks of using the appliance.
- Children must not play with this appliance.

- Do not allow children to clean or maintain this appliance unsupervised.
- Keep children under 3 years and pets away from this appliance.
- Do not leave the appliance unattended when children or other people who are unable to assess the risks are in the vicinity.

Warning **Risk of death!**

Children may lock themselves inside appliances and find themselves in a life-threatening situation.

- Do not position the appliance behind a door, as this may obstruct the appliance door or prevent it from opening completely.
- Once an appliance has reached the end of its life, pull the mains plug from the socket **before** severing the mains cable, and then destroy the lock on the appliance door.

Warning **Risk of suffocation!**

If allowed to play with the packaging/plastic film or packing components, children may become caught in these or pull them over their heads and suffocate.

Keep packaging, plastic film and packing components away from children.

 **Warning**

Risk of poisoning!

Detergents and care products may result in poisoning if consumed.

If accidentally swallowed, seek medical advice. Keep detergents and care products out of the reach of children.

 **Warning**

Eye/skin irritation!

Contact with detergents or care products may cause eye/skin irritation.

Rinse eyes/skin thoroughly if they/it come(s) into contact with detergents or care products. Keep detergents and care products out of the reach of children.

Installation

 **Warning**

**Risk of electric shock/fire/
material damage/damage to
the appliance!**

If the appliance is not installed properly, this may lead to a dangerous situation. Ensure the following:

- The mains voltage on your power socket must match the rated voltage specified on the appliance (identification plate). The connected loads and the required fuse protection are specified on the identification plate.
- The appliance must not be supplied through an external switching device, such as a timer, or connected to a circuit that is regularly switched on and off by a utility.
- The mains plug and the protective contact socket must match and the earthing system must be correctly installed.
- The installation must have an adequate cross section.

- The mains plug must be freely accessible at all times. If this is not possible, in order to comply with the relevant safety regulations, a switch (all pole disconnection) must be built into the permanent installation in accordance with electrical installation regulations.
- If using a residual current circuit breaker, only use one that bears the following mark: . The presence of this mark is the only way to be sure that it fulfils all the applicable regulations.

⚠ Warning

**Risk of electric shock/fire/
material damage/damage to
the appliance!**

If the appliance's mains cable is altered or damaged, this may result in electric shock, short circuiting or fire due to overheating.

The mains cable must not be kinked, crushed or altered, and must not come into contact with any heat sources.

⚠ Warning

**Risk of fire/material damage/
damage to the appliance!**

The use of extension cords or power strips may result in fire due to overheating or short circuiting.

Connect the appliance directly to an earthed socket that has been correctly installed. Do not use extension cords, power strips or multi-way couplers.

⚠ Warning

**Risk of injury/material
damage/damage to the
appliance!**

- The appliance may vibrate or move when in operation, potentially resulting in injury or material damage. Place the appliance on a clean, even, solid surface and, using a spirit level to guide you, level it with the screw-in feet.

- Incorrectly placing (stacking) this appliance on top of a washing machine may result in injury, material damage and/or damage to the appliance.

If this appliance is to be placed on top of a washing machine, the washing machine must be of at least the same depth and width as the appliance, and it must be secured in place with the appropriate connection set if available. → *Page 16*

- The appliance **MUST** be secured with this connection set. Stacking the appliance in any other way is forbidden.
- If you take hold of any of the appliance's protruding parts (e.g. the appliance door) in order to lift or move it, these parts may break off and cause injury.

Do not take hold of any of the appliance's protruding parts in order to move the appliance.

 **Warning**
Risk of injury!

- The appliance is very heavy. Lifting it may result in injury. Do not lift the appliance on your own.
- The appliance has sharp edges on which you could cut your hands. Do not take hold of the appliance by its sharp edges. Wear protective gloves to lift it.

- If the hoses and mains cables are not correctly routed, they may constitute a tripping hazard, which may result in injury. Route hoses and cables such that they do not constitute a tripping hazard.

Operation

 **Warning**
Risk of explosions/fire!

Laundry that has come into contact with solvents, oil, wax, wax remover, paint, grease or stain remover may ignite when dried in the machine, or even cause the appliance to explode. Therefore please note:

- Rinse the laundry thoroughly with warm water and detergent before drying it in the machine.
- Do not place laundry in this appliance to be dried if the laundry has not been washed first.
- Do not use the appliance if industrial chemicals have been used to clean the laundry.

 **Warning**
Risk of explosions/fire!

- If there is any residual material left in the fluff filter, this may ignite when drying is in progress, or even cause the appliance to catch fire or explode. Clean the fluff filter regularly.

- Certain objects may ignite when drying is in progress, or even cause the appliance to catch fire or explode. Remove any lighters or matches from pockets on items of clothing.
- If there is coal dust or flour in the air around the appliance, this may cause an explosion. Make sure that the area around the appliance is kept clean when it is in operation.

⚠ Warning

**Risk of fire/material damage/
damage to the appliance!**

The appliance contains R290, a refrigerant that is environmentally friendly but flammable. Keep open fire and ignition sources away from the appliance.



⚠ Warning

**Risk of fire/material damage/
damage to the appliance!**

If a program is terminated before the drying cycle has finished, this prevents the laundry from cooling down sufficiently and may cause the laundry to ignite, or may result in material damage or damage to the appliance.

- During the last part of the drying cycle, the laundry in the drum is not heated (cooling cycle). This is to ensure that it remains at a temperature at which it will not be damaged.
- Do not switch off the appliance before the drying cycle has finished unless you remove all items of laundry from the drum immediately and spread them out (to dissipate the heat).

⚠ Warning

**Risk of poisoning/material
damage!**

Condensation water is not suitable for drinking and may be contaminated with lint. Contaminated condensation water may be hazardous to health and may cause material damage.

Do not drink or reuse.

 **Warning**

Risk of poisoning!

Poisonous fumes may be given off by cleaning agents that contain solvents, e.g. cleaning solvent.

Do not use cleaning agents that contain solvents.

 **Warning**

Risk of injury!

- If you support your weight/sit on the appliance door when it is open, the appliance may tip over, which may result in injury.

Do not support your weight on the appliance door when it is open.

- If you climb onto the appliance, the worktop may break, which may result in injury.

Do not climb onto the appliance.

- If you reach into the drum while it is still rotating, you risk injuring your hands. Wait until the drum has stopped rotating.

Caution!

Material damage/damage to the appliance

- If the amount of laundry in the appliance exceeds its maximum load capacity, it may not be able to operate properly, or this may result in material damage or damage to the appliance.

Do not exceed the maximum load capacity of dry laundry.

Make sure you comply with the maximum load capacities specified for each of the programs. → *Page 22*

- If you operate the appliance without a fluff catcher (e.g. fluff filter, fluff depot, depending on appliance specifications), or if the fluff catcher is incomplete or defective, this may result in damage to the appliance. Do not operate the appliance without a fluff catcher, or with a fluff catcher that is incomplete or defective.

- Light objects such as hair and lint may be sucked into the air inlet when the appliance is in operation. Keep these away from the appliance.

- Foam and foam rubber may deform or melt if dried in the appliance.

Do not dry laundry items that contain foam or foam rubber in the appliance.

- If you pour the wrong quantity of detergent or cleaning agent into the appliance, this may result in material damage or damage to the appliance. Use detergents/care products/cleaning agents and softeners in accordance with the manufacturers' instructions.
- If the appliance overheats, it may not be able to operate properly, or this may result in material damage or damage to the appliance. Make sure that the appliance's air inlet is never obstructed when the appliance is in operation, and that the area around the appliance is adequately ventilated.
- When removing the mains plug from the socket, always take hold of the plug itself and never the mains cable, otherwise this may damage the mains cable.
- Do not make any technical modifications to the appliance or its features.
- Repairs and any other work on the appliance must only be conducted by our customer service or by an electrician. The same applies for replacing the mains cable (when necessary).
- Spare mains cables can be ordered from our customer service.

 Warning
Risk of poisoning!

Poisonous fumes may be given off by cleaning agents that contain solvents, e.g. cleaning solvent.

Do not use cleaning agents that contain solvents.

 Warning
Risk of electric shock/material damage/damage to the appliance!

If moisture penetrates the appliance, this may cause it to short circuit.

Do not use a pressure washer, steam cleaner, hose or spray gun to clean your appliance.

Cleaning/Maintenance

 Warning
Risk of death!

The appliance is powered by electricity. There is a risk of electric shock if you come into contact with live components. Therefore please note:

- Switch off the appliance. Disconnect the appliance from the power supply (pull out the plug).
- Never take hold of the mains plug with wet hands.

Warning

Risk of injury/material damage/damage to the appliance!

The use of spare parts and accessories supplied by other brands is dangerous and may result in injury, material damage or damage to the appliance.

For safety reasons, use genuine spare parts and accessories only.

Caution!

Material damage/damage to the appliance

Cleaning agents and agents for pretreating laundry (e.g. stain removers, prewash sprays, etc.) may cause damage if they come into contact with the surfaces of the appliance. Therefore please note:

- Do not allow these agents to come into contact with the surfaces of the appliance.
- Clean the appliance with nothing but water and a soft, damp cloth.
- Remove any detergent, spray or other residues immediately.



Energy-saving tips

- Spin the laundry before drying. The drier the laundry, the shorter the programme will be, in turn reducing energy consumption.
- Load the appliance with the maximum loads permitted for the programmes.

Note: If the maximum load is exceeded, this extends the programme duration and increases energy consumption.

- Operate the appliance in a ventilated room and make sure that the air inlet on the appliance is unobstructed so that air exchange can take place unhindered.
- Regularly remove the fluff from the appliance. If there is fluff in the appliance, this extends the programme duration and increases energy consumption.
- If you do not perform any actions on the appliance for an extended period before the programme starts or once the programme has ended, the appliance will automatically switch to energy-saving mode. The display and indicator lights go out after a few minutes and  (Start/Pause) flashes. To end energy-saving mode, all you need to do is perform an action on the appliance, such as opening and closing the door.
- If you do not perform any actions on the appliance for an extended period when it is in energy-saving mode, the appliance automatically switches itself off.

Note: If Wi-Fi is activated, the appliance will not switch itself off automatically.



Installing and connecting the appliance

Scope of delivery

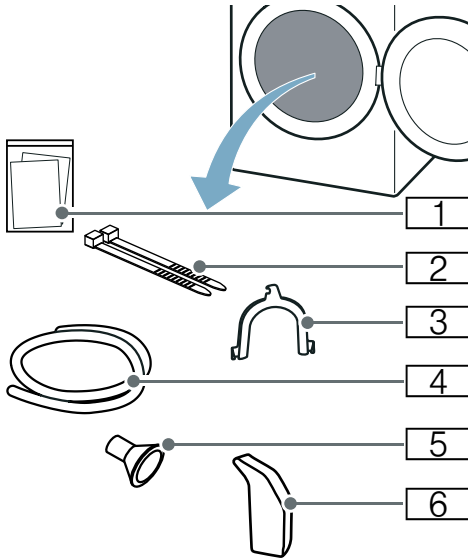

- 1 Accompanying documents (e.g. installation and operating instructions)
- 2 Fastening parts
- 3 U-piece for fixing the drain hose in place
- 4 Outlet hose
- 5 Connection adapter
- 6 Water jug

1. Remove any packaging and protective covers completely from the appliance.
2. Open the door.

3. Remove all the accessories from the drum.

You can now install and connect the appliance.

Caution!

Risk of material damage and damage to the appliance

Objects remaining in the drum that are not designed for operation with the appliance may result in material damage and damage to the appliance. Remove these objects, along with all accessories, from the drum.

Installing the appliance

Warning **Risk of death!**

Children may lock themselves inside appliances and find themselves in a life-threatening situation.

- Do not position the appliance behind a door, as this may obstruct the appliance door or prevent it from opening completely.
- Once an appliance has reached the end of its life, pull the mains plug from the socket **before** severing the mains cable, and then destroy the lock on the appliance door.

Warning **Risk of explosions/fire!**

If there is coal dust or flour in the air around the appliance, this may cause an explosion.

Make sure that the area around the appliance is kept clean when it is in operation.

en Installing and connecting the appliance



Warning
Risk of fire/material damage/damage to the appliance!

The appliance contains R290, a refrigerant that is environmentally friendly but flammable. Keep open fire and ignition sources away from the appliance.



Warning
Risk of injury/material damage/damage to the appliance!

- The appliance may vibrate or move when in operation, potentially resulting in injury or material damage.
Place the appliance on a clean, even, solid surface and, using a spirit level to guide you, level it with the screw-in feet.
- Incorrectly placing (stacking) this appliance on top of a washing machine may result in injury, material damage and/or damage to the appliance.
If this appliance is to be placed on top of a washing machine, the washing machine must be of at least the same depth and width as the appliance, and it must be secured in place with the appropriate connection set if available.
→ Page 16
The appliance **MUST** be secured with this connection set. Stacking the appliance in any other way is forbidden.
- If you take hold of any of the appliance's protruding parts (e.g. the appliance door) in order to lift or move it, these parts may break off and cause injury.
Do not take hold of any of the appliance's protruding parts in order to move the appliance.



Warning
Risk of injury!

- The appliance is very heavy. Lifting it may result in injury.
Do not lift the appliance on your own.
- The appliance has sharp edges on which you could cut your hands.
Do not take hold of the appliance by its sharp edges. Wear protective gloves to lift it.

Caution!
Material damage/damage to the appliance

If the appliance overheats, it may not be able to operate properly, or this may result in material damage or damage to the appliance.
Make sure that the appliance's air inlet is never obstructed when the appliance is in operation, and that the area around the appliance is adequately ventilated.

Caution!
Risk of material damage and damage to the appliance

The appliance underwent a function test before leaving the factory and therefore may contain residual water. This residual water may leak out if the appliance is tilted at an angle greater than 40°.

Install the appliance as follows:

1. Place the appliance on a clean, even, solid surface.
2. Check that the appliance is level using a spirit level.

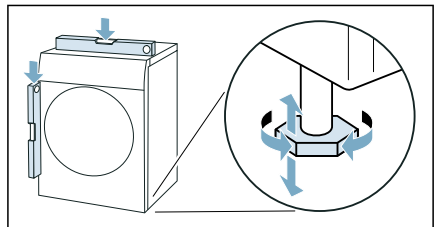

3. If necessary, turn the appliance feet to make sure it is level.
You can now connect the appliance.

Notes

- All appliance feet must stand firmly on the ground.
- If the appliance is not aligned correctly, this may result in noises, vibrations, uneven drum operation and/or residual water leaking out of the appliance.

Connecting the appliance

Warning

Risk of electric shock/fire/material damage/damage to the appliance!

If the appliance is not installed properly, this may lead to a dangerous situation. Ensure the following:

- The mains voltage on your power socket must match the rated voltage specified on the appliance (identification plate). The connected loads and the required fuse protection are specified on the identification plate.
- The appliance must not be supplied through an external switching device, such as a timer, or connected to a circuit that is regularly switched on and off by a utility.
- The mains plug and the protective contact socket must match and the earthing system must be correctly installed.
- The installation must have an adequate cross section.
- The mains plug must be freely accessible at all times. If this is not possible, in order to comply with the relevant safety regulations, a switch (all pole disconnection) must be built into the permanent installation in accordance with electrical installation regulations.

- If using a residual current circuit breaker, only use one that bears the following mark: . The presence of this mark is the only way to be sure that it fulfils all the applicable regulations.

Warning

Risk of electric shock/fire/material damage/damage to the appliance!

If the appliance's mains cable is altered or damaged, this may result in electric shock, short circuiting or fire due to overheating.

The mains cable must not be kinked, crushed or altered, and must not come into contact with any heat sources.

Warning

Risk of fire/material damage/damage to the appliance!

The use of extension cords or power strips may result in fire due to overheating or short circuiting. Connect the appliance directly to an earthed socket that has been correctly installed. Do not use extension cords, power strips or multi-way couplers.

Warning

Risk of injury!

If the hoses and mains cables are not correctly routed, they may constitute a tripping hazard, which may result in injury.

Route hoses and cables such that they do not constitute a tripping hazard.

Connect the appliance as follows:

1. Connecting the drain hose.
→ Page 42

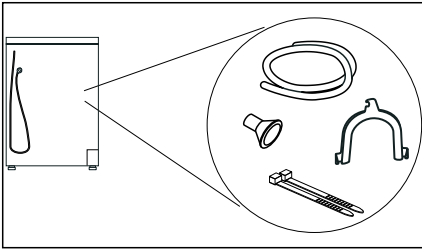

2. Plug the appliance's mains plug into the designated socket.
 3. Check that the mains plug is in securely.
- Your appliance is now ready to use.

Caution!

Risk of material damage/damage to the appliance

The appliance contains refrigerant and may be damaged if it is operated immediately after transportation. Allow the appliance to rest for two hours before initial use.

Note: If in doubt, have your appliance connected by a qualified professional.

Before using the appliance for the first time

Before you switch on the appliance:

Check that there is no visible damage to the appliance. Do not operate the appliance if it is damaged. Should you have any problems, please contact your specialist dealer or our customer service.

Note: Once the appliance has been properly installed and connected, it is ready to use. No further steps are necessary.

Optional accessories











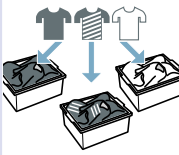

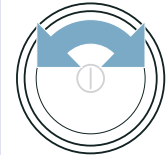
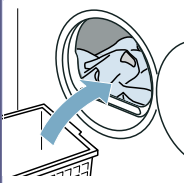
Order optional accessories* from the after-sales service:

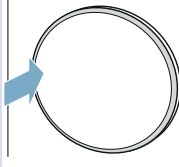
- **Basket for woollens:**
Dry or air individual woollen items, sports shoes and soft toys in the basket for woollens.
– Order number: **WMZ20600**.
- **Platform:**
For easier loading and unloading, raise your dryer with a platform. You can transport laundry with the laundry basket integrated into the platform drawer.
– Order number: **—**.
- **Washer-dryer stack connection kit:**
To save space, the dryer can be placed on top of a suitable washing machine of the same width and depth.
Only this connection kit may be used to secure the dryer to the washing machine.
– Order number with pull-out worktop: **WTZ11400**
– Order number without pull-out worktop: **WTZ20410**.
- **Condensate drainage kit:**
You can discharge the condensation water into the waste-water system via a drain hose. If you choose to discharge the condensation water into the waste-water system, you will not need to empty the condensation container during the drying programme or after each time you use the dryer.
Order number: **—**
– **Y-connection adapter for the water outlet**
If you have a washing machine connected to the same outlet, you can secure the water outlet hose and the drain hose (from the connection kit) to the adapter on the drain.
Order number: **15000490**

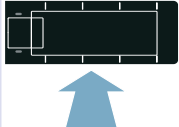
* Depending on the appliance features

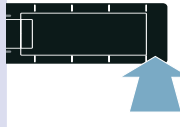
Quick reference guide

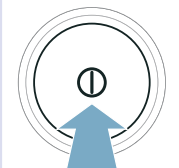
Note: The appliance must be correctly installed and connected. → *Page 13*

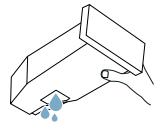
<p>1</p> <p>Before starting the programme:</p>				
		<p>Sort the laundry.</p>		<p>Select a programme.</p>
<p>2</p>		 	 	 
	<p>Open the door and place the laundry in the drum.</p>	<p>Close the door.</p>	<p>If necessary: Adjust the programme settings.</p>	<p>Start the programme.</p>
<p>3</p> <p>Once the programme has ended:</p>				 
		<p>Switch off the appliance.</p>		<p>Empty the condensation container.</p>

Familiarising yourself with your appliance

Appliance overview

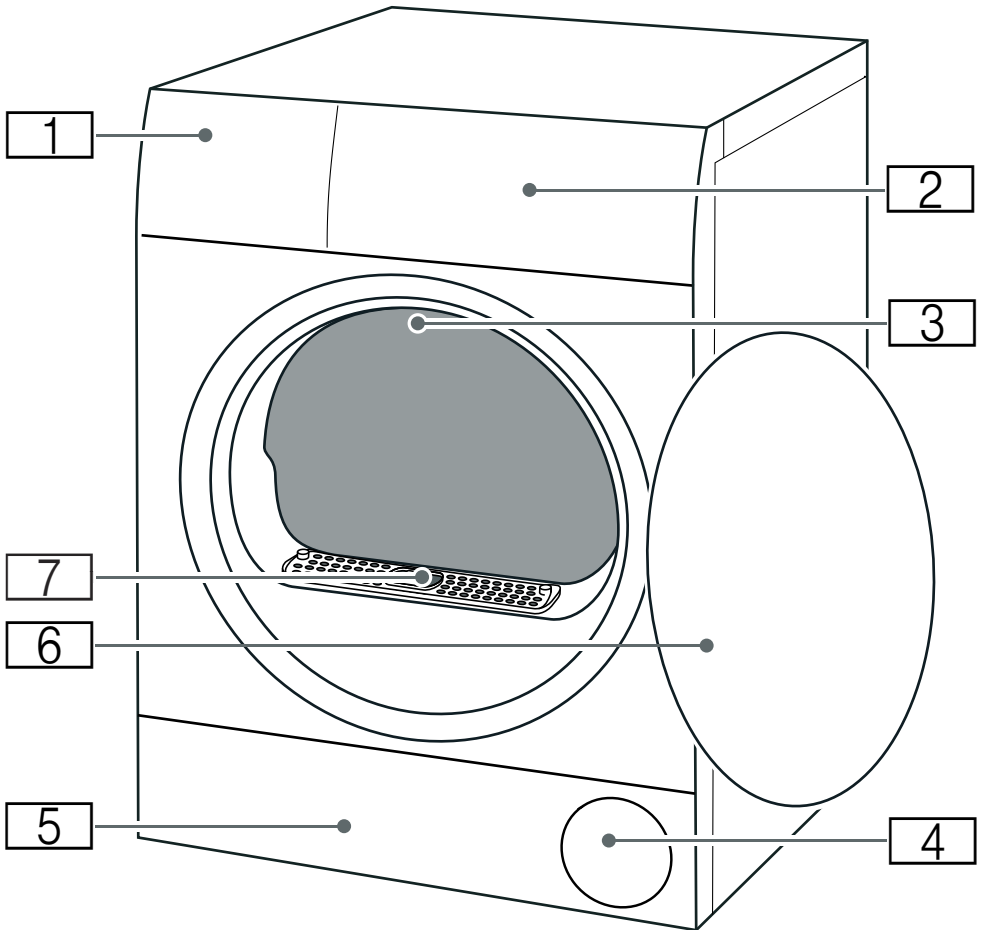

- 1** Condensation container → *Page 30*
- 2** Panel
- 3** Drum interior lighting (depending on the model)
- 4** Air inlet
- 5** Maintenance flap on the base unit → *Page 45*
- 6** Door
- 7** Air channel cover (do not remove)

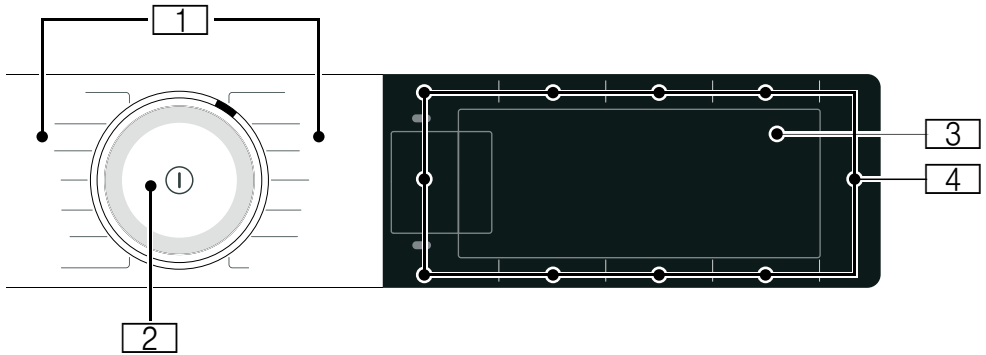
Fascia

1

Programmes

2

Programme selector

- Turn: Set a programme
- Press: Switch the appliance on/off

3

Display

Displays settings and information

4







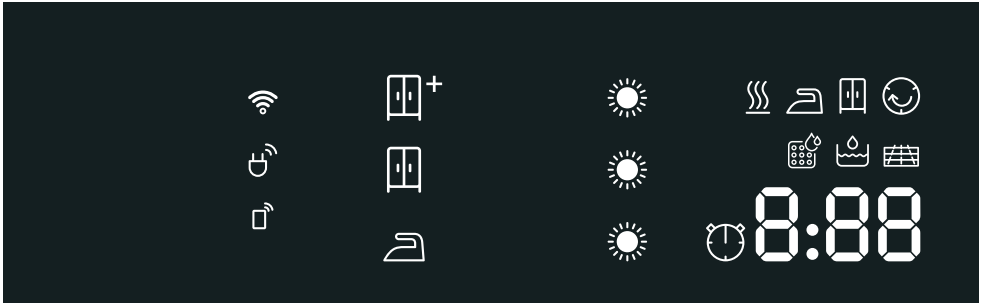



Buttons

for programme settings and additional functions/appliance settings



Display





Display	Description	Information
	Programme status:	Lights up: Status display
	Crease removal	
	Drying	
	Iron Dry	
	Cupboard Dry	
	Anti-Crease	
	Pause	
<i>End</i>	End of programme	
	Dryness level	Dryness level Cupboard Dry Plus activated
		Dryness level Cupboard Dry activated
		Dryness level Iron Dry activated
	Degree of dryness	Degree of dryness for a dryness level activated
e.g. 1:27	Programme duration	Expected programme duration in hours and minutes.
3 h	End of programme	Programme delay in hours if you have activated the "Ready-in" time.
	Timed programme	Timed programme activated
	Wi-Fi	<ul style="list-style-type: none"> ■ Off: Wi-Fi is switched off and your appliance is not connected to your home network. ■ Flashing: The appliance is trying to connect to your home network. ■ Lit: Wi-Fi is switched on and your appliance is connected to your home network.



















	Remote Start	lights up: Remote start function is activated. → Page 24
	Energy manager	Lit: appliance is connected to the smart energy system (Energy manager) (not available in every country)
	Empty the condensation container → Page 30	<ul style="list-style-type: none"> ■ Empty the condensation container and then reinsert it. → Page 30 Then press  (Start/Pause). ■ Clean the filter in the condensation container. ■ If the optional drain hose* is installed, make sure that the drain hose: <ul style="list-style-type: none"> - Is correctly connected. → Page 42 - Is not kinked or bent. - Is not blocked or clogged, e.g. by deposits. ■ Run the intensive appliance care programme. ■ Check that no debris has found its way into the base unit. Open the maintenance flap and remove any debris.
	Base unit	Cleaning the base unit → Page 45
	Automatic heat exchanger rinse	The heat exchanger is being cleaned automatically. Do not pull out the condensation container or cancel the programme while this is displayed.
	Water reservoir	Fill the water reservoir with cold water for the crease removal function. → Page 39 Press  (Start/Pause).
	Basic appliance care programme	Not a fault. After a certain period, the appliance will automatically recommend that you run the basic appliance care programme. Run the basic appliance care programme. → Page 51
	CoolDown	<p>The appliance can reach high temperatures when drying. The CoolDown process reduces the temperature to prevent damage to the laundry when you:</p> <ul style="list-style-type: none"> ■ Pause the programme ■ Cancel the programme ■ Switch off the appliance via the app <p>The CoolDown process does not start until 30 seconds after pausing/cancelling the programme or switching off the appliance via the app. You can continue to operate the appliance during the CoolDown process.</p> <p>Notes</p> <ul style="list-style-type: none"> ■ The drum continues to rotate during the CoolDown process, even if you have paused the programme. ■ Do not change the programme during the CoolDown process. ■ Temperature regulation can take up to 10 minutes.













Overview of programmes

Programme	Maximum load
<p>Programme name Brief explanation of the programme and the items for which it is suitable.</p>	<p>Maximum load based on the dry weight of the items</p>
<p>Cotton  Hard-wearing items and heat-resistant items made of cotton or linen.</p>	<p>9 kg</p>
<p>Easy Care Items made of synthetic or blended fabrics.</p>	<p>3.5 kg</p>
<p>Mix Mixed load consisting of items made from cotton and synthetic fabrics.</p>	<p>3 kg</p>
<p>Delicate Delicate, washable items, e.g. made from satin, or synthetic or blended fabrics.</p>	<p>2 kg</p>
<p>Wool Finish Machine-washable items made of wool or containing wool.</p> <p>Notes</p> <ul style="list-style-type: none"> ■ Laundry becomes fluffier but not dry. ■ Remove laundry once the programme has ended and allow to dry. 	<p>0.5 kg</p>
<p>Time Program Warm Timed programme for all types of fabric except silk. Suitable for pre-dried or slightly damp laundry and for drying off multi-layered, thick laundry. For drying individual items of laundry.</p> <p>Notes</p> <ul style="list-style-type: none"> ■ Dry woollens, sports shoes and soft toys only with the basket for woollens. ■ In the timed programme, the laundry's remaining moisture is not automatically detected. If the laundry is still too damp when the drying programme has ended, repeat the programme and, if required, extend the programme duration. 	<p>3 kg Max. load for woollens/soft toys in the basket: 1 basket load Max. load for shoes in the basket: 1 pair</p>
<p>Smart Dry  After you have washed your laundry in the washing machine, the dryer will recommend a suitable program for drying your laundry. Further information: → <i>Page 38</i></p> <p>Notes</p> <ul style="list-style-type: none"> ■ The washing machine must be Home Connect-capable. ■ The washing machine and dryer must be connected to your home network and registered in your Home Connect app. 	<p>Depends on the recommended program</p>

<p>Business </p> <p>Timed program for reducing creasing and airborne odours (e.g. cigarette smoke). Suitable for dry suits, jackets and trousers that have not been worn for long, are labelled "Dry clean only" and are therefore not suitable for washing in the washing machine. Further information: → <i>Page 39</i></p> <p>Notes</p> <ul style="list-style-type: none"> ■ Laundry is not dried or washed. ■ The program is not suitable for thin, lightweight summer suits. ■ To prevent creasing, remove laundry immediately after the program has ended. 	<p>1 suit (1 jacket and 1 pair of trousers/skirt)</p>
<p>5 Shirts </p> <p>Timed program for reducing creasing and airborne odours (e.g. cigarette smoke). Suitable for dry shirts and blouses that have not been worn for long. Further information: → <i>Page 39</i></p> <p>Notes</p> <ul style="list-style-type: none"> ■ Laundry is not dried or washed. ■ To prevent creasing, remove laundry immediately after the program has ended. 	<p>2-5 shirts</p>
<p>1 Shirt </p> <p>Timed program for reducing creasing and airborne odours (e.g. cigarette smoke). Suitable for dry shirts and blouses that have not been worn for long. Further information: → <i>Page 39</i></p> <p>Notes</p> <ul style="list-style-type: none"> ■ Laundry is not dried or washed. ■ To prevent creasing, remove laundry immediately after the program has ended. 	<p>1 shirt or 1 blouse</p>
<p>Shirts/Blouses</p> <p>Shirts/blouses made of cotton, linen, or synthetic or blended fabrics.</p> <p>Note: Once the laundry is dry, iron it or hang it up. This will allow the residual moisture to be distributed evenly.</p>	<p>1.5 kg</p>
<p>Towels</p> <p>Hard-wearing towels and dressing gowns made of cotton.</p>	<p>6 kg</p>
<p>Rapid 40'</p> <p>Mixed load of synthetic fabrics and light cottons.</p>	<p>1 kg</p>
<p>AllergyPlus</p> <p>Hard-wearing items.</p> <p>Note: The programme reaches high temperatures. Particularly suitable for strict hygiene requirements.</p>	<p>4 kg</p>

P+ Settings

Programme setting	Function
<p>Note: Not all settings can be activated in every programme. The activated settings are displayed on the buttons or highlighted brightly in the display. You can change or deactivate the activated settings by repeatedly pressing on the relevant buttons on the display.</p>	
 (Remote Start)	<p>Pressing  (Remote Start) allows you to start the appliance remotely via the Home Connect app or to call up the Home Connect settings.</p> <p>Notes</p> <ul style="list-style-type: none"> ■ Please observe the instructions for the ambient temperatures → <i>Page 61</i>. ■ Remote start can only be activated if the appliance door is closed and the appliance is connected to your home network. ■ Remote start is deactivated for safety reasons in the following circumstances: <ul style="list-style-type: none"> ■ Open the door, ■ Power failure, ■ Press  (Start/Pause) on the appliance, ■ Briefly press  again, ■ Press  to switch off the appliance.
 (Drying Target):	<p>The dryness level defines how damp or dry the laundry is after the programme ends. If you have set a dryness level, this is retained even after the appliance has been switched off for the relevant programme. Exception: The settings are not saved for Cottons.</p>
 Cupboard Dry Plus	<p>Multi-layered, thick laundry that does not dry readily.</p>
 Cupboard Dry	<p>Normal, single-layered laundry.</p>
 Iron Dry	<p>Normal, single-layered laundry that still needs to be damp after drying and is suitable for ironing or hanging up.</p>
 (Drying level)	<p>If you think the laundry is still too damp when the drying programme has ended, you can adjust the degree of dryness to achieve a particular dryness level. To increase the dryness level, set the degree of dryness to between  and . This extends the programme duration but the temperature remains the same.</p> <p>Once you have adjusted the degree of dryness for a dryness level, this setting is retained even after the appliance is switched off.</p>
 (Finished in)	<p>Before starting the programme, you can delay the time at which the programme ends by up to 24 hours using  and .</p> <p>The set time in hours, e.g. 8 h, is shown in the display and counts down until the programme starts. Once the programme has started, the programme duration is displayed.</p> <p>Note: Observe the information about the ambient temperatures → <i>Page 61</i>.</p>
 (Finished in)	<p>The drying time for  timed programmes can be extended in 10-minute increments using  and .</p>

	You can use the  and  selection buttons to adjust the setting values.
 60' (Reduced Ironing 60 min.)	The drum moves the laundry at regular intervals after drying to prevent creasing. You can activate or deactivate the automatic Anti-Crease function for 60 minutes (using  60' (Reduced Ironing 60 min.)) or for 120 minutes (using  120' (Reduced Ironing 120 min.)).
 120' (Reduced Ironing 120 min.)	
 (Low Heat)	Reduced temperature for delicate fabrics, e.g. polyacrylic or elastane, may increase the drying time.
 (Start/Pause)	Starting, cancelling and interrupting a programme.
Appliance setting Function	
You can find out how to adjust the appliance setting on  <i>Page 31</i>	
 3 sek. (Child Lock 3 sec.)	Disable the control panel to prevent unwanted or accidental operation.
 (Signal)	Use  (Signal) to activate or deactivate the audible signal that sounds to indicate that the programme has ended. If the setting has been selected, the button's indicator light lights up and the signal tone is activated.



Laundry

Preparing laundry



Warning

Risk of explosions/fire!

Certain objects may ignite when drying is in progress, or even cause the appliance to catch fire or explode. Remove any lighters or matches from pockets on items of clothing.

Caution!

Risk of damage to the drum and laundry

Leaving objects in the pockets of your clothing can cause damage to the drum and laundry when the appliance is in operation. Remove all objects (e.g. metal items) from clothing pockets.

Prepare the laundry as follows:

- Tie cloth belts, apron strings, etc. together or use a laundry bag.
- Close zips, hooks, eyelets and buttons. Button up large items of laundry, such as covers.
- Always dry very small items of laundry, e.g. babies' socks, together with large items such as towels.
- Use timed programmes for single items.
- Knitted items, such as T-shirts and jerseys, often shrink slightly the first time they are tumble-dried. Use a gentle programme.
- Do not overdry easy-care laundry. This leads to increased creasing of your laundry.

- Some detergents and care products, e.g. starch or softeners, contain particles that may accumulate on the moisture sensor. This may impair the sensor's performance and, in turn, the drying result.

Notes

- When washing laundry to be tumble-dried, use the correct amount of detergent and care products as specified in the manufacturer's instructions.
- Clean the moisture sensor regularly → *Page 48*.

Sorting laundry

Note: Load the laundry item by item into the appliance. For more effective drying, do not stuff an entire bundle of laundry into the dryer at once.

Caution!

Risk of material damage to the dryer or laundry

Laundry that is unsuitable for tumble-drying may damage the appliance and the laundry when it is dried. Before you dry it, sort the laundry according to the information given on the care label:

- Suitable for tumble drying
- Dry at normal temperature
- Dry at low temperature
- Do not tumble-dry

When sorting the laundry to be dried, take the following points into account:

- To achieve an even drying result, only dry laundry of the same type of fabric and texture together. If you dry thin, thick and multi-layered fabrics together, they will dry to differing degrees.
- Use the fabric descriptions given for the individual drying programmes to help you choose the most appropriate programme.
→ "Overview of programmes" on page 22

Note: You can select a timed programme to add extra drying time for laundry that is still damp.

Caution!

Risk of material damage to the appliance and laundry

Do **not** tumble-dry the following items or fabrics in the appliance:

- Laundry contaminated with solvents, wax or grease.
- Unwashed items.
- Items made from non-breathable fabrics (e.g. rubber-coated).
- Items made from delicate fabrics, such as silk and curtains made of synthetic material.

Operating the appliance

Loading laundry and switching on the appliance

Note: The appliance must be correctly installed and connected. → Page 13

1. Prepare and sort the laundry.
2. Press  to switch on the appliance.

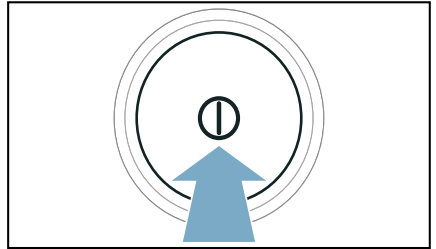

3. Open the door. Check that the drum has been completely emptied. Empty it if necessary.

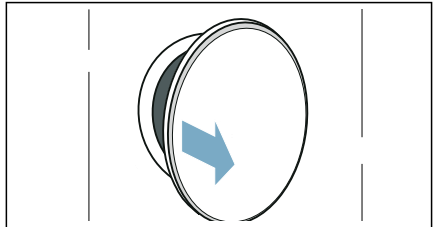

4. Load the laundry unfolded into the drum.

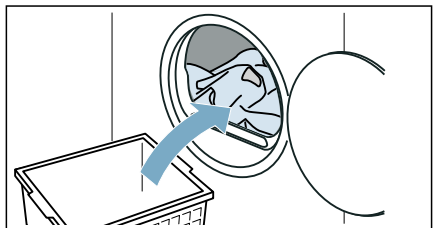

5. Close the appliance door.

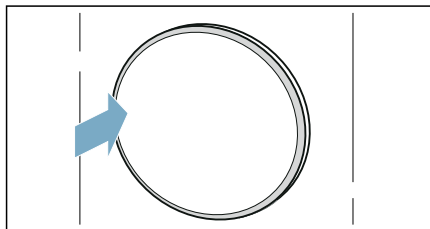

Caution!

Risk of material damage to the appliance or laundry.

Make sure that laundry is not trapped in the door.

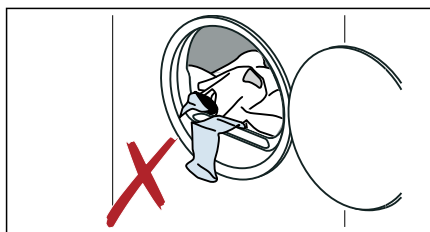

Note: The appliance's drum is lit up after the door is opened and closed and once the programme has started. The drum's interior light goes out on its own (depending on model).

Setting a programme

Note: If you have activated the childproof lock, you must deactivate it before you can set a programme.
→ Page 31

1. Set the programme you require.

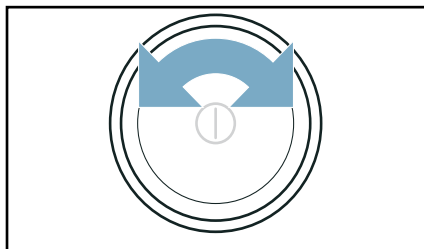

The programme settings will appear on the display.

2. Adjust the programme settings, if required.

Starting the programme

Press  (Start/Pause).

Note: If you want to prevent the programme from being adjusted inadvertently, activate the childproof lock. → Page 31

Programme progress

The programme status will be indicated on the display.

Note: When a programme is selected, the expected drying time for the maximum permitted load is displayed. The moisture sensor measures the residual moisture in the laundry as it is being dried. The programme duration and the remaining time indicated on the display are automatically adjusted as the programme progresses, depending on how damp the laundry is (exception: Timed programmes).

Changing the programme or adding more laundry

You can remove or add laundry and change or adjust the programme at any time during drying.

1. Open the door or press  (Start/Pause) to pause the programme.
Note: The drum will continue to rotate when the CoolDown process is in progress, even if you have paused the programme. You can stop the CoolDown process at any time by opening the door.
2. Add or remove laundry.
3. If required, select a different programme or a different programme setting. → "Overview of programmes" on page 22

Note: Do not change the programme during the CoolDown process.

4. Close the appliance door.
5. Press  (Start/Pause).

Note: The programme duration is updated on the display, depending on the load and on the residual moisture in the laundry. The values displayed may change when the programme or load is changed.

Cancelling the programme

The programme can be cancelled at any time by opening the door or pressing  (Start/Pause).

Caution!

Risk of fire. Laundry may catch fire.

If you cancel the programme, remove all items of laundry from the dryer and spread them out to allow the heat to dissipate.

End of programme

The following message appears in the display: *End*

Removing laundry and switching off the appliance

1. Remove the laundry.

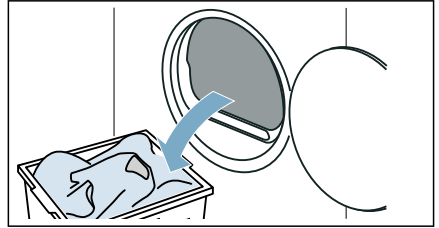

2. Press  to switch off the appliance.

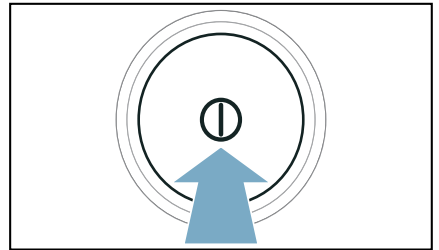

Emptying the condensation container

Condensation will form in the appliance as it dries the laundry.

If there is no drain hose connected to the appliance, the condensation water from the appliance will run into the condensation container. In this case, you will need to empty the condensation container each time the dryer finishes drying the laundry, and also if it becomes full before drying is complete.

1. Pull out the condensation container horizontally.

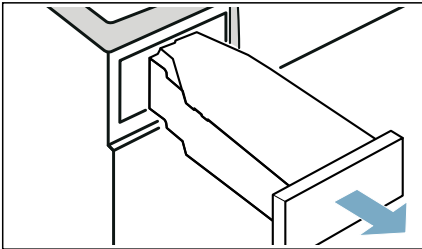

2. Pour out the condensation water.

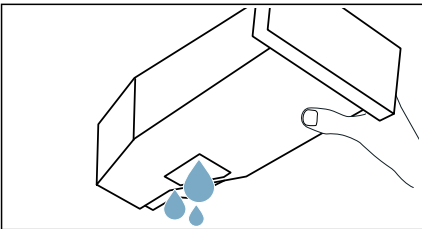

Caution!

Risk of harm to health and material damage

Condensation water is not suitable for drinking and may be contaminated with fluff.

Contaminated condensation water may be harmful to your health and cause material damage. Do not drink the condensation water or reuse it.

3. Push the condensation container back into the appliance until you feel it lock into place.

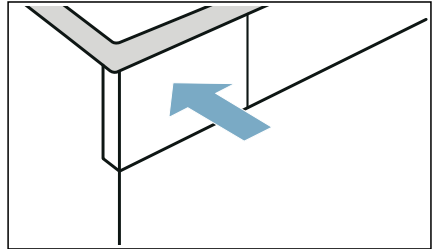

Note: The filter in the condensation container filters the condensation water, which is used during the appliance's automatic cleaning cycle. The filter is cleaned by emptying out the condensation water. You should still check the filter regularly for any build-up, and remove this if necessary.
→ "Cleaning the filter in the condensation container" on page 49

Appliance settings

You can activate/deactivate the childproof lock and adjust the basic settings (e.g. signals).

Childproof lock

Activating the childproof lock prevents the settings from being accidentally changed on the control panel.

Activating/deactivating the childproof lock:

- Press and hold  **3 sek. (Child Lock 3 sec.)** for 3 seconds.

Note: The childproof lock will remain active, even once the appliance has been switched off. If you wish to change settings on the control panel when you turn on the appliance, you will need to deactivate the childproof lock.

Notification signal

You can activate or deactivate the notification signal at the end of the programme. If you activate this setting, an audible signal will sound once the programme has ended.

Activate/deactivate the appliance setting as follows:

Press  (Signal).

The notification signal at the end of programme is activated/deactivated.



Note: If a signal does not sound when the programme ends even though the notification signal is activated, you can change the appliance setting.

Basic settings

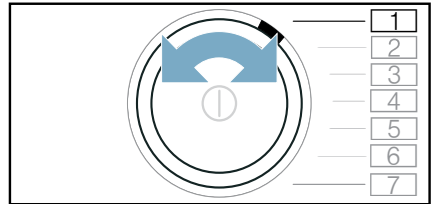

You can adjust certain basic settings on the appliance. To make adjustments, you first need to **call up the setting mode** :

1. Set the programme to the  position.

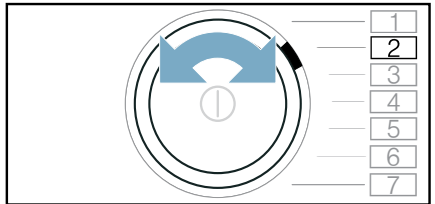

2. Press  (Drying Target) and, at the same time:
3. Set the programme to the  position.



4. Release  .
Setting mode is now activated.

The basic settings are assigned to the following programme positions:

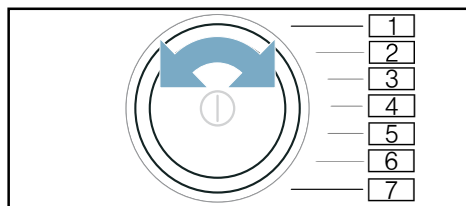

Position	Basic setting
2	Adjust the volume of the audible notification signals (e.g. at the end of a programme).
3	Adjust the volume of the audible operating signals.

Settings:

- 0 Off
- 1 Low
- 2 Medium
- 3 High
- 4 Very high

Adjust and activate/deactivate the basic settings as follows

1. Position of the required basic setting.
2. Change the setting using:
— +
3. Adjust any additional basic settings you require or save and exit the basic settings.

Save and exit the basic settings as follows

Switch off the appliance.

Note: The selected settings are retained even after the appliance has been switched off.

Home Connect

This appliance is Wi-Fi-capable and can be remotely controlled using a mobile device.

You can use the Home Connect app to do the following on your appliance from your mobile device:

- Set up programs and launch them.
- Adjust, activate and deactivate program settings.
- Query the status of programs.
- Adjust, activate and deactivate appliance settings.
- Switch off the appliance.

Before you can use the Home Connect functions, you will need to carry out the following steps:

1. Install the Home Connect app on your mobile device.
2. Register in the Home Connect app.
3. Connect your appliance to your home network automatically **or** manually (you only need to do this the first time).
4. Connect your appliance to the Home Connect app.

You can find information about the app on our Home Connect website www.home-connect.com

Home Connect services are not available in every country. The availability of the Home Connect function depends on the availability of Home Connect services in your country. You can find information on this at: www.home-connect.com

Notes

- Please observe the safety precautions in this instruction manual and make sure that these are complied with even when operating the appliance via the Home Connect app while you are away from home. You must also follow the instructions in the Home Connect app.
- You cannot use the Home Connect app to make changes while the controls on the appliance are being operated. However, you can use the Home Connect app to see any adjustments made directly on the appliance itself.

Calling up the Home Connect menu

In the Home Connect menu, you can create and view network connections, reset network settings, activate/deactivate Wi-Fi and find other Home Connect functions.

1. Switch on the appliance.
2. Press and hold  (Remote Start) for at least 3 seconds.

 appears in the display.

You are now in the Home Connect menu.

Note: Briefly press  (Remote Start) to exit the Home Connect menu.

Connecting to the home network and the Home Connect app

Connect your appliance to the home network **automatically** or **manually** (you only need to do this the first time).

Notes

- If your home network router has a WPS function, you can connect the appliance to your home network automatically.
- If your home network router does not have a WPS function, you need to connect the appliance to your home network manually.

You must then connect to the Home Connect app.

Note: To connect your appliance to the home network, **Wi-Fi** must be activated on the appliance. **Wi-Fi** is deactivated on the appliance by default and is activated automatically when you connect your appliance to your home network.

Connecting to your home network automatically

Step 2.1

Ensure that you are in the Home Connect menu. → *Page 33*

1. Press .

The appliance now attempts to connect to your home network.  flashes in the display.

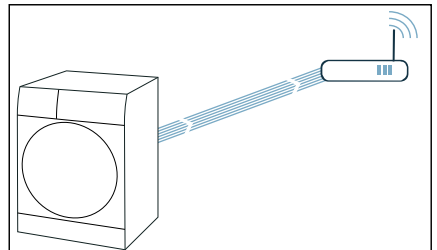

2. Activate the WPS function on your home network router within the next 2 minutes.

If the appliance has connected to your home network successfully, **CON** and  appear in the display and light up continuously.

Note: If you are not able to establish a connection, check whether your appliance is within range of your home network. Try connecting automatically again or connect your appliance manually.

Connecting to your home network manually

Step 2.2

Ensure that you are in the Home Connect menu. → Page 33

Make sure that you have opened the Home Connect app and are logged in.

1. Set the programme to position 2.

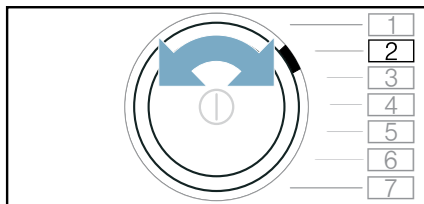

SAP (connect manually) appears in the display.

2. Press .

The appliance now sets up its own Wi-Fi network with the name (SSID)

HomeConnect.

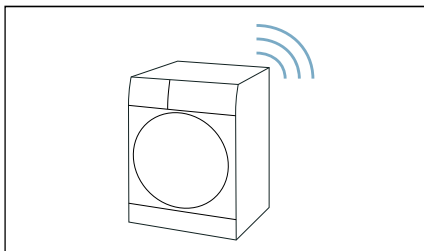

3. Call up the Wi-Fi setting on the mobile device.
4. Connect the mobile device to the **Home Connect** Wi-Fi network and enter the password (key) **HomeConnect**.

Your mobile device now connects to the appliance. The connection process may take up to 60 seconds.

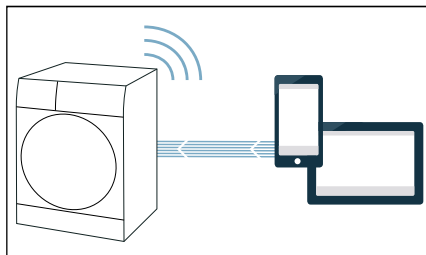

5. Once you have connected successfully, open the Home Connect app on your mobile device and carry out the steps in the app.
6. In the Home Connect app, enter the network name (SSID) and password (key) for **your home network**.
7. Carry out the last steps in the Home Connect app to connect your appliance.

If the appliance has connected to your home network successfully, **CON** and  appear in the display and light up continuously.

Note: If you are not able to establish a connection, check whether your appliance is within range of your home network. Try connecting manually again.

Connecting to the Home Connect app

If your appliance is connected to your home network, you can connect it to the Home Connect app.

Ensure that you are in the Home Connect menu. → Page 33

Make sure that you have opened the Home Connect app and are logged in.

1. Set the programme to position 3.

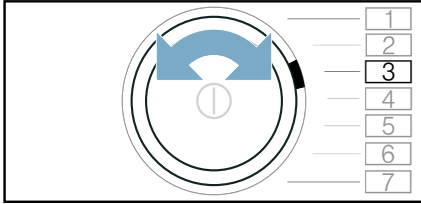

APP (connect to app) appears in the display.

2. Press \triangleright .

The appliance now attempts to connect to the Home Connect app.

3. Once your appliance is displayed in the app, carry out the last steps in the Home Connect app.

Note: If you were not able to establish a connection, check whether your mobile end device is within range of your home network or is connected to this. Try connecting to the Home Connect app again.

Activating/deactivating Wi-Fi

If your appliance is already connected to your home network, you can activate or deactivate **Wi-Fi** on your appliance.

Ensure that you are in the Home Connect menu. → Page 33

1. Set the programme to position 4.

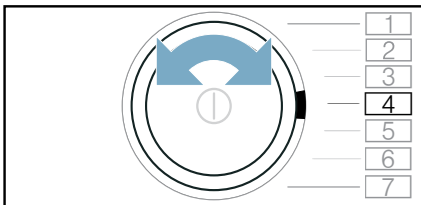

Wi-Fi (Wi-Fi function) appears in the display.

2. Press \triangleright .

If **on** appears in the display, Wi-Fi is activated on the appliance. If **off** appears in the display, Wi-Fi is deactivated on the appliance.

Notes

- If you connect to your home network, Wi-Fi is activated automatically.
- If Wi-Fi is activated, the appliance will not switch itself off automatically.
- If Wi-Fi is switched off on the appliance, it is not possible to use the Home Connect app to start or control the appliance remotely.
- If Wi-Fi is switched off and your appliance was previously connected to your home network, this connection will be re-established automatically when Wi-Fi is switched back on.
- If you activate this function, the energy consumption increases in comparison to the values specified in the consumption value table.
→ Page 60

Resetting your network settings

You can reset all of the network settings.

Ensure that you are in the Home Connect menu. → Page 33

1. Set the programme to position 5.

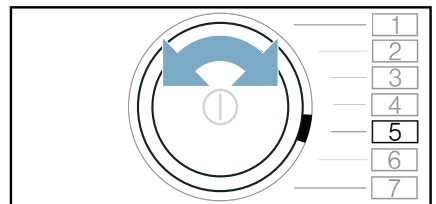

RES (reset network settings) appears in the display.

2. Press \triangleright .

YES appears in the display.

3. Press \triangleright \square .

Note: If you want to operate your appliance via the Home Connect app again, you will need to reconnect it to your home network and to the Home Connect app.

Updating the software

You can update the Home Connect software on your appliance. As soon as a new software update is available, a note appears in the display: *UPd*

Install the update directly via the **message in the display** or **manually** as follows:

Ensure that you are in the Home Connect menu. → *Page 33*

1. Set the programme to position 6.

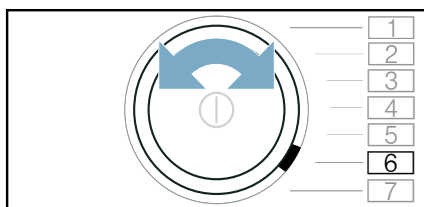

UPd (update) appears in the display. \triangleright \square (Start/Pause) flashes if a software update is available.

2. Press \triangleright \square .

YES appears in the display.

3. Press \triangleright \square .

Note: The software update may take several minutes. Do not switch the appliance off while updates are being installed.

Energy management

You can connect your appliance to your smart energy system (Energy manager).

Once you have connected your appliance to the smart energy system (Energy manager) and activated the **Flex start** function, you will be able to optimise your energy consumption because your appliance will not start up until your home photovoltaic system can provide sufficient energy or the energy tariff is good.

Further information and system requirements for using the Energy manager can be found at: www.home-connect.com/energymanagement

Notes

- The smart energy system (Energy manager) must use the EEBus initiative communications standard.
- Before you start, read the smart energy system instruction manual to find out how to connect your appliance to the smart energy system (Energy manager).

1. Set the programme to position 7.

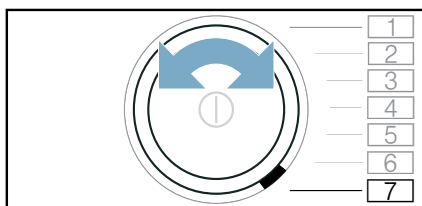

EnG (Energy manager) appears in the display.

2. Press \triangleright \square .

Your appliance now attempts to connect to the smart energy system (energy manager). If the appliance has connected successfully, *con* appears in the display.

3. Activate Flexstart if you want the smart energy system (Energy manager) to start up your appliance.

Flex start

Activate the **Flex start** function to allow your smart energy system (Energy manager) to start your appliance once your home photovoltaic system is able to provide sufficient energy or the energy tariff is good.

Note: Your smart energy system (Energy manager) cannot start your appliance until it is connected to the appliance.

Activate **Flex start** as follows:

1. Select the programme you require.
2. Use the + and - selection buttons for the "Finished in" time to set the required time.
3. Press ▷||| (Start/Pause).
4. Press □ (Remote Start).

⌚ appears in the display. The **FlexStart** function has now been activated and the appliance will wait to be remotely started by the smart energy system (Energy manager).

If the time changes on the display to 3.0h, for example, the smart energy system (Energy manager) has established a time at which your appliance can start. The programme will end after the specified time.

Notes

- If the smart energy system (energy manager) does not start your appliance, the programme will still be started before the set time period ends. The programme ends when the time period ends.
- For safety reasons, □ and, in turn, **Flex start** are deactivated in the following circumstances:
 - Press ▷||| .
 - Open the door.
 - Press ① to switch off the appliance.
 - Power failure.

If the **Flex start** function is deactivated, the - ⌚ + (Finished in) remains active.

Adding more laundry or removing laundry:

Note: If the **Flex start** function has already been activated but the programme has not yet started, you will still be able to load more laundry or remove some from the drum.

1. Press ▷||| (Start/Pause).
2. Open the door.
3. Add or remove laundry.
4. Close the appliance door.
5. Press ▷||| (Start/Pause).
6. Press □ (Remote Start).

The **FlexStart** function has now been activated and the appliance will wait to be remotely started by the smart energy system (Energy manager).

Intelligent program recommendation

After you have washed your laundry in the washing machine, the dryer will recommend a suitable program for drying your laundry.

The expected duration of the recommended program is determined based on the washing program you just used.



To determine the best drying program to use, your appliances must transmit and receive information.

Therefore please note the following:

- Before the data can be transmitted, the washing program must run through to the end.
- The washing machine must be Home Connect-capable.
- The washing machine and dryer must be connected to your home network and registered in your Home Connect app.

1. Switch on the appliance.
2. Set the program to **Smart Dry** ☼. The analysis starts and an animation appears in the display.

3. To cancel the analysis, set a different program or switch the appliance off. Once the right programme is found, the animation stops, the LED for the recommended programme lights up permanently and programme information is shown in the display.
4. Press  (Start/Pause).

Note: If a suitable program cannot be found, an audible signal will sound and   will appear on the display.

Possible reasons:

- No suitable drying programs could be found for the selected washing program.
- The washing machine and dryer must be connected to your home network and registered in your Home Connect app.
- Check whether your appliances are within range of your home network.
- No data is available for the last wash program used. The data is stored for 24 hours and then deleted.
- The washing program was aborted. The washing program must run through to the end.

Remote diagnostics

If a fault occurs, the after-sales service can use remote diagnostics to access your appliance.

Contact the after-sales service, making sure that your appliance is connected to the Home Connect server and checking that the remote diagnostics service is available in your country.

Note: For more information and to check whether the remote diagnostics service is available in your country, please visit the Help & Support area of the Home Connect website for your country: www.home-connect.com

Information on data protection

When your appliance is connected for the first time to a Wi-Fi network, which is connected to the Internet, your appliance transmits the following categories of data to the Home Connect server (initial registration):

- Unique appliance identification (consisting of appliance codes as well as the MAC address of the installed Wi-Fi communication module).
- Security certificate of the Wi-Fi communication module (to ensure a secure data connection).
- The current software and hardware version of your household appliance.
- Status of any previous resetting to factory settings.

This initial registration prepares the Home Connect functions for use and is only required when you want to use these Home Connect functions for the first time.

Note: Ensure that the Home Connect functions can be used only in conjunction with the Home Connect app. Information on data protection can be accessed in the Home Connect app.

Declaration of Conformity

Robert Bosch Hausgeräte GmbH hereby declares that the appliance with Home Connect functionality meets the basic requirements and other relevant provisions of the Directive 2014/53/EU.

A detailed RED Declaration of Conformity can be found online at www.bosch-home.com among the additional documents on the product page for your appliance.



2.4 GHz band: max. 100 mW
5 GHz band: max. 100 mW

	BE	BG	CZ	DK	DE
	EE	IE	EL	ES	FR
	HR	IT	CY	LV	LT
	LU	HU	MT	NL	AT
	PL	PT	RO	SI	SK
	FI	SE	UK	NO	CH
	TR				

5 GHz Wi-Fi: for indoor use only

Crease-removal function

This appliance has programs for removing creases from dry clothing that has not been worn for long and for reducing odours.

Notes

- See the laundry tips. → *Page 26*
- Wash clothing with traces of perfume, deodorant or sweat before wearing again.
- Do **not** run a crease-removal program with the following items:
 - Items made from wool, leather, viscose, or featuring metal, wooden or plastic parts.
 - Waxed and oiled jackets.
- Do not use dryer cleaning sets.

Filling the water tank

Your appliance uses cold drinking water to remove creases from dry clothing that has not been worn for long. Use the water jug provided to pour the water into the filling hole in the front of the appliance.

Caution!

Risk of material damage and damage to the appliance

Fluff may remain in the appliance or the appliance may be damaged by deposits or debris if drinking water is not used for crease removal.

- Always use cold drinking water for crease removal.
 - Do not use condensed water, distilled water, additives or descaler.
1. Select the required crease-removal program. → *"Overview of programmes" on page 22*
 2. Configure the settings for the required crease-removal program.
 3. Press  (Start/Pause).

4. ☹ will appear on the display.
Note: If ☹ does not appear on the display, the water tank is already filled with the correct amount of water and the program will start.
5. Pull out the condensation container horizontally.

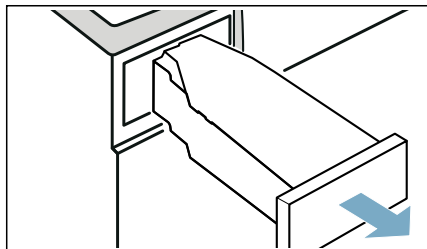

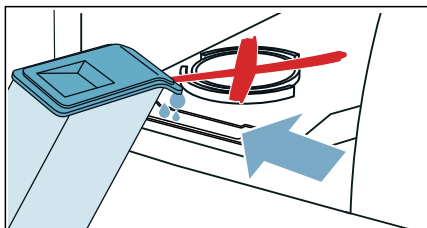

6. Use the water jug provided to pour approx. 180 ml cold drinking water into the filling hole in the **front** of the appliance, until ☹ goes out on the display and an audible signal sounds.

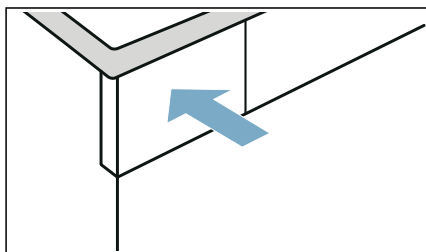

Note: If you pour more than 180 ml drinking water into the appliance and ☹ does not go out on the display, this means that the drinking water has been poured into the wrong filling hole or the appliance is not fully level. Pour the drinking water into the filling hole on the front or make the appliance level.
→ "Installing the appliance" on page 13

7. Push the condensation container back into the appliance until you feel it lock into place.



8. Press  (Start/Pause).

Programs for removing creases

- Do not run crease-removal programs without a load in the drum. Comply with the washing instructions on the clothing label and do not exceed the maximum permitted load for the crease-removal programs. → Page 22
- Opening the door during a crease-removal program pauses the program. To resume the program, close the door and press  (Start/Pause).
- Crease-removal programs run for approx. 45 minutes on average. They may run for longer at low ambient temperatures; at high ambient temperatures, the run time may be reduced.
- There may be some extra noise when a crease-removal program is running.
- Crease removal results may vary depending on the type of fabric, the amount of laundry and the selected program. For best results, take the laundry out of the machine as soon as the program comes to an end, hang it on a clothes hanger to finish drying and reshape it while still damp.

Cleaning the filter in the water tank

The filter in the water tank protects the appliance from dirt and debris and should be cleaned regularly.

Caution!

Risk of material damage and damage to the appliance

If you operate the appliance without a filter or if the filter is defective, this may result in damage to the appliance. Always ensure that the filter is in place and is undamaged before operating the appliance.

1. Pull out the condensation container horizontally.

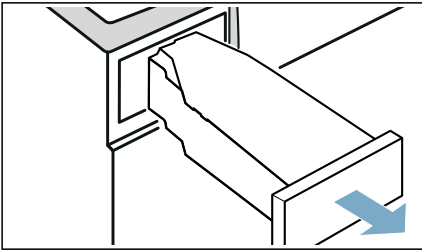

2. Remove the filter and clean it under running water or in the dishwasher.

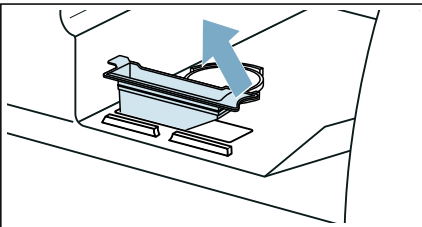

3. Insert the filter into the water tank.
4. Push the condensation container back into the appliance until you feel it lock into place.

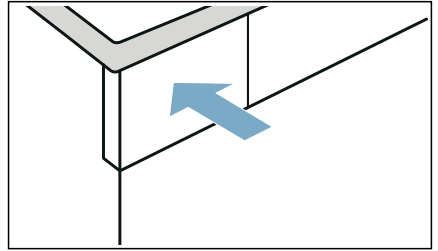



Draining the condensation water

Condensation will form in the appliance as it dries the laundry.

You must ensure that the drain hose is connected when you operate the appliance.

If there is no drain hose connected to the appliance, the condensation water from the appliance will run into the condensation container. In this case, you will need to empty the condensation container each time the dryer finishes drying the laundry, and also if it becomes full before drying is complete.

Connect the drain hose as follows:

1. Remove any accessories from the drum.

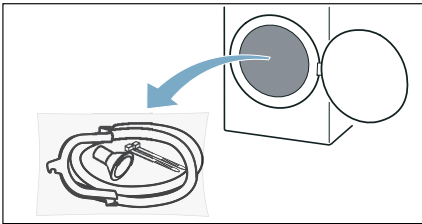

2. Remove all items from the bag.

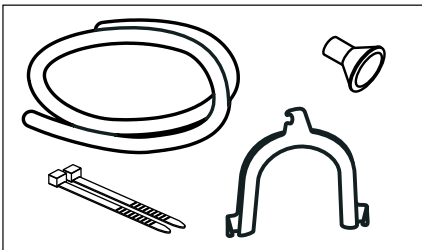

3. Detach the condensation hose from the socket.

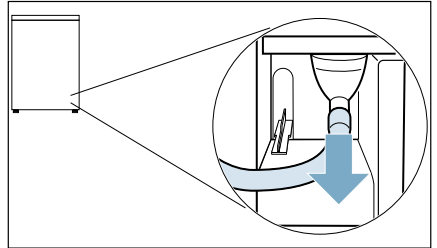

Note: The appliance comes delivered with the condensation hose already fitted to the socket.

4. Place the condensation hose in the "parked" position.

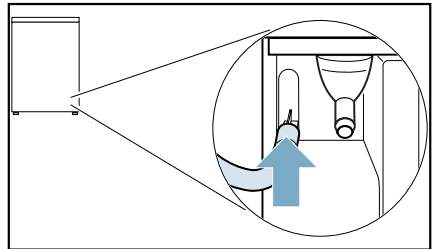

5. Take the drain hose from the accessories and attach it to the free socket, pushing it up to the stop.

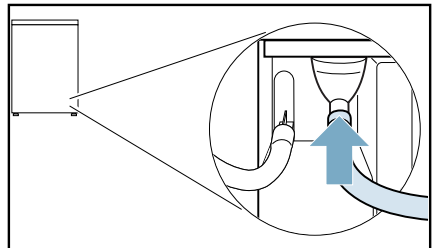

- Secure the other side of the drain hose using the remaining accessories, depending on the connection situation.

Washbasin:

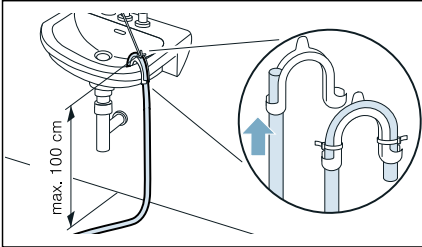

Siphon:

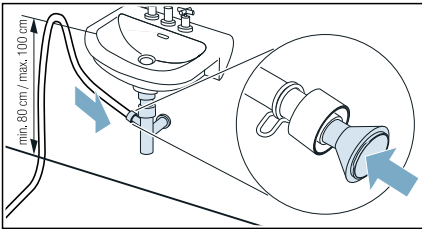

The connection point must be secured using a hose clamp (12-22 mm clamping range, available from specialist retailers). When connecting to a siphon, make sure that the drain hose is routed at a height of at least 80 cm, but no more than 100 cm.

Tip: Y-connection adapter for the water outlet

If you have a washing machine connected to the same outlet, you can secure the water outlet hose and the drain hose (from the connection kit) to the adapter on the drain.

Order number: **15000490**

Floor drain:

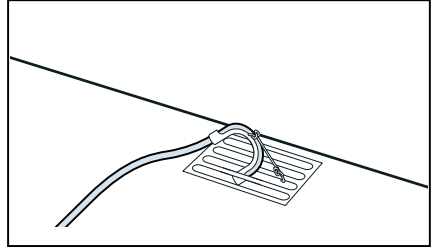

Caution!

Risk of material damage due to leaks or draining water.

Secure the drain hose to prevent it from slipping out. Do not kink or bend the drain hose. The height difference between the surface on which the appliance is installed and the drain hose must be no more than 100 cm.

Caution!

Risk of accumulated water being drawn back into the appliance and causing material damage.

Check that the water drains away quickly. The drain must not be sealed or blocked.

- Pull out the condensation container horizontally and empty it.

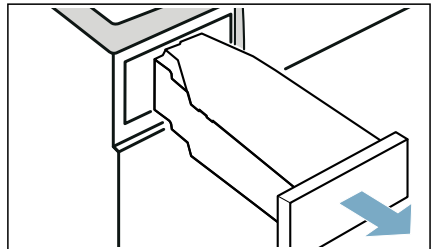

en Draining the condensation water

8. Turn the condensation container 180° onto its underside and remove the stopper that is fitted.

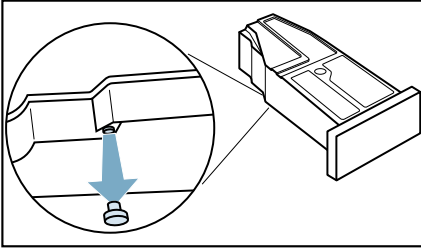

9. Turn the condensation container 180° again and insert the stopper into the recess in the top of the condensation container.

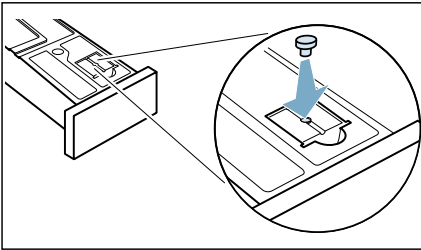

10. Slide in the condensation container until it clicks into place.

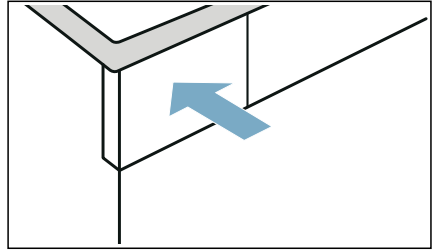

The condensation water is now discharged via the drain hose into the waste-water system or into a washbasin.

Note: If you want to drain the condensation water back into the condensation container, reverse these steps.

Caution!
Risk of material damage/damage to the appliance

If you are draining condensation water into the condensation container, liquid may issue from the socket and cause material damage. Before using the appliance, plug the cap into the socket.



Cleaning and maintenance

Cleaning the appliance



Warning **Risk of death!**

The appliance is powered by electricity. There is a risk of electric shock if you come into contact with live components. Therefore please note:

- Switch off the appliance. Disconnect the appliance from the power supply (pull out the plug).
- Never take hold of the mains plug with wet hands.
- When removing the mains plug from the socket, always take hold of the plug itself and never the mains cable, otherwise this may damage the mains cable.
- Do not make any technical modifications to the appliance or its features.
- Repairs and any other work on the appliance must only be conducted by our customer service or by an electrician. The same applies for replacing the mains cable (when necessary).
- Spare mains cables can be ordered from our customer service.



Warning **Risk of poisoning!**

Poisonous fumes may be given off by cleaning agents that contain solvents, e.g. cleaning solvent. Do not use cleaning agents that contain solvents.



Warning **Risk of electric shock/material damage/damage to the appliance!**

If moisture penetrates the appliance, this may cause it to short circuit. Do not use a pressure washer, steam cleaner, hose or spray gun to clean your appliance.

Caution!

Material damage/damage to the appliance

Cleaning agents and agents for pretreating laundry (e.g. stain removers, prewash sprays, etc.) may cause damage if they come into contact with the surfaces of the appliance. Therefore please note:

- Do not allow these agents to come into contact with the surfaces of the appliance.
- Clean the appliance with nothing but water and a soft, damp cloth.
- Remove any detergent, spray or other residues immediately.

Cleaning the base unit

This appliance is equipped with automatic self-cleaning. Fluff from the laundry does not have to be removed after each use – it is collected in the base unit.

In order to not adversely affect the operation of the appliance, you **must** clean the base unit (fluff collector and fluff filter) only in the following cases:

- The following message appears in the display:
- Before running the appliance care programme.

As an option, you can clean the appliance's base unit at any time.

Note: Allow the appliance to cool down for approximately 30 minutes after use before commencing cleaning.

Clean the base unit as follows:

1. Open the maintenance flap by the handle.

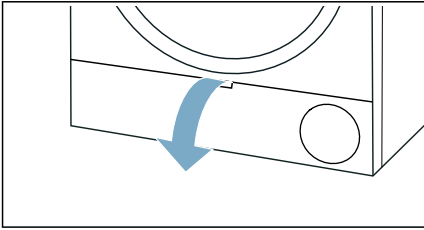

2. Unlock the levers on the heat exchanger cover.

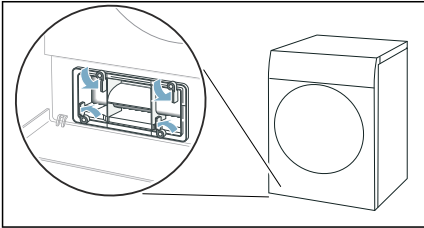

3. Pull the heat exchanger cover out by its grip.

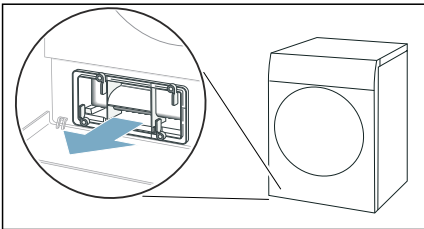

4. Remove all of the fluff from the heat exchanger cover and remove the fluff filter.

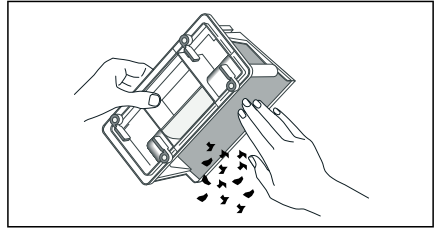

Note: Ensure that no dirt remains on the seals of the heat exchanger cover.

5. Rinse the inside of the heat exchanger cover and the fluff filter thoroughly under running water and dry them.

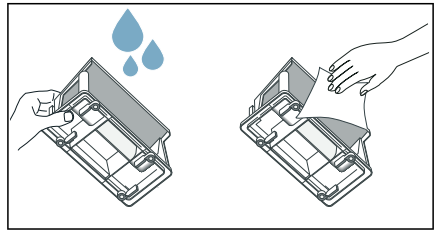

Notes

- You can use a soft brush to clean off more stubborn dirt.
- Make sure you dry the fluff collector's filter thoroughly after rinsing it. If the fluff filter is damp, this may increase the drying time and affect the drying result.

6. Pull the fluff collector out horizontally.

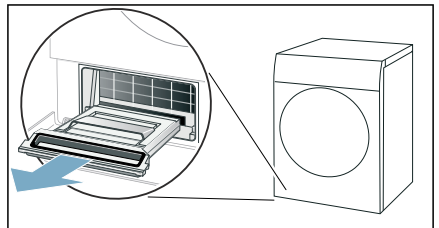

Note: The fluff collector may contain fluff and residual water, which may drip out of it when you pull it out.

7. Open the fluff collector and remove any fluff.

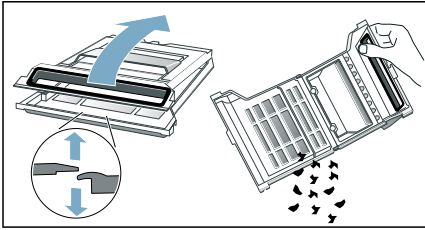

8. Rinse the fluff collector's filter thoroughly under running water and dry it.

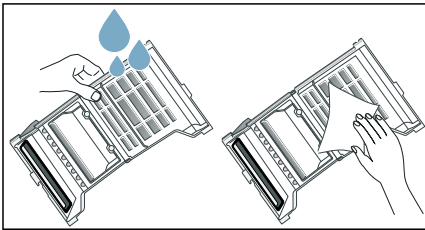

Notes

- You can use a soft brush to clean off more stubborn dirt.
- You must not remove or damage the fluff collector's seal.
- You can also clean the fluff collector in the dishwasher.
- Make sure you dry the fluff collector's filter thoroughly after rinsing it.

9. Close the fluff collector.

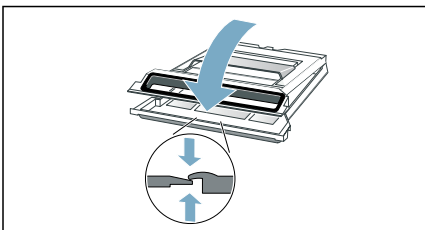

Note: Ensure that you close the fluff collector fully.

10. Slide the fluff collector in horizontally as far as it will go.

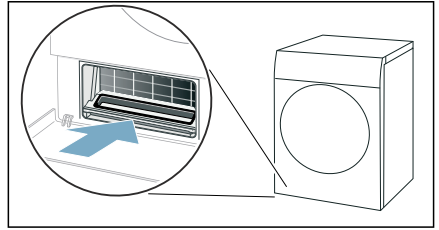

11. Slide the heat exchanger cover in by its grip.

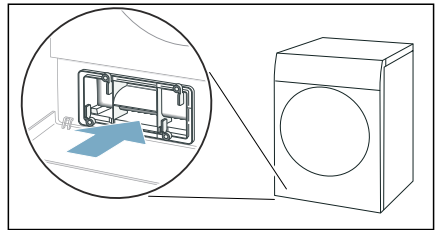

Note: You can only slide the heat exchanger cover in if the fluff collector is in the appliance.

12. Lock the levers on the heat exchanger cover.

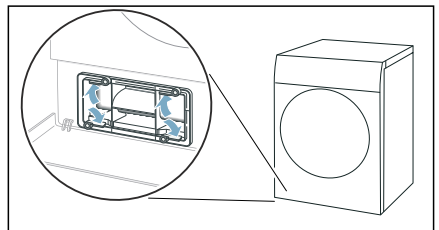

13. Close the maintenance flap.

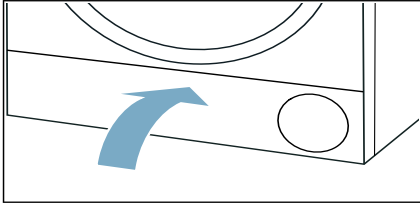

You have now finished cleaning the appliance's base unit.

Caution!
Material damage/damage to the appliance

If you operate the appliance without a fluff catcher (e.g. fluff filter, fluff depot, depending on appliance specifications), or if the fluff catcher is incomplete or defective, this may result in damage to the appliance.

Do not operate the appliance without a fluff catcher, or with a fluff catcher that is incomplete or defective.

Cleaning the moisture sensor

Note: The moisture sensor measures the amount of moisture in the laundry. After long periods of usage, the moisture sensor may become covered by a fine layer of limescale or detergent and care product residue. These deposits must be removed regularly, otherwise the drying results may not be optimal.

1. Open the door.

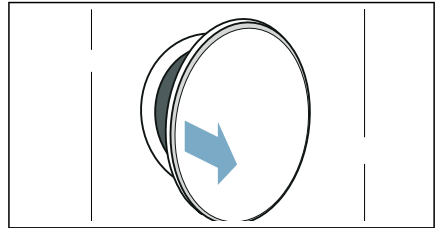

2. Clean the moisture sensor with a rough sponge.

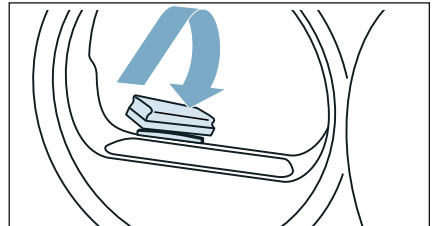

Caution!
Risk of damaging the moisture sensor.

The moisture sensor is made from stainless steel. Do not clean the sensor with abrasive cleaning products or wire wool.

Cleaning the filter in the condensation container

Note: The filter in the condensation container cleans the condensation water, which is used during the appliance's automatic cleaning cycle.

1. Pull out the condensation container horizontally.

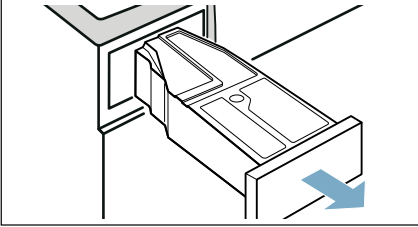

2. Pour out the condensation water.
3. Remove the filter.

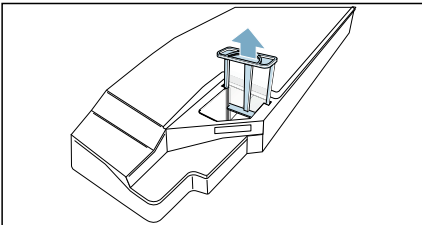

4. Clean the filter under warm, running water or in the dishwasher.

Note: You can use a soft brush to clean off more stubborn dirt.

5. Push the filter in until you feel it lock into place.

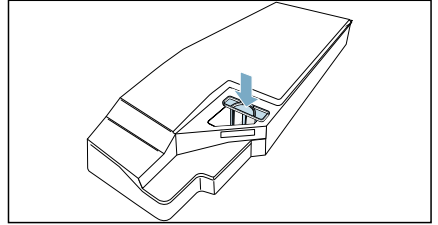

Caution!

If the filter is not inserted, fluff can find its way inside the appliance and damage it.

Only operate the appliance with the filter inserted.

6. Push the condensation container in until you feel it lock into place.



Appliance care

The appliance offers additional cleaning programmes that you can run for the maintenance of the appliance:

- You can use the basic appliance care to remove any light dirt deposits in the appliance.
- You can use the intensive appliance care to remove any stubborn dirt deposits in the appliance and any odours after an extended period.

Before running the appliance care programme, the appliance must be suitably prepared.



Warning

Risk of scalding/material damage/damage to the appliance!

Boiling or hot water can cause severe scalding as well as material damage and damage to the appliance if it is spilled or leaks out.

Do not use boiling water for this appliance or its components or accessories. Do not allow hot water or steam to come into contact with your skin.



Warning

Risk of poisoning/material damage!

Condensation water is not suitable for drinking and may be contaminated with lint. Contaminated condensation water may be hazardous to health and may cause material damage. Do not drink or reuse.

Preparing the appliance for appliance care

Preparing the appliance for appliance care

The appliance must be prepared **before** you can run a basic or intensive appliance care programme.

Prepare the appliance for appliance care as follows:

1. Clean the base unit. → *Page 45*
2. Open the door.
3. Remove the laundry.

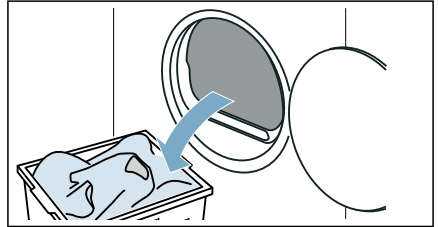

4. Close the appliance door.
5. Pull out the condensation container horizontally and empty it.

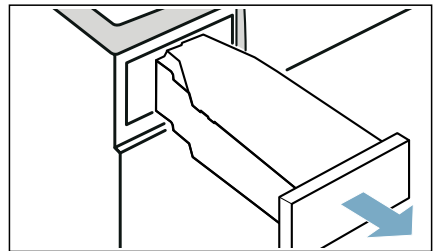

6. Press  to switch on the appliance.

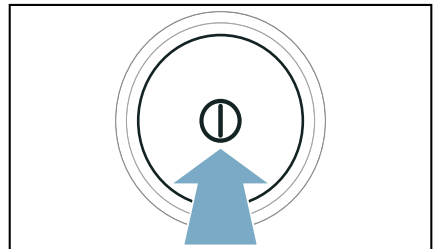

The appliance is now ready to run the appliance care programme.

Preparing the condensation container for appliance care

If you are draining the condensation water from the appliance using the drain hose, the condensation container must be prepared **before** the basic or intensive appliance care programme can be run.

Prepare the condensation container for appliance care as follows:

1. Remove the stopper inserted in the recess on the condensation container.

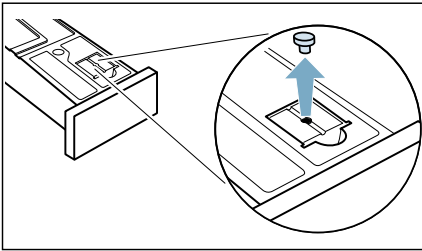

2. Turn the condensation container 180° onto its underside and insert the stopper.

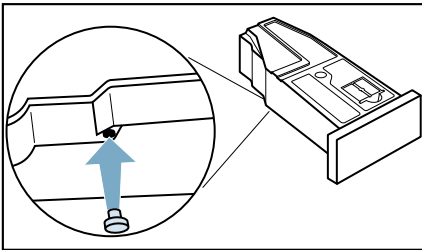

3. Clean the filter in the condensation container. → Page 49

The condensation container is now ready for the appliance care programme.

Note: . If you are draining the condensation water from the appliance using the drain hose, reverse these steps **after** running the basic or intensive appliance care programme.

Running the basic appliance care programme

To remove any dirt deposits in the appliance, you can run the basic appliance care programme.

Notes

- After a certain period, your appliance will automatically recommend that you run the basic appliance care programme. **Ⓛ-ⓔ** will then appear on the display for 5 seconds before the programme starts, and again once the programme ends. This message will appear repeatedly until you have run the basic appliance care programme through to the end.
- The basic appliance care programme runs for approximately one hour.

Run the appliance care programme as follows:

1. Prepare the appliance for appliance care. → Page 50
2. Set the programme to position 1.

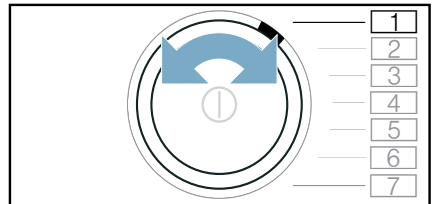

3. Press and hold  (Drying Target). At the same time:

4. Set the programme to position 4.

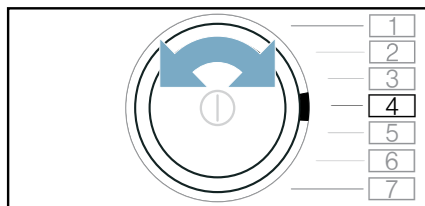

CP and the programme duration will now alternate on the display.

5. Pour approx. 1 ½ litre of warm tap water into the condensation container.

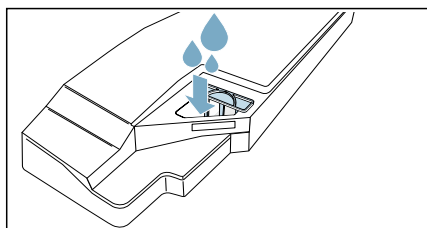

Note: Hold the full condensation container horizontally at all times so that no liquid spills out.

6. Slide in the condensation container until it clicks into place.

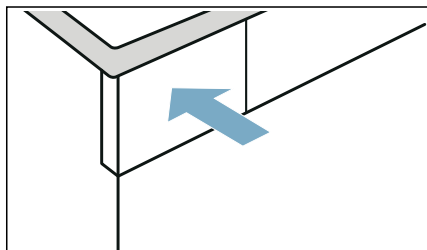

7. Press  (Start/Pause). The appliance care programme will start and an audible signal will sound. *End* will appear on the display once the appliance care programme has ended and an audible signal will sound.

8. Pull out the condensation container horizontally and empty it.

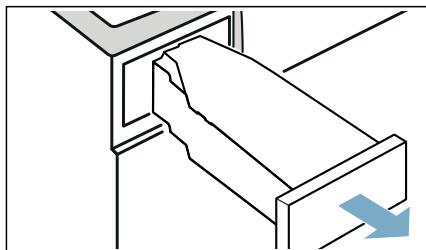

9. Slide in the condensation container until it clicks into place.

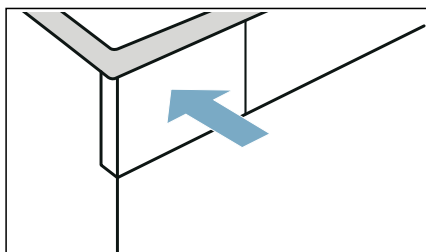

10. Press  to switch off the appliance.

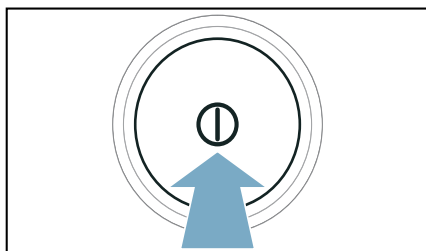

You have now completed the appliance care programme.

Running the intensive appliance care programme

You can run the intensive appliance care programme to remove any stubborn dirt deposits in the appliance and odours after a downtime of more than one month.

Notes

- The intensive appliance care programme runs for approximately 4 hours. The programme may take longer if you do not carry out the necessary steps in good time while the programme is running.
- Once it has started, the intensive appliance care programme should not be cancelled.
- When you run the intensive appliance care programme, you will need to use the original appliance care product. This can be ordered from our after-sales service using spare part number **00311829**. Contact information for all countries can be found in the enclosed after-sales service directory.

Warning

Risk of injury/material damage/damage to the appliance!

The use of spare parts and accessories supplied by other brands is dangerous and may result in injury, material damage or damage to the appliance. For safety reasons, use genuine spare parts and accessories only.

Caution!

Material damage/damage to the appliance

If you pour the wrong quantity of detergent or cleaning agent into the appliance, this may result in material damage or damage to the appliance. Use detergents/care products/cleaning agents and softeners in accordance with the manufacturers' instructions.

Run the appliance care programme as follows:

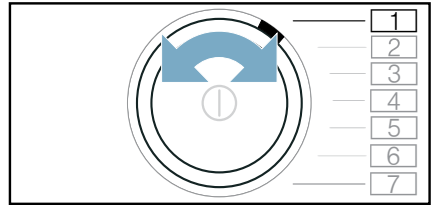

1. Prepare the appliance for appliance care. → Page 50
2. Set the programme to position 1.

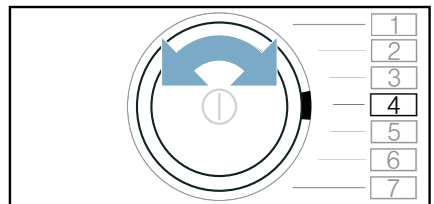

3. Press and hold  (Drying Target). At the same time:
4. Set the programme to position 4.



 and the programme duration will now alternate on the display.

5. Press .
-  and the programme duration now alternate in the display.
6. Pull out the condensation container horizontally and empty it.

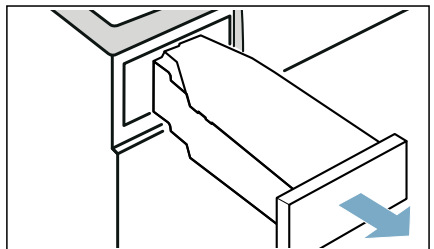

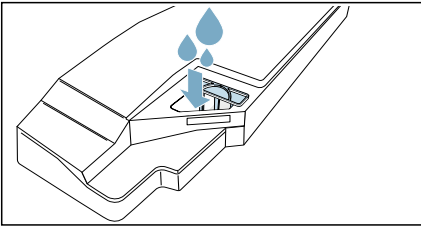

7. Pour a bottle of the original appliance care product and approx. 1 ½ litre of warm tap water into the condensation container.

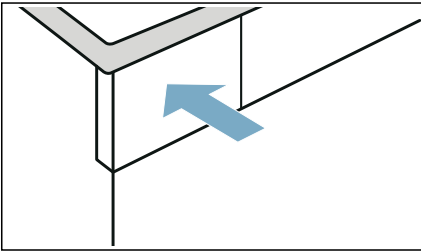

Note: Hold the full condensation container horizontally at all times so that no liquid spills out.

8. Slide in the condensation container until it clicks into place.



9. Press  (Start/Pause). The appliance care programme will start and an audible signal will sound. After approx. three hours, the appliance pauses the appliance care programme and the remaining programme duration flashes in the display.

10. Pull out the condensation container horizontally and empty it.

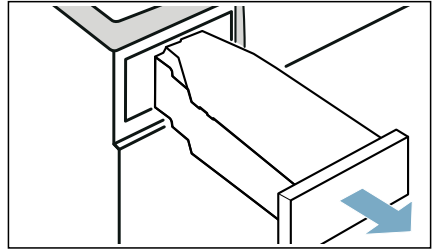

11. Pour approx. 1 ½ litre of warm tap water into the condensation container.

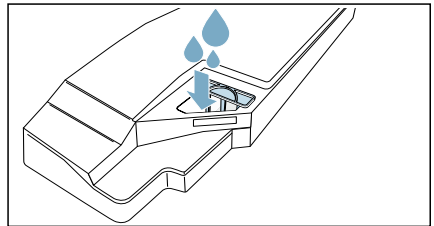

Note: Hold the full condensation container horizontally at all times so that no liquid spills out.

12. Carefully swing the condensation container round horizontally and empty it to dispose of any remaining original appliance care product.

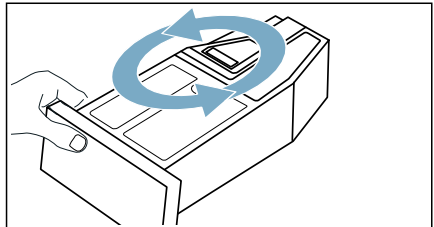

13. Pour approx. another 1 ½ litre of warm tap water into the condensation container.

14. Slide in the condensation container until it clicks into place.

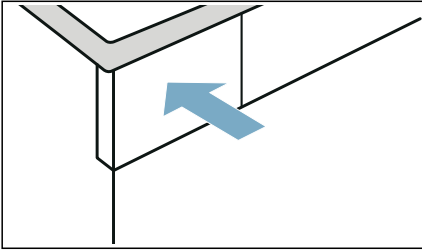

15. Press  (Start/Pause).
The appliance care programme will then be resumed.
End will appear on the display once the appliance care programme has ended and an audible signal will sound.

16. Empty the condensation container again.
17. Slide in the condensation container until it clicks into place.

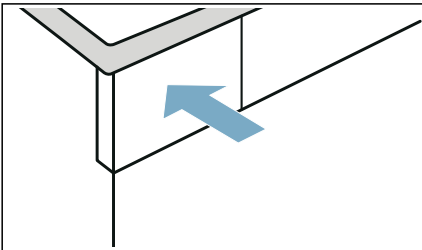



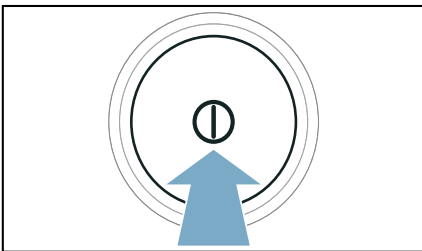

18. Press  to switch off the appliance.



You have now completed the appliance care programme.

Help with the appliance

Faults	Cause/Remedy
Appliance does not start	Check the mains plug and the fuses.
The appliance does not respond to inputs and the display shows:  R Ir	<ul style="list-style-type: none"> ■ If there is fluff or debris in the fluff filter or if the fluff filter is damp, this may impair the airflow in the appliance at low ambient temperatures. <ul style="list-style-type: none"> - Clean the base unit and dry the fluff filter thoroughly. → <i>Page 45</i> - Switch the appliance off and on again. - Press  (Start/Pause) to restart the programme.
Creasing.	<ul style="list-style-type: none"> ■ Load exceeded or incorrect programme selected for a type of fabric. All the required information can be found in the programme table. → <i>Page 22</i> ■ Remove laundry from the drum as soon as the drying programme has finished. Creasing occurs when clothing is left in the drum.
Water is leaking out.	<ul style="list-style-type: none"> ■ The appliance may be positioned at an angle. Level the appliance. ■ In the base unit, make sure that: <ul style="list-style-type: none"> - The heat exchanger cover is properly locked. - There is no dirt or debris on the heat exchanger cover's seal. → <i>Page 45</i> ■ If the optional drain hose* is installed, make sure that the drain hose is correctly connected. → <i>Page 42</i>
The appliance is paused but the drum is turning.	The appliance has detected a high temperature and has started the CoolDown process. Temperature regulation can take up to 10 minutes. You can cancel the CoolDown process at any time by opening the door.
The programme does not start	<p>Make sure that:</p> <ul style="list-style-type: none"> ■ The door is closed ■ The  3 sek. (Child Lock 3 sec.) has been deactivated ■ You have pressed  (Start/Pause) <p>Note: If the programme has been delayed by setting —  + (Finished in), the programme starts at a later point.</p>
Programme duration displayed changes as drying progresses.	Not a fault. The moisture sensor measures the residual moisture in the laundry and adjusts the programme duration (with the exception of timed programmes).

Laundry is not dried properly or is still too damp.	<ul style="list-style-type: none"> ■ After the programme has ended, warm laundry feels damper than it actually is. Spread out the laundry and let it cool down. ■ Adjust the drying time or increase the degree of dryness. This will extend the drying time but the temperature will remain the same. ■ Select a timed programme to add extra drying time for laundry that is still damp. ■ Select timed program for a small load and individual items of laundry. ■ Do not exceed the maximum load for a programme. → <i>Page 22</i> ■ Clean the moisture sensor in the drum. The sensor may become covered in a fine layer of limescale or detergent and care product residue, which then impairs its performance. → <i>Page 48</i> ■ Drying has been interrupted as a result of a power cut, because the condensation container is full or because the maximum drying time has been exceeded.
Note: See also the laundry tips. → <i>Page 26</i>	
Drying time too long.	<ul style="list-style-type: none"> ■ The appliance may have fluff in it. This will increase the required drying time. <ul style="list-style-type: none"> - Clean the base unit. → <i>Page 45</i> - Run a complete drying cycle with a load weighing more than 3 kg. Make sure the laundry has not been pre-dried. <p>Note: The appliance's automatic self-cleaning function uses the condensed water from your laundry. If you regularly dry loads weighing less than 3 kg or you regularly use the crease-removal function, there will not be enough condensed water from your laundry to run the appliance's automatic self-cleaning function. You should therefore dry loads weighing more than 3 kg on a regular basis, making sure that the laundry has not been pre-dried.</p> <ul style="list-style-type: none"> ■ The heat exchanger may have fluff in it. <ul style="list-style-type: none"> - Run the basic appliance care programme. → <i>Page 51</i> ■ If the fluff filter is damp, this may increase the drying time and affect the drying result. Dry the base unit's fluff filter thoroughly after rinsing it. → <i>Page 45</i> ■ If the air inlet on the appliance is blocked or not fully open, this may increase the drying time. Make sure the air inlet remains unobstructed. ■ If the ambient temperature is lower than 15 °C or higher than 30 °C, this may increase the drying time and affect the drying result. ■ If the air circulation in the room is inadequate, this may increase the drying time. Make sure the room is adequately ventilated.
Unpleasant odour in the appliance	Run the intensive appliance care programme. → <i>Page 53</i>
Humidity in the room is increasing.	Make sure the room is sufficiently ventilated.
Unusual noises when drying.	When drying is in progress, the pump and compressor generate noise when operating normally. This does not indicate that the appliance is malfunctioning.

The appliance feels cold despite drying.	Not a fault. The appliance can dry effectively at low temperatures using a heat pump.
Drying programme is stopped.	If the drying programme is stopped due to a power failure, restart the programme or remove the laundry and spread it out.
I am unable to connect to my home network.	<ul style="list-style-type: none"> ■ Wi-Fi is switched off. To connect to your home network, switch on Wi-Fi.  must appear on the display. ■ Wi-Fi is switched on but a connection to your home network cannot be established. Check whether your home network is available or try to connect to your home network again.
Home Connect is not working.	<ul style="list-style-type: none"> ■ You can find solutions to problems with Home Connect at www.home-connect.com. ■ The availability of the Home Connect functionality depends on the availability of the Home Connect Services (e.g. provision of the app) in your country. Home Connect Services are not available in every country – for further information please check: www.home-connect.com.
Water overflows when the water tank is filled.	<p>The water tank is completely full. Do not pour in any more water. It does not matter if a little water has already spilled over – there is no need for concern. → <i>"Filling the water tank"</i> on page 39</p> <p>The filter in the water tank may be blocked by deposits or debris. Remove the filter and clean it.</p>
The steam programs are taking too long.	Low ambient temperatures will extend the duration of the steam programs.
Residual water in the condensation container despite the appliance being connected to the drain hose*.	If the optional drain hose is installed, residual water remains in the condensation container due to the appliance's self-cleaning function.
* Depending on how the appliance is equipped or the available accessory	

Note: If you cannot rectify the fault yourself by turning the appliance off and then on again, please contact our after-sales service. → Page 62



Transporting the appliance

Warning

Risk of injury/material damage/damage to the appliance!

If you take hold of any of the appliance's protruding parts (e.g. the appliance door) in order to lift or move it, these parts may break off and cause injury. Do not take hold of any of the appliance's protruding parts in order to move the appliance.

Warning

Risk of injury!

- The appliance is very heavy. Lifting it may result in injury. Do not lift the appliance on your own.
- The appliance has sharp edges on which you could cut your hands. Do not take hold of the appliance by its sharp edges. Wear protective gloves to lift it.

Prepare the appliance for transportation as follows:

1. Pull out the condensation container horizontally and empty it.

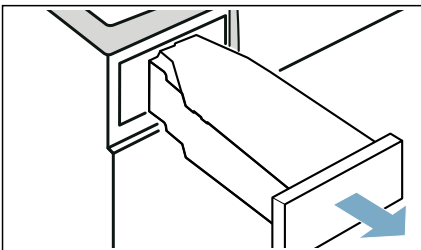

2. Push the condensation container back into the appliance until you feel it lock into place.

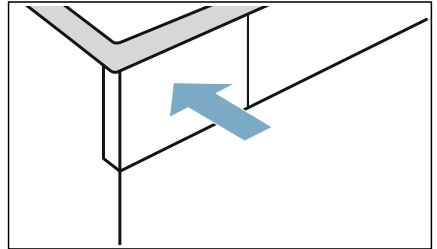

3. Switch on the appliance.
4. Set any programme.
5. Press **▷||** (Start/Pause).
6. Wait for 5 minutes. The condensation water will be drained.
7. Empty the condensation container again.
8. If installed, remove the drain hose from the washbasin, siphon or floor drain. → *Page 42*

Caution!

Secure the drain hose to the appliance to prevent it from slipping out. Do not kink the drain hose.

9. Switch off the appliance.
10. Disconnect the appliance's mains plug from the power supply.

The appliance is now ready to be transported.

Caution!



Risk of material damage/damage to the appliance

Despite draining, there will always be some residual water in the appliance. Any residual water may leak out and cause material damage.

The appliance should therefore be transported upright.

Consumption values

Consumption values table



Programme	Spin speed used for spinning the laundry (in rpm)	Duration** (in min)		Energy consumption** (in kWh)	
		9 kg	4.5 kg	9 kg	4.5 kg
Cotton		9 kg	4.5 kg	9 kg	4.5 kg
Cupboard Dry  *	1400	152	99	1.81	1.09
	1000	171	109	2.10	1.24
	800	190	119	2.39	1.39
Iron Dry  *	1400	115	74	1.24	0.73
	1000	134	84	1.53	0.88
	800	153	94	1.82	1.03
Easy Care		3.5 kg		3.5 kg	
Cupboard Dry  *	800	64		0.58	
	600	73		0.69	

* Programme setting in accordance with the applicable EN61121 standard when using the external drain hose.

** The values may differ from those specified, depending on the type of fabric, composition of laundry to be dried, residual moisture in the laundry, the degree of dryness that has been set, the amount of laundry being loaded, the environmental conditions, and any additional functions that have been activated.

Most efficient programme for cotton laundry

The "standard cottons programme" below (denoted by the  symbol) is suitable for drying cotton laundry with a normal dampness level, and is the most efficient programme for drying damp cotton laundry in terms of combined energy consumption.

Standard programmes for cottons in accordance with current EU regulation 932/2012			
Programme + dryness level	Load (in kg)	Energy consumption (in kWh)	Programme duration (in min)
 Cottons + Cupboard dry 	9/4.5	2.10/1.24	171/109

Programme setting for testing and energy labelling in accordance with Directive 2010/30/EU.



Technical data

Dimensions:

approx. 850 x 600 x 650 mm
(height x width x depth)

Weight:

56 kg (depending on the model)

Mains connection:

Mains voltage 220 - 240 V, 50 Hz

Nominal current 10 A

Nominal power 800 W

Maximum load:

9 kg

Power consumption when switched off:

0.10 W

Power consumption when left on:

0.10 W

Drum interior light*

Ambient temperature**



5 - 35°C

Power consumption when networked (Wi-Fi) in standby mode/duration:

1.2 W / 20 mins

This product contains light sources from energy efficiency class F. These light sources are available as a spare part and must only be replaced by trained specialist staff.

* Depending on the appliance specifications

** At an ambient temperature below 16 °C, the  (Remote Start) function and the maximum duration of 24 hours can be limited for the  (Finished in) function.



Disposal



Dispose of packaging and the appliance in an environmentally responsible manner.

This appliance is labelled in accordance with the European Directive 2012/19/EU, which governs waste electrical and electronic equipment (WEEE). The directive provides a framework for the collection and recycling of old appliances, which is valid across the EU.

Caution!

Risk of fire/risk of poisoning/risk of material damage and damage to the appliance

The appliance contains R290, a refrigerant that is environmentally friendly but flammable. If it is not disposed of correctly, this may result in fire or poisoning.

Dispose of the appliance correctly and do not damage the pipes in the refrigerant circuit.



Customer Service

If you cannot rectify the error yourself by turning the appliance off and then on again, please contact our after-sales service. → Enclosed after-sales service directory or cover page

We will always find an appropriate solution and, where possible, prevent the need for an engineer to visit.

Please provide the after-sales service with the product number (E no.) and the production number (FD) of the appliance.

E-Nr. _____	FD _____
-------------	----------

E no. Product number
FD Production number

You can find this information,
*depending on the model:

On the inside of the door*/open service flap* and at the rear of the appliance.

You can trust in the manufacturer's expertise.

Contact us. This ensures that the repair is carried out by trained service engineers with genuine spare parts.



Thank you for buying a Bosch Home Appliance!

Register your new device on MyBosch now and profit directly from:

- **Expert tips & tricks for your appliance**
- **Warranty extension options**
- **Discounts for accessories & spare-parts**
- **Digital manual and all appliance data at hand**
- **Easy access to Bosch Home Appliances Service**

Free and easy registration – also on mobile phones:

www.bosch-home.com/welcome



Looking for help? You'll find it here.

Expert advice for your Bosch home appliances, need help with problems or a repair from Bosch experts.

Find out everything about the many ways Bosch can support you:

www.bosch-home.com/service

Contact data of all countries are listed in the attached service directory.

Robert Bosch Hausgeräte GmbH

Carl-Wery-Straße 34

81739 München, GERMANY

www.bosch-home.com



9001588705 (0011)

en

Free Manuals Download Website

<http://myh66.com>

<http://usermanuals.us>

<http://www.somanuals.com>

<http://www.4manuals.cc>

<http://www.manual-lib.com>

<http://www.404manual.com>

<http://www.luxmanual.com>

<http://aubethermostatmanual.com>

Golf course search by state

<http://golfingnear.com>

Email search by domain

<http://emailbydomain.com>

Auto manuals search

<http://auto.somanuals.com>

TV manuals search

<http://tv.somanuals.com>