

User's Manual

PCR-T285
PCR-T295
SE-S100

Electronic Cash Register

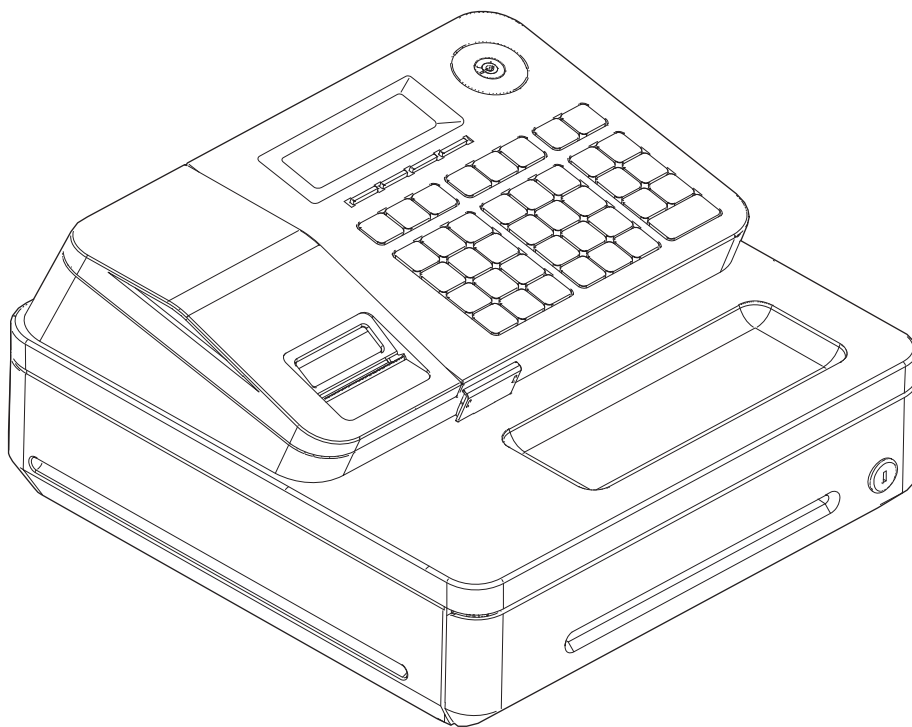

(S size drawer)

Introduction

Thank you very much for purchasing this CASIO electronic Cash Register. START-UP is QUICK and EASY!

For the basic settings of your Cash Register, please see "Quick Start Guide".

CASIO Authorized Service Centers

If your CASIO product needs repair, or you wish to purchase replacement parts, please visit <http://casio4business.com>.

Original Carton/Package

If for any reason, this product is to be returned to the store where purchased, it must be packed in the original carton/package.

Location

Locate the Cash register on a flat, stable surface, away from heaters or areas exposed to direct sunlight, humidity or dust.

Power Supply

Your Cash Register is designed to operate on standard household current (120 V, 220 V, 230 V, 240 V; 50/60 Hz). Do not overload the outlet by plugging in too many appliances.

Cleaning



Clean the Cash Register exterior with a soft cloth which has been moistened with a solution of a mild neutral detergent and water, and wrung out. Be sure that the cloth is thoroughly wrung out to avoid damage to the printer. Never use paint thinner, benzene, or other volatile solvents.

The mains plug on this equipment must be used to disconnect mains power. Please ensure that the socket outlet is installed near the equipment and shall be easily accessible.





To use the Cash Register safely	4
Precautions for Use.....	7
To use the Cash Register’s basic function	9
Getting to know your Cash Register.....	10
Getting started.....	15
Daily job flow	20
Before opening your store.....	21
Registering items	23
Corrections	32
Basic setups and operations.....	34
Daily sales reports	44
Advanced features	47
Receipt control	48
Character settings.....	49
Advanced programming	60
Tax table	71
Printing programmed data.....	72
To record business journal.....	75
To utilize an SD card	78
Calculator mode	81
Specifications	82
Appendix	83
Character code	84
Error code	85
About sales data storage in an SD card.....	86
Tax table programming	88
Index	92

To use the Cash Register safely

- Congratulations upon your selection of this CASIO product. Be sure to read the following safety precautions before using it for the first time. After reading this guide, keep it close at hand for easy reference.
- Please pay due attention to the following symbols to help you use the product safely and properly and to avoid any personal injury or damage to the product.

 Danger	If this symbol is ignored and the product consequently misused, it can result in serious personal injury and/or death.
 Warning	If this symbol is ignored and the product consequently misused, it may result in serious personal injury and/or death.
 Caution	If this symbol is ignored and the product consequently misused, it may result in personal injury and/or property damage.

The figures in this manual have the following meanings.

	This symbol means be careful = a warning. The example at left is a warning about an electrical shock.
	This symbol indicates something you must not do = prohibited action. The example at left means never disassemble the product.
	This symbol indicates something you must do = an instruction. The example at left indicates you should unplug the product from the outlet. Please note that instructions that are difficult to express by a figure are indicated by  .

Danger

If liquid that leaked from a battery gets in your eye, on your skin or clothes, deal with it immediately as follows.



1. Immediately rinse it off with lots of water.
 2. Immediately get medical treatment.
- Failing to act may result in a rash or loss of sight.

Warning



Handling the register







- Should the register malfunction, start to emit smoke or a strange odor, or otherwise behave abnormally, immediately shut down the power and unplug the AC plug from the power outlet. Continued use creates the danger of fire and electric shock. Contact CASIO service representative.

To use the Cash Register safely

Warning

-  Do not place containers of liquids near the register and do not allow any foreign matter to get into it. Should water or other foreign matter get into the register, immediately shut down the power and unplug the AC plug from the power outlet. Continued use creates the danger of short circuit, fire and electric shock. Contact CASIO service representative.
-  Should you drop the register and damage it, immediately shut down the power and unplug the AC plug from the power outlet. Continued use creates the danger of short circuit, fire and electric shock.
-  Attempting to repair the register yourself is extremely dangerous. Contact CASIO service representative.
- Never try to take the register apart or modify it in any way. High-voltage components inside the register create the danger of fire and electric shock. Contact CASIO service representative for all repair and maintenance.

Power plug and AC outlet

-  Use only a proper AC electric outlet. Use of an outlet with a different voltage from the rating creates the danger of malfunction, fire, and electric shock. Overloading an electric outlet creates the danger of overheating and fire.
-  Make sure the power plug is inserted as far as it will go. Loose plugs create the danger of electric shock, overheating, and fire.
- Do not use the register if the plug is damaged. Never connect to a power outlet that is loose.
-  Use a dry cloth to periodically wipe off any dust built up on the prongs of the plug. Humidity can cause poor insulation and create the danger of electric shock and fire if dust stays on the prongs.
-  Do not allow the power cord or plug to become damaged, and never try to modify them in any way. Continued use of a damaged power cord can cause deterioration of the insulation, exposure of internal wiring, and short circuit, which creates the danger of electric shock and fire. Contact CASIO service representative whenever the power cord or plug requires repair or maintenance.

Caution

-  Do not place the register on an unstable or uneven surface. Doing so can cause the register - especially when the drawer is open - to fall, creating the danger of malfunction, fire, and electric shock.

Do not place the register in the following areas.





-  Areas where the register will be subject to large amounts of humidity or dust, or directly exposed to hot or cold air.
- Areas exposed to direct sunlight, in a close motor vehicle, or any other area subject to very high temperatures.

The above conditions can cause malfunction, which creates the danger of fire.

-  Do not overlay bend the power cord, do not allow it to be caught between desks or other furniture, and never place heavy objects on top of the power cord. Doing so can cause short circuit or breaking of the power cord, creating the danger of fire and electric shock.

To use the Cash Register safely



Caution

-  • Be sure to grasp the plug when unplugging the power cord from the wall outlet. Pulling on the cord can damage it, break the wiring, or cause short, creating the danger of fire and electric shock.
-  • Never touch the plug while your hands are wet. Doing so creates the danger of electric shock. Pulling on the cord can damage it, break the wiring, or cause short, creating the danger of fire and electric shock.
-  • At least once a year, unplug the power plug and use a dry cloth or vacuum cleaner to clear dust from the area around the prongs of the power plug.
Never use detergent to clean the power cord, especially power plug.
-  • Keep small parts out of the reach of small children to make sure it is not swallowed accidentally.

Only use the specified batteries.

-  • Do not disassemble, modify or short-circuit them.
- Do not put them in fire or water or heat them.
- Do not mix new and old batteries or different types of batteries.
- Orient the terminals +- correctly.
- Remove the batteries if the system will not be used for a long time.
- After batteries are spent, dispose of them as per local regulations.
- Do not try to recharge dry cell batteries.

Disposing of batteries:

-  • Make sure that you dispose of used batteries in accordance with the rules and regulations in your local area.
-  • Be careful not to cut your finger by the paper cutter.
-  • The cover or the plastic case for the terminal may discolor or damaged when thinner, gasoline, kerosene, various solvent, grease, any cleaner including them, adhesive, paint, medical agent, cosmetics, etc., are adhered. Please be cautious.

Precautions for Use

Notice

- Any copying of the contents of this manual, either in part or its entirety without the permission of CASIO COMPUTER CO., LTD is prohibited under copyright laws.
- The contents of this manual and specifications of this unit are subject to change without notice.
- In case the terminal malfunctions or for any question about the contents of this manual, please contact your local CASIO service center or CASIO COMPUTER CO., LTD.
- To prevent losing all your settings and sales data, we strongly recommend that you install the memory protection batteries before you use the Cash Register and replace them at least once a year.



SD and SDHC Logos are trademarks of SD-3C,LLC.

■ When the cash drawer does not open!

In case of power failure or the machine is in malfunction, the cash drawer does not open automatically. Even in these cases, you can open the cash drawer by pulling drawer release lever (see below).

Important

- The drawer will not open, if it is locked with a drawer lock key.

■ About drawer hook

Drawer hook prevents the Cash Register from falling caused by weight of coins.

Insert the drawer hook in the ditch of the drawer. Peel the release paper from the drawer hook and stick the drawer on the place where the register is installed.

As it may cause a malfunction of the drawer, please do not put coins and bills in the drawer excessively.

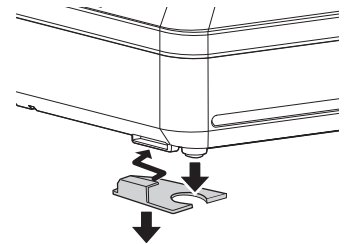
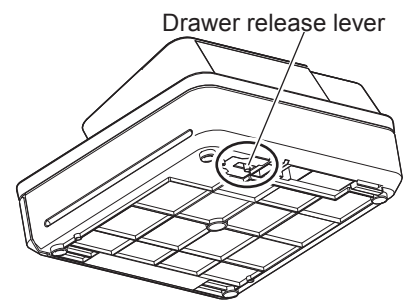

(S size drawer)

Precautions for Use



Manufacturer: CASIO COMPUTER CO., LTD.
6-2, Hon-machi 1-chome, Shibuya-ku, Tokyo 151-8543, Japan
Responsible within the European Union: CASIO EUROPE GmbH
CASIO-Platz 1, 22848 Norderstedt, Germany

Please keep all information for future reference.
The declaration of conformity may be consulted at <http://world.casio.com/>

Laite on liitettävä suojamaadoituskostkettimilla vaurstettuun pistorasiaan
Apparatet må tilkoples jordet stikkontakt
Apparaten skall anslutas till jordat nätuttag.

The main plug on this equipment must be used to disconnect mains power.
Please ensure that the socket outlet is installed near the equipment and shall be easily accessible.

WARNING

This is a Class A product. In a domestic environment this product may cause radio interference in which case the user may be required to take adequate measures.



This mark applies in EU countries only.

This product is also designed for IT power distribution system with phase-to-phase voltage 230 V.

GUIDELINES LAID DOWN BY FCC RULES FOR USE OF THE UNIT IN THE U.S.A. (Not applicable to other areas)

WARNING: This equipment has been tested and found to comply with the limits for a Class A digital device, pursuant to Part 15 of the FCC Rules. These limits are designed to provide reasonable protection against harmful interference when the equipment is operated in a commercial environment. This equipment generates, uses, and can radiate radio frequency energy and, if not installed and used in accordance with the instruction manual, may cause harmful interference to radio communications. Operation of this equipment in a residential area is likely to cause harmful interference in which case the user will be required to correct the interference at his own expense.

FCC WARNING: Changes or modifications not expressly approved by the party responsible for compliance could void the user's authority to operate the equipment.

To use the Cash Register's basic function

Getting to know your Cash Register	10
Name of Parts	10
Display	12
Keyboard	13
Getting started	15
To install memory protection batteries	15
To set a paper roll	16
To set the language, date, time, and tax rates	18
Daily job flow	20
Before opening your store	21
Checking the time and date.....	21
Setting date and time	21
Preparing bills and coins for change	22
Registering items	23
Simple registration	23
To register multiple items of the same price	25
Various payments.....	26
Discount	27
Quantity discount registration	28
Price reduction	29
Refund	30
To print reference numbers	31
Corrections	32
To correct erroneous item input before registration.....	32
To correct erroneous item input immediately after registration.....	33
Basic setups and operations	34
About HELP guidance.....	34
To preset discount rate to  key	35
To preset taxable statuses to departments	36
To preset unit price to each department	38
To preset item names to departments.....	39
To preset PLUs.....	41
Daily sales reports	44
To print sales reports.....	44

To use the Cash Register's basic function

Getting to know your Cash Register

Name of Parts

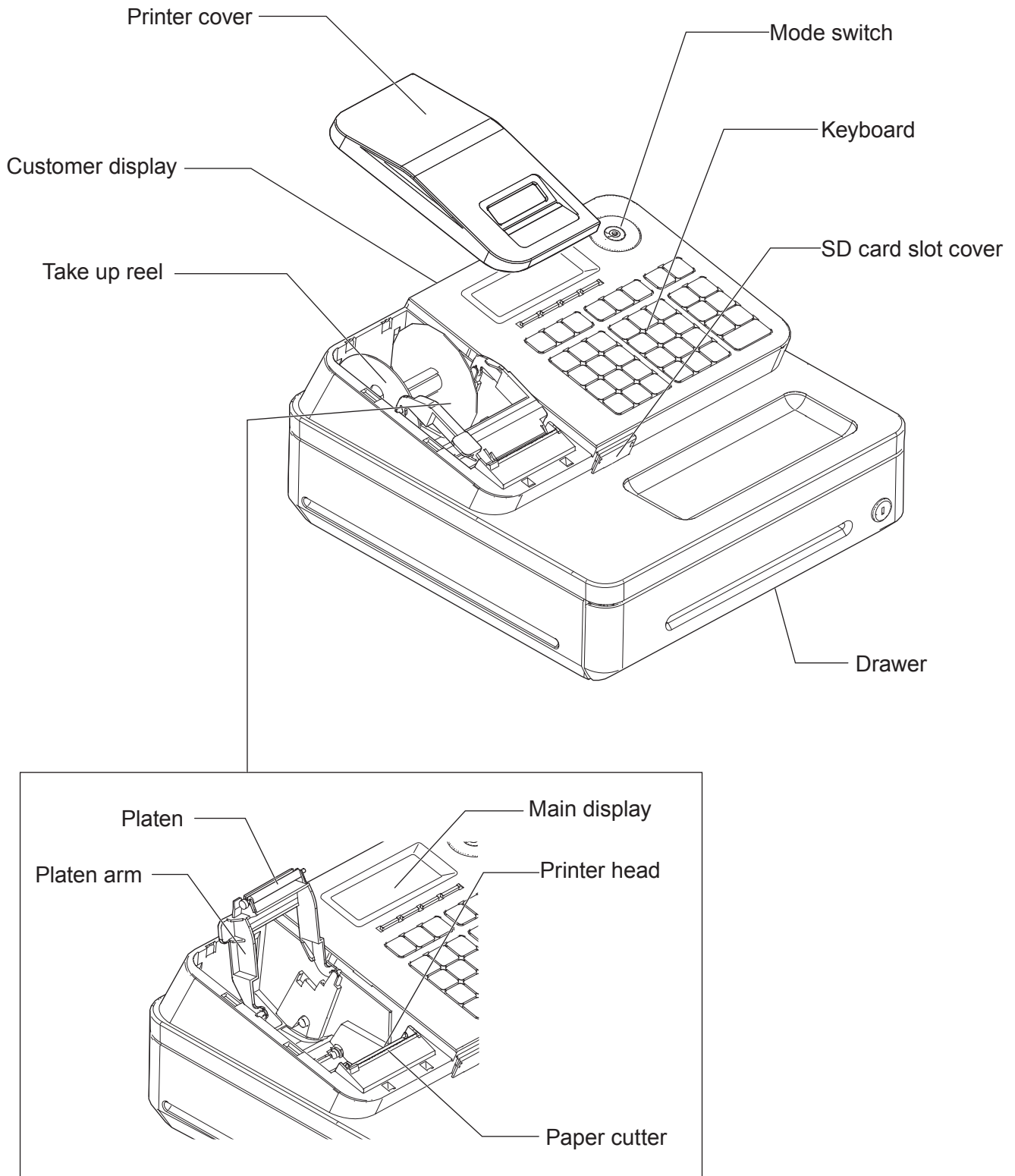

To use the Cash Register's basic function

■ Mode switch

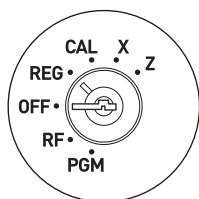

Use the mode keys to change the position of the Mode switch and select the mode you want to use.

PGM (Program)

This position is for setting your Cash Register to suit the needs of your store.

RF (Refund)

Use this position for registering returned goods or correcting registered items.

OFF

The Cash Register turns off in this position.

REG (Register)

Use this position for regular registrations.

CAL (Calculation)

Set to this position when you use the Cash Register as a calculator.

X (Read)

Use this position for issuing daily sales totals report without clearing the data.

Z (Reset)

This position is for issuing reports of daily totals with clearing the accumulated totals.

■ Mode keys

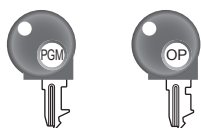

There are two types of mode keys. The program key marked "PGM" and the operator key marked "OP". The program key can set the Mode switch to any position, while the operator key can select only OFF, REG, and CAL positions.

	PGM	RF	OFF	REG	CAL	X	Z
OP key	-	-	○	○	○	-	-
PGM key	○	○	○	○	○	○	○

■ Drawer

The drawer opens automatically whenever you finalize a registration and whenever you issue a read or reset report. The drawer will not open if it is locked with the drawer key.

■ Drawer key

Use this key to lock and unlock the drawer.

■ Bill clip plate

Use this plate for tacking the notes received from customer.

To use the Cash Register's basic function

Display

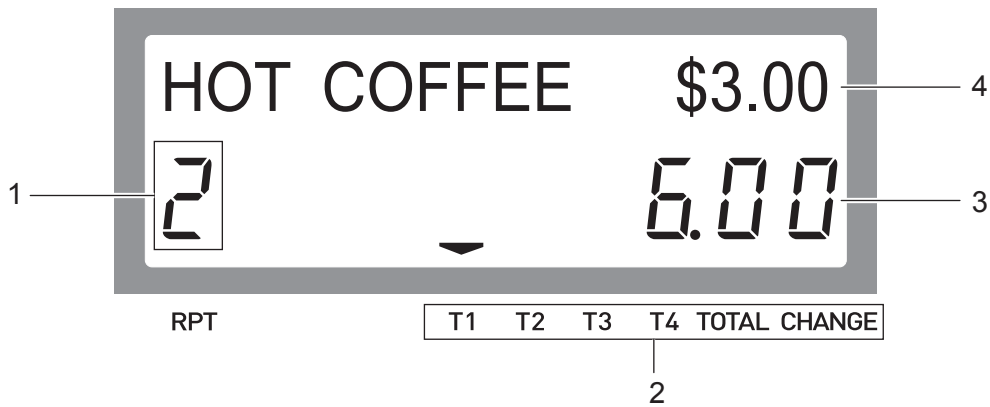





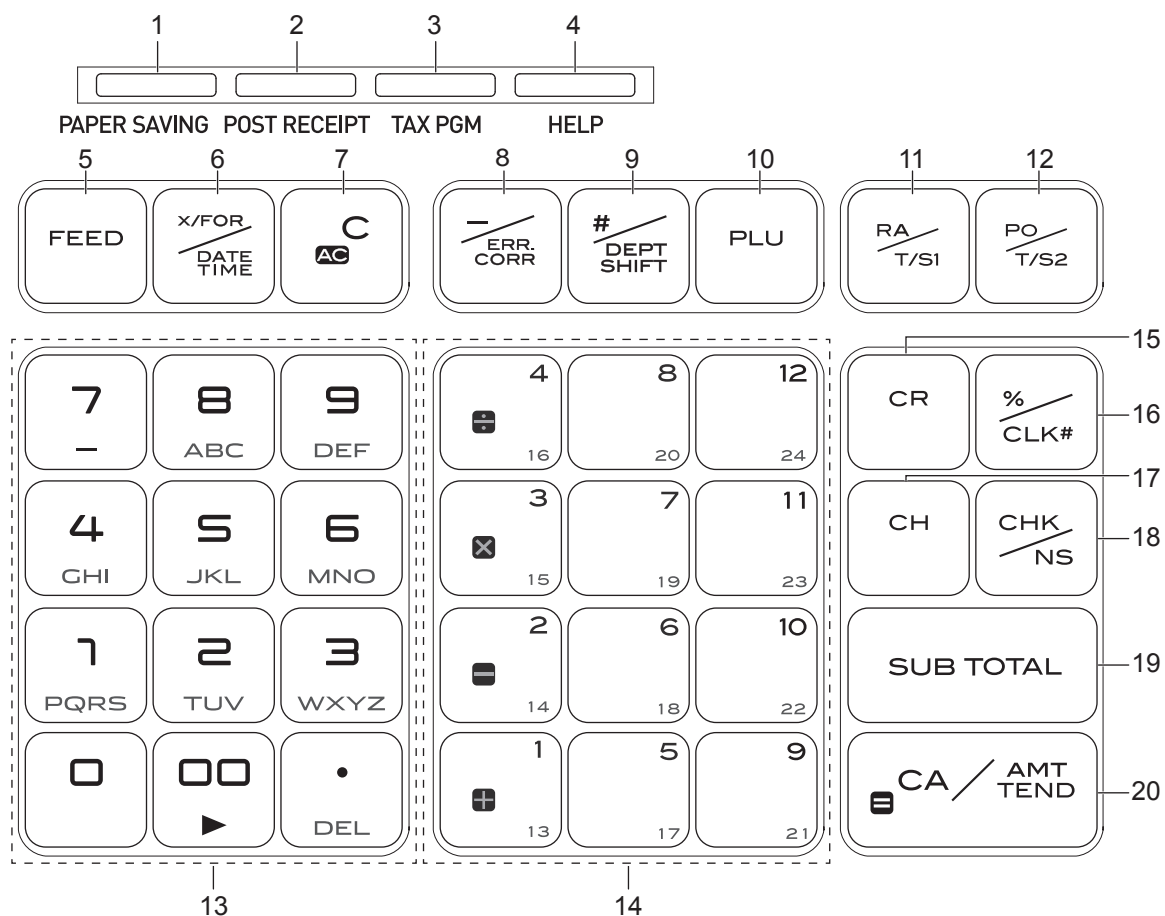

- | | |
|-------------------------|--|
| 1 Repeat counter | Indicates number of repetition for such case as multiple registration of a same item. |
| 2 Transaction indicator | Indicates the status of the displayed amount such as tax status, total amount, or change amount. |
| 3 7-segment display | Indicates amount. |
| 4 Dot matrix display | Indicates characters such as item names and prices. |













To use the Cash Register's basic function

Keyboard



- 1 [PAPER SAVING] Use this key to stop issuing receipts or compressed journal printing to save paper.
- 2 [POST RECEIPT] When the Register is set to not to print receipts, pressing this key prints a receipt of the preceding transaction.
- 3 [TAX PGM] Use this key to set tax statuses and tax tables.
- 4 [HELP] Use this key to print operation guidance.
- 5  Use this key to feed the paper.
- 6  Use this key to show present date and time. Also this key is used for multiplications.
- 7  Use this key to clear an entry that has not yet been registered.
- 8  Use this key to correct immediately preceding registration. Also this key is used for reducing price.
- 9  Department shift key. Using this key with departments 1 to 12 keys, items are registered in departments 13 to 24. Also this key prints preceding number entry without any registration.
- 10  Price look up key. Use this key to register preset items by number.
- 11  Use this key following a numeric entry to register money received by non-sale transactions.

To use the Cash Register's basic function

- 12  Use this key following a numeric entry to register money paid out from the drawer.
- 13  to    Ten-key. Use these keys for numeral entries.
- 14  to  Department keys. Use these keys to register items to the corresponding department.
- 15  Use this key for credit card payments.
- 16  Use this key for discounts. Also this key is used to sign a clerk on or off.
- 17  Use this key to register charge sales.
- 18  Use this key for check payments. Also this key is used for opening drawer.
- 19  Use this key to display and print the current subtotal amount.
- 20  Use this key to register cash sales.

To use the Cash Register's basic function

Getting started

This chapter explains how to set up the Cash Register and get it ready to operate.

To install memory protection batteries

Important

- These batteries protect information stored in your Cash Register's memory when there is a power failure or when you unplug the Cash Register. Be sure to install these batteries first.

1 Remove the printer cover by lifting it up.

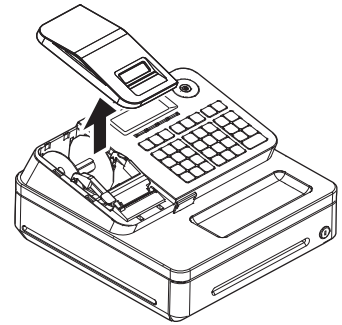

2 Remove the take up reel.

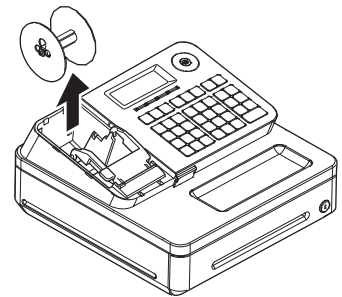

3 Remove the battery compartment cover and install two new "AA" type manganese batteries in the battery compartment over battery extraction ribbon.

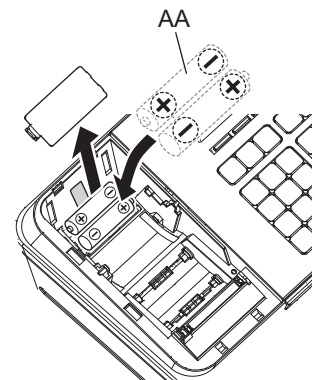

4 Replace the battery compartment cover. Please make sure that the battery compartment cover is fastened securely with a click sound.

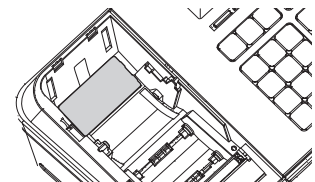

To use the Cash Register's basic function

Important

- Be sure that the plus (+) and minus (-) ends of the batteries are facing in the directions as indicated on the battery compartment.
- The Cash Register will show "LOW BATTERY" on the display when the batteries are running low on power. Install two new batteries when this occurs.

Warning

- Never try to recharge the batteries.
- Do not expose batteries to direct heat, let them become shorted or try to take them apart.
- Keep batteries out of the reach of small children. If your child should swallow a battery, consult a physician immediately.
- There is a risk of explosion if the batteries are replaced with improper type.
- Dispose used batteries according to the local rule.

To set a paper roll

This Cash Register is fitted with a thermal printer - only 58 mm wide thermal paper rolls can be used.

Caution (in handling the thermal paper)

- Never touch the printer head and the platen as they become hot.
- Be careful not to cut your finger with the paper cutter.

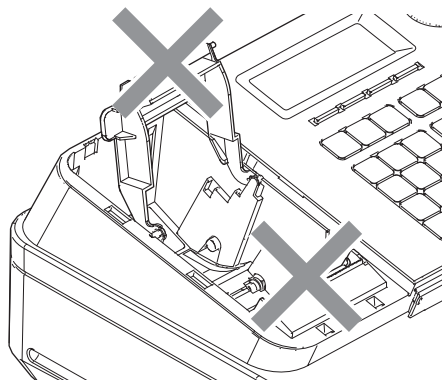

- Unpack the thermal paper just before your use.
- Avoid heat and direct sunlight.
- Avoid dusty and humid places for storage.
- Do not scratch the paper.
- Do not keep the printed paper under the following circumstances.

High humidity and temperature/direct sunlight/contact with glue, thinner or a rubber eraser.

To use the Cash Register's basic function

1 Open the platen arm by lifting it up slowly.

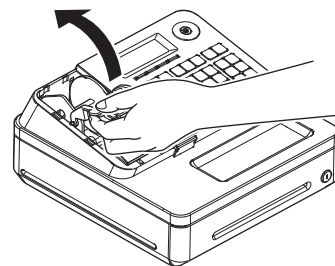

2 Hold the paper roll so that the end of the paper comes out from the bottom of the roll and place it behind the printer.

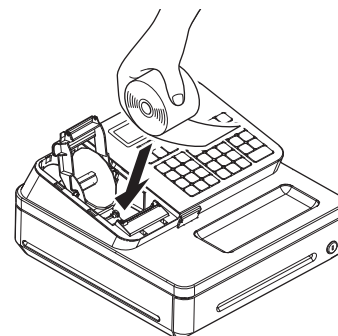

3 Place the end of the paper over the printer.

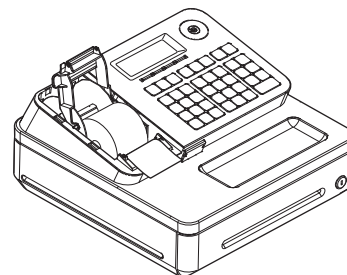

4 Close the platen arm slowly until it locks securely.

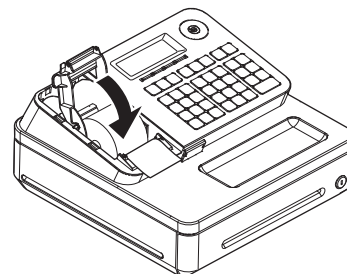

Important

- If the thermal paper roll is not properly installed, you will not be able to use the Cash Register. The display shows "E014 Paper end" to indicate that the paper is not inserted.
- If the display shows "E010 Close the platen arm", close the platen arm securely.

To use the Cash Register's basic function



To set the language, date, time, and tax rates

Important

- In each setting of date, time and tax rates, the Cash Register prints your settings. Make sure that the settings are correct. If you have made incorrect date and time setting, press  key. For other incorrect settings, pull out the AC cord, take out batteries, and start from the beginning.

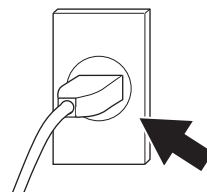
- 1** Plug in the power socket into a wall outlet. Be sure to check the rating plate on the side of the Cash Register to make sure that its voltage matches that of the power supply in your area.



- 2** As soon as you plug in the power cord, the printer prints instructions for selecting language (country). Input the language number and press  key. For example, If you wish to select English, press **0**  keys. For selecting Spanish, press **2**  keys.

```
PLEASE CHOOSE THE
LANGUAGE.
ENGLISH      :0<CA>
ESPAÑOL     :2<CA>
```

```
START RETURNING WITH
<C> WHEN CHANGE THE
LANGUAGE BY MISTAKE.
```



- 3** The printer prints the instructions for setting date and time, the top digit of the display flashes. Enter the date in order of month, day and year. For example, input 012115 for January 21, 2015.

```
MONTH
00-00-00
RPT          T1 T2 T3 T4 TOTAL CHANGE
```

- 4** Display changes for setting time. Enter the present hours and minutes in 24 - hour system. For example, 1300 for 1:00 pm.

Note: For Canadian model, proceed to step 7.

```
TIME SETTING
00-00
RPT          T1 T2 T3 T4 TOTAL CHANGE
```

- 5** After a few seconds, the printer prints "PLEASE INPUT TAX RATE". Input tax rate 1 and press . For example, press **5** and  keys for 5% tax rate 1.



```
PLEASE INPUT TAX RATE.
TAX RATE      :RATE+<CA>
EXIT          :<ST>
```

- 6** Repeat the same operation as step 5 for tax rates 2 and 3. Please do not forget the rates you have set, and be sure to preset the rates to departments explained in "To preset taxable statuses to departments" (page 36). If you wish to exit from the tax rates settings, press  key.



For US model, the basic settings have been completed.

Proceed to the next step for Canadian model.

To use the Cash Register's basic function

7 Canadian model only: As the printer prints "PLEASE SELECT TAX TABLE." and list of the states, choose your state and input the number of the state and press  key. For example, if you use the Cash Register in Alberta, press **1** and  keys. If you select "MANUAL ENTRY: 0 <CA>", input tax rates manually by following steps 5 and 6 and then proceed to step 8.

PLEASE SELECT TAX TABLE	
MANUAL ENTRY	: 0<CA>
Alberta	: 1<CA>
British Columbia:	2<CA>
Manitoba	: 3<CA>
New Brunswick	: 4<CA>
Newfoundland	: 5<CA>
Nova Scotia	: 6<CA>
Ontario	: 7<CA>
Prince Edward	: 8<CA>
Quebec	: 9<CA>
Saskatchewan	: 10<CA>
Yukon	: 11<CA>
Northwest	: 12<CA>
Nunavut	: 13<CA>

8 Canadian model only: The printer prints "DO YOU USE CANADIAN ROUNDING?". Input **1**  (USE: not using 1¢ coins for change) or **0**  (NOT USE: using 1¢ coins for change).

DO YOU USE CANADIAN ROUNDING ?	
USE	: 1<CA>
NOT USE	: 0<CA>

9 Now, you have completed the initial setups of the Cash Register.

NOTE By default, tax 1 is preset to departments 5 through 12, and the rest of the departments are non-tax departments. To preset tax statuses to department keys, see page 36.

Further operations:

- To set tax table (page 71)

To use the Cash Register's basic function

Daily job flow

Before opening your store



- Plugged in? (page 18)
- Enough paper roll? (pages 16 and 17)
- Date and time are correct? (page 21)
- Prepared enough bills and coins for changes? (page 22)



While the store is open



- Registrations (page 23)
- Issuing latest total sales report if needed (page 44)



After closing the store



- Issuing day's total sales report (page 44)
- Withdraw the money from the drawer.
After you withdraw all the money from the drawer, we recommend that you leave the drawer open when you leave your store.
- Turn the Mode switch to OFF.

To use the Cash Register's basic function

Before opening your store

Checking the time and date

You can check the time or date on the display whenever there is no registration being made.



Step	Operation	Display
1 Press key to show the date and time on the display.		
2 Press key to clear the date/time display.		

Setting date and time

To change date and time, perform the following operations.





Step	Operation
1 Turn the Mode switch to PGM position.	
2 Input the date and time from ten key pad and press key in order of MMDDYY. The example on the right is for January 21, 2015.	
3 Press key.	
4 Input the present time in 24-hour system. For example, 1300 for 1:00 PM. After then press key.	
5 Press key.	





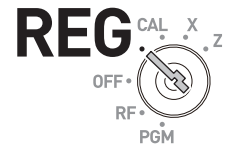

To use the Cash Register's basic function

Preparing bills and coins for change

Use  key to open the drawer and store prepared bills and coins for changes in the drawer.



NOTE You can also use  key to open the drawer however, the amount of prepared money for change is not stored in the Cash Register's memory, and cash amount in drawer is miscalculated on the sales reports.

Step	Operation	Printout
1 Input the amount prepared for changes and press  key. The example on the right is for preparing \$350.50.	     	<div data-bbox="1034 622 1471 913" style="border: 1px solid black; padding: 5px;"><p style="text-align: center;">YOUR RECEIPT THANK YOU CALL AGAIN</p><p>01-21-2015 09:30 REG 000002</p><p>RA \$350.50</p></div>
2 Put the money prepared for changes in the drawer and close the drawer.		

To use the Cash Register's basic function

Registering items

The following examples show how you can use the department keys in various types of registrations. Departments are used for categorizing items. For example, department 01 for vegetables, department 02 for fruits, and department 03 for canned foods etc.

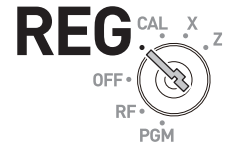

Simple registration

■ Paying the exact amount

Sample Operation

Item	Unit Price	\$1.00	One Dept. 01 item priced \$1.00 is sold, and the customer paid the exact amount in cash.
	Quantity	1	
	Dept.	01	
Payment	Cash	\$1.00	

Step	Operation	Printout
1 Enter the unit price.	1 00	<div style="border: 1px solid black; padding: 5px;"> <p style="text-align: center;">YOUR RECEIPT THANK YOU CALL AGAIN</p> <p>01-21-2015 09:45 REG 000004</p> <p>DEPT01 \$1.00 CASH \$ 1.00</p> </div>
2 Press corresponding Dept. key. In this example, Dept. 01.	+ 1	
3 Press = <small>CA / AMT / TEND</small> key.	= <small>CA / AMT / TEND</small>	

Further operations:

- To preset prices to departments (page 38)
- To preset item names to departments (pages 39 and 51)
- To register single item by single operation (pages 60 and 61)
- To preset tax statuses to departments (page 36)

To use the Cash Register's basic function

■ Registration with change calculation

Sample Operation

Item	Unit Price	\$12.34	One item priced at \$12.34 is sold and the customer paid more than the total amount (\$20.00).
	Quantity	1	
	Dept.	01	
Payment	Cash	\$20.00	

Step	Operation	Printout and Display
1 Enter the unit price.	1 2 3 4	<div style="border: 1px solid black; padding: 5px;"> <p style="text-align: center;">YOUR RECEIPT THANK YOU CALL AGAIN</p> <p>01-21-2015 09:50 REG 000005</p> <p>DEPT01 \$12.34 TOTAL \$ 12.34 CASH \$20.00 CHANGE \$7.66</p> </div>
2 Press corresponding department key.	+ 1	
3 Press SUB TOTAL key. The total amount of the item is shown on the display.	SUB TOTAL	
4 Enter the tendered amount then press CA/AMT TEND key. The display shows the amount of change.	2 0 00 = CA/AMT TEND	<div style="border: 1px solid black; padding: 5px; text-align: center;"> <p>CHANGE</p> <p style="font-size: 2em;">7.66</p> </div> <p style="font-size: 0.8em; margin-top: 5px;">RPT T1 T2 T3 T4 TOTAL CHANGE</p>







To use the Cash Register's basic function

To register multiple items of the same price



■ Registering multiple items of the same price

Sample Operation

Item 1	Unit Price	\$1.50	Three items of Dept. 01 priced at \$1.50 and a dozen of \$1.00 items of the same Dept. are sold, and the customer paid \$20.00 in cash.
	Quantity	3	
	Dept.	01	
Item 2	Unit Price	\$1.00	
	Quantity	12	
	Dept.	01	
Payment	Cash	\$20.00	





Step	Operation	Printout																				
1 Enter the unit price of item 1.	1 5 0	<table border="1"> <tr> <td>21-01-2015</td> <td>10:20</td> </tr> <tr> <td>REG</td> <td>000007</td> </tr> <tr> <td>DEPT01</td> <td>\$1.50</td> </tr> <tr> <td>DEPT01</td> <td>\$1.50</td> </tr> <tr> <td>DEPT01</td> <td>\$1.50</td> </tr> <tr> <td>12 X</td> <td>@1.00</td> </tr> <tr> <td>DEPT01</td> <td>\$12.00</td> </tr> <tr> <td>TOTAL</td> <td>\$ 16.50</td> </tr> <tr> <td>CASH</td> <td>\$20.00</td> </tr> <tr> <td>CHANGE</td> <td>\$3.50</td> </tr> </table>	21-01-2015	10:20	REG	000007	DEPT01	\$1.50	DEPT01	\$1.50	DEPT01	\$1.50	12 X	@1.00	DEPT01	\$12.00	TOTAL	\$ 16.50	CASH	\$20.00	CHANGE	\$3.50
21-01-2015	10:20																					
REG	000007																					
DEPT01	\$1.50																					
DEPT01	\$1.50																					
DEPT01	\$1.50																					
12 X	@1.00																					
DEPT01	\$12.00																					
TOTAL	\$ 16.50																					
CASH	\$20.00																					
CHANGE	\$3.50																					
2 Press corresponding department key repeatedly for the purchased quantity.	+1 +1 +1																					
3 Enter the quantity then press  key.	1 2 																					
4 Enter the unit price and press corresponding Dept. key.	1 00 +1																					
5 Press  key. Display shows the total amount.																						
6 Enter the tendered amount then press  key. The display shows the amount of change.	2 0 00 																					

■ Department shift

Using  key, you can register items in Dept. 13 through 24. To register items in Dept. 13 through 24, operate  key and <unit price> then Dept. key (**+1** for Dept. 13 through **12** for Dept. 24).

Sample Operation

Item	Unit Price	\$1.00	Registering one piece of \$1.00 item of Dept. 20. Dept. 20 is assigned by  and 8 keys.
	Quantity	1	
	Dept.	20	
Payment	Cash	\$1.00	

Step	Operation	Printout								
1 Press  key then enter the unit price.	 1 00	<table border="1"> <tr> <td>01-21-2015</td> <td>10:50</td> </tr> <tr> <td>REG</td> <td>000011</td> </tr> <tr> <td>DEPT20</td> <td>\$1.00</td> </tr> <tr> <td>CASH</td> <td>\$ 1.00</td> </tr> </table>	01-21-2015	10:50	REG	000011	DEPT20	\$1.00	CASH	\$ 1.00
01-21-2015	10:50									
REG	000011									
DEPT20	\$1.00									
CASH	\$ 1.00									
2 Press 8 key. \$1.00 item is registered in Dept.20.	8									
3 Press  key to finalize the transaction.										

To use the Cash Register's basic function







Various payments

Instead of , you can use ,  or  keys for charge, credit card or check payments.

Other payments than cash

Sample Operation

Item	Unit Price	\$10.00	One Dept. 01 item priced \$10.00 is sold and the customer paid by check.
	Quantity	1	
	Dept.	01	
Payment	Check	\$10.00	

Step	Operation	Printout								
1 Enter the unit price.	  	<table border="1"> <tr> <td>01-21-2015</td> <td>11:10</td> </tr> <tr> <td>REG</td> <td>000012</td> </tr> <tr> <td>DEPT01</td> <td>\$10.00</td> </tr> <tr> <td>CHECK</td> <td>\$10.00</td> </tr> </table>	01-21-2015	11:10	REG	000012	DEPT01	\$10.00	CHECK	\$10.00
01-21-2015	11:10									
REG	000012									
DEPT01	\$10.00									
CHECK	\$10.00									
2 Press corresponding Dept. key.										
3 Press  key.										













NOTE Instead of  key, use  or  keys for charge or credit card payments.

Split payment

You can register mixed payment of cash, charge, check, and credit card.

Sample Operation

Item	Unit Price	\$25.50	One Dept. 01 item priced \$25.50 is sold, and the customer paid \$10.00 in cash and the rest (\$15.50) by credit card.
	Quantity	1	
	Dept.	01	
Payment	Cash	\$10.00	
	Card	\$15.50	

Step	Operation	Printout												
1 Enter the unit price.	   	<table border="1"> <tr> <td>01-21-2015</td> <td>13:30</td> </tr> <tr> <td>REG</td> <td>000013</td> </tr> <tr> <td>DEPT01</td> <td>\$25.50</td> </tr> <tr> <td>TOTAL</td> <td>\$25.50</td> </tr> <tr> <td>CASH</td> <td>\$10.00</td> </tr> <tr> <td>CREDIT</td> <td>\$15.50</td> </tr> </table>	01-21-2015	13:30	REG	000013	DEPT01	\$25.50	TOTAL	\$25.50	CASH	\$10.00	CREDIT	\$15.50
01-21-2015	13:30													
REG	000013													
DEPT01	\$25.50													
TOTAL	\$25.50													
CASH	\$10.00													
CREDIT	\$15.50													
2 Press corresponding Dept. key.														
3 Input cash amount and press  key. The display shows the balance.	   													
4 Press  key. The balance is registered as credit card payment.														





To use the Cash Register's basic function

Discount

■ Discount on items

Sample Operation

Item 1	\$10.00 (5% discount)	1 piece	Dept. 01	Five percent discount is given to a \$10.00 item.
Item 2	\$20.00 (no discount)	1 piece	Dept. 02	
Payment	\$30.00 in cash			

Step	Operation	Printout																		
1 Enter the unit price of item 1, and press corresponding Dept. key.	1 0 00 + 1	<table border="1"> <tr><td>01-21-2015</td><td>15:25</td></tr> <tr><td>REG</td><td>000021</td></tr> <tr><td>DEPT01</td><td>\$10.00</td></tr> <tr><td>5%</td><td></td></tr> <tr><td>%-</td><td>-0.50</td></tr> <tr><td>DEPT02</td><td>\$20.00</td></tr> <tr><td>TOTAL</td><td>\$29.50</td></tr> <tr><td>CASH</td><td>\$30.00</td></tr> <tr><td>CHANGE</td><td>\$0.50</td></tr> </table>	01-21-2015	15:25	REG	000021	DEPT01	\$10.00	5%		%-	-0.50	DEPT02	\$20.00	TOTAL	\$29.50	CASH	\$30.00	CHANGE	\$0.50
01-21-2015	15:25																			
REG	000021																			
DEPT01	\$10.00																			
5%																				
%-	-0.50																			
DEPT02	\$20.00																			
TOTAL	\$29.50																			
CASH	\$30.00																			
CHANGE	\$0.50																			
2 Input the discount rate from ten key pad, and press  key. The discounted amount of the item is shown on the display.	5 																			
3 Register item 2.	2 0 00 - 2																			
4 Enter the tendered amount then press  key.	3 0 00 																			







Further operation:

- To preset discount rate (page 35)

■ Discount on total amount

Sample Operation

Item 1	\$10.00	1 piece	Dept. 01	\$10.00 and \$20.00 items are sold, and 5% discount is given on the total amount.
Item 2	\$20.00	1 piece	Dept. 02	
Total	\$30.00 (5% discount)			
Payment	\$30.00 in cash			

Step	Operation	Printout																				
1 Register item 1.	1 0 00 + 1	<table border="1"> <tr><td>01-21-2015</td><td>16:10</td></tr> <tr><td>REG</td><td>000023</td></tr> <tr><td>DEPT01</td><td>\$10.00</td></tr> <tr><td>DEPT02</td><td>\$20.00</td></tr> <tr><td>ST</td><td>\$30.00</td></tr> <tr><td>5%</td><td></td></tr> <tr><td>%-</td><td>-1.50</td></tr> <tr><td>TOTAL</td><td>\$28.50</td></tr> <tr><td>CASH</td><td>\$30.00</td></tr> <tr><td>CHANGE</td><td>\$1.50</td></tr> </table>	01-21-2015	16:10	REG	000023	DEPT01	\$10.00	DEPT02	\$20.00	ST	\$30.00	5%		%-	-1.50	TOTAL	\$28.50	CASH	\$30.00	CHANGE	\$1.50
01-21-2015	16:10																					
REG	000023																					
DEPT01	\$10.00																					
DEPT02	\$20.00																					
ST	\$30.00																					
5%																						
%-	-1.50																					
TOTAL	\$28.50																					
CASH	\$30.00																					
CHANGE	\$1.50																					
2 Register item 2.	2 0 00 - 2																					
3 Press  key.																						
4 Input the percent rate from ten key pad, and press  key. The discounted total amount is shown on the display.	5 																					
5 Enter the tendered amount then press  key.	3 0 00 																					













To use the Cash Register's basic function

Quantity discount registration

Even price is set per specific quantity, the Cash Register calculates the price of add numbered quantity.

Sample Operation

Set quantity	6 pieces	Set price	\$50.00	Dept. 01	Five pieces of \$50.00 for 6 pieces is purchased.
Purchased quantity	5 pieces				
Payment	\$50.00 in cash				









Step	Operation	Printout
1 Input purchased quantity and press  key.	 	<div style="border: 1px solid black; padding: 5px;"> <p>01-21-2015 14:45 REG 000016</p> <p style="text-align: right;">5 X 6 X @50.00</p> <p>DEPT01 \$41.67 CASH \$50.00 CHANGE \$8.33</p> </div>
2 Input unit quantity and press  key.	 	
3 Enter the set price and press corresponding Dept. key. The display indicates the amount of odd numbered quantity.	   	
4 Enter tendered amount and press  key to finalize the transaction.		

To use the Cash Register's basic function

Price reduction

Sample Operation

Item 1	\$10.00 (reduce \$0.05)	1 piece	Dept. 01	Reducing \$0.05 from item 1 unit price.
Item 2	\$20.00 (no reduction)	1 piece	Dept. 02	
Payment	\$30.00 in cash			

Step	Operation	Printout																
1 Register item 1.	1 0 00 	<table border="1"> <tr> <td>01-21-2015</td> <td>16:20</td> </tr> <tr> <td>REG</td> <td>000025</td> </tr> <tr> <td>DEPT01</td> <td>\$10.00</td> </tr> <tr> <td>-</td> <td>-0.05</td> </tr> <tr> <td>DEPT02</td> <td>\$20.00</td> </tr> <tr> <td>TOTAL</td> <td>\$29.95</td> </tr> <tr> <td>CASH</td> <td>\$30.00</td> </tr> <tr> <td>CHANGE</td> <td>\$0.05</td> </tr> </table>	01-21-2015	16:20	REG	000025	DEPT01	\$10.00	-	-0.05	DEPT02	\$20.00	TOTAL	\$29.95	CASH	\$30.00	CHANGE	\$0.05
01-21-2015	16:20																	
REG	000025																	
DEPT01	\$10.00																	
-	-0.05																	
DEPT02	\$20.00																	
TOTAL	\$29.95																	
CASH	\$30.00																	
CHANGE	\$0.05																	
2 Input reduction price (\$0.05 in this case) and press  key.	5 																	
3 Register item 2.	2 0 00 																	
4 Press  key.																		
5 Enter the tendered amount then press  key.	3 0 00 																	

To use the Cash Register's basic function



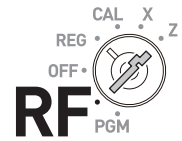

Refund

When a customer returned a goods for refund, use this feature. You can also use this feature for deposited bottle return.



Sample Operation

Returned Item 1	\$10.00	1 piece	Dept. 01	A customer returned one \$10.00 item (Dept. 01) and five bottles (Dept. 04) for refund.
Returned bottle	\$0.10	5 piece	Dept. 04	

Step	Operation	Printout
1 Turn the Mode switch to RF position.		01-21-2015 18:40 RF 000003
2 Enter the price of the returned goods and press corresponding Dept. key.	1 0 00 + 1	DEPT01 \$10.00
3 Register the second item.	5  1 0 ÷ 4	5 X @0.10 DEPT04 \$0.50
4 Press  key. The amount of the refund will be shown on the display.		CASH \$10.50
5 Press  key.		

To use the Cash Register's basic function

To print reference numbers

As a memorandum, you can print a reference number on the receipt. You can use this feature in REG or RF modes.

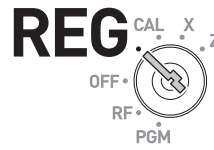

Sample Operation

Reference number	12345			Printing "12345" as a note on the receipt.
Item 1	\$25.00	1 piece	Dept. 02	

Step	Operation	Printout
1	Input a reference number from ten key pad, and press  key.	<div style="border: 1px solid black; padding: 10px;"> <p># 12345</p> <p>YOUR RECEIPT THANK YOU CALL AGAIN</p> <p>01-21-2015 10:35 REG 000009</p> <p>DEPT02 \$25.00 CASH \$25.00</p> </div>
2	Register item 1.	
3	Finalize the transaction.	

To use the Cash Register's basic function

Corrections





To correct erroneous item input before registration

When you made incorrect input before you register it in a department, you can correct it by using  key.



Sample Operation

Item	Unit Price	\$1.00	By mistake, you have entered \$4.00 instead of \$1.00 for a Dept. 01 item.
	Quantity	1	
	Dept.	01	
Payment	Cash	\$1.00	

Step	Operation	Printout
1 By mistake, you have entered \$4.00 for \$1.00 item.		<div style="border: 1px solid black; padding: 10px;"> <p style="text-align: center;">YOUR RECEIPT THANK YOU CALL AGAIN</p> <p>01-21-2015 09:45 REG 000004</p> <p>DEPT01 \$1.00 CASH \$ 1.00</p> </div>
2 Press  key to cancel the wrong entry.		
3 Input the correct unit price. Press Dept. key.		
4 Finalize the transaction.		

Erroneous input is not printed on the receipt.









To use the Cash Register's basic function

To correct erroneous item input immediately after registration

If an item has been already registered in a Dept., use  key to cancel the registration. This correction is effective just after a registration.

Sample Operation

Item	Unit Price	\$2.50	By mistake, you have pressed a Dept. key twice for one item.
	Quantity	1	
	Dept.	03	
Payment	Cash	\$2.50	

Step	Operation	Printout												
1 Entering a unit price.	  	<table border="1"> <tr> <td>01-21-2015</td> <td>18:20</td> </tr> <tr> <td>REG</td> <td>000028</td> </tr> <tr> <td>DEPT03</td> <td>\$2.50</td> </tr> <tr> <td>DEPT03</td> <td>\$2.50</td> </tr> <tr> <td>ERR CORR</td> <td>-2.50</td> </tr> <tr> <td>CASH</td> <td>\$2.50</td> </tr> </table>	01-21-2015	18:20	REG	000028	DEPT03	\$2.50	DEPT03	\$2.50	ERR CORR	-2.50	CASH	\$2.50
01-21-2015	18:20													
REG	000028													
DEPT03	\$2.50													
DEPT03	\$2.50													
ERR CORR	-2.50													
CASH	\$2.50													
2 By mistake, you have hit a Dept. key twice.	 													
3 Press  key to cancel the preceding registration (the last  key).														
4 Finalize the transaction.														

To use the Cash Register's basic function



Basic setups and operations

About HELP guidance

In any Mode switch position, pressing  key prints a guide menu shown below.

```
ENTER NUMBER THEN  
PRESS <HELP> KEY.  
  
01:HOW TO PROGRAM  
DATE AND TIME ?  
02:HOW TO PROGRAM  
TAX TABLE ?  
03:HOW TO REPLACE  
PAPER ROLL ?  
04:HOW TO TAKE REPORTS ?  
05:WHAT IS THE  
ELECTRONIC JOURNAL ?  
06:HOW TO CHANGE PRINTER  
MODE ?  
07:WHEN AN ERROR OCCURS  
08:IN THE CASE OF  
POWER FAILURE  
09:WHEN THE  
"LOW BATTERY" SIGN  
APPEARS ON THE
```

```
POWER FAILURE  
09:WHEN THE  
"LOW BATTERY" SIGN  
APPEARS ON THE  
DISPLAY  
(ABOUT THE LOW-BATTERY  
INDICATOR)  
10:HOW TO SET DEPT/PLU  
NAME ?  
11:HOW TO PROGRAM  
CHARACTER FOR  
CLERK'S NAME /  
RECEIPT MESSAGE ?  
12:HOW TO FORMAT  
SD CARD.  
13:HOW TO BACK UP ECR  
SETTING IN SD CARD.  
14:HOW TO RESTORE ECR  
SETTING FROM SD CARD.  
15:HOW TO SAVE SALES  
DATA AND EJ DATA  
TO SD CARD.  
16:HOW TO SET  
GRAPHIC LOGO.
```

Enter the guidance number and press  key. The printer prints the guidance what to be done. For example, enter **0 2** and press  key to print the guidance for programming tax table.

To use the Cash Register's basic function

To preset discount rate to key







Presetting discount rate makes discount calculations quick and easy.

■Presetting discount rate



Sample Operation

Discount rate	10.5%	Presetting 10.5% to  key.
---------------	-------	--







Step	Operation	Printout						
1 Turn the Mode switch to PGM position and press 1 and  keys. Now, the Cash Register is in the setup mode.	1 	<table border="1"> <tr> <td>01-21-2015</td> <td>14:30</td> </tr> <tr> <td>P01</td> <td>000013</td> </tr> <tr> <td>%-</td> <td>10.5%</td> </tr> </table>	01-21-2015	14:30	P01	000013	%-	10.5%
01-21-2015	14:30							
P01	000013							
%-	10.5%							
2 Enter the discount rate. You can set 2-digit integer and 2-digit decimal.	1 0 . 5							
3 Press  key.								
4 Press  key to complete the setting.								

■Registering an item with preset discount rate



Sample Operation

Item 1	\$10.00 (preset 10.5% discount)	1 piece	Dept. 01	Discounting 10.5% (preset) on item 1.
Item 2	\$20.00 (no discount)	1 piece	Dept. 02	
Payment	\$30.00 in cash			

Step	Operation	Printout																		
1 Turn the Mode switch to REG position. Enter the unit price of item 1, and press corresponding Dept. key.	1 0 00 +1	<table border="1"> <tr> <td>01-21-2015</td> <td>18:30</td> </tr> <tr> <td>REG</td> <td>000030</td> </tr> <tr> <td>DEPT01</td> <td>\$10.00</td> </tr> <tr> <td>10.5%</td> <td></td> </tr> <tr> <td>%-</td> <td>-1.05</td> </tr> <tr> <td>DEPT02</td> <td>\$20.00</td> </tr> <tr> <td>TOTAL</td> <td>\$28.95</td> </tr> <tr> <td>CASH</td> <td>\$30.00</td> </tr> <tr> <td>CHANGE</td> <td>\$1.05</td> </tr> </table>	01-21-2015	18:30	REG	000030	DEPT01	\$10.00	10.5%		%-	-1.05	DEPT02	\$20.00	TOTAL	\$28.95	CASH	\$30.00	CHANGE	\$1.05
01-21-2015	18:30																			
REG	000030																			
DEPT01	\$10.00																			
10.5%																				
%-	-1.05																			
DEPT02	\$20.00																			
TOTAL	\$28.95																			
CASH	\$30.00																			
CHANGE	\$1.05																			
2 Press  key. The item 1 is registered with preset discount rate.																				
3 Register item 2.	2 0 00 -2																			
4 Press  key.																				
5 Enter the tendered amount then press  key.	3 0 00 = 																			

NOTE If you press  after  key, discount is given to the total amount with preset rate.

To use the Cash Register's basic function

To preset taxable statuses to departments

By default, Dept. 05 through 12 are preset as tax status 1 and the rest of the departments are non-tax states. By presetting taxable statuses to departments, the Cash Register performs tax calculations with the rate you have set on pages 18 and 19 "To set the language, date, time, and tax rates".



■ Presetting taxable statuses to departments

Sample Operation

Tax status	Dept. 05	Tax status 2 (10%)	Presetting tax status 2 (10%) to Dept. 05 and tax status 3 (15%) to Dept. 06. Ten and fifteen percent tax rates have been set in "To set the language, date, time, and tax rates" on pages 18 and 19 as an example.
	Dept. 06	Tax status 3 (15%)	

Step	Operation	Printout
------	-----------	----------

1 Turn the Mode switch to PGM position and press **1** and  keys. Now, the Cash Register is in the setup mode.



01-21-2015	16:10
P01	000018
DEPT05	T2
DEPT06	T3

2 Pressing  key repeatedly changes the tax status indication as; T/S1 → T/S2 → T/S1 & T/S2 → T/S3 → T/S1 & T/S3 → T/S2 & T/S3 → ALL → NON TAX. Select the tax status you wish to set. In this example, T/S2.



3 Press corresponding Dept. key. In this example, Dept. 05. If you wish to set the same tax status to another department, press the Dept. key consecutively.



4 Press  key twice. The tax status indication changes to T/S3. After then, press corresponding Dept. key.



5 Press  key to complete the setting.



To use the Cash Register's basic function



■ To register taxable items

Sample Operation

Item 1	\$10.00	1 piece	Dept. 05 (TS2: 5% tax)	Registering item 1 to Dept. 05 (preset tax status 2; 5% tax) and item 2 to Dept. 06 (preset tax status 3: 15% tax)
Item 2	\$20.00	1 piece	Dept. 06 (TS3: 15% tax)	
Payment	\$50.00 in cash			

Step

- Turn the Mode switch to REG position and register items 1 and 2.
- Enter tendered amount and finalize the transaction.

Operation



By the above operation, Cash Register prints the following receipt.

01-21-2015	16:15	
REG	000024	
DEPT05	T2	\$10.00
DEPT06	T3	\$20.00
TA2		\$10.00
TAX2		\$1.00
TA3		\$20.00
TAX3		\$3.00
TOTAL		\$34.00
CASH		\$50.00
CHANGE		\$16.00

- Tax status
- Taxable amount
- Tax amount

■ To change tax statuses (Tax shift)

Using $\frac{RA}{T/S1}$ or $\frac{PO}{T/S2}$ keys, you can change the tax statuses preset to departments. The following table explains the tax status shifts by $\frac{RA}{T/S1}$ or $\frac{PO}{T/S2}$ keys.

Preset tax status	Pressing $\frac{RA}{T/S1}$ key	Pressing $\frac{PO}{T/S2}$ key.
Non tax	Tax status 1	Tax status 2
Tax status 1	Non tax	Tax statuses 1 and 2
Tax status 2	Tax statuses 1 and 2	Non tax
Tax status 3	Tax statuses 1 and 3	Tax statuses 2 and 3

Sample Operation

Department 01 is non-tax Dept. But pressing $\frac{RA}{T/S1}$ key shifts the department to Tax status 1.

Step

- Prior to a registration, press $\frac{RA}{T/S1}$ key.
- Register an item.
- Finalize the transaction.
The item is registered as taxable 1 item to non-tax Dept.

Operation

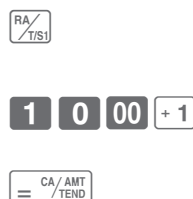

Printout

01-21-2015	18:30
REG	000030
DEPT01	T1 \$10.00
TA1	\$10.00
TAX1	\$0.50
CASH	\$10.50

To use the Cash Register's basic function

To preset unit price to each department

■ Presetting unit prices to departments

You can preset a unit price to corresponding department to make registrations quick and easy.

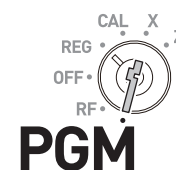

Sample Operation

Preset price	Dept. 02	\$3.50	Presetting \$3.50 to Dept. 02 and \$5.25 to Dept. 03.
	Dept. 03	\$5.25	

Step	Operation	Printout
1 Turn the Mode switch to PGM position and press 1 and SUB TOTAL keys. Now, the Cash Register is in the setup mode.	1 SUB TOTAL	01-21-2015 16:15 P01 000020
2 Input the unit price and the Dept. key you wish to preset to. The example on the right is for presetting \$3.50 to Dept. 02.	3 5 0 - 2	DEPT02 #02 @3.50
3 Perform the same operation for other Depts.	5 2 5 × 3	DEPT03 #03 @5.25
4 Press SUB TOTAL key to complete the setting.	SUB TOTAL	

■ Registering items with preset prices

By presetting unit prices to departments, you can register items just by pressing Dept. keys.



Sample Operation

Item	Unit Price	\$3.50 (preset)	\$5.25 (preset)	Registering preset priced items.
	Quantity	1	1	
	Dept.	02	03	
Payment	Cash			

Step	Operation	Printout
1 Turn the Mode switch to REG position and just press corresponding Dept. keys. Items with preset prices have been registered.	- 2 × 3	01-21-2015 15:10 REG 000017
2 Finalize the transaction.	= CA/AMT /TEND	DEPT02 \$3.50 DEPT03 \$5.25 CASH \$8.75

NOTE If you enter unit price by ten key prior to the Dept. key, the preset price becomes ineffective, and entered price is registered.

To use the Cash Register's basic function

To preset item names to departments

By presetting item names to departments, the names are printed on a receipt. You can choose an item name from 200 item list.

■ Programming item names to departments



Sample Operation

Item	Dept. 02	MAGAZINE	Presetting "MAGAZINE" to Dept. 02 and "BOOK" to Dept. 03.
	Dept. 03	BOOK	

Step	Operation	Printout
<p>1 Turn the Mode switch to PGM position and press 2 and keys. The Cash Register becomes program mode .</p>	2	Category list
<p>2 Press 1 0 and keys. Printer prints the category list.</p>	1 0	<pre> 110:ARTICLE SALE 210:BOOK, STATIONERY 310:ELECTRONIC GOODS 410:DRESSING 510:SERVICE 610:PHARMACY 710:FOODSTUFFS 810:MEAL 910:OTHERS ENTER XXX AND PRESS <HELP> TO SEE DEPT/PLU NAME.</pre>
<p>3 Enter the category number (in this example, 210: BOOK, STATIONERY) and press key. Printer prints the item code list of the category.</p>	2 1 0	
<p>4 Enter the item code, in this example, 040 for MAGAZINE and press corresponding Dept. key.</p>	0 4 0	Item code
<p>5 Enter the item code for the next item (in this example, 044 for BOOK) and press corresponding Dept. key.</p>	0 4 4	
<p>6 Press key to complete the setting. If you wish to set an item name of another category, repeat from step 3.</p>		<pre> 210:BOOK, STATIONERY 036 : CD 037 : DVD 038 : ALBUM 039 : COMIC 040 : MAGAZINE 041 : GUIDE 042 : SUPPLIES 043 : HOBBY 044 : BOOK 045 : NEWSPAPE 046 : STATIONE 047 : LITERARY 048 : PAPERBAC 049 : DICTIONA 050 : CALCULAT 051 : MAP</pre>

To use the Cash Register's basic function

■ Registering items with preset names

The item names programmed by the above procedures are printed on receipts.

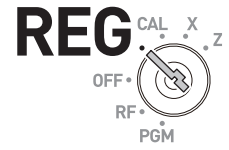

Sample Operation

Item	Dept.	Unit Price	Quantity	Preset item name	Registering Dept. 02 (preset as MAGAZINE) and Dept. 03 (BOOK) items.
	02	\$8.75	1	MAGAZINE	
	03	\$15.50	1	BOOK	

Step

Operation

Printout

1 Turn the Mode switch to REG position. Enter the unit price and press corresponding Dept. key. If a preset price is programmed to the Dept. key, just press the Dept. key.

8 7 5 - 2

01-21-2015	15:15
REG	000020
MAGAZINE	\$8.75
BOOK	\$15.50
CASH	\$24.25

2 Register the other item.

1 5 5 0 × 3

3 Finalize the transaction. The item names, MAGAZINE, and BOOK will be printed on the receipt.

= CA/AMT /TEND

To use the Cash Register's basic function

To preset PLUs

Apart from departments, you can preset unit prices and item names by using PLU (Price Look Up) feature. You can preset prices and names for up to 2000 PLU items.

■ Presetting unit prices to PLUs



Sample Operation

PLU item	PLU No.	Unit Price	
	5	\$8.50	Presetting \$8.50 to PLU 5 and \$14.00 to PLU 123.
	123	\$14.00	

Step	Operation	Printout												
1 Turn the Mode switch to PGM position and press 1 and keys. Now, the Cash Register is in the setup mode.	1	<table border="1"> <tr> <td>01-21-2015</td> <td>14:00</td> </tr> <tr> <td>P01</td> <td>000007</td> </tr> <tr> <td>PLU0005</td> <td>#0005</td> </tr> <tr> <td></td> <td>@8.50</td> </tr> <tr> <td>PLU0123</td> <td>#0123</td> </tr> <tr> <td></td> <td>@14.00</td> </tr> </table>	01-21-2015	14:00	P01	000007	PLU0005	#0005		@8.50	PLU0123	#0123		@14.00
01-21-2015	14:00													
P01	000007													
PLU0005	#0005													
	@8.50													
PLU0123	#0123													
	@14.00													
2 Input a PLU number and press key.	5													
3 Enter the unit price and press key.	8 5 0													
4 Perform the same operation for the next PLU item.	1 2 3 1 4 00													
5 Press key to complete the setting.														

Further operation:

- To link PLU items to department (page 57).

To use the Cash Register's basic function

■ Naming PLU items

From 200 item name list, you can preset item names to PLU items.



Sample Operation

PLU item	PLU No.	Item name	Item name No.	
	5	UMBRELLA	061	Presetting PLU No.5 as UMBRELLA and PLU No.123 as SHIRT.
	123	SHIRT	077	

Step	Operation	Printout
<p>1 Turn the Mode switch to PGM position and press 2 and SUB TOTAL keys to set the Register in the program mode.</p>	<p>2 SUB TOTAL</p>	<div style="border: 1px solid black; padding: 5px;"> <p>01-21-2015 13:15 P02 000008</p> <p>UMBRELLA #0005 SHIRT #0123</p> </div>
<p>2 Input the PLU number (in this case 5) and press PLU key.</p>	<p>5 PLU</p>	
<p>3 Press ERR CORR key.</p>	<p>ERR CORR</p>	
<p>4 Input the item name code (in this case 061: UMBRELLA) and press CA/AMT/TEND.</p> <p>You can refer item name codes by the printout using HELP key (see page 39).</p>	<p>0 6 1 CA/AMT/TEND</p>	
<p>5 Repeat steps 2 through 4 for the next PLU item (in this example, PLU 123, item name code 077: SHIRT).</p>	<p>1 2 3 PLU</p> <p>ERR CORR</p> <p>0 7 7 CA/AMT/TEND</p>	
<p>6 Press SUB TOTAL key to complete the setting.</p>	<p>SUB TOTAL</p>	

To use the Cash Register's basic function

■ Registering PLU items

By entering a PLU number, preset unit price is automatically registered with pre-set name.



Sample Operation

PLU item	PLU No.	Preset unit price	Quantity	Item name	Registering two of PLU 5 items (UMBRELLA, \$8.50) and one PLU 123 item (SHIRT, \$14.00).
	5	\$8.50	2	UMBRELLA	
	123	\$14.00	1	SHIRT	
Payment	Cash	\$50.00			

Step	Operation	Printout																
1 Turn the Mode switch to REG position. Input the PLU number (5 in this case) and press PLU key twice (for two pieces).	5 PLU PLU	<table border="1"> <tr> <td>01-21-2015</td> <td>14:45</td> </tr> <tr> <td>REG</td> <td>000016</td> </tr> <tr> <td>UMBRELLA</td> <td>\$8.50</td> </tr> <tr> <td>UMBRELLA</td> <td>\$8.50</td> </tr> <tr> <td>SHIRT</td> <td>\$14.00</td> </tr> <tr> <td>TOTAL</td> <td>\$31.00</td> </tr> <tr> <td>CASH</td> <td>\$50.00</td> </tr> <tr> <td>CHANGE</td> <td>\$19.00</td> </tr> </table>	01-21-2015	14:45	REG	000016	UMBRELLA	\$8.50	UMBRELLA	\$8.50	SHIRT	\$14.00	TOTAL	\$31.00	CASH	\$50.00	CHANGE	\$19.00
01-21-2015	14:45																	
REG	000016																	
UMBRELLA	\$8.50																	
UMBRELLA	\$8.50																	
SHIRT	\$14.00																	
TOTAL	\$31.00																	
CASH	\$50.00																	
CHANGE	\$19.00																	
2 Enter the PLU number of the next item, and press PLU key.	1 2 3 PLU																	
3 Press SUB TOTAL key.	SUB TOTAL																	
4 Input the tendered amount and press CA/AMT TEND key to finalize the transaction.	5 0 00 CA/AMT TEND																	

NOTE

- If PLU name is not preset, PLU number is printed instead of an item name.
- If unit price is not preset, the Cash Register emits an error sound when the PLU number is assigned.

To use the Cash Register's basic function

Daily sales reports

To print sales reports

At the end or middle of the business day, you can print categorized and summarized sales results of the day. Z report clears all the sales data whereas the data remains in memory by X report output.

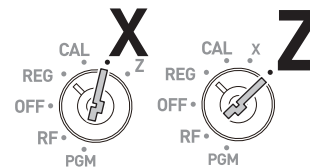

NOTE

- Please do not perform the Reset report (Z) printing while your store is open. It clears all the sales data.
- Items that transactions have not been made will not be printed on the report.

■ Daily sales report

Step	Operation
------	-----------

1 Turn the Mode switch to X or Z position.

2 Press  key. The printer prints the sales report.



01-21-2015	19:25	1	1	Date/time
Z	000073	2	2	Consecutive No.
0000 DAILY	Z 0012	3	3	Z report counter
DEPT01	48	4	4	Dept. /Quantity
	\$50.10	5	5	Amount
DEPT02	28		6	Gross sales quantity
	\$76.40		7	Gross sales amount
DEPT03	17		8	No. of net sales
	\$85.80		9	Net sales amount
DEPT20	4		10	Cash in drawer
	\$3.00		11	Charge in drawer
-----			12	Check in drawer
GROSS TOTAL	108	6	13	Credit in drawer
	\$316.80	7	14	Taxable amount for tax rate 1
NET TOTAL	No 46	8		
	\$325.13	9		
CAID	\$199.91	10		
CHID	\$16.22	11		
CKID	\$20.00	12		
CRID	\$85.00	13		
TA1	\$105.10	14		

To use the Cash Register's basic function

TAX1		\$4.20	15	15	Tax amount for tax rate 1
ROUND		\$1.23	16	16	Rounded amount
RF-MODE TTL	No	2	17	17	Refunded mode counter
		\$0.50	18	18	Refunded amount
CALCULATOR	No	3	19	19	No. of CAL operation

CASH	No	44	20	20	No. of cash sales
		\$203.91	21	21	Cash sales amount
CHARGE	No	3	22	22	Charge sales counter
		\$16.22	23	23	Charge sales amount
CHECK	No	1	24	24	Check sales counter
		\$20.00	25	25	Check sales amount
CREDIT	No	2	26	26	Credit sales counter
		\$85.00	27	27	Credit sales amount
RA	No	1	28	28	Received on account counter
		\$6.00	29	29	Received on account amount
P0	No	2	30	30	Paid-out counter
		\$10.00	31	31	Paid-out amount
-		1	32	32	Reduced counter
		\$0.50	33	33	Reduced amount
%-	No	1	34	34	Premium/Discount counter
		\$0.66	35	35	Premium/Discount amount
ERR CORR	No	21	36	36	Error correction counter
		\$30.50	37	37	Error correction amount
NS	No	12	38	38	No sale counter

CLERK	No	46	39	39	No. of clerk 01 transactions
		\$325.13	40	40	Clerk 01 sales amount

GT		\$0000832271.20	41	41	Grand total (not resettable)

■ Periodic sales report



Apart from daily report, you can obtain periodic sales report. The register prints total sales data from the last periodic report. Namely, if you do this operation monthly, you can obtain monthly sales reports.

Step	Operation	Printout
1	While Mode switch is in X or Z position, enter 1 0 from ten key pad and press CA/AMT/TEND keys.	<pre> 01-21-2015 16:15 Z 000001 0010 PERIODIC Z 0001 GROSS TOTAL 24 \$956.00 NET TOTAL No 21 \$1,027.15 </pre>

To use the Cash Register's basic function

■ PLU report

You can issue PLU sales report.

Step	Operation	Printout																																
<p>1 While Mode switch is in X or Z position, press 1 and  keys. The Cash Register issues PLU sales report.</p>	<p>1 </p>	<table border="1"><tr><td>01-21-2015</td><td>14:15</td></tr><tr><td>X</td><td>000015</td></tr><tr><td>0001 PLU</td><td>X</td></tr><tr><td>PLU0005</td><td>3</td></tr><tr><td></td><td>\$25.50</td></tr><tr><td>PLU0008</td><td>2</td></tr><tr><td></td><td>\$6.50</td></tr><tr><td>PLU0009</td><td>5</td></tr><tr><td></td><td>\$31.50</td></tr><tr><td>PLU0010</td><td>1</td></tr><tr><td></td><td>\$2.50</td></tr><tr><td>PLU0123</td><td>1</td></tr><tr><td></td><td>\$14.00</td></tr><tr><td>-----</td><td>-----</td></tr><tr><td>TOTAL</td><td>12</td></tr><tr><td></td><td>\$80.00</td></tr></table>	01-21-2015	14:15	X	000015	0001 PLU	X	PLU0005	3		\$25.50	PLU0008	2		\$6.50	PLU0009	5		\$31.50	PLU0010	1		\$2.50	PLU0123	1		\$14.00	-----	-----	TOTAL	12		\$80.00
01-21-2015	14:15																																	
X	000015																																	
0001 PLU	X																																	
PLU0005	3																																	
	\$25.50																																	
PLU0008	2																																	
	\$6.50																																	
PLU0009	5																																	
	\$31.50																																	
PLU0010	1																																	
	\$2.50																																	
PLU0123	1																																	
	\$14.00																																	
-----	-----																																	
TOTAL	12																																	
	\$80.00																																	

Advanced features

Receipt control	48
To not print receipts	48
To print receipts in paper saving mode.....	48
Character settings	49
Character keyboard	49
Character setting display.....	50
To set characters to departments and PLUs	51
Other character settings	54
To link PLU items to departments	57
Simple settings	59
Advanced programming	60
To program advanced features to departments	60
To program advanced features of the function keys	62
To program advanced features of the Cash Register	64
Tax table	71
To set tax table.....	71
Printing programmed data	72
Checking your program	72
To record business journal.....	75
To use journal paper	75
Electronic journal	77
To utilize an SD card	78
To insert an SD card.....	78
To save or recall data in or from SD card.....	79
Calculator mode	81
To use Cash Register as a Calculator.....	81
Specifications	82

Receipt control

To save paper, you can stop receipt print and, even in the paper saving mode, the Cash Register is able to print the receipt of immediately preceding transaction.

To not print receipts

If you do not need to print out receipts, use the paper saving mode.

1 To set the Cash Register in paper saving mode, just press [PAPER SAVING] key.

The printer will not print any receipt.

- NOTE**
- Even in the paper saving mode, transactions are stored in the Cash Register and, you can print X or Z reports.
 - To unset the paper saving mode, press [PAPER SAVING] key again.

To print receipts in paper saving mode

If you wish to issue a receipt in the paper saving mode, use post receipt feature.

1 After the finalization of a transaction, press [POST RECEIPT] key. The receipt of the transaction is issued.

- NOTE**
- You can issue a receipt only for the immediately preceding transaction.

Character settings

Apart from the preprogrammed department or PLU names (see pages 39 and 42), you can attach names to departments and PLUs. The following clauses explain how to preset “FRUITS” to Dept. 10 and “ORANGE” to PLU 100.

Character keyboard

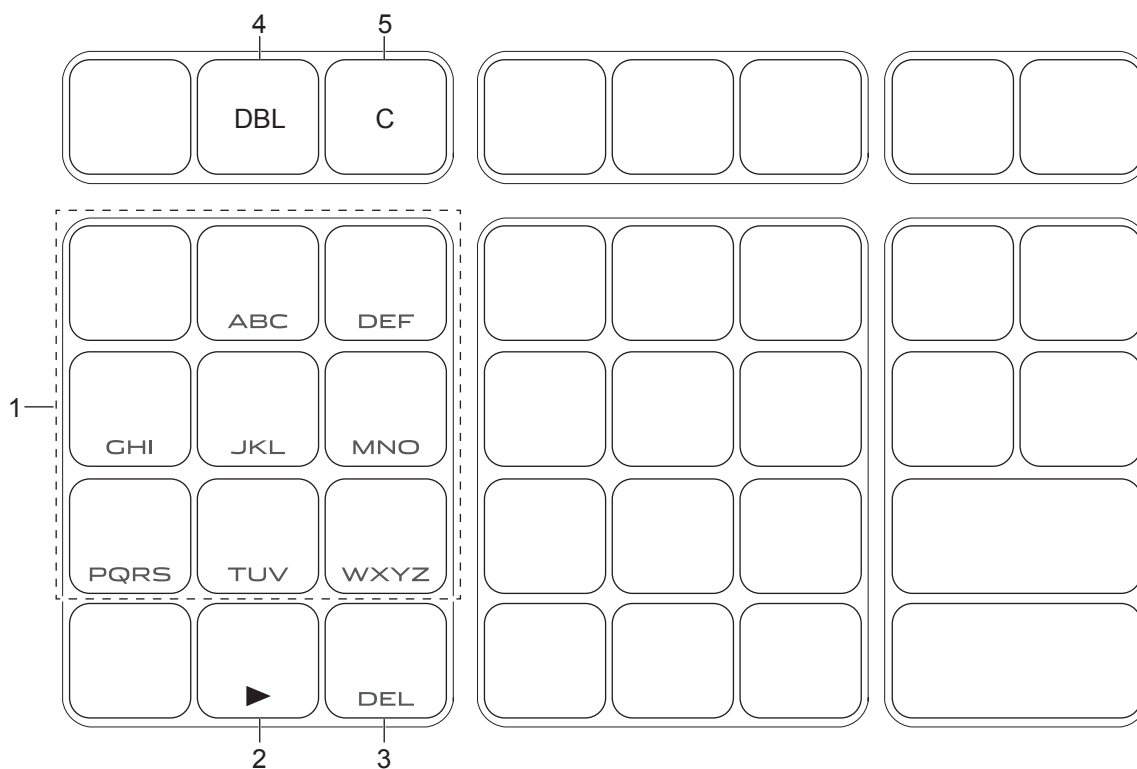

- | | | |
|---|------------------|--|
| 1 | Alphabet keys | Hitting one of those keys repeatedly changes characters in the order shown in the table below. |
| 2 | Right cursor key | Moves the cursor to the next digit. |
| 3 | DELETE key | Clears the last inputted character. |
| 4 | DBL key | Double size letter key. Assigns the next input character to be double-width character. |
| 5 | Clear key | Clears all the characters. |

Advanced features

8	A → B → C → a → b → c → 8 → Ä → Å → Æ → Á → Â → Æ → Ç → â → ä → à → á → æ → á → ä → ç returns to the beginning
9	D → E → F → d → e → f → 9 → ð → É → Ê → Ë → È → ð → é → ê → ë → è → f returns to the beginning
4	G → H → I → g → h → i → 4 → Í → Î → Ï → I → Ì → Î → Ï → Î → Ì → í → í returns to the beginning
5	J → K → L → j → k → l → 5 returns to the beginning
6	M → N → O → m → n → o → 6 → Ñ → Ö → ø → Ó → Ô → Ò → Õ → ñ → ô → ö → ò → ø → ó → õ returns to the beginning
1	P → Q → R → S → p → q → r → s → 1 → p → p → ß returns to the beginning
2	T → U → V → t → u → v → 2 → T _{EL} → Ü → Ú → Û → Û → ü → û → ù → ú → μ returns to the beginning
3	W → X → Y → Z → w → x → y → z → 3 → ŷ → ŷ → ŷ returns to the beginning
0	0
00	(Right cursor)
.	(Delete)
7	7 → @ → - → / → space → : → ! → ? → ~ → (→) → * → # → + → , → ^ → ; → < → > → = → > → \$ → ¥ → % → & → [→] → ' → { → → } → • → “ → . → \ → _ → ` → £ → × → ÷ → i → € → § returns to the beginning

Character setting display

Setting digit is displayed in a reversed character.

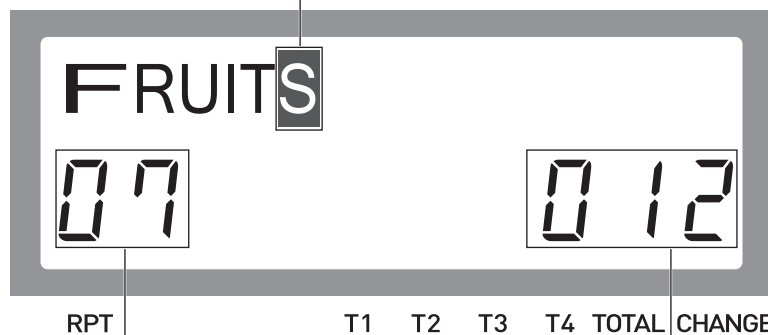

Present digit of cursor. Double width character is counted as 2.

Maximum number of characters

To set characters to departments and PLUs

■ Setting characters to departments

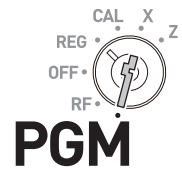

Sample Operation

	Category name	
Dept. 10	F FRUITS	Setting category name "F FRUITS" to Dept. 10.

Step	Operation	Printout
1 Turn the Mode switch to PGM position and press 2 and SUB TOTAL keys to make the Register in the program mode.	2 SUB TOTAL	
2 Press Dept. key you wish to set to. In this example, Dept. 10.	10	01-21-2015 14:40 P 02 000012 FRUITS # 10
3 Press X / FOR DATE TIME (DBL) key to assign the next character as double-width character.	X / FOR DATE TIME (DBL) <Assigning double-width>	
4 Press 9 key three times for letter F.	9 9 9 <F>	
5 Press X / FOR DATE TIME (DBL) key to release double-width assignment.	X / FOR DATE TIME (DBL) <Releasing double-width>	
6 Press 1 key three times for letter R.	1 1 1 <R>	
7 Press 2 key twice for letter U.	2 2 <U>	
8 Set the rest of characters "ITS".	4 4 4 2 <I> <T> 1 1 1 1 <S>	
9 Press = CA / AMT / TEND key to determine the setting. If you wish to set characters to another department, repeat steps 2 through 9.	= CA / AMT / TEND	
10 Press SUB TOTAL key to complete the setting.	SUB TOTAL	

- NOTE**
- Use **•** (DEL) key to delete the last inputted character. To clear all the characters of the department, press **AC C** key.
 - If you wish to set characters using the same key, use **00** (right cursor) key to move the setting digit.
 - To insert a space between characters, press **7** (-) key five times.

Advanced features

■ Registering an item to a character preset department

After a category name of a department is set, the Cash Register prints following receipt when an item is registered to the department.

After **1 0 00 10**  operation in REG mode.

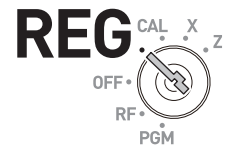











01-21-2015	14:42
REG	000015
FRUITS	T1 \$10.00
TA1	\$10.00
TAX1	\$0.50
CASH	\$10.50

■ Setting characters to PLUs



Sample Operation

	Item name	
PLU100	APPLE	Setting item name "APPLE" to PLU100.

Step	Operation	Printout						
1 Turn the Mode switch to PGM position and press 2 and  keys to make the Register in the program mode.	 	<table border="1"> <tr> <td>01-21-2015</td> <td>14:45</td> </tr> <tr> <td>P02</td> <td>000013</td> </tr> <tr> <td>APPLE</td> <td>#0100</td> </tr> </table>	01-21-2015	14:45	P02	000013	APPLE	#0100
01-21-2015	14:45							
P02	000013							
APPLE	#0100							
2 Enter the PLU number you wish to set to and press  key.	1 0 0 							
3 Press  key if you wish to clear present PLU name.								
4 Enter item name (APPLE in this example) using multi typing keyboard.	8 1 00 1 <A><P><▶><P> 5 5 5 9 9 <L> <E>							
5 Press  key to set the item name. Repeat steps 2 through 5 for other PLU items.								
6 Press  key to complete the setting.								

Advanced features

■ Registering character preset PLU items

After the above setting, the register prints the following receipt by the operation

1 0 0 **PLU**  CA/AMT
/TEND in REG mode.



01-21-2015	15:12
REG	000018
APPLE	\$1.23
CASH	\$ 1 . 23

NOTE

An error occurs if unit price is not set to the PLU number. See page 41 for setting PLU unit price.

Advanced features

Other character settings

You can also set clerk names and receipt messages.

■ Setting receipt message

There are five lines for receipt message as shown below.

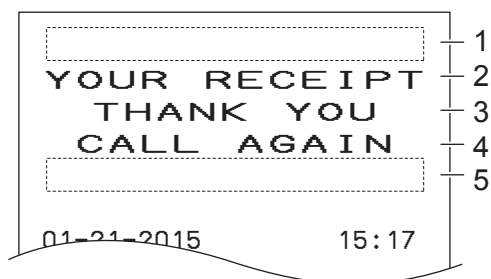

- 1 Line No.1
- 2 Line No.2
- 3 Line No.3
- 4 Line No.4
- 5 Line No.5

You can set message line by line.

Sample Operation

Line No. 1	CASIO	Programming to print CASIO on top of the receipt.
------------	-------	--

Step	Operation
<p>1 Turn the Mode switch to PGM position and press 2 and SUB TOTAL keys to make the Register in the program mode.</p>	<p>2 SUB TOTAL</p>
<p>2 Enter the message number (in this example 1), and press CH key. The Register is set to program the first line of the receipt message.</p>	<p>1 CH</p>
<p>3 Input message of the first line. In this example, CASIO.</p>	<p>X DATE 8 8 8 00 8 <DBL> <C> <▶> <A> 1 1 1 1 4 4 4 <S> <I> 6 6 6 <O></p>
<p>4 Press = CA/AMT /TEND key to set the message of the first line. If you wish to set another line, repeat steps 2 through 4.</p>	<p>= CA/AMT /TEND</p>
<p>5 Press SUB TOTAL key to complete the setting.</p>	<p>SUB TOTAL</p>

Advanced features

■ Issuing receipts with preset message

After the above setting, the Cash Register issues the following receipts when transactions are made in REG mode.

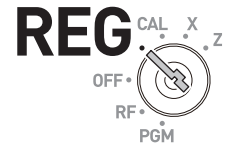

■ Setting clerk name



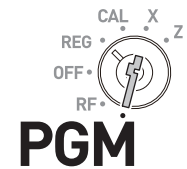





You can set clerk name so that the Register prints the name of the clerk in charge.



NOTE To print clerk name, you must program to force clerk number entry. (See page 68)

Sample Operation

Clerk No. 1	MARY	Programming clerk No. 1 MARY.
-------------	------	-------------------------------

Step	Operation
1 Turn the Mode switch to PGM position and press 2 and  keys to make the Register in the program mode.	2 
2 Enter the clerk number you wish to set name. In this example 1. Then press  key.	1 
3 Program the clerk name using multi typing keyboard.	6 8 1 1 1 <M><A> <R> 3 3 3 <Y>
4 Press  key to set the name. If you wish to set another name, repeat steps 2 through 4.	
5 Press  key to complete the setting.	

Advanced features

■ Printing clerk name on the receipt

After the above setting, the Cash Register issues the following receipt in REG mode when the clerk has signed on.

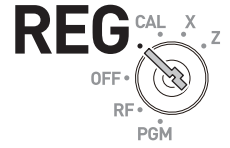

01-21-2015	14:20
REG MARY	000014
DEPT02	\$3.50
DEPT03	\$5.25
CASH	\$8.75

1 Clerk name

NOTE

To print clerk name, you must program to force clerk number entry by D3 of "Overall settings of Cash Register (Set code 0622)". (page 68)

Advanced features

To link PLU items to departments

You can link PLU items to corresponding departments. For example, link PLU 100 (Apple) to Dept. 10 (Fruits).

■ Linking PLU items to departments



Sample Operation

PLU No.	Linking Dept.	Linking PLU 100 to Dept. 10.
100	Dept. 10	

Step	Operation	Printout								
1 Turn the Mode switch to PGM position and press 3 and keys to make the Register in the program mode.		<table border="1"> <tr> <td>01-21-2015</td> <td>16:20</td> </tr> <tr> <td>P03</td> <td>000022</td> </tr> <tr> <td>APPLE</td> <td>#0100</td> </tr> <tr> <td>10</td> <td></td> </tr> </table>	01-21-2015	16:20	P03	000022	APPLE	#0100	10	
01-21-2015	16:20									
P03	000022									
APPLE	#0100									
10										
2 Enter PLU No. you wish to link (100 in this example) and press key.										
3 Enter Dept. number from ten key pad (10 in this example) and press key. Repeat steps 2 and 3 for other PLUs.										
4 Press key to complete the setting.										

NOTE By default, all the PLUs are linked to Dept. 24.

■ About PLU tax status

Tax statuses of PLUs accord with the linked departments as shown below.

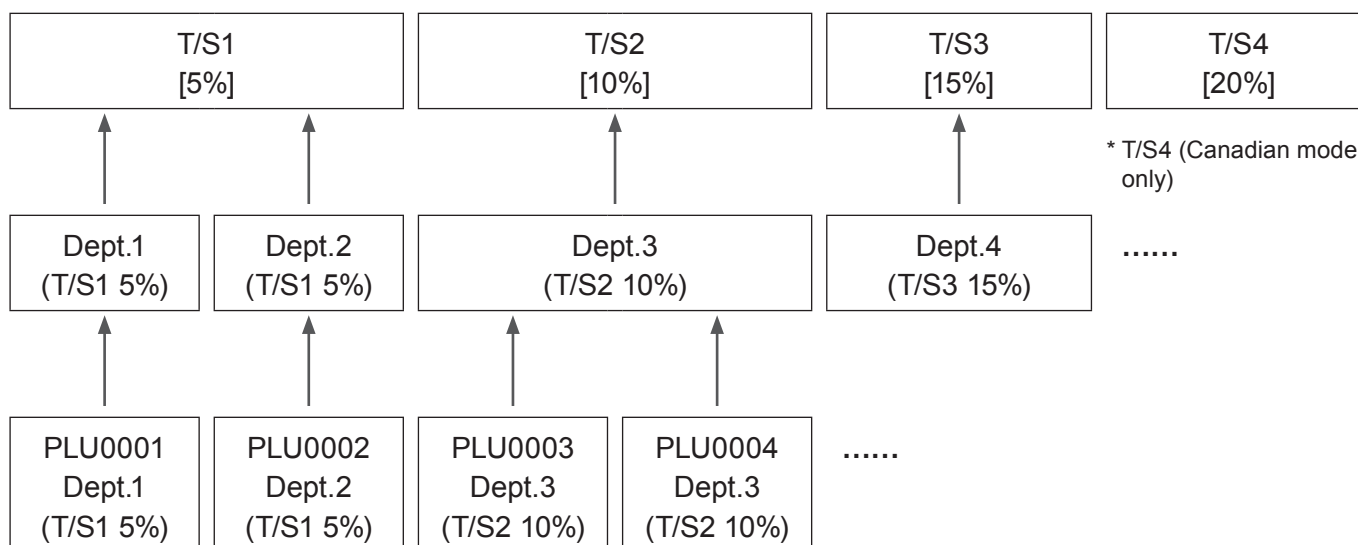

NOTE Please refer to “To preset taxable statuses to departments” (page 36) and “To set tax table” (page 71).

Advanced features

■ Registering PLU item linked to a department

When you register preset PLU item, linked department number is not printed on the receipt but it is categorized in the corresponding department.

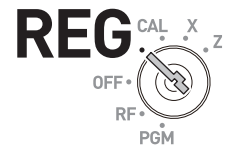

Receipt

	01-21-2015	15:17	
	REG	000018	
1	APPLE	T1	\$1.23
	TA1		\$1.23
	TAX1		\$0.56
	CASH		\$ 1.29

1 PLU 100 with preset name linked to Dept. 10

X/Z Report

	DEPT08	\$10.00
	DEPT09	1
		\$120.00
1	FRUITS	3
		\$21.23
	DEPT11	2
		\$20.00
	DEPT12	1
		\$1.23
	DEPT17	1
		\$10.00
	DEPT24	2
		\$4.23

	GROSS TOTAL	84
		\$895.95
	NET TOTAL	No 57





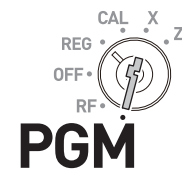

1 Dept. 10 with preset name

Simple settings

■ Simple setting of key catch tones







You can set whether to sound key catch tones or not by simple programming.



Step	Operation
1 Turn the Mode switch to PGM position and press 1 and  keys.	1 
2 Input 10800 from ten key pad and press  key.	1 0 8 0 0 
3 Input 0 (sound key catch tones) or 1 (not sound key catch tones) and press  key. The example on the right is for not sounding key catch tones.	1 

■ Simple setting of double height printing

By this setting, the Cash Register prints receipts with double height characters.

Step	Operation
1 While Mode switch is in PGM position, press 1 and  keys.	1 
2 Input 10200 from ten key pad and press  key.	1 0 2 0 0 
3 Input 0 (normal character height) or 1 (double character height) and press  key. The example on the right is for setting double height characters.	1 

After the above setting, the Cash Register prints the following receipts in REG mode.

21-01-2015	09:40
REG	000003
DEPT01	\$1.00
TOTAL	\$1.00
CASH	\$1.00

Advanced features

Advanced programming

To program advanced features to departments

You can also program the following features to the departments.





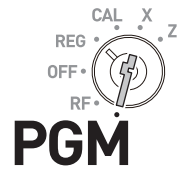

- Minus unit price registration: Unit price registered in the department is stored as minus value. It is useful for refunded items or returned bottles.
- Maximum digit limitation: To prevent wrong unit price entry, you can set the maximum number of digit for numeral entry.
- Single item transaction: This feature finalizes the transaction just by hitting a Dept. key for single item registration. You do not need to press  key to finalize.

Advanced programming of Dept. keys



Sample Operation

	(A)	(B)	(C)	
Dept. 02	Normal Dept.	Maximum 4-digit entry	Single item transaction dept.	Programming Dept. 02 as normal (not negative price) Dept., 4-digit limitation, and single transaction Dept. Dept. 03 as minus price Dept., 5-digit limitation, normal (not single item) Dept.
Dept. 03	Minus Dept.	Maximum 5-digit entry	Normal dept.	

Step	Operation	Printout
1 Turn the Mode switch to PGM position and press 3 and  keys to make the Register in the program mode.	3 	<div style="border: 1px solid black; padding: 5px;"> <p>01-21-2015 14:48 P03 000014</p> <p>DEPT02 #02 0041</p> <p>DEPT03 #03 0150</p> </div>
2 Referring the set code list A, B, and C below, input the setting code. In this example, (A) 0 ; Normal dept., (B) 4 ; 4-digit limitation, and (C) 1 ; Single transaction. After then, press corresponding Dept. key.	0 4 1  (A) (B) (C)	
3 By the same manner, program the set code to Dept. 03 as (A) 1 ; Negative Dept., (B) 5 ; 5-digit limitation, and (C) 0 ; Not single transaction Dept.	1 5 0  (A) (B) (C)	
4 Press  key to complete the setting.		

Advanced features

Set code		
(A)	Normal Dept.	0
	Negative unit price allowable	1
(B)	No digit limitation for unit price	0
	Maximum number of digit for unit prices (up to 8 digits)	1 to 8
	Prohibit manual unit price entry (only preset price is registrable)	9
(C)	Normal registration department	0
	Single item transaction department	1

* Default value of (A), (B), and (C) are "000".

■ Single item transaction

By presetting a Dept. key as single item transaction department, you can transact an item just by pressing the Dept. key without any transaction key.



NOTE

Single item transaction feature is not effective if a unit price is not preset to the corresponding department key.

Step	Operation	Printout
1	Turn the Mode switch to REG position, just press a single item transaction Dept. key. In this example, Dept. 02.	<div style="border: 1px solid black; padding: 5px;"> <pre> 21-01-2015 17:20 REG 000026 DEPT02 \$3.50 CASH \$3.50 </pre> </div>

Advanced features

To program advanced features of the function keys

The following operation sets $\frac{\%}{\text{CLK\#}}$, **CH**, **CR**, $\frac{\text{CHK}}{\text{NS}}$, and $\frac{\text{CA/AMT}}{\text{TEND}}$ keys further features.

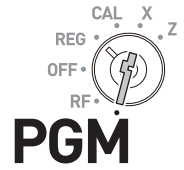

Step	Operation
1 Turn the Mode switch to PGM position and press 3 and $\frac{\text{SUB}}{\text{TOTAL}}$ keys.	3 $\frac{\text{SUB}}{\text{TOTAL}}$
2 Referring the following table, input the program code you wish to program. For example, to program $\frac{\%}{\text{CLK\#}}$ key as %+ (premium) key, enter 0001.	<input type="text"/> <input type="text"/> <input type="text"/> <input type="text"/> D4 D3 D2 D1
3 Press corresponding function key.	$\frac{\%}{\text{CLK\#}}$, CH , CR , $\frac{\text{CHK}}{\text{NS}}$, or $\frac{\text{CA/AMT}}{\text{TEND}}$
4 Press $\frac{\text{SUB}}{\text{TOTAL}}$ key to complete the setting.	$\frac{\text{SUB}}{\text{TOTAL}}$

■ Programming $\frac{\%}{\text{CLK\#}}$ key further functions

Description		Selection	Program code	Default value
D4	Always 0	0	0	<input type="text"/>
D3	Always 0	0	0	<input type="text"/>
D2	Round off, omit fraction, or round up?	Round off = 0 Omit = 1 Round up = 2	0 , 1 or 2	<input type="text"/>
D1	Use $\frac{\%}{\text{CLK\#}}$ key as <%->, <%+>, or <Manual – Tax> key?	%- = 0 %+ = 1 Manual – Tax = 2	0 , 1 or 2	<input type="text"/>

Programming example

To set $\frac{\%}{\text{CLK\#}}$ key as manual tax key, follow the undermentioned operation.

3 $\frac{\text{SUB}}{\text{TOTAL}}$ **0 0 0 2** $\frac{\%}{\text{CLK\#}}$ $\frac{\text{SUB}}{\text{TOTAL}}$

After this setting, you can manually input tax amount. For example, to lay \$1.25 tax on \$50.00 Dept. 01 item, operate as follows.

In REG mode, operate **5 0 00** **+ 1 1 2 5** $\frac{\%}{\text{CLK\#}}$ $\frac{\text{CA/AMT}}{\text{TEND}}$.

01-21-2015	16:15
REG	000024
DEPT01	\$50.00
TAX	\$1.25
CASH	\$51.25

■ Programming CH, CR, CHK/INS, and CA/AMT/TEND keys further functions

Description		Selection	Program code	Default value	
D4	Use Finnish rounding?	a	<input type="checkbox"/> * (a+b+c) Add a, b and c	<input type="checkbox"/> 0	
	Limit last 2 digits of numeral entry 00 or 50? (Only for <input type="checkbox"/> CA/AMT/TEND key)	b			Yes = 1 No = 0
	Limit the last digit of numeral entry 0 or 5? (Except <input type="checkbox"/> CH and <input type="checkbox"/> CR keys.)	c			Yes = 2 No = 0
D3	Prohibit partial payment? (Except <input type="checkbox"/> CH and <input type="checkbox"/> CR keys.)	Yes = 1 No = 0	<input type="checkbox"/> 0 or <input type="checkbox"/> 1	<input type="checkbox"/> 0	
D2	Always 0	0	<input type="checkbox"/> 0	<input type="checkbox"/> 0	
D1	Always 0	0	<input type="checkbox"/> 0	<input type="checkbox"/> 0	

Advanced features

To program advanced features of the Cash Register

To program the advanced settings of the register, please follow the operations shown below.



Step

- 1** While Mode switch is in PGM position, press **3** and keys.
- 2** Referring the following table, input the set code you wish to program and press key. For example, to program overall features of Register, input 0622
- 3** Referring table of each program, input six-digit program code and press key.
- 4** Press key to complete the setting.

Operation

3

(Set code)

D6 D5 D4 D3 D2 D1

(Program code)

Set codes

Set code	Items to set	Set code	Items to set
0322	Tax related printings	0822	Print control of X/Z reports
0422	Country-specific rounding and tax system	1022	Operations in calculator mode
0522	Print control	2022	Display control
0622	Overall settings of the Register		

■ Programming taxable item symbol printing (Set code: 0322)

Description		Selection	Program code	Default value
D6	Always 0	0	<input checked="" type="checkbox"/> 0	<input type="checkbox"/> 0
D5	Print T/S (tax symbol)?	a Yes = 2 No = 0	<input checked="" type="checkbox"/> 0 or <input checked="" type="checkbox"/> 2	<input type="checkbox"/> 2
D4	Print Australian GST message?	b Yes = 4 No = 0	<input checked="" type="checkbox"/> 0 or <input checked="" type="checkbox"/> 4	<input type="checkbox"/> 0
D3	Print TA1 on the receipt?	a Yes = 1 No = 0	<input type="checkbox"/> * (a+b+c) Add a, b and c	<input type="checkbox"/> 7
	Print TA2 on the receipt?	b Yes = 2 No = 0		
	Print TA3 on the receipt?	c Yes = 4 No = 0		
D2	Print TA4 on the receipt?	a Yes = 1 No = 0	<input type="checkbox"/> (a+b) Add a and b	<input type="checkbox"/> 1
	Print VAT (inclusive tax) on receipts?	b Print = 2 Not print = 0		
D1	Always 0	0	<input checked="" type="checkbox"/> 0	<input type="checkbox"/> 0

* Add a, b, and c. For example, to print TA1 (a= 1), TA2 (b=2), and TA3 (c = 4), D3 should be 7.

Programming example

To program Print T/S on receipts (D5 = 2)/Print TA1, TA2, and TA3 on receipts (D3 = 7)/Print TA4 on receipts, and print VAT (D2 = 3), operate as follows.

SUB TOTAL 3 2 2 SUB TOTAL 0 2 0 7 3 0 = CA/AMT/TEND SUB TOTAL
 (Set code) (Set data)

■ Country-specific rounding and tax systems (Set code: 0422)

Description		Selection	Program code	Default value
D6	Rounding system (see tables below)	00 to 13	<input checked="" type="checkbox"/> <input checked="" type="checkbox"/> to <input checked="" type="checkbox"/> <input checked="" type="checkbox"/>	Depend on the region
D5	00: No rounding 01: IF1 02: IF2 03: Denmark 04: Norway 05: Singapore 06: Finland 07: Australia 08: Canada 09: New Zealand (A) 10: New Zealand (B) 11: Malaysia 12: Czech 13: South Africa			
D4	Tax system 0: Single tax (1 to 4) 1: USA 2: Canada 3: Singapore	0 to 3	<input checked="" type="checkbox"/> 0 to <input checked="" type="checkbox"/> 3	Depend on the region
D3	Print invoice number on receipts?	Yes = 1 No = 0	<input checked="" type="checkbox"/> 0 or <input checked="" type="checkbox"/> 1	<input type="checkbox"/> 0
D2	Always 0	0	<input checked="" type="checkbox"/> 0	<input type="checkbox"/> 0
D1	Display rounded value?	a Yes = 1 No = 0	<input type="checkbox"/> (a+b) Add a and b	<input type="checkbox"/> 0
	Allow <input checked="" type="checkbox"/> RA/T/S1 and <input checked="" type="checkbox"/> PO/T/S2 amount only multiples of 0.05? (Australian model only)	b Yes = 2 No = 0		<input type="checkbox"/> 0

Advanced features

Rounding systems for each country

IF 1 rounding	
Last digit of ST	Result
0 to 2	0
3 to 7	5
8 to 9	10

South African rounding	
Last digit of ST	Result
0 to 4	0
5 to 9	5

IF 2 rounding	
Last digit of ST	Result
0 to 4	0
5 to 9	10

New Zealander (A/B) rounding	
Last digit of ST/ CA CG	Result
0 to 4/5	0
5/6 to 9	10

Danish rounding	
Last 2 digits of ST/ CA CG	Result
00 to 24	00
25 to 74	50
75 to 99	100

Malaysian rounding	
Last digit of ST/ CA CG	Result
0 to 2	0
3 to 7	5
8 to 9	10

Singaporean rounding	
Last digit of item, %- REG	Result
0 to 2	0
3 to 7	5
8 to 9	10

Norwegian/Czech rounding	
Last digit of ST	Result
00 to 49	00
50 to 99	100

Finnish rounding	
Last digit of ST/ CA CG	Result
0 to 2	0
3 to 7	5
8 to 9	10

Canadian rounding	
Last digit of ST/ CA CG	Result
0 to 2	0
3 to 7	5
8 to 9	10

Australian rounding	
Last digit of ST/ CA CG	Result
0 to 2	0
3 to 7	5
8 to 9	10

Programming example

To program No rounding: (D6, D5 = 00)/Single tax system: (D4 = 0)/Print invoice No. on receipts: (D3 = 1)/D2 should be 0/Display rounded amount (D1 = 1), operate as follows.

3
SUB TOTAL
0
4
2
2
SUB TOTAL
0
0
0
1
0
1
=
CA/AMT TEND
SUB TOTAL

(Set code) (Set data)

■ Programming print control (Set code: 0522)

Description		Selection	Program code	Default value	
D6	Use receipt or journal?*	a	Receipt = 0 Journal = 1	<input type="checkbox"/> (a+b+c) Add a, b and c	
	Normal print or double length print on receipts?	b	Normal = 0 Tall = 2		
	Print total amount when finalized?	c	Yes = 4 No = 0		
D5	Print receipt message characters or graphic logo?		Character = 0 Graphic = 1	0 or 1	0
D4	Print the time on receipts?		Yes = 0 No = 4	0 or 4	0
D3	Print consecutive number on receipts?	a	Yes = 0 No = 1	<input type="checkbox"/> (a+b+c) Add a, b and c	
	Print total amount by <input type="text" value="SUB TOTAL"/> key?	b	Yes = 2 No = 0		
	Print detailed items on journal?	c	Yes = 0 No = 4		
D2	Always 0		0	0	0
D1	Printing density Normal: 0, Dark: 1, Max. darkness: 2		0 to 2	0 , 1 or 2	0

* See page 75 for simple journal setting.

Programming example

Using journal, Normal print width, Print total amount by subtotal key: (D6 = 1 + 0 + 4)/Character receipt message: (D5 = 0)/Print time on receipts: (D4 = 0)/Not print consecutive number, Print total amount by key (D3 = 1 + 2)/Print density: normal (D1 = 0), operate as follows.

(Set code) (Set data)

Advanced features

■ Overall settings of Cash Register (Set code: 0622)

You can program the following features to the Cash Register.

- (D6) Whether to sound key catch tone or not.
- (D5) Whether to clear the key entry buffer when a receipt is issued.
Whether to reset the consecutive number after Z report.
Allow to finalize minus total amount.
- (D4) Whether to show seconds on the display or not.
- (D3) Whether to use **00** key as <00> or <000> key.
Whether to force clerk number entry before registrations.
- (D2) Whether to use multi typing system or character code entry system (see page 49) for character settings.
- (D1) Whether to store electronic journal (see page 79) and sales data in an SD card or not.

Description		Selection	Program code	Default value
D6	Sound key catch tone?	Yes = 0 No = 4	0 or 4	0
D5	Clear key entry buffer when issuing receipt?	a Yes = 1 No = 0	<input type="checkbox"/> (a+b+c) Add a, b and c	0
	Clear consecutive number after Z report?	b Yes = 0 No = 2		
	Allow minus total finalization?	c Yes = 4 No = 0		
D4	Show seconds on the display?	Yes = 1 No = 0	0 or 1	0
D3	Use 00 key as <000> key?	a Yes = 1 No = 0	<input type="checkbox"/> (a+b) Add a and b	0
	Force clerk number entry?	b Yes = 2 No = 0		
D2	Character set method is multi typing or key code entry system?	Multi typing = 0 Key code = 2	0 or 2	0
D1	Store electronic journal and sales data in an SD card for X report?	a Yes = 1 No = 0	<input type="checkbox"/> (a+b) Add a and b	0
	Store electronic journal and sales data in an SD card for Z report?	b Yes = 2 No = 0		

* Add a, b, and c. For example, to set clear key entry buffer: a = 1, not clearing consecutive number: b = 2, not allowing minus total finalization: c = 4. The set value for (B) is 1 + 2 + 4 = 7.

Programming example

Sound key catch tone: (D6 = 0)/Clear consecutive number, Allow minus total finalization (D5 = 1 + 2 + 4 = 7)/Show seconds on the display: (D4 = 1)/Not use **00** key as 000 key/Force clerk sign on (D3 = 2)/Character setting method is multi typing: (D2 = 0)/Store electronic journal and sales data in an SD for X report/Not storing electronic journal and sales data in an SD card for Z report (D1 = 1), operate as follows.

3 SUB TOTAL
0 6 2 2 SUB TOTAL
0 7 1 2 0 1 = CA/AMT /TEND SUB TOTAL

(Set code) (Set data)

Advanced features

Forcing clerk number entry

In the above program, if you set 2 or 3 to the set value of (D3), the Cash Register emits an alert and asks you to sign on when you operate the Cash Register without entering clerk number.

Clerk number or clerk name (see page 56) will be printed on receipts if clerk number entry is forced. You can use up to eight clerk numbers or names.

1	01-21-2015	16:15	1	Clerk No.
	REG CLERK03	000024		
	DEPT01	\$10.00		
	DEPT02	\$20.00		
	CASH	\$30.00		

■ Print controls of X/Z report (Set code: 0822)

Description		Selection	Program code	Default value
D6	Always 0	0	<input type="checkbox"/> 0	<input type="checkbox"/> 0
D5	Clear electronic journal after Z report?	Yes = 0 No = 1	<input type="checkbox"/> 0 or <input type="checkbox"/> 1	<input type="checkbox"/> 0
D4	Print total refunded amount?	Yes = 0 No = 1	<input type="checkbox"/> 0 or <input type="checkbox"/> 1	<input type="checkbox"/> 0
D3	Print zero amounts on reports?	Yes = 1 No = 0	<input type="checkbox"/> (a+b) Add a and b	<input type="checkbox"/> 0
	Print GT (accumulated amount of the Register) on reports?	Yes = 0 No = 2		
D2	Print invoice numbers on receipts?	Yes = 4 No = 0	<input type="checkbox"/> 0 or <input type="checkbox"/> 4	<input type="checkbox"/> 0
D1	Always 0	0	<input type="checkbox"/> 0	<input type="checkbox"/> 0

■ Calculator mode settings (Set code: 1022)

Description		Selection	Program code	Default value
D6	Always 0	0	<input type="checkbox"/> 0	<input type="checkbox"/> 0
D5	Always 0	0	<input type="checkbox"/> 0	<input type="checkbox"/> 0
D4	Always 0	0	<input type="checkbox"/> 0	<input type="checkbox"/> 0
D3	Always 0	0	<input type="checkbox"/> 0	<input type="checkbox"/> 0
D2	Always 0	0	<input type="checkbox"/> 0	<input type="checkbox"/> 0
D1	Open the drawer when <input type="checkbox"/> CA/AMT/TEND key is pressed?	Yes = 1 No = 0	<input type="checkbox"/> (a+b+c) Add a, b and c	<input type="checkbox"/> 0
	Open the drawer when <input type="checkbox"/> CHK/INS key is pressed?	Yes = 2 No = 0		
	Print number of <input type="checkbox"/> CA/AMT/TEND key depression on X/Z reports?	Yes = 0 No = 4		

Advanced features

■ Display control (Set code: 2022)

Description		Selection	Program code	Default value
D6	Display rear indicator?	Yes = 0 No = 1	0 or 1	0
D5	Always 0	0	0	0
D4	Always 0	0	0	0
D3	Light the illuminator?	Yes = 0 No = 1	0 or 1	0
D2	Illumination off timer. (00 to 59 minutes)		0 0	2 0
D1			to 5 9	

Tax table

To set tax table



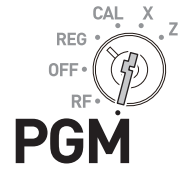





You can set four kinds of tax table. By this table, you can set tax rates, rounding system, and add-in or add-on tax systems.



NOTE The tax rates you have set in “To set the language, date, time, and tax rates” (pages 18 and 19) is replaced by the rate of this setting.

Sample Operation

Setting 7.0 percent tax rate, rounding off, and add-on tax to tax table 1.

Step	Operation
1 Turn the Mode switch to PGM position and press 3 and  keys.	3 
2 Enter tax table number and press [TAX PGM] key. The example on the right is for assigning tax table 1.	1 [TAX PGM]
3 Enter the tax rate in the range from 0.0001 to 99.9999 and press  key. The example on the right is for setting 7.0%.	7 0 
4 Referring the tables below, enter rounding (A), add-in/add-on (B) codes, and press  key. The example on the right is the code for rounding off, and add-on tax.	5 0 0 2  (A) (B)
5 Press  key to complete the setting.	

Rounding system (A)		Add-in/Add-on (B)	
Cut off to 2 decimal places	0 0 0	No specifications	0
Round off to 2 decimal places	5 0 0	Add-on tax	2
Round up to 2 decimal places	9 0 0	Add-in tax (VAT)	3
		Tax on tax	4
		VAT on tax (Thai system)	6

Printing programmed data

Checking your program

You can check programmed data you have set.

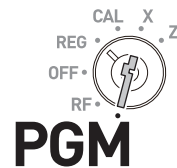

■ To check settings (other than PLU)

Step

Operation

1 Turn the Mode switch to PGM position and press  key.



01-21-2015	16:40	
P03	000028	
FRUITS	#01	1
0000	@0.98	
VEGETABLES	#02	
0000	@2.05	
FISH	#03	
0000	@3.15	
MEAT	#04	
0000	@15.30	
CASH	#01	2
0000		
CHARGE	#02	
0000		
CHECK	#03	3
0000		
CREDIT	#04	
0000		
-	#07	4
%-	#08	
0000	0%	
T/S1	#23	4
0100		
T/S2	#24	
0200		
10200	0	5
10800	0	6
10900	0	7
0001-22	000012	8
0002-22	000000	
0003-22	020730	
0004-22	000101	
0005-22	501300	
	000000	

- 1 Dept. name and price
- 2 Transaction key setting
- 3 Reduction and discount settings
- 4 Tax shift settings
- 5 Receipt/Journal setting
- 6 Key catch tone setting
- 7 Storing in SD card setting
- 8 Set code and set data

0028-22	
MARRY	#01
JOHN	#02
MAC	#03
CLERK04	#04
CLERK05	#05
CLERK06	#06
CLERK07	#07
CLERK08	#08
0001-25	
TAX1	5%
TAX1	0000
TAX1	5003
0002-25	
TAX2	10%
TAX2	0000
TAX2	5003
0003-25	
TAX3	15%
TAX3	0000
TAX3	5003
0004-25	
TAX4	20%
TAX4	0000
TAX4	5003
CASIO	
	#01
	#02
YOUR RECEIPT	#03
THANK YOU	#04
CALL AGAIN	#05
STATES	#06

- 9 Clerk names settings
- 10 Tax rate settings
- 11 Receipt message settings

Advanced features

■ To check PLU settings



Step

1 While Mode switch is in PGM position, enter **1 0** and press **SUB TOTAL** key.

Unit prices and item names preset to PLUs are printed.

Operation

1 0 **SUB TOTAL**

	01-21-2015	17:05	
	P01	000030	
1	APPLE	#0001	3
2	01	@1.80	4
	ORANGE	#0002	
	01	@2.50	
	STRAWBERRY	#0003	
	01	@3.20	
	PINEAPPLE	#0004	
		@18.30	

- 1 PLU item name
- 2 Linked Dept.
- 3 PLU No.
- 4 PLU unit price

To record business journal

To use journal paper

Instead of issuing receipts, you can roll the printouts of transactions on the take up reel so that you can use the printouts as business journal.

■ Programming to print business journal

The following operations set the Cash Register to print business journal. By this setting, the printer omits receipt message, and the take up reel rolls the paper up.

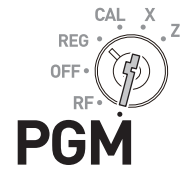

Step	Operation	Printout						
1 Turn the Mode switch to PGM position and press 1 and SUB TOTAL keys to make the Register in the program mode.	1 SUB TOTAL	<div style="border: 1px solid black; padding: 5px;"> <table style="width: 100%; border-collapse: collapse;"> <tr> <td style="width: 50%;">01-21-2015</td> <td style="width: 50%;">11:45</td> </tr> <tr> <td>P01</td> <td>000005</td> </tr> <tr> <td>PRINTER</td> <td>JOURNAL</td> </tr> </table> </div>	01-21-2015	11:45	P01	000005	PRINTER	JOURNAL
01-21-2015	11:45							
P01	000005							
PRINTER	JOURNAL							
2 Press 1 and CH keys. The Register is set as journal printer.	1 CH							
3 Press SUB TOTAL key to complete the setting.	SUB TOTAL							

NOTE If you wish to resume receipt printing press **0** and **CH** keys in step 2.

■ Setting journal paper

1 Remove the printer cover by lifting it up.

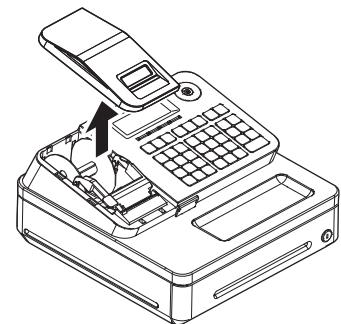

2 Press **FEED** key so that the paper is fed about 15 centimeters.

3 Remove the left side plate from the take up reel.

Advanced features

- 4 Clip the paper between the shaft and hook by rolling the paper from top of the hook.
- 5 Roll the reel a few turns so that it holds the paper securely. After then replace the left side plate.

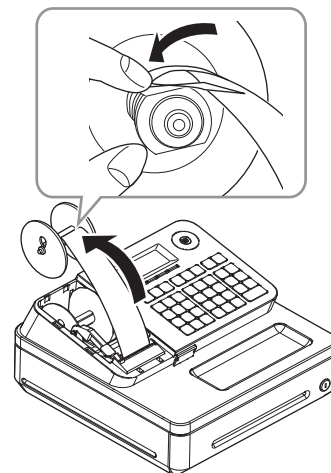

- 6 Place the take up reel behind the printer. Be sure that the shaft of the reel is in the groove of the compartment. Press **FEED** key to reduce a slack of the paper. Make sure that the paper is rolled securely.
- 7 Replace the printer cover.

■ Compressed journal print

To save the paper, you can set the Register to print journals with compressed numbers and characters. To set compressed journal printing, press [PAPER SAVING] key while the Register is programmed to be journal printer.



01-21-2015	18:00
REG	000027
DEPT01	\$10.00
DEPT02	\$20.00
DEPT03	\$30.00
CASH	\$60.00

NOTE To resume normal journal printing, press [PAPER SAVING] key again.

Electronic journal

The Cash Register stores daily transactions in the memory and, you can call transactions in specific date.

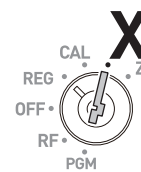

■ To call business journal of specific date

Step	Operation	Printout
1 Turn the Mode switch to X position and press 5 8 and press keys.	5 8	01-21-2015 15:30 X 000025
2 Input the date you wish to call in order of MM/DD/YY and press key. The example on the right is January 21 2015. If you wish to obtain all the past sales data, just press key without entering date.	0 1 2 1 1 5	0058 EJ X 01-21-2015 13:15 P01 000020 01-21-2015 13:18 X 000021 0000 DAILY X 01-21-2015 14:42 REG 000015 DEPT01 \$1.00 DEPT02 \$2.00 DEPT03 \$3.00 CASH \$6.00
3 If you wish to call specific transaction, input consecutive number of the transaction. If not, press key. The Register prints transactions of the specific date.		01-21-2015 15:25 X 000024 0000 DAILY X 01-21-2015 15:30 X 000025 0058 EJ X

Advanced features

■ To clear electronic journal data

Perform the above operations in Z mode.

NOTE To save electronic journal data in an SD card, follow "Saving sales data and electronic journal data in an SD card" (page 79) first.

Advanced features

To utilize an SD card

To insert an SD card

Important

- Insert the SD card in the direction so that the label of the card is facing upward.
- To extract the SD card, turn the Mode switch off and push the card once lightly. As the card will be popped out, pull it out.

1 Open the SD card compartment cover.

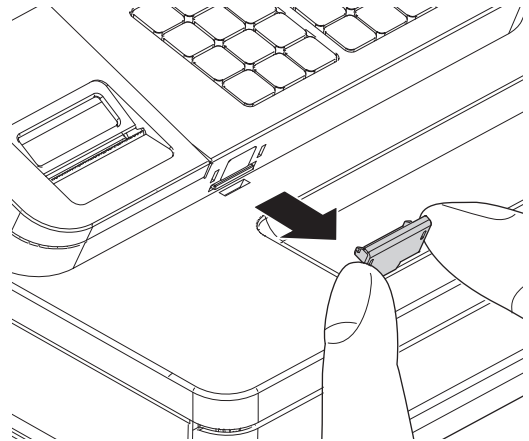

2 Insert an SD card all the way into the SD card slot.
Diagonally cut part should be right upper corner.

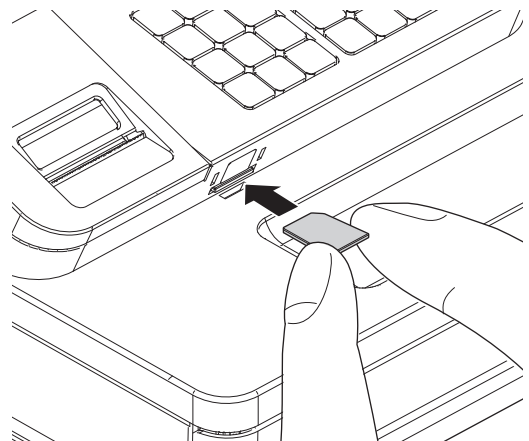







Advanced features

To save or recall data in or from SD card

■ Saving sales data and electronic journal data in an SD card







You can store X, Z, or electronic journal data in an SD card.



Step	Operation
1 Turn the Mode switch to PGM position and press 1 and  keys.	1 
2 Enter 1 0 9 0 0 from ten key pad and press  key.	1 0 9 0 0 
3 Input 1 , 2 or 3 key depending on the storing data press  key after then. 0 : Does not save in SD card 1 : For X report 2 : For Z report 3 : For X and Z reports	1 , 2 or 3 
4 Issue the report you wish to store. After issuing, selected data is saved in the SD card. <ul style="list-style-type: none"> • Daily Z report • Periodic X report • Periodic Z report • PLU X report • PLU Z report 	

■ To back up Cash Register settings

You can back up the set data you have programmed in an SD card.

Step	Operation	Printout
1 While Mode switch is in PGM position, press 7 and  keys.	7 	<pre> 01-21-2015 17:15 P07 000010 ----- (4114)----- SD Data Backup Normal End ----- </pre>
2 Enter 4 1 1 4 keys from ten key pad and press  key.	4 1 1 4 	
3 Press  key. After for a while, Cash Register prints "Data Backup Normal End".		

Advanced features

■ To restore backed up program data from SD card

Step	Operation	Printout
1 While Mode switch is in PGM position, press 7 and SUB TOTAL keys.	7 SUB TOTAL	<pre>01-21-2015 17:18 P07 000011 ----- (4104)----- SD Data Restore Normal End -----</pre>
2 Enter 4 1 0 4 keys from ten key pad and press SUB TOTAL key.	4 1 0 4 SUB TOTAL	
3 Press CA/AMT /TEND key. After for a while, Cash Register prints “Data Restore Normal End”.	CA/AMT /TEND	

Advanced features

Calculator mode

To use Cash Register as a Calculator

Using $\boxed{+1}$, $\boxed{-2}$, $\boxed{\times 3}$, $\boxed{\div 4}$, $\boxed{AC\ C}$, $\boxed{RA/MB}$ and $\boxed{= CA/AMT/TEND}$ keys, you can use the Cash Register as a Calculator. You can also use the calculator during registrations.

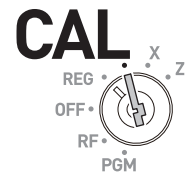

Example

Sample calculation

Operation

Display

$5 + 3 - 2 =$

$\boxed{5} \boxed{+1} \boxed{3} \boxed{-2} \boxed{2} \boxed{= CA/AMT/TEND}$



RPT T1 T2 T3 T4 TOTAL CHANGE

$(23 - 56) \times 78 =$

$\boxed{2} \boxed{3} \boxed{-2} \boxed{5} \boxed{6} \boxed{\times 3} \boxed{7} \boxed{8} \boxed{= CA/AMT/TEND}$



RPT T1 T2 T3 T4 TOTAL CHANGE

12 percent on .1500

$\boxed{1} \boxed{5} \boxed{0} \boxed{0} \boxed{\times 3} \boxed{1} \boxed{2} \boxed{\% / CLK\#}$



RPT T1 T2 T3 T4 TOTAL CHANGE

Advanced features

Specifications

Entry	10-key system; Buffer memory 8 keys (2-key roll over)
Main display	20 characters x 1 line 10-digit numeral x 1 line
Customer display	Amount 8 digits (zero suppression)
PRINTER	
Receipt/Journal	Thermal alpha-numeric system 24 digits, receipt on/off key
Paper roll	58 (W) x 80 (D) mm
Paper feed	Receipt or Journal
Print speed	10 lines/second max.
Listing capacity	
Amount	99999999
Quantity	9999.999
Tendered amount	9999999999
Percent	99.99
Tax rate	9999.9999
Numbers	9999999999
Chronological data	
Date print	Automatic date printout on receipt or journal, automatic calendar
Time print	Automatic time printout on receipt or journal, 24-hour system
Alarm	Key catch tone, error alarm
Memory protection battery	The effective service life of memory protection batteries (two new size AA manganese batteries) is approximately one year from installation into the machine.
Power supply/power consumption	See the rating plate.
Operation temperature	0°C to 40°C (32°F to 104°F)
Humidity	10 to 90%
Dimensions	180 mm (H) x 410 mm (W) x 450 mm (D) (7 3/32"(H) x 16 5/32"(W) x 17 23/32"(D)) with medium size drawer. 167 mm (H) x 326 mm (W) x 345 mm (D) (6 9/16"(H) x 12 27/32"(W) x 13 9/16"(D)) with small size drawer.
Weight	7.3 kg (16.0 lbs.) with medium size drawer 3.3 kg (7.2 lbs.) with small size drawer
Accessories	Paper roll, Mode keys, Drawer key, Bill clip plate, Quick Start Guide

* Specifications and design are subject to change without notice.

Character code	84
Error code	85
About sales data storage in an SD card.....	86
Tax table programming	88
Programming U.S.tax tables.....	88
Index	92

Character code

Chara	Code	Chara	Code	Chara	Code	Chara	Code	Chara	Code	Chara	Code	Chara	Code
Space	32	0	48	@	64	P	80	'	96	p	112	Ç	128
!	33	1	49	A	65	Q	81	a	97	q	113	ü	129
"	34	2	50	B	66	R	82	b	98	r	114	é	130
#	35	3	51	C	67	S	83	c	99	s	115	â	131
\$	36	4	52	D	68	T	84	d	100	t	116	ä	132
%	37	5	53	E	69	U	85	e	101	u	117	à	133
&	38	6	54	F	70	V	86	f	102	v	118	å	134
'	39	7	55	G	71	W	87	g	103	w	119	ç	135
(40	8	56	H	72	X	88	h	104	x	120	ê	136
)	41	9	57	I	73	Y	89	i	105	y	121	ë	137
*	42	:	58	J	74	Z	90	j	106	z	122	è	138
+	43	;	59	K	75	[91	k	107	{	123	ï	139
,	44	<	60	L	76	\	92	l	108		124	î	140
-	45	=	61	M	77]	93	m	109	}	125	ì	141
.	46	>	62	N	78	^	94	n	110	~	126	Ä	142
/	47	?	63	O	79	_	95	o	111		127	Å	143

Chara	Code	Chara	Code	Chara	Code	Chara	Code	Chara	Code	Chara	Code	Chara	Code
É	144	á	160	■	176	ℒ	192	ø	208	Ó	224	-	240
æ	145	í	161	■	177	⊥	193	ð	209	ß	225	±	241
Æ	146	ó	162	■	178	⊥	194	Ê	210	Ô	226	_	242
ô	147	ú	163		179	†	195	Ë	211	Ò	227	3/4	243
ö	148	ñ	164	†	180	—	196	È	212	ö	228	¶	244
ò	149	Ñ	165	Á	181	†	197	€	213	Õ	229	§	245
û	150	ª	166	Â	182	ã	198	í	214	μ	230	÷	246
ù	151	º	167	À	183	Ã	199	î	215	þ	231	¸	247
ÿ	152	¿	168	©	184	ℒ	200	ï	216	Ɔ	232	°	248
Ö	153	®	169	†	185	⊥	201	Ɔ	217	Ú	233	¨	249
Ü	154	¬	170		186	⊥	202	⊥	218	Û	234	•	250
ø	155	1/2	171	⊥	187	⊥	203	■	219	Ù	235	¹	251
£	156	1/4	172	Ɔ	188	†	204	■	220	ý	236	³	252
Ø	157	¡	173	¢	189	—	205		221	Ý	237	²	253
×	158	«	174	¥	190	†	206	ì	222	—	238	■	254
f	159	»	175	ı	191	⊥	207	■	223	'	239	Double size	255

Error code

Error code	Guidance on the display	Cause	Solution
E001	Wrong mode	Mode switch position has been changed before finalization.	Return the Mode switch to its original setting and finalize the operation.
E008	Please sign on	Registration without entering a clerk number.	Input a clerk number.
E010	Close the platen arm	Platen arm is not closed.	Close the platen arm firmly.
E014	Paper end	There is no paper.	Insert paper.
E029	In the tender operation	Item registration is prohibited while partial tendering.	Finalize the transaction.
E046	REG buffer full	Register buffer is full.	Finalize the transaction.
E081	EJ Full	Electronic journal memory is full.	Print reset (Z) report of electronic journal.
E090	Totals remain in the memory	Totals not cleared at the end of the day.	Perform reset (Z) reporting.
E100	Insert SD	No SD card is inserted.	Insert an SD card.
E101	Illegal Format	SD card is not formatted correctly.	Format the SD card.
E102	File not found	There is no relevant file in the SD card.	Create the file in the SD card.
E103	SD memory full	No space in the SD card.	Create space in the SD card.
E104	Check the write protect switch	Write protect switch of the SD card is on.	Turn the write protect switch off.
E109	SD card Error End	SD card error	Format or replace the SD card.
E139	Negative balance is not allowed	The result of the transaction is minus.	Register properly

About sales data storage in an SD card

Storing sales data in an SD card depends on the setting of 10900 Saving sales data and electronic journal data in an SD card.

■ Totalizers to store sales data

The following files data are subject to be stored. Group range, department range, or flash report data will not be stored.

001	Fixed adder
002	Free function
004	PLU
005	Department
011	Clerk
020	Grand total

■ Folder and file names of stored sales data

<Folder name>

\CASIO\SES100\XZ\yyyy\mm\

yyyy: Year

mm: Month

<File name>

Xxxx_dda.CSV

X: Mode X or Z

xxx: 3-digit file number

dd: date

a: Identifier for the same file name

The first save of the day: none

The second save (in the same folder) of the day: A

The fourth save (in the same folder) of the day: B

⋮

The 27th save (in the same folder) of the day: Z

The 28th save (in the same folder) of the day: Error (SD CARD FULL error)

<Example>

File names of lump X report

Issuing lump X report on March 13, 2015.

↓

↓ The following files are created.

↓

\CASIO\SES100\XZ\2015\03\X001_13.CSV
 X002_13.CSV
 X005_13.CSV
 X011_13.CSV

↓

Issuing lump X report on the same day.

↓

\CASIO\SES100\XZ\2015\03\X001_13A.CSV (with the extension "A")
 X002_13A.CSV (ditto)
 X005_13A.CSV (ditto)
 X011_13A.CSV (ditto)

■ CSV file format of the sales data

Sales data are stored in the CSV format as described below.

Number of fields vary by the type of the totalizer.

```
"MACHINE"      ", "MC#01"      "
"MODE"         ", "X"          "
"Z COUNTER"    ", "0000"       "
"DATE"         ", "16-03-2015"
"TIME"        ", "21:39"

"RECORD"      ", "DESCRIPTOR" ", "QUANTITY/No" ", "AMOUNT"  "
"0001", "GROSS"  ", "0", "0.00"
"0002", "NET"    ", "0", "0.00"
"0003", "CAID"  ", "0", "0.00"
~              ~
```

■ Folder and file names of electronic journal

<Folder name>

\CASIO\SES100\XZ

<File name>

EJddmmyy.TXT

EJ.....Fixed

dd.....Date

mm...Month

yy.....Year

Tax table programming

Programming U.S. tax tables

Before you can program a U.S. tax table, you must first calculate the program data. The partial tax table shown below is for a tax rate of 7.0%. A tax amount is applied for each price range, which is defined by a low end minimum break point. If you subtract each maximum break point from the next lower maximum break point, you should soon be able to see certain patterns. In a cyclic pattern, the differences in maximum breakpoints form a regularly repeating cycle. A pattern which does not fit the cyclic pattern is called non-cyclic pattern.

Though rare, it is conceivable that you can find that subtracting maximum breakpoints results in an one big non-cyclic pattern. In this case, you won't be able to use automatic tax calculation, and must enter the tax for each transaction manually or use a tax rate.

■ Example 1: Add-on rate tax

Preparation

Tax rate (2-digit for integer + 4-digit for decimal)	7.0%	
Tax table maximum value ("0" means unlimited)	0 (no limitation)	
Rounding/tax table system code	5002 (Round off)	
Sum of a cyclic pattern	0] No need to enter.
Number of values in each cyclic pattern	0	
Number of values in each non-cyclic pattern	0	
Actual value of difference of the non-cyclic and cyclic values 0	0	

Programming procedure:

NOTE Refer to page 71 "To set tax table" for setting tax table.

■ Example 2: Without rate tax

Preparation

TAX (6%)	Price range		Max. break point		Difference	Pattern
	Min. break point	Max. break point	Upper	Lower		
\$.00	\$.01	\$.10	10	0	10	Non-cyclic
.01	.11	.24	24	10	14	
.02	.25	.41	41	24	17	Cyclic
.03	.42	.58	58	41	17	
.04	.59	.74	74	58	16	Cyclic
.05	.75	.91	91	74	17	
.06	.92	1.08	108	91	17	Cyclic
.07	1.09	1.24	124	108	16	
			124		17	
					17	

Tax rate (2-digit for integer + 4-digit for decimal)	0% (Table only)
Maximum table amount ("0" means unlimited)	0 (Table only)
Rounding system (A) and tax system of add-in or add-on (B) codes (see pages 60 and 61)	01 (Table only)
Sum of a cyclic pattern	50 (17 + 17 + 16)
Number of values in each cyclic pattern	3
Sum of non-cyclic values	24 (10 + 14)
Actual value of difference of the non-cyclic and cyclic values	10, 14, 17, 17, 16

Programming procedure:

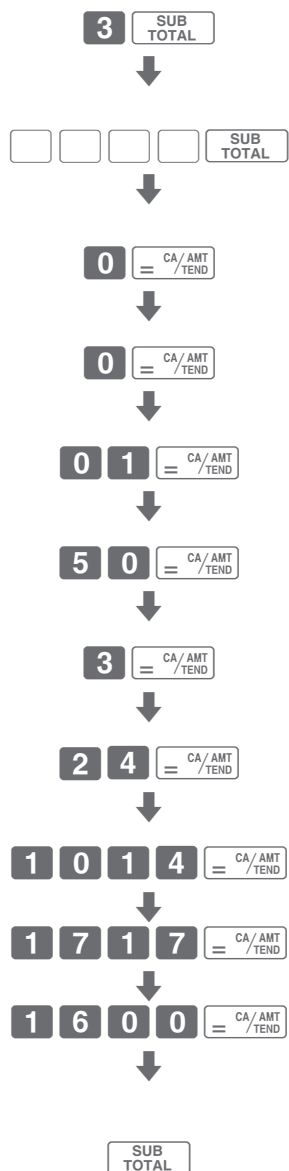

Tax table 1= 0 1 2 5

Tax table 2= 0 2 2 5

Tax table 3= 0 3 2 5

Tax rate (2-digit for integer + 4-digit for decimal)

Maximum table amount ("0" means unlimited)

Rounding system (A) and tax system of add-in or add-on (B) codes (see pages 60 and 61)

Sum of a cyclic pattern

Number of values in each cyclic pattern

Sum of non-cyclic values

Actual value of difference of the non-cyclic and cyclic values

You must enter these values in 4-digit block. If the last block comes out to be only two digits, add two zeros.

Appendix

■ Example 3: With rate tax:

Preparation

TAX (7%)	Price range		Max. break point		Difference	Pattern
	Min. break point	Max. break point	Upper	Lower		
\$.00	\$.01	\$.07	7	0 =	7	Non-cyclic
.01	.08	.21	21	7 =	14	Cyclic
.02	.22	.35	35	21 =	14	
.03	.36	.49	49	35 =	14	
.04	.50	.64	64	49 =	15	
.05	.65	.78	78	64 =	14	
.06	.79	.92	92	78 =	14	
.07	.93	1.07	107	92 =	15	
.08	1.08	1.21	121	107 =	14	Cyclic
.09	1.22	1.35	135	121 =	14	
.10	1.36	1.49	149	135 =	14	
.11	1.50	1.64	164	149 =	15	
.12	1.65	1.78	178	164 =	14	
.13	1.79	1.92	192	178 =	14	
.14	1.93	2.07	207	192 =	15	
1.40	19.93	20.07				

On all sales above \$20.07, compute the tax at the rate of 7 %.

Tax rate (2-digit for integer + 4-digit for decimal)	7%
Maximum table amount	2007
Rounding system (A) and tax system of add-in or add-on (B) codes (see pages 60 and 61)	0002 (Cut off & table + rate)
Sum of a cyclic pattern	100 (14 + 14 + 14 + 15 + 14 + 14 + 15)
Number of values in each cyclic pattern	7
Sum of non-cyclic values	7
Actual value of difference of the non-cyclic and cyclic values	14, 14, 14, 15, 14, 14, 15

Programming procedure:

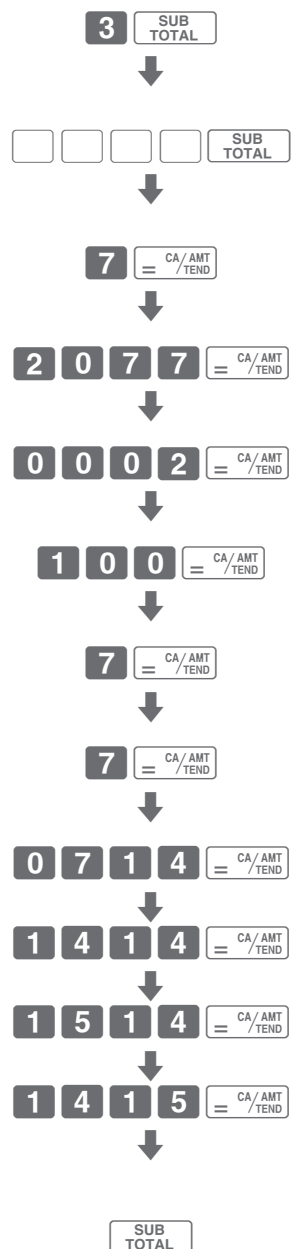

Tax table 1= 0 1 2 5

Tax table 2= 0 2 2 5

Tax table 3= 0 3 2 5

Tax rate (2-digit for integer + 4-digit for decimal)

Maximum table amount ("0" means unlimited)

Rounding system (A) and tax system of add-in or add-on (B) codes (see pages 60 and 61)

Sum of a cyclic pattern

Number of values in each cyclic pattern

Sum of non-cyclic values

Actual value of difference of the non-cyclic and cyclic values

You must enter these values in 4-digit block. If the last block comes out to be only two digits, add two zeros.

Index

Advanced features of function keys	
To program advanced features of function keys	62, 63
Calculator mode	
To program calculator functions (Set code 1022).....	69
To use Cash Register as a calculator	81
Change calculation	
To register with change calculation.....	24
Character setting	
Character keyboard	49
To preset characters to departments	51
To preset characters to PLU items.....	52
To preset clerk characters	55
To preset receipt messages	54
Correction	
To correct erroneous item input	32
To correct immediately after registration.....	33
Date/Time	
To set date and time	21
To check date and time	21
Department	
Department shift.....	13, 25
To limit departments' digit.....	60
To preset names to departments	39, 51
To preset unit prices to departments	38
To program minus department	60
To register items with preset department names.....	40
To register items with preset unit prices.....	38
Discount	
Discount on items	27
Discount on total amount	27
To register items with preset discount rate	35
To set discount rate to % key	35
Display	
Display	12, 50
To program display control (Set code 2022)	70

Electronic journal	
To call business journal of specific date.....	77
To clear business journal data	77
Help	
Help guidance	34
Journal	
To print compressed journal	13, 76
To program to print business journal (Set code 0522).....	67
To program to use business journal.....	75
To set journal paper	75
Multiplication	
Multiple items registration using multiplication key	13, 25
Overall settings	
To program overall settings of Cash Register (Set code 0622).....	68
To program to force clerk number entry (Set code 0622).....	68
Paper saving mode	
Paper saving mode.....	13, 48, 76
Payments	
Paying other than cash	26
Split payment	26
PLU	
To link PLU items to departments.....	57
To preset names to PLU items	42, 52
To preset PLU unit prices	41
To register PLU items.....	43
Price reduction	
To register items with price reduction	29
Print control	
To program print controls (Set code 0522)	67
Program check	
To check PLU programs.....	74
To check your program	72
Receipt	
To set to not print receipts	48
To set receipt paper.....	16, 17
Reference number	
To print reference number	31
Refund	
To register refunded items	30

Appendix

Sales report

To print daily sales report.....	44
To print periodic sales report.....	45
To program X/Z reports printing (Set code 0822).....	69
X report.....	44
Z report.....	44

SD card

To back up Cash Register settings in an SD card.....	79
To restore backed up program data to Cash Register.....	80
To save sales data and electronic journal in an SD card.....	79

Single item transaction

To program single item transaction	60
To register single item transaction	61

Tax

To check tax amount.....	44, 45
To program country-specific rounding and tax system (Set code 0422)	65
To program taxable item printing (Set code 0322)	65
To set add-in or add-on tax	71
To set tax table.....	71

Taxable status

To preset taxable statuses to departments	36
---	----

CASIO®



Free Manuals Download Website

<http://myh66.com>

<http://usermanuals.us>

<http://www.somanuals.com>

<http://www.4manuals.cc>

<http://www.manual-lib.com>

<http://www.404manual.com>

<http://www.luxmanual.com>

<http://aubethermostatmanual.com>

Golf course search by state

<http://golfingnear.com>

Email search by domain

<http://emailbydomain.com>

Auto manuals search

<http://auto.somanuals.com>

TV manuals search

<http://tv.somanuals.com>