



Dell P2418HZm

User's Guide

Monitor Model: P2418HZm
Regulatory Model: P2418HZc



-  **NOTE:** A NOTE indicates important information that helps you make better use of your computer.
-  **CAUTION:** A CAUTION indicates potential damage to hardware or loss of data if instructions are not followed.
-  **WARNING:** A WARNING indicates a potential for property damage, personal injury, or death.

Copyright © 2018–2019 Dell Inc. or its subsidiaries. All rights reserved. Dell, EMC, and other trademarks are trademarks of Dell Inc. or its subsidiaries. Other trademarks may be trademarks of their respective owners.

2019 – 3

Rev. A01

Contents

About your monitor	5
Package contents.....	5
Product features.....	7
Identifying parts and controls.....	8
Monitor specifications.....	12
Universal serial bus (USB) interface	22
Plug and play capability	25
LCD monitor quality and pixel policy.....	25
Maintenance guidelines.....	25
Setting up the monitor	26
Attaching the stand.....	26
Connecting your monitor	28
Organizing cables	30
Disconnecting the monitor stand.....	31
Wall mounting (optional).....	32
Operating your monitor.....	33
Power on the monitor.....	33



Using the front panel controls	33
Using the on-screen display (OSD) menu	37
Setting up your monitor.....	49
Using the Tilt, Swivel, and Vertical Extension.....	50
Operating the webcam cover shutter	52
Installing the monitor IR Camera driver	53
Setting up Windows Hello.....	54
Setting up the monitor webcam as default setting.....	57
Setting up the monitor speaker as default setting	61
Troubleshooting	65
Self-test	65
Built-in diagnostics	67
Common problems	68
Product-specific problems	70
Universal serial bus (USB) specific problems.....	71
Microsoft® Skype for Business® Specific Problems.....	71
Appendix	73
FCC notices (U.S. Only) and other regulatory information.....	73
Contacting Dell.....	73







About your monitor

Package contents

Your monitor ships with the components shown below. Ensure that you have received all the components and [Contacting Dell](#) if something is missing.

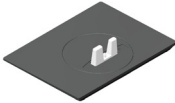
 **NOTE:** Some items may be optional and may not ship with your monitor. Some features or media may not be available in certain countries.

	Monitor
	Stand riser
	Stand base
	Power cable (varies by country)



	<p>VGA cable</p>
	<p>DP Cable</p>
	<p>USB 3.0 Upstream Cable (Enables the USB Ports on the Monitor)</p>
	<ul style="list-style-type: none"> • Quick Setup Guide • Safety and Regulatory Information



Product features

The **Dell P2418HZm** flat panel display has an active matrix, Thin-Film Transistor (TFT), Liquid Crystal Display (LCD), and LED backlight. The monitor features include:

- **P2418HZm:**60.47 cm (23.8 inch) viewable area display (measured diagonally). 1920 x 1080 resolution, plus full-screen support for lower resolutions.
- Plug and play capability if supported by your system.
- Features built-in 2MP Full HD image sensor and dual IR LEDs with infrared camera at the top bezel for top notch video quality.
- Comes with 2 x 5W integrated front-firing speakers and dual mic array with noise cancellation to provide a rich audio experience.
- VGA, HDMI and DisplayPort connectivity.
- Equipped with 1 USB upstream port and 2x USB2.0/ 2x USB3.0 downstream ports (including 1x USB3.0 BC1.2 charging port).
- On-Screen Display (OSD) adjustments for ease of set-up and screen optimization.
- Security-cable slot.
- Tilt,swivel,height and rotate adjustment capabilities.
- Removable stand and Video Electronics Standards Association (VESA™) 100 mm mounting holes for flexible mounting solutions.
- 0.3 W power consumption when in the sleep mode.
- Optimize eye comfort with a flicker-free screen and ComfortView feature which minimizes blue light emission.
- Certified for Skype for Business.
- Certified for Windows Hello (Face Authentication) and supports Microsoft Cortana.



Identifying parts and controls

Front View

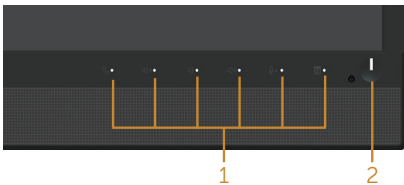
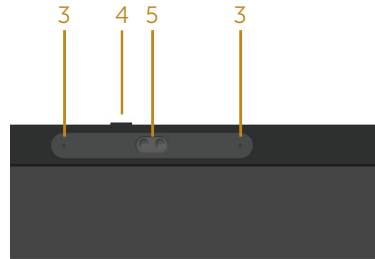

Front panel controls

Label	Description
1	Function buttons (For more information, see Operating your monitor)
2	Power on/off button (with LED indicator)
3	Microphone
4	Webcam cover shutter
5	Webcam (Full HD)

 **NOTE:** For displays with glossy bezels the user should consider the placement of the display as the bezel may cause disturbing reflections from surrounding light and bright surfaces.



Back View



Back View without monitor stand

Back View with monitor stand

Label	Description	Use
1	VESA mounting holes (100 mm x 100 mm - behind attached VESA Cover)	Wall mount monitor using VESA-compatible wall mount kit (100 mm x 100 mm).
2	Regulatory label	Lists the regulatory approvals.
3	Stand release button	Release stand from monitor.
4	Security lock slot	Secures monitor with security lock(sold separately).
5	Barcode, serial number, and Service Tag label	Refer to this label if you need to contact Dell for technical support.
6	Cable management slot	Use to organize cables by placing them through the slot.



Side View

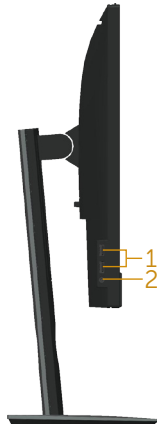

Label	Description	Use
1	USB downstream port 2x USB 3.0 downstream port (including 1x USB3.0 BC1.2 charging port)	Connect your USB device. NOTE: To use this port, you must connect the USB cable (shipped with your monitor) to the USB-upstream port on the monitor and to your computer.
2	Headphone-out / Microphone-in combo jack	Connect the headset.



Bottom View

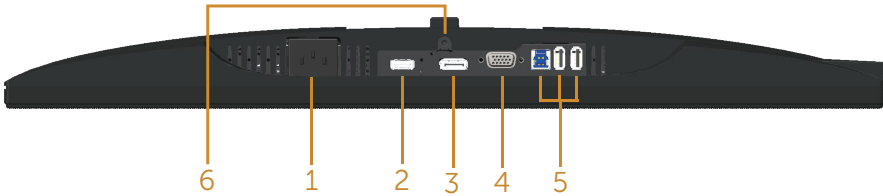

Bottom view without monitor stand

Label	Description	Use
1	Power port	Connect the power cable.
2	HDMI port	Connect your computer with HDMI cable(optional).
3	DP port	Connect your computer to the monitor using a DP cable.
4	VGA port	Connect your computer with VGA cable.
5	USB connector (x2 downstream, x1 upstream)	Connect the USB cable that came with your monitor to the computer. Once the cable is connected, you can use the USB connectors on the rear side and bottom side of the monitor.
6	Stand lock feature	To lock the stand to the monitor using a M3 x 6mm screw (screw not included).



Monitor specifications

Model	P2418HZm
Screen type	Active matrix - TFT LCD
Panel type	In-Plane Switching Technology
Viewable image	
Diagonal	604.70 mm (23.80 in)
Horizontal, Active Area	527.04 mm (20.75 in)
Vertical, Active Area	296.46 mm (11.67 in)
Area	1562.46 cm ² (242.15 in ²)
Pixel pitch	0.2745 mm x 0.2745 mm
Pixel per inch (PPI)	93
Viewing angle (vertical / horizontal)	178° (vertical) typical 178° (horizontal) typical
Brightness	250 cd/m ² (typical)
Contrast ratio	1000: 1 (typical) 8 Million: 1 (Dynamic)
Aspect ratio	16:9
Display screen coating	Anti-glare with 3H hardness
Backlight	White LED edgelight system
Response time	6 ms (gray to gray)
Color depth	16.7 million colors
Color support	83% (CIE 1976), 72% (CIE 1931)
Built-in devices	USB 3.0 super-speed hub (with 1x USB 3.0 upstream port, 2x USB 3.0 downstream ports and 2x USB2.0 downstream ports, including 1x USB 3.0 BC1.2 charging port)
Dell Display Manager compatibility	Yes



Connectivity	1xDP 1.2 (HDCP 1.4) 1xHDMI 1.4 (HDCP 1.4) 1xVGA 1xUSB3.0 port - Upstream 2xUSB3.0 port - Side 2xUSB2.0 port - Bottom 1xHeadphone-out / Microphone-in combo jack
Border width (edge of monitor to active area)	19.8mm (Top) 11.4mm(Left/Right) 43.3mm(Bottom)
Security	Security lock slot (cable lock sold separately)
Adjustability	Height adjustable stand (125mm) Tilt (-5°/+21°) Swivel (-45°/+45°) Pivot (90°)



Resolution specifications

Model	P2418HZm
Horizontal scan range	30 kHz to 83 kHz (automatic)
Vertical scan range	56 Hz to 76 Hz (automatic)
Maximum preset resolution	1920 x 1080 at 60 Hz

Supported video modes

Model	P2418HZm
Video display capabilities (HDMI & DP playback)	480i, 480p, 576i, 576p, 720p, 1080i, 1080p

Preset display modes

Display Mode	Horizontal Frequency (kHz)	Vertical Frequency (Hz)	Pixel Clock (MHz)	Sync Polarity (Horizontal / Vertical)
VESA, 720 x 400	31.5	70.1	28.3	-/+
VESA, 640 x 480	31.5	60.0	25.2	-/-
VESA, 640 x 480	37.5	75.0	31.5	-/-
VESA, 800 x 600	37.9	60.3	40.0	+/+
VESA, 800 x 600	46.9	75.0	49.5	+/+
VESA, 1024 x 768	48.4	60.0	65.0	-/-
VESA, 1024 x 768	60.0	75.0	78.8	+/+
VESA, 1152 x 864	67.5	75.0	108.0	+/+
VESA, 1280 x 1024	64.0	60.0	108.0	+/+
VESA, 1280 x 1024	80.0	75.0	135.0	+/+
VESA, 1600 x 900	60.0	60.0	108.0	+/+
VESA, 1920 x 1080	67.5	60.0	148.5	+/+



Electrical specifications

Model	P2418HZm
Video input signals	<ul style="list-style-type: none"> • Analog RGB, 0.7 Volts +/-5%, positive polarity at 75 ohm input impedance • HDMI 1.4, 600mV for each differential line, 100 ohm input impedance per differential pair • DisplayPort 1.2, 600mV for each differential line, 100 ohm input impedance per differential pair
AC input voltage/frequency/ current	100 VAC to 240 VAC / 50 Hz or 60 Hz \pm 3 Hz / 1.5A (typical)
Inrush current	<ul style="list-style-type: none"> • 120 V: 30 A (Max.) at 0°C (cold start) • 240 V: 60 A (Max.) at 0°C (cold start)

Webcam – microphone specifications

Lens	Field of view	77.5° for 1920 x 1080
	Focus mode	Fixed Focus
	Focus area	28 cm~2.47 m
	Focusing distance (normal mode)	50 cm
Image Sensor	Active array size	2.12 mega-pixel
Video Specification	Video frame rate	1920 x 1080 (Full HD)- up to 30 frames per second
		640 x 480 (VGA) and below - up to 30 frames per second
Audio Specification	Microphone type	Omni-directional digital microphone x 2
Interface	USB 2.0 High Speed	
Power Supply	3.3 volts +/- 5%	

Speaker specifications

Model	P2418HZm
Speaker	2 x 5.0 W
Frequency Response	200 Hz - 20 kHz
Operating Temperature	-25 °C ~ 70 °C



Physical characteristics

Model	P2418HZm
Signal cable type	<ul style="list-style-type: none"> • Digital: detachable, HDMI, 19 pins. • Digital: detachable, DP, 20 pins. • Analog: detachable, D-Sub, 15 pins • Universal Serial Bus: USB, 9 pins
Dimensions (with stand)	
Height (extended)	500.6 mm (19.71 in)
Height (compressed)	375.6 mm (14.79 in)
Width	549.8 mm (21.65 in)
Depth	180.0 mm (7.09 in)
Dimensions (without stand)	
Height	359.6 mm (14.16 in)
Width	549.8 mm (21.65 in)
Depth	51.1 mm (2.01 in)
Stand dimensions	
Height (extended)	401.5 mm (15.87 in)
Height (compressed)	354.4 mm (13.95 in)
Width	242.6 mm (9.55 in)
Depth	180.0 mm (7.09 in)
Weight	
Weight with packaging	8.25 kg (18.18 lb)
Weight with stand assembly and cables	6.12 kg (13.49 lb)
Weight without stand assembly (no cables)	3.60 kg (7.93 lb)
Weight of stand assembly	1.96 kg (4.32 lb)
Front-frame gloss	2 - 4

Environmental characteristics

Model	P2418HZm
Compliant Standards	



Energy Saver feature for Energy Star certified Monitor
 EPEAT registered where applicable. EPEAT registration varies by country.
 See www.epeat.net for registration status by country
 TCO-certified display
 BFR/PVC- Free monitor (excluding external cables)
 Energy Gauge shows the energy level being consumed by the monitor in real time

Temperature

Operating	0°C to 40°C (32°F to 104°F)
Non-operating	<ul style="list-style-type: none"> • Storage: -20°C to 60°C (-4°F to 140°F) • Shipping: -20°C to 60°C (-4°F to 140°F)

Humidity

Operating	20% to 80% (non-condensing)
Non-operating	<ul style="list-style-type: none"> • Storage: 10% to 90% (non-condensing) • Shipping: 10% to 90% (non-condensing)

Altitude

Operating (maximum)	5,000 m (16,400 ft)
Non-operating (maximum)	12,192 m (40,000 ft)
Thermal dissipation	• 218.52 BTU/hour(maximum)
	• 64.87 BTU/hour(typical)

Power management modes

If you have VESA's DPM™ compliance display card or software installed in your PC, the monitor can automatically reduce its power consumption when not in use. This is referred to as Power Save Mode*. If the computer detects input from the keyboard, mouse or other input devices, the monitor automatically resumes functioning. The following table shows the power consumption and signaling of this automatic power saving feature.

* Zero power consumption in off mode can only be achieved by disconnecting the main cable from the monitor.



VESA Modes	Horizontal Sync	Vertical Sync	Video	Power Indicator	Power Consumption
Normal operation	Active	Active	Active	White	64 W (maximum)** 19 W (typical, without USB load)
Active-off mode	Inactive	Inactive	Blanked	White (Glowing)	Less than 0.3 W
Switch off	-	-	-	Off	Less than 0.3 W

Energy Star	Power Consumption
P_{on}	17.1 W
E_{TEC}	54 kWh

** Maximum power consumption with max luminance.

This document is informational only and reflects laboratory performance. Your product may perform differently, depending on the software, components and peripherals you ordered and shall have no obligation to update such information. Accordingly, the customer should not rely upon this information in making decisions about electrical tolerances or otherwise. No warranty as to accuracy or completeness is expressed or implied.

The OSD functions only in the normal operation mode. When any button is pressed in the Active-off mode, the following message will be displayed:

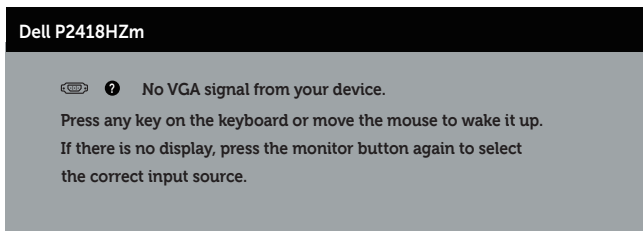

Activate the computer and the monitor to gain access to the OSD.



 **NOTE: This monitor is ENERGY STAR-certified.**

 **NOTE:**

P_{on} : Power consumption of on mode as defined in Energy Star 7.0 version.

E_{TEC} : Total energy consumption in kWh as defined in Energy Star 7.0 version.



Pin assignments

VGA connector

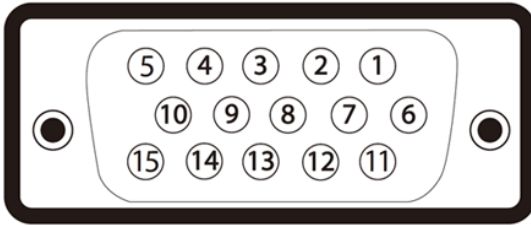

Pin Number	15-pin Side of the Connected Signal Cable
1	Video-Red
2	Video-Green
3	Video-Blue
4	GND
5	Self-test
6	GND-R
7	GND-G
8	GND-B
9	Computer 5V/3.3V
10	GND-sync
11	GND
12	DDC data
13	H-sync
14	V-sync
15	DDC clock



HDMI connector

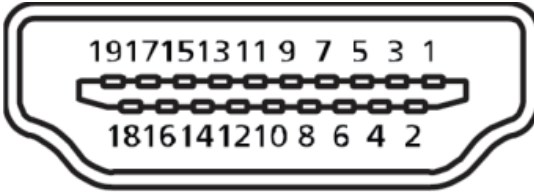

Pin Number	19-pin Side of the Connected Signal Cable
1	T.M.D.S. Data 2+
2	T.M.D.S. Data 2 Shield
3	T.M.D.S. Data 2-
4	T.M.D.S. Data 1+
5	T.M.D.S. Data 1 Shield
6	T.M.D.S. Data 1 -
7	T.M.D.S. Data 0+
8	T.M.D.S. Data 0 Shield
9	T.M.D.S. Data 0-
10	T.M.D.S. Clock +
11	T.M.D.S. Clock Shield
12	T.M.D.S. Clock -
13	CEC
14	Reserved (N.C. on device)
15	SCL
16	SDA
17	DDC/CEC Ground
18	+5V Power
19	Hot Plug Detect



DisplayPort connector

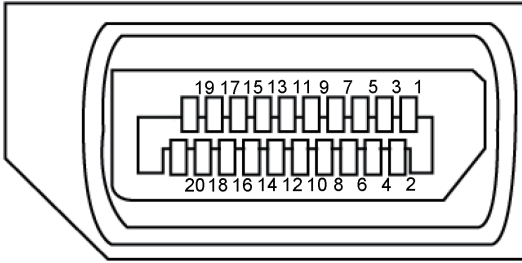

Pin Number	20-pin Side of the Connected Signal Cable
1	ML3 (n)
2	GND
3	ML3 (p)
4	ML2 (n)
5	GND
6	ML2 (p)
7	ML1 (n)
8	GND
9	ML1 (p)
10	ML0 (n)
11	GND
12	ML0 (p)
13	GND
14	GND
15	AUX (p)
16	GND
17	AUX (n)
18	Hot Plug Detect
19	Re-PWR
20	+3.3 V DP_PWR



Universal serial bus (USB) interface

This section gives you information about the USB ports that are available on the monitor.

 **NOTE:** This monitor is Super-Speed USB 3.0 and High-Speed USB 2.0 compatible.

Transfer Speed	Data Rate	Power Consumption*
Super-speed	5 Gbps	4.5 W (Max, each port)
High speed	480 Mbps	4.5 W (Max, each port)
Full speed	12 Mbps	4.5 W (Max, each port)

Transfer Speed	Data Rate	Power Consumption
High speed	480 Mbps	2.5 W (Max, each port)
Full speed	12 Mbps	2.5 W (Max, each port)
Low speed	1.5 Mbps	2.5 W (Max, each port)

*Up to 2A on USB downstream port (port with  lightning icon) with BC1.2 compliance devices or normal USB devices.

USB 3.0 upstream connector

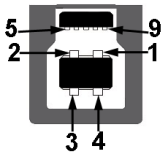

Pin Number	9-pin Side of the Connector
1	VCC
2	D-
3	D+
4	GND
5	SSTX-
6	SSTX+



7	GND
8	SSRX-
9	SSRX+

USB 3.0 downstream connector



Pin Number	9-pin Side of the Connector
1	VCC
2	D-
3	D+
4	GND
5	SSRX-
6	SSRX+
7	GND
8	SSTX-
9	SSTX+

USB 2.0 Downstream Connector

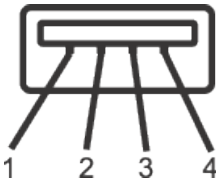

Pin Number	4-pin Side of the Connector
1	VCC
2	DMD
3	DPD
4	GND



USB Ports

- 1 x USB 3.0 upstream - bottom
- 2 x USB 2.0 downstream - bottom
- 2 x USB 3.0 downstream - side
- Power Charging Port- the port with  lightning icon; supports fast current charging capability if the device is BC1.2 compatible.



NOTE: USB 3.0 functionality requires a USB 3.0-capable computer.



NOTE: The monitor's USB interface works only when the monitor is On or in the power save mode. If you turn Off the monitor and then turn it On, the attached peripherals may take a few seconds to resume normal functionality.



NOTE: USB2.0 and above is needed to support webcam video & audio functions.



Plug and play capability

You can install the monitor in any Plug and Play-compatible system. The monitor automatically provides the computer system with its Extended Display Identification Data (EDID) using Display Data Channel (DDC) protocols so the system can configure itself and optimize the monitor settings. Most monitor installations are automatic, you can select different settings if desired. For more information about changing the monitor settings, see [Operating your monitor](#).

LCD monitor quality and pixel policy

During the LCD Monitor manufacturing process, it is not uncommon for one or more pixels to become fixed in an unchanging state which are hard to see and do not affect the display quality or usability. For more information on Dell Monitor Quality and Pixel Policy, see Dell Support site at: www.dell.com/support/monitors.

Maintenance guidelines

Cleaning your monitor

 **WARNING:** Before cleaning the monitor, unplug the monitor power cable from the electrical outlet.

 **CAUTION:** Read and follow the [Safety instructions](#) before cleaning the monitor.



For best practices, follow the instructions in the list below while unpacking, cleaning or handling your monitor:

- To clean your anti-static screen, lightly dampen a soft, clean cloth with water. If possible, use a special screen-cleaning tissue or solution suitable for the anti-static coating. Do not use benzene, thinner, ammonia, abrasive cleaners or compressed air.
- Use a lightly-dampened, warm cloth to clean the monitor. Avoid using detergent of any kind as some detergents leave a milky film on the monitor.
- If you notice white powder when you unpack your monitor, wipe it off with a cloth.
- Handle your monitor with care as a darker-colored monitor may get scratched and show white scuff marks more than a lighter-colored monitor.
- To help maintain the best image quality on your monitor, use a dynamically changing screen saver and turn off your monitor when not in use.



Setting up the monitor

Attaching the stand

-  **NOTE:** The stand is detached when the monitor is shipped from the factory.
-  **NOTE:** This is applicable for a monitor with a stand. When any other stand is bought, please refer to the respective stand setup guide for the set up instructions.

To attach the monitor stand.

1. Follow the instructions on the flaps of carton to remove the stand from the top cushion that secures it.
2. Insert the stand base blocks fully into the stand slot.
3. Lift the screw handle and turn the screw clockwise.
4. After fully tightening the screw, fold the screw handle flat within the recess.

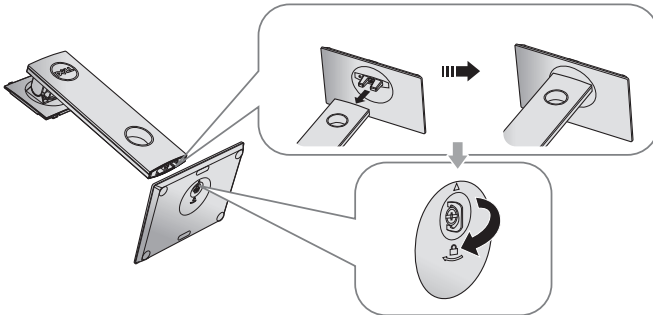

5. Lift the cover, as shown, to expose the VESA area for stand assembly.

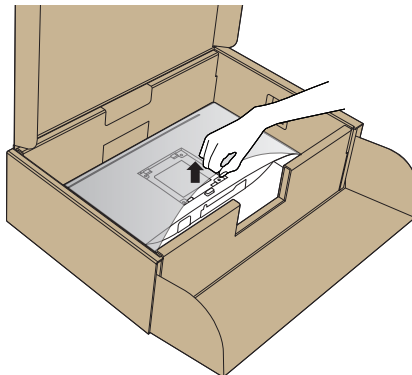

6. Attach the stand assembly to the monitor.
 - a. Fit the two tabs on the upper part of the stand to the groove on the back of the monitor.
 - b. Press the stand down till it snaps into place.

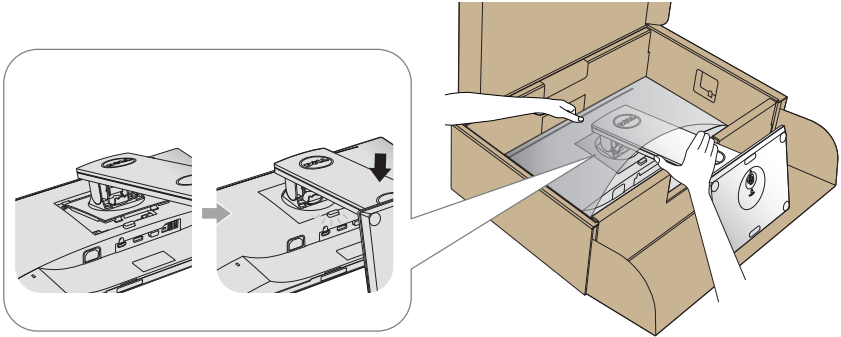

7. Place the monitor upright.



NOTE: Lift the monitor carefully to prevent it from slipping or falling.



Connecting your monitor

⚠ WARNING: Before you perform any of the procedures in this section, follow the [Safety instructions](#).

📎 NOTE: Do not connect all cables to the computer at the same time. It is recommend to route the cables through the cable-management slot before you connect them to the monitor.

To connect your monitor to the computer:

1. Turn off your computer and disconnect the power cable.
2. Connect the VGA, HDMI or DP cable from your monitor to the computer.

Connecting the VGA cable

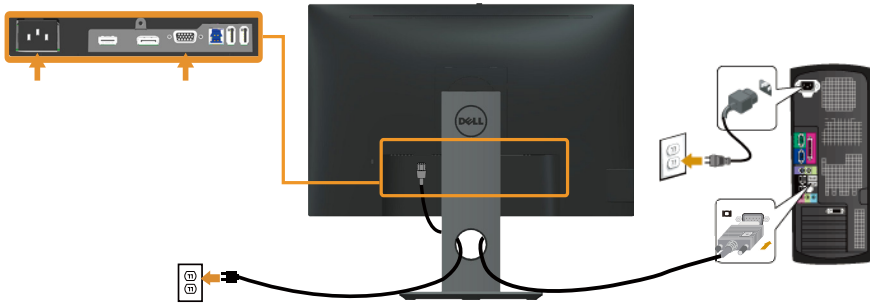

Connecting the HDMI cable (optional)

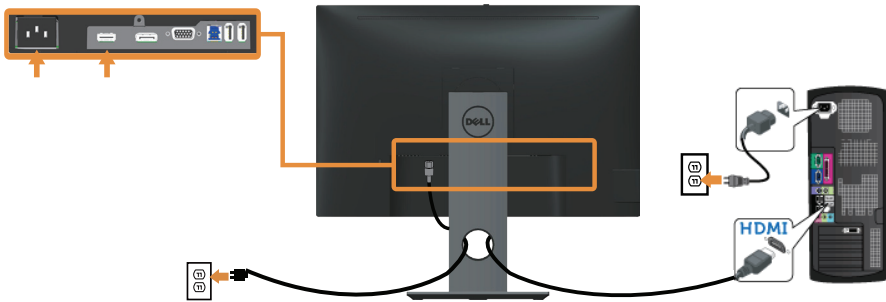

Connecting the DP cable

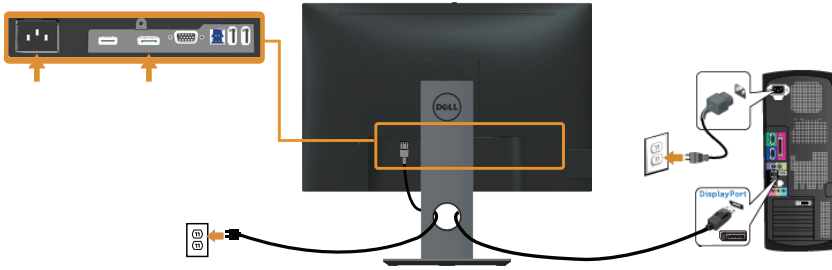

Connecting the USB 3.0 cable

After you have completed connecting the DP/HDMI cable, follow the procedures below to connect the USB 3.0 cable to the computer and complete your monitor setup:

1. Connect the upstream USB 3.0 port (cable supplied) to an appropriate USB 3.0 port on your computer. (See [Bottom View](#) for details.)
2. Connect the USB 3.0 peripherals to the downstream USB 3.0 ports on the monitor.
3. Plug the power cables for your computer and monitor into a nearby outlet.
4. Turn on the monitor and the computer.
If your monitor displays an image, installation is complete. If it does not display an image, see [Universal serial bus \(USB\) specific problems](#).
5. Use the cable slot on the monitor stand to organize the cables.

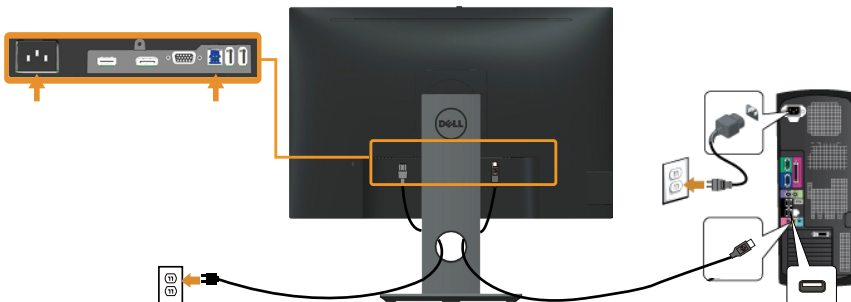



Organizing cables

Use the cable-management slot to organize the cables connected to your monitor.



Disconnecting the monitor stand

-  **NOTE:** To prevent scratches on the LCD screen while removing the stand, ensure that the monitor is placed on a soft and clean surface.
-  **NOTE:** This is applicable for a monitor with a stand. When any other stand is bought, please refer to the respective stand setup guide for the set-up instructions.

To remove the stand:

1. Place the monitor on a soft cloth or cushion.
2. Press and hold the stand release button.
3. Lift the stand up and away from the monitor.

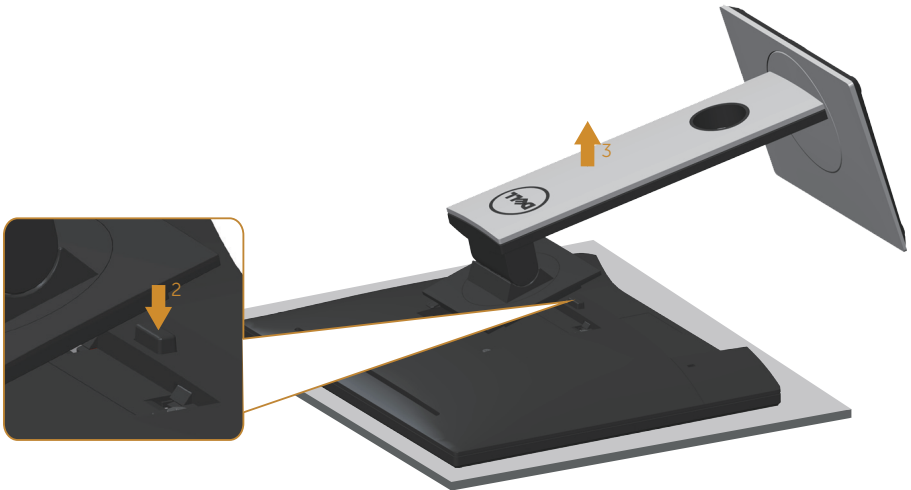

Wall mounting (optional)

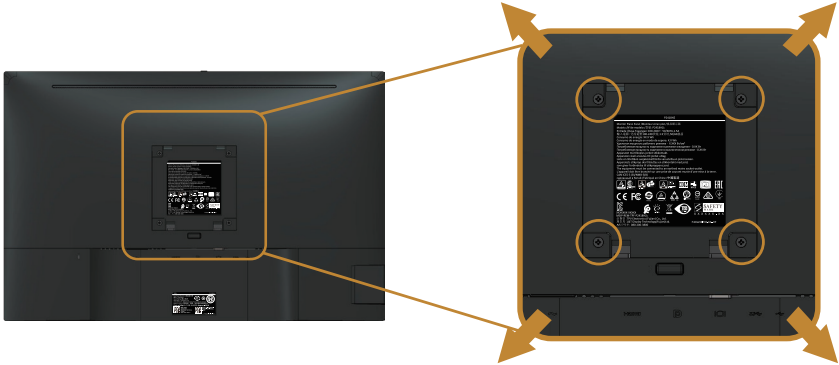

(Screw dimension: M4 x 10 mm).

Refer to the instructions that come with the VESA-compatible wall mounting kit.

1. Place the monitor panel on a soft cloth or cushion on a stable, flat table.
2. Remove the stand.
3. Use a screwdriver to remove the four screws securing the plastic cover.
4. Attach the mounting bracket from the wall mounting kit to the monitor.
5. Mount the monitor on the wall by following the instructions that comes with the wall mounting kit.

 **NOTE:** For use only with UL or CSA or GS-listed wall mount bracket with minimum weight/load bearing capacity of 14.4 kg



Operating your monitor

Power on the monitor

Press the  button to turn on the monitor.

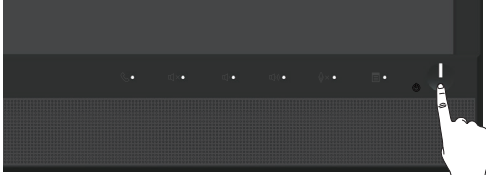



Using the front panel controls

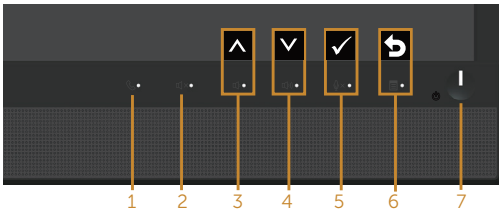







Use the control buttons on the front of the monitor to link up Microsoft® Skype for Business® Software or adjust the characteristics of the image being displayed. As you use these buttons, an On-Screen Display (OSD) or LED indicator shows the numeric values or activities of the characteristics as they change.



The following table describes the front panel buttons:

Front Panel Button / OSD Button	Description
1  Hook	Use the Hook button to accept an incoming invite notification.
2  MUTE	Use the Mute button to mute audio.



3	 Volume Down	 Up	<ul style="list-style-type: none"> • Use Volume Down button to decrease OSD bar volume. • Use the Up button to adjust (increase ranges) items in the OSD menu
4	 Volume Up	 Down	<ul style="list-style-type: none"> • Use Volume Up button to increase OSD bar volume. • Use the Down button to adjust (decrease ranges) items in the OSD menu.
5	 Microphone Mute	 OK	<ul style="list-style-type: none"> • Use the Microphone Mute button to mute microphone. • Use the OK button to confirm your selection.
6	 MENU	 Back	<ul style="list-style-type: none"> • Use the MENU button to launch the OSD. • Use the Back button to go back to the previous menu. <p>See Accessing the Menu System.</p>
7	 Power (with power light indicator)		<p>Use the Power button to turn the monitor On and Off.</p> <p>The white light indicates the monitor is On and fully functional. A breathing white light indicates the power save mode.</p>



Accessing Microsoft® Skype for Business® with the Panel Buttons

NOTE: To enable Microsoft® Skype for Business® functions with your monitor, make sure that the USB upstream cable is connected between your computer and the monitor. If not, the following message will be displayed:



NOTE: The front panel buttons, excluding **Volume Up** and **Volume Down**, function only when Microsoft® Skype for Business® is active on your computer.

1. Hook

The **Hook** button light flashes when someone calls you on Skype for Business. Press the **Hook** button to answer the incoming voice or video call.

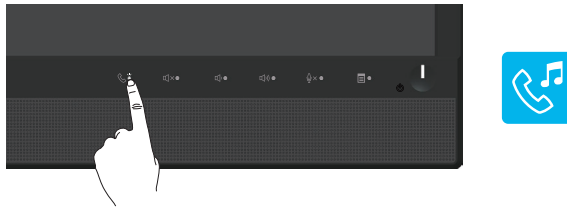

To end an active voice or video call, press the **Hook** button.



2. Mute

To mute the audio, press the **Mute** button. The mute-button light turns on when audio is muted.



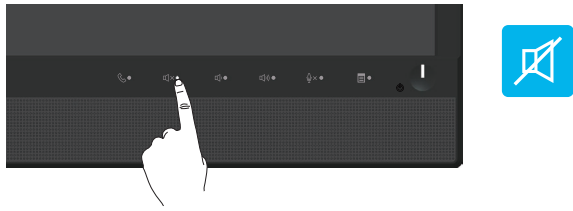

3. Volume Down/Volume Up

To adjust the volume, press the **Volume Down** or **Volume Up** buttons. The activated OSD shows the numeric values of the volume level.

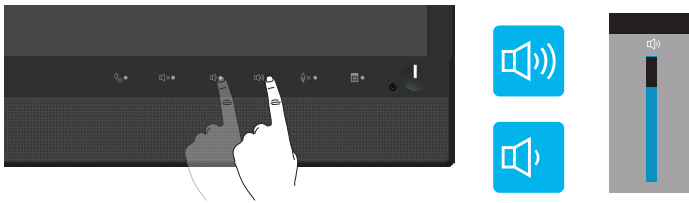

4. Microphone Mute

To mute the microphone, press the **Microphone Mute** button. The microphone-mute-button light turns on when the microphone is muted.

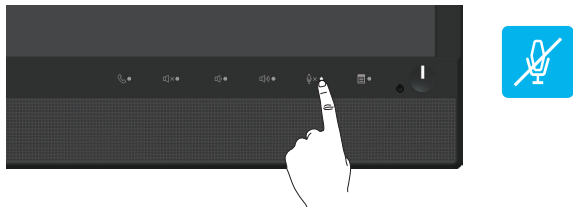

Using the on-screen display (OSD) menu







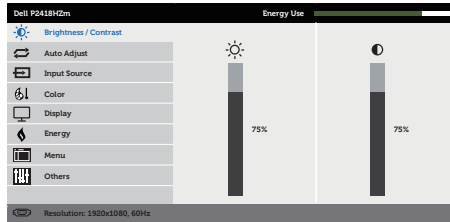

Accessing the Menu System

 **NOTE:** Any changes you make are automatically saved when you move to another menu, exit the OSD menu, or wait for the OSD menu to automatically close.





1. Press the  button to display the OSD main menu.

Main menu for analog (VGA) input

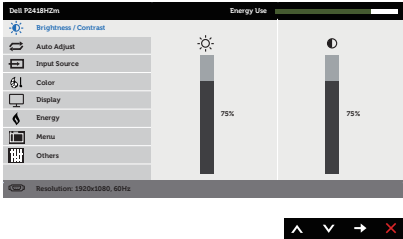

2. Press the  and  buttons to move between the setting options. As you move from one icon to another, the option is highlighted.
3. Press the  button once to activate the highlighted option.
4. Press  and  button to select the desired parameter.
5. Press  and then use the  and  buttons, according to the indicators on the menu, to make your changes.
6. Select the  button to return to the main menu.



Icon	Menu and Submenus	Description
	Brightness/ Contrast	<p>Use this menu to activate brightness/contrast adjustment.</p> 
	Brightness	<p>Brightness adjusts the luminance of the backlight.</p> <p>Press the  button to increase the brightness and press the  button to decrease the brightness (min. 0 / max. 100).</p> <p>NOTE: Manual adjustment of brightness is disabled when dynamic contrast is switched on.</p>
	Contrast	<p>Adjust the brightness first, and then adjust the contrast only if further adjustment is necessary.</p> <p>Press the  button to increase the contrast and press the  button to decrease the contrast (min. 0 / max. 100).</p> <p>The contrast function adjusts the degree of difference between darkness and lightness on the monitor screen.</p>





Auto Adjust

Use this key to activate automatic setup and adjust menu.

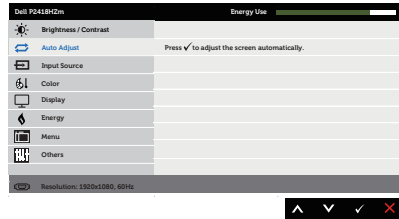

The following dialog appears on a black screen as the monitor self-adjusts to the current input:

Auto Adjustment in Progress...

Auto adjustment allows the monitor to self-adjust to the incoming video signal. After using auto adjustment, you can further tune your monitor by using the pixel clock (coarse) and phase (fine) controls under display settings.

NOTE: Auto adjust does not occur if you press the button while there are no active video input signals or attached cables.

This option is only available when you are using the analog (VGA) connector.





Input Source

Use the input source menu to select between the different video signals that may be connected to your monitor.

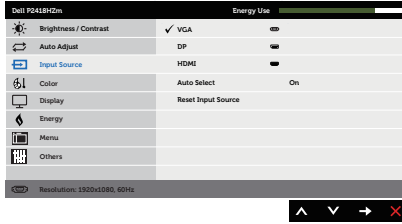

VGA

Select VGA input when you are using the analog (VGA) connector. Push to select the VGA input source.

DP

Select DP input when you are using the DP connector. Push to select the DP input source.

HDMI

Select HDMI input when you are using the HDMI connector. Push to select the HDMI input source.

Auto Select

Select auto select to scan for available input signals.

Reset Input Source

Select this option to restore default Input Source.



Color

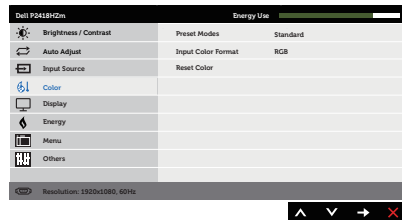

Use color to adjust the color setting mode.



Preset Modes

When you select preset modes, you can choose standard, comfortview, multimedia, movie, game, warm, cool, or custom color from the list.

- Standard: Loads the monitor's default color settings. This is the default preset mode.
- ComfortView: Decreases the level of blue light emitted from the screen to make viewing more comfortable for your eyes.
- Multimedia: Loads color settings ideal for multimedia applications.
- Movie: Loads color settings ideal for movies.
- Game: Loads color settings ideal for most gaming applications.
- Warm: Increases the color temperature. The screen appears warmer with a red/yellow tint.
- Cool: Decreases the color temperature. The screen appears cooler with a blue tint.
- Custom Color: Allows you to manually adjust the color settings.

Press the  and  buttons to adjust the three colors (R, G, B) values and create your own preset color mode.

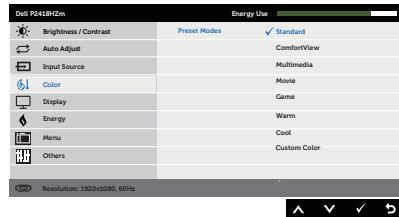

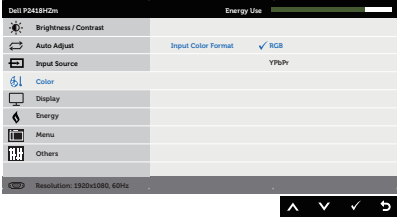
<p>Input Color Format</p>	<p>Allows you to set the video input mode to:</p> <ul style="list-style-type: none"> • RGB: Select this option if your monitor is connected to a computer or DVD player using the HDMI cable. • YPbPr: Select this option if your DVD player supports only YPbPr output. 
<p>Hue</p>	<p>This feature can shift the color of the video image to green or purple. This is used to adjust the desired flesh tone color. Use ▲ or ▼ to adjust the hue from 0 to 100. Press ▲ to increase the green shade of the video image. Press ▼ to increase the purple shade of the video image. NOTE: Hue adjustment is available only when you select Movie or Game preset mode.</p>
<p>Saturation</p>	<p>This feature can adjust the color saturation of the video image. Use ▲ or ▼ to adjust the saturation from 0 to 100. Press ▲ to increase the monochrome appearance of the video image. Press ▼ to increase the colorful appearance of the video image. NOTE: Saturation adjustment is available only when you select movie or game preset mode.</p>
<p>Reset Color</p>	<p>Allows your monitor color settings to the factory settings.</p>





Display

Use the display to adjust image.

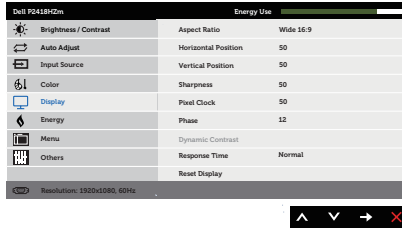

Aspect Ratio

Adjusts the image ratio to wide 16:9, 4:3 or 5:4

Horizontal Position

Use or the buttons to adjust image left and right. Minimum is 0 (-). Maximum is 100 (+).

Vertical Position

Use the or buttons to adjust image up and down. Minimum is 0 (-). Maximum is 100 (+).

NOTE: Horizontal position and vertical position adjustments are only available for "VGA" input.

Sharpness

This feature can make the image look sharper or softer. Use or to adjust the sharpness from 0 to 100.

Pixel Clock

The phase and pixel clock adjustments allow you to adjust your monitor to your preference. Use or buttons to adjust for best image quality. Minimum is 0 (-). Maximum is 100 (+).

Phase

If satisfactory results are not obtained using the phase adjustment, use the pixel clock (coarse) adjustment and then use phase (fine), again. Minimum is 0 (-). Maximum is 100 (+).

NOTE: Pixel clock and phase adjustments are only available for "VGA" input.

Dynamic Contrast

Allows you to increase the level of contrast to provide sharper and more detailed image quality.

Press the button to select the dynamic contrast on or off.

NOTE: Dynamic contrast provides higher contrast if you select game or movie preset mode.

Response Time

User can select between fast or normal.

Reset Display

Select this option to restore default display settings.





Energy

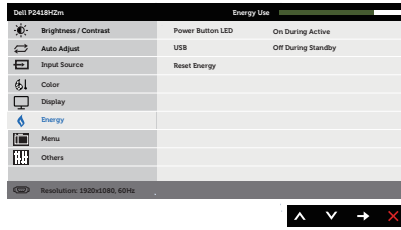

Power Button LED

Allows you to set the power LED indicator on during active or off during active to save energy.

USB







Allows you to enable or disable USB function during monitor standby mode.

NOTE: USB ON/OFF under standby mode is only available when USB upstream cable unplugged. This option will be grey out when USB upstream cable plug in.

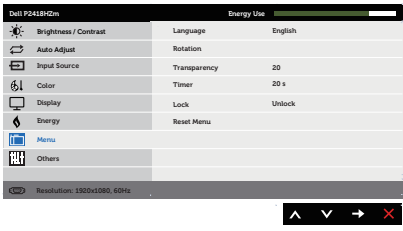
Reset Energy

Select this option to restore default Energy settings.

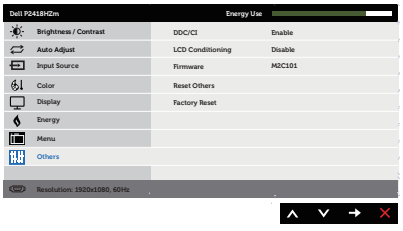

	<p>Menu</p>	<p>Select this option to adjust the settings of the OSD, such as, the languages of the OSD, the amount of time the menu remains on screen and so on.</p> 
	<p>Language</p>	<p>Language options set the OSD display to one of the eight languages (English, Spanish, French, German, Brazilian Portuguese, Russian, Simplified Chinese, or Japanese).</p>
	<p>Rotation</p>	<p>Rotates the OSD by 90 degrees counter-clockwise. You can adjust the menu according to your display rotation.</p>
	<p>Transparency</p>	<p>Select this option to change the menu transparency by pressing the  and  buttons from 0 to 100.</p>
	<p>Timer</p>	<p>OSD hold time: sets the length of time the OSD will remain active after the last time you pressed a button.</p> <p>Use  or  to adjust the slider in 1 second increments, from 5 to 60 seconds.</p>
	<p>Lock</p>	<p>Controls user access to adjustments. When lock is selected, no user adjustments are allowed. All buttons are locked.</p> <p>NOTE: When the OSD is locked, pressing the menu key takes you directly to the OSD settings menu, with 'OSD Lock' pre-selected on entry. Press and hold  key for 6 seconds to unlock and allow user access to all applicable settings.</p>
	<p>Reset Menu</p>	<p>Reset all OSD settings to the factory preset values.</p>
	<p>Others</p>	

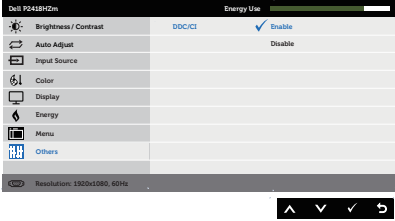
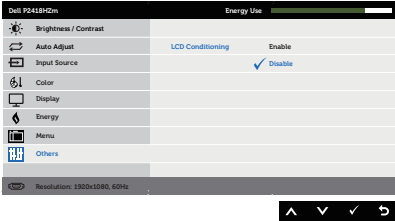

<p>DDC/CI</p>	<p>DDC/CI (display data channel/command interface) allows your monitor parameters (brightness, color balance and etc.) to be adjustable via the software on your computer. You can disable this feature by selecting disable. Enable this feature for best user experience and optimum performance of your monitor.</p> 
<p>LCD Conditioning</p>	<p>Helps reduce minor cases of image retention. Depending on the degree of image retention, the program may take some time to run. To start LCD conditioning, select Enable.</p> 
<p>Firmware</p>	<p>Show your monitor current firmware revision.</p>
<p>Reset Other</p>	<p>Reset all settings under the Others setting menu to the factory preset values.</p>
<p>Factory Reset</p>	<p>Reset all settings to the factory preset values.</p>

 **NOTE:** Your monitor has a built-in feature to automatically calibrate the brightness to compensate for LED aging.



OSD warning messages

When the **Dynamic Contrast** feature is enabled (in these preset modes: **Game** or **Movie**), the manual brightness adjustment is disabled.

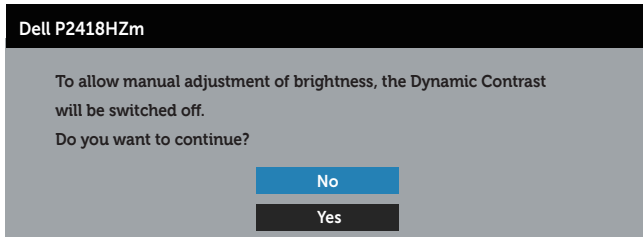

When the monitor does not support a particular resolution mode, the following message is displayed:

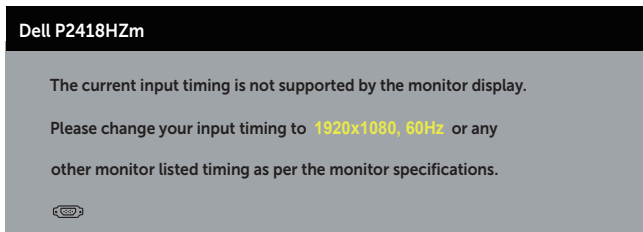

This means that the monitor cannot synchronize with the signal that it is receiving from the computer. See [Monitor specifications](#) for the Horizontal and Vertical frequency ranges addressable by this monitor. Recommended mode is 1920 x 1080.

Before the **DDC/CI** function is disabled, the following message is displayed:

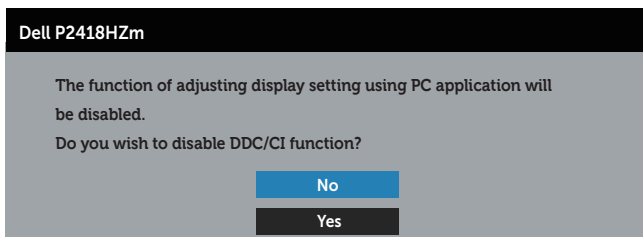

When the monitor enters the **Power Save Mode**, the following message appears:



If you press any button other than the power button, the following messages will appear depending on the selected input:

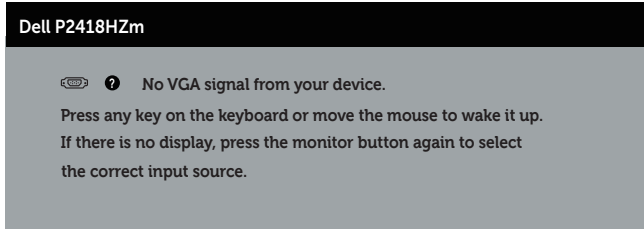

If VGA, HDMI, or DP cable is not connected, a floating dialog box as shown below appears. The monitor will enter Power Save Mode after 4 minutes if left at this state.

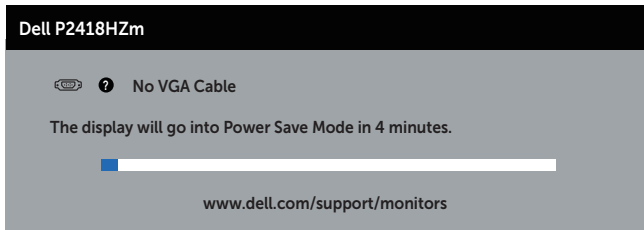

or

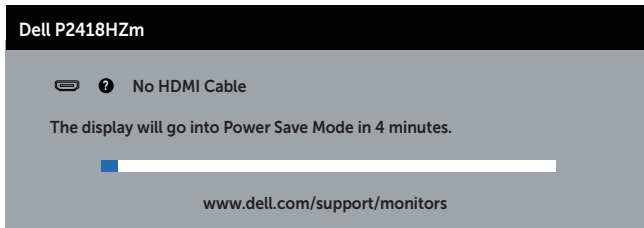

or

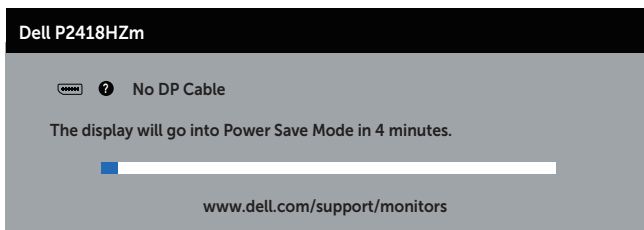

See [Troubleshooting](#) for more information.



Setting up your monitor

Setting the maximum resolution

To set the maximum resolution for the monitor:

In Windows® 7, Windows® 8, and Windows® 8.1:

1. For Windows 8 and Windows 8.1, select the Desktop tile to switch to classic desktop.
2. Right-click on the desktop and click **Screen resolution**.
3. Click the dropdown list of the Screen Resolution and select **1920 x 1080**
4. Click **OK**.

In Windows® 10:

1. Right-click on the desktop and click **Display settings**.
2. Click **Advanced display settings**.
3. Click the dropdown list of **Resolution** and select **1920 x 1080**.
4. Click **Apply**.

If you do not see 1920 x 1080) as an option, you may need to update your graphics driver. Depending on your computer, complete one of the following procedures:

If you have a Dell desktop or portable computer:

- Go to www.dell.com/support, enter your computer's Service Tag, and download the latest driver for your graphics card.

If you are using a non-Dell computer (portable or desktop):

- Go to the support site for your computer and download the latest graphic drivers.
- Go to your graphics card website and download the latest graphic drivers.



Using the Tilt, Swivel, and Vertical Extension

NOTE: This is applicable for a monitor with a stand. When any other stand is bought, please refer to the respective stand setup guide for set up instructions.

Tilt, Swivel

With the stand attached to the monitor, you can tilt and swivel the monitor for the most comfortable viewing angle.

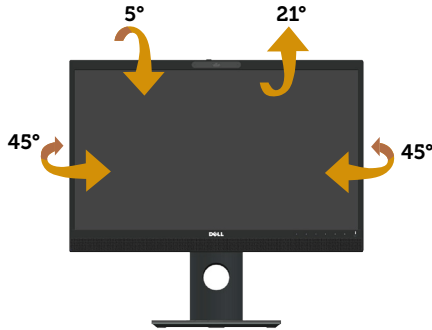

NOTE: The stand is detached when the monitor is shipped from the factory.

Vertical Extension

NOTE: The stand extends vertically up to 125 mm. The figure below illustrates how to extend the stand vertically.



Rotating the Monitor

Before you rotate the monitor, your monitor should be fully vertically extended ([Vertical Extension](#)) and fully tilted up to avoid hitting the bottom edge of the monitor.

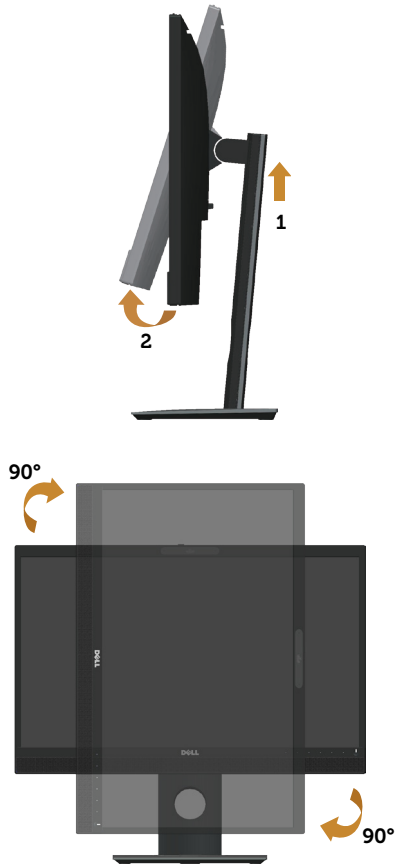

 **NOTE:** To use the Display Rotation function (Landscape versus Portrait view) with your Dell computer, you require an updated graphics driver that is not included with this monitor. To download the graphics driver, go to www.dell.com/support and see the **Download** section for **Video Drivers** for latest driver updates.

 **NOTE:** When in the Portrait View Mode, you may experience performance degradation in graphic-intensive applications (3D Gaming and etc.).



Adjusting the Rotation Display Settings of Your System

After you have rotated your monitor, you need to complete the procedure below to adjust the Rotation Display Settings of your system.

 **NOTE:** If you are using the monitor with a non-Dell computer, you need to go the graphics driver website or your computer manufacturer website for information on rotating the 'contents' on your display.

To adjust the Rotation Display Settings:

1. Right-click on the desktop and click **Properties**.
2. Select the **Settings** tab and click **Advanced**.
3. If you have an ATI graphics card, select the **Rotation** tab and set the preferred rotation.
4. If you have an nVidia graphics card, click the **nVidia** tab, in the left-hand column select **NVRotate**, and then select the preferred rotation.
5. If you have an Intel® graphics card, select the **Intel** graphics tab, click **Graphic Properties**, select the **Rotation** tab, and then set the preferred rotation.

 **NOTE:** If you do not see the rotation option or it is not working correctly, go to www.dell.com/support and download the latest driver for your graphics card.

Operating the webcam cover shutter

Slide the shutter to the left: Uncover the webcam.



Slide the shutter to the right: Cover the webcam.

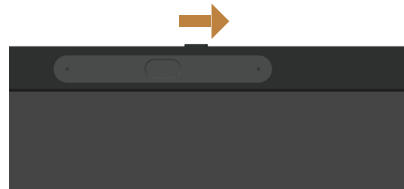

Installing the monitor IR Camera driver

The IR camera driver is available for download from Dell.com/P2418HZm.

Navigate to the Drivers & Downloads section to download the driver file, unzip the file, and then double click "setup.exe" to install the driver.

It will directly transfer to the Realtek PC Camera installation interface. Wait for automatic running of the installation program.

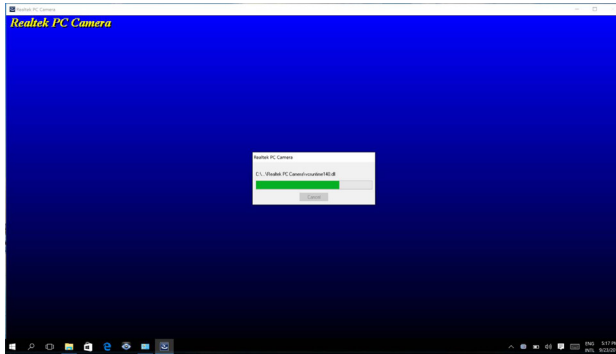

When the installation is complete, restart your computer.

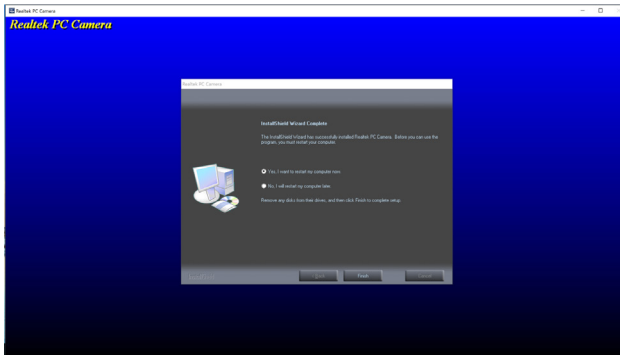

Setting up Windows Hello

In Windows® 10:

Click Windows start menu, click **Settings**.

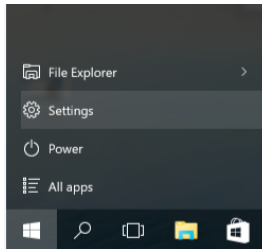

Click **Accounts**.

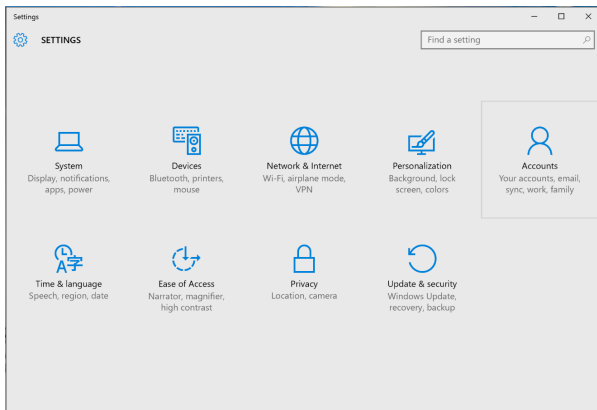

Click **Sign-in options**. You must set up a PIN before you can enroll in Windows Hello.

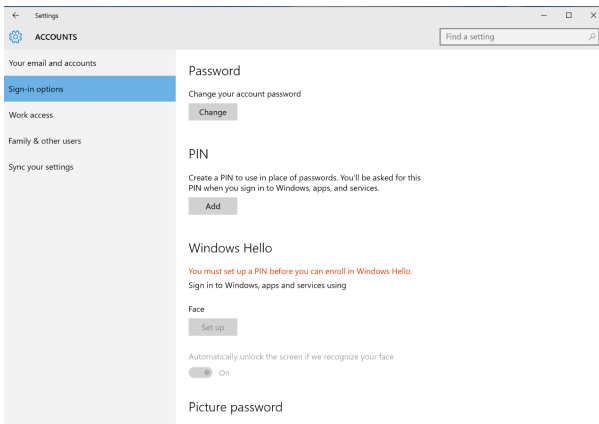

Click **Add** under **PIN** enter to **Set up a PIN**. Enter New PIN and Confirm PIN, and then click **OK**.

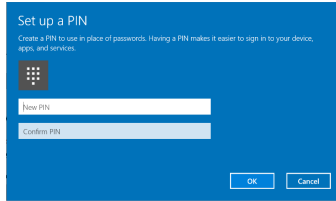

Once you've done that, the options to set up Windows Hello will unlock. Click **Set up** under **Windows Hello**, enter to **Windows Hello setup**.

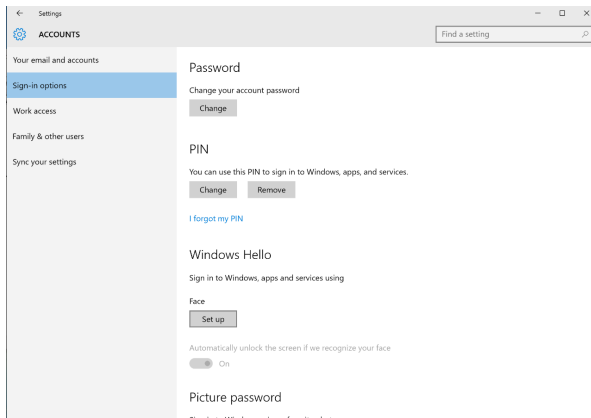

The following message is displayed, click **Get started**.



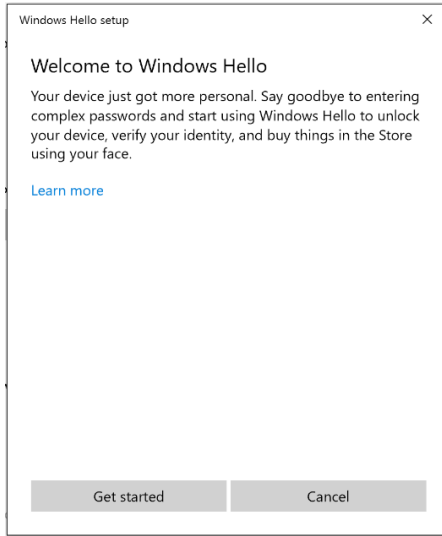

Keep looking directly at your screen and position yourself so that your face is in the center of the frame that appears on screen. The webcam will then register your face.

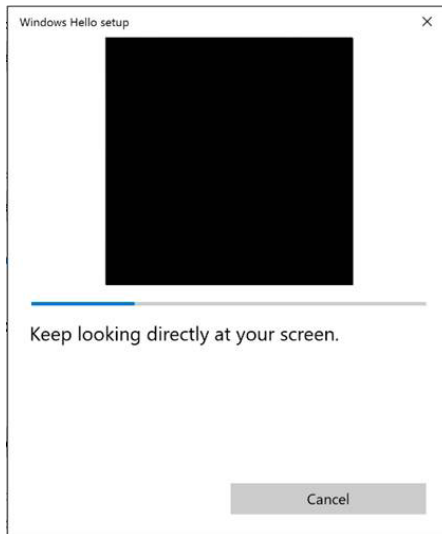

When the following message is displayed, click **Close** to exit **Windows Hello setup**.



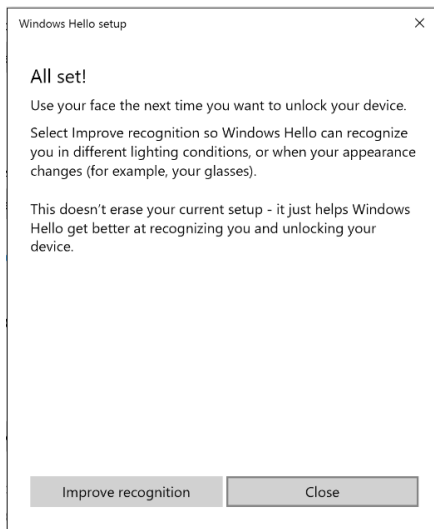

Once you have set up, you have another option to improve the recognition. Click **Improve recognition** if necessary.

Setting up the monitor webcam as default setting

When using a notebook with built-in webcam to connect this monitor, in the device manager interface, you can find the notebook built-in webcam and the monitor webcam. Normally, they are in enable status, and the default setting is using notebook built-in webcam.



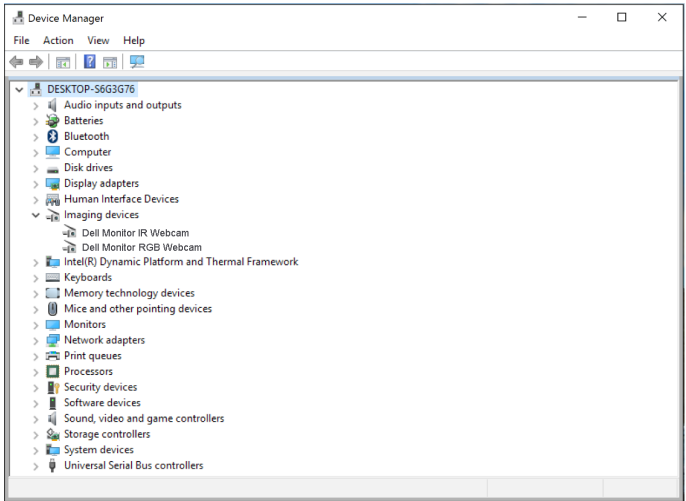

If you want to set up the monitor webcam as default setting, you need disable the notebook built-in webcam. To identify the notebook built-in webcam and disable it, please follow below instructions:

Right-click **Dell Monitor IR Webcam**, and click **Properties** to open the **Dell Monitor IR Webcam Properties**.

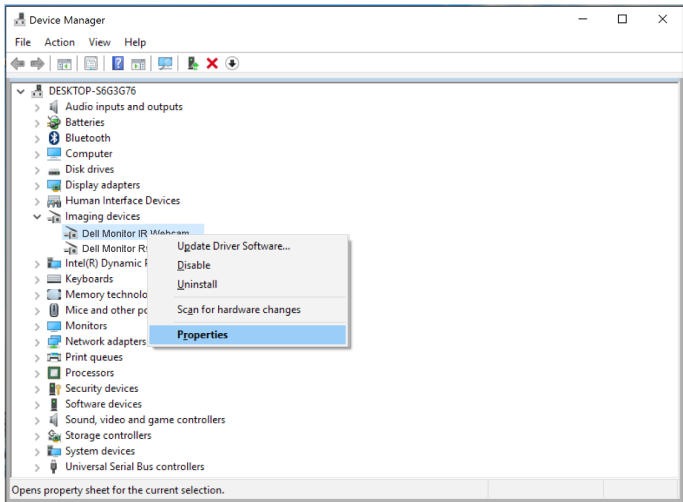

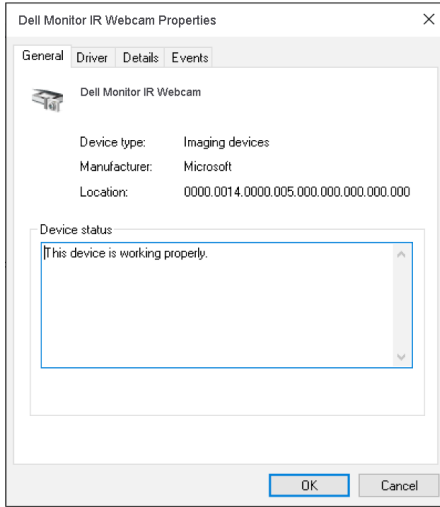

Click **Details > Property** and select **Hardware Ids**.

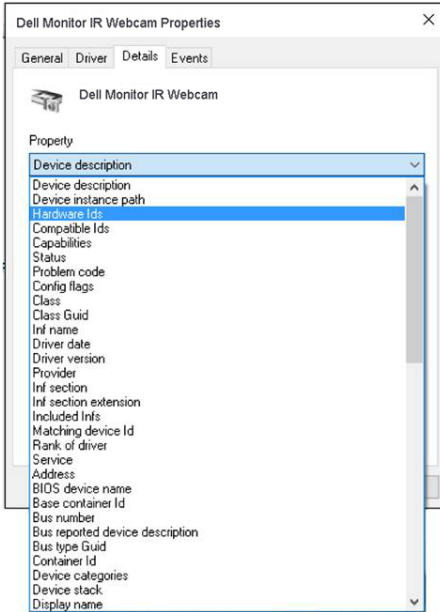

The **Value** will show the detail hardware ids of this Dell Monitor IR Webcam. The hardware ids of the notebook built-in webcam and the monitor webcam are different. For P2418HZm, the monitor webcam hardware ids will show as below:

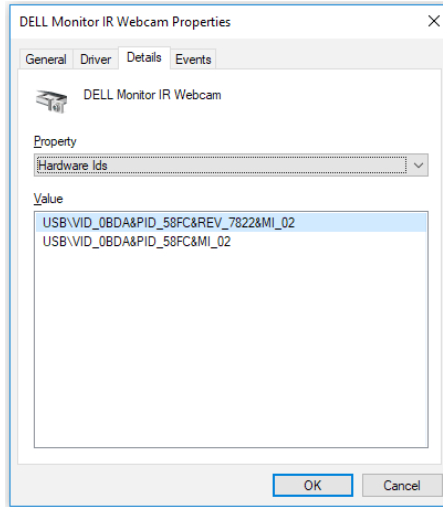

Right click the **Dell Monitor IR Webcam** which has different hardware ids of the P2418HZm monitor webcam, and then click **Disable**.

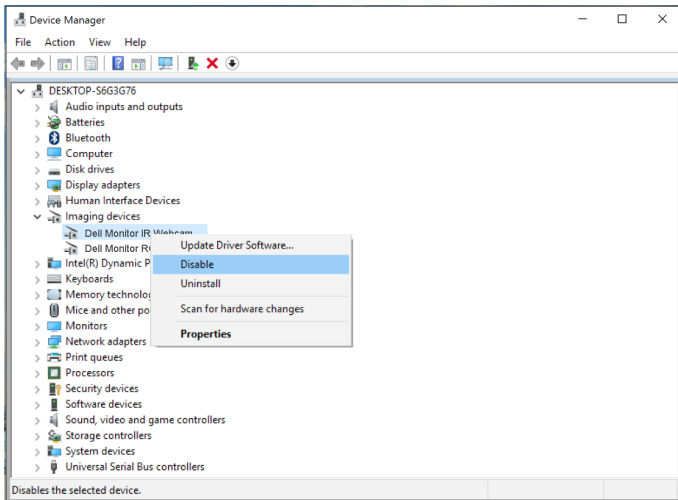

The following message is displayed:



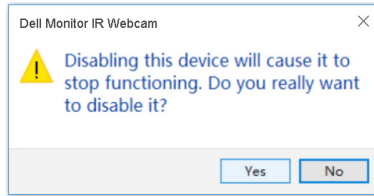

Click **Yes**. The notebook webcam is now disabled and the monitor webcam will be used as the default setting. Restart the notebook.

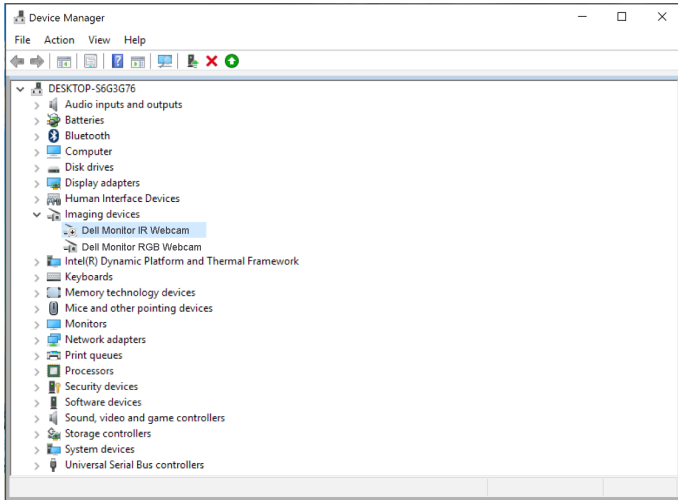

Setting up the monitor speaker as default setting

When your computer connects multiple speakers, if you want to set up the monitor speaker as default setting, please follow below instructions:

Right-click **Volume** in the Windows task bar notification area.



click **Playback devices** enter to **Sound** setting interface.

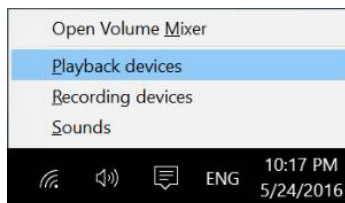

If only the HDMI or DP cable is connected from your monitor to the computer, only one speaker named **DELL P2418HZm** from the monitor will show in the **Sound** setting interface.

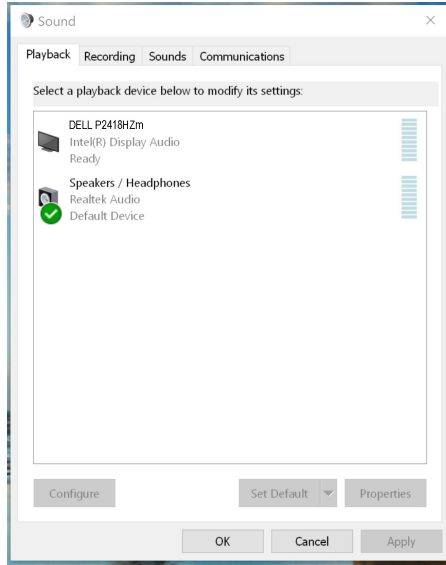

click **DELL P2418HZm**, and then click **Set Default**, the monitor speaker will be used as the default setting.

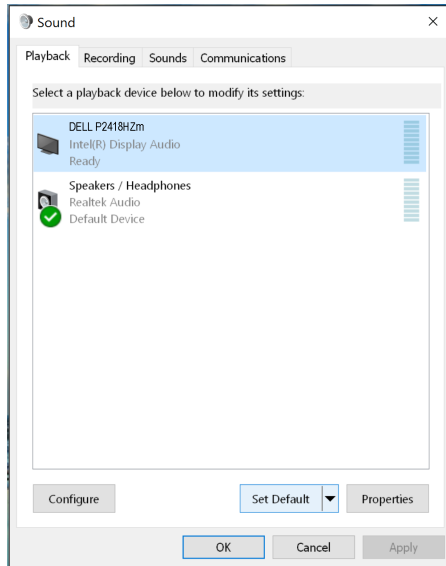

Click **OK** to exit the **Sound** setting.

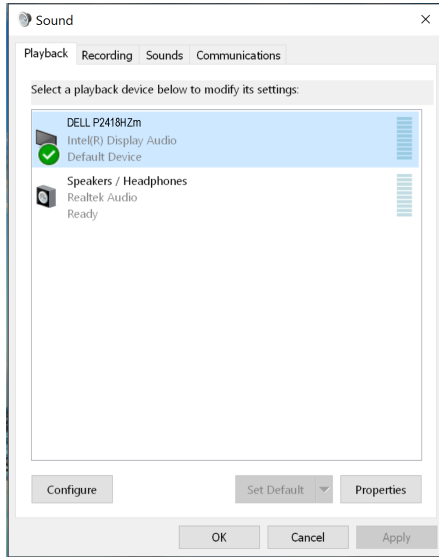

If the USB cable and the HDMI or DP cable are connected from monitor to the computer, two speakers named **DELL P2418HZm** and **P2418HZm** respectively from the monitor will show in the **Sound** setting interface. The difference between **DELL P2418HZm** and **P2418HZm** is only different signal source. You can choose any one to set default, the monitor speaker will be used as the default setting.



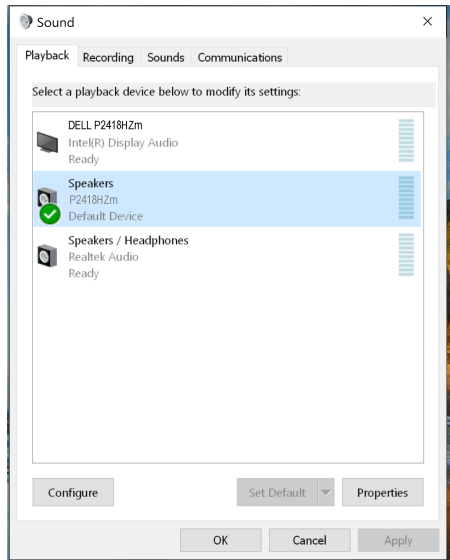
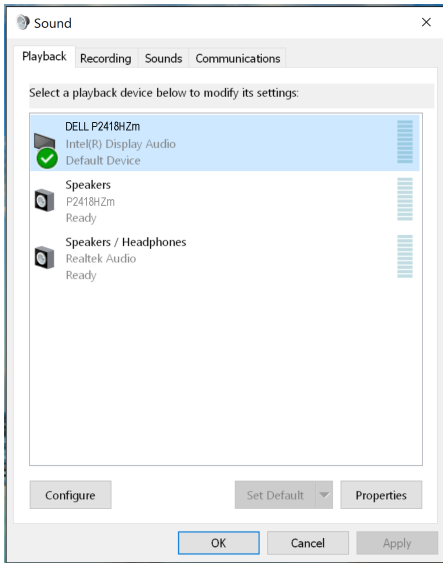

Troubleshooting

⚠ WARNING: Before you begin any of the procedures in this section, follow the [Safety instructions](#).

Self-test

Your monitor provides a self-test feature that allows you to check if your monitor is functioning properly. If your monitor and computer are properly connected but the monitor screen remains dark, run the monitor self-test by performing the following steps:

1. Turn off both your computer and the monitor.
2. Disconnect all video cables from the monitor. This way, the computer doesn't have to be involved.
3. Turn on the monitor.

If the monitor is working correctly, it detects that there is no signal and one of the following message appears. While in self-test mode, the power LED remains white.

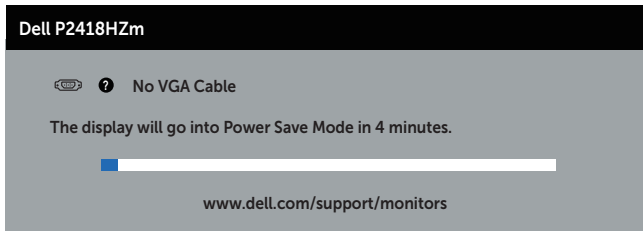

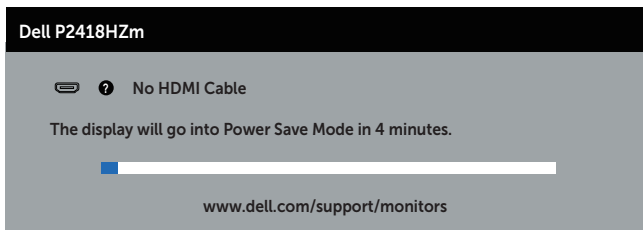

or



or

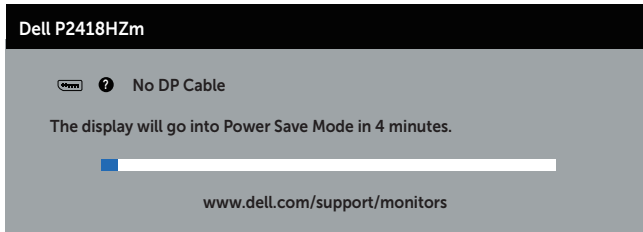



 **NOTE:** This box also appears during normal system operation, if the video cable is disconnected or damaged.

4. Turn off your monitor and reconnect the video cable; then turn on both your computer and the monitor.

If your monitor remains dark after you reconnect the cables, check your video controller and computer.



Built-in diagnostics

Your monitor has a built-in diagnostic tool that helps you determine if any screen abnormality you experience is an inherent problem with your monitor, or with your computer and video card.

 **NOTE:** You can run the built-in diagnostics only when the video cable is unplugged and the monitor is in *self-test mode*.

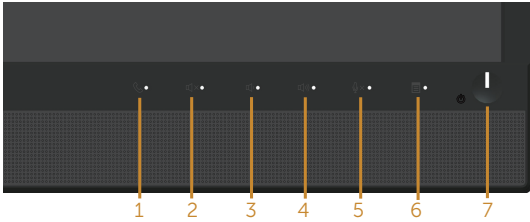

To run the built-in diagnostics:

1. Ensure that the screen is clean (no dust particles on the surface of the screen).
2. Unplug the video cable(s) from the back of the computer or monitor. The monitor then goes into the self-test mode.
3. Press and hold **Button 3** on the front panel simultaneously for 5 seconds. A gray screen appears.
4. Carefully inspect the screen for abnormalities.
5. Press **button 3** on the front panel again. The color of the screen changes to red.
6. Inspect the display for any abnormalities.
7. Repeat steps 5 and 6 to inspect the display in green, blue, black, white and text screens.

The test is complete when the text screen appears. To exit, press **button 3** again.

If you do not detect any screen abnormalities upon using the built-in diagnostic tool, the monitor is functioning properly. Check the video card and computer.



Common problems

The following table contains general information about common monitor problems you might encounter and the possible solutions:

Common Symptoms	Possible Solutions
No video/power LED off	<ul style="list-style-type: none">• Ensure that the video cable connecting the monitor and the computer is properly connected and secure.• Verify that the power outlet is functioning properly using any other electrical equipment.• Ensure that the correct input source is selected via the Input source menu.
No video/power LED on	<ul style="list-style-type: none">• Increase brightness and contrast controls using the OSD.• Perform monitor self-test feature check.• Check for bent or broken pins in the video cable connector.• Run the built-in diagnostics.• Ensure that the correct input source is selected via the Input source menu.
Poor focus	<ul style="list-style-type: none">• Eliminate video extension cables.• Reset the monitor to Factory Settings (Factory Reset).• Change the video resolution to the correct aspect ratio.
Shaky/jittery video	<ul style="list-style-type: none">• Reset the monitor to Factory Settings (Factory Reset).• Check environmental factors.• Relocate the monitor and test in another room.
Missing pixels	<ul style="list-style-type: none">• Cycle power on-off.• Pixel that is permanently Off is a natural defect that can occur in LCD technology.• For more information on Dell Monitor Quality and Pixel Policy, see Dell Support site at www.dell.com/support/monitors.
Stuck-on pixels	<ul style="list-style-type: none">• Cycle power on-off.• Pixel that is permanently off is a natural defect that can occur in LCD technology.• For more information on Dell Monitor Quality and Pixel Policy, see Dell Support site at www.dell.com/support/monitors.
Brightness problems	<ul style="list-style-type: none">• Reset the monitor to Factory Settings (Factory Reset).• Adjust brightness & contrast controls via OSD.
Geometric distortion	<ul style="list-style-type: none">• Reset the monitor to Factory Settings (Factory Reset).• Adjust horizontal & vertical controls via OSD.
Horizontal/vertical lines	<ul style="list-style-type: none">• Reset the monitor to Factory Settings (Factory Reset).• Perform monitor self-test feature check and determine if these lines are also in self-test mode.• Check for bent or broken pins in the video cable connector.• Run the built-in diagnostics.



Synchronization problems	<ul style="list-style-type: none"> • Reset the monitor to Factory Settings (Factory Reset). • Perform monitor self-test feature check to determine if the scrambled screen appears in self-test mode. • Check for bent or broken pins in the video cable connector. • Restart the computer in the <i>safe mode</i>.
Safety related issues	<ul style="list-style-type: none"> • Do not perform any troubleshooting steps. • Contact Dell immediately.
Intermittent problems	<ul style="list-style-type: none"> • Ensure that the video cable connecting the monitor to the computer is connected properly and is secure. • Reset the monitor to Factory Settings (Factory Reset). • Perform monitor self-test feature check to determine if the intermittent problem occurs in self-test mode.
Missing color	<ul style="list-style-type: none"> • Perform monitor self-test feature check. • Ensure that the video cable connecting the monitor to the computer is connected properly and is secure. • Check for bent or broken pins in the video cable connector.
Wrong color	<ul style="list-style-type: none"> • Change the Color Setting Mode in the Color Settings OSD to Graphics or Video depending on the application. • Try different Preset Modes in Color settings OSD. Adjust R/G/B value in Custom Color in Color settings OSD. • Change the Input Color Format to RGB or YPbPr in the Color settings OSD. • Run the built-in diagnostics.
Image retention from a static image left on the monitor for a long period of time	<ul style="list-style-type: none"> • Use the Power Management feature to turn off the monitor at all times when not in use (for more information, see Power management modes). • Alternatively, use a dynamically changing screensaver.
Video ghosting or overshooting	<ul style="list-style-type: none"> • Change the Response Time in the Display OSD to Fast or Normal depending on your application and usage.



Product-specific problems

Specific Symptoms	Possible Solutions
Screen image is too small	<ul style="list-style-type: none">• Check the Aspect Ratio setting in the Display settings OSD.• Reset the monitor to Factory Settings (Factory Reset) .
Cannot adjust the monitor with the buttons on the side panel	<ul style="list-style-type: none">• Turn off the monitor, unplug the power cord, plug it back, and then turn on the monitor.• Check if the OSD menu is locked. If yes, press and hold the button above the power button for 6 seconds to unlock. (For more information, see Lock).
No input signal when user controls are pressed	<ul style="list-style-type: none">• Check the signal source. Ensure the computer is not in standby or sleep mode by moving the mouse or pressing any key on the keyboard.• Check if the video cable is plugged in properly. Disconnect and reconnect the video cable if necessary.• Reset the computer or video player.
The picture does not fill the entire screen	<ul style="list-style-type: none">• Due to different video formats (aspect ratio) of DVDs, the monitor may display in full screen.• Run the built-in diagnostics.



Universal serial bus (USB) specific problems

Specific Symptoms	Possible Solutions
USB interface is not working	<ul style="list-style-type: none"> • Check that your monitor is turned On. • Reconnect the upstream cable to your computer. • Reconnect the USB peripherals (downstream connector). • Switch Off and then turn On the monitor again. • Reboot the computer. • Some USB devices like external portable HDD require higher electric current; connect the device directly to the computer system.
Supre Speed USB 3.0 interface is slow	<ul style="list-style-type: none"> • Check that your computer is USB 3.0-capable.. • Some computers have USB 3.0, USB 2.0, and USB 1.1 ports. Ensure that the correct USB port is used. • Ensure that the correct USB port is used. • Reconnect the upstream cable to your computer. • Reconnect the USB peripherals (downstream connector). • Reboot the computer.
Wireless USB peripherals stop working when a USB 3.0 device is plugged in	<ul style="list-style-type: none"> • Increase the distance between the USB 3.0 peripherals and the wireless USB receiver. • Position your wireless USB receiver as close as possible to the wireless USB peripherals. • Use a USB-extender cable to position the wireless USB receiver as far away as possible from the USB 3.0 port.

Microsoft® Skype for Business® Specific Problems

Specific Symptoms	Possible Solutions
The Hook button is not working	<ul style="list-style-type: none"> • Ensure that the USB upstream cable is connected between the monitor and the computer or notebook. • Ensure that you have signed in to Skype for Business.
Webcam is not detected	<ul style="list-style-type: none"> • Ensure that the USB upstream cable is connected between the monitor and the computer or notebook. • Reconnect the USB upstream cable to the computer or notebook.
The Mute button is not working	<ul style="list-style-type: none"> • Ensure that the USB upstream cable is connected between the monitor and the computer or notebook. • Reconnect the USB upstream cable to the computer or notebook.



No sound coming from the speakers

- Ensure that you have set the default playback device as "DELL P2418HZm" on your system.
- Turn Off the monitor, unplug the monitor power cord, replug it, and then turn On the monitor.
- Reset the monitor to **Factory Settings**.

Wireless mouse is not working or lagging

- Increase the distance between the USB 3.0 peripherals and the wireless USB receiver.
 - Position your wireless USB receiver as close as possible to the wireless mouse.
 - Use a USB-extender cable to position the wireless USB receiver as far away as possible from the USB 3.0 port.
-



Appendix

WARNING: Safety Instructions

-  **WARNING: Use of controls, adjustments, or procedures other than those specified in this documentation may result in exposure to shock, electrical hazards, and/or mechanical hazards.**

For information on safety instructions, see the *Safety, Environmental, and Regulatory Information (SERI)*.

FCC notices (U.S. Only) and other regulatory information

For FCC notices and other regulatory information, see the regulatory compliance website located at www.dell.com/regulatory_compliance.

Contacting Dell

To contact Dell for sales, technical assistance, or customer service issues:

1. Go to www.dell.com/contactdell.
2. Verify your country or region in the **Choose a Country/Region** drop-down list at the bottom of the page.
3. Select the appropriate service or support link based on your requirement or choose the method of contacting Dell that is convenient for you. Dell provides several online and telephone-based support and service options. Availability varies by country and product, and some services may not be available in your area.

 **NOTE:** If you do not have an active internet connection, you can find contact information on your purchase invoice, packing slip, bill, or Dell product catalog.



Free Manuals Download Website

<http://myh66.com>

<http://usermanuals.us>

<http://www.somanuals.com>

<http://www.4manuals.cc>

<http://www.manual-lib.com>

<http://www.404manual.com>

<http://www.luxmanual.com>

<http://aubethermostatmanual.com>

Golf course search by state

<http://golfingnear.com>

Email search by domain

<http://emailbydomain.com>

Auto manuals search

<http://auto.somanuals.com>

TV manuals search

<http://tv.somanuals.com>