

Dell™ PowerEdge™ 1600SC Systems Installation and Troubleshooting Guide

[Introduction](#)
[Indicators, Codes, and Messages](#)
[Finding Software Solutions](#)
[Running the System Diagnostics](#)
[Troubleshooting Your System](#)
[Installing System Options](#)
[Installing Drives](#)
[Getting Help](#)
[Jumpers, Switches, and Connectors](#)
[I/O Ports and Connectors](#)
[Abbreviations and Acronyms](#)



NOTE: A NOTE indicates important information that helps you make better use of your computer.



NOTICE: A NOTICE indicates either potential damage to hardware or loss of data and tells you how to avoid the problem.



CAUTION: A CAUTION indicates a potential for property damage, personal injury, or death.

Information in this document is subject to change without notice.

© 2003 Dell Inc. All rights reserved.

Reproduction in any manner whatsoever without the written permission of Dell Inc. is strictly forbidden.

Trademarks used in this text: *Dell*, the *DELL* logo, *PowerEdge*, *Dell OpenManage*, *DellNet*, *Dell Precision*, *Dimension*, *Inspiron*, *OptiPlex*, and *Latitude* are trademarks of Dell Inc.; *Intel* is a registered trademark of Intel Corporation; *MS-DOS* is a registered trademark of Microsoft Corporation.

Other trademarks and trade names may be used in this document to refer to either the entities claiming the marks and names or their products. Dell Inc. disclaims any proprietary interest in trademarks and trade names other than its own.

Initial release: 22 Sep 2003

Jumpers, Switches, and Connectors

Dell™ PowerEdge™ 1600SC Systems Installation and Troubleshooting Guide

- [Jumpers—A General Explanation](#)
 - [System Board Jumpers](#)
 - [System Board Connectors](#)
 - [Disabling a Forgotten Password](#)
-

This section provides specific information about the system jumpers. It also provides some basic information on jumpers and switches and describes the connectors on the various boards in the system.

Jumpers—A General Explanation

Jumpers provide a convenient and reversible way of reconfiguring the circuitry on a printed circuit board. When reconfiguring the system, you may need to change jumper settings on circuit boards or drives.

Jumpers

Jumpers are small blocks on a circuit board with two or more pins emerging from them. Plastic plugs containing a wire fit down over the pins. The wire connects the pins and creates a circuit. To change a jumper setting, pull the plug off its pin(s) and carefully fit it down onto the pin(s) indicated. [Figure A-1](#) shows an example of a jumper.

Figure A-1. Example Jumpers

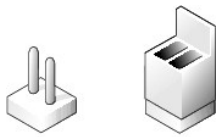

CAUTION: Ensure that the system is turned off before you change a jumper setting. Otherwise, damage to the system or unpredictable results may occur.

A jumper is referred to as open or unjumped when the plug is pushed down over only one pin or if there is no plug at all. When the plug is pushed down over two pins, the jumper is referred to as jumped. The jumper setting is often shown in text as two numbers, such as 1–2. The number 1 is printed on the circuit board so that you can identify each pin number based on the location of pin 1.

[Figure A-2](#) shows the location and default settings of the system jumper blocks. See [Table A-1](#) for the designations, default settings, and functions of the system's jumpers.

System Board Jumpers

[Figure A-2](#) shows the location of the configuration jumpers on the system board. [Table A-1](#) lists the jumpers settings.

Figure A-2. System Board Jumpers

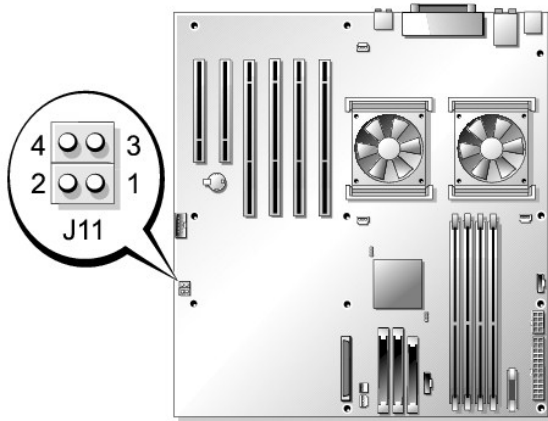







Table A-1. System Board Jumper Settings

Jumper	Setting	Description
J11 pins 1 and 2	 (default)	The password feature is enabled.
		The password feature is disabled.
J11 pins 3 and 4	 (default)	The configuration settings in NVRAM are retained at system boot.
		The configuration settings in NVRAM are cleared at next system boot (see " Resetting Corrupted BIOS Configuration " in "Troubleshooting Your System").
 jumpered  unjumpered		

System Board Connectors

See [Figure A-3](#) and [Table A-2](#) for the location and description of system board connectors. [Figure A-3](#) also indicates expansion slots and bus operating speeds.

Figure A-3. System Board Connectors

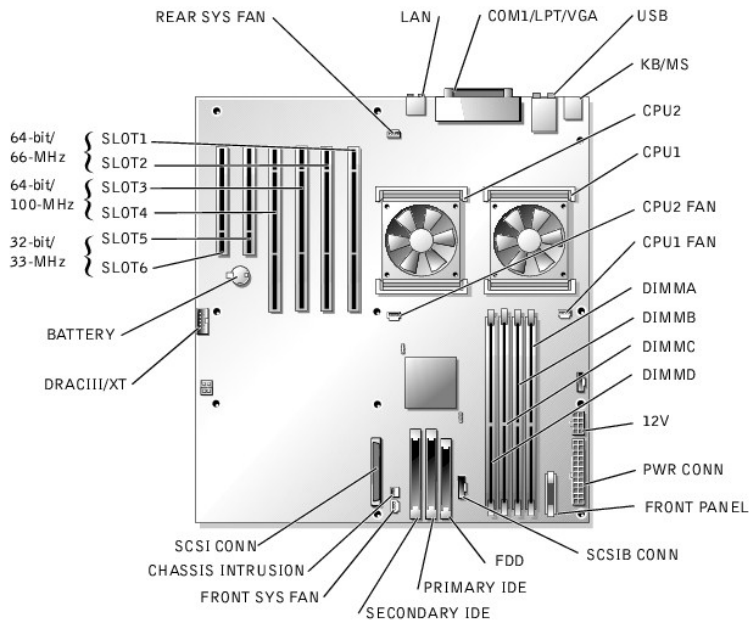

Table A-2. System Board Connectors

Connector	Description
BATTERY	System battery
CHASSIS INTRUSION	Chassis intrusion switch
COM1/LPT/VGA	Serial, parallel, and video
CPU _n	Microprocessors (2)
CPU _n FAN	Microprocessor fan power (2)
DIMM _x	Memory modules (4)
DRACIII/XT	Systems management
FDD	Diskette drive
FRONT PANEL	Front-panel switches and indicators
FRONT SYS FAN	Front system fan power
KB/MS	PS/2 keyboard and mouse
LAN	NIC
PRIMARY IDE	Primary IDE
PWR CONN	System board power
SCSI CONN	SCSI controller
SCSIB CONN	SCSI backplane
SECONDARY IDE	Secondary IDE
SLOT _n	Expansion slots: <ul style="list-style-type: none"> 1-2: 64-bit/66-MHz PCI 3-4: 64-bit/100-MHz PCIX 5-6: 32-bit/33-MHz PCI
REAR SYS FAN	Back system fan power
USB	USB (2)
12V	System board power

NOTE: For the full name of an abbreviation or acronym used in this table, see "[Abbreviations and Acronyms.](#)"

Disabling a Forgotten Password

The system's software security features include a system password and a setup password, which are discussed in detail in "Using the System Setup Program" in your *User's Guide*. The password jumper enables these password features or disables them and clears any password(s) currently in use.

 **CAUTION:** Before you perform this procedure, see "[Safety First—For You and Your System](#)" in "Troubleshooting Your System."

 **CAUTION:** See "Protecting Against Electrostatic Discharge" in the safety instructions in your *System Information Guide*.

1. Turn off the system, including any attached peripherals, and disconnect the system from the electrical outlet.
2. Remove the cover (see "[Removing the Cover](#)" in "Troubleshooting Your System").
3. Lay the system on its right side.
4. Remove the password jumper plug.

See [Figure A-2](#) to locate the password jumper on the system board.

5. Stand the system upright.
6. Install the cover (see "[Installing the Cover](#)" in "Troubleshooting Your System").
7. Reconnect the system to its electrical outlet and turn the system on, including any attached peripherals.

The existing passwords are not disabled (erased) until the system boots with the password jumper plug removed. However, before you assign a new system and/or setup password, you must install the jumper plug.

 **NOTE:** If you assign a new system and/or setup password with the jumper plug still removed, the system disables the new password(s) the next time it boots.

8. Turn off the system, including any attached peripherals, and disconnect the system from the electrical outlet.
9. Remove the cover (see "[Removing the Cover](#)" in "Troubleshooting Your System").
10. Lay the system on its right side.
11. Install the password jumper plug.

See [Figure A-2](#) to locate the password jumper on the system board.

12. Stand the system upright.
13. Install the cover (see "[Installing the Cover](#)" in "Troubleshooting Your System").
14. Reconnect the system to its electrical outlet and turn the system on, including any attached peripherals.
15. Assign a new system and/or setup password.

To assign a new password using the System Setup program, see "Using the System Setup Program" in your *User's Guide*.

[Back to Contents Page](#)

I/O Ports and Connectors

Dell™ PowerEdge™ 1600SC Systems Installation and Troubleshooting Guide

- [I/O Connectors](#)
- [Serial Connector](#)
- [Parallel Connector](#)
- [PS/2-Compatible Keyboard and Mouse Connectors](#)
- [Video Connector](#)
- [USB Connector](#)
- [Integrated NIC Connector](#)
- [Network Cable Requirements](#)

I/O Connectors





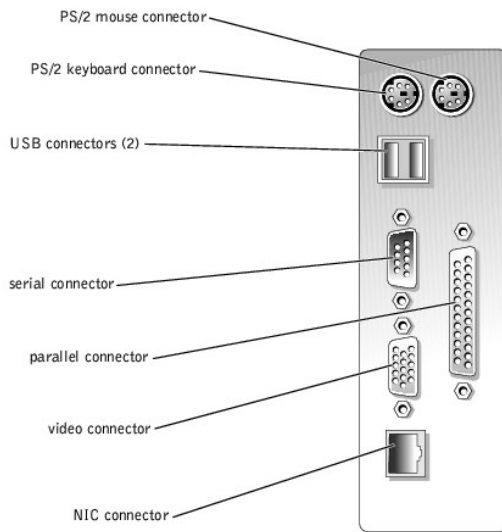

I/O connectors are the gateways that the system uses to communicate with external devices, such as a keyboard, mouse, printer, or monitor. This section describes the various connectors on your system. If you reconfigure the hardware connected to the system, you may also need the pin number and signal information for these connectors. [Figure B-1](#) illustrates the connectors on the system.

Figure B-1. I/O Connectors



[Table B-1](#) shows the icons used to label the connectors on the system.

Table B-1. I/O Connector Icons

Icon	Connector
	Serial connector
	Parallel connector
	Mouse connector
	Keyboard connector
	Video connector
	USB connector

	NIC connector
---	---------------

Serial Connector

Serial connectors support devices such as external modems, printers, and mice that require serial data transmission. The serial connector uses a 9-pin D-subminiature connector.

Serial Connector Autoconfiguration

The default designation of the integrated serial connector is COM1. When you add an expansion card containing a serial connector that has the same designation as the integrated connector, the system's autoconfiguration feature remaps (reassigns) the integrated serial connector to the next available designation. Both the new and the remapped COM connectors share the same IRQ setting. COM1 and COM3 share IRQ4, while COM2 and COM4 share IRQ3.

NOTE: If two COM connectors share an IRQ setting, you may not be able to use them both at the same time. In addition, if you install one or more expansion cards with serial connectors designated as COM1 and COM3, the integrated serial connector is disabled.

Before adding a card that remaps the COM connectors, check the documentation that came with the software to make sure that the software can accommodate the new COM connector designation.

[Figure B-2](#) illustrates the pin numbers for the serial connector and [Table B-2](#) defines the pin assignments for the connector.

Figure B-2. Serial Connector Pin Numbers

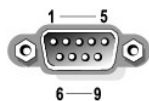

Table B-2. Serial Connector Pin Assignments

Pin	Signal	I/O	Definition
1	DCD	I	Data carrier detect
2	SIN	I	Serial input
3	SOUT	O	Serial output
4	DTR	O	Data terminal ready
5	GND	N/A	Signal ground
6	DSR	I	Data set ready
7	RTS	O	Request to send
8	CTS	I	Clear to send
9	RI	I	Ring indicator
Shell	N/A	N/A	Chassis ground

Parallel Connector

The integrated parallel connector, intended primarily for use by printers that require data in parallel format, uses a 25-pin D-subminiature connector on the system's back panel. The default designation of the system's parallel connector is LPT1. If you add an expansion card containing a parallel connector configured as LPT1 (IRQ7, I/O address 378h), use the System Setup program to remap the integrated parallel connector. See "Using the System Setup Program" in the *User's Guide*. [Figure B-3](#) illustrates the pin numbers for the parallel connector and [Table B-3](#) defines the pin assignments for the connector.

Figure B-3. Parallel Connector Pin Numbers

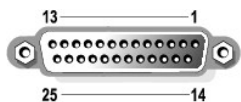

Table B-3. Parallel Connector Pin Assignments

Pin	Signal	I/O	Definition
1	STB#	I/O	Strobe
2	PD0	I/O	Printer data bit 0
3	PD1	I/O	Printer data bit 1
4	PD2	I/O	Printer data bit 2
5	PD3	I/O	Printer data bit 3
6	PD4	I/O	Printer data bit 4
7	PD5	I/O	Printer data bit 5
8	PD6	I/O	Printer data bit 6
9	PD7	I/O	Printer data bit 7
10	ACK#	I	Acknowledge
11	BUSY	I	Busy
12	PE	I	Paper end
13	SLCT	I	Select
14	AFD#	O	Automatic feed
15	ERR#	I	Error
16	INIT#	O	Initialize printer
17	SLIN#	O	Select in
18-25	GND	N/A	Ground

PS/2-Compatible Keyboard and Mouse Connectors

The PS/2-compatible keyboard and mouse cables attach to 6-pin, miniature DIN connectors. [Figure B-4](#) illustrates the pin numbers for these connectors and [Table B-4](#) defines the pin assignments for these connectors.

Figure B-4. Keyboard and Mouse Connector Pin Numbers



Table B-4. Keyboard and Mouse Connector Pin Assignments

Pin	Signal	I/O	Definition
1	KBDATA or MFDATA	I/O	Keyboard data or mouse data
2	NC	N/A	No connection
3	GND	N/A	Signal ground
4	FVcc	N/A	Fused supply voltage
5	KBCLK or MFCLK	I/O	Keyboard clock or mouse clock
6	NC	N/A	No connection
Shell	N/A	N/A	Chassis ground

Video Connector

You can attach a VGA-compatible monitor to the system's integrated video controller using a 15-pin high-density D-subminiature connector. [Figure B-5](#) illustrates the pin numbers for the video connector and [Table B-5](#) defines the pin assignments for the connector.

 **NOTE:** Installing a video card automatically disables the system's integrated video controller.

Figure B-5. Video Connector Pin Numbers

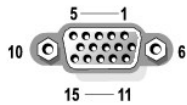

Table B-5. Video Connector Pin Assignments

Pin	Signal	I/O	Definition
1	RED	O	Red video
2	GREEN	O	Green video
3	BLUE	O	Blue video
4	NC	N/A	No connection
5-8, 10	GND	N/A	Signal ground
9	VCC	N/A	Vcc
11	NC	N/A	No connection
12	DDC data out	O	Monitor detect data
13	HSYNC	O	Horizontal synchronization
14	VSYNC	O	Vertical synchronization
15	NC	N/A	No connection

USB Connector

The system's USB connector supports USB-compliant peripherals such as keyboards, mice, and printers and may also support USB-compliant devices such as diskette drives and CD drives. [Figure B-6](#) illustrates the pin numbers for the USB connector and [Table B-6](#) defines the pin assignments for the connector.

 **NOTICE:** Do not attach a USB device or a combination of USB devices that draw a maximum current of more than 500 mA per channel or +5 V. Attaching devices that exceed this threshold may cause the USB connectors to shut down. See the documentation that accompanied the USB devices for their maximum current ratings.

Figure B-6. USB Connector Pin Numbers



Table B-6. USB Connector Pin Assignments

Pin	Signal	I/O	Definition
1	Vcc	N/A	Supply voltage
2	DATA	I	Data in
3	+DATA	O	Data out
4	GND	N/A	Signal ground

Integrated NIC Connector

The system's integrated NIC functions as a separate network expansion card while providing fast communication between servers and workstations. [Figure B-7](#) illustrates the pin numbers for the NIC connector and [Table B-7](#) defines the pin assignments for the connector.

Figure B-7. NIC Connector

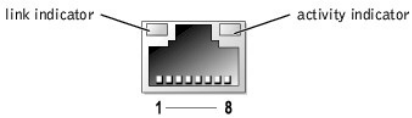

Table B-7. NIC Connector Pin Assignments

Pin	Signal	I/O	Definition
1	TD+	O	Data out (+)
2	TD-	O	Data out (-)
3	RD+	I	Data in (+)
4	NC	N/A	No connection
5	NC	N/A	No connection
6	RD-	I	Data in (-)
7	NC	N/A	No connection
8	NC	N/A	No connection

Network Cable Requirements

The NIC supports a UTP Ethernet cable equipped with a standard RJ45-compatible plug. Observe the following cabling restrictions.

🔔 **NOTICE:** To avoid line interference, voice and data lines must be in separate sheaths.

- 1 Use Category 5 or greater wiring and connectors.
- 1 Do not exceed a cable run length (from a workstation to a hub) of 100 m (328 ft).

For detailed guidelines on operation of a network, see "Systems Considerations of Multi-Segment Networks" in the IEEE 802.3 standard.

[Back to Contents Page](#)

[Back to Contents Page](#)

Abbreviations and Acronyms

Dell™ PowerEdge™ 1600SC Systems Installation and Troubleshooting Guide

A

ampere(s)

AC

alternating current

ADC

analog-to-digital converter

ANSI

American National Standards Institute

APIC

Advanced Peripheral Interrupt Controller

ASIC

application-specific integrated circuit

BIOS

basic input/output system

BMC

baseboard management controller

bpi

bits per inch

bps

bits per second

BTU

British thermal unit

C

Celsius

CD

compact disc

CGA

color graphics adapter

cm

centimeter(s)

CMOS

complementary metal oxide semiconductor

COM

communications

cpi

characters per inch

cpl

characters per line

CPU

central processing unit

DAC

digital-to-analog converter

DAT

digital audio tape

dB

decibel(s)

dBA

adjusted decibel(s)

DC

direct current

DDR

double-data rate

DIMM

dual in-line memory module

DIN

Deutsche Industrie Norm

DIP

dual in-line package

DMA

direct memory access

DOC

Department of Communications (in Canada)

dpi

dots per inch

DRAC III

remote access card

DRAM

dynamic random-access memory

DS/DD

double-sided double-density

DS/HD

double-sided high-density

ECC

error checking and correction

EDO

extended-data out

EGA

enhanced graphics adapter

EIDE

enhanced integrated drive electronics

EMI

electromagnetic interference

EMM

expanded memory manager

EMS

Expanded Memory Specification

EPP

Enhanced Parallel Port

EPROM

erasable programmable read-only memory

ERA

embedded remote access

ESD

electrostatic discharge

ESDI

enhanced small-device interface

ESM

embedded server management

F

Fahrenheit

FAT

file allocation table

FCC

Federal Communications Commission

ft

feet

g

gram(s)

G

gravities

GB

gigabyte(s)

GUI

graphical user interface

Hz

hertz

I/O

input/output

ID

identification

IDE

integrated drive electronics

IRQ

interrupt request

K

kilo- (1024)

KB

kilobyte(s)

KB/sec

kilobyte(s) per second

Kb

kilobit(s)

Kbps

kilobit(s) per second

kg

kilogram(s)

KHz

kilohertz

LAN

local area network

lb

pound(s)

LCD

liquid crystal display

LED

light-emitting diode

LIF

low insertion force

LN

load number

lpi

lines per inch

LVD

low voltage differential

m

meter(s)

mA

milliampere(s)

mAh

milliampere-hour(s)

MB

megabyte(s)

Mb

megabit(s)

Mbps

megabit(s) per second

MBR

master boot record

MDA

monochrome display adapter

MGA

monochrome graphics adapter

MHz

megahertz

mm

millimeter(s)

ms

millisecond(s)

MTBF

mean time between failures

mV

millivolt(s)

NIC

network interface controller

NiCad

nickel cadmium

NiMH

nickel-metal hydride

NMI

nonmaskable interrupt

ns

nanosecond(s)

NTFS

NT File System

NVRAM

nonvolatile random-access memory

OTP

one-time programmable

PAL

programmable array logic

PCI

Peripheral Component Interconnect

PCMCIA

Personal Computer Memory Card International Association

PDB

power distribution board

PDU

power distribution unit

PGA

pin grid array

PIC

personal identification code

POST

power-on self-test

ppm

pages per minute

PQFP

plastic quad flat pack

PSDB

power-supply distribution board

PS/2

Personal System/2

PXE

preboot execution environment

RAID

redundant arrays of independent disks

RAC

remote access controller

RAM

random-access memory

RCU

Resource Configuration Utility

REN

ringer equivalence number

RFI

radio frequency interference

RGB

red/green/blue

ROM

read-only memory

rpm

revolutions per minute

RTC

real-time clock

SBE

single bit ECC

SCSI

small computer system interface

sec

second(s)

SEC

single-edge contact

SEL

system event log

SDRAM

synchronous dynamic random-access memory

SIMM

single in-line memory module

SMB

server management bus

SMI

system management interrupt

SNMP

Simple Network Management Protocol

SRAM

static random-access memory

SVGA

super video graphics array

TFT

thin film transistor

tpi

tracks per inch

UMB

upper memory block

UPS

uninterruptible power supply

USB

universal serial bus

V

volt(s)

VAC

volt(s) alternating current

VDC

volt(s) direct current

VGA

video graphics array

VLSI

very-large-scale integration

VRAM

video random-access memory

VRM

voltage regulator module

W

watt(s)

WH

watt-hour(s)

XMM

extended memory manager

XMS

ZIF

zero insertion force

[Back to Contents Page](#)

Introduction

Dell™ PowerEdge™ 1600SC Systems Installation and Troubleshooting Guide

- [Other Documents You May Need](#)
 - [Obtaining Technical Assistance](#)
-

Your system includes the following significant service and upgrade features:

- 1 Embedded server management hardware, which monitors temperatures and voltages throughout the system and notifies you if there is a fault or failure
- 1 System diagnostics, which checks for hardware problems (if the system can boot)

The following system options are offered:

- 1 Microprocessors
 - 1 System memory
 - 1 Expansion-card options, including RAID controller cards
 - 1 IDE and SCSI hard drives
 - 1 SCSI backplane board for hot-plug SCSI drive support
 - 1 IDE and SCSI tape drives
 - 1 Redundant, hot-plug power supplies
-

Other Documents You May Need

 The *System Information Guide* provides important safety and regulatory information. Warranty information may be included within this document or as a separate document.

- 1 The *Setting Up Your System* document provides an overview of initially setting up your system.
- 1 The *User's Guide* provides information about system features and technical specifications.
- 1 Systems management software documentation describes the features, requirements, installation, and basic operation of the software.
- 1 Operating system documentation describes how to install (if necessary), configure, and use the operating system software.
- 1 Other documentation included on the CDs that came with your system describing the use of advanced system features.
- 1 Updates are sometimes included with the system to describe changes to the system, software, and/or documentation.

 **NOTE:** Always read the updates first because they often supersede information in other documents.

- 1 Release notes or readme files may be included to provide last-minute updates to the system or documentation, or advanced technical reference material intended for experienced users or technicians.
-

Obtaining Technical Assistance

If at any time you do not understand a procedure described in this guide or if your system does not perform as expected, a number of tools are provided to help you. For more information on these help tools, see "[Getting Help](#)."

Indicators, Codes, and Messages

Dell™ PowerEdge™ 1600SC Systems Installation and Troubleshooting Guide

- [Front-Panel Features](#)
- [Back-Panel Features](#)
- [Power Indicator Codes](#)
- [Hard-Drive Indicator Codes](#)
- [NIC Indicator Codes](#)
- [System Messages](#)
- [System Beep Codes](#)
- [Warning Messages](#)
- [Diagnostics Messages](#)
- [Alert Messages](#)

Applications, operating systems, and the system itself are capable of identifying problems and alerting you to them. When a problem occurs, a message may appear on the monitor or a beep code may sound.

A variety of messages can indicate when the system is not operating properly:

- 1 System messages
- 1 System beep codes
- 1 Warning messages
- 1 Diagnostics messages
- 1 Alert messages

The system indicators and front- and back-panel features are illustrated in this section. This section also describes each type of message and lists the possible causes and actions you can take to resolve any problems indicated by a message.

Front-Panel Features

[Figure 2-1](#), [Figure 2-2](#), and [Figure 2-3](#) show the system's front-panel features. [Table 2-1](#) describes the front-panel controls and indicators.

Figure 2-1. System With Non-Hot-Plug Hard Drives

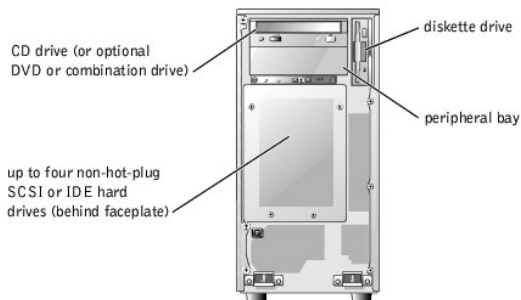

Figure 2-2. System With Hot-Plug SCSI Hard Drives

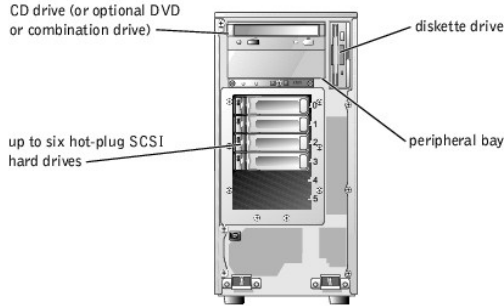

Figure 2-3. Front-Panel Controls and Indicators

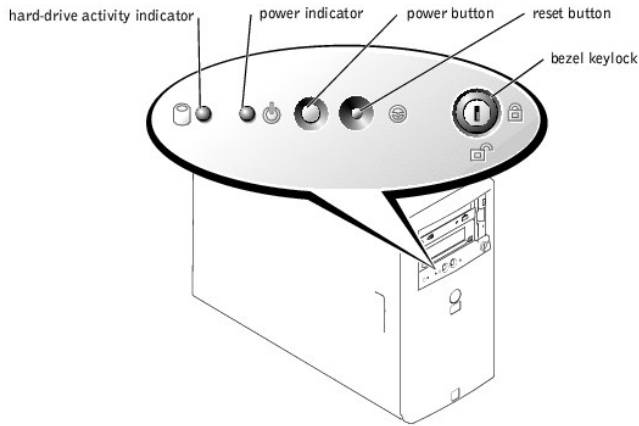

Table 2-1. Front-Panel Controls and Indicators

Component	Description
Power button	Turns system power off and on. <ul style="list-style-type: none"> 1 If you turn off the system using the power button and the system is running an ACPI-compliant operating system, the system can perform an orderly shutdown before power is turned off. If the power button is pressed for more than four seconds, the system power will turn off regardless of the current operating system state. 1 If the system is not running an ACPI-compliant operating system, power is turned off immediately after the power button is pressed. <p>The power button is enabled in the System Setup program. When disabled, the button can only turn the system power on. For more information, see your <i>User's Guide</i> and the operating system's documentation.</p>
Reset button	Restarts the system.
Power indicator	Provides information on power status (see " Power Indicator Codes ").
Hard-drive activity indicator	Indicates read or write access to a hard drive.
Diskette and CD drive indicators	Indicate read or write access to the respective drive.

Back-Panel Features

[Figure 2-4](#) shows the back-panel features of the system. [Table 2-2](#) describes the back-panel features.

Figure 2-4. Back-Panel Features

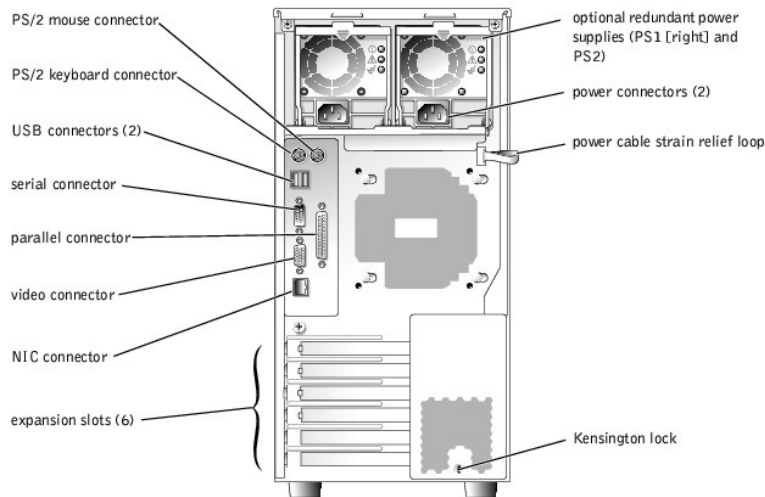

Table 2-2. Back-Panel Features

Component	Description
Power connector	Connects the system's power supply to a power source.
Power cable strain relief loop	Relieves strain on the power cable.
NIC indicators	Provide information on NIC status (see " NIC Indicator Codes ").
Expansion slots	Provide two 64-bit/100-MHz slots, two 64-bit/66-MHz slots, and two 32-bit/33-MHz slots.
I/O ports and connectors	Connect peripheral devices to the system.

Power Indicator Codes

The power button on the front panel controls the power input to the system's power supplies. The power indicator can provide information on power status (see [Figure 2-3](#)). [Table 2-3](#) lists the power button indicator codes.

Table 2-3. Power Button Indicators

Indicator	Function
On	Indicates that power is supplied to the system and the system is operational.
Off	Indicates that no power is supplied to the system.
Blinking	Indicates that power is supplied to the system, but the system is in a standby state. For information on standby states, see your operating system documentation.

The indicators on the optional redundant power supplies show whether power is present or whether a power fault has occurred (see [Figure 2-5](#)).

Figure 2-5. Redundant Power Supply Indicators

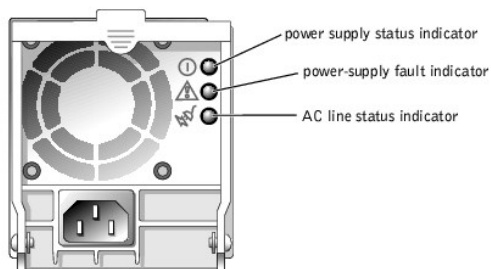

Table 2-4. Redundant Power Supply Indicators

Indicator	Function
Power supply status	Green indicates that the power supply is operational.
Power supply fault	Amber indicates a problem with the power supply.
AC line status	Green indicates that a valid AC source is connected to the power supply.

Hard-Drive Indicator Codes

Each hard-drive carrier has two indicators: a busy indicator and a status indicator (see [Figure 2-6](#)). The indicators provide information on the status of the respective hard drive.

Figure 2-6. Hard-Drive Indicators

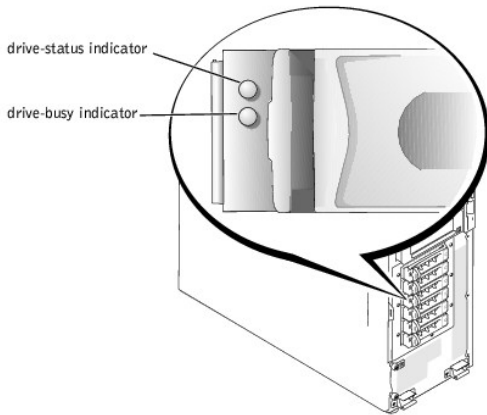

[Table 2-5](#) lists the drive status indicator codes. Different codes display as drive events occur in the system. For example, in the event of a hard-drive failure, the "drive fail" code appears. After the drive is selected for removal, the "preparing for removal" code appears. After the replacement drive is installed, the "preparing for operation, drive online" code appears.

The drive-busy indicator signifies whether the hard drive is active on the SCSI bus. This indicator is controlled by the hard drive.

Table 2-5. Hard-Drive Status Indicator Codes

Drive-Status Indicator	Indicator Code
Drive bay empty	Off
Drive being prepared for operation, drive online	Steady green
Drive being identified, prepared for removal, or drive offline	Blinks green three times per second at equal intervals
Drive rebuilding	Blinks green once per second
Drive failed	Steady amber

NIC Indicator Codes

The NIC on the back panel has an indicator that provides information on network activity and link status (see [Figure 2-7](#)). [Table 2-6](#) lists the NIC indicator codes.

Figure 2-7. NIC Indicators



Table 2-6. NIC Indicator Codes

Indicator	Indicator Code
Link and activity indicators are off.	The NIC is not connected to the network.
Link indicator is green.	The NIC is connected to a valid link partner on the network.
Activity indicator is amber blinking.	Network data is being sent or received.

System Messages

System messages alert you to a possible operating system problem or to a conflict between the software and hardware. [Table 2-7](#) lists the system error messages that can occur and the probable cause for each message.

NOTE: If you receive a system message that is not listed in [Table 2-7](#), see the documentation for the application that is running when the message appears and/or the operating system documentation for an explanation of the message and recommended action.

Table 2-7. System Messages

Message	Causes	Corrective Actions
Address mark not found	Faulty CD drive, diskette drive, or hard-drive; faulty system board.	See " Troubleshooting the Diskette Drive ," " Troubleshooting a CD Drive ," and " Troubleshooting Hard Drives " in "Troubleshooting Your System."
Alert! Back system fan was not detected.	Specified fan is missing, faulty, or improperly installed.	See " Troubleshooting System Cooling " in "Troubleshooting Your System."
Alert! CPU <i>n</i> fan was not detected.		
Alert! Front system fan was not detected.		
Alert! Cover was previously removed!	The chassis has been opened.	Information only.
Alert! Previous back system fan failure.	Specified fan failed before last system startup (see Figure 5-5 to identify the fans).	Information only.
Alert! Previous CPU <i>n</i> fan failure.		
Alert! Previous front system fan failure.		
Alert! Previous voltage failure.	Power supply failed before last system startup.	Information only.
Alert! Processor thermal probe failure detected.	Microprocessor fan is missing, faulty, or improperly installed.	See " Troubleshooting System Cooling " in "Troubleshooting Your System."
Alert! Unsupported memory or incomplete sets in the	Faulty memory module(s).	Ensure that all memory modules are properly installed. If the problem persists, see " Troubleshooting System Memory " in "Troubleshooting Your System."

following bank(s): Bank n		
Amount of available memory limited to 256 MB!	OS Install Mode is enabled in the System Setup program.	Disable OS Install Mode in the System Setup program (see "Using the System Setup Program" in your <i>User's Guide</i>).
Attachment failed to respond	Diskette-drive or hard-drive controller cannot send data to the associated drive; faulty or improperly installed diskette drive or hard drive.	See " Troubleshooting the Diskette Drive " and " Troubleshooting Hard Drives " in "Troubleshooting Your System."
Auxiliary device failure	Loose or improperly connected mouse or keyboard cable; faulty mouse or keyboard.	See " Troubleshooting the Mouse " and " Troubleshooting the Keyboard " in "Troubleshooting Your System."
Bad error-correction code (ECC) on disk read	Faulty CD/diskette-drive subsystem or hard-drive subsystem; faulty system board.	See " Getting Help ."
Controller has failed		
BIOS Update Attempt Failed!	Remote BIOS firmware update attempt failed.	Retry the BIOS firmware update (see " Getting Help ").
Caution! NVRAM_CLR jumper is installed on system board. Please run setup.	NVRAM-clear jumper is installed.	Remove the NVRAM-clear jumper (see Figure A-2 for jumper location). Check the System Setup configuration settings (see "Using the System Setup Program" in your <i>User's Guide</i>).
Data error	Faulty diskette, diskette drive, CD drive, tape drive, or hard drive.	Replace the diskette. If the problem persists, see " Troubleshooting the Diskette Drive ," " Troubleshooting a CD Drive ," " Troubleshooting a Tape Drive ," and " Troubleshooting Hard Drives " in "Troubleshooting Your System."
Decreasing available memory	Faulty or improperly installed memory modules.	See " Troubleshooting System Memory " in "Troubleshooting Your System."
Diskette drive seek failure	Incorrect configuration settings in the System Setup program. Faulty or improperly installed diskette drive.	Run the System Setup program to correct the settings (see "Using the System Setup Program" in your <i>User's Guide</i>). See " Troubleshooting the Diskette Drive " in "Troubleshooting Your System."
Diskette read failure	Faulty or improperly inserted diskette.	Replace the diskette.
Diskette subsystem reset failed	Faulty or improperly installed diskette drive.	See " Troubleshooting the Diskette Drive " in "Troubleshooting Your System."
Diskette write protected	Diskette write-protect feature activated.	Move the write-protect tab on the diskette to the disabled position.
Drive not ready	Diskette missing or improperly inserted in diskette drive.	Reinsert or replace the diskette.
Gate A20 failure	Faulty keyboard controller; faulty system board.	See " Getting Help ."
General failure	Operating system corrupted or improperly installed.	Reinstall the operating system.
Hard disk controller failure	Incorrect configuration settings in System Setup program; improperly installed hard drive; loose interface or power cable; faulty hard-drive controller subsystem.	Run the System Setup program to correct the drive type setting (see "Using the System Setup Program" in your <i>User's Guide</i>). If the problem persists, see " Troubleshooting Hard Drives " in "Troubleshooting Your System."
Invalid memory configuration detected. Potential corruption exists!	Memory module installation guidelines have not been properly followed.	See " Memory Module Installation Guidelines " in "Installing System Options."
Keyboard controller failure	Faulty keyboard controller; faulty system board.	See " Getting Help ."
Keyboard data line failure	Loose or improperly connected keyboard cable; faulty keyboard; faulty keyboard controller.	See " Troubleshooting the Keyboard " in "Troubleshooting Your System."
Keyboard failure		

Keyboard stuck key failure		
Memory address line failure at <i>address</i> , read value expecting value	Faulty or improperly installed memory modules.	See " Troubleshooting System Memory " in "Troubleshooting Your System."
Memory double word logic failure at <i>address</i> , read value expecting value		
Memory odd/even logic failure at start <i>address</i> to end <i>address</i>		
Memory write/read failure at <i>address</i> , read value expecting value		
Memory allocation error	Faulty application program.	Restart the application program.
Memory bank population error!	Memory module installation guidelines have not been properly followed.	See " Memory Module Installation Guidelines " in "Installing System Options."
Memory parity interrupt at <i>address</i>	Faulty or improperly installed memory modules.	See " Troubleshooting System Memory " in "Troubleshooting Your System."
Memory tests terminated by keystroke	The spacebar was pressed during POST to terminate the memory test.	Information only.
No boot device available	Faulty diskette, diskette drive, CD drive, or hard drive.	Use a bootable diskette, CD, or hard drive. If the problem persists, see " Troubleshooting the Diskette Drive ," " Troubleshooting a CD Drive ," and " Troubleshooting Hard Drives " in "Troubleshooting Your System."
No boot sector on hard-disk drive	No operating system on hard drive.	Check the hard-drive configuration settings in the System Setup program (see "Using the System Setup Program" in your <i>User's Guide</i>).
No timer tick interrupt	Faulty system board.	See " Getting Help ."
Non-system disk or disk error	Faulty diskette, diskette drive, CD drive, or hard drive.	See " Troubleshooting the Diskette Drive ," " Troubleshooting a CD Drive ," and " Troubleshooting Hard Drives " in "Troubleshooting Your System." If the problem persists, see " Getting Help ."
Not a boot diskette	No operating system on diskette.	Use a bootable diskette.
One <i>value1</i> MHz Processor, L2 Cache: 512KB One <i>value2</i> MHz processor, L2 Cache: 512KB System running at <i>value1</i> MHz	Microprocessors with different speeds are installed. System operates at speed of slower microprocessor.	Replace the slower microprocessor with one that matches the faster microprocessor.
PCI BIOS failed to install	Loose cables to expansion card(s); faulty or improperly installed expansion card.	Ensure that all appropriate cables are securely connected to the expansion cards. If the problem persists, see " Troubleshooting Expansion Cards " in "Troubleshooting Your System."
Plug & Play Configuration error	Error encountered while initializing PCI devices.	Install the NVRAM-clear jumper and reboot the system (see Figure A-2 for jumper location). If the problem persists, see " Troubleshooting Expansion Cards " in "Troubleshooting Your System."
Primary drive <i>n</i> not found	The primary IDE channel is enabled in the System Setup program, but no drive is attached; improperly installed hard drive; loose interface or power cable.	Run the System Setup program to correct the drive settings (see "Using the System Setup Program" in your <i>User's Guide</i>). If the problem persists, see " Troubleshooting Hard Drives " in "Troubleshooting Your System."
	Faulty diskette, diskette drive, CD drive, tape drive,	See " Troubleshooting the Diskette Drive ," " Troubleshooting a CD

Read fault	or hard drive.	Drive ," Troubleshooting a Tape Drive ," and Troubleshooting Hard Drives " in "Troubleshooting Your System." If the problem persists, see Getting Help ."
Requested sector not found		
Reset failed	Improperly connected diskette drive, tape drive, hard drive, or power cable.	Ensure that all cables are securely connected. If the problem persists, see Getting Help ."
ROM bad checksum = address	Faulty or improperly installed expansion card.	See Troubleshooting Expansion Cards " in "Troubleshooting Your System."
Secondary drive n not found	The secondary IDE controller is enabled in the System Setup program, but no drive is attached; improperly installed hard drive; loose interface or power cable.	Run the System Setup program to correct the drive settings (see "Using the System Setup Program" in your <i>User's Guide</i>). If the problem persists, see Troubleshooting Hard Drives " in "Troubleshooting Your System."
Sector not found	Faulty diskette or hard drive.	Replace the diskette. If the problem persists, see Troubleshooting Hard Drives " in "Troubleshooting Your System." If the problem persists, see Getting Help ."
Seek error		
Seek operation failed		
Shutdown failure	Shutdown test failure.	See Troubleshooting System Memory " in "Troubleshooting Your System."
Time-of-day clock stopped	Faulty battery.	See Troubleshooting the System Battery " in "Troubleshooting Your System."
Time-of-day not set - please run SETUP program	Incorrect Time or Date settings; faulty system battery.	Check the Time and Date settings (see "Using the System Setup Program" in your <i>User's Guide</i>). If the problem persists, replace the system battery (see System Battery " in "Installing System Options").
Timer chip counter 2 failed	Faulty system board.	See Getting Help ."
Unexpected interrupt in protected mode	Faulty or improperly installed memory modules or faulty system board.	See Troubleshooting System Memory " in "Troubleshooting Your System." If the problem persists, see Getting Help ."
Unsupported CPU stepping detected	Microprocessor is not supported by the system.	Update the BIOS firmware (see Getting Help).
Utility partition not available	The <F10> key was pressed during POST, but no utility partition exists on the boot hard drive.	Create a utility partition on the boot hard drive (see "Using the Dell OpenManage Server Assistant CD" in your <i>User's Guide</i>).
Warning! No microcode update loaded for processor n	BIOS error.	Update the BIOS firmware (see Getting Help).
Write fault	Faulty diskette, CD drive, diskette drive, hard drive, or hard-drive subsystem.	See Troubleshooting the Diskette Drive ," Troubleshooting a CD Drive ," and Troubleshooting Hard Drives " in "Troubleshooting Your System."
Write fault on selected drive		

System Beep Codes

When an error that cannot be reported on the monitor occurs during a boot routine, the system may emit a series of beeps that identify the problem.

 **NOTE:** If the system boots without a keyboard, mouse, or monitor attached, the system will not issue beep codes related to these peripherals.

When a beep code is emitted, record it on a copy of the Diagnostics Checklist in [Getting Help](#)," and then look it up in [Table 2-8](#). If you are unable to resolve the problem by looking up the meaning of the beep code, use the system diagnostics to identify the cause. If you are still unable to resolve the problem, see [Getting Help](#)."

Table 2-8. System Beep Codes

Code	Cause	Corrective Action
1-1-2	CPU register test failure	See " Troubleshooting a Microprocessor " in "Troubleshooting Your System."
1-1-3	CMOS write/read failure: faulty system board	See " Getting Help ."
1-1-4	BIOS error	Reflash the BIOS firmware (see " Getting Help ").
1-2-1	Programmable interval-timer failure: faulty system board	See " Getting Help ."
1-2-2	DMA initialization failure	See " Troubleshooting System Memory " in "Troubleshooting Your System."
1-2-3	DMA page register write/read failure	
1-3-1	Main-memory refresh verification failure	
1-3-2	No memory installed	
1-3-3	Chip or data line failure in the first 64 KB of main memory	
1-3-4	Odd/even logic failure in the first 64 KB of main memory	
1-4-1	Address line failure in the first 64 KB of main memory	
1-4-2	Parity failure in the first 64 KB of main memory	
1-4-3	Fail-safe timer test failure	
1-4-4	Software NMI port test failure	
2-1-1 through 2-4-4	Bit failure in the first 64 KB of main memory	
3-1-1	Slave DMA-register failure	See " Getting Help ."
3-1-2	Master DMA-register failure	
3-1-3	Master interrupt-mask register failure	
3-1-4	Slave interrupt-mask register failure	
3-2-2	Interrupt vector loading failure	
3-2-4	Keyboard-controller test failure	See " Troubleshooting the Keyboard " in "Troubleshooting Your System."
3-3-1	CMOS failure	See " Getting Help ."
3-3-2	System configuration check failure	
3-3-3	Keyboard controller not detected	
3-3-4	Video memory test failure	
3-4-1	Screen initialization failure	
3-4-2	Screen-retrace test failure	
3-4-3	Video ROM search failure	
4-2-1	No timer tick	
4-2-2	Shutdown test failure	
4-2-3	Gate A20 failure	
4-2-4	Unexpected interrupt in protected mode	See " Troubleshooting Expansion Cards " in "Troubleshooting Your System."
4-3-1	Improperly installed or faulty memory modules	See " Troubleshooting System Memory " in "Troubleshooting Your System."
4-3-2	No memory modules installed in the first memory module connector	Install a memory module in the first memory module connector (see " Memory Modules " in "Installing System Options").
4-3-3	Faulty system board	See " Getting Help ."
4-3-4	Time-of-day clock stopped	See " Troubleshooting the System Battery " in "Troubleshooting Your System."
4-4-1	Super I/O chip failure: faulty system board	See " Getting Help ."
4-4-4	Cache test failure: faulty microprocessor	See " Troubleshooting a Microprocessor " in "Troubleshooting Your System."

Warning Messages

A warning message alerts you to a possible problem and asks you to take corrective action before the system continues a task. For example, before you format a diskette, a message may warn you that you may lose all data on the diskette. Warning messages usually interrupt the procedure and require you to respond by typing y (yes) or n (no).

 **NOTE:** Warning messages are generated by either the application program or the operating system. For more information, see "[Finding Software Solutions](#)" and the documentation that accompanied the operating system or application program.

Diagnostics Messages

When you run a test group or subtest in the system diagnostics, an error message may result. Diagnostic error messages are not covered in this section. Record the message on a copy of the Diagnostics Checklist (see "[Getting Help](#)"), and then follow the instructions in that section for obtaining technical assistance.

Alert Messages

Systems management software generates alert messages for your system. For example, the software generates messages that appear in the SNMP trap log file. Alert messages consist of information, status, warning, and failure messages for drive, temperature, fan, and power conditions. For more information, see the systems management software documentation.

[Back to Contents Page](#)

[Back to Contents Page](#)

Finding Software Solutions

Dell™ PowerEdge™ 1600SC Systems Installation and Troubleshooting Guide

- [Before You Begin](#)
 - [Troubleshooting Errors and Conflicts](#)
-

Software problems can be caused by:

- 1 Improper installation or configuration of an application
- 1 Application conflicts
- 1 Input errors
- 1 Interrupt assignment conflicts

Ensure that you are installing the software application according to the software manufacturer's recommended procedures. If a problem occurs after you install the software, you might need to troubleshoot your software application and your system.

See the documentation that accompanied the software or contact the software manufacturer for detailed troubleshooting information.

 **NOTE:** If all of the system diagnostic tests complete successfully, then the problem is most likely caused by the software and not the hardware.

Before You Begin

- 1 Scan the software media with antivirus software.
- 1 Read the software documentation before you run the installation utility.
- 1 Be prepared to respond to prompts from the installation utility.

The installation utility may require you to enter information about your system, such as how the operating system is configured, and the type of peripherals that are connected to the system. Have this information available before running the installation utility.

Troubleshooting Errors and Conflicts

While configuring and running software, problems might occur that are caused by input errors, application conflicts, and/or IRQ assignment conflicts. The problems are sometimes indicated by error messages.

Error messages are generated by system hardware or software. "[Indicators, Codes, and Messages](#)" provides information about error messages that are hardware-based. If you receive an error message that is not listed, see your operating system or software program documentation for troubleshooting information.

Input Errors

Pressing a specific key or set of keys at the wrong time may produce unexpected results. See the documentation that came with the software application to ensure that the values or characters you are entering are valid.

Ensure that your operating system is configured properly to run the application. Remember that whenever you change the parameters of the operating system, the changes can conflict with an application's operating requirements. After you configure the operating system, you may need to reinstall or reconfigure a software application so that it can run properly in its new environment.

Application Conflicts

Some applications can leave unnecessary files or data behind after they are deleted from your system. Device drivers can also create application errors. If application errors occur, see your application device driver or operating system documentation for troubleshooting information.

IRQ Assignment Conflicts

Most PCI devices can share an IRQ with another device, but they cannot use an IRQ simultaneously. To avoid this type of conflict, see the documentation for each PCI device for specific IRQ requirements.

Table 3-1. IRQ Assignment Defaults

IRQ Line	Assignment
IRQ0	System timer
IRQ1	Keyboard controller
IRQ2	Interrupt controller 1 to enable IRQ8 through IRQ15
IRQ3	Serial port 2 (COM2 and COM4)
IRQ4	Serial port 1 (COM1 and COM3)
IRQ5	<i>Available</i>
IRQ6	Diskette drive controller
IRQ7	Parallel port
IRQ8	Real-time clock
IRQ9	ACPI functions (used for power management)
IRQ10	<i>Available</i>
IRQ11	<i>Available</i>
IRQ12	PS/2 mouse port unless the mouse is disabled through the System Setup program
IRQ13	Math coprocessor
IRQ14	<i>Available</i>
IRQ15	<i>Available</i>

NOTE: For the full name of an abbreviation or acronym used in this table, see "[Abbreviations and Acronyms](#)."

[Back to Contents Page](#)

Running the System Diagnostics

Dell™ PowerEdge™ 1600SC Systems Installation and Troubleshooting Guide

- [Running Server Administrator Diagnostics](#)
 - [Features of the System Diagnostics](#)
 - [When to Use the System Diagnostics](#)
 - [Starting the System Diagnostics](#)
 - [Using the System Diagnostics](#)
 - [Using the Device Groups Menu](#)
 - [Error Messages](#)
-

If you experience a problem with your system, run the diagnostics before you call for technical assistance. The diagnostics tests check your system's hardware without additional equipment and without the risk of destroying data. If the tests indicate a problem you cannot solve by yourself, the test results provide important information for service and support personnel.

Running Server Administrator Diagnostics

If you are using Dell OpenManage™ Server Administrator to manage your system, you should first use the diagnostic capabilities of Server Administrator to analyze the problem. If you cannot identify the problem using Server Administrator, then use the system diagnostics.

To access the Server Administrator diagnostics, log into the Server Administrator home page, and then click the **Diagnostics** tab. For information on using the Server Administrator diagnostics, see the Server Administrator online help. For additional information, see the online *Dell OpenManage Server Administrator User's Guide*.

Features of the System Diagnostics

The system diagnostics provides a series of menus and options from which you choose particular device groups or devices. You can also control the sequence in which the tests are run. The diagnostic menus have these helpful features:

- 1 Options that let you run tests individually or collectively
 - 1 An option that allows you to choose the number of times a test is repeated
 - 1 The ability to display or print test results or to save them in a file
 - 1 Options to temporarily suspend testing if an error is detected or to terminate testing when an adjustable error limit is reached
 - 1 Help messages that briefly describe each test and its parameters
 - 1 Status messages that inform you whether device group or device tests are completed successfully
 - 1 Error messages that appear if any problems are detected
-

When to Use the System Diagnostics

Whenever a major component or device in the system does not operate properly, you may have a component failure. As long as the microprocessor and the input and output components of the system (the monitor, keyboard, and diskette drive) are working, you can use the system diagnostics. If you know what component(s) you need to test, select the appropriate diagnostic device group(s) or subtest(s). If you are unsure about the scope of the problem, read the remainder of the information in this section.

Starting the System Diagnostics

 **NOTICE:** Use the system diagnostics to test only your system. Using this program with other systems may cause incorrect results or error messages. Also, use only the program that came with your system or an updated version of the program for your system.

You can run the system diagnostics from either the utility partition on your hard drive or from a set of diskettes that you create from the *Dell OpenManage Server Assistant* CD.

To run the diagnostics from the utility partition, perform the following steps:

1. Start the utility partition by pressing <F10> during POST.
2. From the utility partition's main menu, select the **Run System Diagnostics** option.

See the *Dell OpenManage Server Assistant* CD for additional information about the utility partition.

To run the system diagnostics from the diskettes, perform the following steps:

1. Create a set of diagnostics diskettes.

See the *Dell OpenManage Server Assistant* CD for information on creating diagnostics diskettes.

2. Boot the system from the first diagnostics diskette.

If the system fails to boot, see "[Getting Help](#)."

When you start the system diagnostics, a message is displayed telling you that the diagnostics is loading. The **Diagnostics** menu appears. The menu allows you to run all or specific diagnostic tests or to exit system diagnostics.

 **NOTE:** Before you read the rest of this section, start the system diagnostics so that you can see it on your monitor screen.

For a quick test of the system, select **Test All Devices** and then select **Quick Tests**. This option runs only the device tests that do not require user interaction and that do not take a long time to run. Dell recommends that you choose this option first to increase the chance of tracing the source of the problem quickly. To test a particular device, select **Test One Device**. For a complete test of the system, select **Test All Devices** and then select **Extended Tests**.

To test a particular area of the system, choose **Advanced Testing**. When you select **Advanced Testing**, the main screen of the diagnostics appears. This screen includes a listing of the various device groups in the system and the system's service tag number.

To view data on test results, select **Information and Results**. Select **Program Options** to set various test parameters.

By selecting **Device Configuration**, you can see an overview of the devices in the system.

Selecting **Exit to MS-DOS** exits the diagnostics and returns you to the MS-DOS® operating system environment.

To select an option from the **Diagnostics** menu, highlight the option and press <Enter>, or press the key that corresponds to the highlighted letter in the option you choose.

Using the System Diagnostics

When you select **Advanced Testing** from the **Diagnostics** menu, the main screen of the diagnostics appears.

Information on the main screen of the diagnostics is presented in the following areas:

- 1 Two lines at the top of the main screen identify the diagnostics, the version number, and the system's service tag number.

- 1 On the left side of the screen, **Device Groups** lists the diagnostic device groups in the order they will run if you select **All** under the **Run Tests** submenu. Press the up- or down-arrow key to highlight a device group.
 - 1 On the right side of the screen, **Devices for Highlighted Group** lists the specific devices within a particular test group.
 - 1 Two lines at the bottom of the screen make up the menu area. The first line lists the menu options you can select; press the left- or right-arrow key to highlight an option. The second line gives information about the highlighted option.
-

Using the Device Groups Menu

The **Device Groups** menu at the bottom of the screen provides options that enable you to select and run specific diagnostic tests from the diagnostics main screen. Press the left- and right-arrow keys to select the options on the menu. As you move from one menu option to another, a brief explanation of the highlighted option appears on the bottom line of the screen.

If you want more information about a device group or device, highlight the **Help** option and press <Enter>. After you read the information, press <Esc> to return to the previous screen.

Error Messages

When you run a test in the system diagnostics, you may receive an error message. Record the message on a copy of the Diagnostics Checklist. For a copy of the Diagnostics Checklist and instructions on obtaining technical assistance, see "[Getting Help](#)."

[Back to Contents Page](#)

Troubleshooting Your System

Dell™ PowerEdge™ 1600SC Systems Installation and Troubleshooting Guide

- [Safety First—For You and Your System](#)
- [External Connections](#)
- [Checking Specific System Problems](#)
- [Start-Up Routine](#)
- [System Orientation](#)
- [Bezel](#)
- [System Cover](#)
- [Baffle](#)
- [Checking the Equipment](#)
- [Inside the System](#)
- [Responding to a Systems Management Alert Message](#)
- [Troubleshooting a Wet System](#)
- [Troubleshooting a Damaged System](#)
- [Troubleshooting the System Battery](#)
- [Troubleshooting Redundant Power Supplies](#)
- [Troubleshooting a Nonredundant Power Supply](#)
- [Troubleshooting System Cooling](#)
- [Troubleshooting Expansion Cards](#)
- [Troubleshooting System Memory](#)
- [Troubleshooting the Diskette Drive](#)
- [Troubleshooting a CD Drive](#)
- [Troubleshooting a Tape Drive](#)
- [Troubleshooting Hard Drives](#)
- [Troubleshooting a RAID Controller Card](#)
- [Troubleshooting a Microprocessor](#)
- [Troubleshooting the System Board](#)
- [Resetting Corrupted BIOS Configuration](#)

If your system is not working as expected, begin troubleshooting by using the procedures in this section. This section guides you through some initial tests and procedures that can solve basic system problems and provides troubleshooting procedures for components inside the system. Before you start any of the procedures in this section, perform the following steps:

- ⚠ Read the "Safety Instructions" in your *System Information Guide*.
- 1. Read "[Running the System Diagnostics](#)" for information about running diagnostics.
- 1. Get the key to the system keylock.

Safety First—For You and Your System

The procedures in this guide require that you remove the cover and work inside the system. While working inside the system, do not attempt to service the system except as explained in this guide and elsewhere in your system documentation. Always follow the instructions closely. Review all of the procedures in "Safety Instructions" in your *System Information Guide*.

Observe the following precautions when working inside your system:

- ⚠ **CAUTION:** The power supplies in this system produces high voltages and energy hazards, which can cause bodily harm. Only trained service technicians are authorized to remove the system cover and access any of the components inside the system.
- ⚠ **CAUTION:** See "Protecting Against Electrostatic Discharge" in the safety instructions in your *System Information Guide* before performing any procedure that requires you to remove the cover.

External Connections

Loose or improperly connected cables are the most likely source of problems for the system, monitor, or other peripherals (such as a printer, keyboard, mouse, or other external equipment). A quick check of all the cable connections can easily solve many problems. See [Figure 2-4](#) for the back-panel features and connectors.

Checking Specific System Problems

1. Turn off the system, including any attached peripherals, and disconnect the system from the electrical outlet.
2. If the system is connected to a PDU, turn the PDU off and then on again.

If the PDU is not receiving power, plug it into another electrical outlet. If it still is not receiving power, try another PDU.

3. Reconnect the system to its electrical outlet or PDU and turn the system on, including any attached peripherals.
4. Is the monitor working properly?

See "[Troubleshooting the Video Subsystem.](#)"

5. Is the keyboard working properly?

See "[Troubleshooting the Keyboard.](#)"

6. Is the mouse working properly?

See "[Troubleshooting the Mouse.](#)"

7. Are the other attached peripherals working properly?

See "[Troubleshooting the Basic I/O Functions.](#)"

Start-Up Routine

Looking at and listening to the system is important in determining the source of a problem. Look and listen during the system's start-up routine for the indications described in [Table 5-1](#).

Table 5-1. Start-Up Routine Indications

Look/listen for:	Action
An error message displayed on the monitor.	See " System Messages " in "Indicators, Codes, and Messages."
A series of beeps emitted by the system.	See " System Beep Codes " in "Indicators, Codes, and Messages."
Alert messages from the systems management software.	See the systems management software documentation.
The monitor's power indicator.	See " Troubleshooting the Video Subsystem. "
The keyboard indicators.	See " Troubleshooting the Keyboard. "
The diskette-drive activity indicator.	See " Troubleshooting the Diskette Drive. "
The CD drive activity indicator.	See " Troubleshooting a CD Drive. "
The hard-drive activity indicators.	See " Troubleshooting Hard Drives. "
An unfamiliar constant scraping or grinding sound when you access a drive.	See " Getting Help " for instructions on obtaining technical assistance.
The system will not boot.	See " Resetting Corrupted BIOS Configuration. "
NOTE: For the full name of an abbreviation or acronym used in this table, see " Abbreviations and Acronyms. "	

System Orientation

The illustrations in this document are based on the positioning of the system as shown in [Figure 5-1](#).

Figure 5-1. System Orientation

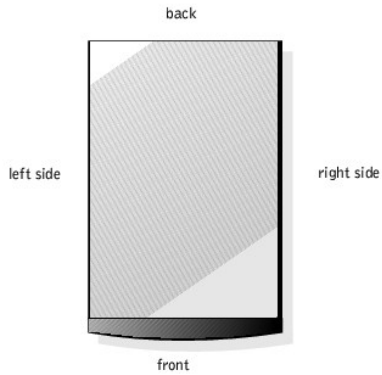

Bezel

The front bezel has status and attention indicators. You must remove the bezel to remove the cover.

Removing the Bezel

⚠ CAUTION: Before you perform this procedure, see "[Safety First—For You and Your System.](#)"

➡ NOTICE: To remove the bezel, the system must be standing upright.

1. Using the system key, unlock the front bezel (see [Figure 5-2](#)).

Figure 5-2. Removing the Bezel

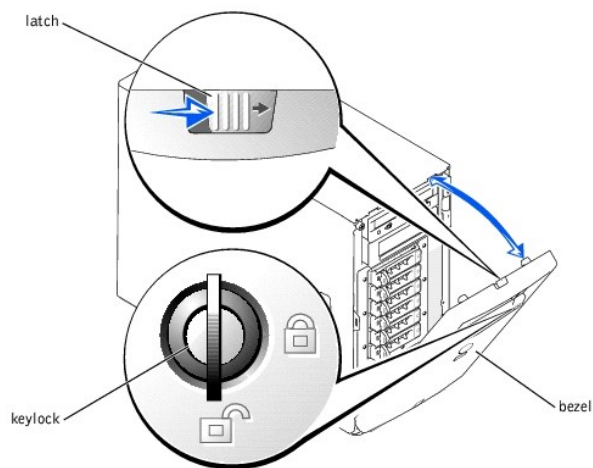

➡ NOTICE: [Figure 5-2](#) shows the system standing upright as the bezel is being removed. However, before you service components inside the system, lay the system on its right side.

2. Slide the latch to the right and pull the upper edge of the bezel away from the front panel (see [Figure 5-2](#)).
3. Pivot the bezel downward until it is at right angles to the front panel.
4. Unsnap the bezel from the metal clips on the front panel.

Installing the Bezel

1. Snap the two tabs on the lower inside edge of the bezel into the corresponding clips on the system front panel, and pivot the bezel upward to its closed position.
 2. Using the system key, lock the bezel.
-

System Cover

To upgrade or troubleshoot the system, remove the cover to gain access to internal components.

Removing the Cover

⚠ CAUTION: Before you perform this procedure, see "[Safety First—For You and Your System.](#)"

1. Remove the bezel (see "[Removing the Bezel](#)").
2. Loosen the three thumbscrews on the left-side cover (see [Figure 5-3](#)).
3. Grasp the cover at both ends and slide it toward the front of the system.
4. Lift the cover away from the system.

Figure 5-3. Removing the Cover

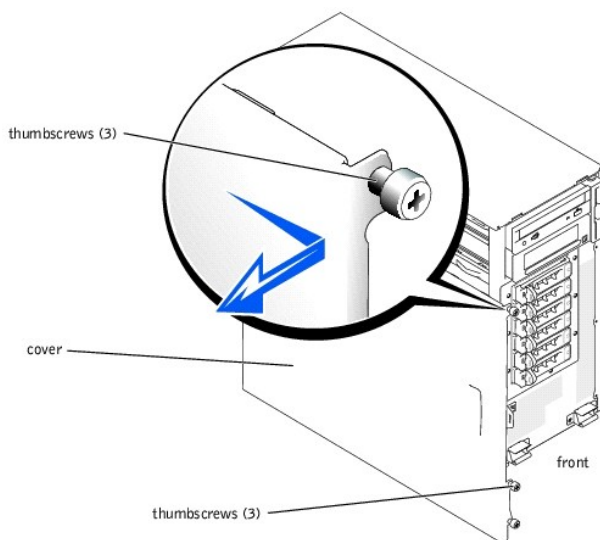

👉 NOTICE: [Figure 5-3](#) shows the system standing upright as the cover is being removed. However, before you service components inside the system, lay the system on its right side.

Installing the Cover

1. Ensure that no tools or loose parts are left inside the system.
 2. Fit the cover on the side of the system, and slide the cover backward.
 3. Tighten the three cover thumbscrews (see [Figure 5-3](#)).
 4. Replace the bezel.
-

Baffle

The vertical plastic baffle in the center of the system improves system cooling by guiding the airflow within the system. You must remove the baffle when performing certain procedures inside the system to improve access to some internal components.

Figure 5-4. Removing the Baffle

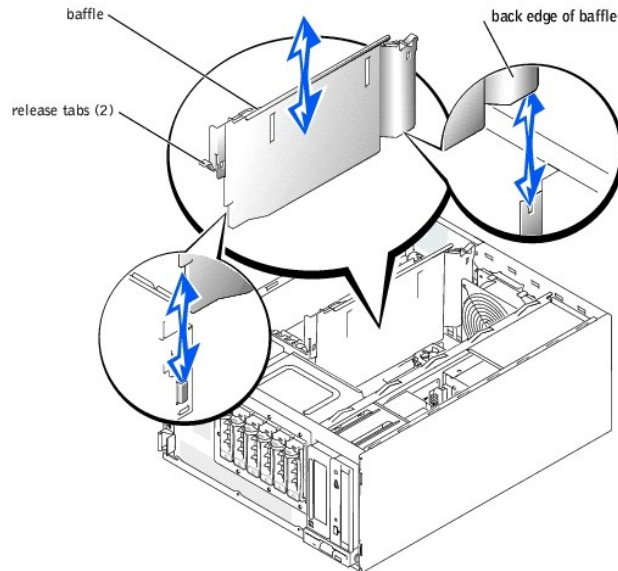

Removing the Baffle

To remove the baffle, lift the release tab at the end of the baffle near the front of the system, depress the release tab at the back end of the baffle, and slide the baffle upward.

🔔 **NOTICE:** You must reinstall the baffle to maintain proper airflow for system cooling.

Installing the Baffle

When you install the baffle, note the proper position of the back edge of the baffle in [Figure 5-4](#). After aligning both ends of the baffle, slide the baffle into the system until the release tabs lock into place.

Checking the Equipment

This section provides troubleshooting procedures for equipment that connects directly to the system, such as the monitor, keyboard, or mouse. Before you perform any of the procedures, see "[External Connections](#)."

Troubleshooting the Video Subsystem

Problem

- 1 Monitor
- 1 Monitor interface cable
- 1 Video memory

- 1 Video logic

Action

1. Check the system and power connections to the monitor.
2. Run the video tests in the system diagnostics (see "[Running the System Diagnostics](#)").

If the tests run successfully, the problem is not related to video hardware. Go to "[Finding Software Solutions](#)."

If the tests fail, see "[Getting Help](#)."

Troubleshooting the Keyboard

Problem

- 1 System message indicates a problem with the keyboard
- 1 Keyboard cable

Action

1. Press each key on the keyboard, and look at the keyboard and its cable for any signs of damage.

If the keyboard appears to be free of physical damage, go to [step 3](#).

If the keyboard is damaged, continue to [step 2](#).

2. Swap the faulty keyboard with a working keyboard.

If the problem is resolved, you must replace the faulty keyboard (see "[Getting Help](#)").

3. Run the keyboard test in the system diagnostics (see "[Running the System Diagnostics](#)").

If the test fails, see "[Getting Help](#)."

4. Swap the faulty keyboard with a working keyboard.

If the problem is resolved, you must replace the faulty keyboard (see "[Getting Help](#)").

If the problem persists, see "[Getting Help](#)."

Troubleshooting the Mouse

Problem

- 1 System message indicates a problem with the mouse
- 1 Mouse cable

Action

1. Click each button on the mouse, and look at the mouse and its cable for any signs of damage.

If the mouse appears to be free of physical damage, go to [step 3](#).

If the mouse is damaged, continue to [step 2](#).

2. Swap the faulty mouse with a working mouse.

If the problem is resolved, you must replace the faulty mouse (see "[Getting Help](#)").

3. Run the pointing devices test in the system diagnostics (see "[Running the System Diagnostics](#)").

If the problem is resolved, you must replace the faulty mouse (see "[Getting Help](#)").

If the test fails, see "[Getting Help](#)."

Troubleshooting the Basic I/O Functions

Problem

1. System message indicates a problem with an I/O port
1. Device connected to the port is not operating properly

Action

1. Enter the System Setup program, and check the serial port and parallel port settings (see "Using the System Setup Program" in your *User's Guide*).

If the ports are enabled, go to [step 3](#).

If the ports are not enabled, continue to [step 2](#).

2. Change the settings to enable the serial port and/or parallel port.
3. Restart the system, and run the serial ports test and/or the parallel ports test in the system diagnostics (see "[Running the System Diagnostics](#)").

If the tests fail, see "[Getting Help](#)."

If the tests run successfully but the problem persists, see one of the following procedures: "[Troubleshooting a Serial I/O Device](#)" or "[Troubleshooting a Parallel Printer](#)."

Troubleshooting a Serial I/O Device

Problem

1. Device connected to the serial port is not operating properly
1. Serial device interface cable

Action

1. Turn off the system and any peripheral devices connected to the serial port.
2. Swap the serial interface cable with a known working cable, and turn on the system and the serial device.

If the problem is resolved, you must replace the interface cable (see "[Getting Help](#)").

3. Turn off the system and the serial device, and swap the device with a comparable device.
4. Turn on the system and the serial device.

If the problem is resolved, you must replace the serial device (see "[Getting Help](#)").

If the problem persists, see "[Getting Help](#)."

Troubleshooting a Parallel Printer

Problem

1. Parallel printer is not operating properly
1. Parallel printer interface cable

Action

1. Turn off the system and the parallel printer.
2. Swap the parallel printer interface cable with a known working cable, and turn on the system and the printer.
3. Attempt a print operation.

If the print operation is successful, you must replace the interface cable (see "[Getting Help](#)").

4. Run the printer's self-test.

If the self-test fails, the printer is malfunctioning (see "[Getting Help](#)").

Troubleshooting a USB Device

Problem

1. System message indicates a problem with a USB device
1. Device connected to a USB port is not operating properly
1. USB device interface cable

Action

1. Enter the System Setup program, and ensure that the USB ports are enabled (see "Using the System Setup Program" in your *User's Guide*).
2. Turn off the system and any USB devices.
3. Disconnect the USB devices, and connect the malfunctioning device to the other USB connector.
4. Turn on the system and the reconnected device.

If the problem is resolved, the USB connector might be defective (see "[Getting Help](#)").

5. If possible, swap the interface cable with a known working cable.

If the problem is resolved, you must replace the interface cable (see "[Getting Help](#)").

6. Turn off the system and the USB device, and swap the device with a comparable device.
7. Turn on the system and the USB device.

If the problem is resolved, you must replace the USB device (see "[Getting Help](#)").

If the problem persists, see "[Getting Help](#)."

Troubleshooting a NIC

Problem

- 1 NIC cannot communicate with network
- 1 NIC cable
- 1 NIC, hub, and switch configuration settings

Action

1. Check the appropriate indicator on the NIC connector (see [Figure 2-7](#)).
 - 1 If the link indicator does not light, check all cable connections.
 - 1 If the activity indicator does not light, the network driver files might be damaged or deleted.

Check the drivers, and remove and reinstall the drivers if applicable. You must reboot your system for the reinstalled drivers to become active.

- 1 Try changing the auto-negotiation setting, if possible.
- 1 Try another connector on the switch or hub.

If you are using a NIC card instead of an integrated NIC, see the documentation for the NIC card.

2. Ensure that the appropriate drivers are installed and the protocols are bound.
3. Enter the System Setup program and confirm that the NIC is enabled (see "Using the System Setup Program" in your User's Guide).
4. Ensure that the NIC, hubs, and switches on the network are all set to the same data transmission speed.
5. Ensure that all network cables are of the proper type and do not exceed the maximum length.

For more information, see "[Network Cable Requirements](#)."

Inside the System

[Figure 5-5](#) shows an interior view of the system.

Figure 5-5. Inside the System

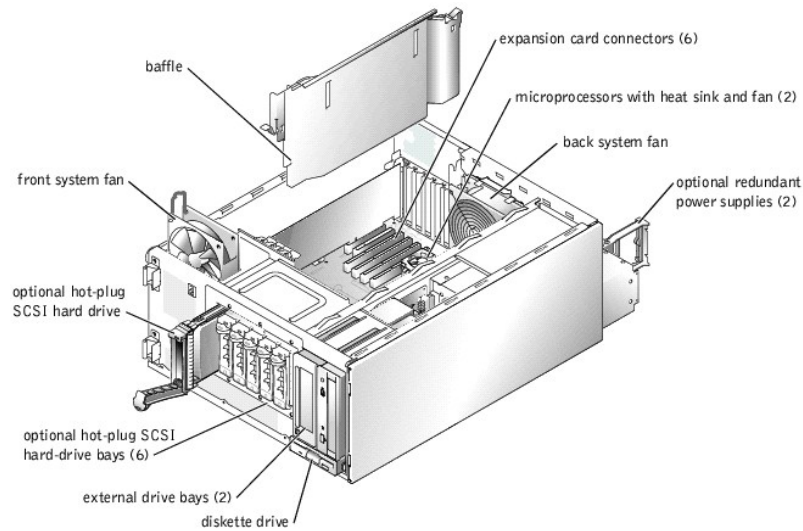

The system board contains the system's control circuitry and other electronic components. Several hardware options, such as the microprocessors and memory, are installed directly on the system board.

The system accommodates up to six expansion cards (two 64-bit/100-MHz PCI-X cards, two 64-bit/66-MHz PCI cards, and two 32-bit/33-MHz PCI cards). System memory is contained in four memory module sockets.

The system supports a 3.5-inch diskette drive and up to two externally accessible 5.25-inch drives, such as CD, DVD, or tape drives. The hard-drive bays support up to four IDE hard drives or four non-hot-plug SCSI hard drives or up to six hot-plug SCSI hard drives. The hard drives connect to a controller on the system board or to a controller card.

During an installation or troubleshooting procedure, you may be required to change a jumper setting. For more information, see "[Jumpers, Switches, and Connectors](#)."

Responding to a Systems Management Alert Message

The optional systems management applications monitor critical system voltages and temperatures, the cooling fans, and the status of hard drives in the system. Alert messages appear in the alert log window. For information about the alert log window and options, see your systems management software documentation.

NOTICE: Dell strongly urges you to install the systems management applications to receive alerts if a hardware problem occurs. For example, if a redundant power supply fails, you receive no notification that the system is operating in a nonredundant power mode unless you have installed the systems management applications.

Troubleshooting a Wet System

Problem

- 1 Liquid spills
- 1 Splashes
- 1 Excessive humidity

Action

 **CAUTION:** Before you perform this procedure, see "[Safety First—For You and Your System](#)."

 **CAUTION:** See "Protecting Against Electrostatic Discharge" in the safety instructions in your *System Information Guide*.

1. Turn off the system, including any attached peripherals, and disconnect the system from the electrical outlet.
2. Remove the cover (see "[Removing the Cover](#)").
3. Lay the system on its right side.
4. Remove all expansion cards installed in the system (see "[Removing an Expansion Card](#)" in "Installing System Options").
5. Let the system dry thoroughly for at least 24 hours.
6. Stand the system upright.
7. Install the cover (see "[Installing the Cover](#)").
8. Reconnect the system to its electrical outlet and turn the system on, including any attached peripherals.

If the system does not start up properly, see "[Getting Help](#)."

9. If the system starts up normally, shut down the system and reinstall all of the expansion cards you removed in [step 4](#) (see "[Installing an Expansion Card](#)" in "Installing System Options").
10. Run the system board tests in the system diagnostics to confirm that the system is working properly (see "[Running the System Diagnostics](#)").

If the tests fail, see "[Getting Help](#)."

Troubleshooting a Damaged System

Problem

- 1 System was dropped or damaged

Action

1. Ensure that the following components are properly installed and connected:
 - 1 Expansion cards
 - 1 Power cables
 - 1 Cooling fans
 - 1 Drives
2. Ensure that all cables are properly connected.
3. Ensure that all components are properly installed and free from damage.
4. Run the system board tests in the system diagnostics (see "[Running the System Diagnostics](#)").

If the tests fail, see "[Getting Help](#)."

Troubleshooting the System Battery

Problem

- 1 System message indicates a problem with the battery
- 1 System Setup program loses system configuration information
- 1 System date and time do not stay current

The system battery maintains system configuration, date, and time information in NVRAM when you turn off the system. The operating life of the battery ranges from 2 to 5 years, depending on how you use the system (for example, if you keep the system on most of the time, the battery gets little use and thus

lasts longer). You may need to replace the battery if an incorrect time or date is displayed during the boot routine.

You can operate the system without a battery; however, the system configuration information maintained by the battery in NVRAM is erased each time you remove power from the system. Therefore, you must re-enter the system configuration information and reset the options each time the system boots until you replace the battery.

Action

1. Re-enter the time and date through the System Setup program (see "Using the System Setup Program" in your *User's Guide*).
2. Turn off the system and disconnect it from the electrical outlet for at least one hour.
3. Reconnect the system to its electrical outlet and turn the system on.
4. Enter the System Setup program.

If the date and time are not correct in the System Setup program, replace the battery (see "[System Battery](#)" in "Installing System Options").

If the problem is not resolved by replacing the battery, see "[Getting Help](#)."

 **NOTE:** Some software may cause the system time to speed up or slow down. If the system seems to operate normally except for the time kept in the System Setup program, the problem may be caused by software rather than by a defective battery.

 **NOTE:** If the system is turned off for long periods of time (for weeks or months), the NVRAM may lose its system configuration information. This situation is caused by a defective battery.

Troubleshooting Redundant Power Supplies

Problem

- 1 Power indicator on the front panel does not light
- 1 Power supply amber fault indicator is on
- 1 Systems management software issues a power supply-related message
- 1 No power to the system

Action

1. Locate the faulty power supply.

The power supply's fault indicator is lit (see [Figure 2-5](#)).

2. Check that a power cable is connected to the power supply and that the green AC line status indicator on the supply is lit (see "[Power Indicator Codes](#)" in "Indicators, Codes, and Messages)."

 **CAUTION:** To prevent risk of personal injury from electrical shock, do not reach into an empty power supply bay.

 **NOTICE:** The optional redundant power supplies are hot-pluggable. The system requires one power supply to be installed for the system to operate normally. The system is in the redundant mode when two power supplies are installed. Remove and replace only one power supply at a time in a system that is powered on.

3. If AC power is available to the system, remove the faulty power supply (see "[Removing a Redundant Power Supply](#)" in "Installing System Options").
4. Install a new power supply (see "[Installing a Redundant Power Supply](#)" in "Installing System Options").

 **NOTE:** After installing a new power supply, allow several seconds for the system to recognize the power supply and determine whether it is working properly. The power supply status indicator will turn green if the power supply is functioning properly (see [Figure 2-5](#)).

5. If the problem is not resolved, see "[Getting Help](#)" for information on obtaining technical assistance.
-

Troubleshooting a Nonredundant Power Supply

Problem

- 1 Power indicator on the front panel does not light
- 1 Systems management software issues a power supply–related message
- 1 No power to the system

Action

 **CAUTION:** Before you perform this procedure, see "[Safety First—For You and Your System](#)."

 **CAUTION:** See "Protecting Against Electrostatic Discharge" in the safety instructions in your *System Information Guide*.

1. Ensure that all power cables are properly connected to the system and any attached peripherals and to the electrical outlet (see "[External Connections](#)").
2. Turn off the system, including any attached peripherals, and disconnect the system from the electrical outlet.
3. Remove the cover (see "[Removing the Cover](#)").
4. Lay the system on its right side.
5. Ensure that the power cables are properly connected to the power connectors on the system board.

To identify system board connectors, see [Figure A-3](#).

6. Stand the system upright.
7. Install the cover (see "[Installing the Cover](#)").
8. Reconnect the system to its electrical outlet and turn the system on, including any attached peripherals.

If the problem persists, see "[Getting Help](#)."

Troubleshooting System Cooling

Problem

- 1 A fan is not operating properly
- 1 System message indicates a problem with cooling
- 1 Systems management software issues a fan-related error message
- 1 Expansion-card filler brackets are not installed over empty expansion slots

Action

 **CAUTION:** Before you perform this procedure, see "[Safety First—For You and Your System](#)."

 **CAUTION:** See "Protecting Against Electrostatic Discharge" in the safety instructions in your *System Information Guide*.

1. Turn off the system, including any attached peripherals, and disconnect the system from the electrical outlet.
2. Remove the cover (see "[Removing the Cover](#)").
3. Lay the system on its right side.
4. Ensure that the fan cables are properly connected to the fan connectors on the system board.

To identify system board connectors, see [Figure A-3](#).

5. Ensure that expansion-card filler brackets are installed over any empty expansion slots (see "[Removing an Expansion Card](#)" in "Installing System

- Options").
6. Stand the system upright.
 7. Install the cover (see "[Installing the Cover](#)").
 8. Reconnect the system to its electrical outlet and turn the system on, including any attached peripherals.

If the problem persists, replace the faulty fan (see "[System Fans](#)" in "Installing System Options").



If the problem is not resolved after a replacement fan is installed, see "[Getting Help](#)."

Troubleshooting Expansion Cards

Problem

1. Expansion card is not operating properly
1. System message indicates a problem with an expansion card
1. Expansion-card filler brackets are not installed over empty expansion slots
1. Expansion-card cable(s)

Action

-  **CAUTION:** Before you perform this procedure, see "[Safety First—For You and Your System](#)."
-  **CAUTION:** See "Protecting Against Electrostatic Discharge" in the safety instructions in your *System Information Guide*.
-  **NOTICE:** When troubleshooting an expansion card, see the documentation for your operating system and the expansion card.
1. Turn off the system, including any attached peripherals, and disconnect the system from the electrical outlet.
 2. Remove the cover (see "[Removing the Cover](#)").
 3. Lay the system on its right side.
 4. Ensure that each expansion card is firmly seated in its connector (see "[Installing an Expansion Card](#)" in "Installing System Options").
 5. Ensure that any appropriate cables are firmly connected to their corresponding connectors on the expansion cards.
 6. Ensure that expansion-card filler brackets are installed over any empty expansion slots (see "[Removing an Expansion Card](#)" in "Installing System Options").
 7. Stand the system upright.
 8. Install the cover (see "[Installing the Cover](#)").
 9. Reconnect the system to its electrical outlet and turn the system on, including any attached peripherals.
 10. Run **Quick Tests** in the system diagnostics (see "[Running the System Diagnostics](#)").

If the problem persists, continue to [step 11](#).

11. Turn off the system, including any attached peripherals, and disconnect the system from its electrical outlet.
12. Remove the cover (see "[Removing the Cover](#)").
13. Remove all expansion cards installed in the system (see "[Removing an Expansion Card](#)" in "Installing System Options").
14. Stand the system upright.
15. Install the cover (see "[Installing the Cover](#)").
16. Reconnect the system to its electrical outlet and turn the system on, including any attached peripherals.
17. Run **Quick Tests** in the system diagnostics (see "[Running the System Diagnostics](#)").

If the tests fail, see "[Getting Help](#)."

18. For each expansion card, perform the following steps:

- a. Turn off the system, including any attached peripherals, and disconnect the system from its electrical outlet.
- b. Remove the cover (see "[Removing the Cover](#)").
- c. Lay the system on its right side.
- d. Reinstall one of the expansion cards you removed in [step 13](#) (see "[Installing an Expansion Card](#)" in "Installing System Options").
- e. Stand the system upright.
- f. Install the cover (see "[Installing the Cover](#)").
- g. Reconnect the system to its electrical outlet and turn the system on, including any attached peripherals.
- h. Run **Quick Tests** in the system diagnostics (see "[Running the System Diagnostics](#)").

If the tests fail, see "[Getting Help](#)."

If you have reinstalled all of the expansion cards and the **Quick Tests** still fail, see "[Getting Help](#)."

Troubleshooting System Memory

Problem

- 1 Faulty memory module
- 1 Faulty system board

Action

 **CAUTION:** Before you perform this procedure, see "[Safety First—For You and Your System](#)."

 **CAUTION:** See "Protecting Against Electrostatic Discharge" in the safety instructions in your *System Information Guide*.

1. Turn on the system, including any attached peripherals.

If no error messages appear, go to [step 17](#).

2. Enter the System Setup program and check the system memory setting (see "Using the System Setup Program" in your *User's Guide*).

If the amount of memory installed matches the system memory setting, go to [step 17](#).

3. Turn off the system, including any attached peripherals, and disconnect the system from the electrical outlet.
4. Remove the cover (see "[Removing the Cover](#)").
5. Lay the system on its right side.
6. Reseat the memory modules in their sockets (see "[Installing Memory Modules](#)" in "Installing System Options").
7. Stand the system upright.
8. Install the cover (see "[Installing the Cover](#)").
9. Reconnect the system to its electrical outlet and turn the system on, including any attached peripherals.
10. Enter the System Setup program and check the system memory setting (see "Using the System Setup Program" in your *User's Guide*).

If the amount of memory installed does not match the system memory setting, then perform the following steps:

- a. Turn off the system, including any attached peripherals, and disconnect the system from its electrical outlet.
- b. Remove the cover (see "[Removing the Cover](#)").
- c. Lay the system on its right side.

 **NOTE:** There are multiple configurations for the memory modules; see "[Memory Module Installation Guidelines](#)" in "Installing System Options." The following steps are an example of one configuration.

11. Swap the memory module in the first memory connector with another of the same capacity (see "[Installing Memory Modules](#)" in "Installing System Options").
12. Stand the system upright.
13. Install the cover (see "[Installing the Cover](#)").
14. Reconnect the system to its electrical outlet and turn the system on, including any attached peripherals.
15. As the system boots, observe the monitor screen and the indicators on the keyboard.
16. Perform the following steps:
 - a. Turn off the system, including any attached peripherals, and disconnect the system from its electrical outlet.
 - b. Remove the cover (see "[Removing the Cover](#)").
 - c. Repeat [step 11](#) through [step 15](#) for each memory module installed.

If the problem persists, see "[Getting Help](#)."

17. Run the system memory test in the system diagnostics (see "[Running the System Diagnostics](#)").

If the test fails, see "[Getting Help](#)."

Troubleshooting the Diskette Drive

Problem

- 1 Faulty diskette
- 1 System message indicates a problem with the diskette drive
- 1 Diskette drive cables

Action

 **CAUTION:** Before you perform this procedure, see "[Safety First—For You and Your System](#)."

 **CAUTION:** See "Protecting Against Electrostatic Discharge" in the safety instructions in your *System Information Guide*.

1. Swap the diskette with a known working diskette.

If the problem is resolved, the diskette is faulty.

2. Enter the System Setup program, and verify that the system is configured correctly (see "Using the System Setup Program" in your *User's Guide*).
3. Run the diskette drive tests in the system diagnostics to determine whether the diskette drive operates properly (see "[Running the System Diagnostics](#)").

If the tests fail, continue to [step 4](#).

4. Turn off the system, including any attached peripherals, and disconnect the system from the electrical outlet.
5. Remove the cover (see "[Removing the Cover](#)").
6. Lay the system on its right side.
7. Ensure that the diskette drive interface cable is properly connected between the drive and the system board.

To identify system board connectors, see [Figure A-3](#).

8. Ensure that a power cable is properly connected to the drive.
9. Stand the system upright.
10. Install the cover (see "[Installing the Cover](#)").
11. Reconnect the system to its electrical outlet and turn the system on, including any attached peripherals.

12. Run the diskette drive tests in the system diagnostics to determine whether the diskette drive operates properly (see "[Running the System Diagnostics](#)").

If the tests fail, continue to [step 13](#).

13. Turn off the system, including any attached peripherals, and disconnect the system from its electrical outlet.
14. Remove the cover (see "[Removing the Cover](#)").
15. Lay the system on its right side.
16. Remove all expansion cards installed in the system (see "[Removing an Expansion Card](#)" in "Installing System Options").
17. Stand the system upright.
18. Install the cover (see "[Installing the Cover](#)").
19. Reconnect the system to its electrical outlet and turn the system on, including any attached peripherals.
20. Run the diskette drive tests in the system diagnostics to determine whether the diskette drive operates properly (see "[Running the System Diagnostics](#)").

If the tests complete successfully, an expansion card may be conflicting with the diskette drive, or you may have a faulty expansion card. Continue to [step 21](#).

If the tests fail, see "[Getting Help](#)".

21. For each expansion card, perform the following steps:
 - a. Turn off the system, including any attached peripherals, and disconnect the system from its electrical outlet.
 - b. Remove the cover (see "[Removing the Cover](#)").
 - c. Lay the system on its right side.
 - d. Reinstall one of the expansion cards you removed in [step 16](#) (see "[Installing an Expansion Card](#)" in "Installing System Options").
 - e. Stand the system upright.
 - f. Install the cover (see "[Installing the Cover](#)").
 - g. Reconnect the system to its electrical outlet and turn the system on, including any attached peripherals.
 - h. Run the diskette drive tests in the system diagnostics to determine whether the diskette drive operates properly (see "[Running the System Diagnostics](#)").

If the tests fail, see "[Getting Help](#)."

If you have reinstalled all of the expansion cards and the tests still fail, see "[Getting Help](#)."

Troubleshooting a CD Drive

Problem

- 1 System cannot read data from the CD
- 1 CD drive cables

Action

 **CAUTION:** Before you perform this procedure, see "[Safety First—For You and Your System](#)."

 **CAUTION:** See "Protecting Against Electrostatic Discharge" in the safety instructions in your *System Information Guide*.

1. Run the IDE devices tests in the system diagnostics to determine whether the CD drive operates properly (see "[Running the System Diagnostics](#)").

If the tests fail, continue to [step 2](#).

2. Turn off the system, including any attached peripherals, and disconnect the system from the electrical outlet.
3. Remove the cover (see "[Removing the Cover](#)").
4. Lay the system on its right side.
5. Ensure that the CD drive interface cable is properly connected between the drive and the system board.

To identify system board connectors, see [Figure A-3](#).

 **NOTE:** Ensure that the drive is configured and connected properly. See "[IDE Configuration Information](#)" in "Installing Drives."

6. Ensure that a power cable is properly connected to the drive.
7. Stand the system upright.
8. Install the cover (see "[Installing the Cover](#)").
9. Reconnect the system to its electrical outlet and turn the system on, including any attached peripherals.
10. Run the IDE devices tests in the system diagnostics to determine whether the CD drive operates properly (see "[Running the System Diagnostics](#)").

If the tests fail, see "[Getting Help](#)."

Troubleshooting a Tape Drive

Troubleshooting an IDE Tape Drive

Problem

- 1 Faulty tape cartridge
- 1 Tape-drive indicator signifies a problem with the drive
- 1 Software error
- 1 Tape-drive cables

Action

 **CAUTION:** Before you perform this procedure, see "[Safety First—For You and Your System](#)."

 **CAUTION:** See "Protecting Against Electrostatic Discharge" in the safety instructions in your *System Information Guide*.

 **NOTE:** If the tape-drive indicator signifies a problem with the drive, see the tape drive's documentation for detailed information on troubleshooting.

1. Swap the tape cartridge with a known working cartridge.

If the problem is resolved, the cartridge is faulty.

2. Run the IDE devices tests in the system diagnostics to determine whether the tape drive operates properly (see "[Running the System Diagnostics](#)").

If the tests fail, continue to [step 3](#).

3. Test the tape drive by performing a tape backup and verification test (see the tape backup software documentation).

If the tests fail, continue to [step 4](#).

4. Reinstall the tape backup software as instructed in the tape backup software documentation.
5. Turn off the system, including any attached peripherals, and disconnect the system from the electrical outlet.
6. Remove the cover (see "[Removing the Cover](#)").

7. Lay the system on its right side.
8. Ensure that the tape drive interface cable is properly connected between the drive and the system board.

To identify system board connectors, see [Figure A-3](#).

9. Ensure that a power cable is properly connected to the drive.
10. Stand the system upright.
11. Install the cover (see "[Installing the Cover](#)").
12. Reconnect the system to its electrical outlet and turn the system on, including any attached peripherals.
13. Run the IDE devices tests in the system diagnostics to determine whether the tape drive operates properly (see "[Running the System Diagnostics](#)").

If the tests fail, see "[Getting Help](#)."

Troubleshooting a SCSI Tape Drive

Problem

1. Faulty tape cartridge
1. Tape-drive indicator signifies a problem with the drive
1. Software or device driver error
1. Tape drive cables

Action

 **CAUTION:** Before you perform this procedure, see "[Safety First—For You and Your System](#)."

 **CAUTION:** See "Protecting Against Electrostatic Discharge" in the safety instructions in your *System Information Guide*.

 **NOTE:** If the tape-drive indicator signifies a problem with the drive, see the tape drive's documentation for detailed information on troubleshooting.

1. Swap the tape cartridge with a known working cartridge.

If the problem is resolved, the cartridge is faulty.

2. Run the SCSI controllers test in the system diagnostics to determine whether the controller operates properly (see "[Running the System Diagnostics](#)").

If the tests fail, continue to [step 3](#).

3. Ensure that any required device drivers are installed and are configured correctly.

For information on installing device drivers, see the *Dell OpenManage Server Assistant* CD and the documentation that accompanied the controller card.

4. Test the tape drive by performing a tape backup and verification test (see the tape backup software documentation).

If the tests fail, continue to [step 5](#).

5. Reinstall the tape backup software as instructed in the tape backup software documentation.
6. Turn off the system, including any attached peripherals, and disconnect the system from the electrical outlet.
7. Remove the cover (see "[Removing the Cover](#)").
8. Lay the system on its right side.
9. Ensure that the tape drive interface cable is properly connected between the drive and the controller card (see the documentation that accompanied the controller card).
10. Ensure that a power cable is properly connected to the drive.
11. Ensure that the tape drive is configured with a unique SCSI ID number and that the drive is terminated or not terminated as appropriate.

See the documentation for the tape drive for instructions on configuring the SCSI ID and enabling or disabling termination.

12. Stand the system upright.
 13. Install the cover (see "[Installing the Cover](#)").
 14. Reconnect the system to its electrical outlet and turn the system on, including any attached peripherals.
 15. Test the tape drive by performing a tape backup and verification test (see the tape backup software documentation).
 16. If the problem persists, see "[Getting Help](#)."
-

Troubleshooting Hard Drives

Troubleshooting an IDE Hard Drive

Problem

1. Faulty hard drive
1. Hard-drive cables

Action

 **CAUTION:** Before you perform this procedure, see "[Safety First—For You and Your System](#)."

 **CAUTION:** See "Protecting Against Electrostatic Discharge" in the safety instructions in your *System Information Guide*.

 **NOTICE:** This troubleshooting procedure can destroy data stored on the hard drive. Before you proceed, back up all the files on the hard drive.

 **NOTE:** If the hard drive is used in a RAID configuration, see "[Troubleshooting an IDE Hard Drive in a RAID Configuration](#)."

1. Enter the System Setup program, and verify that the system is configured correctly (see "Using the System Setup Program" in your *User's Guide*).
2. Run the hard drive and IDE devices tests in the system diagnostics to determine whether the hard drive operates properly (see "[Running the System Diagnostics](#)").

If the tests fail, continue to [step 3](#).

3. Turn off the system, including any attached peripherals, and disconnect the system from the electrical outlet.
4. Remove the cover (see "[Removing the Cover](#)").
5. Lay the system on its right side.
6. Ensure that the hard drive interface cable is properly connected between the drive and the system board.

To identify system board connectors, see [Figure A-3](#).

 **NOTE:** Ensure that the drive is configured and connected properly. See "[IDE Configuration Information](#)" in "Installing Drives."

7. If the hard drive is the boot drive, ensure that the drive is configured and connected properly (see "[Configuring the Boot Drive](#)" in "Installing Drives").
8. Ensure that a power cable is properly connected to the drive.
9. Stand the system upright.
10. Install the cover (see "[Installing the Cover](#)").
11. Reconnect the system to its electrical outlet and turn the system on, including any attached peripherals.
12. Partition and logically format the hard drive (see the operating system documentation).
13. If possible, restore the files to the drive.

If the problem persists, see "[Getting Help](#)."

Troubleshooting an IDE Hard Drive in a RAID Configuration

Problem

- 1 Device driver error
- 1 Hard-drive cables
- 1 Device drivers

Action

 **CAUTION:** Before you perform this procedure, see "[Safety First—For You and Your System](#)."

 **CAUTION:** See "Protecting Against Electrostatic Discharge" in the safety instructions in your *System Information Guide*.

 **NOTICE:** This troubleshooting procedure can destroy data stored on the hard drive. Before you proceed, back up all the files on the hard drive.

1. Run the hard drive tests in the system diagnostics (see "[Running the System Diagnostics](#)").

For information on testing the controller, see the RAID controller's documentation.

If the tests fail, continue to [step 2](#).

2. Restart your system and enter the RAID configuration utility.

For information on the configuration utility, see the documentation supplied with the RAID controller card.

3. Ensure that any required device drivers are installed and are configured correctly.

For information on installing device drivers, see the *Dell OpenManage Server Assistant* CD and the documentation that accompanied the controller card.

4. Turn off the system, including any attached peripherals, and disconnect the system from the electrical outlet.
5. Remove the cover (see "[Removing the Cover](#)").
6. Lay the system on its right side.
7. Ensure that the hard drive interface cable is properly connected between the drive and the controller card (see the documentation that accompanied the controller card).
8. If the hard drive is the boot drive, ensure that the drive is configured and connected properly (see "[Configuring the Boot Drive](#)" in "Installing Drives").
9. Ensure that a power cable is properly connected to the drive.
10. Stand the system upright.
11. Install the cover (see "[Installing the Cover](#)").
12. Reconnect the system to its electrical outlet and turn the system on, including any attached peripherals.

If the problem persists, continue to [step 13](#).

13. Partition and logically format the hard drive (see the operating system documentation).
14. If possible, restore the files to the drive.

If the problem persists, see "[Getting Help](#)."

Troubleshooting a SCSI Hard Drive (System With SCSI Backplane)

Problem

- 1 Device driver error
- 1 Hard-drive cables
- 1 SCSI backplane board
- 1 Device drivers

Action

 **CAUTION:** Before you perform this procedure, see "[Safety First—For You and Your System](#)."

 **CAUTION:** See "Protecting Against Electrostatic Discharge" in the safety instructions in your *System Information Guide*.

 **NOTICE:** This troubleshooting procedure can destroy data stored on the hard drive. Before you proceed, back up all the files on the hard drive.

1. If the integrated SCSI host adapter is being used to control the SCSI hard drives, reboot the system and press <Ctrl><a> to enter the SCSI configuration utility program.

 **NOTE:** If your system has an optional RAID controller card installed, reboot the system and press <Ctrl><h>, <Ctrl><a>, or <Ctrl><m>, depending on the utility. See the documentation supplied with the controller for information on the configuration utility.

2. Check that the primary SCSI channel is enabled, and reboot the system.
3. Verify that the device drivers are installed and configured correctly (see the operating system's documentation).
4. Remove the hard drive and install it in the another drive bay.
5. If the problem is resolved, reinstall the hard drive in the original bay.

If the hard drive functions properly in the original bay, the drive carrier could have intermittent problems. Replace the drive carrier (see "Installing SCSI Hard Drives" in "Installing Drives").

If the drive carrier still does not function properly in the original bay, the SCSI backplane board has a defective connector (see "[Technical Assistance](#)" for instructions).

6. Check the SCSI cable connections inside the system:
 - a. Turn off the system, including any attached peripherals, and disconnect the system from its electrical outlet.
 - b. Remove the system cover (see "[System Cover](#)").
 - c. Check the SCSI cable connection to the SCSI host adapter.

The SCSI cable may be connected to the SCSI host adapter on the system board or a SCSI host adapter card installed in an expansion slot.

7. Partition and logically format the hard drive. If possible, restore the files to the drive.

To partition and logically format the drive, see the operating system documentation.

If the problem is not resolved, see "Getting Help" for instructions on obtaining technical assistance.

Troubleshooting a SCSI Hard Drive (System Without SCSI Backplane)

Problem

- 1 Hard-drive cables
- 1 Device drivers

Action

 **CAUTION:** Before you perform this procedure, see "[Safety First—For You and Your System](#)."

 **CAUTION:** See "Protecting Against Electrostatic Discharge" in the safety instructions in your *System Information Guide*.

 **NOTICE:** This troubleshooting procedure can destroy data stored on the hard drive. Before you proceed, back up all the files on the hard drive.

1. Run the SCSI controllers test and the hard drive tests in the system diagnostics (see "[Running the System Diagnostics](#)").

For information on testing the controller, see the SCSI or RAID controller's documentation.

If the tests fail, continue to step 2.

2. Reboot the system and enter the SCSI configuration utility.

To enter the utility, press <Ctrl><h>, <Ctrl><a>, or <Ctrl><m>, depending on the utility. See the documentation supplied with the controller for information on the configuration utility.

3. Ensure that the primary SCSI channel is enabled, and restart the system (see the documentation for your SCSI controller).
4. Ensure that any required device drivers are installed and are configured correctly.

For information on installing device drivers, see the *Dell OpenManage Server Assistant CD* and the documentation that accompanied the controller card.

5. Turn off the system, including any attached peripherals, and disconnect the system from the electrical outlet.
6. Remove the cover (see "[Removing the Cover](#)").
7. Lay the system on its right side.
8. Ensure that the hard-drive interface cable is properly connected between the drive and the system board or controller card (see the documentation that accompanied the controller card).
9. If the hard drive is the boot drive, ensure that the drive is configured and connected properly (see "[Configuring the Boot Drive](#)" in "Installing Drives.")
10. Ensure that a power cable is properly connected to the drive.
11. Ensure that the hard drive is configured with a unique SCSI ID number and that the drive is terminated or not terminated as appropriate.

See the documentation for the hard drive for instructions on configuring the SCSI ID and enabling or disabling termination.

12. Stand the system upright.
13. Install the cover (see "[Installing the Cover](#)").
14. Reconnect the system to its electrical outlet and turn the system on, including any attached peripherals.

If the problem persists, continue to [step 15](#).

15. Partition and logically format the hard drive (see the operating system documentation).
16. If possible, restore the files to the drive.

If the problem persists, see "[Getting Help](#)."

Troubleshooting a RAID Controller Card

Your system may contain an optional RAID controller card. If you encounter problems with a RAID controller, see the RAID controller's documentation for detailed information on troubleshooting.

Troubleshooting a Microprocessor

 **NOTE:** Microprocessors with an internal speed of less than 3.06 GHz use an active cooling heat sink. Microprocessors with internal speeds greater than or equal to 3.06 GHz use a passive heat sink and plastic shroud.

Problem

- 1 System message indicates a problem with the microprocessor
- 1 Heat sink is not installed for the microprocessor
- 1 Fan is not operating properly

Action

 **CAUTION:** Before you perform this procedure, see "[Safety First—For You and Your System](#)."

 **CAUTION:** See "Protecting Against Electrostatic Discharge" in the safety instructions in your *System Information Guide*.

1. Turn off the system, including any attached peripherals, and disconnect the system from the electrical outlet.
2. Remove the cover (see "[Removing the Cover](#)").
3. Lay the system on its right side.
4. Ensure that the microprocessor and heat sink with cooling fan are properly installed (see "[Removing and Installing a Microprocessor](#)" in "Installing System Options").
5. Stand the system upright.
6. Install the cover (see "[Installing the Cover](#)").
7. Reconnect the system to its electrical outlet and turn the system on, including any attached peripherals.
8. Run **Quick Tests** in the system diagnostics (see "[Running the System Diagnostics](#)").

If the tests fail or the problem persists, see "[Getting Help](#)."

Troubleshooting the System Board

Problem

- 1 System message indicates a problem with the system board

Action

 **CAUTION:** Before you perform this procedure, see "[Safety First—For You and Your System](#)."

 **CAUTION:** See "Protecting Against Electrostatic Discharge" in the safety instructions in your *System Information Guide*.

1. Turn off the system, including any attached peripherals, and disconnect the system from the electrical outlet.
2. Remove the cover (see "[Removing the Cover](#)").
3. Lay the system on its right side.
4. Remove all expansion cards installed in the system (see "[Removing an Expansion Card](#)" in "Installing System Options").

 **NOTE:** If the boot drive is connected to a SCSI or RAID controller card, remove all expansion cards except the controller card used by the boot drive.

5. Stand the system upright.
6. Install the cover (see "[Installing the Cover](#)").
7. Reconnect the system to its electrical outlet and turn the system on, including any attached peripherals.
8. Run **Quick Tests** in the system diagnostics (see "[Running the System Diagnostics](#)").

If the tests fail, see "[Getting Help](#)."

9. For each expansion card, perform the following steps:
 - a. Turn off the system, including any attached peripherals, and disconnect the system from its electrical outlet.
 - b. Remove the cover (see "[Removing the Cover](#)").
 - c. Lay the system on its right side.
 - d. Reinstall one of the expansion cards you removed in [step 4](#) (see "[Installing an Expansion Card](#)" in "Installing System Options").
 - e. Stand the system upright.
 - f. Install the cover (see "[Installing the Cover](#)").
 - g. Reconnect the system to its electrical outlet and turn the system on, including any attached peripherals.
 - h. Run **Quick Tests** in the system diagnostics (see "[Running the System Diagnostics](#)").

If the tests fail, see "[Getting Help](#)."

If you have reinstalled all of the expansion cards and the **Quick Tests** still fail, see "[Getting Help](#)."

Resetting Corrupted BIOS Configuration

If your system cannot boot and you have exhausted *all* other troubleshooting options, perform the following steps.

 **CAUTION:** Before you perform this procedure, see "[Safety First—For You and Your System](#)."

 **CAUTION:** See "Protecting Against Electrostatic Discharge" in the safety instructions in your *System Information Guide*.

 **NOTICE:** After you reset the configuration settings using the NVRAM-clear jumper, you must enter the System Setup program and restore any option settings that were not in your default configuration. For more information, see "Using the System Setup Program" in your *User's Guide*.

1. Turn off the system, including any attached peripherals, and disconnect the system from the electrical outlet.
2. Remove the cover (see "[Removing the Cover](#)").
3. Lay the system on its right side.
4. Install the NVRAM-clear jumper.

See [Figure A-2](#) to locate the jumper on the system board.

If you do not have a spare jumper, see "[Getting Help](#)."

 **NOTE:** The configuration settings will be cleared during the next system startup.

5. Stand the system upright.
6. Install the cover (see "[Installing the Cover](#)").
7. Reconnect the system to its electrical outlet and turn the system on, including any attached peripherals.

 **NOTE:** The configuration settings have been cleared.

8. Turn off the system, including any attached peripherals, and disconnect the system from the electrical outlet.
9. Remove the cover (see "[Removing the Cover](#)").
10. Lay the system on its right side.
11. Remove the NVRAM-clear jumper.

See [Figure A-2](#) to locate the jumper on the system board.

12. Stand the system upright.
13. Install the cover (see "[Installing the Cover](#)").

14. Reconnect the system to its electrical outlet and turn the system on, including any attached peripherals.
15. Enter the System Setup program, and change the configuration settings appropriate for your system (see "Using the System Setup Program" in your *User's Guide*).
16. Reboot the system.

If the problem persists, see "[Getting Help](#)."

17. Enter the System Setup program and restore any option settings that were not in your default configuration. For more information, see "Using the System Setup Program" in your *User's Guide*.
-

[Back to Contents Page](#)

Installing System Options

Dell™ PowerEdge™ 1600SC Systems Installation and Troubleshooting Guide

- [System Fans](#)
 - [Redundant Power Supplies](#)
 - [Expansion Cards](#)
 - [Memory Modules](#)
 - [Microprocessors](#)
 - [System Battery](#)
-

This section describes how to remove and install the following components:

- 1 System fans
- 1 Optional redundant power supplies
- 1 Expansion cards
- 1 Memory modules
- 1 Microprocessors
- 1 System battery

For information on installing a hard drive or other drives, see "[Installing Drives](#)."

System Fans

Your system includes the following system cooling fans:

- 1 Front system fan
- 1 Back system fan

Removing the Front System Fan

 **CAUTION:** Before you perform this procedure, see "[Safety First—For You and Your System](#)" in "Troubleshooting Your System."

 **CAUTION:** See "Protecting Against Electrostatic Discharge" in the safety instructions in your *System Information Guide*.

1. Turn off the system, including any attached peripherals, and disconnect the system from the electrical outlet.
2. Remove the bezel (see "[Removing the Bezel](#)" in "Troubleshooting Your System").
3. Remove the cover (see "[Removing the Cover](#)" in "Troubleshooting Your System").
4. Lay the system on its right side.
5. Disconnect the fan power cable from the fan power connector on the chassis (see [Figure 6-1](#)).
6. Remove the fan power cable from the plastic retention clip.
7. Open the fan door (see [Figure 6-1](#)).
8. Pull the wire handle on the fan upward and slide the fan out of the system (see [Figure 6-1](#)).

Figure 6-1. Removing the Front and Back System Fans

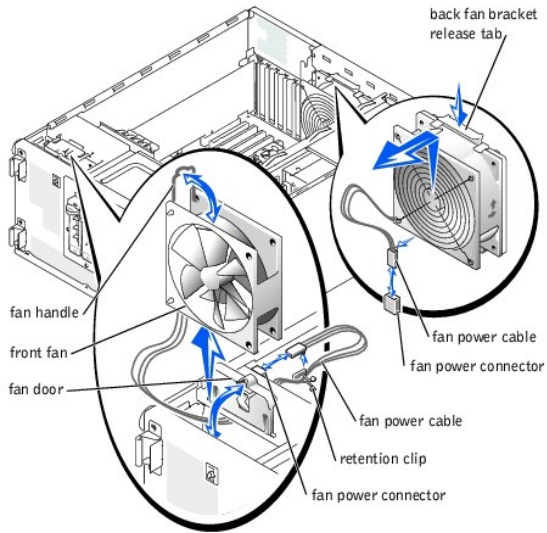

Installing the Front System Fan

⚠ CAUTION: Before you perform this procedure, see "[Safety First—For You and Your System](#)" in "Troubleshooting Your System."

⚠ CAUTION: See "Protecting Against Electrostatic Discharge" in the safety instructions in your *System Information Guide*.

1. Insert the fan power cable into the fan bay and connect the fan power cable to the fan power connector on the chassis (see [Figure 6-1](#)).
2. Slide the fan into the system chassis (see [Figure 6-1](#)), being careful not to trap the power cable between the fan and chassis.
3. Secure the fan power cable with the plastic retention clip (see [Figure 6-1](#)).
4. Close the fan handle.
5. Close the fan door.
6. Stand the system upright.
7. Install the cover (see "[Installing the Cover](#)" in "Troubleshooting Your System").
8. Install the bezel (see "[Installing the Bezel](#)" in "Troubleshooting Your System").
9. Reconnect the system to its electrical outlet and turn the system on, including any attached peripherals.

Removing the Back System Fan

⚠ CAUTION: Before you perform this procedure, see "[Safety First—For You and Your System](#)" in "Troubleshooting Your System."

⚠ CAUTION: See "Protecting Against Electrostatic Discharge" in the safety instructions in your *System Information Guide*.

1. Turn off the system, including any attached peripherals, and disconnect the system from the electrical outlet.
2. Remove the cover (see "[Removing the Cover](#)" in "Troubleshooting Your System").
3. Lay the system on its right side.
4. Disconnect the fan power cable from the fan power connector on the system board.

To identify system board connectors, see [Figure A-3](#).

5. Pull the fan bracket release tab away from the back panel and slide the fan assembly upward about 1 cm (0.5 inch) (see [Figure 6-1](#)).
6. Lift the fan assembly away from the back panel and out of the system.

Installing the Back System Fan

 **CAUTION:** Before you perform this procedure, see "[Safety First—For You and Your System](#)" in "Troubleshooting Your System."

 **CAUTION:** See "Protecting Against Electrostatic Discharge" in the safety instructions in your *System Information Guide*.

1. Insert the four tabs on the fan bracket into the mounting holes in the back panel and slide the fan assembly downward about 1 cm (0.5 inch) until the fan bracket release tab snaps into place.
2. Connect the fan power cable to the fan power connector on the system board.

To identify system board connectors, see [Figure A-3](#).

3. Stand the system upright.
 4. Install the cover (see "[Installing the Cover](#)" in "Troubleshooting Your System").
 5. Reconnect the system to its electrical outlet and turn the system on, including any attached peripherals.
-

Redundant Power Supplies

The optional redundant power supplies are accessible from the back panel.

Removing a Redundant Power Supply

 **CAUTION:** To prevent risk of personal injury from electrical shock, do not reach into an empty power supply bay.

 **NOTICE:** The power supplies are hot-pluggable. The system requires one power supply to be installed for the system to operate normally. The system is in the redundant mode when two power supplies are installed. Remove and replace only one power supply at a time in a system that is powered on.

1. Disconnect the power cord from the power supply.
2. Using your thumb and index finger, squeeze the catch in the middle of the power supply handle (see [Figure 6-2](#)).
3. Rotate the handle downward to release the power supply.
4. Slide the power supply out of the chassis.

Installing a Redundant Power Supply

1. Slide the power supply into the chassis.
2. When the power supply is fully inserted, rotate the power supply handle upward to lock the power supply in place.

The power supply will not function until the handle is fully closed.

3. Plug the power cable into the power supply, making sure that the cable passes through the power cable strain relief loop.

 **NOTE:** After installing a new power supply, allow several seconds for the system to recognize the power supply and determine whether it is working properly. The power-on indicator turns green to signify that the power supply is functioning properly (see [Figure 2-3](#)).

Figure 6-2. Removing and Installing an Optional Redundant Power Supply



Expansion Cards

The system includes six expansion slots, configured as follows:

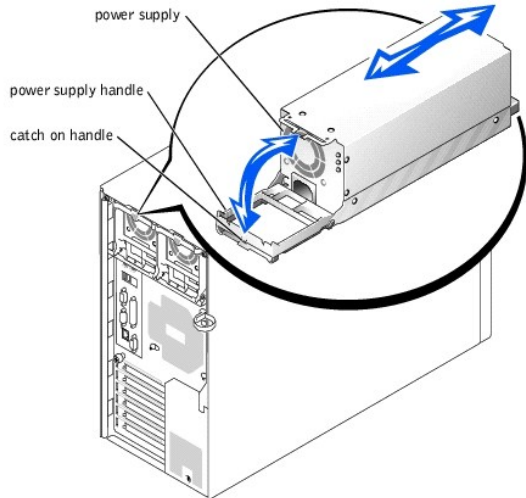
- 1 Slots 1 and 2 are 64-bit, 66-MHz PCI slots (3.3 V).
- 1 Slots 3 and 4 are 64-bit, 100-MHz PCI-X slots (3.3 V).
- 1 Slots 5 and 6 are 32-bit, 33-MHz PCI slots (5 V).

All expansion slots accommodate full-length cards, except for slot 1.

To identify expansion slots and operating speeds, see [Figure A-3](#).

Installing an Expansion Card

⚠ CAUTION: Before you perform this procedure, see "[Safety First—For You and Your System](#)" in "Troubleshooting Your System."

⚠ CAUTION: See "Protecting Against Electrostatic Discharge" in the safety instructions in your *System Information Guide*.

🔧 NOTE: If you install a RAID controller card, install the card in expansion slot 1 or 2. (See [Figure A-3](#) to locate these expansion slots.)

1. Unpack the expansion card, and prepare it for installation.

For instructions, see the documentation that accompanied the card.

2. Turn off the system, including any attached peripherals, and disconnect the system from the electrical outlet.
3. Remove the cover (see "[Removing the Cover](#)" in "Troubleshooting Your System").
4. Lay the system on its right side.
5. Remove the filler bracket from the expansion slot.
6. Install the expansion card (see [Figure 6-3](#)):
 - a. Position the expansion card so that the card-edge connector aligns with the expansion-card connector on the system board.
 - b. Insert the card-edge connector firmly into the expansion-card connector until the card is fully seated.
 - c. Install the screw that secures the expansion-card bracket to the back panel.
 - d. If the card is a full-length card, close the card-guide latch.

7. Connect any cables that should be attached to the card.

See the documentation that accompanied the card for information about its cable connections.

8. Stand the system upright.
9. Install the cover (see "[Installing the Cover](#)" in "Troubleshooting Your System").
10. Reconnect the system to its electrical outlet and turn the system on, including any attached peripherals.

Figure 6-3. Removing and Installing an Expansion Card

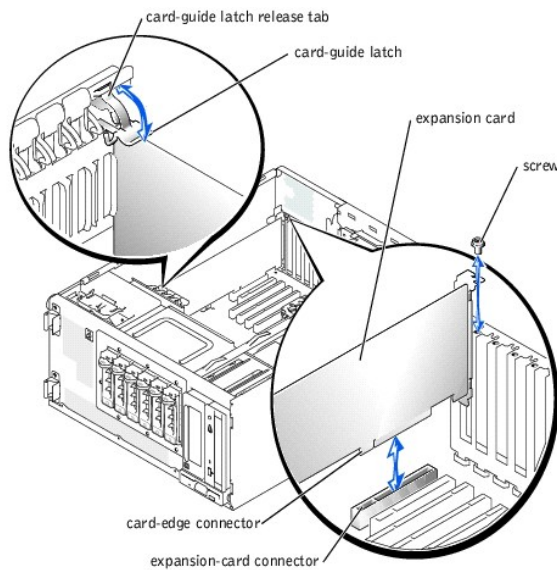

Removing an Expansion Card

CAUTION: Before you perform this procedure, see "[Safety First—For You and Your System](#)" in "Troubleshooting Your System."

CAUTION: See "Protecting Against Electrostatic Discharge" in the safety instructions in your *System Information Guide*.

1. Turn off the system, including any attached peripherals, and disconnect the system from the electrical outlet.
2. Remove the cover (see "[Removing the Cover](#)" in "Troubleshooting Your System").
3. Lay the system on its right side.
4. Disconnect any cables attached to the card.
5. Remove the expansion card (see [Figure 6-3](#)):
 - a. If the card is a full-length card, press the release tab on the card-guide latch and open the latch.
 - b. Remove the screw that secures the expansion-card bracket to the back panel.
 - c. Grasp the expansion card by its top corners, and carefully remove it from the expansion-card connector.
6. If you are removing the card permanently, install a metal filler bracket over the empty expansion slot opening and close the expansion-card latch.

NOTICE: You must install a filler bracket over an empty expansion slot to maintain Federal Communications Commission (FCC) certification of the system. The brackets also help keep dust and dirt out of the system and aid in proper cooling and airflow inside the system.

7. Stand the system upright.
8. Install the cover (see "[Installing the Cover](#)" in "Troubleshooting Your System").
9. Reconnect the system to its electrical outlet and turn the system on, including any attached peripherals.

Memory Modules

The four memory module connectors on the system board can accommodate from 128 MB to 4 GB of registered memory modules.

Memory Upgrade Kits

System memory is upgradable to 4 GB by installing combinations of 128-, 256-, 512-MB, and 1-GB registered DDR SDRAM modules. You can purchase memory upgrade kits as needed.

 **NOTICE:** The DDR SDRAM memory modules must be PC-266 compliant.

Memory Module Installation Guidelines

Starting with the connector nearest the side of the system board, the memory module sockets are labeled "DIMMA" through "DIMMD" (see [Figure A-3](#)). When you install memory modules, install the first module in connector DIMMA before installing additional modules in connectors DIMMB, DIMMC, and DIMMD.

[Table 6-1](#) lists sample memory configurations based on these guidelines.

Table 6-1. Sample Memory Module Configurations

Total Memory	DIMMA	DIMMB	DIMMC	DIMMD
128 MB	128 MB	None	None	None
512 MB	256 MB	256 MB	None	None
512 MB	512 MB	None	None	None
1 GB	512 MB	512 MB	None	None
1.5 GB	1 GB	512 MB	None	None
2 GB	512 MB	512 MB	512 MB	512 MB
3 GB	1 GB	1 GB	1 GB	None
3 GB	1 GB	1 GB	512 MB	512 MB
4 GB	1 GB	1 GB	1 GB	1 GB

NOTE: This table only lists sample memory module configurations. Not all possible configurations are listed.

Performing a Memory Upgrade

 **CAUTION:** Before you perform this procedure, see "[Safety First—For You and Your System](#)" in "Troubleshooting Your System."

 **CAUTION:** See "Protecting Against Electrostatic Discharge" in the safety instructions in your *System Information Guide*.

1. Turn off the system, including any attached peripherals, and disconnect the system from the electrical outlet.
2. Remove the cover (see "[Removing the Cover](#)" in "Troubleshooting Your System").
3. Lay the system on its right side.
4. Install or remove memory modules as necessary to reach the desired memory total (see "[Installing Memory Modules](#)" and "[Removing Memory Modules](#)").

See [Figure A-3](#) to locate the memory module connectors.

5. Stand the system upright.
6. Install the cover (see "[Installing the Cover](#)" in "Troubleshooting Your System").
7. Reconnect the system to its electrical outlet and turn the system on, including any attached peripherals.

After the system completes the POST routine, it runs a memory test.

The system detects that the new memory does not match the system configuration information, which is stored in NVRAM. The monitor displays an error message that ends with the following words:

Press <F1> to continue; <F2> to enter System Setup

8. Press <F2> to enter the System Setup program, and check the **System Memory** setting.

The system should have already changed the value in the **System Memory** setting to reflect the newly installed memory.

9. If the **System Memory** value is incorrect, one or more of the memory modules may not be installed properly. Repeat [step 1](#) through [step 8](#), ensuring that the memory modules are firmly seated in their connectors.
10. Run the system memory test in the system diagnostics.

Installing Memory Modules

CAUTION: Before you perform this procedure, see "[Safety First—For You and Your System](#)" in "Troubleshooting Your System."

CAUTION: See "Protecting Against Electrostatic Discharge" in the safety instructions in your *System Information Guide*.

1. Turn off the system, including any attached peripherals, and disconnect the system from the electrical outlet.
2. Remove the cover (see "[Removing the Cover](#)" in "Troubleshooting Your System").
3. Lay the system on its right side.
4. Locate the memory module connectors in which you will install a memory module (see [Figure A-3](#)).
5. Press down and outward on the memory module connector ejectors, as shown in [Figure 6-4](#), to allow the memory module to be inserted into the connector.

Figure 6-4. Removing and Installing a Memory Module

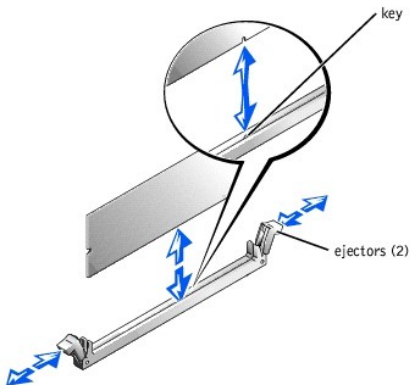

6. Align the notch in the memory module's edge connector with the alignment key in the socket, and insert the memory module in the connector (see [Figure 6-4](#)).

The memory module connector has an alignment key that allows the memory module to be installed in the connector in only one way.

7. Press down on the memory module with your thumbs while pulling up on the ejectors with your index fingers to lock the memory module into the connector (see [Figure 6-4](#)).

When the memory module is properly seated in the connector, the memory module connector ejectors should align with the ejectors on the other connectors with memory modules installed.

8. Repeat [step 4](#) through [step 7](#) to install the remaining memory modules.
9. Perform [step 5](#) through [step 10](#) of "[Performing a Memory Upgrade](#)."

Removing Memory Modules

 **CAUTION:** Before you perform this procedure, see "[Safety First—For You and Your System](#)" in "Troubleshooting Your System."

 **CAUTION:** See "Protecting Against Electrostatic Discharge" in the safety instructions in your *System Information Guide*.

1. Turn off the system, including any attached peripherals, and disconnect the system from the electrical outlet.
 2. Remove the cover (see "[Removing the Cover](#)" in "Troubleshooting Your System").
 3. Lay the system on its right side.
 4. Locate the memory module connectors from which you will remove memory modules (see [Figure A-3](#)).
 5. Press down and outward on the memory module connector ejectors until the memory module pops out of the connector (see [Figure 6-4](#)).
 6. Repeat [step 4](#) and [step 5](#) of this procedure to remove any other memory modules.
 7. Perform [step 5](#) through [step 10](#) of "[Performing a Memory Upgrade](#)."
-

Microprocessors

To take advantage of future options in speed and functionality, you can add a second microprocessor or replace either the primary or secondary microprocessor.

 **NOTE:** The second microprocessor must be of the same type as the first. If the two microprocessors are different speeds, both will operate at the speed of the slower microprocessor.

Each microprocessor and its associated cache memory are contained in a PGA package that is installed in a ZIF socket on the system board.

The following items are included in the microprocessor upgrade kit:

1. A microprocessor
1. A heat sink with cooling fan

Removing and Installing a Microprocessor

 **CAUTION:** Before you perform this procedure, see "[Safety First—For You and Your System](#)" in "Troubleshooting Your System."

 **CAUTION:** See "Protecting Against Electrostatic Discharge" in the safety instructions in your *System Information Guide*.

1. Turn off the system, including any attached peripherals, and disconnect the system from the electrical outlet.
2. Remove the cover (see "[Removing the Cover](#)" in "Troubleshooting Your System").
3. Lay the system on its right side.
4. If you are removing or installing a microprocessor in socket CPU2, remove the vertical plastic baffle to improve access to the microprocessor socket (see "[Removing the Baffle](#)" in "Troubleshooting Your System").
5. Disconnect the microprocessor fan cable from the fan power connector on the system board (see [Figure 6-5](#)).

To identify system board connectors, see [Figure A-3](#).

6. Remove the back system fan (see "[Removing the Back System Fan](#)").

 **CAUTION:** The microprocessor and heat sink can become extremely hot. Be sure they have had sufficient time to cool before handling.

 **NOTICE:** Do not operate the system without the fan and heat sink assembly installed. The assembly is required to maintain proper thermal conditions.

 **NOTICE:** After removing the fan and heat sink assembly, place it upside down on a flat surface to prevent the thermal interface material on the heat sink from being damaged or contaminated.

 **NOTICE:** The microprocessor fan and heat sink are constructed together as a single assembly. Do not attempt to remove the fan from the heat sink.

7. Remove the microprocessor fan and heat sink assembly (see [Figure 6-5](#)):
 - a. Press down on the release tabs on the heat-sink retention clips to release the clips from the retaining tabs on the ZIF socket.
 - b. Lift the assembly away from the microprocessor.

Figure 6-5. Removing the Microprocessor Fan and Heat Sink Assembly

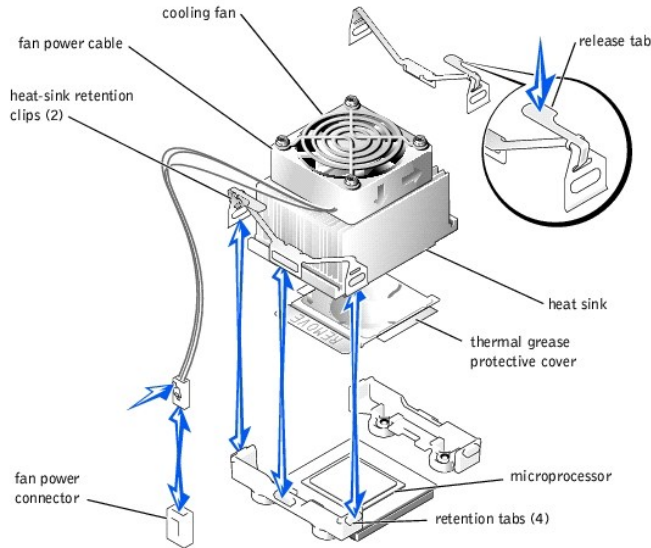

8. Pull the microprocessor socket release lever upward to the fully open position (see [Figure 6-6](#)).

NOTICE: Be careful not to bend any of the pins when removing the microprocessor. Bending the pins can permanently damage the microprocessor.

9. Lift the microprocessor out of the socket and leave the release lever in the open position so that the socket is ready for the new microprocessor (see [Figure 6-6](#)).

Figure 6-6. Removing and Installing a Microprocessor

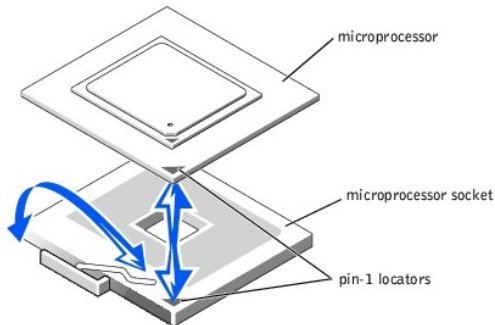

10. Unpack the new microprocessor.

If any of the pins on the microprocessor appear bent, see ["Getting Help"](#) for instructions on obtaining technical assistance.

11. Ensure that the microprocessor socket release lever is in the fully open position.

NOTICE: The microprocessor and system board can be damaged if the microprocessor socket release lever is not fully open when you insert the new microprocessor.

12. Align pin 1 on the microprocessor (see [Figure 6-6](#)) with pin 1 on the microprocessor socket.

➡ **NOTICE:** Positioning the microprocessor incorrectly can permanently damage the microprocessor and the system when you turn on the system. When placing the microprocessor in the socket, be sure that all of the pins on the microprocessor go into the corresponding holes and that the processor is parallel to the surface of the socket. Be careful not to bend the pins.

13. Install the microprocessor in the socket (see [Figure 6-6](#)).

 **NOTE:** No force is needed to install the microprocessor in the socket. When the microprocessor is aligned correctly, it should drop into the socket.

14. When the microprocessor is fully seated in the socket, rotate the socket release lever back down until it snaps into place, securing the microprocessor in the socket.

15. Place the microprocessor fan and heat sink assembly on top of the microprocessor (see [Figure 6-5](#)).

 | If the heat sink has a protective cover on the underside of the heat sink (see [Figure 6-5](#)), remove and discard the cover to expose the thermal grease, and then place the heat sink on the microprocessor.

 | If the heat sink has a foil thermal interface material on the bottom, place the heat sink on the microprocessor.

16. To reinstall the heat-sink retention clips, hold the clip by the release tab (see [Figure 6-5](#)), fit the opposite end of the clip over the tab on the microprocessor socket, and press down on the release tab until the free end of the clip snaps into place.

➡ **NOTICE:** The cooling fan must be connected for the microprocessor to maintain proper thermal conditions.

17. Connect the microprocessor fan cable to the fan connector on the system board (see [Figure 6-5](#)).

To identify system board connectors, see [Figure A-3](#).

18. Reinstall the back system fan (see "[Installing the Back System Fan](#)").

19. If you removed the baffle in [step 4](#), replace the baffle now (see "[Installing the Baffle](#)" in "Troubleshooting Your System").

➡ **NOTICE:** You must reinstall the baffle to maintain proper airflow for system cooling.

20. Stand the system upright.

21. Install the cover (see "[Installing the Cover](#)" in "Troubleshooting Your System").

22. Reconnect the system to its electrical outlet and turn the system on, including any attached peripherals.

23. Enter the System Setup program, and ensure that the microprocessor options match the new system configuration (see "Using the System Setup Program" in your *User's Guide*).

As the system boots, it detects the presence of the new microprocessor and automatically changes the system configuration information in the System Setup program. A message similar to the following appears:

```
One 1.8 GHz Processor, Processor Bus: 400 MHz, L2 cache 512 KB Advanced
```

24. Confirm that the top line of the system data area in the System Setup program correctly identifies the installed microprocessor(s) (see "Using the System Setup Program" in your *User's Guide*).

25. Exit the System Setup program.

26. Run the system diagnostics to verify that the new microprocessor is operating correctly.

See "[Running the System Diagnostics](#)" for information on running the diagnostics and troubleshooting any problems that may occur.

System Battery

The system battery is a 3-V, coin-cell battery.

Replacing the System Battery

 **CAUTION:** Before you perform this procedure, see "[Safety First—For You and Your System](#)" in "Troubleshooting Your System."

 **CAUTION:** See "Protecting Against Electrostatic Discharge" in the safety instructions in your *System Information Guide*.

⚠ CAUTION: There is a danger of a new battery exploding if it is incorrectly installed. Replace the battery only with the same or equivalent type recommended by the manufacturer. Discard used batteries according to the manufacturer's instructions. See your *System Information Guide* for additional information.

1. Turn off the system, including any attached peripherals, and disconnect the system from the electrical outlet.
2. Remove the cover (see "[Removing the Cover](#)" in "Troubleshooting Your System").
3. Lay the system on its right side.

See [Figure A-3](#) to locate the system battery on the system board.

4. If necessary, remove the expansion cards to access the battery socket.

See "[Removing an Expansion Card](#)."

5. Remove the system battery (see [Figure 6-7](#)).

You can pry the system battery out of its connector with your fingers or with a blunt, nonconductive object such as a plastic screwdriver.

6. Install the new system battery with the side labeled "+" facing up (see [Figure 6-7](#)).
7. If you removed expansion cards in step 4, replace them now.

See "[Installing an Expansion Card](#)."

8. Stand the system upright.
9. Install the cover.

See "[Installing the Cover](#)" in "Troubleshooting Your System."

10. Reconnect the system to its electrical outlet and turn the system on, including any attached peripherals.

Figure 6-7. Replacing the System Battery

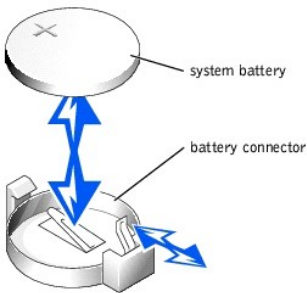

11. Enter the System Setup program to confirm that the battery is operating properly (see "Using the System Setup Program" in your *User's Guide*).
12. Enter the correct time and date in the System Setup program's **Time** and **Date** fields.
13. Exit the System Setup program.
14. To test the newly installed battery, turn off the system and disconnect it from the electrical outlet for at least an hour.
15. After an hour, reconnect the system to its electrical outlet and turn it on.
16. Enter the System Setup program and if the time and date are still incorrect, see "[Getting Help](#)" for instructions on obtaining technical assistance.

Installing Drives

Dell™ PowerEdge™ 1600SC Systems Installation and Troubleshooting Guide

- [Connecting Drives](#)
- [IDE Configuration Information](#)
- [SCSI Configuration Information](#)
- [Configuring the Boot Drive](#)
- [Diskette Drive](#)
- [Front-Panel Drive Inserts](#)
- [5.25-Inch Drives](#)
- [Hard Drives](#)
- [Installing a RAID Controller Card](#)

Your system can contain the following drives:

- 1 Up to two externally accessible 5.25-inch drives (typically CD drives or tape drives). A CD or other optical drive is standard in the first external drive bay, and an additional drive of your choice can be installed in the remaining external drive bay.
- 1 An externally accessible 3.5-inch diskette drive.
- 1 Up to four 1-inch non-hot-plug IDE or SCSI hard drives.
- 1 Up to six hot-plug SCSI hard drives.

Connecting Drives

Interface Cables

Most interface connectors are keyed for correct insertion. When you disconnect an interface cable, take care to grasp the cable connector, rather than the cable itself, to avoid stress on the cable.

Drive Cable Configurations

Your system can accommodate many different drive configurations, each with specific cable requirements. [Table 7-1](#) shows the cable requirements for common drive configurations.

Table 7-1. Drive Cable Configuration

Drives	Required Cable	Cable Connections
IDE CD drive, DVD drive, or combination drive (See Figure 7-4 .)	40-pin IDE 2-drop cable	IDE drive and secondary IDE connector on system board
Up to two IDE hard drives (See Figure 7-8 .)	80-pin IDE 2-drop cable	IDE hard drives and primary IDE connector on system board
Three or four IDE hard drives (See Figure 7-11 .)	80-pin IDE bundled 4-drop cable	IDE hard drives and IDE RAID controller card
Up to four non-hot-plug SCSI hard-drives (See Figure 7-9 and Figure 7-10 .)	66-cm (26-inch) or 94-cm (37-inch) 68-pin SCSI 4-drop cable (terminated)	660-cm (26-inch) cable to SCSI hard drives and SCSI controller on system board (See Figure 7-9 .) or 94-cm (37-inch) cable to SCSI hard drives and SCSI RAID controller (See Figure 7-10 .)
Up to six hot-plug SCSI hard drives (See Figure 7-12 and Figure 7-13 .)	38-cm (15-inch) or 63-cm (25-inch) 68-pin SCSI 1-drop cable (unterminated)	38-cm (15-inch) cable to SCSI backplane and SCSI connector on system board (See Figure 7-12 .) or 63-cm (25-inch) cable to SCSI backplane and RAID controller card (See Figure 7-13 .)
SCSI tape drive (See Figure 7-5 and Figure 7-6 .)	68-pin SCSI 1-drop cable (terminated)	SCSI tape drive and SCSI controller on system board (See Figure 7-5 .) or SCSI tape drive and SCSI controller card if SCSI controller is used for SCSI hard drives (See Figure 7-6 .)

NOTE: For the full name of an abbreviation or acronym used in this table, see "[Abbreviations and Acronyms](#)."

DC Power Cables

The 3.5-inch diskette drive, 5.25-inch devices, and non-hot-plug hard drives must connect to a DC power cable from the system power supply. (Hot-plug SCSI drives obtain their power from the optional SCSI backplane.)

IDE Configuration Information

The IDE subsystem provides two channels (primary and secondary). Each channel can support up to two IDE drives such as high-capacity hard drives, CD drives, DVD drives, and tape drives.

Each IDE drive should be configured for the **Cable Select** setting, which assigns master and slave status to a drive according to its position on the interface cable. In this configuration, the drive attached to the last connector on the interface cable is the master or boot drive (drive 0) and the drive attached to the middle connector on the interface cable is the slave drive (drive 1). See the drive's documentation for instructions on configuring the **Cable Select** setting.

[Table 7-2](#) lists guidelines for installing IDE drives connected to the IDE system board connectors.

Table 7-2. IDE Drive Configuration Guidelines

IDE Channel	System Board Connector	Drive Type(s)
1	PRIMARY IDE	IDE hard drives
2	SECONDARY IDE	IDE CD, DVD, tape, or combination drives
NOTE: The configurations shown in this table describe IDE drives connected directly to the IDE system board connectors. To identify system board connectors, see Figure A-3 .		

SCSI Configuration Information

Although SCSI drives are installed in essentially the same way as other drives, their configuration requirements are different. To install and configure a SCSI drive, follow the guidelines in the following subsections.

SCSI Interface Cables

SCSI interface connectors are keyed for correct insertion. Keying ensures that the pin-1 wire in the cable connects to pin 1 in the connectors on both ends. When you disconnect an interface cable, take care to grasp the cable connector, rather than the cable itself, to avoid stress on the cable.

SCSI ID Numbers

Each drive attached to a SCSI controller must have a unique SCSI ID number from 0 to 15.

- 1 The SCSI hard drive from which the system boots is configured as SCSI ID 0.
- 1 A SCSI tape drive is typically configured as SCSI ID 6.
- 1 If you install optional SCSI drives or change your SCSI configuration, see the documentation for each SCSI drive for information on setting the appropriate SCSI ID number.

 **NOTE:** There is no requirement that SCSI ID numbers be assigned sequentially or that drives be attached to the cable in order by ID number.

Device Termination

SCSI logic requires that termination be enabled for the two drives at opposite ends of the SCSI chain and disabled for all drives in between. For internal SCSI drives, termination is configured automatically. See the documentation provided with any optional SCSI drive you purchase for information on disabling termination.

Configuring the Boot Drive

The drive or device from which the system boots is determined by the boot order specified in the System Setup program (see "Using the System Setup Program" in your *User's Guide*). To boot the system from a hard drive or drive array, the drive(s) must be connected to the appropriate controller:

- 1 To boot from a single IDE hard drive, the master drive (drive 0) must be connected to the secondary controller on the system board. To identify system board connectors, see [Figure A-3](#).
 - 1 To boot from a single SCSI hard drive, the drive must be connected to the SCSI controller card (see the documentation that accompanied the controller card).
 - 1 To boot from an IDE or SCSI RAID array, the drive must be connected to the RAID controller card (see the documentation that accompanied the controller card).
-

Diskette Drive

Removing a Diskette Drive

⚠ CAUTION: Before you perform this procedure, see "[Safety First—For You and Your System](#)" in "Troubleshooting Your System."

⚠ CAUTION: See "Protecting Against Electrostatic Discharge" in the safety instructions in your *System Information Guide*.

1. Turn off the system, including any attached peripherals, and disconnect the system from the electrical outlet.
2. Remove the bezel (see "[Removing the Bezel](#)" in "Troubleshooting Your System").
3. Remove the cover (see "[Removing the Cover](#)" in "Troubleshooting Your System").
4. Lay the system on its right side.
5. Use your thumb and index finger to depress the tabs that secure the diskette drive in the drive bay (see [Figure 7-1](#)).
6. Slide the diskette drive forward out of the drive bay.
7. Disconnect the power cable and the interface cable from the diskette drive.

Figure 7-1. Removing a Diskette Drive

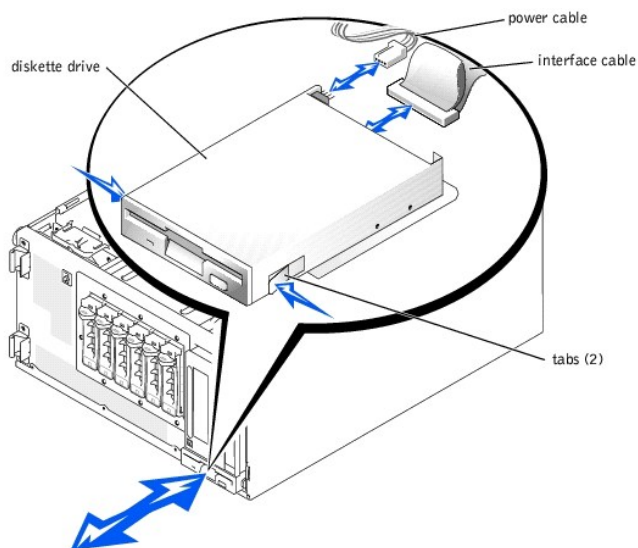

Installing a Diskette Drive

⚠ CAUTION: Before you perform this procedure, see "[Safety First—For You and Your System](#)" in "Troubleshooting Your System."

⚠ CAUTION: See "Protecting Against Electrostatic Discharge" in the safety instructions in your *System Information Guide*.

1. Connect the power cable and the interface cable to the diskette drive.
2. Slide the diskette drive into the externally accessible drive bay (see [Figure 7-1](#)).
3. Stand the system upright.
4. Install the cover (see "[Installing the Cover](#)" in "Troubleshooting Your System").
5. Install the bezel (see "[Installing the Bezel](#)" in "Troubleshooting Your System").
6. Reconnect the system to its electrical outlet and turn the system on, including any attached peripherals.

Front-Panel Drive Inserts

To help keep dust and dirt out of the system, a plastic insert in the bezel covers each empty external drive bay. Additionally, each empty external drive bay is covered by a metal insert in the chassis to maintain to maintain Federal Communications Commission (FCC) certification of the system.

Before you install a 5.25-inch drive in an empty external drive bay, you must first remove both drive inserts. If you remove a 5.25-inch drive permanently, you must install both the chassis and bezel inserts.

Removing the Front-Panel Drive Inserts

⚠ CAUTION: Before you perform this procedure, see "[Safety First—For You and Your System](#)" in "Troubleshooting Your System."

1. Turn off the system, including any attached peripherals, and disconnect the system from the electrical outlet.
2. Remove the bezel (see "[Removing the Bezel](#)" in "Troubleshooting Your System").
3. Remove the cover (see "[Removing the Cover](#)" in "Troubleshooting Your System").
4. Remove the bezel drive insert:
 - a. From inside the bezel, press the tabs at each end of the insert inward with your thumbs.
 - b. Pull the insert out of the bezel.
5. Remove the chassis drive insert (see [Figure 7-2](#)):
 - a. Press the tabs at each end of the insert inward.
 - b. Pull the insert out of the chassis.

Figure 7-2. Removing the Chassis Drive Insert

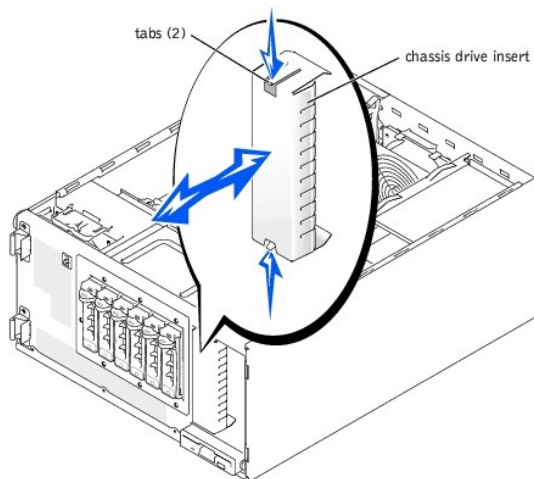

Installing the Front-Panel Drive Inserts

 **CAUTION:** Before you perform this procedure, see "[Safety First—For You and Your System](#)" in "Troubleshooting Your System."

 **NOTICE:** You must install both inserts in an empty 5.25-inch drive bay to maintain Federal Communications Commission (FCC) certification of the system. The inserts also help keep dust and dirt out of the system.

1. Install the chassis drive insert by sliding the insert into the chassis until the tabs on the side of the insert snap into place (see [Figure 7-2](#)).
 2. Install the bezel drive insert by sliding the insert into the bezel until the tabs on the side of the insert snap into place.
 3. Install the cover (see "[Installing the Cover](#)" in "Troubleshooting Your System").
 4. Install the bezel (see "[Installing the Bezel](#)" in "Troubleshooting Your System").
 5. Reconnect the system to its electrical outlet and turn the system on, including any attached peripherals.
-

5.25-Inch Drives

A CD drive, DVD drive, or combination drive is standard in the first external drive bay, and an additional drive of your choice can be installed in the second external drive bay. These drives connect either to the system board or to an optional controller card.

Installing a 5.25-Inch Drive

 **CAUTION:** Before you perform this procedure, see "[Safety First—For You and Your System](#)" in "Troubleshooting Your System."

 **CAUTION:** See "Protecting Against Electrostatic Discharge" in the safety instructions in your *System Information Guide*.

1. Unpack the drive (and controller card, if applicable), and prepare the drive for installation.

For instructions, see the documentation that accompanied the drive. Also, see "[IDE Configuration Information](#)" or "[SCSI Configuration Information](#)" for information on configuring the drive.

2. Turn off the system, including any attached peripherals, and disconnect the system from the electrical outlet.
3. Remove the front-panel inserts for the empty external drive bay (see "[Removing the Front-Panel Drive Inserts](#)").
4. Lay the system on its right side.
5. If the drive was supplied with a controller card, install the controller card in an expansion slot (see "[Installing an Expansion Card](#)" in "Installing System Options").
6. Slide the drive into the external drive bay.
7. Install the screws that secure the drive in the drive bay (see [Figure 7-3](#)).

Figure 7-3. Installing a 5.25-Inch Drive

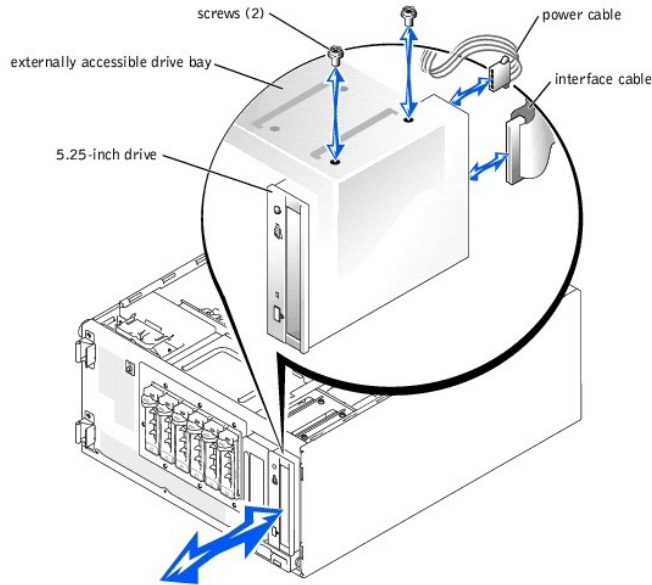

8. Connect a DC power cable connector to the drive's power input connector (see [Figure 7-3](#)).
9. Connect the interface cable to the drive (see [Figure 7-3](#)) and to the system board or controller card:
 1. [Figure 7-4](#) illustrates a common cable configuration for externally accessible IDE drives.
 1. [Figure 7-5](#) illustrates a SCSI tape drive connected to the SCSI controller on the system board.
 1. [Figure 7-6](#) shows a SCSI tape drive connected to a SCSI controller card.

If necessary, temporarily remove the baffle to allow easier routing of the interface cable (see "[Removing the Baffle](#)" in "Troubleshooting Your System").

For information about the controller card, see the documentation that accompanied the card.

Figure 7-4. Connecting an IDE CD Drive and Optional IDE Tape Drive to the Integrated IDE Controller

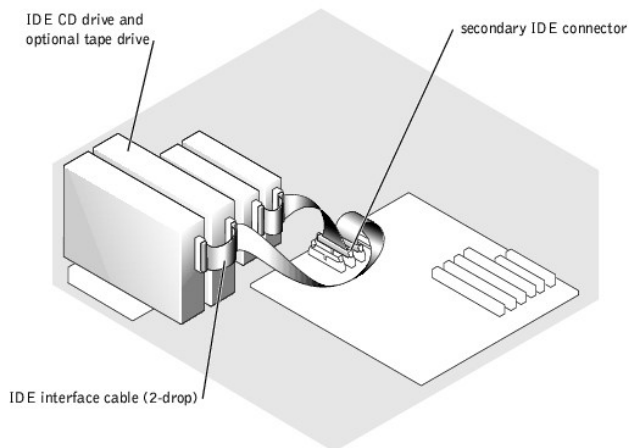

Figure 7-5. Connecting a SCSI Tape Drive to the Integrated SCSI Controller

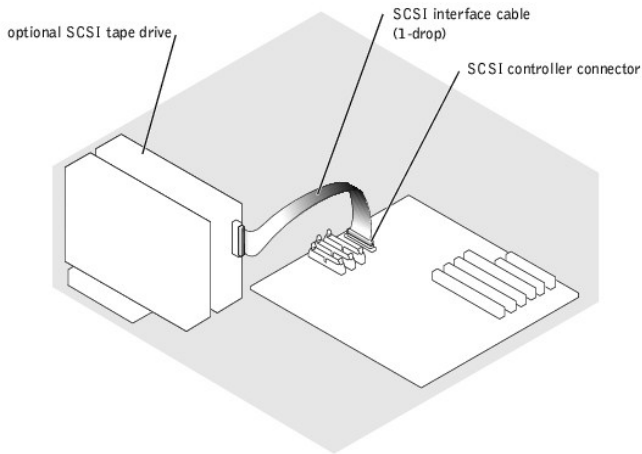
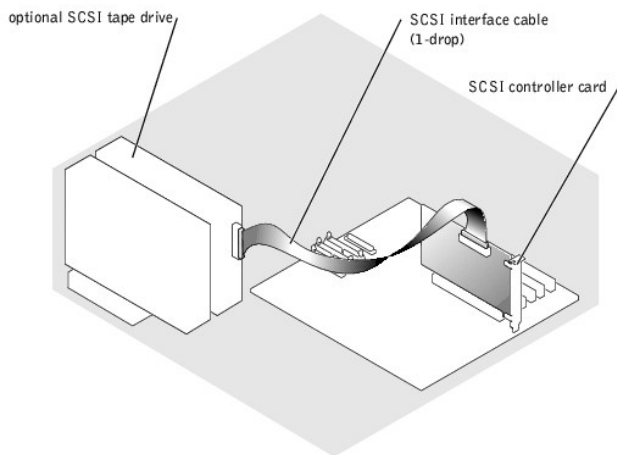

Figure 7-6. Connecting an SCSI Tape Drive to a SCSI Controller Card



10. Ensure that all cables are firmly connected and arranged so that they will not catch on the computer covers or block airflow inside the system.
11. If you removed the baffle in [step 9](#), replace the baffle now (see "[Installing the Baffle](#)" in "Troubleshooting Your System").
12. Stand the system upright.
13. Install the cover (see "[Installing the Cover](#)" in "Troubleshooting Your System").
14. Reconnect the system to its electrical outlet and turn the system on, including any attached peripherals.
15. Test the drive:
 1. If you installed an IDE drive, run the IDE devices tests in the system diagnostics to determine whether the tape drive operates properly (see "[Running the System Diagnostics](#)").
 1. If you installed a SCSI drive, run the SCSI controllers test in the system diagnostics (see "[Running the System Diagnostics](#)").
 1. If you installed a tape drive, see the tape drive software documentation to perform a backup and verification test.

Hard Drives

You can install up to four non-hot-plug IDE or SCSI hard drives in a removable drive bay or up to six hot-plug SCSI hard drives connected to the optional SCSI backplane.

General Installation Guidelines

Use the following guidelines when installing hard drives:

- 1 You should only use drives tested and approved for use in your system.
- 1 You may need to use different programs than those provided with the operating system to partition and format a hard drive. See the hard drive's documentation for information on setting up the drive.
- 1 When you format a high-capacity hard drive, allow enough time for the formatting to be completed. Long format times for these drives are normal. For example, a large drive can take over an hour to format.
- 1 Do not turn off or reboot your system while the drive is being formatted. Doing so can cause a drive failure.

Installing and Removing Non-Hot-Plug Hard Drives

Removing a Non-Hot-Plug Hard Drive

⚠ CAUTION: Before you perform this procedure, see "[Safety First—For You and Your System](#)" in "Troubleshooting Your System."

⚠ CAUTION: See "Protecting Against Electrostatic Discharge" in the safety instructions in your *System Information Guide*.

1. Turn off the system, including any attached peripherals, and disconnect the system from the electrical outlet.
2. Remove the cover (see "[Removing the Cover](#)" in "Troubleshooting Your System").
3. Lay the system on its right side.
4. Disconnect all power cables and interface cables from the hard drives in the drive bay.
5. Remove the hard-drive bay (see [Figure 7-7](#)):
 - a. Loosen the four Phillips-head screws that secure the drive bay in the system.
 - b. Slide the drive bay out of the system.
6. If you are removing a drive, remove the drive from the drive bay (see [Figure 7-7](#)):
 - a. Remove the two screws that secure the drive in the drive bay.
 - b. Slide the drive out of the drive bay.

Figure 7-7. Removing and Installing a Non-Hot-Plug Hard Drive

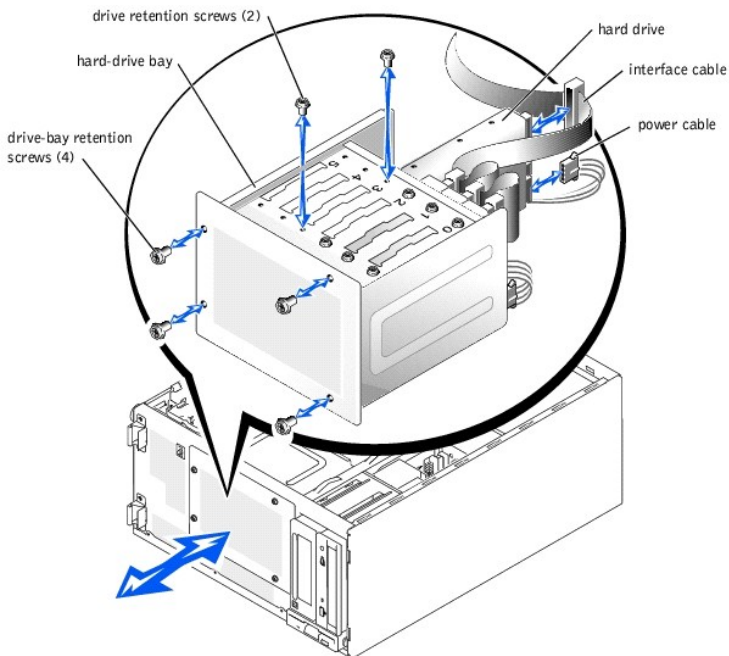

7. Install the hard-drive bay (see [Figure 7-7](#)):
 - a. With the side of the drive bay labeled "Top" facing toward the external drive bays, slide the drive bay into the system.

- b. Replace the four screws that secure the drive bay in the system.
8. Connect all power cables and interface cables to the hard drives remaining in the drive bay.
9. Stand the system upright.
10. Install the cover (see "[Installing the Cover](#)" in "Troubleshooting Your System").
11. Reconnect the system to its electrical outlet and turn the system on, including any attached peripherals.

Installing a Non-Hot-Plug Hard Drive

⚠ CAUTION: Before you perform this procedure, see "[Safety First—For You and Your System](#)" in "Troubleshooting Your System."

⚠ CAUTION: See "Protecting Against Electrostatic Discharge" in the safety instructions in your *System Information Guide*.

1. Unpack the drive (and controller card, if applicable), and prepare the drive for installation.

For instructions, see the documentation that accompanied the drive. Also, see "[IDE Configuration Information](#)" or "[SCSI Configuration Information](#)" for information on configuring the drive.

2. Turn off the system, including any attached peripherals, and disconnect the system from the electrical outlet.
3. Remove the cover (see "[Removing the Cover](#)" in "Troubleshooting Your System").
4. Lay the system on its right side.
5. If the drive was supplied with a controller card, install the controller card in an expansion slot (see "[Installing an Expansion Card](#)" in "Installing System Options").
6. Disconnect all power cables and interface cables from the hard drives in the drive bay.
7. Remove the hard-drive bay (see [Figure 7-7](#)):
 - a. Loosen the four Phillips-head screws that secure the drive bay in the system.
 - b. Slide the drive bay out of the system.
8. Install the drive in the drive bay (see [Figure 7-7](#)):
 - a. Slide the drive into the drive bay with the back of the drive toward the back of the drive bay.
 - b. Install the two screws that secure the drive in the drive bay.
9. Install the hard-drive bay (see [Figure 7-7](#)):
 - a. With the side of the drive bay labeled "Top" facing toward the external drive bays, slide the drive bay into the system.
 - b. Replace the four screws that secure the drive bay in the system.
10. Connect a DC power cable connector to the drive's power input connector.
11. Connect the interface cable connector to the drive's interface connector:
 1. If you are installing one or two IDE hard drives, connect the interface cable between the drive(s) and the system board (see [Figure 7-8](#)).
 1. If you are installing one or more SCSI hard drives, connect the interface cable to the drive(s) and the SCSI controller on the system board (see [Figure 7-9](#)).
 1. If you are installing drives in an IDE or SCSI RAID array, connect the interface cable to the drives and the optional RAID controller card (see [Figure 7-10](#) or [Figure 7-11](#)).

If necessary, temporarily remove the baffle to allow easier routing of the interface cable (see "[Removing the Baffle](#)" in "Troubleshooting Your System").

For information about the controller card, see the documentation that accompanied the card.

Figure 7-8. Connecting IDE Hard Drives to the Integrated IDE Controller

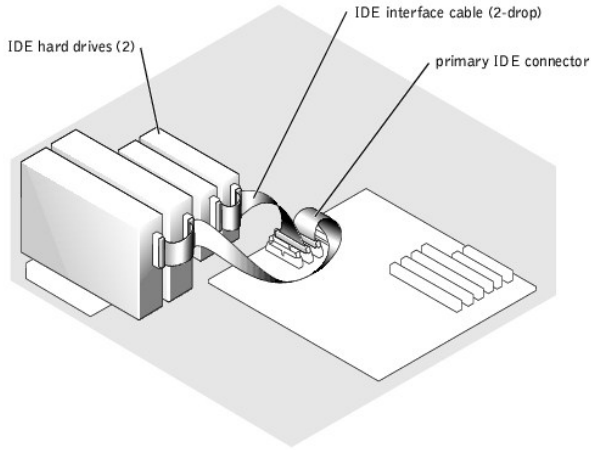

Figure 7-9. Connecting Non-Hot-Plug SCSI Hard Drives to the Integrated SCSI Controller

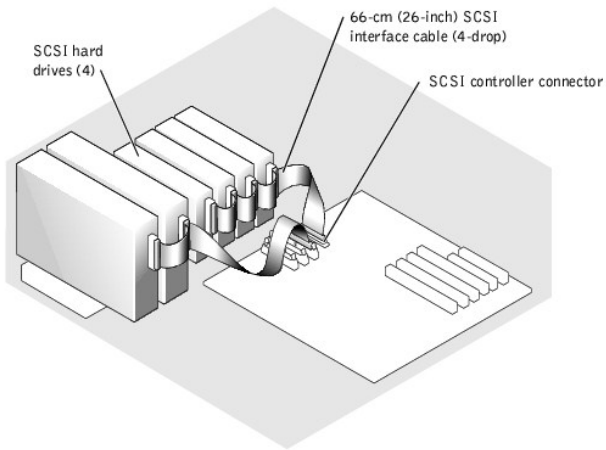

Figure 7-10. Connecting Non-Hot-Plug SCSI Hard Drives to an Optional SCSI RAID Controller Card

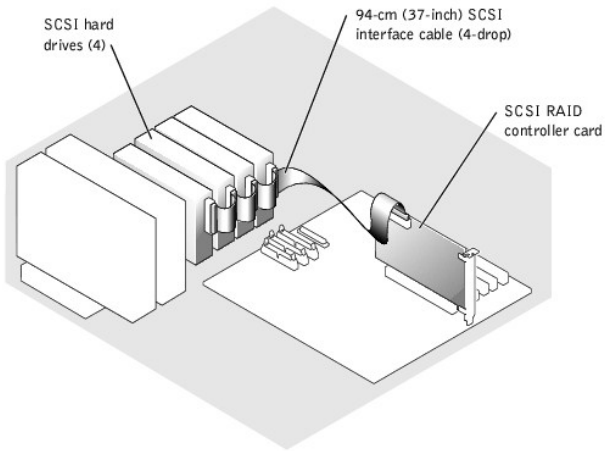
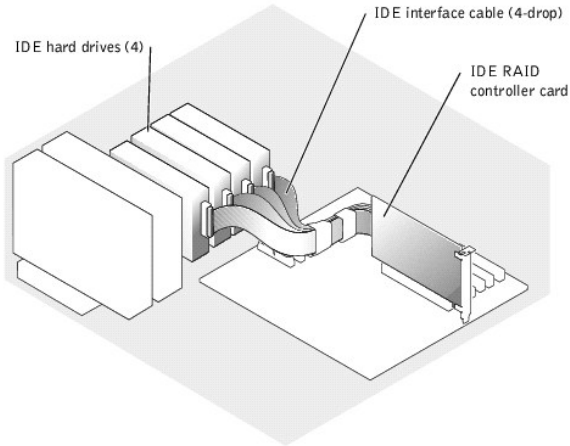

Figure 7-11. Connecting IDE Hard Drives to an Optional IDE RAID Controller Card



12. Connect all power cables and interface cables to the other hard drives in the drive bay.
13. Ensure that all cables are firmly connected and arranged so that they will not catch on the computer covers or block airflow inside the system.
14. If you removed the baffle in [step 11](#), replace the baffle now (see "[Installing the Baffle](#)" in "Troubleshooting Your System").
15. Stand the system upright.
16. Install the cover (see "[Installing the Cover](#)" in "Troubleshooting Your System").
17. Reconnect the system to its electrical outlet and turn the system on, including any attached peripherals.

NOTICE: Do not turn off or reboot your system while the drive is being formatted. Doing so can cause a drive failure.

18. Partition and logically format the hard drive (see the operating system documentation).
19. Test the drive:
 - 1 If you installed one or more IDE hard drives connected to the IDE controller on the system board, run the hard drive tests in the system diagnostics to determine whether the drive operates properly (see "[Running the System Diagnostics](#)").
 - 1 If you installed a drive in an IDE RAID array, run the hard drive tests in the system diagnostics (see "[Running the System Diagnostics](#)"). Also, see the RAID controller's documentation for information on testing the controller.
 - 1 If you installed one or more SCSI hard drives connected to the SCSI controller on the system board, run the SCSI controllers tests and the hard drive tests in the system diagnostics (see "[Running the System Diagnostics](#)").
 - 1 If you installed a drive in a SCSI RAID array, run the SCSI controllers tests and the hard drive tests in the system diagnostics (see "[Running the System Diagnostics](#)"). Also, see the RAID controller's documentation for information on testing the array.

Installing and Removing Hot-Plug SCSI Hard Drives

The drive bays in a system with an optional SCSI backplane board provide space for up to six 1-inch hard drives. The hard drives plug into the SCSI backplane board, which is connected to a controller on the system board (see [Figure 7-12](#)) or to a RAID controller card (see [Figure 7-13](#)).

Figure 7-12. Hot-Plug SCSI Hard Drives Connected to the Integrated SCSI Controller

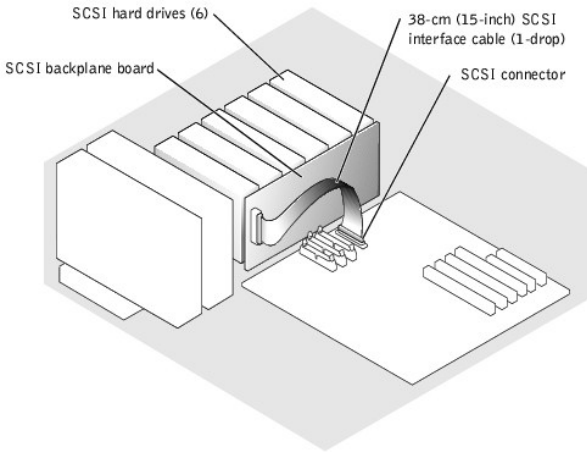
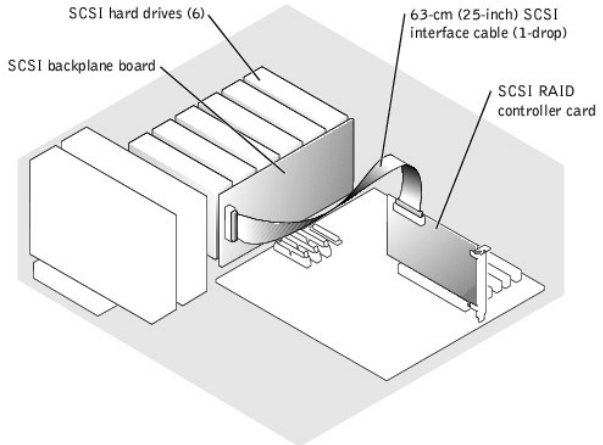

Figure 7-13. Hot-Plug SCSI Hard Drives Connected to a RAID Controller Card



Removing a Hot-Plug Hard Drive

NOTICE: Not all operating systems support hot-plug drive installation. See the documentation supplied with your operating system.

1. Remove the bezel (see ["Removing the Bezel"](#) in "Troubleshooting Your System").
2. Take the hard drive offline and wait until the hard-drive indicator codes on the drive carrier signal that the drive can be removed safely (see [Table 2-5](#)).

If the drive has been online, the drive-status indicator will blink green two times a second as the drive is powered down. When all indicators are off, the drive is ready for removal.

See your operating system documentation for more information on taking the hard drive offline.

3. Open the hard-drive carrier handle to release the drive (see [Figure 7-14](#)).

Figure 7-14. Removing and Installing a Hot-Plug Hard-Drive

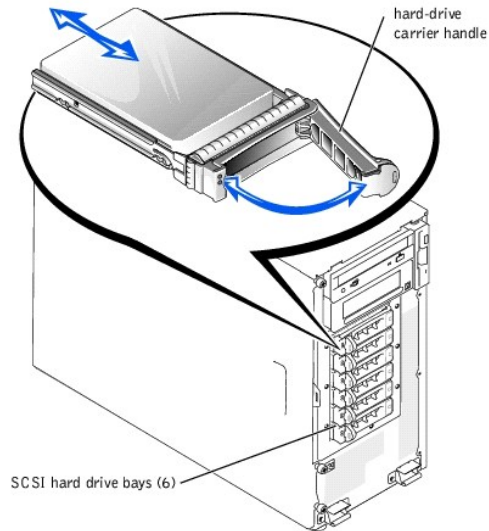

4. Slide the hard drive out until it is free of the drive bay (see [Figure 7-14](#)).
5. Replace the bezel (see "[Installing the Bezel](#)" in "Troubleshooting Your System").

Installing a Hot-Plug Hard Drive

➡ **NOTICE:** Not all operating systems support hot-plug drive installation. See the documentation supplied with your operating system.

1. Remove the bezel (see "[Removing the Bezel](#)" in "Troubleshooting Your System").
2. Open the hard-drive carrier handle (see [Figure 7-14](#)).

⚠ **NOTICE:** Do not insert a hard-drive carrier and attempt to lock its handle next to a partially installed carrier. Doing so can damage the partially installed carrier's shield spring and make it unusable. Ensure that the adjacent drive carrier is fully installed.

3. Insert the hard-drive carrier into the drive bay (see [Figure 7-14](#)).
4. Close the hard-drive carrier handle to lock it in place.
5. Replace the bezel (see "[Installing the Bezel](#)" in "Troubleshooting Your System").
6. Install any required SCSI device drivers.
7. If the hard drive is new, run the SCSI controllers test in the system diagnostics.

Installing a RAID Controller Card

Follow this general procedure when installing a RAID controller card. For specific instructions, see the documentation supplied with the card.

⚠ **CAUTION:** Before you perform this procedure, see "[Safety First—For You and Your System](#)" in "Troubleshooting Your System."

⚠ **CAUTION:** See "[Protecting Against Electrostatic Discharge](#)" in the safety instructions in your *System Information Guide*.

1. Unpack the expansion card, and prepare it for installation.

For instructions, see the documentation that accompanied the card.

2. Turn off the system, including any attached peripherals, and disconnect the system from the electrical outlet.
3. Remove the cover (see "[Removing the Cover](#)" in "Troubleshooting Your System").
4. Lay the system on its right side.
5. Install the controller card in expansion slot 1 or 2 (see "[Installing an Expansion Card](#)" in "Installing System Options").

6. Connect the interface cable to the card and to the drives.

See [Figure 7-10](#), [Figure 7-12](#), and the documentation that accompanied the card for information about cable connections between the drives and RAID card.

7. Stand the system upright.
8. Install the cover (see "[Installing the Cover](#)" in "Troubleshooting Your System").
9. Reconnect the system to its electrical outlet and turn the system on, including any attached peripherals.
10. Ensure that any required device drivers are installed and are configured correctly.

For information on installing device drivers, see the *Dell OpenManage Server Assistant* CD and the documentation that accompanied the controller card.

11. Test the array:
 1. If you are setting up an IDE RAID array, run the hard drive tests in the system diagnostics (see "[Running the System Diagnostics](#)").
 1. If you are setting up a SCSI RAID array, run the SCSI controllers tests and the hard drive tests in the system diagnostics (see "[Running the System Diagnostics](#)").

Also, see the RAID controller's documentation for information on testing the array.

[Back to Contents Page](#)

[Back to Contents Page](#)

Getting Help

Dell™ PowerEdge™ 1600SC Systems Installation and Troubleshooting Guide

- [Technical Assistance](#)
 - [Dell Enterprise Training and Certification](#)
 - [Problems With Your Order](#)
 - [Product Information](#)
 - [Returning Items for Warranty Repair or Credit](#)
 - [Before You Call](#)
 - [Contacting Dell](#)
-

Technical Assistance

If you need assistance with a technical problem, perform the following steps:

1. Complete the procedures in "Troubleshooting Your System."
2. Run the system diagnostics and record any information provided.
3. Make a copy of the [Diagnostics Checklist](#), and fill it out.
4. Use Dell's extensive suite of online services available at Dell Support at support.dell.com for help with installation and troubleshooting procedures.

For more information, see "Online Services."

5. If the preceding steps have not resolved the problem, call Dell for technical assistance.

 **NOTE:** Call technical support from a phone near or at the system so that technical support can assist you with any necessary procedures.

 **NOTE:** Dell's Express Service Code system may not be available in all countries.

When prompted by Dell's automated telephone system, enter your Express Service Code to route the call directly to the proper support personnel. If you do not have an Express Service Code, open the **Dell Accessories** folder, double-click the **Express Service Code** icon, and follow the directions.

For instructions on using the technical support service, see "[Technical Support Service](#)" and "[Before You Call](#)."

 **NOTE:** Some of the following services are not always available in all locations outside the continental U.S. Call your local Dell representative for information on availability.

Online Services

You can access Dell Support at support.dell.com. Select your region on the **WELCOME TO DELL SUPPORT** page, and fill in the requested details to access help tools and information.

You can contact Dell electronically using the following addresses:

- 1 World Wide Web

www.dell.com/

www.dell.com/ap/ (Asian/Pacific countries only)

www.euro.dell.com (Europe only)

www.dell.com/la (Latin American countries)

www.dell.ca (Canada only)

- 1 Anonymous file transfer protocol (FTP)

ftp.dell.com/

Log in as user: `anonymous`, and use your e-mail address as your password.

- 1 Electronic Support Service

support@us.dell.com

apsupport@dell.com (Asian/Pacific countries only)

support.euro.dell.com (Europe only)

- 1 Electronic Quote Service

sales@dell.com

apmarketing@dell.com (Asian/Pacific countries only)

sales_canada@dell.com (Canada only)

- 1 Electronic Information Service

info@dell.com

AutoTech Service

Dell's automated technical support service—AutoTech—provides recorded answers to the questions most frequently asked by Dell customers about their portable and desktop computer systems.

When you call AutoTech, use your touch-tone telephone to select the subjects that correspond to your questions.

The AutoTech service is available 24 hours a day, 7 days a week. You can also access this service through the technical support service. See the contact information for your region.

Automated Order-Status Service

To check on the status of any Dell™ products that you have ordered, you can go to support.dell.com, or you can call the automated order-status service. A recording prompts you for the information needed to locate and report on your order. See the contact information for your region.

Technical Support Service

Dell's technical support service is available 24 hours a day, 7 days a week, to answer your questions about Dell hardware. Our technical support staff use computer-based diagnostics to provide fast, accurate answers.

To contact Dell's technical support service, see "[Before You Call](#)" and then see the contact information for your region.

Dell Enterprise Training and Certification

Dell Enterprise Training and Certification is available; see www.dell.com/training for more information. This service may not be offered in all locations.

Problems With Your Order

If you have a problem with your order, such as missing parts, wrong parts, or incorrect billing, contact Dell for customer assistance. Have your invoice or packing slip available when you call. See the contact information for your region.

Product Information

If you need information about additional products available from Dell, or if you would like to place an order, visit the Dell website at www.dell.com. For the telephone number to call to speak to a sales specialist, see the contact information for your region.

Returning Items for Warranty Repair or Credit

Prepare all items being returned, whether for repair or credit, as follows:

1. Call Dell to obtain a Return Material Authorization Number, and write it clearly and prominently on the outside of the box.

For the telephone number to call, see the contact information for your region.

2. Include a copy of the invoice and a letter describing the reason for the return.
3. Include a copy of any diagnostic information (including the Diagnostics Checklist) indicating the tests you have run and any error messages reported by the system diagnostics.
4. Include any accessories that belong with the item(s) being returned (such as power cables, media such as CDs and diskettes, and guides) if the return is for credit.
5. Pack the equipment to be returned in the original (or equivalent) packing materials.

You are responsible for paying shipping expenses. You are also responsible for insuring any product returned, and you assume the risk of loss during shipment to Dell. Collect-on-delivery (C.O.D.) packages are not accepted.

Returns that are missing any of the preceding requirements will be refused at our receiving dock and returned to you.

Before You Call

 **NOTE:** Have your Express Service Code ready when you call. The code helps Dell's automated-support telephone system direct your call more efficiently.

Remember to fill out the [Diagnostics Checklist](#). If possible, turn on your system before you call Dell for technical assistance and call from a telephone at or near

the computer. You may be asked to type some commands at the keyboard, relay detailed information during operations, or try other troubleshooting steps possible only at the computer system itself. Ensure that the system documentation is available.

⚠ CAUTION: Before servicing any components inside your computer, see your *System Information Guide* for important safety information.

Diagnostics Checklist
Name:
Date:
Address:
Phone number:
Service Tag (bar code on the back of the computer):
Express Service Code:
Return Material Authorization Number (if provided by Dell support technician):
Operating system and version:
Peripherals:
Expansion cards:
Are you connected to a network? Yes No
Network, version, and network card:
Programs and versions:
See your operating system documentation to determine the contents of the system's start-up files. If possible, print each file. Otherwise, record the contents of each file before calling Dell.
Error message, beep code, or diagnostic code:
Description of problem and troubleshooting procedures you performed:

Contacting Dell

To contact Dell electronically, you can access the following websites:

- 1 www.dell.com
- 1 support.dell.com (technical support)
- 1 premiersupport.dell.com (technical support for educational, government, healthcare, and medium/large business customers, including Premier, Platinum, and Gold customers)

For specific web addresses for your country, find the appropriate country section in the table below.

NOTE: Toll-free numbers are for use within the country for which they are listed.

When you need to contact Dell, use the electronic addresses, telephone numbers, and codes provided in the following table. If you need assistance in determining which codes to use, contact a local or an international operator.

Country (City) International Access Code Country Code City Code	Department Name or Service Area, Website and E-Mail Address	Area Codes, Local Numbers, and Toll-Free Numbers
Anguilla	General Support	toll-free: 800-335-0031
Antigua and Barbuda	General Support	1-800-805-5924
Argentina (Buenos Aires)	Website: www.dell.com.ar	
International Access Code: 00	Tech Support and Customer Care	toll-free: 0-800-444-0733
Country Code: 54	Sales	0-810-444-3355
City Code: 11	Tech Support Fax	11 4515 7139
	Customer Care Fax	11 4515 7138
Aruba	General Support	toll-free: 800-1578

Australia (Sydney) International Access Code: 0011 Country Code: 61 City Code: 2	E-mail (Australia): au_tech_support@dell.com	
	E-mail (New Zealand): nz_tech_support@dell.com	
	Home and Small Business	1-300-65-55-33
	Government and Business	toll-free: 1-800-633-559
	Preferred Accounts Division (PAD)	toll-free: 1-800-060-889
	Customer Care	toll-free: 1-800-819-339
	Corporate Sales	toll-free: 1-800-808-385
	Transaction Sales	toll-free: 1-800-808-312
	Fax	toll-free: 1-800-818-341
Austria (Vienna) International Access Code: 900 Country Code: 43 City Code: 1	Website: support.euro.dell.com	
	E-mail: tech_support_central_europe@dell.com	
	Home/Small Business Sales	0820 240 530 00
	Home/Small Business Fax	0820 240 530 49
	Home/Small Business Customer Care	0820 240 530 14
	Preferred Accounts/Corporate Customer Care	0820 240 530 16
	Home/Small Business Technical Support	0820 240 530 14
	Preferred Accounts/Corporate Technical Support	0660 8779
	Switchboard	0820 240 530 00
Bahamas	General Support	toll-free: 1-866-278-6818
Barbados	General Support	1-800-534-3066
Belgium (Brussels) International Access Code: 00 Country Code: 32 City Code: 2	Website: support.euro.dell.com	
	E-mail: tech_be@dell.com	
	E-mail for French Speaking Customers: support.euro.dell.com/be/fr/emaiddell/	
	Technical Support	02 481 92 88
	Customer Care	02 481 91 19
	Corporate Sales	02 481 91 00
	Fax	02 481 92 99
	Switchboard	02 481 91 00
Bermuda	General Support	1-800-342-0671
Bolivia	General Support	toll-free: 800-10-0238
Brazil International Access Code: 00 Country Code: 55 City Code: 51	Website: www.dell.com/br	
	Customer Support, Technical Support	0800 90 3355
	Tech Support Fax	51 481 5470
	Customer Care Fax	51 481 5480
	Sales	0800 90 3390
British Virgin Islands	General Support	toll-free: 1-866-278-6820
Brunei Country Code: 673	Customer Technical Support (Penang, Malaysia)	604 633 4966
	Customer Service (Penang, Malaysia)	604 633 4949
	Transaction Sales (Penang, Malaysia)	604 633 4955
Canada (North York, Ontario) International Access Code: 011	Online Order Status: www.dell.ca/ostatus	
	AutoTech (automated technical support)	toll-free: 1-800-247-9362
	TechFax	toll-free: 1-800-950-1329
	Customer Care (Home Sales/Small Business)	toll-free: 1-800-847-4096
	Customer Care (med./large business, government)	toll-free: 1-800-326-9463
	Technical Support (Home Sales/Small Business)	toll-free: 1-800-847-4096
	Technical Support (med./large bus., government)	toll-free: 1-800-387-5757
	Sales (Home Sales/Small Business)	toll-free: 1-800-387-5752
	Sales (med./large bus., government)	toll-free: 1-800-387-5755
	Spare Parts Sales & Extended Service Sales	1 866 440 3355
Cayman Islands	General Support	1-800-805-7541
Chile (Santiago) Country Code: 56 City Code: 2	Sales, Customer Support, and Technical Support	toll-free: 1230-020-4823
China (Xiamen) Country Code: 86 City Code: 592	Tech Support website: support.ap.dell.com/china	
	Tech Support E-mail: cn_support@dell.com	
	Tech Support Fax	818 1350
	Home and Small Business Technical Support	toll-free: 800 858 2437
	Corporate Accounts Technical Support	toll-free: 800 858 2333

	Customer Experience	toll-free: 800 858 2060
	Home and Small Business	toll-free: 800 858 2222
	Preferred Accounts Division	toll-free: 800 858 2062
	Large Corporate Accounts GCP	toll-free: 800 858 2055
	Large Corporate Accounts Key Accounts	toll-free: 800 858 2628
	Large Corporate Accounts North	toll-free: 800 858 2999
	Large Corporate Accounts North Government and Education	toll-free: 800 858 2955
	Large Corporate Accounts East	toll-free: 800 858 2020
	Large Corporate Accounts East Government and Education	toll-free: 800 858 2669
	Large Corporate Accounts Queue Team	toll-free: 800 858 2572
	Large Corporate Accounts South	toll-free: 800 858 2355
	Large Corporate Accounts West	toll-free: 800 858 2811
	Large Corporate Accounts Spare Parts	toll-free: 800 858 2621
Colombia	General Support	980-9-15-3978
Costa Rica	General Support	0800-012-0435
Czech Republic (Prague)	Website: support.euro.dell.com	
International Access Code: 00	E-mail: czech_dell@dell.com	
Country Code: 420	Technical Support	02 2186 27 27
City Code: 2	Customer Care	02 2186 27 11
	Fax	02 2186 27 14
	TechFax	02 2186 27 28
	Switchboard	02 2186 27 11
Denmark (Copenhagen)	Website: support.euro.dell.com	
International Access Code: 00	E-mail Support (portable computers): den_nbk_support@dell.com	
Country Code: 45	E-mail Support (desktop computers): den_support@dell.com	
	E-mail Support (servers): Nordic_server_support@dell.com	
	Technical Support	7023 0182
	Customer Care (Relational)	7023 0184
	Home/Small Business Customer Care	3287 5505
	Switchboard (Relational)	3287 1200
	Fax Switchboard (Relational)	3287 1201
	Switchboard (Home/Small Business)	3287 5000
	Fax Switchboard (Home/Small Business)	3287 5001
Dominica	General Support	toll-free: 1-866-278-6821
Dominican Republic	General Support	1-800-148-0530
Ecuador	General Support	toll-free: 999-119
El Salvador	General Support	01-899-753-0777
Finland (Helsinki)	Website: support.euro.dell.com	
International Access Code: 990	E-mail: fin_support@dell.com	
Country Code: 358	E-mail Support (servers): Nordic_support@dell.com	
City Code: 9	Technical Support	09 253 313 60
	Technical Support Fax	09 253 313 81
	Relational Customer Care	09 253 313 38
	Home/Small Business Customer Care	09 693 791 94
	Fax	09 253 313 99
	Switchboard	09 253 313 00
France (Paris) (Montpellier)	Website: support.euro.dell.com	
International Access Code: 00	E-mail: support.euro.dell.com/fr/fr/emaildell/	
Country Code: 33	Home and Small Business	
City Codes: (1) (4)	Technical Support	0825 387 270
	Customer Care	0825 823 833
	Switchboard	0825 004 700
	Switchboard (calls from outside of France)	04 99 75 40 00
	Sales	0825 004 700
	Fax	0825 004 701
	Fax (calls from outside of France)	04 99 75 40 01
	Corporate	
	Technical Support	0825 004 719
	Customer Care	0825 338 339

	Switchboard	01 55 94 71 00
	Sales	01 55 94 71 00
	Fax	01 55 94 71 01
Germany (Langen)	Website: support.euro.dell.com	
International Access Code: 00	E-mail: tech_support_central_europe@dell.com	
Country Code: 49	Technical Support	06103 766-7200
City Code: 6103	Home/Small Business Customer Care	0180-5-224400
	Global Segment Customer Care	06103 766-9570
	Preferred Accounts Customer Care	06103 766-9420
	Large Accounts Customer Care	06103 766-9560
	Public Accounts Customer Care	06103 766-9555
	Switchboard	06103 766-7000
Greece	Website: support.euro.dell.com	
International Access Code: 00	E-mail: support.euro.dell.com/gr/en/emaildell/	
Country Code: 30	Technical Support	080044149518
	Gold Technical Support	08844140083
	Switchboard	2108129800
	Sales	2108129800
	Fax	2108129812
Grenada	General Support	toll-free: 1-866-540-3355
Guatemala	General Support	1-800-999-0136
Guyana	General Support	toll-free: 1-877-270-4609
Hong Kong	Website: support.ap.dell.com	
International Access Code: 001	E-mail: ap_support@dell.com	
Country Code: 852	Technical Support (Dimension™ and Inspiron™)	296 93188
	Technical Support (OptiPlex™, Latitude™, and Dell Precision™)	296 93191
	Customer Service (non-technical, post-sales issues)	800 93 8291
	Transaction Sales	toll-free: 800 96 4109
	Large Corporate Accounts HK	toll-free: 800 96 4108
	Large Corporate Accounts GCP HK	toll-free: 800 90 3708
India	Technical Support	1600 33 8045
	Sales	1600 33 8044
Ireland (Cherrywood)	Website: support.euro.dell.com	
International Access Code: 16	E-mail: dell_direct_support@dell.com	
Country Code: 353	Ireland Technical Support	1850 543 543
City Code: 1	U.K. Technical Support (dial within U.K. only)	0870 908 0800
	Home User Customer Care	01 204 4014
	Small Business Customer Care	01 204 4014
	U.K. Customer Care (dial within U.K. only)	0870 906 0010
	Corporate Customer Care	1850 200 982
	Corporate Customer Care (dial within U.K. only)	0870 907 4499
	Ireland Sales	01 204 4444
	U.K. Sales (dial within U.K. only)	0870 907 4000
	Fax/SalesFax	01 204 0103
	Switchboard	01 204 4444
Italy (Milan)	Website: support.euro.dell.com	
International Access Code: 00	E-mail: support.euro.dell.com/it/it/emaildell/	
Country Code: 39	Home and Small Business	
City Code: 02	Technical Support	02 577 826 90
	Customer Care	02 696 821 14
	Fax	02 696 821 13
	Switchboard	02 696 821 12
	Corporate	
	Technical Support	02 577 826 90
	Customer Care	02 577 825 55
	Fax	02 575 035 30
	Switchboard	02 577 821
Jamaica	General Support (dial from within Jamaica only)	1-800-682-3639
Japan (Kawasaki)	Website: support.jp.dell.com	

International Access Code: 001 Country Code: 81 City Code: 44	Technical Support (servers)	toll-free: 0120-198-498
	Technical Support outside of Japan (servers)	81-44-556-4162
	Technical Support (Dimension™ and Inspiron™)	toll-free: 0120-198-226
	Technical Support outside of Japan (Dimension and Inspiron)	81-44-520-1435
	Technical Support (Dell Precision™, OptiPlex™, and Latitude™)	toll-free: 0120-198-433
	Technical Support outside of Japan (Dell Precision, OptiPlex, and Latitude)	81-44-556-3894
	Faxbox Service	044-556-3490
	24-Hour Automated Order Service	044-556-3801
	Customer Care	044-556-4240
	Business Sales Division (up to 400 employees)	044-556-1465
	Preferred Accounts Division Sales (over 400 employees)	044-556-3433
	Large Corporate Accounts Sales (over 3500 employees)	044-556-3430
	Public Sales (government agencies, educational institutions, and medical institutions)	044-556-1469
	Global Segment Japan	044-556-3469
	Individual User	044-556-1760
	Switchboard	044-556-4300
Korea (Seoul) International Access Code: 001 Country Code: 82 City Code: 2	Technical Support	toll-free: 080-200-3800
	Sales	toll-free: 080-200-3600
	Customer Service (Seoul, Korea)	toll-free: 080-200-3800
	Customer Service (Penang, Malaysia)	604 633 4949
	Fax	2194-6202
	Switchboard	2194-6000
Latin America	Customer Technical Support (Austin, Texas, U.S.A.)	512 728-4093
	Customer Service (Austin, Texas, U.S.A.)	512 728-3619
	Fax (Technical Support and Customer Service) (Austin, Texas, U.S.A.)	512 728-3883
	Sales (Austin, Texas, U.S.A.)	512 728-4397
	SalesFax (Austin, Texas, U.S.A.)	512 728-4600 or 512 728-3772
Luxembourg International Access Code: 00 Country Code: 352	Website: support.euro.dell.com	
	E-mail: tech_be@dell.com	
	Technical Support (Brussels, Belgium)	3420808075
	Home/Small Business Sales (Brussels, Belgium)	toll-free: 080016884
	Corporate Sales (Brussels, Belgium)	02 481 91 00
	Customer Care (Brussels, Belgium)	02 481 91 19
	Fax (Brussels, Belgium)	02 481 92 99
	Switchboard (Brussels, Belgium)	02 481 91 00
Macao Country Code: 853	Technical Support	toll-free: 0800 582
	Customer Service (Penang, Malaysia)	604 633 4949
	Transaction Sales	toll-free: 0800 581
Malaysia (Penang) International Access Code: 00 Country Code: 60 City Code: 4	Technical Support	toll-free: 1 800 888 298
	Customer Service	04 633 4949
	Transaction Sales	toll-free: 1 800 888 202
	Corporate Sales	toll-free: 1 800 888 213
Mexico International Access Code: 00 Country Code: 52	Customer Technical Support	001-877-384-8979 or 001-877-269-3383
	Sales	50-81-8800 or 01-800-888-3355
	Customer Service	001-877-384-8979 or 001-877-269-3383
	Main	50-81-8800 or 01-800-888-3355
	General Support	toll-free: 1-866-278-6822
Netherlands Antilles	General Support	001-800-882-1519
Netherlands (Amsterdam) International Access Code: 00	Website: support.euro.dell.com	
	E-mail (Technical Support):	

Country Code: 31 City Code: 20	(Enterprise): nl_server_support@dell.com	
	(Latitude): nl_latitude_support@dell.com	
	(Inspiron): nl_inspiron_support@dell.com	
	(Dimension): nl_dimension_support@dell.com	
	(OptiPlex): nl_optiplex_support@dell.com	
	(Dell Precision): nl_workstation_support@dell.com	
	Technical Support	020 674 45 00
	Technical Support Fax	020 674 47 66
	Home/Small Business Customer Care	020 674 42 00
	Relational Customer Care	020 674 4325
	Home/Small Business Sales	020 674 55 00
	Relational Sales	020 674 50 00
	Home/Small Business Sales Fax	020 674 47 75
	Relational Sales Fax	020 674 47 50
Switchboard	020 674 50 00	
Switchboard Fax	020 674 47 50	
New Zealand	E-mail (New Zealand): nz_tech_support@dell.com	
International Access Code: 00	E-mail (Australia): au_tech_support@dell.com	
Country Code: 64	Home and Small Business	0800 446 255
	Government and Business	0800 444 617
	Sales	0800 441 567
	Fax	0800 441 566
Nicaragua	General Support	001-800-220-1006
Norway (Lysaker)	Website: support.euro.dell.com	
International Access Code: 00	E-mail Support (portable computers): nor_nbk_support@dell.com	
Country Code: 47	E-mail Support (desktop computers): nor_support@dell.com	
	E-mail Support (servers): nordic_server_support@dell.com	
	Technical Support	671 16882
	Relational Customer Care	671 17514
	Home/Small Business Customer Care	23162298
	Switchboard	671 16800
	Fax Switchboard	671 16865
	Panama	General Support
Peru	General Support	0800-50-669
Poland (Warsaw)	Website: support.euro.dell.com	
International Access Code: 011	E-mail: pl_support@dell.com	
Country Code: 48	Customer Service Phone	57 95 700
	Customer Care	57 95 999
	Sales	57 95 999
	Customer Service Fax	57 95 806
	Reception Desk Fax	57 95 998
	Switchboard	57 95 999
Portugal	Website: support.euro.dell.com	
International Access Code: 00	E-mail: support.euro.dell.com/pt/en/emaiddell/	
Country Code: 351	Technical Support	707200149
	Customer Care	800 300 413
	Sales	800 300 410 or 800 300 411 or 800 300 412 or 21 422 07 10
	Fax	21 424 01 12
Puerto Rico	General Support	1-800-805-7545
St. Kitts and Nevis	General Support	toll-free: 1-877-441-4731
St. Lucia	General Support	1-800-882-1521
St. Vincent and the	General Support	toll-free: 1-877-270-4609

Grenadines		
Singapore (Singapore)	Technical Support	toll-free: 800 6011 051
International Access Code: 005	Customer Service (Penang, Malaysia)	604 633 4949
	Transaction Sales	toll-free: 800 6011 054
Country Code: 65	Corporate Sales	toll-free: 800 6011 053
South Africa (Johannesburg)	Website: support.euro.dell.com	
International Access Code:	E-mail: dell_za_support@dell.com	
09/091	Technical Support	011 709 7710
	Customer Care	011 709 7707
Country Code: 27	Sales	011 709 7700
City Code: 11	Fax	011 706 0495
	Switchboard	011 709 7700
Southeast Asian and Pacific Countries	Customer Technical Support, Customer Service, and Sales (Penang, Malaysia)	604 633 4810
Spain (Madrid)	Website: support.euro.dell.com	
International Access Code: 00	E-mail: support.euro.dell.com/es/es/emaildell/	
	Home and Small Business	
Country Code: 34	Technical Support	902 100 130
	Customer Care	902 118 540
City Code: 91	Sales	902 118 541
	Switchboard	902 118 541
	Fax	902 118 539
	Corporate	
	Technical Support	902 100 130
	Customer Care	902 118 546
	Switchboard	91 722 92 00
	Fax	91 722 95 83
Sweden (Upplands Vasby)	Website: support.euro.dell.com	
International Access Code: 00	E-mail: swe_support@dell.com	
	E-mail Support for Latitude and Inspiron: Swe-nbk_kats@dell.com	
Country Code: 46	E-mail Support for OptiPlex: Swe_kats@dell.com	
City Code: 8	E-mail Support for Servers: Nordic_server_support@dell.com	
	Technical Support	08 590 05 199
	Relational Customer Care	08 590 05 642
	Home/Small Business Customer Care	08 587 70 527
	Employee Purchase Program (EPP) Support	20 140 14 44
	Fax Technical Support	08 590 05 594
	Sales	08 590 05 185
Switzerland (Geneva)	Website: support.euro.dell.com	
International Access Code: 00	E-mail: swisstech@dell.com	
	E-mail for French-speaking HSB and Corporate Customers: support.euro.dell.com/ch/fr/emaildell/	
Country Code: 41	Technical Support (Home and Small Business)	0844 811 411
City Code: 22	Technical Support (Corporate)	0844 822 844
	Customer Care (Home and Small Business)	0848 802 202
	Customer Care (Corporate)	0848 821 721
	Fax	022 799 01 90
	Switchboard	022 799 01 01
Taiwan	Technical Support (portable and desktop computers)	toll-free: 00801 86 1011
International Access Code: 002	Technical Support (servers)	toll-free: 0080 60 1256
	Transaction Sales	toll-free: 0080 651 228
Country Code: 886		or 0800 33 556
	Corporate Sales	toll-free: 0080 651 227
		or 0800 33 555
Thailand	Technical Support	toll-free: 0880 060 07
International Access Code: 001	Customer Service (Penang, Malaysia)	604 633 4949
Country Code: 66	Sales	toll-free: 0880 060 09

Trinidad/Tobago	General Support	1-800-805-8035
Turks and Caicos Islands	General Support	toll-free: 1-866-540-3355
U.K. (Bracknell)	Website: support.euro.dell.com	
International Access Code: 00	Customer Care website: support.euro.dell.com/uk/en/ECare/Form/Home.asp	
Country Code: 44	E-mail: dell_direct_support@dell.com	
City Code: 1344	Technical Support (Corporate/Preferred Accounts/PAD [1000+ employees])	0870 908 0500
	Technical Support (direct/PAD and general)	0870 908 0800
	Global Accounts Customer Care	01344 373 186
	Home and Small Business Customer Care	0870 906 0010
	Corporate Customer Care	01344 373 185
	Preferred Accounts (500-5000 employees) Customer Care	0870 906 0010
	Central Government Customer Care	01344 373 193
	Local Government & Education Customer Care	01344 373 199
	Health Customer Care	01344 373 194
	Home and Small Business Sales	0870 907 4000
	Corporate/Public Sector Sales	01344 860 456
Uruguay	General Support	toll-free: 000-413-598-2521
U.S.A. (Austin, Texas)	Automated Order-Status Service	toll-free: 1-800-433-9014
International Access Code: 011	AutoTech (portable and desktop computers)	toll-free: 1-800-247-9362
Country Code: 1	Consumer (Home and Home Office)	
	Technical Support	toll-free: 1-800-624-9896
	Customer Service	toll-free: 1-800-624-9897
	DellNet™ Service and Support	toll-free: 1-877-Dellnet (1-877-335-5638)
	Employee Purchase Program (EPP) Customers	toll-free: 1-800-695-8133
	Financial Services website: www.dellfinancialservices.com	
	Financial Services (lease/loans)	toll-free: 1-877-577-3355
	Financial Services (Dell Preferred Accounts [DPA])	toll-free: 1-800-283-2210
	Business	
	Customer Service and Technical Support	toll-free: 1-800-822-8965
	Employee Purchase Program (EPP) Customers	toll-free: 1-800-695-8133
	Projectors Technical Support	toll-free: 1-877-459-7298
	Public (government, education, and healthcare)	
	Customer Service and Technical Support	toll-free: 1-800-456-3355
	Employee Purchase Program (EPP) Customers	toll-free: 1-800-234-1490
	Dell Sales	toll-free: 1-800-289-3355 or toll-free: 1-800-879-3355
	Dell Outlet Store (Dell refurbished computers)	toll-free: 1-888-798-7561
	Software and Peripherals Sales	toll-free: 1-800-671-3355
	Spare Parts Sales	toll-free: 1-800-357-3355
	Extended Service and Warranty Sales	toll-free: 1-800-247-4618
	Fax	toll-free: 1-800-727-8320
	Dell Services for the Deaf, Hard-of-Hearing, or Speech-Impaired	toll-free: 1-877-DELLTTY (1-877-335-5889)
U.S. Virgin Islands	General Support	1-877-673-3355
Venezuela	General Support	8001-3605

Free Manuals Download Website

<http://myh66.com>

<http://usermanuals.us>

<http://www.somanuals.com>

<http://www.4manuals.cc>

<http://www.manual-lib.com>

<http://www.404manual.com>

<http://www.luxmanual.com>

<http://aubethermostatmanual.com>

Golf course search by state

<http://golfingnear.com>

Email search by domain

<http://emailbydomain.com>

Auto manuals search

<http://auto.somanuals.com>

TV manuals search

<http://tv.somanuals.com>