

# Dell™ Vostro™ 1310, 1510, 1710, and 2510 Setup and Quick Reference Guide

**This guide provides a features overview, specifications, and quick setup, software, and troubleshooting information for your computer. For more information about your operating system, devices, and technologies, see the *Dell Technology Guide* at [support.dell.com](http://support.dell.com)**

**Models PP36S, PP36L, and PP36X**

# Notes, Notices, and Cautions



**NOTE:** A NOTE indicates important information that helps you make better use of your computer.



**NOTICE:** A NOTICE indicates either potential damage to hardware or loss of data and tells you how to avoid the problem.



**CAUTION:** A CAUTION indicates a potential for property damage, personal injury, or death.

If you purchased a Dell™ n Series computer, any references in this document to Microsoft® Windows® operating systems are not applicable.

## Macrovision Product Notice

This product incorporates copyright protection technology that is protected by U.S. patents and other intellectual property rights. Use of this copyright protection technology must be authorized by Macrovision, and is intended for home and other limited viewing uses only unless otherwise authorized by Macrovision. Reverse engineering or disassembly is prohibited.

---

**Information in this document is subject to change without notice.**

© 2008 Dell Inc. All rights reserved.

Reproduction in any manner whatsoever without the written permission of Dell Inc. is strictly forbidden.

Trademarks used in this text: *Dell*, the *DELL* logo, *DellConnect*, and *Vostro* are trademarks of Dell Inc.; *Intel* and *Celeron* are registered trademarks and *Core* is a trademark of Intel Corporation in the U.S. and other countries; *Microsoft*, *Windows*, *Windows Vista*, and the *Windows Vista* start button logo are either trademarks or registered trademarks of Microsoft Corporation in the United States and/or other countries. *Bluetooth* is a registered trademark of Bluetooth SIG Inc.

Other trademarks and trade names may be used in this document to refer to either the entities claiming the marks and names or their products. Dell Inc. disclaims any proprietary interest in trademarks and trade names other than its own.

Models PP36S, PP36L, and PP36X

June 2008

P/N T607F

Rev. A01

# Contents

1	About Your Computer . . . . .	7
	<b>Front View</b> . . . . .	7
	<b>Back View</b> . . . . .	8
	<b>Battery Removal</b> . . . . .	9
	<b>Wireless Switch</b> . . . . .	10
2	Setting Up Your Computer . . . . .	11
	<b>Quick Setup</b> . . . . .	11
	<b>Connecting to the Internet</b> . . . . .	13
	Setting Up Your Internet Connection . . . . .	14
	<b>Transferring Information to a New Computer</b> . . . . .	15
	Microsoft Windows Vista® . . . . .	15
	Microsoft® Windows® XP Operating System . . . . .	15
3	Specifications . . . . .	19
4	Troubleshooting . . . . .	31
	<b>Tools</b> . . . . .	31
	Power Lights . . . . .	31
	Beep Codes . . . . .	31

Error Messages . . . . .	33
Dell Diagnostics. . . . .	38
<b>Solving Problems . . . . .</b>	<b>40</b>
Power Problems . . . . .	41
Memory Problems . . . . .	42
Lockups and Software Problems . . . . .	43
Dell Technical Update Service . . . . .	45
Dell Support Utility . . . . .	45
<b>5 Reinstalling Software . . . . .</b>	<b>47</b>
<b>Drivers . . . . .</b>	<b>47</b>
Identifying Drivers . . . . .	47
Reinstalling Drivers and Utilities . . . . .	47
<b>Restoring Your Operating System . . . . .</b>	<b>50</b>
Using Microsoft® Windows® System Restore . . . . .	50
Using Dell™ Factory Image Restore . . . . .	52
Using the Operating System Media. . . . .	53
Using the Operating System Media. . . . .	55
<b>6 Finding Information . . . . .</b>	<b>57</b>
<b>7 Getting Help . . . . .</b>	<b>59</b>
<b>Obtaining Assistance . . . . .</b>	<b>59</b>
Technical Support and Customer Service . . . . .	60
DellConnect™. . . . .	60
Online Services . . . . .	60
AutoTech Service. . . . .	61
Automated Order-Status Service. . . . .	61

<b>Problems With Your Order</b> . . . . .	<b>61</b>
<b>Product Information</b> . . . . .	<b>61</b>
<b>Returning Items for Warranty Repair or Credit</b> . . . . .	<b>62</b>
<b>Before You Call</b> . . . . .	<b>62</b>
<b>Contacting Dell</b> . . . . .	<b>64</b>
 Index . . . . .	 <b>65</b>



# About Your Computer

## Front View

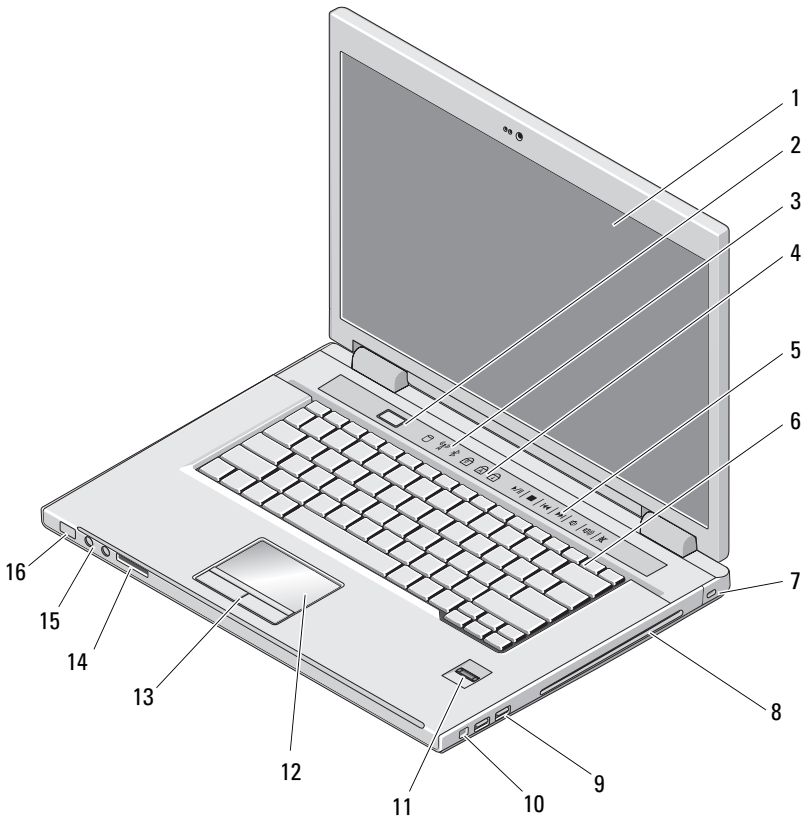

1	display	2	power button
3	device status lights	4	keyboard status lights
5	media controls (volume, forward, reverse, stop, play, eject)	6	keyboard
7	security cable slot	8	optical device/media bay
9	USB connectors (2)	10	IEEE 1394 connector
11	fingerprint reader (optional)	12	touch pad
13	touch pad buttons (2)	14	8-in-1 card reader slot
15	audio connectors (2)	16	power and battery charge lights

## Back View

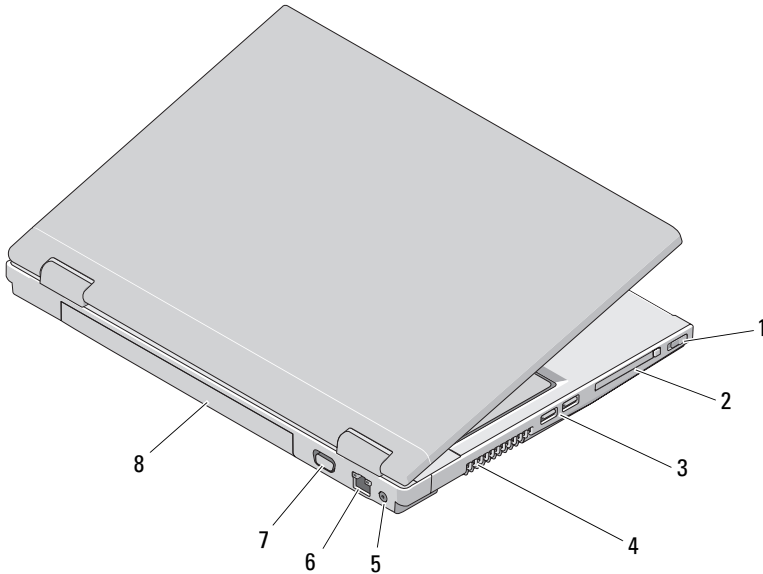





1	wireless switch	2	ExpressCard/54 slot
3	USB connectors (2)	4	air vents
5	AC Adapter connector	6	network connector
7	video connector	8	battery

 **CAUTION:** Do not block, push objects into, or allow dust to accumulate in the air vents. Do not store your Dell™ computer in a low-airflow environment, such as a closed briefcase, while it is running. Restricting the airflow can damage the computer or cause a fire. The computer turns on the fan when the computer gets hot. Fan noise is normal and does not indicate a problem with the fan or the computer.

## Battery Removal

 **CAUTION:** Before you begin any of the procedures in this section, follow the safety instructions that shipped with your computer.

 **CAUTION:** Using an incompatible battery may increase the risk of fire or explosion. Replace the battery only with a compatible battery purchased from Dell. The battery is designed to work with your Dell™ computer. Do not use a battery from other computers with your computer.

 **CAUTION:** Before removing or replacing the battery, turn off the computer, disconnect the AC adapter from the electrical outlet and the computer, disconnect the modem from the wall connector and computer, and remove any other external cables from the computer.

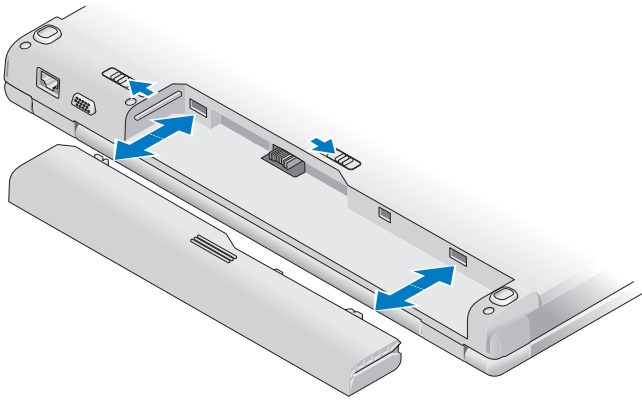

For more information about the battery, see the *Dell Technology Guide* at [support.dell.com](http://support.dell.com).



## Wireless Switch



Use the wireless switch to locate networks or to enable or disable wireless network devices. For more information about the wireless switch, see the *Dell Technology Guide* on your computer or at [support.dell.com](http://support.dell.com). For information about connecting to the Internet, see "Connecting to the Internet" on page 13.

# Setting Up Your Computer

## Quick Setup

-  **CAUTION:** Before you begin any of the procedures in this section, follow the safety instructions that shipped with your computer.
-  **CAUTION:** The AC adapter works with electrical outlets worldwide. However, power connectors and power strips vary among countries. Using an incompatible cable or improperly connecting the cable to the power strip or electrical outlet may cause fire or equipment damage.
-  **NOTICE:** When you disconnect the AC adapter cable from the computer, grasp the connector, not the cable itself, and pull firmly but gently to avoid damaging the cable. When you wrap the AC adapter cable, ensure that you follow the angle of the connector on the AC adapter to avoid damaging the cable.
- 1 Connect the AC adapter to the AC adapter connector on the computer and to the electrical outlet.

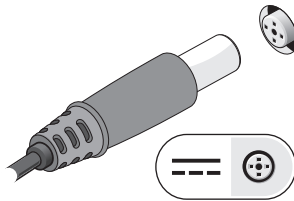

- 2 Connect the network cable (not provided) (optional).

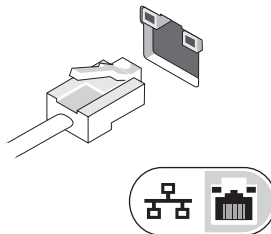

- 3 Connect USB devices, such as a mouse or keyboard (optional).

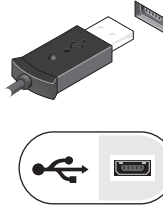

- 4 Connect IEEE 1394 devices, such as a media player (optional).

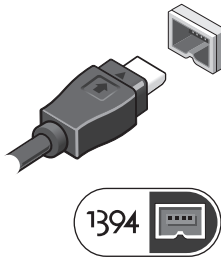

- 5 Open the computer display and press the power button to turn on the computer.

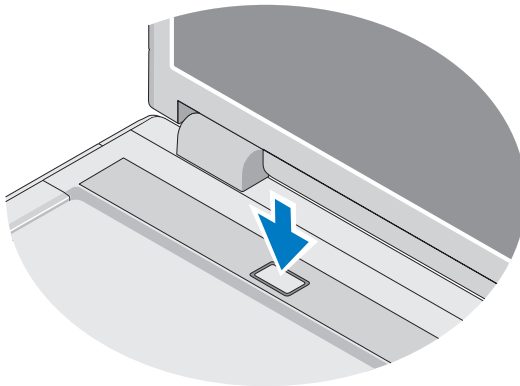

 **NOTE:** It is recommended that you turn on and shut down your computer at least once before you install any cards or connect the computer to a docking device or other external device, such as a printer.

- 6 Connect to the Internet (optional). See "Connecting to the Internet" on page 13 for more information.

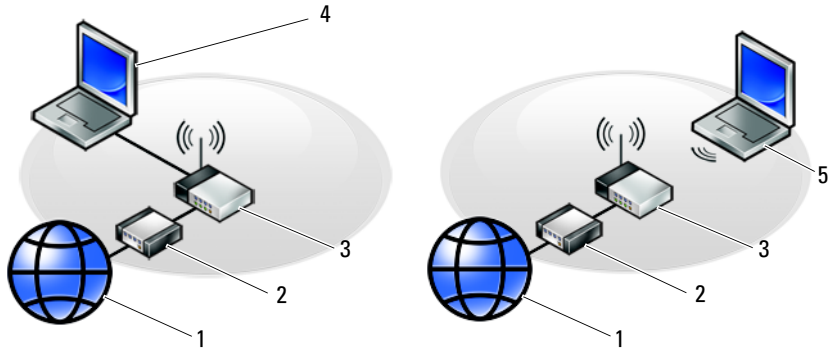

- 1 Internet service
- 2 cable or DSL modem
- 3 wireless router
- 4 laptop computer with network adapter
- 5 laptop computer with wireless network card

## Connecting to the Internet

 **NOTE:** ISPs and ISP offerings vary by country.

To connect to the Internet, you need a modem or network connection and an Internet service provider (ISP). *If you are using a dial-up connection*, connect a telephone line to the modem connector on your computer and to the telephone wall connector before you set up your Internet connection. *If you are using a DSL or cable/satellite modem connection*, contact your ISP or cellular phone service for setup instructions.

## Setting Up Your Internet Connection

To set up an Internet connection with a desktop shortcut provided by your ISP:

- 1 Save and close any open files, and exit any open programs.
- 2 Double-click the ISP icon on the Microsoft® Windows® desktop.
- 3 Follow the instructions on the screen to complete the setup.

If you do not have an ISP icon on your desktop or if you want to set up an Internet connection with a different ISP, perform the steps in the appropriate section below.



**NOTE:** If you cannot connect to the Internet, see the *Dell Technology Guide*. If you have successfully connected in the past, the ISP might have a service outage. Contact your ISP to check the service status, or try connecting again later.



**NOTE:** Have your ISP information ready. If you do not have an ISP, consult the **Connect to the Internet** wizard.

### Microsoft® Windows® XP Operating System

- 1 Save and close any open files, and exit any open programs.
- 2 Click **Start**→**Internet Explorer**→**Connect to the Internet**.
- 3 In the next window, click the appropriate option:
  - If you do not have an ISP, click **Choose from a list of Internet service providers (ISPs)**.
  - If you have already obtained setup information from your ISP but you did not receive a setup CD, click **Set up my connection manually**.
  - If you have a setup CD, click **Use the CD I got from an ISP**.

- 4 Click **Next**.



If you selected **Set up my connection manually** in step 3, continue to step 5. Otherwise, follow the instructions on the screen to complete the setup.



**NOTE:** If you do not know which type of connection to select, contact your ISP.

- 5 Click the appropriate option under **How do you want to connect to the Internet?**, and click **Next**.
- 6 Use the setup information provided by your ISP to complete the setup.

## Microsoft Windows Vista®

- 1 Save and close any open files, and exit any open programs.
  - 2 Click the Windows Vista Start button  → **Control Panel**
  - 3 Under **Network and Internet**, click **Connect to the Internet**.
  - 4 In the **Connect to the Internet** window, click either **Broadband (PPPoE)** or **Dial-up**, depending on how you want to connect:
    - Choose **Broadband** if you will use a DSL, satellite modem, cable TV modem, or Bluetooth wireless technology connection.
    - Chose **Dial-up** if you will use a dial-up modem or ISDN.
-  **NOTE:** If you do not know which type of connection to select, click **Help me choose** or contact your ISP.
- 5 Follow the instructions on the screen and use the setup information provided by your ISP to complete the setup.

## Transferring Information to a New Computer

### Microsoft Windows Vista®

- 1 Click the Windows Vista Start button , and then click **Transfer files and settings** → **Start Windows Easy Transfer**.
- 2 In the **User Account Control** dialog box, click **Continue**.
- 3 Click **Start a new transfer** or **Continue a transfer in progress**.

Follow the instructions provided on the screen by the Windows Easy Transfer wizard.

### Microsoft® Windows® XP Operating System

Windows XP provides the Files and Settings Transfer Wizard to move data from a source computer to a new computer.

You can transfer the data to the new computer over a network or serial connection, or you can store it on removable media, such as a writable CD, for transfer to the new computer.



**NOTE:** You can transfer information from an old computer to a new computer by directly connecting a serial cable to the input/output (I/O) ports of the two computers.

For instructions on setting up a direct cable connection between two computers, see Microsoft Knowledge Base Article #305621, titled *How to Set Up a Direct Cable Connection Between Two Computers in Windows XP*. This information may not be available in certain countries.

For transferring information to a new computer, you must run the Files and Settings Transfer Wizard.

### Running the Files and Settings Transfer Wizard With the Operating System Media



**NOTE:** This procedure requires the *Operating System* media. This media is optional and may not be included with certain computers.

To prepare a new computer for the file transfer:

- 1 Open the Files and Settings Transfer Wizard: click **Start**→**All Programs**→**Accessories**→**System Tools**→**Files and Settings Transfer Wizard**.
- 2 When the Files and Settings Transfer Wizard welcome screen appears, click **Next**.
- 3 On the **Which computer is this?** screen, click **New Computer**→**Next**.
- 4 On the **Do you have a Windows XP CD?** screen, click **I will use the wizard from the Windows XP CD**→**Next**.
- 5 When the **Now go to your old computer** screen appears, go to your old or source computer. Do *not* click **Next** at this time.

To copy data from the old computer:

- 1 On the old computer, insert the Windows XP *Operating System* media.
- 2 On the **Welcome to Microsoft Windows XP** screen, click **Perform additional tasks**.
- 3 Under **What do you want to do?**, click **Transfer files and settings**→**Next**.
- 4 On the **Which computer is this?** screen, click **Old Computer**→**Next**.
- 5 On the **Select a transfer method** screen, click the transfer method you prefer.



- 6 On the **What do you want to transfer?** screen, select the items you want to transfer and click **Next**.

After the information has been copied, the **Completing the Collection Phase** screen appears.

- 7 Click **Finish**.

To transfer data to the new computer:

- 1 On the **Now go to your old computer** screen on the new computer, click **Next**.
- 2 On the **Where are the files and settings?** screen, select the method you chose for transferring your settings and files and click **Next**.

The wizard reads the collected files and settings and applies them to your new computer.

When all of the settings and files have been applied, the **Finished** screen appears.

- 3 Click **Finished** and restart the new computer.

### **Running the Files and Settings Transfer Wizard Without the Operating System Media**

To run the Files and Settings Transfer Wizard without the *Operating System* media, you must create a wizard disk that will allow you to create a backup image file to removable media.

To create a wizard disk, use your new computer with Windows XP and perform the following steps:

- 1 Open the Files and Settings Transfer Wizard: click **Start**→**All Programs**→**Accessories**→**System Tools**→**Files and Settings Transfer Wizard**.
- 2 When the **Files and Settings Transfer Wizard** welcome screen appears, click **Next**.
- 3 On the **Which computer is this?** screen, click **New Computer**→**Next**.
- 4 On the **Do you have a Windows XP CD?** screen, click **I want to create a Wizard Disk in the following drive**→**Next**.
- 5 Insert the removable media, such as a writable CD, and click **OK**.

- 6 When the disk creation completes and the **Now go to your old computer** message appears, *do not* click **Next**.
- 7 Go to the old computer.

To copy data from the old computer:

- 1 On the old computer, insert the wizard disk, and click **Start**→**Run**.
- 2 In the **Open** field on the **Run** window, browse to the path for **fastwiz** (on the appropriate removable media) and click **OK**.
- 3 On the **Files and Settings Transfer Wizard** welcome screen, click **Next**.
- 4 On the **Which computer is this?** screen, click **Old Computer**→**Next**.
- 5 On the **Select a transfer method** screen, click the transfer method you prefer.
- 6 On the **What do you want to transfer?** screen, select the items you want to transfer and click **Next**.

After the information has been copied, the **Completing the Collection Phase** screen appears.

- 7 Click **Finish**.

To transfer data to the new computer:

- 1 On the **Now go to your old computer** screen on the new computer, click **Next**.
- 2 On the **Where are the files and settings?** screen, select the method you chose for transferring your settings and files and click **Next**. Follow the instructions on the screen.

The wizard reads the collected files and settings and applies them to your new computer.

When all of the settings and files have been applied, the **Finished** screen appears.

- 3 Click **Finished** and restart the new computer.



**NOTE:** For more information about this procedure, search [support.dell.com](http://support.dell.com) for document #154781 (*What Are The Different Methods To Transfer Files From My Old Computer To My New Dell™ Computer Using the Microsoft® Windows® XP Operating System?*).



**NOTE:** Access to the Dell™ Knowledge Base document may not be available in certain countries.

# Specifications



**NOTE:** Offerings may vary by region. For more information regarding the configuration of your computer, click **Start→Help and Support** and select the option to view information about your computer.

---

## Processor

---

Processor type	Dell™ Vostro™ 1310, 1510, and 1710: <ul style="list-style-type: none"> <li>• Intel® Core™2 Duo (1.4–2.6 GHz)</li> <li>• Intel® Celeron® (1.8–2.0 GHz)</li> </ul> Dell™ Vostro™ 2510: <ul style="list-style-type: none"> <li>• Intel® Core™2 Duo (1.4–2.6 GHz)</li> </ul>
L2 cache	<ul style="list-style-type: none"> <li>• 2 MB, 3 MB, 4MB, or 6 MB (Intel Core 2 Duo)</li> <li>• 1 MB (Intel Celeron)</li> </ul>
Front-side bus frequency	Vostro 1310, 1510, 1710, and 2510: <ul style="list-style-type: none"> <li>• 533 MHz or 800 MHz</li> </ul>

---

## System Information

---

Chipset	Vostro 1310, 1510, and 1710: <ul style="list-style-type: none"> <li>• Intel GM965 Express chipset for integrated graphics</li> <li>• Intel PM965 chipset for discrete graphics</li> </ul> Vostro 2510: <ul style="list-style-type: none"> <li>• Intel PM965</li> </ul>
Data bus width	64 bit
DRAM bus width	dual channel 64-bit bus
Processor address bus width	32 bit
Flash EPROM	1 MB

---

**ExpressCard**

---

**NOTE:** The ExpressCard slot is designed only for ExpressCards. It does NOT support PC Cards.

ExpressCard controller	integrated
ExpressCard connector	<ul style="list-style-type: none"><li>• 54-mm ExpressCard slot (supports both USB- and PCIe-based interfaces)</li></ul>
Cards supported	ExpressCard/54 (54 mm) (2.126 inches) ExpressCard/34 (34mm) (1.339 inches)
ExpressCard connector size	54 mm (2.126 inches)

---

**8-in-1 Memory Card Reader**

---

8-in-1 memory card controller	O2MICRO OZ129
8-in-1 memory card connector	8-in-1 combo card connector
Cards supported	<ul style="list-style-type: none"><li>• Secure Digital (SD)</li><li>• SDIO</li><li>• MultiMediaCard (MMC)</li><li>• Memory Stick</li><li>• Memory Stick Pro</li><li>• xD-Picture Card</li><li>• Hi Speed-SD</li><li>• Hi Density-SD</li></ul>

---

**Memory**

---

Memory module connector	2 DIMM slots
Memory module capacity	Vostro 1310, 1510, and 1710: 512 MB, 1 GB, or 2 GB Vostro 2510: 1 GB or 2 GB
Memory type	Vostro 1310, 1510, 1710, and 2510: DDR2 667 MHz

---

**Memory (continued)**

---

Minimum memory	Vostro 1310, 1510, and 1710: 512 MB Vostro 2510: 1 GB
Maximum memory	4 GB

**NOTE:** In order to take advantage of the dual-channel bandwidth capability, both memory slots must be populated.

**NOTE:** The available memory displayed does not reflect the complete maximum memory installed because some memory is reserved for system files.

---

**Ports and Connectors**

---

Audio	microphone connector, stereo headphone/speakers connector
IEEE 1394a	4-pin connector
Mini-Card support (internal expansion slots)	Vostro 1310, 1510, 1710, and 2510: <ul style="list-style-type: none"><li>• one dedicated Mini-Card slot for WLAN</li><li>• one USB-based daughter card with Bluetooth® wireless technology (Dell™ Wireless 360)</li></ul>
Network adapter	RJ-45 port
USB	Vostro 1310, 1510, and 2510: <ul style="list-style-type: none"><li>• four USB ports</li></ul> Vostro 1710: <ul style="list-style-type: none"><li>• six USB ports</li></ul>
Video	15-pin VGA video connector

---

**Communications**

---

Modem	supports external USB modem
Network adapter	Vostro 1310, 1510, 1710, and 2510: <ul style="list-style-type: none"><li>• 10/100/1000 Ethernet LAN on system board</li></ul>
Wireless	internal support for PCI-e Mini-Card WLAN and card with Bluetooth V2.0 wireless technology

---

**Video**

---

**NOTE:** Optional video controller upgrades are available for your computer subject to availability at the time of purchase.

Video type	Vostro 1310, 1510, and 1710 integrated: <ul style="list-style-type: none"><li>• integrated on system board</li><li>• discrete video card</li></ul>
Video controller	Vostro 1310, 1510, and 2510 discrete: <ul style="list-style-type: none"><li>• NVIDIA GeForce 8400M GS, 64 bit</li></ul> Vostro 1710 discrete: <ul style="list-style-type: none"><li>• NVIDIA GeForce 8600M GS, 128 bit</li></ul>
Video memory	Vostro 1310, 1510, and 1710 integrated: <ul style="list-style-type: none"><li>• up to 256 MB of shared memory</li></ul> Vostro 1310 discrete: <ul style="list-style-type: none"><li>• 128 MB</li></ul> Vostro 1510 and Vostro 2510 discrete: <ul style="list-style-type: none"><li>• 256 MB</li></ul> Vostro 1710 discrete: <ul style="list-style-type: none"><li>• 256 MB</li></ul>
LCD interface	LVDS

---

**Audio**

---

Audio type	high-definition audio (HDA)
Audio codec	Realtek ALC268
Stereo conversion	24-bit (analog-to-digital and digital-to-analog)
Interfaces:	
Internal	Azalia
External	microphone-in connector, stereo headphone/speakers connector
Speaker	Vostro 1310: <ul style="list-style-type: none"><li>• one 2-ohm speaker</li></ul> Vostro 1510, 1710, and 2510: <ul style="list-style-type: none"><li>• two 2-ohm speakers</li></ul>
Internal speaker amplifier	2 W
Volume controls	program menus, media controls

---

**Display**

---

Type (active-matrix TFT)	<ul style="list-style-type: none"><li>• WXGA anti-glare (Vostro 1310 and 1510)</li><li>• WXGA TrueLife (Vostro 1310)</li><li>• WXGA+ anti-glare (Vostro 1510 and 1710)</li><li>• WXGA+ TrueLife (Vostro 1510 and Vostro 2510)</li><li>• WUXGA TrueLife (Vostro 1510 and 1710)</li></ul>
Dimensions:	
Height	Vostro 1310: <ul style="list-style-type: none"><li>• 178.8 mm (7.03 inches)</li></ul> Vostro 1510 and Vostro 2510: <ul style="list-style-type: none"><li>• 208.9 mm (8.224 inches)</li></ul> Vostro 1710: <ul style="list-style-type: none"><li>• 245.0 mm (9.64 inches)</li></ul>

---

**Display (continued)**

---

Width	Vostro 1310: <ul style="list-style-type: none"><li>• 286 mm (11.26 inches)</li></ul> Vostro 1510 and Vostro 2510: <ul style="list-style-type: none"><li>• 333.1 mm (13.114 inches)</li></ul> Vostro 1710: <ul style="list-style-type: none"><li>• 383.0 mm (15.0 inches)</li></ul>
Diagonal	Vostro 1310: <ul style="list-style-type: none"><li>• 339.5 mm (13.366 inches)</li></ul> Vostro 1510 and Vostro 2510: <ul style="list-style-type: none"><li>• 393.2 mm (15.48 inches)</li></ul> Vostro 1710: <ul style="list-style-type: none"><li>• 431.71 mm (17.0 inches)</li></ul>
Maximum resolutions:	
WXGA	1280 x 800 (Vostro 1310 and 1510)
WXGA anti-glare	1280 x 800 (Vostro 1510 and 1710)
WXGA with TrueLife	1280 x 800 (Vostro 1310 and 1510)
WXGA+ anti-glare	1440 x 900 (Vostro 1510 and 1710)
WXGA+ with TrueLife	1440 x 900 (Vostro 1510, 1710 and 2510)
WSXGA+ with TrueLife	1680 x 1050 (Vostro 1510)
WUXGA with TrueLife	1920 x 1200 (Vostro 1510 and 1710)
Refresh rate	60 Hz
Operating angle	0° (closed) to 160°
Horizontal viewing angle	±40° (WXGA) ±40° (WXGA with TrueLife)
Controls	Brightness can be controlled through keyboard shortcuts.



---

**Keyboard**

---

Number of keys	Vostro 1310, Vostro 1510, and Vostro 2510: <ul style="list-style-type: none"><li>• 84 (U.S./Canada); 85 (Europe); 88 (Japan)</li></ul> Vostro 1710: <ul style="list-style-type: none"><li>• 105 (U.S./Chinese); 106 (Europe/Brazil); 109 (Japan)</li></ul>
Layout	QWERTY/AZERTY/Kanji
Size:	
Standard	full sized
Maximum	Vostro 1310, Vostro 1510, and Vostro 2510: <ul style="list-style-type: none"><li>• 283.1 mm x 118.9 mm x 5.2 mm (11.146 x 4.681 x 0.205 inches)</li></ul> Vostro 1710: <ul style="list-style-type: none"><li>• 359.4 mm x 118.9 mm x 5.2 mm (14.15 x 4.681 x 0.205 inches)</li></ul>

---

**Touch Pad**

---

X/Y position resolution (graphics table mode)	240 cpi
Size:	
Width	Vostro 1310: <ul style="list-style-type: none"><li>• 63 mm (2.480 inches)</li></ul> Vostro 1510, 1710, and Vostro 2510: <ul style="list-style-type: none"><li>• 73.7 mm (2.902 inches)</li></ul>
Height	Vostro 1310: <ul style="list-style-type: none"><li>• 37 mm (1.457 inches)</li></ul> Vostro 1510, 1710, and Vostro 2510: <ul style="list-style-type: none"><li>• 43.1 mm (1.697 inches)</li></ul>

---

**Battery**

---

Type	<p>Vostro 1310:</p> <ul style="list-style-type: none"><li>• 4-cell "smart" lithium ion</li><li>• 6-cell "smart" lithium ion</li><li>• 9-cell "smart" lithium ion</li></ul> <p>Vostro 1510 and Vostro 2510:</p> <ul style="list-style-type: none"><li>• 6-cell "smart" lithium ion</li><li>• 9-cell "smart" lithium ion</li></ul> <p>Vostro 1710:</p> <ul style="list-style-type: none"><li>• 6-cell "smart" lithium ion</li><li>• 8-cell "smart" lithium ion</li></ul>
Dimensions:	
Depth	<p>4 cell, 6 cell, and 8 cell:</p> <ul style="list-style-type: none"><li>• 50.3 mm (1.980 inches)</li></ul> <p>9 cell:</p> <ul style="list-style-type: none"><li>• 72 mm (2.835 inches)</li></ul>
Height	<p>Vostro 1310:</p> <ul style="list-style-type: none"><li>• 4 cell and 6 cell: 19.9 mm (0.783 inch)</li><li>• 9 cell: 20.7 mm (0.815 inch)</li></ul> <p>Vostro 1510 and Vostro 2510:</p> <ul style="list-style-type: none"><li>• 6 cell: 19.9 mm (0.783 inch)</li><li>• 9 cell: 20.7 mm (0.815 inch)</li></ul> <p>Vostro 1710:</p> <ul style="list-style-type: none"><li>• 6 cell and 8 cell: 20.2 mm (0.795 inch)</li></ul>
Width	<p>Vostro 1310 , Vostro 1510, and Vostro 2510:</p> <ul style="list-style-type: none"><li>• 4 cell and 6 cell: 205 mm (8.071 inches)</li><li>• 9 cell: 221.9 mm (8.736 inches)</li></ul> <p>Vostro 1710:</p> <ul style="list-style-type: none"><li>• 6 cell and 8 cell: 271 mm (10.67 inches)</li></ul>

---

**Battery (continued)**

---

Ampere hours	6-cell (2.6 Ahr) primary battery
	6-cell (2.2 Ahr) primary battery
	9-cell (2.6 Ahr) primary battery
Voltage	14.8 V (4 cell)
	11.1 V (6 cell and 9 cell)
Operating time (approximate)	2.5 hours (4 cell)
	4–5 hours (6 cell)
	7 hours or more (9 cell)

**NOTE:** Battery operating time varies depending on operating conditions and can be significantly reduced under certain power-intensive conditions (see "Power Problems" on page 41).

---

**AC Adapter**

---

Input voltage	100–240 VAC (65 W and 90 W)
Input current (maximum)	1.5 A (65 W and 90 W)
Input frequency	50–60 Hz (65 W and 90 W)
Output current (65 W)	4.34 A (maximum at 4-second pulse)
	3.34 A (continuous)
Output current (90 W)	5.62 A (maximum at 4-second pulse)
	4.62 A (continuous)

**NOTE:** On Vostro computers (except Vostro 1310) with discrete video configuration, you must use a 90 W AC adapter that is shipped with your computer. Using the incorrect AC adapter will prevent optimal system performance and produce a BIOS warning.

Rated output voltage	19.5 VDC (65 W and 90 W)
Dimensions (65 W):	
Height	27.8–28.6 mm (1.10–1.12 inches)
Width	57.9 mm (2.28 inches)
Depth	137.2 mm (5.40 inches)

---

**AC Adapter (continued)**

---

## Dimensions (90 W):

Height	33.8–34.6 mm (1.34–1.36 inches)
Width	60.9 mm (2.39 inches)
Depth	153.4 mm (6.04 inches)
Weight (with cables)	0.46 kg (1.01 lb)
Temperature range	0° to 35°C (32° to 95°F)

---

**Physical**

---

Height	Vostro 1310: <ul style="list-style-type: none"><li>• 23.8–37.2 mm (0.937–1.465 inches)</li></ul> Vostro 1510 and Vostro 2510: <ul style="list-style-type: none"><li>• 26.2–38 mm (1.031–1.496 inches)</li></ul> Vostro 1710: <ul style="list-style-type: none"><li>• 29–40.5 mm (1.142–1.594 inches)</li></ul>
Width	Vostro 1310: <ul style="list-style-type: none"><li>• 317 mm (12.480 inches)</li></ul> Vostro 1510 and Vostro 2510: <ul style="list-style-type: none"><li>• 357 mm (14.055 inches)</li></ul> Vostro 1710: <ul style="list-style-type: none"><li>• 393 mm (15.472 inches)</li></ul>
Depth	Vostro 1310: <ul style="list-style-type: none"><li>• 243.2 mm (9.575 inches)</li></ul> Vostro 1510 and Vostro 2510: <ul style="list-style-type: none"><li>• 258 mm (10.157 inches)</li></ul> Vostro 1710: <ul style="list-style-type: none"><li>• 286 mm (11.26 inches)</li></ul>

---

**Physical (continued)**

---

Weight	Vostro 1310: <ul style="list-style-type: none"><li>• minimum 2.1 kg (4.630 lb) with 4-cell battery</li></ul> Vostro 1510 and Vostro 2510: <ul style="list-style-type: none"><li>• minimum 2.8 kg (6.173 lb) with 6-cell battery</li></ul> Vostro 1710: <ul style="list-style-type: none"><li>• minimum 3.41kg (7.51 lb) with 8-cell battery</li></ul>
--------	---

---

**Environmental**

---

Temperature range:

Operating 0° to 35°C (32° to 95°F)

Storage -40° to 65°C (-40° to 149°F)

Relative humidity (maximum):

Operating 10% to 90% (noncondensing)

Storage 5% to 95% (noncondensing)

Maximum vibration (using a random vibration spectrum that simulates user environment):

Operating 0.66 GRMS

Storage 1.3 GRMS

Maximum shock (measured with hard drive in operating status and a 2-ms half-sine pulse for operating. Also measured with hard drive in head-parked position and a 2-ms halfsine pulse for storage):

Operating 142 G

Storage 163 G

---

**Camera (Optional)**

---

Still resolution	1.3 mega-pixel
------------------	----------------



# Troubleshooting

 **CAUTION:** To guard against the likelihood of electric shock, laceration by moving fan blades, or other expected injuries, always unplug your computer from the electrical outlet before opening the cover.

 **CAUTION:** Before you begin any of the procedures in this section, follow the safety instructions that shipped with your computer.

## Tools

### Power Lights

The two-color power-button light located on the front of the computer illuminates and blinks or remains solid to indicate different states:

- If the power light is off, the computer is either turned off or is not receiving power.
- If the power light is steady blue and the computer is not responding, ensure that the display is connected and powered on.
- If the power light is blinking blue, the computer is in standby mode. Press a key on the keyboard, move the mouse, or press the power button to resume normal operation. If the power light is blinking amber, the computer is receiving electrical power, a device such as a memory module or graphics card might be malfunctioning or incorrectly installed.
- If the power light is steady amber, there may be a power problem or an internal device malfunction.

### Beep Codes

Your computer might emit a series of beeps during start-up if the monitor cannot display errors or problems. This series of beeps, called a beep code, identifies a problem. One possible beep code consists of repetitive three short beeps. This beep code tells you that the computer encountered a possible motherboard failure.

If your computer beeps during start-up:

- 1 Write down the beep code.
- 2 Run the Dell Diagnostics to identify a more serious cause (see "Dell Diagnostics" on page 38).

<b>Code (repetitive short beeps)</b>	<b>Description</b>	<b>Suggested Remedy</b>
1	BIOS checksum failure. Possible motherboard failure.	Contact Dell.
2	No memory modules are detected	<ol style="list-style-type: none"><li>1 If you have two or more memory modules installed, remove the modules, reinstall one module (see your <i>Service Manual</i> at <a href="http://support.dell.com">support.dell.com</a>), and then restart the computer. If the computer starts normally, reinstall an additional module. Continue until you have identified a faulty module or reinstalled all modules without error.</li><li>2 If available, install good memory of the same type into your computer (see your <i>Service Manual</i> at <a href="http://support.dell.com">support.dell.com</a>).</li><li>3 If the problem persists, contact Dell.</li></ol>
3	Possible system board failure	Contact Dell.
4	RAM Read/Write failure	<ol style="list-style-type: none"><li>1 Ensure that no special memory module/memory connector placement requirements exist (see your <i>Service Manual</i> at <a href="http://support.dell.com">support.dell.com</a>).</li><li>2 Verify that the memory modules that you are installing are compatible with your computer (see your <i>Service Manual</i> at <a href="http://support.dell.com">support.dell.com</a>).</li><li>3 If the problem persists, contact Dell.</li></ol>



<b>Code (repetitive short beeps)</b>	<b>Description</b>	<b>Suggested Remedy</b>
5	Real-time clock failure. Possible battery failure or motherboard failure.	<b>1</b> Replace the battery (see your <i>Service Manual</i> at <a href="http://support.dell.com">support.dell.com</a> ). <b>2</b> If the problem persists, contact Dell.
6	Video BIOS Test Failure	Contact Dell.
7	CPU-cache test failure	Contact Dell.

## Error Messages



**CAUTION:** Before you begin any of the procedures in this section, follow the safety instructions that shipped with your computer.

If the message is not listed, see the documentation for the operating system or the program that was running when the message appeared.

**AUXILIARY DEVICE FAILURE** — The touch pad or external mouse may be faulty. For an external mouse, check the cable connection. Enable the **Pointing Device** option in the system setup program. See your *Service Manual* at [support.dell.com](http://support.dell.com) for more information. If the problem persists, contact Dell (see "Contacting Dell" on page 64).

**BAD COMMAND OR FILE NAME** — Ensure that you have spelled the command correctly, put spaces in the proper place, and used the correct pathname.

**CACHE DISABLED DUE TO FAILURE** — The primary cache internal to the microprocessor has failed. Contact Dell (see "Contacting Dell" on page 64).

**CD DRIVE CONTROLLER FAILURE** — The CD drive does not respond to commands from the computer.

**DATA ERROR** — The hard drive cannot read the data.

**DECREASING AVAILABLE MEMORY** — One or more memory modules may be faulty or improperly seated. Reinstall the memory modules and, if necessary, replace them. See your *Service Manual* at [support.dell.com](http://support.dell.com) for more information.

**DISK C: FAILED INITIALIZATION** — The hard drive failed initialization. Run the hard drive tests in the Dell Diagnostics (see "Dell Diagnostics" on page 38).

**DRIVE NOT READY** — The operation requires a hard drive in the bay before it can continue. Install a hard drive in the hard drive bay. See your *Service Manual* at [support.dell.com](http://support.dell.com) for more information.

**ERROR READING PCMCIA CARD** — The computer cannot identify the ExpressCard. Reinsert the card or try another card. See your *Service Manual* at [support.dell.com](http://support.dell.com) for more information.

**EXTENDED MEMORY SIZE HAS CHANGED** — The amount of memory recorded in nonvolatile memory (NVRAM) does not match the memory installed in the computer. Restart the computer. If the error appears again, contact Dell (see "Contacting Dell" on page 64).

**THE FILE BEING COPIED IS TOO LARGE FOR THE DESTINATION DRIVE** — The file that you are trying to copy is too large to fit on the disk, or the disk is full. Try copying the file to a different disk or use a larger capacity disk.

**A FILENAME CANNOT CONTAIN ANY OF THE FOLLOWING CHARACTERS: \ / : \* ? " < > |** — Do not use these characters in filenames.

**GATE A20 FAILURE** — A memory module may be loose. Reinstall the memory modules and, if necessary, replace them. See your *Service Manual* at [support.dell.com](http://support.dell.com) for more information.

**GENERAL FAILURE** — The operating system is unable to carry out the command. The message is usually followed by specific information—for example, `Printer out of paper`. Take the appropriate action.

**HARD-DISK DRIVE CONFIGURATION ERROR** — The computer cannot identify the drive type. Shut down the computer, remove the hard drive (see your *Service Manual* at [support.dell.com](http://support.dell.com)), and boot the computer from a CD. Then, shut down the computer, reinstall the hard drive, and restart the computer. Run the Hard Disk Drive tests in the Dell Diagnostics (see "Dell Diagnostics" on page 38).

**HARD-DISK DRIVE CONTROLLER FAILURE 0** — The hard drive does not respond to commands from the computer. Shut down the computer, remove the hard drive (see the *Service Manual* on [support.dell.com](http://support.dell.com)), and boot the computer from a CD. Then, shut down the computer, reinstall the hard drive, and restart the computer. If the problem persists, try another drive. Run the Hard Disk Drive tests in the Dell Diagnostics (see "Dell Diagnostics" on page 38).

**HARD-DISK DRIVE FAILURE** — The hard drive does not respond to commands from the computer. Shut down the computer, remove the hard drive (see your *Service Manual* at [support.dell.com](http://support.dell.com)), and boot the computer from a CD. Then, shut down the computer, reinstall the hard drive, and restart the computer. If the problem persists, try another drive. Run the Hard Disk Drive tests in the Dell Diagnostics (see "Dell Diagnostics" on page 38).

**HARD-DISK DRIVE READ FAILURE** — The hard drive may be defective. Shut down the computer, remove the hard drive (see your *Service Manual* at [support.dell.com](http://support.dell.com)), and boot the computer from a CD. Then, shut down the computer, reinstall the hard drive, and restart the computer. If the problem persists, try another drive. Run the Hard Disk Drive tests in the Dell Diagnostics (see "Dell Diagnostics" on page 38).

**INSERT BOOTABLE MEDIA** — The operating system is trying to boot to nonbootable media. Insert bootable media.

**INVALID CONFIGURATION INFORMATION-PLEASE RUN SYSTEM SETUP PROGRAM** — The system configuration information does not match the hardware configuration. The message is most likely to occur after a memory module is installed. Correct the appropriate options in the system setup program. See your *Service Manual* at [support.dell.com](http://support.dell.com) for more information.

**KEYBOARD CLOCK LINE FAILURE** — For external keyboards, check the cable connection. Run the Keyboard Controller test in the Dell Diagnostics (see "Dell Diagnostics" on page 38).

**KEYBOARD CONTROLLER FAILURE** — For external keyboards, check the cable connection. Restart the computer, and avoid touching the keyboard or the mouse during the boot routine. Run the Keyboard Controller test in the Dell Diagnostics (see "Dell Diagnostics" on page 38).

**KEYBOARD DATA LINE FAILURE** — For external keyboards, check the cable connection. Run the Keyboard Controller test in the Dell Diagnostics (see "Dell Diagnostics" on page 38).

**KEYBOARD STUCK KEY FAILURE** — For external keyboards or keypads, check the cable connection. Restart the computer, and avoid touching the keyboard or keys during the boot routine. Run the Stuck Key test in the Dell Diagnostics (see "Dell Diagnostics" on page 38).

**MEMORY ADDRESS LINE FAILURE AT ADDRESS, READ VALUE EXPECTING VALUE —**

A memory module may be faulty or improperly seated. Reinstall the memory modules and, if necessary, replace them. See your *Service Manual* at [support.dell.com](http://support.dell.com) for more information.

**MEMORY ALLOCATION ERROR —** The software you are attempting to run is conflicting with the operating system, another program, or a utility. Shut down the computer, wait 30 seconds, and then restart it. Try to run the program again. If the error message still appears, see the software documentation.

**MEMORY DATA LINE FAILURE AT ADDRESS, READ VALUE EXPECTING VALUE —** A memory module may be faulty or improperly seated. Reinstall the memory modules and, if necessary, replace them. See your *Service Manual* at [support.dell.com](http://support.dell.com) for more information.

**MEMORY DOUBLE WORD LOGIC FAILURE AT ADDRESS, READ VALUE EXPECTING VALUE —** A memory module may be faulty or improperly seated. Reinstall the memory modules and, if necessary, replace them. See your *Service Manual* at [support.dell.com](http://support.dell.com) for more information.

**MEMORY ODD/EVEN LOGIC FAILURE AT ADDRESS, READ VALUE EXPECTING VALUE —** A memory module may be faulty or improperly seated. Reinstall the memory modules and, if necessary, replace them. See your *Service Manual* at [support.dell.com](http://support.dell.com) for more information.

**MEMORY WRITE/READ FAILURE AT ADDRESS, READ VALUE EXPECTING VALUE —** A memory module may be faulty or improperly seated. Reinstall the memory modules and, if necessary, replace them. See your *Service Manual* at [support.dell.com](http://support.dell.com) for more information.

**NO BOOT DEVICE AVAILABLE —** The computer cannot find the hard drive. If the hard drive is your boot device, ensure that the drive is installed, properly seated, and partitioned as a boot device.

**NO BOOT SECTOR ON HARD DRIVE —** The operating system may be corrupted. Contact Dell (see "Contacting Dell" on page 64).

**NO TIMER TICK INTERRUPT —** A chip on the system board may be malfunctioning. Run the System Set tests in the Dell Diagnostics (see "Dell Diagnostics" on page 38).

**NOT ENOUGH MEMORY OR RESOURCES. EXIT SOME PROGRAMS AND TRY AGAIN —** You have too many programs open. Close all windows and open the program that you want to use.

**OPERATING SYSTEM NOT FOUND** — Reinstall the hard drive (see your *Service Manual* at [support.dell.com](http://support.dell.com)). If the problem persists, run the Dell Diagnostics (see "Dell Diagnostics" on page 38).

**OPTIONAL ROM BAD CHECKSUM** — The optional ROM has failed. run the Dell Diagnostics (see "Dell Diagnostics" on page 38).

**A REQUIRED .DLL FILE WAS NOT FOUND** — The program that you are trying to open is missing an essential file. Remove and then reinstall the program.

*Windows XP:*

- 1 Click **Start**→**Control Panel**→**Add or Remove Programs**→**Programs and Features**.
- 2 Select the program you want to remove.
- 3 Click **Uninstall**.
- 4 See the program documentation for installation instructions.

*Windows Vista:*

- 1 Click the Windows Vista Start button →**Control Panel**→**Programs**→**Programs and Features**.
- 2 Select the program you want to remove.
- 3 Click **Uninstall**.
- 4 See the program documentation for installation instructions.

**SECTOR NOT FOUND** — The operating system cannot locate a sector on the hard drive. You may have a defective sector or corrupted FAT on the hard drive. Run the Windows error-checking utility to check the file structure on the hard drive. See Windows Help and Support for instructions (click **Start**→**Help and Support**). If a large number of sectors are defective, back up the data (if possible), and then reformat the hard drive.

**SEEK ERROR** — The operating system cannot find a specific track on the hard drive.

**SHUTDOWN FAILURE** — A chip on the system board may be malfunctioning. Run the System Set tests in the Dell Diagnostics (see "Dell Diagnostics" on page 38).

**TIME-OF-DAY CLOCK LOST POWER** — System configuration settings are corrupted. Connect your computer to an electrical outlet to charge the battery. If the problem persists, try to restore the data by entering the system setup program, then immediately exit the program (see your *Service Manual* at [support.dell.com](http://support.dell.com)). If the message reappears, contact Dell (see "Contacting Dell" on page 64).

**TIME-OF-DAY CLOCK STOPPED** — The reserve battery that supports the system configuration settings may require recharging. Connect your computer to an electrical outlet to charge the battery. If the problem persists, contact Dell (see "Contacting Dell" on page 64).

**TIME-OF-DAY NOT SET-PLEASE RUN THE SYSTEM SETUP PROGRAM** — The time or date stored in the system setup program does not match the system clock. Correct the settings for the **Date** and **Time** options. See your *Service Manual* at [support.dell.com](http://support.dell.com) for more information.

**TIMER CHIP COUNTER 2 FAILED** — A chip on the system board may be malfunctioning. Run the System Set tests in the Dell Diagnostics (see "Dell Diagnostics" on page 38).

**UNEXPECTED INTERRUPT IN PROTECTED MODE** — The keyboard controller may be malfunctioning, or a memory module may be loose. Run the System Memory tests and the Keyboard Controller test in the Dell Diagnostics (see "Dell Diagnostics" on page 38).

**X:\ IS NOT ACCESSIBLE. THE DEVICE IS NOT READY** — Insert a disk into the drive and try again.

**WARNING: BATTERY IS CRITICALLY LOW** — The battery is running out of charge. Replace the battery, or connect the computer to an electrical outlet; otherwise, activate hibernate mode or shut down the computer.

## Dell Diagnostics



**CAUTION:** Before you begin any of the procedures in this section, follow the safety instructions that shipped with your computer.

### When to Use the Dell Diagnostics

If you experience a problem with your computer, perform the checks in Lockups and Software Problems (see "Lockups and Software Problems" on page 43) and run the Dell Diagnostics before you contact Dell for technical assistance.

It is recommended that you print these procedures before you begin.



**NOTICE:** The Dell Diagnostics works only on Dell computers.



**NOTE:** The *Drivers and Utilities* media is optional and may not ship with your computer.

See your *Service Manual* at [support.dell.com](http://support.dell.com) to review your computer's configuration information, and ensure that the device that you want to test displays in the system setup program and is active.

Start the Dell Diagnostics from your hard drive or from the *Drivers and Utilities* media.

### Starting the Dell Diagnostics From Your Hard Drive



**NOTE:** If your computer cannot display a screen image, see "Contacting Dell" on page 64.

- 1 Ensure that the computer is connected to an electrical outlet that is known to be working properly.
- 2 Turn on (or restart) your computer.
- 3 When the DELL™ logo appears, press <F12> immediately. Select **Diagnostics** from the start menu and press <Enter>.



**NOTE:** If you wait too long and the operating system logo appears, continue to wait until you see the Microsoft® Windows® desktop, and then shut down your computer and try again.



**NOTE:** If you see a message stating that no diagnostics utility partition has been found, run the Dell Diagnostics from the *Drivers and Utilities* media.

- 4 Press any key to start the Dell Diagnostics from the diagnostics utility partition on your hard drive, and follow the instructions on the screen.

## Starting the Dell Diagnostics From the *Drivers and Utilities Media*

- 1 Insert the *Drivers and Utilities* media.
- 2 Shut down and restart the computer.

When the DELL logo appears, press <F12> immediately.



**NOTE:** If you wait too long and the operating system logo appears, continue to wait until you see the Microsoft® Windows® desktop; then, shut down your computer and try again.



**NOTE:** The next steps change the boot sequence for one time only. On the next start-up, the computer starts according to the devices specified in the system setup program.

- 3 When the boot device list appears, highlight CD/DVD/CD-RW and press <Enter>.
- 4 Select the **Boot from CD-ROM** option from the menu that appears and press <Enter>.
- 5 Type 1 to start the CD menu and press <Enter> to proceed.
- 6 Select **Run the 32 Bit Dell Diagnostics** from the numbered list. If multiple versions are listed, select the version that is appropriate for your computer.
- 7 When the Dell Diagnostics **Main Menu** appears, select the test that you want to run, and follow the instructions on the screen.

## Solving Problems

Follow these tips when troubleshooting your computer:

- If you added or removed a part before the problem started, review the installation procedures and ensure that the part is correctly installed (see your *Service Manual* at [support.dell.com](http://support.dell.com)).
- If a device does not work, ensure that the device is properly connected.
- If an error message appears on the screen, write down the exact message. This message may help support personnel to diagnose and fix the problem(s).
- If an error message occurs in a program, see the program documentation.



**NOTE:** The procedures in this document were written for the Windows default view, so they may not apply if you set your Dell computer to the Windows Classic view.



## Power Problems

 **CAUTION:** Before you begin any of the procedures in this section, follow the safety information that shipped with your computer.

**IF THE POWER LIGHT IS OFF** — The computer is either turned off or is not receiving power.

- Reseat the power cable in the power connector on the back of the computer and the electrical outlet.
- Bypass power strips, power extension cables, and other power protection devices to verify that the computer turns on properly.
- Ensure that any power strips being used are plugged into an electrical outlet and are turned on.
- Ensure that the electrical outlet is working by testing it with another device, such as a lamp.
- Ensure that the main power cable and front panel cable are securely connected to the system board (see your *Service Manual* at [support.dell.com](http://support.dell.com)).

**IF THE POWER LIGHT IS BLUE AND THE COMPUTER IS NOT RESPONDING** —

- Ensure that the display is connected and powered on.
- If the display is connected and powered on, see "Beep Codes" on page 31.

**IF THE POWER LIGHT IS BLINKING BLUE** — The computer is in standby mode. Press a key on the keyboard, move the mouse, or press the power button to resume normal operation.

**IF THE POWER LIGHT IS BLINKING AMBER** — The computer is receiving electrical power, a device might be malfunctioning or incorrectly installed.

- Remove and then reinstall all memory modules (see your *Service Manual* at [support.dell.com](http://support.dell.com)).
- Remove and then reinstall any expansion cards, including graphics cards (see your *Service Manual* at [support.dell.com](http://support.dell.com)).

**IF THE POWER LIGHT IS STEADY AMBER** — There is a power problem, a device may be malfunctioning or incorrectly installed.

- Ensure that the processor power cable is securely connected to the system board power connector (see your *Service Manual* at [support.dell.com](http://support.dell.com)).
- Ensure that the main power cable and the front panel cable are securely connected to the system board connector (see your *Service Manual* at [support.dell.com](http://support.dell.com)).

**ELIMINATE INTERFERENCE** — Some possible causes of interference are:

- Power, keyboard, and mouse extension cables
- Too many devices connected to the same power strip
- Multiple power strips connected to the same electrical outlet

## Memory Problems



**CAUTION:** Before you begin any of the procedures in this section, follow the safety information that shipped with your computer.

### IF YOU RECEIVE AN INSUFFICIENT MEMORY MESSAGE —

- Save and close any open files and exit any open programs you are not using to see if that resolves the problem.
- See the software documentation for minimum memory requirements. If necessary, install additional memory (see your *Service Manual* at [support.dell.com](http://support.dell.com)).
- Reseat the memory modules (see your *Service Manual* at [support.dell.com](http://support.dell.com)) to ensure that your computer is successfully communicating with the memory.
- Run the Dell Diagnostics (see "Dell Diagnostics" on page 38).

### IF YOU EXPERIENCE OTHER MEMORY PROBLEMS —

- Reseat the memory modules (see your *Service Manual* at [support.dell.com](http://support.dell.com)) to ensure that your computer is successfully communicating with the memory.
- Ensure that you are following the memory installation guidelines (see your *Service Manual* at [support.dell.com](http://support.dell.com)).
- Ensure that the memory you are using is supported by your computer. For more information about the type of memory supported by your computer, see "Memory" on page 20.
- Run the Dell Diagnostics (see "Dell Diagnostics" on page 38).

## Lockups and Software Problems



**CAUTION:** Before you begin any of the procedures in this section, follow the safety information that shipped with your computer.

### The computer does not start up

**ENSURE THAT THE POWER CABLE IS FIRMLY CONNECTED TO THE COMPUTER AND TO THE ELECTRICAL OUTLET**

### The computer stops responding



**NOTICE:** You may lose data if you are unable to perform an operating system shutdown.

**TURN THE COMPUTER OFF** — If you are unable to get a response by pressing a key on your keyboard or moving your mouse, press and hold the power button for at least 8 to 10 seconds (until the computer turns off), and then restart your computer.

### A program stops responding

**END THE PROGRAM** —

- 1 Press <Ctrl><Shift><Esc> simultaneously to access the Task Manager.
- 2 Click the **Applications** tab.
- 3 Click to select the program that is no longer responding.
- 4 Click **End Task**.

### A program crashes repeatedly



**NOTE:** Most software includes installation instructions in its documentation or on a CD or DVD.

**CHECK THE SOFTWARE DOCUMENTATION** — If necessary, uninstall and then reinstall the program.

## **A program is designed for an earlier Microsoft® Windows® operating system**

### **RUN THE PROGRAM COMPATIBILITY WIZARD —**

*Windows XP:*

The Program Compatibility Wizard configures a program so that it runs in an environment similar to non-XP operating system environments.

- 1 Click **Start** → **All Programs** → **Accessories** → **Program Compatibility Wizard** → **Next**.
- 2 Follow the instructions on the screen.

*Windows Vista:*

The Program Compatibility Wizard configures a program so that it runs in an environment similar to non-Windows Vista operating system environments.

- 1 Click **Start**  → **Control Panel** → **Programs** → **Use an older program with this version of Windows**.
- 2 In the welcome screen, click **Next**.
- 3 Follow the instructions on the screen.

## **A solid blue screen appears**

**TURN THE COMPUTER OFF —** If you are unable to get a response by pressing a key on your keyboard or moving your mouse, press and hold the power button for at least 8 to 10 seconds (until the computer turns off), and then restart your computer.

## **Other software problems**

### **CHECK THE SOFTWARE DOCUMENTATION OR CONTACT THE SOFTWARE MANUFACTURER FOR TROUBLESHOOTING INFORMATION —**

- Ensure that the program is compatible with the operating system installed on your computer.
- Ensure that your computer meets the minimum hardware requirements needed to run the software. See the software documentation for information.
- Ensure that the program is installed and configured properly.
- Verify that the device drivers do not conflict with the program.
- If necessary, uninstall and then reinstall the program.

## **BACK UP YOUR FILES IMMEDIATELY**

- Use a virus-scanning program to check the hard drive, floppy disks, CDs, or DVDs
- Save and close any open files or programs and shut down your computer through the Start menu

## **Dell Technical Update Service**

The Dell Technical Update service provides proactive e-mail notification of software and hardware updates for your computer. The service is free and can be customized for content, format, and how frequently you receive notifications.

To enroll for the Dell Technical Update service, go to [support.dell.com/technicalupdate](http://support.dell.com/technicalupdate).

## **Dell Support Utility**

The Dell Support Utility is installed on your computer and available from the Dell Support, , icon on the taskbar or from the **Start** button. Use this support utility for self-support information, software updates, and health scans of your computing environment.

### **Accessing the Dell Support Utility**

Access the Dell Support Utility from the  icon on the taskbar or from the **Start** menu.

If the Dell Support icon does not appear in your taskbar:

- 1** Click **Start**→**All Programs**→**Dell Support**→**Dell Support Settings**.
- 2** Ensure that the **Show icon on the taskbar** option is checked.



**NOTE:** If the Dell Support Utility is not available from the **Start** menu, go to [support.dell.com](http://support.dell.com) and download the software.

The Dell Support Utility is customized for your computing environment.

The  icon in the taskbar functions differently when you click, double-click, or right-click the icon.

### **Clicking the Dell Support Icon**

Click or right-click the  icon to perform the following tasks:

- Check your computing environment.
- View the Dell Support Utility settings.
- Access the help file for the Dell Support Utility.
- View frequently asked questions.
- Learn more about the Dell Support Utility.
- Turn off the Dell Support Utility.

### **Double-Clicking the Dell Support Icon**

Double-click the  icon to manually check your computing environment, view frequently asked questions, access the help file for the Dell Support Utility, and view Dell Support settings.

For more information about the Dell Support Utility, click the question mark (?) at the top of the **Dell™ Support** screen.

# Reinstalling Software

## Drivers

### Identifying Drivers

If you experience a problem with any device, identify whether the driver is the source of your problem and, if necessary, update the driver.

*Windows XP:*

- 1 Click **Start**→**Control Panel**.
- 2 Under **Pick a Category**, click **Performance and Maintenance**, and click **System**.
- 3 In the **System Properties** window, click the **Hardware** tab, and click **Device Manager**.

*Windows Vista:*

- 1 Click the Windows Vista Start button™ , and right-click **Computer**.
- 2 Click **Properties**→**Device Manager**.



**NOTE:** The **User Account Control** window may appear. If you are an administrator on the computer, click **Continue**; otherwise, contact your administrator to continue.

Scroll down the list to see if any device has an exclamation point (a yellow circle with a [!]) on the device icon.

If an exclamation point is next to the device name, you may need to reinstall the driver or install a new driver (see "Reinstalling Drivers and Utilities" on page 47).

### Reinstalling Drivers and Utilities





**NOTICE:** The Dell Support website at [support.dell.com](http://support.dell.com) and your *Drivers and Utilities* media provide approved drivers for Dell™ computers. If you install drivers obtained from other sources, your computer might not work correctly.

## Returning to a Previous Device Driver Version

*Windows XP:*

- 1 Click **Start**→**My Computer**→**Properties**→**Hardware**→**Device Manager**.
- 2 Right-click the device for which the new driver was installed and click **Properties**.
- 3 Click the **Drivers** tab→**Roll Back Driver**.

*Windows Vista:*

- 1 Click the Windows Vista Start button , and right-click **Computer**.
- 2 Click **Properties**→**Device Manager**.  
 **NOTE:** The **User Account Control** window may appear. If you are an administrator on the computer, click **Continue**; otherwise, contact your administrator to enter the Device Manager.
- 3 Right-click the device for which the new driver was installed and click **Properties**.
- 4 Click the **Drivers** tab→**Roll Back Driver**.

If Device Driver Rollback does not resolve the problem, then use System Restore (see "Restoring Your Operating System" on page 50) to return your computer to the operating state that existed before you installed the new driver.

## Using the Drivers and Utilities Media

If using Device Driver Rollback or System Restore (see "Restoring Your Operating System" on page 50) does not resolve the problem, reinstall the driver from your *Drivers and Utilities* media.

- 1 With the Windows desktop displayed, insert your *Drivers and Utilities* media. If this is your first time to use the *Drivers and Utilities* media, go to step 2. If not, go to step 5.
- 2 When the *Drivers and Utilities* media installation program starts, follow the prompts on the screen.

 **NOTE:** In most cases, the *Drivers and Utilities* program starts running automatically. If it does not, start Windows Explorer, click your media drive directory to display the media contents, and then double-click the **autorcd.exe** file.



- 3 When the **InstallShield Wizard Complete** window appears, remove the *Drivers and Utilities* media and click **Finish** to restart the computer.
- 4 When you see the Windows desktop, reinsert the *Drivers and Utilities* media.
- 5 At the **Welcome Dell System Owner** screen, click **Next**.



**NOTE:** The *Drivers and Utilities* program displays drivers only for hardware that came installed in your computer. If you installed additional hardware, the drivers for the new hardware might not be displayed. If those drivers are not displayed, exit the *Drivers and Utilities* program. For drivers information, see the documentation that came with the device.

A message stating that the *Drivers and Utilities* media is detecting hardware in your computer appears.

The drivers that are used by your computer are automatically displayed in the **My Drivers—The ResourceCD has identified these components in your system** window.

- 6 Click the driver that you want to reinstall and follow the instructions on the screen.

If a particular driver is not listed, then that driver is not required by your operating system.

### Manually Reinstalling Drivers

After extracting the driver files to your hard drive as described in the previous section:

- 1 Click the Windows Vista Start button , and right-click **Computer**.
- 2 Click **Properties**→**Device Manager**.



**NOTE:** The **User Account Control** window may appear. If you are an administrator on the computer, click **Continue**; otherwise, contact your administrator to enter the **Device Manager**.

- 3 Double-click the type of device for which you are installing the driver (for example, **Audio** or **Video**).
- 4 Double-click the name of the device for which you are installing the driver.
- 5 Click the **Driver** tab→**Update Driver**→**Browse my computer for driver software**.

- 6 Click **Browse** and browse to the location to which you previously copied the driver files.
- 7 When the name of the appropriate driver appears, click the name of the driver→**OK**→**Next**.
- 8 Click **Finish** and restart your computer.

## Restoring Your Operating System

You can restore your operating system in the following ways:

- Microsoft Windows System Restore returns your computer to an earlier operating state without affecting data files. Use System Restore as the first solution for restoring your operating system and preserving data files.
- Dell Factory Image Restore (available in Windows Vista) returns your hard drive to the operating state it was in when you purchased the computer. The program permanently deletes all data on the hard drive and removes any programs installed after you received the computer. Use Dell Factory Image Restore only if System Restore did not resolve your operating system problem.
- If you received the *Operating System* media with your computer, you can use it to restore your operating system. However, using the *Operating System* media also deletes all data on the hard drive. Use the media *only* if System Restore did not resolve your operating system problem.

### Using Microsoft® Windows® System Restore

The Windows operating systems provide a System Restore option that allows you to return your computer to an earlier operating state (without affecting data files) if changes to the hardware, software, or other system settings have left the computer in an undesirable operating state. Any changes that System Restore makes to your computer are completely reversible.



**NOTICE:** Make regular backups of your data files. System Restore does not monitor your data files or recover them.





**NOTE:** The procedures in this document were written for the Windows default view, so they may not apply if you set your Dell™ computer to the Windows Classic view.



**NOTE:** Set your Dell™ computer to the Windows Classic view.

## Starting System Restore

*Windows Vista:*

- 1 Click Start .
- 2 In the Start Search box, type System Restore and press <Enter>.   
 **NOTE:** The User Account Control window may appear. If you are an administrator on the computer, click **Continue**; otherwise, contact your administrator to continue the desired action.
- 3 Click Next and follow the remaining prompts on the screen.

In the event that System Restore did not resolve the issue, you may undo the last system restore (see "Undoing the Last System Restore" on page 51).

*Windows XP:*

-  **NOTICE:** Before you restore the computer to an earlier operating state, save and close any open files and exit any open programs. Do not alter, open, or delete any files or programs until the system restoration is complete.
- 1 Click Start → All Programs → Accessories → System Tools → System Restore.
- 2 Click either **Restore my computer to an earlier time** or **Create a restore point**.
- 3 Click Next and follow the remaining on-screen prompts.

## Undoing the Last System Restore

-  **NOTICE:** Before you undo the last system restore, save and close all open files and exit any open programs. Do not alter, open, or delete any files or programs until the system restoration is complete.

*Windows Vista:*

- 1 Click Start .
- 2 In the Start Search box, type System Restore and press <Enter>.
- 3 Click **Undo my last restoration** and click Next.

*Windows XP:*

- 1 Click Start → All Programs → Accessories → System Tools → System Restore.
- 2 Click **Undo my last restoration** and click Next.

## Enabling System Restore



**NOTE:** Windows Vista does not disable System Restore; regardless of low disk space. Therefore, the steps below apply only to Windows XP.

If you reinstall Windows XP with less than 200 MB of free hard-disk space available, System Restore is automatically disabled.

To see if System Restore is enabled:

- 1 Click **Start**→**Control Panel**→**Performance and Maintenance**→**System**.
- 2 Click the **System Restore** tab and ensure that **Turn off System Restore** is unchecked.

## Using Dell™ Factory Image Restore



**NOTICE:** Using Dell Factory Image Restore permanently deletes all data on the hard drive and removes any programs or drivers installed after you received your computer. If possible, back up the data before using these options. Use Dell Factory Image Restore only if System Restore did not resolve your operating system problem.



**NOTE:** Dell Factory Image Restore may not be available in certain countries or on certain computers.

Use Dell Factory Image Restore (Windows Vista) only as the last method to restore your operating system. These options restore your hard drive to the operating state it was in when you purchased the computer. Any programs or files added since you received your computer—including data files—are permanently deleted from the hard drive. Data files include documents, spreadsheets, e-mail messages, digital photos, music files, and so on. If possible, back up all data before using Factory Image Restore.

### Dell Factory Image Restore (Windows Vista Only)

- 1 Turn on the computer. When the Dell logo appears, press <F8> several times to access the Vista Advanced Boot Options Window.
- 2 Select **Repair Your Computer**.  
The System Recovery Options window appears.
- 3 Select a keyboard layout and click **Next**.

4 To access the recovery options, log on as a local user. To access the command prompt, type `administrator` in the User name field, then click **OK**.

5 Click **Dell Factory Image Restore**.



**NOTE:** Depending upon your configuration, you may need to select **Dell Factory Tools**, then **Dell Factory Image Restore**.

6 On the Dell Factory Image Restore welcome screen, click **Next**.

The Confirm Data Deletion screen appears.



**NOTICE:** If you do not want to proceed with Factory Image Restore, click **Cancel**.

7 Click the checkbox to confirm that you want to continue reformatting the hard drive and restoring the system software to the factory condition, then click **Next**.

The restore process begins and may take 5 or more minutes to complete. A message appears when the operating system and factory-installed applications have been restored to factory condition.

8 Click **Finish** to restart the computer.

## Using the Operating System Media

### Before you Begin

If you are considering reinstalling the Windows operating system to correct a problem with a newly installed driver, first try using Windows Device Driver Rollback. See "Returning to a Previous Device Driver Version" on page 48. If Device Driver Rollback does not resolve the problem, use Microsoft Windows System Restore to return your operating system to the operating state it was in before you installed the new device driver. See "Using Microsoft® Windows® System Restore" on page 50.



**NOTICE:** Before performing the installation, back up all data files on your primary hard drive. For conventional hard drive configurations, the primary hard drive is the first drive detected by the computer.

To reinstall Windows, you need the Dell™ *Operating System* media and the Dell *Drivers and Utilities* media.

 **NOTE:** The Dell *Drivers and Utilities* media contains drivers that were installed during the assembly of the computer. Use the Dell *Drivers and Utilities* media to load any required drivers. Depending on the region from which you ordered your computer, or whether you requested the media, the Dell *Drivers and Utilities* media and Dell *Operating System* media may not ship with your computer.

## Reinstalling Windows

The reinstallation process can take 1 to 2 hours to complete. After you reinstall the operating system, you must also reinstall the device drivers, virus protection program, and other software.

- 1 Save and close any open files and exit any open programs.
- 2 Insert the *Operating System* media.
- 3 If the **Install Windows** message appears, click **Exit**.
- 4 Restart the computer.

When the DELL logo appears, press <F12> immediately.

 **NOTE:** If you wait too long and the operating system logo appears, continue to wait until you see the Microsoft® Windows® desktop; then, shut down your computer and try again.

 **NOTE:** The next steps change the boot sequence for one time only. On the next start-up, the computer boots according to the devices specified in the system setup program.

- 5 When the boot device list appears, highlight **CD/DVD/CD-RW Drive** and press <Enter>.
- 6 Press any key to **Boot from CD-ROM**, and follow the instructions on the screen to complete the installation.

## Windows Vista: Dell Factory Image Restore

- 1 Turn on the computer. When the Dell logo appears, press <F8> several times to access the Vista Advanced Boot Options Window.
- 2 Select **Repair Your Computer**.  
The System Recovery Options window appears.
- 3 Select a keyboard layout and click **Next**.

4 To access the recovery options, log on as a local user. To access the command prompt, type `administrator` in the User name field, then click **OK**.

5 Click **Dell Factory Image Restore**.



**NOTE:** Depending upon your configuration, you may need to select **Dell Factory Tools**, then **Dell Factory Image Restore**.

The Dell Factory Image Restore welcome screen appears.

6 Click **Next**.

The Confirm Data Deletion screen appears.



**NOTICE:** If you do not want to proceed with Factory Image Restore, click **Cancel**.

7 Click the checkbox to confirm that you want to continue reformatting the hard drive and restoring the system software to the factory condition, then click **Next**.

The restore process begins and may take five or more minutes to complete. A message appears when the operating system and factory-installed applications have been restored to factory condition.

8 Click **Finish** to restart the computer.

## Using the Operating System Media

### Before you Begin

If you are considering reinstalling the Windows operating system to correct a problem with a newly installed driver, first try using Windows Device Driver Rollback. See "Returning to a Previous Device Driver Version" on page 48. If Device Driver Rollback does not resolve the problem, then use Microsoft Windows System Restore to return your operating system to the operating state it was in before you installed the new device driver.



**NOTICE:** Before performing the installation, back up all data files on your primary hard drive. For conventional hard drive configurations, the primary hard drive is the first drive detected by the computer.

To reinstall Windows, you need the Dell™ *Operating System* media and the Dell *Drivers and Utilities* media.

 **NOTE:** The *Drivers and Utilities* media contains drivers that were installed during the assembly of the computer. Use the Dell *Drivers and Utilities* media to load any required drivers. Depending on the region from which you ordered your computer, or whether you requested the media, the Dell *Drivers and Utilities* media and *Operating System* media may not ship with your computer.

## Reinstalling Windows

The reinstallation process can take 1 to 2 hours to complete. After you reinstall the operating system, you must also reinstall the device drivers, virus protection program, and other software.

- 1 Save and close any open files and exit any open programs.
- 2 Insert the *Operating System* media.
- 3 If the `Install Windows` message appears, click **Exit**.
- 4 Restart the computer.

When the DELL logo appears, press <F12> immediately.

 **NOTE:** If you wait too long and the operating system logo appears, continue to wait until you see the Microsoft® Windows® desktop; then, shut down your computer and try again.

 **NOTE:** The next steps change the boot sequence for one time only. On the next start-up, the computer boots according to the devices specified in the system setup program.

- 5 When the boot device list appears, highlight `CD/DVD/CD-RW Drive` and press <Enter>.
- 6 Press any key to **Boot from CD-ROM**, and follow the instructions on the screen to complete the installation.



# Finding Information

 **NOTE:** Some features or media may be optional and may not ship with your computer. Some features or media may not be available in certain countries.

 **NOTE:** Additional information may ship with your computer.

Document/Media/Label	Contents
<p><b>Service Tag/Express Service Code Label</b></p> <p>The Service Tag/Express Service Code is located on your computer.</p>	<ul style="list-style-type: none"> <li>• Use the Service Tag to identify your computer when you use <a href="http://support.dell.com">support.dell.com</a> or contact support.</li> <li>• Enter the Express Service Code to direct your call when contacting support</li> </ul>
<p><b>Drivers and Utilities Media</b></p> <p>The <i>Drivers and Utilities</i> media is a CD or DVD that may have shipped with your computer.</p>	<ul style="list-style-type: none"> <li>• A diagnostic program for your computer</li> <li>• Drivers for your computer</li> </ul> <p><b>NOTE:</b> Drivers and documentation updates can be found at <a href="http://support.dell.com">support.dell.com</a>.</p> <ul style="list-style-type: none"> <li>• Notebook System Software (NSS)</li> <li>• Readme files</li> </ul> <p><b>NOTE:</b> Readme files may be included on your media to provide last-minute updates about technical changes to your computer or advanced technical-reference material for technicians or experienced users.</p>
<p><b>Operating System Media</b></p> <p>The <i>Operating System</i> media is a CD or DVD that may have shipped with your computer.</p>	<p>Reinstall your operating system.</p>

<b>Document/Media/Label</b>	<b>Contents</b>
<p><b>Safety, Regulatory, Warranty, and Support Documentation</b></p> <p>This type of information may have shipped with your computer. For additional regulatory information, see the Regulatory Compliance Homepage on <a href="http://www.dell.com">www.dell.com</a> at the following location: <a href="http://www.dell.com/regulatory_compliance">www.dell.com/regulatory_compliance</a>.</p>	<ul style="list-style-type: none"> <li>• Warranty information</li> <li>• Terms and Conditions (U.S. only)</li> <li>• Safety instructions</li> <li>• Regulatory information</li> <li>• Ergonomics information</li> <li>• End User License Agreement</li> </ul>
<p><b>Service Manual</b></p> <p>The <i>Service Manual</i> for your computer can be found at <a href="http://support.dell.com">support.dell.com</a>.</p>	<ul style="list-style-type: none"> <li>• How to remove and replace parts</li> <li>• How to configure system settings</li> <li>• How to troubleshoot and solve problems</li> </ul>
<p><b>Dell Technology Guide</b></p> <p>The <i>Dell Technology Guide</i> is available at <a href="http://support.dell.com">support.dell.com</a>.</p>	<ul style="list-style-type: none"> <li>• About your operating system</li> <li>• Using and maintaining peripherals</li> <li>• Understanding technologies such as RAID, Internet, Bluetooth® wireless technology, e-mail, and so on.</li> </ul>
<p><b>Microsoft Windows License Label</b></p> <p>Your Microsoft Windows License is located on your computer.</p>	<ul style="list-style-type: none"> <li>• Provides your operating system product key.</li> </ul>

# Getting Help

## Obtaining Assistance

 **CAUTION:** If you need to remove the computer cover, first disconnect the computer power and modem cables from all electrical outlets.

If you experience a problem with your computer, you can complete the following steps to diagnose and troubleshoot the problem:

- 1 See "Solving Problems" on page 40 for information and procedures that pertain to the problem your computer is experiencing.
- 2 See "Dell Diagnostics" on page 38 for procedures on how to run Dell™ Diagnostics.
- 3 Fill out the "Diagnostics Checklist" on page 63.
- 4 Use Dell's extensive suite of online services available at Dell Support ([support.dell.com](http://support.dell.com)) for help with installation and troubleshooting procedures. See "Online Services" on page 60 for a more extensive list of Dell Support online.
- 5 If the preceding steps have not resolved the problem, see "Contacting Dell" on page 64.

 **NOTE:** Call Dell Support from a telephone near or at the computer so that the support staff can assist you with any necessary procedures.

 **NOTE:** Dell's Express Service Code system may not be available in all countries.

When prompted by Dell's automated telephone system, enter your Express Service Code to route the call directly to the proper support personnel. If you do not have an Express Service Code, open the **Dell Accessories** folder, double-click the **Express Service Code** icon, and follow the directions.

For instructions on using the Dell Support, see "Technical Support and Customer Service" on page 60.

 **NOTE:** Some of the following services are not always available in all locations outside the continental U.S. Call your local Dell representative for information on availability.

## Technical Support and Customer Service

Dell's support service is available to answer your questions about Dell™ hardware. Our support staff uses computer-based diagnostics to provide fast, accurate answers.

To contact Dell's support service, see "Before You Call" on page 62, and then see the contact information for your region or go to [support.dell.com](http://support.dell.com).

### DellConnect™

DellConnect is a simple online access tool that allows a Dell service and support associate to access your computer through a broadband connection, diagnose your problem and repair it all under your supervision. For more information, go to [support.dell.com](http://support.dell.com) and click **DellConnect**.

### Online Services

You can learn about Dell products and services on the following websites:

[www.dell.com](http://www.dell.com)

[www.dell.com/ap](http://www.dell.com/ap) (Asian/Pacific countries only)

[www.dell.com/jp](http://www.dell.com/jp) (Japan only)

[www.euro.dell.com](http://www.euro.dell.com) (Europe only)

[www.dell.com/la](http://www.dell.com/la) (Latin American and Caribbean countries)

[www.dell.ca](http://www.dell.ca) (Canada only)

You can access Dell Support through the following websites and e-mail addresses:

- Dell Support websites

[support.dell.com](http://support.dell.com)

[support.jp.dell.com](http://support.jp.dell.com) (Japan only)

[support.euro.dell.com](http://support.euro.dell.com) (Europe only)

- Dell Support e-mail addresses

[mobile\\_support@us.dell.com](mailto:mobile_support@us.dell.com)

[support@us.dell.com](mailto:support@us.dell.com)

[la-techsupport@dell.com](mailto:la-techsupport@dell.com) (Latin America and Caribbean countries only)

[apsupport@dell.com](mailto:apsupport@dell.com) (Asian/Pacific countries only)

- Dell Marketing and Sales e-mail addresses  
apmarketing@dell.com (Asian/Pacific countries only)  
sales\_canada@dell.com (Canada only)
- Anonymous file transfer protocol (FTP)  
ftp.dell.com  
Log in as user: `anonymous`, and use your e-mail address as your password.

## **AutoTech Service**

Dell's automated support service—AutoTech—provides recorded answers to the questions most frequently asked by Dell customers about their portable and desktop computers.

When you call AutoTech, use your touch-tone telephone to select the subjects that correspond to your questions. For the telephone number to call for your region, see "Contacting Dell" on page 64.

## **Automated Order-Status Service**

To check on the status of any Dell products that you have ordered, you can go to [support.dell.com](http://support.dell.com), or you can call the automated order-status service. A recording prompts you for the information needed to locate and report on your order. For the telephone number to call for your region, see "Contacting Dell" on page 64.

## **Problems With Your Order**

If you have a problem with your order, such as missing parts, wrong parts, or incorrect billing, contact Dell for customer assistance. Have your invoice or packing slip handy when you call. For the telephone number to call for your region, see "Contacting Dell" on page 64.

## **Product Information**

If you need information about additional products available from Dell, or if you would like to place an order, visit the Dell website at [www.dell.com](http://www.dell.com). For the telephone number to call for your region or to speak to a sales specialist, see "Contacting Dell" on page 64.

# Returning Items for Warranty Repair or Credit

Prepare all items being returned, whether for repair or credit, as follows:

- 1 Call Dell to obtain a Return Material Authorization Number, and write it clearly and prominently on the outside of the box.  
For the telephone number to call for your region, see "Contacting Dell" on page 64. Include a copy of the invoice and a letter describing the reason for the return.
- 2 Include a copy of the Diagnostics Checklist (see "Diagnostics Checklist" on page 63), indicating the tests that you have run and any error messages reported by the Dell Diagnostics (see "Contacting Dell" on page 64).
- 3 Include any accessories that belong with the item(s) being returned (power cables, software floppy disks, guides, and so on) if the return is for credit.
- 4 Pack the equipment to be returned in the original (or equivalent) packing materials.

You are responsible for paying shipping expenses. You are also responsible for insuring any product returned, and you assume the risk of loss during shipment to Dell. Collect On Delivery (C.O.D.) packages are not accepted.

Returns that are missing any of the preceding requirements will be refused at Dell's receiving dock and returned to you.

## Before You Call



**NOTE:** Have your Express Service Code ready when you call. The code helps Dell's automated-support telephone system direct your call more efficiently. You may also be asked for your Service Tag (located on the back or bottom of your computer).

Remember to fill out the Diagnostics Checklist (see "Diagnostics Checklist" on page 63). If possible, turn on your computer before you call Dell for assistance and call from a telephone at or near the computer. You may be asked to type some commands at the keyboard, relay detailed information during operations, or try other troubleshooting steps possible only at the computer itself. Ensure that the computer documentation is available.



**CAUTION:** Before working inside your computer, follow the safety instructions in your *Product Information Guide*.

## **Diagnostics Checklist**

Name:

Date:

Address:

Phone number:

Service Tag (bar code on the back or bottom of the computer):

Express Service Code:

Return Material Authorization Number (if provided by Dell support technician):

Operating system and version:

Devices:

Expansion cards:

Are you connected to a network? Yes No

Network, version, and network adapter:

Programs and versions:

See your operating system documentation to determine the contents of the system's start-up files. If the computer is connected to a printer, print each file. Otherwise, record the contents of each file before calling Dell.

Error message, beep code, or diagnostic code:

Description of problem and troubleshooting procedures you performed:

# Contacting Dell

For customers in the United States, call 800-WWW-DELL (800-999-3355).



**NOTE:** If you do not have an active Internet connection, you can find contact information on your purchase invoice, packing slip, bill, or Dell product catalog.

Dell provides several online and telephone-based support and service options. Availability varies by country and product, and some services may not be available in your area. To contact Dell for sales, technical support, or customer service issues:

- 1 Visit [support.dell.com](http://support.dell.com).
- 2 Verify your country or region in the **Choose A Country/Region** drop-down menu at the bottom of the page.
- 3 Click **Contact Us** on the left side of the page.
- 4 Select the appropriate service or support link based on your need.
- 5 Choose the method of contacting Dell that is convenient for you.



# Index

## B

beep codes, 31

## C

CDs/DVDs

operating system, 57

computer

beep codes, 31

crashes, 43-44

stops responding, 43

contacting Dell, 64

## D

Dell

contacting, 64

Factory Image Restore, 52

Dell Diagnostics, 38

Dell Factory Image Restore, 52

Dell Technology Guide, 58

DellConnect, 60

diagnostics

beep codes, 31

Dell, 38

documentation

Dell Technology Guide, 58

Service Manual, 58

drivers, 47

identifying, 47

reinstalling, 47

Drivers and Utilities media

about, 48

Dell Diagnostics, 38

## E

ergonomics information, 58

error messages, 33

beep codes, 31

## F

Factory Image Restore, 52, 54

Files and Settings Transfer  
Wizard, 15

## H

hardware

beep codes, 31

Dell Diagnostics, 38

## I

- Internet connection
  - about, 13
  - options, 13
  - setting up, 14

## M

- memory
  - problems, 42
- messages
  - error, 33

## O

- operating system
  - Dell Factory Image Restore, 52
  - media, 53, 55
  - reinstalling, 57
  - System Restore, 50
- Operating System CD/DVD, 57

## P

- phone numbers, 64
- power
  - problems, 41
- power light, 45
  - conditions, 41
- printer
  - connecting, 13
  - setting up, 13

## problems

- beep codes, 31
- blue screen, 44
- computer crashes, 43-44
- computer stops responding, 43
- Dell Diagnostics, 38
- error messages, 33
- general, 43
- memory, 42
- power, 41
- power light conditions, 41
- program crashes, 43
- program stops responding, 43
- programs and Windows
  - compatibility, 44
- restore to previous state, 50
- software, 43-44

## S

- software
  - problems, 43-44
- specifications, 19
- Starting the Dell Diagnostics
  - From the Drivers and Utilities media, 40
- Starting the Dell Diagnostics
  - From Your Hard Drive, 39
- support
  - contacting Dell, 64
- System Restore, 50
  - enabling, 52

## **T**

- telephone numbers, 64
- transferring information to a new computer, 15
- troubleshooting
  - Dell Diagnostics, 38
  - restore to previous state, 50

## **W**

- Windows Vista
  - Dell Factory Image Restore, 52
  - Program Compatibility wizard, 44
  - System Restore, 50
- Windows XP
  - Device Driver Rollback, 48
  - Files and Settings Transfer Wizard, 15
  - reinstalling, 57
  - System Restore, 50
- wizards
  - Files and Settings Transfer Wizard, 15
  - Program Compatibility wizard, 44



## Free Manuals Download Website

<http://myh66.com>

<http://usermanuals.us>

<http://www.somanuals.com>

<http://www.4manuals.cc>

<http://www.manual-lib.com>

<http://www.404manual.com>

<http://www.luxmanual.com>

<http://aubethermostatmanual.com>

Golf course search by state

<http://golfingnear.com>

Email search by domain

<http://emailbydomain.com>

Auto manuals search

<http://auto.somanuals.com>

TV manuals search

<http://tv.somanuals.com>