KODAK EASYSHARE Digital Frames



Extended user guide P730/P730m/P736

www.kodak.com

For help with your digital frame, www.kodak.com/go/digitalframesupport

Kodak

Eastman Kodak Company

Rochester, New York 14650

© Eastman Kodak Company, 2009

All screen images are simulated.

Kodak, EasyShare, and Perfect Touch are trademarks of Eastman Kodak Company.

P/N 4H6539_en

Front View

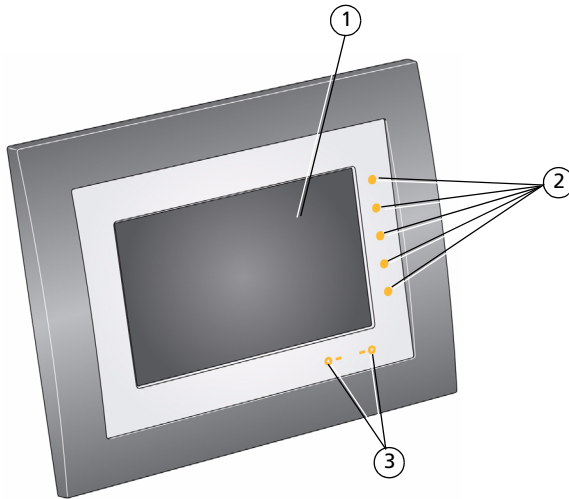

1 LCD screen

Quick Touch Border:

2 Side touch lights—tap only

3 Bottom touch lights—slide between or tap arrows

NOTE: When your hand is within 1 - 3 inches (2.5 - 7.6 cm) of the borders, the lights turn on and indicate where to touch. Tap a light on the right border to see the screen icons.

To use the Quick Touch Border, see [page 4](#).

Back/side View

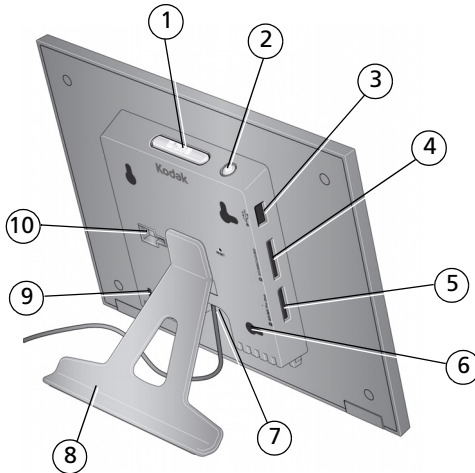

1 Mode button 

2 Power button 

3 USB connector

4 Memory card slot - SD/MMC/xD/MS

5 Memory card slot - MS/MS Pro Duo

6 Wall mounting holes (3) - P730, P730m only

7 DC In 5V power connector 

8 Frame stand (see [page 1](#))

9 Security lock slot

10 Stand attachment slot

Table of contents

1 Getting started	1
Setting up your frame.....	1
Navigating using the Quick Touch Border	4
Setting your language	6
Setting the clock, date, and timer	6
Inserting a memory card.....	8
Connecting a USB device.....	9
2 Viewing pictures	10
Enjoying your pictures immediately!	10
Viewing your pictures.....	11
Changing viewing modes	12
Viewing pictures in collage mode	13
Viewing thumbnails	15
Viewing a single picture	16
Saving a default play location.....	16
3 Doing more with your frame	17
Accessing menu options.....	17
Selecting multiple pictures.....	19
Copying on your frame	20
Rotating pictures.....	21
Deleting pictures.....	21
Creating and playing a multimedia slide show	22
4 Changing settings and more	25
Changing frame settings	25
Settings menus	25
Changing the display picture order	28
Upgrading your firmware (recommended).....	29
Changing your frame orientation	29
Hanging your frame on the wall (P730/P730m only)	31

Maintaining your frame	31
Learning more about your frame.....	31
5 Troubleshooting and support	32
Picture frame problems	32
Screen messages.....	34
6 Appendix	36
Digital frame specifications.....	36
Important safety instructions	38
Upgrading your software and firmware.....	38
Additional care and maintenance	39
Limited warranty.....	39
Regulatory compliance and advisory	41

1

Getting started



Welcome to your KODAK EASYSHARE Digital Frame. Viewing and sharing your pictures couldn't be simpler!

Setting up your frame

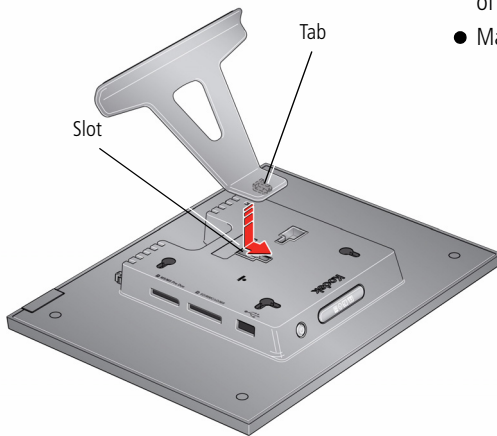
Attaching the stand



- Snap the stand into the slot in the back of the frame.
- Make sure the tab is secure in the slot.

Your frame displays pictures in landscape orientation . To change to portrait orientation , see [page 29](#).

Attaching the power cable



CAUTION:

Do not use this power cable with other devices, including digital cameras.

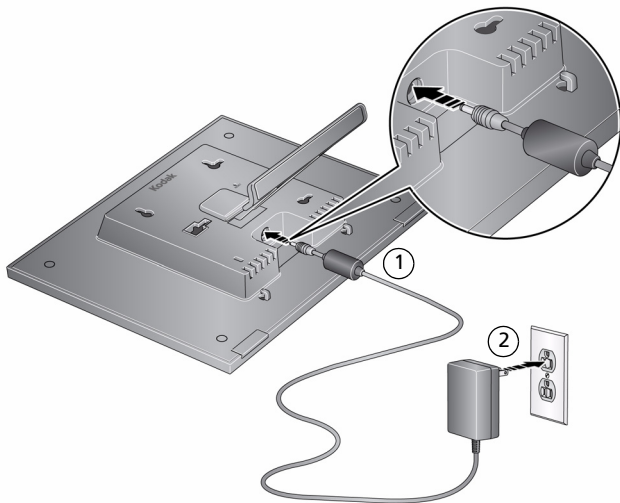

Your power cable may look different from the one pictured. Use the plug that accommodates your type of power outlet.

Turning your frame on and off

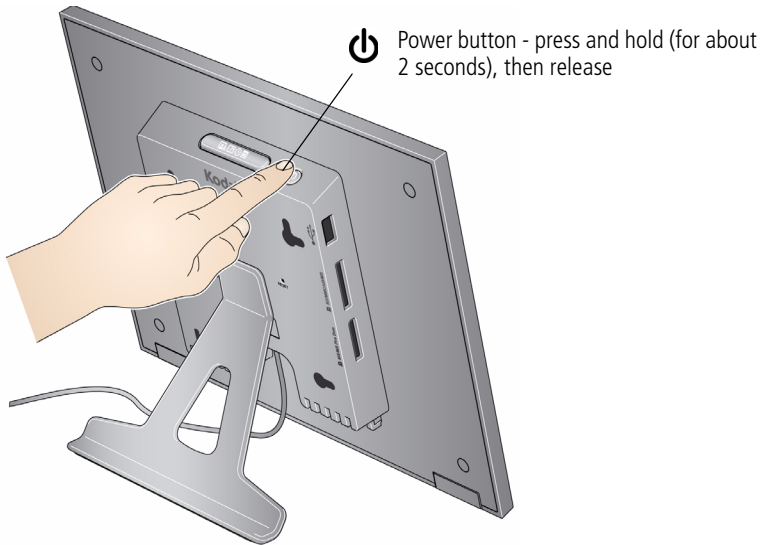

With the power cable still plugged in, your frame retains information (like the time) if you turn it off.

Navigating using the Quick Touch Border

IMPORTANT: *The display screen is not touch-sensitive. Do not touch it. Instead, tap the lights on the right and bottom borders.*

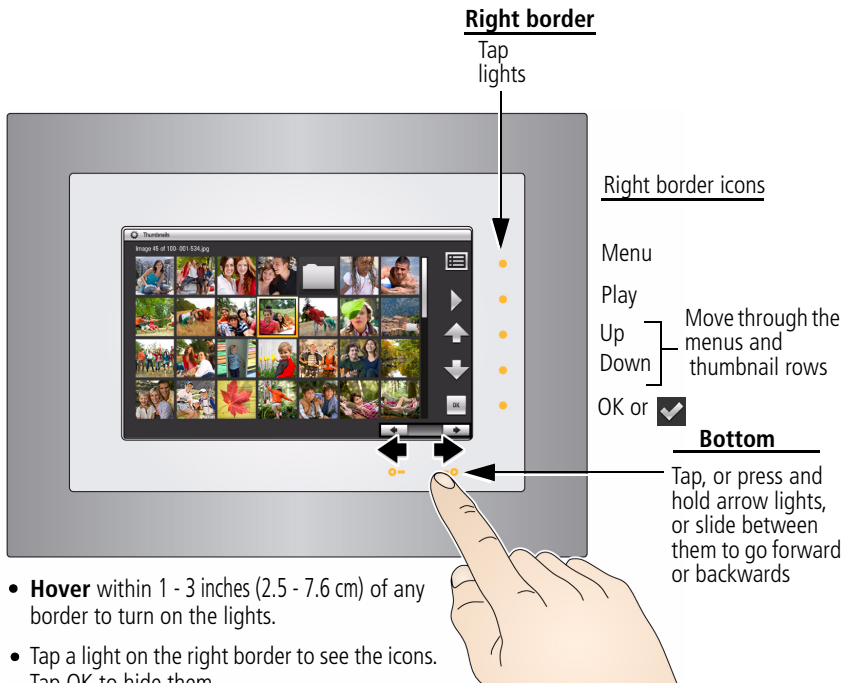

- **Hover** within 1 - 3 inches (2.5 - 7.6 cm) of any border to turn on the lights.
- Tap a light on the right border to see the icons. Tap OK to hide them.





CAUTION:

Only use your finger on the borders. Borders do not react to sharp or metal objects—and they may damage the border or screen.

Tapping on the right border



- Tap the light next to an icon to select it. Icons change color when they are selected.
- Tap the lights next to the up/down arrows  to move up or down through menus or rows of thumbnails.
- Tap the light next to OK or  (see [page 19](#)) to select the highlighted item.

Tapping and sliding on the bottom border

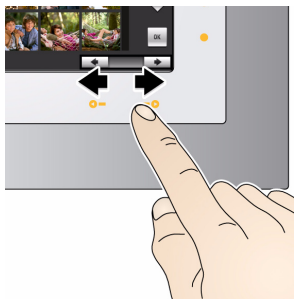

- Tap the left/right arrow lights to change the values for your settings (see [Changing frame settings, page 25](#)), or to move the highlight one picture, menu, or item at a time.
- Slide between the arrow lights to scroll through pictures: like turning the pages of a book, slide left ← to go forward; slide right → to go back.
- For faster scrolling through large numbers of thumbnail pictures, press and hold an arrow light (3 seconds).

What 'tap' and 'slide' mean in this guide

Only the lights on the right and bottom Quick Touch Border are touch-sensitive. The screen and other borders are not.

In this manual, 'tap' or 'slide' means tap or slide on the light next to or under an icon or button. It does not mean 'tap the icon on the screen'.



For example: 'Tap  (Menu)' means 'Tap the light on the Quick Touch Border next to the  (Menu) icon'.

Setting your language

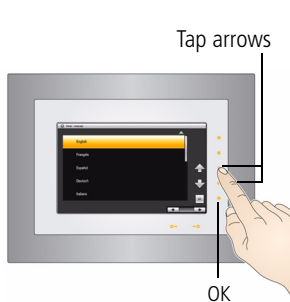
The language screen appears the first time you turn on your frame.



- Tap the light next to an up/down arrow  to highlight your language, then tap the OK light. To change the language at a later time:

- Tap  (Menu). Tap the down arrow to highlight  (Settings); tap the down arrow to highlight Language, then tap OK.

The language screen appears.



- Tap an up/down arrow  to highlight your language, then tap OK.

To use the Quick Touch Border, see [page 4](#).

Setting the clock, date, and timer

If this is the first time you turned on your frame, the Clock and Date screen appears automatically after you select your language. Follow steps 3, 4, and 6 below.

To change or set the clock, date, and automatic timer later, follow all the steps below.

- 1 Tap  (Menu), then tap the down arrow  to highlight  (Settings). Tap OK.
- 2 Tap the down arrow to highlight Clock and Date, then tap OK.



Slide between the arrow lights.

Press and hold to move quickly through the time and date settings.

3 Set the clock.

Tap the down arrow  to highlight Clock, then slide or tap between the left/right arrow lights to select the current time (based on a 24-hour clock).

4 Set the date.

Tap the down arrow  to highlight Year/Month/Day, then slide or tap between the left/right arrow lights to select the current date (three separate settings).

5 Set your automatic on and off times.

Specify the times you want your frame to automatically turn on and off.

NOTE: Make sure the on time is earlier than the off time.

- a Tap the down arrow  to highlight Auto Off Auto On, then tap OK to change the option to Enabled.
- b Tap the down arrow to highlight Turn Frame On At, then slide or tap between the left/right arrow lights to select the On time (based on a 24-hour clock).
- c Tap the down arrow to highlight Turn Frame Off At, then slide or tap between the left/right arrow lights to select the Off time (based on a 24-hour clock).

6 Tap OK to save your selections.

If your frame loses power (for more than 12 hours), the clock time returns to the factory setting and the automatic on/off times, if set, are disabled. To reset the clock and re-enable your on/off times, see [Resetting the clock after losing power, page 33](#).

Inserting a memory card



CAUTION:

Do not insert an MS Pro Duo card in the top slot. It could get stuck and damage the card or your frame.

- To insert a card, push it firmly into the slot until it clicks and stops
- To remove a card, pull it out of the slot.



Top card slot:

SD (SECURE DIGITAL)
MMC (MULTIMEDIA Card)
xD
MS (MEMORY STICK)

Bottom card slot:

MS/MS Pro Duo (MEMORY STICK)

Connecting a USB device



Supported USB devices include a flash drive, card reader, hard drive, etc.

USB devices and cables are sold separately.

2

Viewing pictures

View pictures from your frame's internal memory or any connected picture source (memory card, USB device).

Enjoying your pictures immediately!

To view your pictures or play a slide show, insert a memory card or other USB device (see [page 8](#)). Your pictures play automatically.







NOTE: Your frame may have pre-loaded pictures, which start playing if you do not insert a memory card or USB device with your own pictures.

You cannot delete the pre-loaded pictures.

Viewing your pictures

View your pictures from the frame's internal memory or any connected picture source.



- 1 Tap  (Menu), then tap  (Pictures).
All connected sources and internal memory are listed.
- 2 Tap an up/down arrow  to highlight a picture source, then:
 - Tap  (Play) to start a slide show of the pictures in the highlighted source.
 - Or, tap OK to view thumbnails of the pictures in the highlighted source.

Picture sources:



Default play location—appears when you save a picture source as your automatic go-to location (see [page 16](#)).



Internal memory—the frame's 512 MB internal memory. Copy your pictures into internal memory from a memory card or other device.



Memory card—appears when you insert a card ([page 8](#)). The label and icon indicate the type of card.



USB drive—appears when you insert a USB flash or other type drive ([page 9](#)).

Playback information

- Picture display order:
 - When Shuffle is On (the default setting, [see page 26](#)), pictures play in random order.
 - When Shuffle is Off, pictures play according to your Display Picture Order By setting ([see page 27](#)).

- You can change the slide duration (how long each picture stays on the screen) and transition style between pictures. See [Changing frame settings, page 25](#).
- Pictures play continuously until you: tap a right border light to pause play, turn off the frame, or change viewing modes. Play resumes automatically after 15 seconds or when you tap  (Play).

Changing viewing modes

Press the Mode button to access the four slide show viewing modes on your frame: Pictures, Collage, Clock/picture, and Calendar/picture.

NOTE: If your pictures are cropped, change the frame setting to Fit ([see page 27](#)).

Each time you press the Mode button, the frame advances to the next mode.

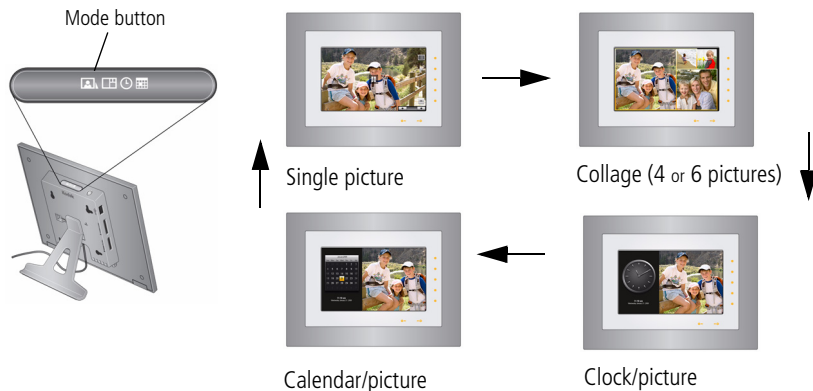

Viewing modes



Pictures (default)—the pictures in your current picture source play one at a time ([see page 11](#)).



Collage—multiple pictures from your current picture source are arranged on the screen, then continue to change according to your playback settings ([page 11](#)).



Clock—a clock with the current time is displayed on one side of the screen, while the pictures in your current picture source play on the other. See [Setting the clock, date, and timer, page 6](#).



Calendar—a calendar with today's date highlighted is displayed on one side of the screen, while the pictures in your current picture source play on the other. See [Setting the clock, date, and timer, page 6](#).

Viewing pictures in collage mode

View a revolving four-picture (or six-picture, P736) slide show. Press the Mode button to play your pictures in collage mode .

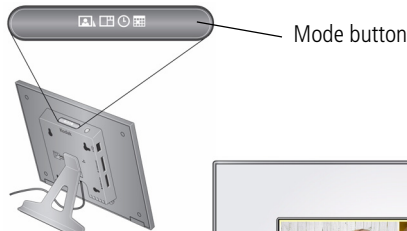



Four-picture collage



Six-picture collage (P736 only)

- Tap a right/left arrow  to highlight a different picture in the collage.
- Tap the right or bottom border to pause play and highlight the current picture.

- While play is paused, tap OK to display the highlighted picture in full screen, single view.
- While play is paused, tap  (Menu) to access the main menu options (see [page 17](#)).
- Tap  (Play) to resume collage play.



NOTE: Multimedia slide shows do not play in collage mode.

Viewing thumbnails



There are two ways to view your pictures as thumbnails:





First, from the picture source list:

- 1 Tap a light on the right border to see the icons, then tap  (Menu).
- 2 Tap  (Pictures).
- 3 Tap an up/down arrow  to select a picture source (see page 11), then tap OK.
Pictures are displayed as thumbnails.

Second, while pictures are playing or from a single view:

- 1 Tap a light on the right border to see the icons, then tap  (Menu).
- 2 Tap  (Thumbnails).
Pictures are displayed as thumbnails.

Tips when viewing thumbnails:

- To move to the previous or next row, tap the up/down arrows on the right Quick Touch Border.
- To move through the thumbnails, tap the arrows or slide your finger left/right along the bottom slider. To move even faster through the thumbnails, touch and hold until the slide control changes (about 3 seconds), then slide.
- To play a folder of images, highlight the folder then tap  (Play).
- To play a slide show, highlight the slide show thumbnail and tap  (Play).

Viewing a single picture





- To view a single, full-screen picture, highlight it in thumbnails view (see [page 15](#)), then tap OK.
- Or, when a slide show is playing, tap a Quick Touch Border (right or bottom). The slide show is paused and the picture in view is displayed. Tap OK to hide the icons.

Saving a default play location

Save the picture source where you usually store your favorite pictures (internal memory, memory card, USB drive, etc.) as your default go-to location.

- 1 While viewing a slide show, tap a Quick Touch Border.

The slide show is paused and the screen icons (with their lights) appear.

- 2 Tap  (Menu), then  (Settings).

- 3 Tap an up/down arrow  to highlight Default Play Location.

- 4 Tap an up/down arrow to highlight an option:

- Yes—to confirm.
- No—to exit the menu.
- Clear my Default Play Location—to delete reference to the currently designated picture source.

The next time you turn on your frame, it will automatically start playing from the same source you were in when you entered the Settings Menu.

The Default Play Location icon  appears in the Pictures list as a picture source (see [page 11](#)).

3

Doing more with your frame

Accessing menu options

Use the Menu button to view and work with your pictures, and change your frame settings (see [page 25](#)).

NOTE: As your hand approaches the frame, lights turn on indicating where to touch on the Quick Touch Border. Tap the right border to see the screen icons.

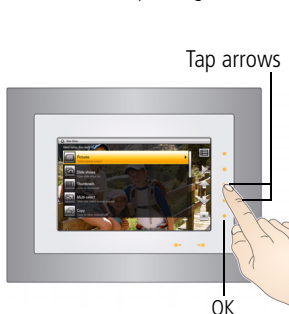

1 Tap  (Menu).

2 Tap an up/down arrow  to highlight a menu option, then tap OK.

IMPORTANT: *You may need to keep tapping the up/down arrows to see a complete list of available options.*

NOTE: Menu options are displayed for one minute after selecting them.

Understanding menu options







Tap OK after highlighting an option	Description
Pictures	View all available picture sources. Start here to play your pictures (see page 11).
Slide shows View your slide show list.	View and play all available multimedia slide shows (see page 22).
Thumbnails	View all pictures in your current picture source as thumbnails (see page 15).

Tap OK after highlighting an option	Description
Multi-select Available from the Thumbnails menu only.	Select multiple pictures to copy, rotate, delete, or play (see page 19).
Select or Deselect All Available from the Multi-select/Thumbnails menu only.	Select or deselect everything in your current picture source (see page 19).
Copy	See Copying on your frame, page 20 .
Rotate	See Rotating pictures, page 21 .
Delete	See Deleting pictures, page 21 .
Settings	Customize how you use your frame and how you view your pictures. See Chapter 4, Changing settings and more .
Exit	Close the Menu and return to the previous screen.

Selecting multiple pictures

Use the multi-select feature to copy, delete, or rotate multiple pictures at once. Or select just the pictures you want to play in a slide show.



- 1 While viewing pictures or thumbnails, tap  (Menu), then tap Multi-Select.
- 2 To find and highlight a picture, tap the arrow lights or slide between them, then tap  (Select).
A check mark appears on the selected picture.
- 3 Continue selecting pictures.
 - Tap the up/down arrows  to move to the previous or next row.
 - To remove a check mark, tap  (Unselect) while the picture is highlighted.
 - To select all pictures at once, tap  (Menu), then tap Select All.
 - To deselect all pictures at once, tap  (Menu), then tap Deselect All.

Copying on your frame

Copy pictures from your current viewing location to other connected devices (see [page 8](#)). For example, copy pictures from a memory card* into your frame's internal memory.

*HINT: Share the digital pictures from your camera or computer—take the memory card out of your camera or computer, then insert it in your frame for easy copying to internal memory. Then share your pictures with friends and family, anywhere!





CAUTION:

Removing a card or disconnecting a device while copying may damage your card, pictures, or device.

- 1 Highlight a picture in thumbnails view (see [page 15](#)) or display it in single view (see [page 16](#)).

To select multiple pictures, see [page 19](#).

- 2 Tap  (Menu).

- 3 Tap the down arrow  to highlight Copy , then tap OK

- 4 Tap an up/down arrow  to highlight the copy-to destination, then tap OK.

The picture is copied.





- 5 Tap OK to dismiss the screen.

Notes on copying to internal memory

When you copy pictures into the frame's internal memory, the copies are automatically resized to a lower resolution (smaller size). Full resolution is unnecessary for viewing and quickly fills up the internal memory.

To copy pictures at full resolution, turn off the automatic resizing feature in the Settings → Automatic resizing menu (see [Settings menus, page 25](#)).

Rotating pictures



- 1 Highlight a picture in thumbnails view (see [page 15](#)) or display it in single view (see [page 16](#)).
To select multiple pictures, see [page 19](#).
- 2 Tap  (Menu).
- 3 Tap the down arrow  to highlight Rotate , then tap OK
- 4 Tap an up/down arrow  to highlight the direction and degree of rotation, then tap OK.
Highlight Exit and tap OK to return to the picture without rotating it.

Deleting pictures



CAUTION:

Removing a card or disconnecting a device while deleting may damage your card, pictures, or device.

- 1 Highlight a picture in thumbnails view (see [page 15](#)) or display it in single view (see [page 16](#)).
To select multiple pictures, see [page 19](#).
- 2 Tap  (Menu).
- 3 Tap the down arrow  to highlight Delete , then tap OK
- 4 Tap Yes to confirm.
- 5 Tap OK to delete the picture and return to the menu.
To change your mind, highlight No, then tap OK to return to the menu.

Creating and playing a multimedia slide show

Use KODAK EASYSHARE Digital Display Software to create a multimedia slide show on your computer (WINDOWS OS only); then, copy the slide show to your frame.

Before you proceed, make sure you download and install the software.

Download EASYSHARE Digital Display Software

Download and install the latest version of KODAK EASYSHARE Digital Display Software—www.kodak.com/go/digitalframedownloads.

- 1 Select Software in the product type drop-down menu.
- 2 Select Digital Display Software in the software package drop-down menu, then click Go.
- 3 Select your operating system, then follow the screen directions to download and install KODAK EASYSHARE Digital Display Software.

The software icon  appears on your desktop when the installation is complete.

- 4 Double-click  to open EASYSHARE Digital Display Software (if it doesn't open automatically).

When prompted, take a few minutes to electronically register your frame and software for exclusive tips and offers. To register later, visit www.kodak.com/go/register.

Creating a multimedia slide show

- 1 Double-click the KODAK EASYSHARE Digital Display Software icon on your desktop to open the software .

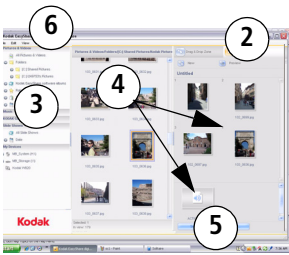



- 2 Click the Slide Show Editor tab.
- 3 In Picture & Videos, click the folder or location that contains the picture files you want to add to the slide show.
- 4 In the Viewer pane, select the pictures, then drag and drop them to the Slide Show Editor. Drag pictures in the Editor to change the order.
- 5 Click Save.
- 6 For more details on creating multimedia slide shows, click Help.

Copying a multimedia slide show to your frame

On your computer, use Digital Display Software to copy your multimedia slide shows to a memory card or USB flash; then, copy the slide shows to your frame. Here's how:

- 1 In the navigation pane under Slide Shows, click a multimedia slide show.
- 2 Drag the slide show to a connected card or USB drive in the Drag & Drop Zone.
For more details on copying from Digital Display Software to a connected device, click the Help button in the software.
- 3 Insert the card or USB drive into your frame. To copy the slide show to your frame, follow the directions in [Copying on your frame, page 20](#).

Playing a multimedia slide show on your frame

- 1 Tap  (Menu), then tap Slide Shows.
- 2 Tap an up/down arrow  to highlight a slide show icon, then tap  (Play).
The slide show begins playing.

To play a multimedia slide show on your frame, see [Viewing your pictures, page 11](#).

NOTE: To maintain the multimedia slide show's order during playback on the frame, see [Changing the display picture order, page 28](#) and select Filename, A - Z.

NOTE: A slide show plays continuously until you: tap a right border light to pause play, turn off the frame, or change viewing modes ([page 12](#)). Play resumes automatically after 15 seconds or when you tap

 (Play).





4

Changing settings and more

Changing frame settings

The options in the Settings menu let you customize and configure your frame.

IMPORTANT: *You may need to keep tapping the up/down arrows to see a complete list of available options.*

- 1 Tap  (Menu), then tap  (Settings).
- 2 Tap an up/down arrow  to highlight a setting.
- 3 Follow the on-screen instructions. Use the left/right arrows on the bottom Quick Touch Border to select an option, then tap OK to save your selections.
- 4 Tap  (Play) to return to playback from the current image. Tap  (Menu) to return to the top level menu.

Settings menus

Setting	Options
Upgrade firmware This setting is only available if the upgrade file (.img) is present on the frame (memory card, flash drive, internal memory, etc.).	Upgrade firmware —load the latest version of firmware on your frame (page 29). Exit —return to the Home screen.
Duration	Specify how long each picture is displayed from 3 seconds to 1 hour. The default is 5 seconds. NOTE: When Transition is set to Zoom and Pan, the Duration is always 10 seconds.



Setting	Options
Transition	Specify the transition style between pictures during playback. See screen for options. The default is Random.
Default Play Location Save the current picture source as your default go-to location.	Yes —confirm the current picture source as your default go-to location. No —exit the menu Clear my Default Play Location —delete reference to the currently designated picture source. See Saving a default play location, page 16 .
Shuffle	On (default)—pictures play in random order. Off —play pictures by the current Display Picture Order By setting (see page 27).
Slide show starting point Specify where playback starts when Display Picture Order By setting is Oldest to newest.	Most recent week (default)—start playback with the last week of pictures. Oldest pictures —start playback with the oldest picture available. This setting only applies when Display Picture Order By setting is Oldest to newest (see page 27).
Brightness	1 (darkest) to 10 (brightest).
Frame Orientation Change this setting if you turn your frame to display it in a different orientation.	<input checked="" type="checkbox"/> Landscape (default) <input type="checkbox"/> Portrait See Changing your frame orientation, page 29 .
Automatic resizing This setting applies when you copy pictures into the frame's internal memory. Copies are automatically resized to a lower resolution (smaller size).	On (default)—copy pictures to internal memory at a lower resolution (smaller size). Off —copy pictures to internal memory at full resolution. See page 20 . Full resolution is unnecessary for viewing and quickly fills up the frame's memory.

Setting	Options
<p>Fit or Fill Choose the picture scale for your screen.</p>	<p>Fit—show the entire picture. Black borders may appear around the image. Fill (default)—the picture fills the entire screen; some of the picture may be cut off (cropped).</p>
<p>KODAK PERFECT TOUCH Technology Automatically enhance your pictures to look their best on your frame.</p>	<p>On—automatically enhance your pictures. Off (default)—display pictures without corrections.</p>
<p>Display Picture Order By Specify the order in which to play your pictures—by date or file name. NOTE: If Shuffle is On (see page 26), pictures play in random order, regardless of this setting.</p>	<p>Oldest to newest (default)—start play with the oldest file date. Newest to oldest—start play with the most recent file date. A - Z—start play alphabetically from A to Z. Z - A—start play alphabetically by filename from Z to A.</p>
<p>Clock & Date</p>	<p>Clock—set the current time. Year—set the current year. Month—set the current month. Day—set the current day of the month. Auto Off Auto On—set automatic on and off times.</p>
<p>Language</p>	<p>Choose your language (page 6).</p>
<p>About this frame</p>	<p>Check your frame model, serial number, and firmware version.</p>
<p>Exit</p>	<p>Return to the top menu with no actions performed or saved.</p>

Changing the display picture order

The pictures on your frame are arranged and played by date, starting with the oldest. You can change the display order by date or alphabetically by file name.

To change the display order:



- 1 Tap a light on the right border to see the icons.
- 2 Tap  (Menu), then  (Settings).
- 3 Tap  (Down arrows) to highlight Display picture order by, then tap OK.
- 4 Highlight a display order:
 - Oldest to newest (default)
 - Newest to oldest
 - A to Z
 - Z to A
- 5 Tap OK.

NOTE: If Shuffle is On ([see page 26](#)), pictures play in random order, regardless of this setting.

Upgrading your firmware (recommended)

Firmware is the software that runs on your frame. To check for the latest version, visit www.kodak.com/go/digitalframedownloads.



Download the firmware to your computer, then upgrade your frame:

- 1 On your computer, go to www.kodak.com/go/digitalframedownloads.
- 2 Follow the screen directions to download the frame firmware to your computer.
- 3 Copy the IMG file to the root directory (not in a folder or subfolder) of a memory card or USB flash drive, then insert into the frame. See [page 20](#) for copying files.
- 4 Tap  (Menu), then tap  (Settings).
- 5 Highlight Firmware Upgrade, then tap OK to begin the upgrade.

IMPORTANT: Do not turn off the frame or remove the memory card or USB flash drive during the upgrade or damage to the internal memory may occur.

When the upgrade is complete, your frame automatically restarts. If it doesn't, wait 10 minutes, then press the power button on the frame to Off, then back to On.

Changing your frame orientation

Your frame is set up to display pictures in landscape orientation . You can turn the frame on its side to change the orientation to portrait . But, you must also change the orientation setting to portrait ([page 30](#)).



Landscape



Portrait





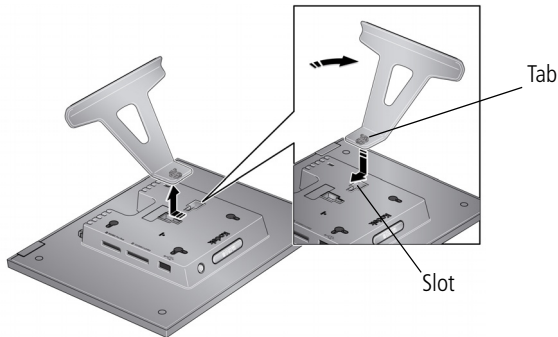

Change the stand position

Remove the stand, turn it 90°, and replace as shown.

Make sure the tab is secure in the slot.



Change the frame orientation setting

- 1 Tap  (Menu), then tap  (Settings).
- 2 Tap the down arrow  to highlight Frame orientation, then tap OK.
- 3 Tap the down arrow  to highlight Portrait, then tap OK.
- 4 Tap  (Menu) to return to the main menu, or tap  (Play) to play your pictures.

Hanging your frame on the wall (P730/P730m only)

To hang your frame on the wall, remove the stand, then use wall-anchoring hardware (not included) to securely mount the frame to the wall.

See [Back/side View, page ii](#) for the location of the mounting holes.

Maintaining your frame

IMPORTANT: *Always disconnect the power before cleaning. Do not use water, cleaning solutions, or other adhesives on the frame or any of its parts.*

Gently wipe the frame and screen with a clean, dry, lint-free cloth. For fingerprints on the frame, apply light pressure.

Learning more about your frame

www.kodak.com/go/digitalframe

Learn more about your frame

www.kodak.com/go/digitalframesupport

Interactive troubleshooting and repairs

Interactive tutorials

Frequently asked questions

Downloads

Product registration

5

Troubleshooting and support

For step-by-step product support, visit www.kodak.com/go/digitalframesupport and select Step-by-Step Solutions & Repair.

Picture frame problems

If...	Try one or more of the following
Frame does not turn on.	<ul style="list-style-type: none"> ■ Make sure the power cable that was included with your frame is connected securely (see page 2). ■ Unplug the power cable for 5 seconds, then reconnect the cable. Press and hold the power button (for about 2 seconds), then release.
Nothing happens when a memory card or USB device is connected.	<ul style="list-style-type: none"> ■ Insert a certified SD/MMC/MS/xD Card, with images, into the upper designated card slot, then push to seat it (see page 8). ■ Insert a certified MS Duo/Duo Pro Card, with images, into the lower designated card slot, then push to seat it (see page 8). <p>NOTE: Do not insert an MS Pro or MS Pro Duo card in the top slot. It could get stuck and damage the card or your frame.</p> <ul style="list-style-type: none"> ■ Make sure the USB cable that was included with your USB device is connected securely (see page 9). ■ Make sure the file format of your pictures is supported. (See page 36). <p>NOTE: Pictures may take a longer time to display when: the picture/video files are large; when using a large capacity memory card or other connected device.</p>
Touch border doesn't work.	<ul style="list-style-type: none"> ■ Use your finger to make your selections on the touch-sensitive borders (see page 4). Lights on the border show you where to touch. <p>IMPORTANT: <i>Do not slide on the right border (tap only).</i></p> <ul style="list-style-type: none"> ■ Unplug the power cable for 5 seconds, then reconnect the cable. Press and hold the power button (for about 2 seconds), then release.

If...	Try one or more of the following
<p>Frame freezes up or doesn't work properly.</p>	<ul style="list-style-type: none"> ■ Unplug the power cable for 5 seconds, then reconnect the cable. Press and hold the power button (for about 2 seconds), then release. ■ Reset the frame. Press the Mode and Power buttons (see page ii) at the same time, then tap Yes to reset the frame. (Resetting your frame does not erase your saved files.)
<p>You set automatic on/off but the frame doesn't turn on and off at the specified times.</p>	<ul style="list-style-type: none"> ■ Make sure you Enabled the on/off setting after you set the times, then press OK (not Back). See page 6. ■ If your frame loses power, the clock returns to the factory setting and auto on/off times are disabled. See Resetting the clock after losing power, page 33.
<p>Cannot copy pictures from one device to another even though the copy destination is not full.</p>	<p>Storage devices that have FAT (File Allocation Table) 16 formatting can only store up to 512 files in the top level folder (root directory). To make sure all your pictures copy properly, format the copy destination to FAT32 before copying to it:</p> <p>Caution: Formatting deletes all pictures and videos, including protected files.</p> <ol style="list-style-type: none"> 1 Connect the device to your computer. 2 Open My Computer and locate the device. 3 Right-click on it and choose Format. 4 From the File system drop-down menu, choose FAT32 then click Start.

Resetting the clock after losing power

If you turn off the power on the frame or otherwise lose power for half a day or more, the clock time returns to the factory setting and the automatic on/off times, if set, are disabled.

- When you turn the frame back on, the set time screen appears on the frame.
- Slide to set the hour. Tap the left/right arrows to highlight the previous or next setting (hour and minutes), then slide to adjust the setting.

- Tap OK.

The Home screen appears. The time is reset and the automatic on/off times (if set) are re-enabled. It is not necessary to reset the on/off times.

NOTE: If you exit the set time screen without setting the time, you can manually reset the clock and re-enable the automatic on/off times (see [page 6](#)). It is not necessary to reset the on/off times.

Screen messages

Screen message	Try one or more of the following
File is bad. (usually preceded by the file name: xxx_xxxx.JPG file is bad)	The frame is unable to display the picture. Make sure the file format of your pictures is supported. (See page 36).
Create file failed.	The device (memory card, USB drive, etc.) you are trying to copy to is protected. <ul style="list-style-type: none">■ See your device documentation to remove write protection.■ Insert or connect a different device.
Write failed. Select another location.	The frame was unable to copy the picture. <ul style="list-style-type: none">■ Insert a different card or device (page 8).
Unable to create file. Device write protected or full.	The frame was unable to copy the picture. <ul style="list-style-type: none">■ Insert a different card or device (page 8).
Disk full.	<ul style="list-style-type: none">■ Remove write protection, unlock card.■ Delete pictures from card.

Screen message	Try one or more of the following
Error attempting to open file or directory.	<ul style="list-style-type: none"> ■ Turn off the frame, then turn it back on. Press and hold the power button (for about 2 seconds), then release. If the problem persists, contact customer support help, at www.kodak.com/go/digitalframesupport.
Error duplicate filename.	
Error occurred while closing a file.	
Error invalid filename.	
Error reading from file.	
Error writing from file.	
Error writing a file.	
Error writing to a file.	
File Copy Failed!	
Internal error.	
Parameter is invalid.	
Unknown error.	

6

Appendix

Digital frame specifications

For more specifications, visit www.kodak.com/go/digitalframesupport.

KODAK EASYSHARE P730/P730m/P736 Digital Frames		
Color display		
Size (approximate)	17.8 cm (7 in.) diagonal digital LCD, 800 x 480 pixels, 15:9 aspect ratio (P736 - 4:3) 15.4 x 9.2 cm (6.1 x 3.6 in.) viewable area	
Internal storage capacity		
512 MB		
Power (5 Volt AC Adapter)		
United States/Canada	P730m	Manufacturer, Model #: Malata, MPA-05015A, EIAJ class 2 DC plug Input: 100 - 240V AC 50/60 Hz Output: 5 Volt DC, 1.5 amp,
United States/Canada	P730	Manufacturer, Model #: Leader, MU12-G050200-A1, EIAJ class 2 DC plug, straight Input: 100 - 240V AC 50/60 Hz Output: 5 Volt DC, 2.0 amp,
EAMER Asia Pacific	P730 P736	Manufacturer, Model #: Pihong, PSAA10R-050, EIAJ class 2 DC plug (P730 - straight; P736 - right angle) Input: 100 - 240V AC 50/60 Hz Output: 5 Volt DC, 2.0 amp,
Communication with computer		
Not supported		

KODAK EASYSHARE P730/P730m/P736 Digital Frames		
Wi-Fi wireless network compatibility		
Not supported		
Other features		
PICTBRIDGE enabled printing	Not supported	
Picture formats	JPEG, JPG, EXIF 2.2	
Video formats	Not supported.	
Music formats	Not supported.	
Memory cards	Top card slot: SD (SECURE DIGITAL); MMC (MULTIMEDIA Card); MS (MEMORY STICK), XD Bottom card slot: MS (MEMORY STICK)/Pro Duo	
Security lock (not included)	Kensington	
Temperature	Operating: 32 to 104° F (0 to 40° C) Storage: -4 to 140° F (-20 to 60° C)	
Size (approximate)	P730/ P730m	196 x 256 x 39 mm (7.7 x 10.1 x 1.5 in.)
	P736	150 x 215 x 30 mm (5.9 x 8.5 x 1.2 in.)
Weight (approximate) with stand and AC power adapter	P730	669 grams (23.6 ozs.)
	P730m	714 grams (25.2 ozs.)
	P736	537 grams (18.9 ozs.)

Important safety instructions



CAUTION:

Do not disassemble this product; there are no user-serviceable parts inside. Refer servicing to qualified service personnel. Do not expose this product to liquid, moisture, or extreme temperatures. The use of controls, adjustments, or procedures other than those specified herein may result in exposure to shock and/or electrical or mechanical hazards. If the LCD screen breaks, do not touch the glass or liquid. Contact Kodak customer support.

- The use of an accessory that is not recommended by Kodak may cause fire, electric shock, or injury. For approved accessories, visit www.kodak/go/accessories.
- Use only the AC power adapter specified for your frame (see page 36). Use of other AC adapters may damage the frame and void your warranties.
- Use only a USB-certified computer equipped with a current-limiting motherboard. Contact your computer manufacturer if you have questions.
- When displayed, the frame rests at a 68 - 76 degree angle.
- Do not place frame near open flame sources such as lighted candles or heaters.
- Excessive sound pressure from earphones and headphones may cause hearing loss.

Upgrading your software and firmware

Upgrade to the latest versions of the KODAK EASYSHARE Software and the frame firmware at www.kodak.com/go/digitalframedownloads. See page 29 for upgrading firmware.

Additional care and maintenance

- To clean the frame or screen, use a soft lint-free cloth dampened with lens cleaning solution or a water-based cleaning solution. Use light pressure.
- Do not allow chemicals, such as suntan lotion, to contact painted surfaces.
- Service agreements are available in some countries. Contact a dealer of Kodak products for more information.
- For digital frame disposal or recycling information, contact your local authorities. In the US, visit the Electronics Industry Alliance Web site at www.eiae.org or visit www.kodak.com/go/digitalframesupport.

Limited warranty

Kodak warrants Kodak consumer electronic products and accessories ("Products"), excluding batteries, to be free from malfunctions and defects in both materials and workmanship for one year from the date of purchase. Retain the original dated sales receipt. Proof of the date of purchase will be required with any request for warranty repair.

Limited warranty coverage

Warranty service is only available from within the country where the Products were originally purchased. You may be required to ship Products, at your expense, to the authorized service facility for the country where the Products were purchased. Kodak will repair or replace Products if they fail to function properly during the warranty period, subject to any conditions and/or limitations stated herein. Warranty service will include all labor as well as any necessary adjustments and/or replacement parts. If Kodak is unable to repair or replace a Product, Kodak will, at its option, refund the purchase price paid for the Product provided the Product has been returned to Kodak along with proof of the purchase price paid. Repair, replacement, or refund of the purchase price are the sole remedies under the warranty. If replacement parts are used in making repairs, those parts may be remanufactured, or may contain remanufactured materials. If it is necessary to replace the entire Product, it may be

replaced with a remanufactured Product. Remanufactured Products, parts and materials are warranted for the remaining warranty term of the original Product, or 90 days after the date of repair or replacement, whichever is longer.

Limitations

This warranty does not cover circumstances beyond Kodak's control. This warranty does not apply when failure is due to shipping damage, accident, alteration, modification, unauthorized service, misuse, abuse, use with incompatible accessories or attachments (such as third party ink or ink tanks), failure to follow Kodak's operation, maintenance or repacking instructions, failure to use items supplied by Kodak (such as adapters and cables), or claims made after the duration of this warranty. Kodak makes no other express or implied warranty for this product, and disclaims the implied warranties of merchantability and fitness for a particular purpose. In the event that the exclusion of any implied warranty is ineffective under the law, the duration of the implied warranty will be one year from the purchase date or such longer period as required by law. The option of repair, replacement, or refund is Kodak's only obligation. Kodak will not be responsible for any special, consequential or incidental damages resulting from the sale, purchase, or use of this product regardless of the cause. Liability for any special, consequential or incidental damages (including but not limited to loss of revenue or profit, downtime costs, loss of the use of the equipment, cost of substitute equipment, facilities or services, or claims of your customers for such damages resulting from the purchase, use, or failure of the Product), regardless of cause or for breach of any written or implied warranty is expressly disclaimed.

Your rights

Some states or jurisdictions do not allow exclusion or limitation of incidental or consequential damages, so the above limitation or exclusion may not apply to you. Some states or jurisdictions do not allow limitations on how long an implied warranty lasts, so the above limitation may not apply to you. This warranty gives you specific rights, and you may have other rights which vary from state to state or by jurisdiction.

Outside the United States and Canada

In countries other than the United States and Canada, the terms and conditions of this warranty may be different. Unless a specific Kodak warranty is communicated to the purchaser in writing by a Kodak company, no warranty or liability exists beyond any minimum requirements imposed by law, even though defect, damage, or loss may be by negligence or other act.

Regulatory compliance and advisory

FCC compliance and advisory



FCC and Industry Canada

This device complies with Part 15 of the FCC Rules. Operation is subject to the following two conditions: (1) this device may not cause harmful interference, and (2) this device must accept any interference received, including interference that may cause undesired operation.

Canadian DOC statement

This Class B digital apparatus complies with Canadian ICES-003.

Cet appareil numérique de la classe B est conforme à la norme NMB-003 du Canada.



Hereby, Eastman Kodak Company declares that this Kodak product is in compliance with the essential requirements and other relevant provisions of Directive 1999/5/EC.

Australian C-Tick



Waste Electrical and Electronic Equipment labeling



EU: It is the final user's responsibility to discard this equipment into an approved, segregated collection scheme to enable its suitable treatment/disposal and to improve human/environmental protection. For more information, see your retailer, local authority, or www.kodak.com/go/recycle.

Weight with AC adapter and stand: P730 - 669 g

P730m - 714 g

P736 - 537 g

Russian GOST-R



Eastman Kodak Company
Rochester, NY 14650

Цифровая фоторамка изготовлена в Китае; остальные элементы – в соответствии с маркировкой

China RoHS

Product Disclosure Table
KODAK Digital Picture Frames
 有毒有害物质或元素名称及含量标识表
 table of hazardous substances' name and concentration

部件名称 Component name	有毒有害物质或元素 hazardous substances' name					
	铅 (Pb)	汞 (Hg)	镉 (Cd)	六价铬 (Cr6+)	多溴联苯 (PBB)	多溴二苯醚 (PBDE)
交流变压器电路板元件 AC Adapter circuit board components	x	o	o	o	o	o
数码相架电路板元件 Digital Photo Frame circuit board components	x	o	o	o	o	o
数码相架外壳 Digital Photo Frame Enclosure	o	o	o	o	o	o
○：表示该有毒有害物质在该部件所有均质材料中的含量均在SJ/T 11363-2006规定的限量要求以下。 ×：表示该有毒有害物质至少在该部件的某一均质材料中的含量超出SJ/T 11363-2006规定的限量要求。 ○： indicates hazardous substance concentration lower than MCV ×： indicates hazardous substance concentration higher than MCV						

Licensing

Supply of this product does not convey a license nor imply any right to distribute content created with this product in revenue-generating broadcast systems (terrestrial, satellite, cable and/or other distribution channels), streaming applications (via Internet, intranets and/or other networks), other content distribution systems (pay-audio or audio-on-demand applications and the like) or on physical media (compact discs, digital versatile discs, semiconductor chips, hard drives, memory cards and the like). An independent license for such use is required. For details, please visit <http://mp3licensing.com>.

Index

A

- about, frame, 27
- AC adapter, 36
- appendix, 36
- automatic on/off, 27

B

- border, touch, 4

C

- cable
 - power, connecting, 2
- cables
 - USB, connecting, 9
- changing picture locations, 11
- cleaning, 31
- cleaning frame, 39
- clock and date, setting, 27
- clock, date, and timer, setting, 33
- copying
 - to frame's internal memory, 20

D

- date
 - sort pictures by, 28
- deleting pictures, 21
- display order, changing, 28
- disposal, recycling, 39

E

- EASYSHARE Digital Display Software
 - create slide show, 22

- error messages, 34

F

- filename, sort by, 28
- firmware
 - checking version, 27
 - upgrading, 25, 29, 38
- flash drive, connecting, 9
- frame
 - URLs, 31
- frame screen, cleaning, 31
- frame, picture
 - checking model, firmware, serial number, 27
 - disposal, 39
 - resetting, 33
 - setup, 1
 - specifications, 36
 - troubleshooting, 32
 - turn on/off, 3

G

- go-to location
 - saving, 16

H

- hanging your frame, 31
- help
 - frame, 32
 - troubleshooting and support, 32
- home
 - viewing picture sources, 11

I

internal memory
capacity, 36

L

landscape, set orientation, 29
language, 27
language, setting, 6

M

memory card types, 37
memory cards
inserting, 8

Menu

Copy, 18
Delete, 18
Deselect All, 18
Exit, 18
Multi-select, 18
Pictures, 17
Rotate, 18
Select All, 18
Settings, 18
Slide shows, 17
Thumbnails, 17

Menu options, 17

Mode

button, ii

mounting your frame, 31
multimedia slide show, 22

O

on/off, setting auto, 27
orientation setting, 29

P

pictures

copying to internal memory, 20
deleting, 21
location, viewing, 11
rotating, 21
selecting more than one, 19
sort by date or filename, 28
thumbnails, 15
viewing locally, 10
viewing single, 16

portrait, set orientation, 29

power

button, ii, 3
connecting, 2
specifications, 36

Q

Quick Touch Border, i
quick touch border, 4

R

recycling, disposal, 39
regulatory compliance, 41
reset frame, 33
rotating
pictures, 21

S

safety information, 38
screen
cleaning, 39
error messages, 34
selecting
menus and pictures, 4

- multiple pictures, 19
- serial number, checking, 27
- setting
 - auto on/off, 27
 - clock after losing power, 33
 - language, 6
 - time, 27
- setting your language, 27
- Settings
 - About, 27
 - Automatic resizing, 26
 - Brightness, 26
 - Clock and Date, 27
 - Default play location, 26
 - Display picture order by, 27
 - Duration, 25
 - Exit, 27
 - Fit or Fill, 27
 - Frame orientation, 26
 - KODAK PERFECT TOUCH technology, 27
 - Language, 27
 - Shuffle, 26
 - Slide show starting point, 26
 - Transition, 26
 - Upgrade firmware, 25
- setup
 - picture frame, 1
- size, 37
- slide show
 - create with pictures and music, 22
 - playing, 10
 - sort order, 28
- slide show location

- saving, 16
- software
 - upgrading, 38
- sort, 28
- source, picture location, 11
- specifications, frame, 36
- storage capacity, internal memory, 36

T

- thumb drive. See flash drive.
- thumbnails, 15
- time, setting, 27
- timer, 27
- troubleshooting
 - error messages, 34
 - frame, 32
- turn on frame, 3

U

- upgrading
 - firmware, 25
 - software and firmware, 38
- USB
 - device, connecting, 9

V

- viewing
 - picture sources, 11
 - pictures, locally, 10
 - single picture, 16
 - thumbnails, 15

W

- warranty, 39
- weight, 37

Free Manuals Download Website

<http://myh66.com>

<http://usermanuals.us>

<http://www.somanuals.com>

<http://www.4manuals.cc>

<http://www.manual-lib.com>

<http://www.404manual.com>

<http://www.luxmanual.com>

<http://aubethermostatmanual.com>

Golf course search by state

<http://golfingnear.com>

Email search by domain

<http://emailbydomain.com>

Auto manuals search

<http://auto.somanuals.com>

TV manuals search

<http://tv.somanuals.com>