



MDRIVE 34™

MOTOR+DRIVER

AC Plus²

MOTION CONTROL

(with optional CANopen)

FEATURES



- Highly Integrated Microstepping Driver/ Intelligent Motion Controller with Optional Encoder/NEMA 34 High Torque 1.8° Brushless Step Motor
- Advanced 2nd Generation Current Control for Exceptional Performance and Smoothness
- Single Supply: 120 or 240 VAC
- Cost Effective
- Extremely Compact
- High Positioning Accuracy
- No Tuning Required
- Stable at Low Speeds
- No Dithering at Zero Speed
- High Starting Torque
- Allows for Greater Inertia Mismatch
- Built-in Regeneration Circuitry
- Available Options:
 - Long Life Linear Actuators**
 - Integral Optical Encoder for Closed Loop Control
 - External/Remote Encoder (not supplied) for Closed Loop Control
 - Control Knob for Manual Positioning
 - Integrated Planetary Gearbox
 - IP65 Sealed Configuration
 - Linear Slide
- Three Motor Lengths Available
- Auxiliary Logic Power Supply Input
- Up to 5 MHz Step Clock Rate
- 20 Microstep Resolutions up to 51,200 Steps Per Rev Including: Degrees, Metric, Arc Minutes
- Open or Optional Closed Loop Control
- Programmable Motor Current
- Up to Eight +24 VDC Tolerant I/O Lines, Sourcing or Sinking
- One 10 Bit Analog Input Selectable: 0 to +5 VDC, 0 to +10 VDC, 0-20 mA, 4-20 mA
- RS-422/485 or Optional CANopen Communications
- 62 Software Addresses for Multi-Drop Communications
- High Speed Position Capture Input or Trip Output
- Electronic Gearing

DESCRIPTION

The **MDrive34AC Plus2 Motion Control** system offers designers a cost effective, full featured programmable motion controller integrated with a NEMA 34 high torque 1.8° brushless step motor and a microstepping driver operating at 120 or 240 VAC.

Unsurpassed smoothness and performance delivered by the MDrive34AC are achieved through IMS's advanced 2nd generation current control. By applying innovative techniques to control current flow through the motor, resonance is significantly dampened over the entire speed range and audible noise is reduced.

The MDrive34AC accepts a broad input voltage range from 95 to 264 VAC, delivering enhanced performance and speed. Oversized input capacitors are used to minimize power line surges, reducing problems that can occur with long cable runs and multiple drive systems. An extended operating range of -40° to +75°C provides long life, trouble free service in demanding environments.

The MDrive34AC Plus2 Motion Control system adds a versatile array of functions by combining a full featured programmable motion controller with our compact and cost effective MDrive34AC Microstepping products, adding little cost and no increase in size. Standard offerings include up to 8 general purpose I/O lines (sourcing or sinking) that operate to +24 VDC, one 10 bit analog input, electronic gearing, high speed position capture input/trip output, microstep resolutions up to 51,200 steps per revolution, 0 to 5 MHz step clock rate, and a full featured easy-to-program instruction set.

The MDrive34AC Plus2 Motion Control system communicates over RS-422/485 which allows for point-to-point or multiple unit configurations utilizing one communication port. Addressing and hardware support multiple uniquely addressed units communicating over a single line.

Optional communication protocols include CANopen. The CAN bus is 2.0B active (11 and/or 29 bit) and is capable of all standard frequencies from 10 kHz to 1 MHz. CANopen features include node guarding, heartbeat producer, SDOs and PDOs. Highlights include variable PDO mapping and extended node identifier.

The MDrive34AC Plus2 Motion Control is available with optional closed loop control. This increases functionality by adding stall detection, position maintenance and find index mark.

The closed loop configuration is added via a 512 line (2048 edge) optical encoder with index mark, internal to the MDrive34AC so there is no increase in length. Or, for an expanded choice of line counts and resolutions, closed loop control is available with an interface to a remotely mounted user-supplied external encoder.

In addition to encoder options, the MDrive34AC Plus2 Motion Control has the capability of electronic gearing by following a rotary or linear axis at an electronically controlled ratio, or an output clock can be generated fixed to the internal step clock.

A sealed version designed to meet IP65 specifications is also available. The sealed assembly allows the MDrive34AC to be used in environments where exposure to chemical, dust and liquids may occur.

Three rotary motor lengths are available as are linear actuators with long life Acme screw**.

Interface connections are accomplished using standard industrial circular connectors. And connectivity has never been easier with options ranging from **all-inclusive QuickStart Kits to individual interfacing cables.** See pg 4.

**Consult Factory for Availability.

MDrive34AC Plus2 MOTION CONTROL

GENERAL SPECIFICATIONS

INPUT VOLTAGE	Range	120 V MDrive – 95 to 132 VAC @ 50/60 Hz 240 V MDrive – 95 to 264 VAC @ 50/60 Hz		
AUX. LOGIC INPUT VOLTAGE	Range	+12 to +24 VDC Maintains power to control and feedback circuits (only) when input voltage is removed.		
ANALOG INPUT	Resolution	10 Bit		
	Voltage Range	0 to +5 VDC, 0 to +10 VDC, 0-20 mA or 4-20 mA		
GENERAL PURPOSE I/O	Number/Type	8 Sourcing or Sinking (or 4 when Remote Encoder Option is Selected)		
	Logic Range	+5 to +24 VDC – Inputs and Sinking Outputs; Inputs TTL Level Compatible +12 to +24 VDC – Sourcing Outputs		
	Output Sink/Source Current	Up to 600 mA per Channel		
	Protection	Over Temp, Short Circuit, Transient Over Voltage, Over Voltage, Inductive Clamp		
COMMUNICATION	Type (Standard)	RS-422/485		
	Baud Rate	4800 to 115.2kbps		
	Type (Optional)	CANopen DSP-402 (V2.0), DS-301 (V3.0), 2.OB Active		
	ID	11 and/or 29 Bit		
	Isolation	Galvanic		
	Features	Node Guarding, Heartbeat, SDOs, PDOs (Variable Mapping)		
MOTION	Open Loop Configuration	Number of Settings	20	
		Steps Per Revolution	200, 400, 800, 1000, 1600, 2000, 3200, 5000, 6400, 10000, 12800, 20000, 25000, 25600, 40000, 50000, 51200, 36000 (0.01 deg/μstep), 21600 (1 arc minute/μstep), 25400 (0.001mm/μstep)	
	Closed Loop Configuration (Optional)	Internal Encoder	Type	Internal, Optical
			Steps Per Revolution	51200
		Remote Encoder	Type	User-Supplied Differential Encoder
			Steps Per Revolution	200, 400, 800, 1000, 1600, 2000, 3200, 5000, 6400, 10000, 12800, 20000, 25000, 25600, 40000, 50000, 51200, 36000 (0.01 deg/μstep), 21600 (1 arc minute/μstep), 25400 (0.001mm/μstep)
	Counters	Type	Position, Encoder/32 Bit	
		Edge Rate (Max)	5 MHz	
	Velocity	Range	+/- 5,000,000 Steps Per Second	
		Resolution	0.5961 Steps Per Second	
	Accel/Decel	Range	1.5 x 10 ⁹ Steps Per Second ²	
		Resolution	90.9 Steps Per Second ²	
	Electronic Gearing	Range‡/Resolution/Threshold (External Clock In)	0.001 to 2.000/32 Bit/TTL	
		Input Filter Range	50 nS to 12.9 μS (10 MHz to 38.8 kHz)	
		Range‡ (Secondary Clock Out)	1 to 1	
	High Speed I/O	Position Capture	Input Filter Range	50 nS to 12.9 μS (10 MHz to 38.8 kHz)
			Resolution	32 Bit
Trip Output – Speed/Resolution/Threshold		150 nS/32 Bit/TTL		
SOFTWARE	Program Storage	Type/Size	Flash/6384 Bytes	
	User Registers	(4) 32 Bit		
	User Program Labels and Variables	192		
	Math Functions	+, -, x, ÷, >, <, =, <=, >=, AND, OR, XOR, NOT		
	Branch Functions	Branch & Call		
	General Purpose I/O Functions	Inputs	Home, Limit Plus, Limit Minus, Go, Stop, Pause, Jog Plus, Jog Minus, Analog In, General Purpose	
		Outputs	Moving, Fault, Stall, Velocity Change, General Purpose	
	Trip Functions	Trip on Input, Trip on Position, Trip on Time, Trip Capture		
Party Mode Addresses	62			
Encoder Functions	Stall Detection, Position Maintenance, Find Index			
THERMAL	Operating Temperature	Heat Sink	-40° to +75°C (non-condensing)	
		Motor	-40° to +90°C (non-condensing)	
PROTECTION	Type	Thermal, Internal Fuse †		

† Designed for line-neutral systems.

‡ Adjusting the microstep resolution can increase the range.

MOTOR SPECIFICATIONS

	Holding Torque	Detent Torque	Rotor Inertia	Weight (Motor+Driver)
SINGLE LENGTH	330 oz-in / 233 N-cm	10.9 oz-in / 7.7 N-cm	0.01416 oz-in-sec ² / 1.0 kg-cm ²	6.4 lb / 2.9 kg
DOUBLE LENGTH	500 oz-in / 353 N-cm	14.16 oz-in / 10.0 N-cm	0.02266 oz-in-sec ² / 1.6 kg-cm ²	7.7 lb / 3.5 kg
TRIPLE LENGTH	750 oz-in / 529 N-cm	19.83 oz-in / 14.0 N-cm	0.04815 oz-in-sec ² / 3.4 kg-cm ²	11.0 lb / 5.0 kg

SPEED-TORQUE

MDrive34AC - 120VAC

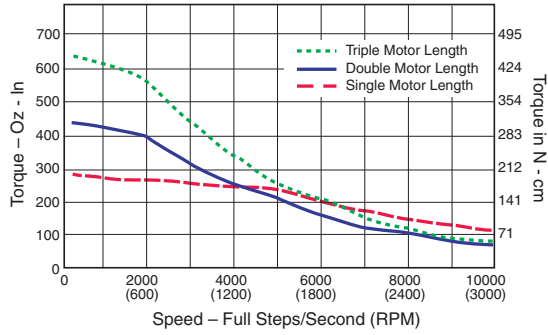

MDrive34AC - 240VAC

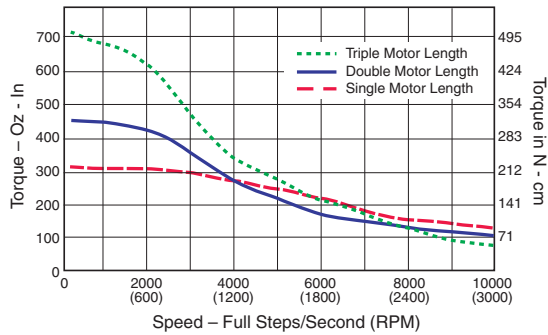

PIN ASSIGNMENTS

P1: I/O CONNECTOR		
M23 Circular (Male)	Function	
	Expanded I/O	Remote Encoder Closed Loop Control
Pin 1	I/O 9	Channel A +
Pin 2	I/O 11	Channel B +
Pin 3	Step/Clock I/O	Index +
Pin 4	I/O 1	I/O 1
Pin 5	Direction/Clock I/O	Index -
Pin 6	No Connect	No Connect
Pin 7	Aux-Logic (+12 to +24 VDC)	Aux-Logic (+12 to +24 VDC)
Pin 8	Aux-Ground	Aux-Ground
Pin 9	I/O 3	I/O 3
Pin 10	I/O Ground	I/O Ground
Pin 11	I/O Power	I/O Power
Pin 12	Shell Connect	Shell Connect
Pin 13	I/O 12	Channel B -
Pin 14	Capture/Trip I/O	Capture/Trip I/O
Pin 15	Analog In	Analog In
Pin 16	I/O 2	I/O 2
Pin 17	I/O 4	I/O 4
Pin 18	I/O 10	Channel A -
Pin 19	No Connect	No Connect

P2: COMM CONNECTOR			
RS-422/485		CANopen	
M12 Circular (Female)	Function	M12 Circular (Male)	Function
Pin 1	TX -	Pin 1	Shield
Pin 2	TX +	Pin 2	CAN +V
Pin 3	RX +	Pin 3	CAN -V
Pin 4	RX -	Pin 4	CAN High
Pin 5	Comm Ground	Pin 5	CAN Low

P3: POWER CONNECTOR	
Euro AC (Male)	Function
Pin 1	Chassis Ground
Pin 2	AC Power Line
Pin 3	AC Power Neutral

MECHANICAL SPECIFICATIONS

Dimensions in Inches (mm)

MDrive34AC Plus²

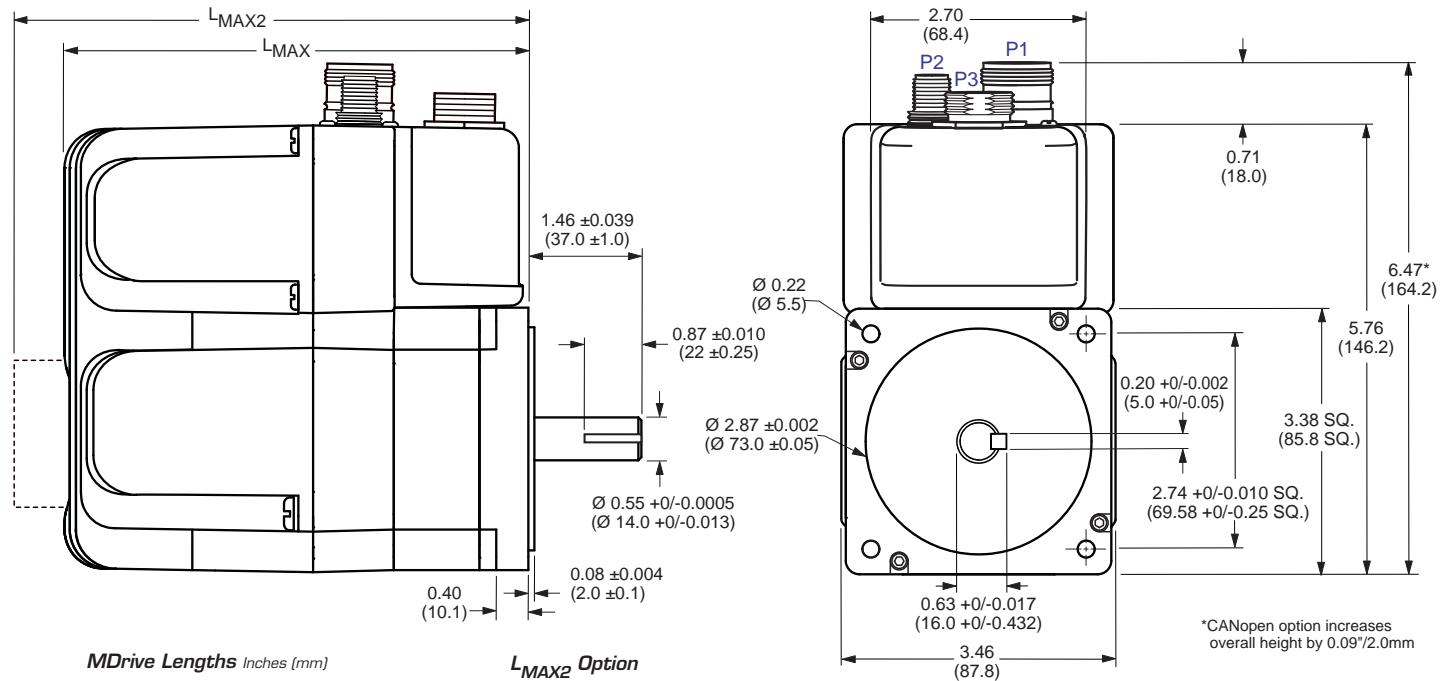

MDrive Lengths Inches (mm)

Motor Length	LMAX	LMAX2
	SINGLE SHAFT, ENCODER or LINEAR ACTUATOR VERSION	CONTROL KNOB VERSION
Single	6.1 (155.0)	7.1 (180.4)
Double	6.9 (174.3)	7.9 (199.7)
Triple	8.4 (214.3)	9.4 (239.7)

L_{MAX2} Option

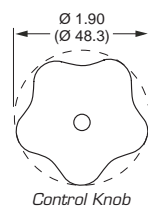

Connectors

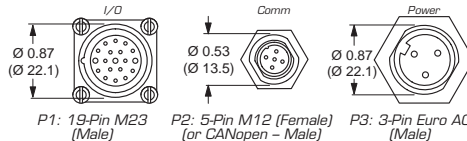

ORDER INFORMATION — MDrive34AC Plus² Motion Control

CONNECTIVITY

new

QuickStart Kit

For rapid design verification, all-inclusive QuickStart Kits have communication converter, prototype development cable(s), instructions and CD for MDrivePlus initial functional setup and system testing.

new

Communication Converter

Electrically isolated, in-line converter pre-wired with mating connector to conveniently set/program communication parameters for a single MDrivePlus via a PC's USB port. Length 12.0" (3.6m).

Mates to connector:

- 5-Pin M12MD-CC401-001
- 5-Pin M12 CANopenMD-CC500-000*

*Requires mating connector adapter and power supply, not supplied.

Prototype Development Cables

Speed test/development with pre-wired mating connectors that have flying leads other end. Single-ended cordsets are PVC jacketed with foil shield and unconnected drain wire. Length 13.0" (4.0m).

Mates to connector:

- 19-Pin M23
 - Straight TerminationMD-CC100-000
 - Right Angle TerminationMD-CC101-000
- 3-Pin Euro AC
 - Straight TerminationMD-CC200-000
 - Right Angle TerminationMD-CC201-000

**Consult Factory for Availability.

‡ Not Available with Sealed -65 Versions.

Connectivity details: www.imshome.com/cables_cordsets.html

OPTIONS

Linear Actuator**

The MDrive34AC Plus² is offered with numerous linear actuator styles and options to satisfy a broad range of linear motion applications. Contact the factory for details or see: www.imshome.com/mdriveplus_linear_actuator.html

Internal Encoder

An internal 512-line (2048 count) differential optical encoder with index mark is available factory-mounted.

Remote Encoder

This MDrivePlus Motion Control is offered with differential encoder inputs for use with a remote encoder (not supplied).

Control Knob‡

For manual shaft positioning, a factory-mounted rear control knob is available.

Planetary Gearbox

Efficient, low maintenance planetary gearboxes are offered factory-mounted. Refer to details and part numbers on the back cover.

Linear Slide

Integrated linear slides are available factory installed for precision linear movement. Screw leads are 0.1", 0.2", 0.5" or 1.0" of travel per rev. Slides are 12.0" (30.5cm) to 42.0" (106.7cm) long. Contact factory for custom lengths. Refer to separate datasheet or web site for complete details.

PART NUMBERING

Plus²
expanded features

Plus² - 65
IP65 sealed

K MDI M Q34 - **OPTION**

QuickStart Kit
details above

MDrive Version
3 = Plus
4 = Plus-65 (sealed)

Communications
R = RS-422/485
C = CANopen

Input Voltage
1 = 120 Volt
2 = 240 Volt

Motor
A = Single Length & Linear Actuator**
B = Double Length
C = Triple Length

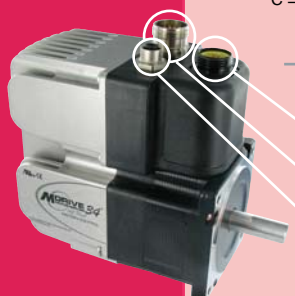

P3: Power, 3-Pin Euro AC Connector

P1: I/O, 19-Pin M23 Circular Connector

P2: Communications, 5-Pin M12 Circular Connector

Example #1: Part Number **MDI3MRQ34A2** is an MDrive34AC Plus² Motion Control with 19-pin M23 circular I/O interface, RS-422/485 communications with 5-pin M12 circular connector, NEMA 34 single length motor and 240 input voltage.

**Consult Factory for Availability.

OPTIONS

Linear Actuator** **-L**

For complete product specifications, see:
www.imshome.com/mdriveplus_linear_actuator.html

Internal Encoder **-EQ**

Example: **MDI3MRQ34A2-EQ** adds a 512-line internal optical encoder with index mark to example #1.

Remote Encoder **-EE**

Example: **MDI3MRQ34A2-EE** adds differential encoder inputs for use with remote encoder (not supplied).
May not be combined with internal encoder option.

Control Knob **-N**

Example: **MDI3MRQ34A2-N** adds a rear control knob to example #1. *Not available with sealed -65 versions.*

Planetary Gearbox **-G** **-F**

Refer to gearbox page for complete table of ratios and part numbers. **Optional NEMA Flange**

Example: **MDI3MRQ34A2-G1A2** adds a 1-stage planetary gearbox with 5.18:1 ratio to example #1. Add -F for optional NEMA flange.

Linear Slide **-R**

<p>Screw Lead (inches/rev)</p> <p>A = 0.10" (2.54mm) B = 0.20" (5.08mm) C = 0.50" (12.7mm) D = 1.00" (25.4mm)</p>	<p>Standard Screw Lengths 12", 18", 24", 36" or 42" <i>For Custom Lengths, Consult Factory</i></p>
--	---

Example: **MDI3MRQ34A2-RA12** adds a Linear Slide with 0.10" screw lead, 12" long to example #1.

MDrive34AC PLUS WITH PLANETARY GEARBOX

The MDrive34AC Plus is available with a Planetary Gearbox option developed to increase torque at lower speeds, enable better inertia matching and produce finer positional resolutions. These efficient, low maintenance Planetary Gearbox come fully assembled with the MDrive and are offered in a large number of reduction ratios in 1-, 2- and 3-stage configurations. An optional NEMA Output Flange allows mounting the Planetary Gearbox to the load using a standard NEMA bolt circle. Planetary Gearbox may be combined with other MDrive34AC Plus options, however are unavailable with Linear Actuators.

Planetary Gearbox Parameters

	Permitted Output Torque (oz-in./Nm)	Gearbox Efficiency	Maximum Backlash	Output Side with Ball Bearing			
				Maximum Load (lb-force/N)		Weight (oz/g)	
				Radial	Axial	Gearbox	with Flange
1-STAGE	2832/20.0	0.80	1.0°	90/400	18/80	64.4/1827	66.7/1890
2-STAGE	8496/60.0	0.75	1.5°	135/600	27/120	89.5/2538	92.6/2625
3-STAGE	16992/120.0	0.70	2.0°	225/1000	45/200	114.6/3248	118.5/3360

Ratios and Part Numbers

Planetary Gearbox	Ratio (Rounded)	Part Number**
1-Stage	3.71:1	G1A1
1-Stage	5.18:1	G1A2
1-Stage	6.75:1	G1A3
2-Stage	13.73:1	G1A4
2-Stage	15.88:1	G1A5
2-Stage	18.37:1	G1A6
2-Stage	19.20:1	G1A7
2-Stage	22.21:1	G1A8
2-Stage	25.01:1	G1A9
2-Stage	26.85:1	G1B1
2-Stage	28.93:1	G1B2
2-Stage	34.98:1	G1B3
2-Stage	45.56:1	G1B4
3-Stage	50.89:1	G1B5
3-Stage	58.86:1	G1B6
3-Stage	68.07:1	G1B7
3-Stage	71.16:1	G1B8
3-Stage	78.72:1	G1B9
3-Stage	92.70:1	G1C1
3-Stage	95.18:1	G1C2
3-Stage	99.51:1	G1C3
3-Stage	107.21:1	G1C4
3-Stage	115.08:1	G1C5
3-Stage	123.98:1	G1C6
3-Stage	129.62:1	G1C7
3-Stage	139.14:1	G1C8
3-Stage	149.90:1	G1C9
3-Stage	168.85:1	G1D1
3-Stage	181.25:1	G1D2
3-Stage	195.27:1	G1D3
3-Stage	236.10:1	G1D4
3-Stage	307.55:1	G1D5

Planetary Gearbox for MDrive34AC Plus

Dimensions in Inches (mm)

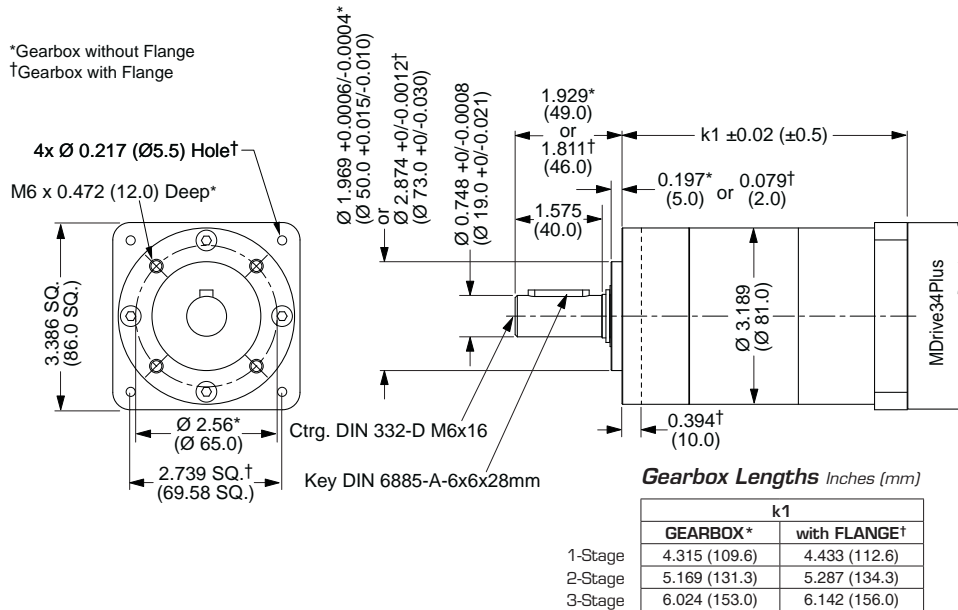

**Include optional planetary gearbox by adding -G plus 3 characters to the end of an MDrive part number.

U.S.A. SALES OFFICES

Eastern Region

Tel. 862 208-9742 - Fax 973 661-1275
e-mail: jroake@imshome.com

Central Region

Tel. 260 402-6016 - Fax 419 858-0375
e-mail: dwaksman@imshome.com

Western Region

Tel. 602 578-7201
e-mail: dweisenberger@imshome.com

IMS ASIA PACIFIC OFFICE

30 Raffles Pl., 23-00 Caltex House, Singapore 048622
Tel. +65/6233/6846 - Fax +65/6233/5044
e-mail: wlee@imshome.com

IMS EUROPEAN SALES MANAGEMENT

4 Quai Des Etroits
69005 Lyon, France
Tel. +33/4 7256 5113 - Fax +33/4 7838 1537
e-mail: bmartinez@imshome.com

IMS UK Ltd.

Sanderson Centre, 15 Lees Lane
Gosport, Hampshire PO12 3UL
Tel. +44/0 2392-520775 - Fax +44/0 2392-502559
e-mail: mcheckley@imshome.com

TECHNICAL SUPPORT

Tel. +00 (1) 860 295-6102 - Fax +00 (1) 860 295-6107
e-mail: etech@imshome.com

Intelligent Motion Systems, Inc.

370 North Main Street, P.O. Box 457
Marlborough, CT 06447 - U.S.A.
Tel. +00 (1) 860 295-6102 - Fax +00 (1) 860 295-6107
e-mail: info@imshome.com
http://www.imshome.com

© Intelligent Motion Systems, Inc. All Rights Reserved. REV060208
IMS Product Disclaimer and most recent product information at www.imshome.com.

IMS™ INTELLIGENT MOTION SYSTEMS, INC.

by Schneider Electric

Free Manuals Download Website

<http://myh66.com>

<http://usermanuals.us>

<http://www.somanuals.com>

<http://www.4manuals.cc>

<http://www.manual-lib.com>

<http://www.404manual.com>

<http://www.luxmanual.com>

<http://aubethermostatmanual.com>

Golf course search by state

<http://golfingnear.com>

Email search by domain

<http://emailbydomain.com>

Auto manuals search

<http://auto.somanuals.com>

TV manuals search

<http://tv.somanuals.com>