

marantz®

Model SA-14S1 Owner's Manual

Super Audio CD Player

SAFETY PRECAUTIONS



CAUTION
RISK OF ELECTRIC SHOCK
DO NOT OPEN



CAUTION:
TO REDUCE THE RISK OF ELECTRIC SHOCK, DO NOT REMOVE COVER (OR BACK). NO USER-SERVICEABLE PARTS INSIDE. REFER SERVICING TO QUALIFIED SERVICE PERSONNEL.

The lightning flash with arrowhead symbol, within an equilateral triangle, is intended to alert the user to the presence of uninsulated "dangerous voltage" within the product's enclosure that may be of sufficient magnitude to constitute a risk of electric shock to persons.

The exclamation point within an equilateral triangle is intended to alert the user to the presence of important operating and maintenance (servicing) instructions in the literature accompanying the appliance.

WARNING:
TO REDUCE THE RISK OF FIRE OR ELECTRIC SHOCK, DO NOT EXPOSE THIS APPLIANCE TO RAIN OR MOISTURE.

CAUTION:
USE OF CONTROLS OR ADJUSTMENTS OR PERFORMANCE OF PROCEDURES OTHER THAN THOSE SPECIFIED HEREIN MAY RESULT IN HAZARDOUS RADIATION EXPOSURE.
THIS PRODUCT SHOULD NOT BE ADJUSTED OR REPAIRED BY ANYONE EXCEPT PROPERLY QUALIFIED SERVICE PERSONNEL.

CLASS 1 LASER PRODUCT

"CLASS 1
 LASER PRODUCT"

IMPORTANT SAFETY INSTRUCTIONS

1. Read these instructions.
2. Keep these instructions.
3. Heed all warnings.
4. Follow all instructions.
5. Do not use this apparatus near water.
6. Clean only with dry cloth.
7. Do not block any ventilation openings. Install in accordance with the manufacturer's instructions.
8. Do not install near any heat sources such as radiators, heat registers, stoves, or other apparatus (including amplifiers) that produce heat.
9. Do not defeat the safety purpose of the polarized or grounding-type plug. A polarized plug has two blades with one wider than the other. A grounding type plug has two blades and a third grounding prong. The wide blade or the third prong are provided for your safety. If the provided plug does not fit into your outlet, consult an electrician for replacement of the obsolete outlet.
10. Protect the power cord from being walked on or pinched particularly at plugs, convenience receptacles, and the point where they exit from the apparatus.
11. Only use attachments/accessories specified by the manufacturer.
12. Use only with the cart, stand, tripod, bracket, or table specified by the manufacturer, or sold with the apparatus. When a cart is used, use caution when moving the cart/apparatus combination to avoid injury from tip-over.
13. Unplug this apparatus during lightning storms or when unused for long periods of time.
14. Refer all servicing to qualified service personnel. Servicing is required when the apparatus has been damaged in any way, such as power-supply cord or plug is damaged, liquid has been spilled or objects have fallen into the apparatus, the apparatus has been exposed to rain or moisture, does not operate normally, or has been dropped.
15. Batteries shall not be exposed to excessive heat such as sunshine, fire or the like.



CAUTION:

To completely disconnect this product from the mains, disconnect the plug from the wall socket outlet. The mains plug is used to completely interrupt the power supply to the unit and must be within easy access by the user.

PRECAUTION:

Pour déconnecter complètement ce produit du courant secteur, débranchez la prise de la prise murale. La prise secteur est utilisée pour couper complètement l'alimentation de l'appareil et l'utilisateur doit pouvoir y accéder facilement.

PRECAUCIÓN:

Para desconectar completamente este producto de la alimentación eléctrica, desconecte el enchufe del enchufe de la pared. El enchufe de la alimentación eléctrica se utiliza para interrumpir por completo el suministro de alimentación eléctrica a la unidad y debe de encontrarse en un lugar al que el usuario tenga fácil acceso.

FCC INFORMATION (For US customers)

1. COMPLIANCE INFORMATION

Product Name: Super Audio CD Player
 Model Number: SA-14S1
 This product complies with Part 15 of the FCC Rules. Operation is subject to the following two conditions: (1) this product may not cause harmful interference, and (2) this product must accept any interference received, including interference that may cause undesired operation.
 Marantz America, LLC.
 (a D&M Holdings Company)
 100 Corporate Drive,
 Mahwah, NJ, 07430, U.S.A.
 Tel. 201-762-6500

2. IMPORTANT NOTICE: DO NOT MODIFY THIS PRODUCT

This product, when installed as indicated in the instructions contained in this manual, meets FCC requirements. Modification not expressly approved by marantz may void your authority, granted by the FCC, to use the product.

3. NOTE

This product has been tested and found to comply with the limits for a Class B digital device, pursuant to Part 15 of the FCC Rules. These limits are designed to provide reasonable protection against harmful interference in a residential installation.

This product generates, uses and can radiate radio frequency energy and, if not installed and used in accordance with the instructions, may cause harmful interference to radio communications. However, there is no guarantee that interference will not occur in a particular installation. If this product does cause harmful interference to radio or television reception, which can be determined by turning the product OFF and ON, the user is encouraged to try to correct the interference by one or more of the following measures:

- Reorient or relocate the receiving antenna.
- Increase the separation between the equipment and receiver.
- Connect the product into an outlet on a circuit different from that to which the receiver is connected.
- Consult the local retailer authorized to distribute this type of product or an experienced radio/TV technician for help.

For Canadian customers:

CAN ICES-3(B)/NMB-3(B)

NOTE ON USE / OBSERVATIONS RELATIVES A L'UTILISATION / NOTAS SOBRE EL USO

WARNINGS	AVERTISSEMENTS	ADVERTENCIAS
<ul style="list-style-type: none"> • Avoid high temperatures. • Allow for sufficient heat dispersion when installed in a rack. • Handle the power cord carefully. • Hold the plug when unplugging the cord. • Keep the unit free from moisture, water, and dust. • Unplug the power cord when not using the unit for long periods of time. • Do not obstruct the ventilation holes. • Do not let foreign objects into the unit. • Do not let insecticides, benzene, and thinner come in contact with the unit. • Never disassemble or modify the unit in any way. • Ventilation should not be impeded by covering the ventilation openings with items, such as newspapers, tablecloths or curtains. • Naked flame sources such as lighted candles should not be placed on the unit. • Observe and follow local regulations regarding battery disposal. • Do not expose the unit to dripping or splashing fluids. • Do not place objects filled with liquids, such as vases, on the unit. • Do not handle the mains cord with wet hands. • When the switch is in the OFF position, the equipment is not completely switched off from MAINS. • The equipment shall be installed near the power supply so that the power supply is easily accessible. • Do not keep the battery in a place exposed to direct sunlight or in places with extremely high temperatures, such as near a heater. 	<ul style="list-style-type: none"> • Eviter des températures élevées. • Tenir compte d'une dispersion de chaleur suffisante lors de l'installation sur une étagère. • Manipuler le cordon d'alimentation avec précaution. • Tenir la prise lors du débranchement du cordon. • Protéger l'appareil contre l'humidité, l'eau et la poussière. • Débrancher le cordon d'alimentation lorsque l'appareil n'est pas utilisé pendant de longues périodes. • Ne pas obstruer les trous d'aération. • Ne pas laisser des objets étrangers dans l'appareil. • Ne pas mettre en contact des insecticides, du benzène et un diluant avec l'appareil. • Ne jamais démonter ou modifier l'appareil d'une manière ou d'une autre. • Ne pas recouvrir les orifices de ventilation avec des objets tels que des journaux, nappes ou rideaux. Cela entraverait la ventilation. • Ne jamais placer de flamme nue sur l'appareil, notamment des bougies allumées. • Veuillez à respecter les lois en vigueur lorsque vous jetez les piles usagées. • L'appareil ne doit pas être exposé à l'eau ou à l'humidité. • Ne pas poser d'objet contenant du liquide, par exemple un vase, sur l'appareil. • Ne pas manipuler le cordon d'alimentation avec les mains mouillées. • Lorsque l'interrupteur est sur la position OFF, l'appareil n'est pas complètement déconnecté du SECTEUR (MAINS). • L'appareil sera installé près de la source d'alimentation, de sorte que cette dernière soit facilement accessible. • Ne placez pas la pile dans un endroit exposé à la lumière directe du soleil ou dans des endroits présentant des températures extrêmement élevées, par exemple près d'un radiateur. 	<ul style="list-style-type: none"> • Evite altas temperaturas. • Permite la suficiente dispersión del calor cuando está instalado en la consola. • Maneje el cordón de energía con cuidado. • Sostenga el enchufe cuando desconecte el cordón de energía. • Mantenga el equipo libre de humedad, agua y polvo. • Desconecte el cordón de energía cuando no utilice el equipo por mucho tiempo. • No obstruya los orificios de ventilación. • No deje objetos extraños dentro del equipo. • No permita el contacto de insecticidas, gasolina y diluyentes con el equipo. • Nunca desarme o modifique el equipo de ninguna manera. • La ventilación no debe quedar obstruida por haberse cubierto las aperturas con objetos como periódicos, manteles o cortinas. • No deberán colocarse sobre el aparato fuentes inflamables sin protección, como velas encendidas. • A la hora de deshacerse de las pilas, respete la normativa para el cuidado del medio ambiente. • No exponer el aparato al goteo o salpicaduras cuando se utilice. • No colocar sobre el aparato objetos llenos de líquido, como jarras. • No maneje el cable de alimentación con las manos mojadas. • Cuando el interruptor está en la posición OFF, el equipo no está completamente desconectado de la alimentación MAINS. • El equipo se instalará cerca de la fuente de alimentación de manera que resulte fácil acceder a ella. • No coloque las pilas en un lugar expuesto a la luz directa del sol o donde la temperatura sea extremadamente alta, como cerca de una calefacción.

CAUTIONS ON INSTALLATION
PRÉCAUTIONS D'INSTALLATION
EMPLAZAMIENTO DE LA INSTALACIÓN

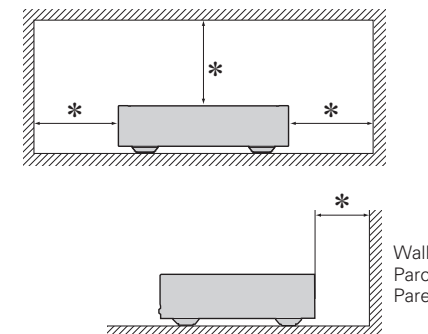

- * **For proper heat dispersal, do not install this unit in a confined space, such as a bookcase or similar enclosure.**
 - More than 4 in. (0.1 m) is recommended.
- * **Pour permettre la dissipation de chaleur requise, n'installez pas cette unité dans un espace confiné tel qu'une bibliothèque ou un endroit similaire.**
 - Une distance de plus de 4 po (0.1 m) est recommandée.
- * **Para la dispersión del calor adecuadamente, no instale este equipo en un lugar confinado tal como una librería o unidad similar.**
 - Se recomienda dejar más de 4 pulg. (0.1 m) alrededor.

PROPOSITION 65 WARNING (California only)

This product contains a chemical known to the State of California to cause cancer and birth defects or other reproductive harm. For more information go to www.p65warnings.ca.gov

Preparation

Thank you for purchasing this Marantz product. To ensure proper operation, please read this owner's manual carefully before using the product. After reading the manual, be sure to keep it for future reference.

Contents

Preparation1	Playback13	Settings24
Accessories2	Basic operation13	Menu map24
About the remote control2	Turning the power on.....13	Menu operation.....24
Inserting the batteries.....2	Switching the input source.....13	Timer Play24
Operating range of the remote control.....2	Switching the sound mode (Playback layer).....13	Play File25
Cautions on handling3	Playing CDs14	Disc.....25
Features3	Playing Super Audio CDs or CDs.....14	USB.....25
Part names and functions4	Having the display and the illumination lamp off.....15	Disp Info25
Front panel.....4	Having the illumination lamp always off.....15	iPod.....25
Display.....5	Switching the display.....15	USB.....25
Rear panel.....5	Repeat playback.....15	iPod Ctrl25
Remote control.....6	Random playback.....16	USB Resume25
	Playing tracks in a specific order	Digital Out25
	(Program playback).....16	Auto Standby25
	Stopping digital outputs.....16	
	Playing DATA CDs17	
	Playing files.....17	
	Playback iPod18	
	Playing an iPod.....18	
	Disconnecting the iPod.....18	
	Playing a USB memory device19	
	Playing files stored on USB memory devices.....19	
	Removing the USB memory device.....19	
	Using as a D/A converter20	
	Connecting and playing back from a computer	
	(USB-DAC).....20	
	Connect and playback from a devices	
	with digital audio connectors (Coaxial/Optical).....23	
	Specifying the desired sound quality23	
	Switching the filter characteristics.....23	
Connections8		Tips26
Cables used for connections8		Tips26
Connecting to a stereo audio amplifier8		Troubleshooting26
Connecting to a device with digital audio input connectors9		
Connecting to a device with digital audio output connectors9		
Connecting an iPod or USB memory device to the USB port10		
Connecting a PC or Mac11		
Remote control connection11		
Connecting the timer device12		
Connecting the power cord12		
		Appendix30
		Playable media30
		Discs.....30
		DATA CD.....30
		USB memory device.....30
		Playback order of files
		(DATA CD / USB memory device).....31
		About Folders and Files.....31
		D/A converter.....31
		Cautions on using media32
		Inserting a disc.....32
		How to handle media32
		Cleaning discs33
		Explanation of terms33
		Specifications34
		Index34

Accessories

Check that the following parts are supplied with the product.

① Owner's manual.....	1
② Warranty card (for USA)	1
③ Warranty card (for CANADA)	1
④ Power cord.....	1
⑤ Audio cable	1
⑥ Remote control cable.....	1
⑦ Remote control (RC001PMSA)	1
⑧ R03/AAA batteries	2

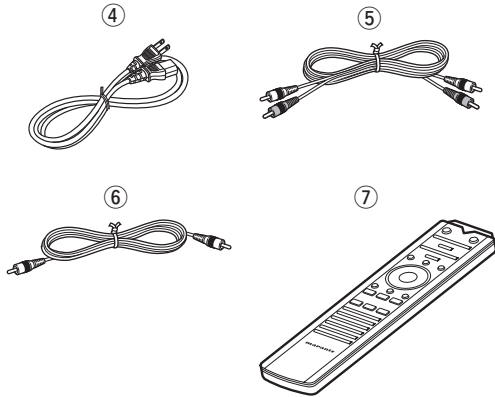

About the remote control

Inserting the batteries

- ① Remove the rear cover of the remote control.
- ② Set two R03/AAA batteries in the battery compartment in the indicated direction.

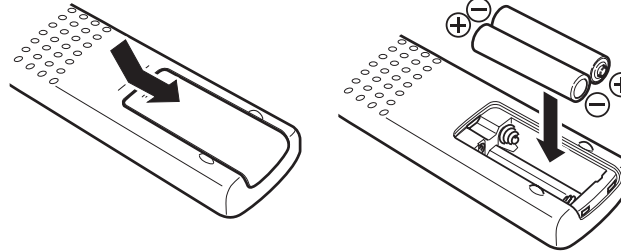

- ③ Put the rear cover back on.

NOTE

- Replace the batteries with new ones if the unit does not operate even when the remote control is operated close to the unit.
- The supplied batteries are only for verifying operation.
- Insert the batteries in the proper direction, following the ⊕ and ⊖ marks in the battery compartment.
- To prevent damage or leakage of battery fluid:
 - Do not use a new battery with an old one.
 - Do not use two different types of batteries.
 - Do not attempt to charge dry batteries.
 - Do not short-circuit, disassemble, heat or dispose of batteries in a fire.
 - Do not keep the battery in a place exposed to direct sunlight or in places with extremely high temperatures, such as near a heater.
- If the battery fluid leaks, carefully wipe the fluid off the inside of the battery compartment and insert new batteries.
- Remove the batteries from the remote control if it will not be used for a long time.
- Dispose of batteries in accordance with local regulations on battery disposal.
- The remote control unit may function improperly if rechargeable batteries are used.

Operating range of the remote control

Operate the remote control while pointing it at the remote sensor.

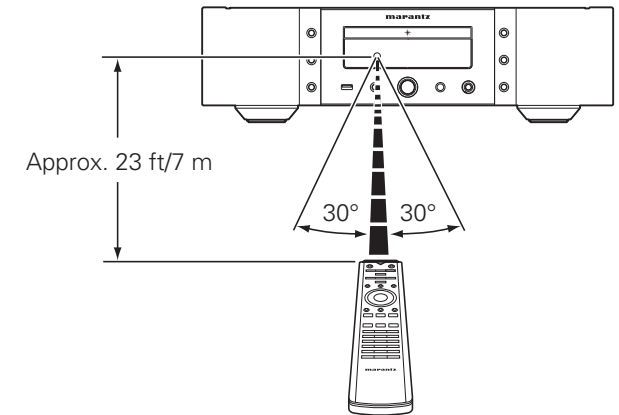

NOTE

The unit may function improperly or the remote control may not operate if the remote control sensor is exposed to direct sunlight or strong artificial light from a fluorescent or infrared light.

Cautions on handling

• Before turning the power switch on

Check once again that all connections are correct and that there are no problems with the connection cables.

- When leaving home for long periods of time, be sure to unplug the power cord from the power outlet.

• Proper ventilation

If the unit is left in a room full of the smoke from cigarettes, etc., for long periods of time, the surface of the optical pickup may get dirty, preventing it from receiving the signals properly.

• About condensation

If there is a major difference in temperature between the inside of the unit and its surroundings, condensation may form on parts inside the unit, causing the unit to fail to operate properly.

If this happens, let the unit sit for an hour or two with the power off and wait until there is little difference in temperature before using the unit.

• Cautions on using mobile phones

Using a mobile phone near this unit may result in noise. If that occurs, move the mobile phone away from the unit when it is in use.

• Moving the unit

Turn off the power and unplug the power cord from the power outlet.

Next, disconnect the cables connected to other system units before moving the unit.

Features

Equipped with a USB-DAC function to support DSD file playback

This unit is equipped with a USB-DAC function that supports DSD signals and 192 kHz/24 bit PCM signals. You can enjoy high-quality audio playback from this unit's D/A converter by inputting PCM signal or DSD signal music files into this unit from a computer via USB connection.

- Install the dedicated driver software onto the computer before use (page 20).
- You can use whichever commercially available or downloadable player software you like to playback files on your computer.

Toroidal transformer

This unit features a toroidal transformer that produces less vibration and magnetic leakage flux compared to conventional power transformers. The materials and manufacturing process of the ring-shaped core are strictly controlled to reduce vibration, while the short-ring attached to the perimeter of the transformer reduce magnetic leakage flux.

Large-capacitance block capacitor

A large capacitance 4700 μ F capacitor carefully selected for its acoustic characteristics is incorporated into the power supply circuit.

Audiophile-grade film capacitors and electrolytic capacitors

The unit's features the same audiophile-grade film capacitors and electrolytic capacitors specifically used in top-range models.

Low-noise low-distortion filter circuit and highspeed HDAM[®]SA2-type output amplifier with the differential input type HDAM[®]

Double-layered chassis

High-grade machined analog audio output connectors

Playback of CD-R/CD-RW discs (MP3/WMA) and USB memory devices (MP3/WMA/WAV/AAC)/ iPod[®]/iPhone[®]

Can be used as a D/A convertor

Digital audio signals input from an external device or computer into this unit can be converted and output as analog signals using this unit's D/A converter.

Features

Peripheral circuitry off function minimizes audio output signal interference

In order to minimize noise from peripheral circuitry which could interfere with the analog audio signal, this unit is equipped with a peripheral circuitry off function which turns off the digital output circuit, the display, and the illumination lamp.

Filter switching function

Switching between 2 types of filter characteristics is possible during playback in the Super Audio CD and CD/DAC modes, allowing the listener to enjoy different shadings of the music.

Headphone circuit component upgrade

The high-grade headphone circuit incorporates HDAM®SA2 amplifier to enable headphone listening of high quality sound reproduction, late at night or in other such situations.

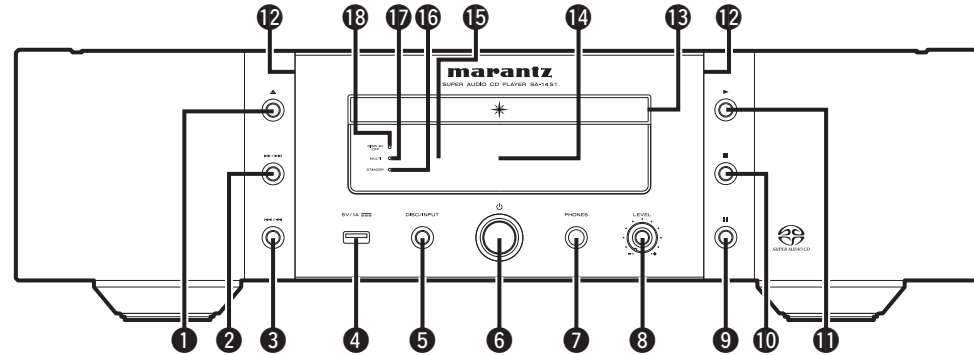
iPod auto detect charges your device even after this unit switches to standby mode**Auto Standby mode for energy savings****Part names and functions****Front panel****1 Disc tray open/close button (▲)**

Opens and closes the disc tray (☞ page 14).

2 Fast forwarding/Forward-skip button (▶▶/▶▶▶)

Plays the next track. Press and hold to fast-forward the track (☞ page 14, 18, 19).

3 Fast reversing/Reverse-skip button (◀◀/◀◀◀)

Returns to the start of the currently playing track. Press and hold to fast-reverse the track (☞ page 14, 18, 19).

4 USB port

Used to connect USB storages (such as USB memory devices) and the USB cable supplied with iPod (☞ page 10).

5 Input source select button (DISC/INPUT)

This selects the input source (☞ page 13).

6 Power operation button (⏻)

This turns the power on/off (☞ page 13).

7 Headphones jack (PHONES)

Used to connect headphones.

8 Headphone volume control knob (LEVEL)

Adjusts the headphone volume.

NOTE

To prevent hearing loss, do not raise the volume level excessively when using headphones.

9 Pause button (⏸)

Pauses playback (☞ page 14, 18, 19).

10 Stop button (■)

Stops playback (☞ page 14, 18, 19).

11 Play button (▶)

Starts playback (☞ page 14, 18, 19).

12 Illumination lamp

The illumination lamp lights (blue).

13 Disc tray

Used to insert a disc (☞ page 14).

14 Display

This displays various pieces of information (☞ page 5).

15 Remote control sensor

This receives signals from the remote control unit (☞ page 2).

16 STANDBY indicator

This is lit as follows according to the power status.

(☞ page 13) :

- Power on : Off
- Standby : Red
- iPod charge standby : Orange
- Power off: Off

17 Multi layer indicator (MULTI)

This indicator lights up when the Multi channel area of a Super Audio CD is selected (☞ page 13).

18 DISPLAY OFF indicator

This indicator lights up when the display is turned off (☞ page 15).

Display

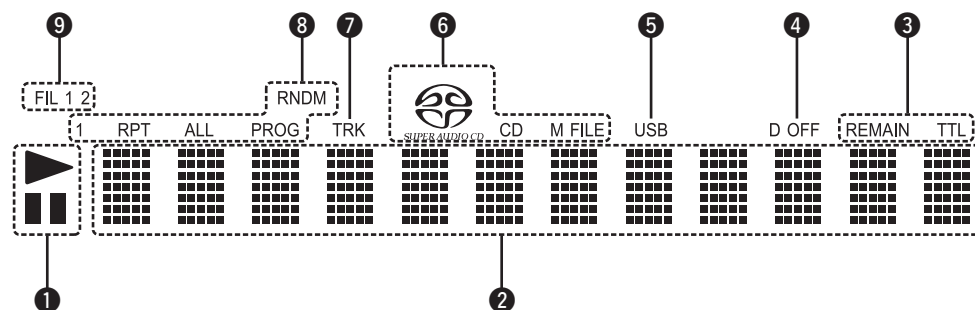

1 Play mode indicator

- ⏸ : This indicator lights up during pause.
- ▶ : This indicator lights up during playback.

2 Main display area

This area displays the time display and text information of the disc to be played, as well as the setting menu items, etc.

3 Time mode indicator

REMAIN : This indicator lights up while the remaining track time is displayed.

TTL : This indicator lights up while the total remaining time.

4 Digital output off indicator (D OFF)

This indicator lights up when the digital output setting is set to off (🔧 page 16).

5 USB indicator

This indicator lights up during operation in the USB mode.

6 Disc indicator

This indicator displays the disc type which is currently in the disc tray. "M FILE" lights up if the disc contains WMA/MP3 files.

7 TRK indicator

This indicator lights up above the display of the track number currently being played.

8 Special play mode indicator

1 : This indicator lights up during repeat play of one track.

RPT : This indicator lights up during repeat play.

ALL : This indicator lights up during repeat play of all tracks.

RNDM : This indicator lights up during random play.

PROG : This indicator lights up during program play.

9 Filter indicator (FIL 1 2)

This indicator shows which filter (Filter 1 or Filter 2) is selected (🔧 page 23).

Rear panel

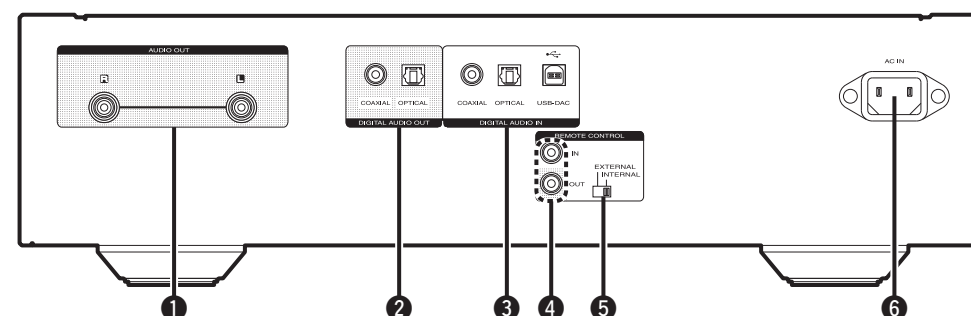

1 AUDIO OUT connectors

Used to connect to an amplifier (🔧 page 8).

2 DIGITAL AUDIO OUT connectors (COAXIAL/OPTICAL)

Used to connect to a device with digital audio input connectors (🔧 page 9).

3 DIGITAL AUDIO IN connectors (COAXIAL/OPTICAL/USB-DAC)

Used to connect to a device with digital audio output connectors or a PC (🔧 page 9).

4 REMOTE CONTROL IN / OUT connectors

Used to connect to a Marantz amplifier that is compatible with the remote control function (🔧 page 11).

5 EXTERNAL/INTERNAL switch

Turn this switch to "EXTERNAL" to operate the unit by pointing the remote control at the amplifier connected to this unit using the remote control connection (🔧 page 11).

6 AC inlet (AC IN)

Used to connect the power cord (🔧 page 12).

Remote control

Buttons for Super Audio CD player

To operate CD, press the CD MODE button to switch the remote control to the CD operation mode.

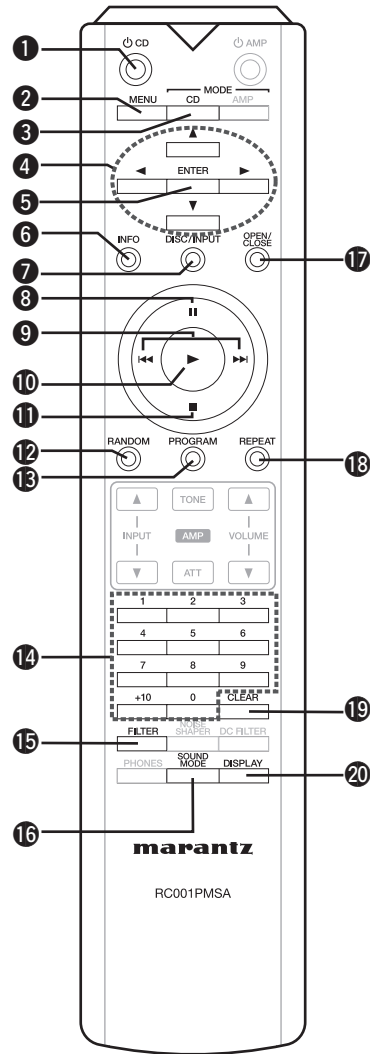

1 Super Audio CD player power button (⏻ CD)

This turns the power on/off (Standby) (👉 page 13).

2 MENU button

This displays the menu (👉 page 24).

3 Remote control mode button (CD MODE)

This switches the remote control operating mode to CD (👉 page 26).

4 Cursor buttons (⬆️⬇️⬇️⬆️)

These select items (👉 page 18, 19, 24).

5 ENTER button

This determines the selection (👉 page 18, 19, 24).

6 Information display button (INFO)

This switches the track information shown in the display during playback (👉 page 15).

7 Input source select button (DISC/INPUT)

This switches the input source (👉 page 13).

8 Pause button (⏸️)

Pauses playback (👉 page 14, 18, 19).

9 Reverse-skip/Forward-skip buttons (⏮️, ⏭️)

This skips to the start of the track. Press and hold to fast-forward/fast reverse (👉 page 14, 18, 19).

10 Playback button (▶️)

Starts playback (👉 page 14, 18, 19).

11 Stop button (■)

Stops playback (👉 page 14, 18, 19).

12 RANDOM button

This switches random playback on/off (👉 page 16, 19).

13 PROGRAM button

This sets program playback (👉 page 16).

14 Number buttons (0 – 9, +10)

These select tracks by specifying the track number (👉 page 14).

15 FILTER button

This switches the filter characteristics (👉 page 23).

16 SOUND MODE button

This switches the playback layer or area of a Super Audio CD (👉 page 13).

17 Disc tray open/close button (OPEN/CLOSE)

Opens and closes the disc tray (👉 page 14).

18 REPEAT button

Switches the repeat playback (👉 page 15, 19).

19 CLEAR button

This clears the program registration (👉 page 16).

20 DISPLAY button

This switches the display on/off (👉 page 15).

Buttons for amplifier

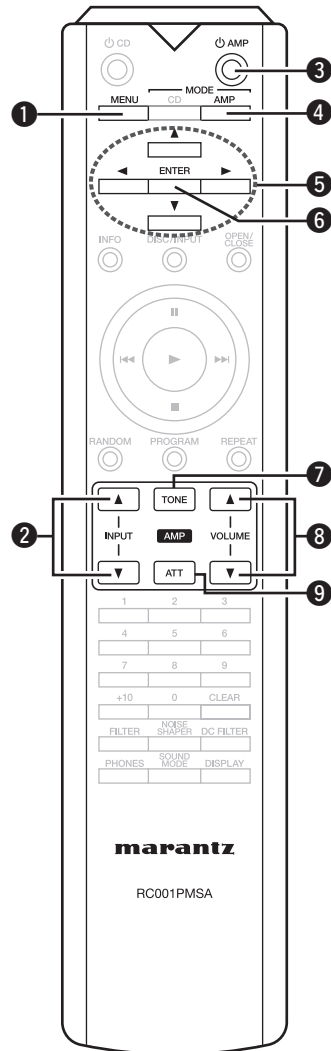

- 1 MENU button
- 2 Input source select button (INPUT)
- 3 Amplifier power button (AMP)
- 4 Remote control mode switch button (MODE AMP)
- 5 Cursor buttons (△▽◀▶)
- 6 ENTER button
- 7 Tone switch button (TONE)
- 8 Volume buttons (VOLUME ▲▼)
- 9 Attenuator button (ATT)



- The supplied remote control can operate Marantz amplifiers.
- When using it, also refer to the operating instructions of the other devices.

NOTE

The remote control may not operate some devices.

Connections

NOTE

- Do not plug in the power cord until all connections have been completed.
- When making connections, also refer to the owner's manual of the other components.
- Be sure to connect the left and right channels properly (left with left, right with right).
- Do not bundle power cords together with connection cables. Doing so can result in humming or noise.

Cables used for connections

Provide necessary cables according to the devices you want to connect.

Audio cable	
Optical cable	
Coaxial cable	
USB cable	
Remote connector cable	

Connecting to a stereo audio amplifier

Use this connection for audio playback via a stereo audio amplifier.

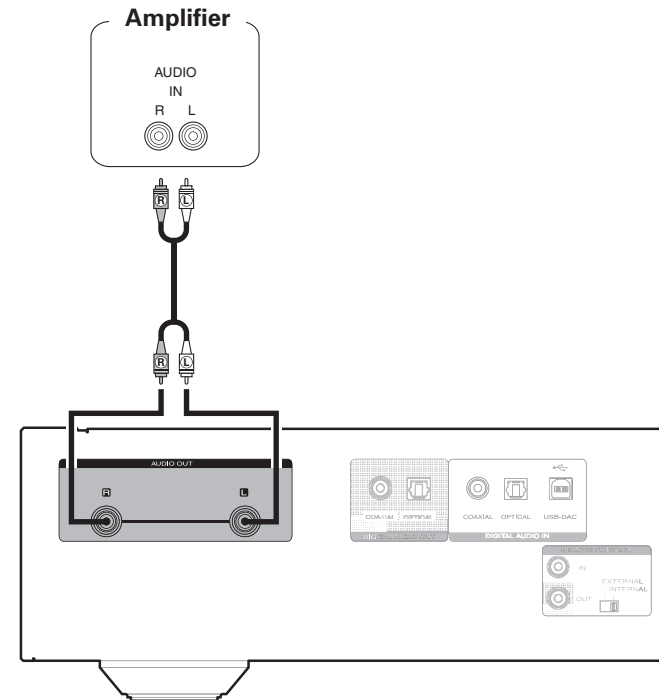

Connecting to a device with digital audio input connectors

You can connect an AV receiver or D/A converter with digital audio input connectors to this unit to enjoy digital audio.

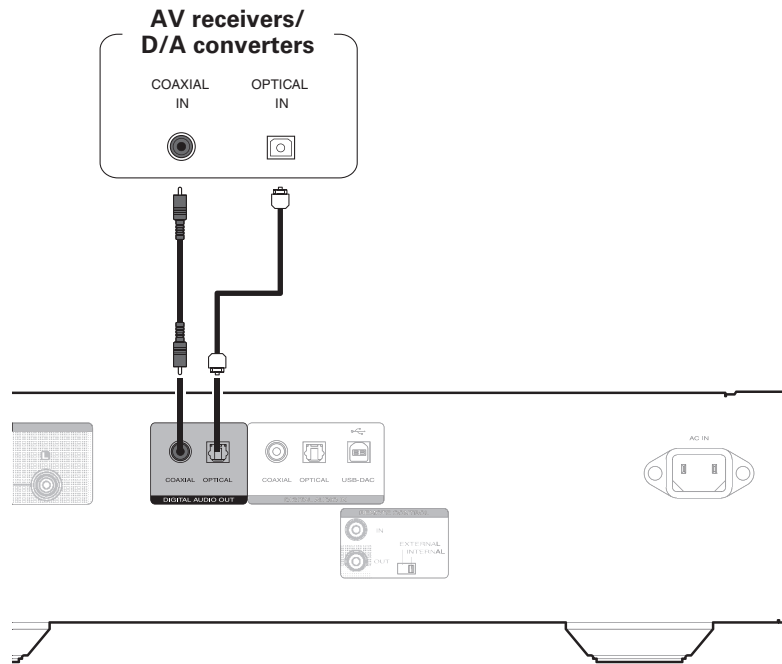

Connecting to a device with digital audio output connectors

This unit can be used as a D/A converter ("Using as a D/A converter" (page 20)).

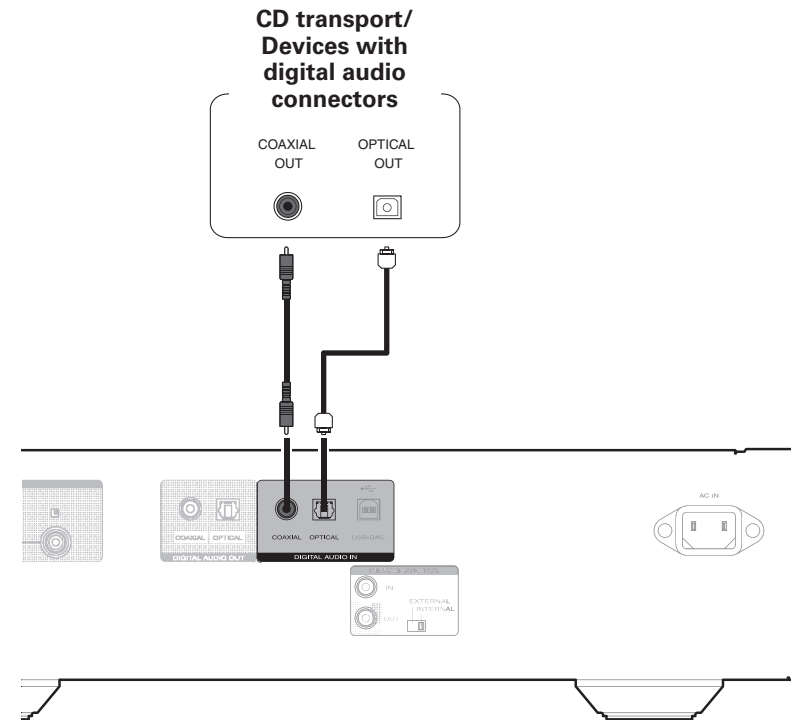

NOTE

- Signals on the HD layer of the Super Audio CD cannot be output in digital output. Signals that can be output using digital output are digital audio signals from audio CDs, CD layers of Super Audio CDs, USB, iPod, USB-DAC, COAXIAL, and OPTICAL.
- When the input source is USB-DAC, digital audio output stops when signals with a sampling frequency of 32 kHz and DSD signals are played back.

NOTE

- Linear PCM signals with a sampling frequency of 32 kHz, 44.1 kHz, 48 kHz, 64 kHz, 88.2 kHz, 96 kHz, 176.4 kHz, or 192 kHz can be input into this device.
- Do not input signals other than linear PCM signals, such as Dolby digital, DTS, AAC etc. into this device. Doing so may cause noise, which may cause damage to the speakers.

Connecting an iPod or USB memory device to the USB port

You can enjoy music stored on an iPod or USB memory device.

- To connect an iPod to this unit, use the USB adapter cable that was supplied with the iPod.
- For operating instructions see "Playback iPod" (page 18) or "Playing a USB memory device" (page 19).

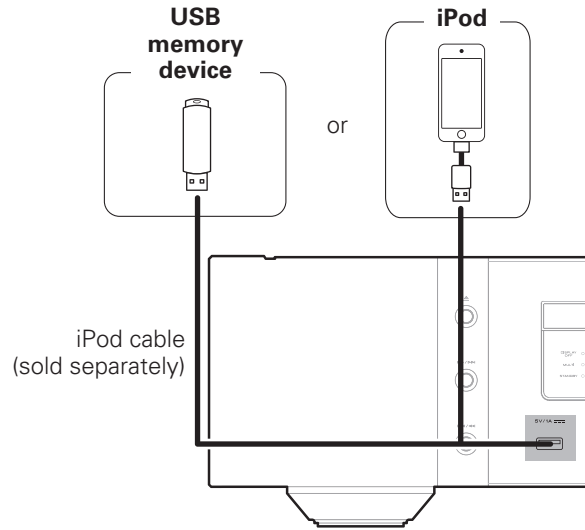

Marantz does not guarantee that all USB memory devices will operate or receive power. When using a portable USB hard disk drive (HDD) which came with an AC adapter, use that device's supplied AC adapter.

NOTE

- USB memory devices will not work via a USB hub.
- It is not possible to use this unit by connecting the unit's USB port to a PC via a USB cable.
- Do not use an extension cable when connecting a USB memory device. This may cause radio interference with other devices.

Supported iPod/iPhone models

• iPod classic



iPod classic
80GB



iPod classic
160GB (2007)



iPod classic
160GB (2009)

• iPod nano



iPod nano
3rd generation
(video)
4GB 8GB



iPod nano
4th generation (video)
8GB 16GB



iPod nano
5th generation (video camera)
8GB 16GB



iPod nano
6th generation
8GB 16GB



iPod nano
7th generation
16GB

• iPod touch



iPod touch
1st generation
8GB 16GB 32GB



iPod touch
2nd generation
8GB 16GB 32GB



iPod touch
3rd generation
32GB 64GB



iPod touch
4th generation
8GB 32GB 64GB



iPod touch
5th generation
32GB 64GB

• iPhone



iPhone
4GB 8GB 16GB



iPhone 3G
8GB 16GB



iPhone 3GS
8GB 16GB 32GB



iPhone 4
8GB 16GB 32GB



iPhone 4S
16GB 32GB 64GB



iPhone 5
16GB 32GB 64GB

Connecting a PC or Mac

By connecting a computer to the USB port on the rear panel of this unit using a commercially available USB connecting cable, this unit can be used as a D/A converter "Using as a D/A converter" (page 20).

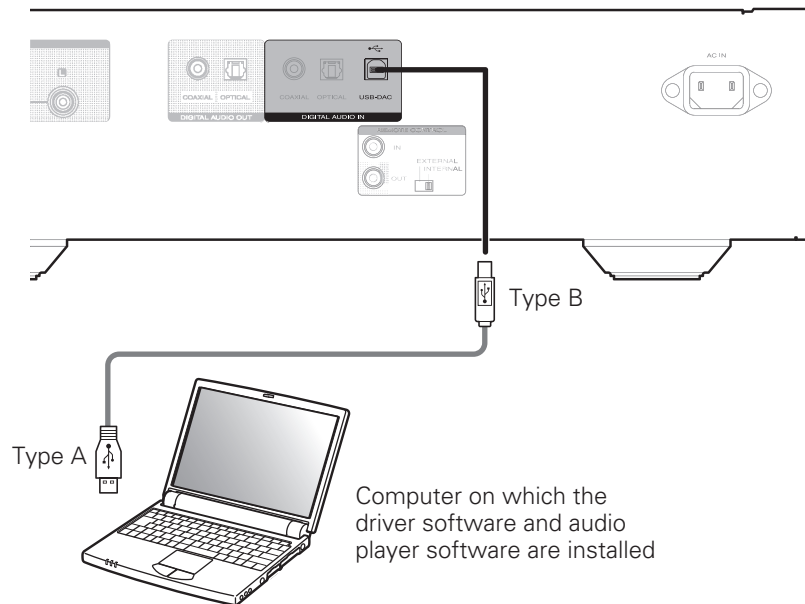

- Install the dedicated driver software on the computer to enable communication between the computer and this unit in order to playback high-resolution sound source (DSD signal or 192 kHz/24 bit PCM signal) audio available on the internet "Installing the dedicated driver (Windows OS only)" (page 20).
- Download the driver software from the SA-14S1 page of the Marantz website.

NOTE

- Use a cable that is 10 ft/3 m or less to connect to the computer.

Remote control connection

When you use this unit connected to a Marantz amplifier, this unit receives operation signals sent from the amplifier and operates accordingly.

Connection

Use the supplied remote connection cable to connect the REMOTE CONTROL IN connector of this unit to REMOTE CONTROL OUT connector of the amplifier.

Setting

Set the remote control switch on the rear panel of this unit to "EXTERNAL" to use this feature.

- This setting will disable remote sensor reception of this unit.
- To operate the unit, point the remote control at the remote sensor of the amplifier.



To use this unit without connecting it to the amplifier, set the remote control switch to "INTERNAL".

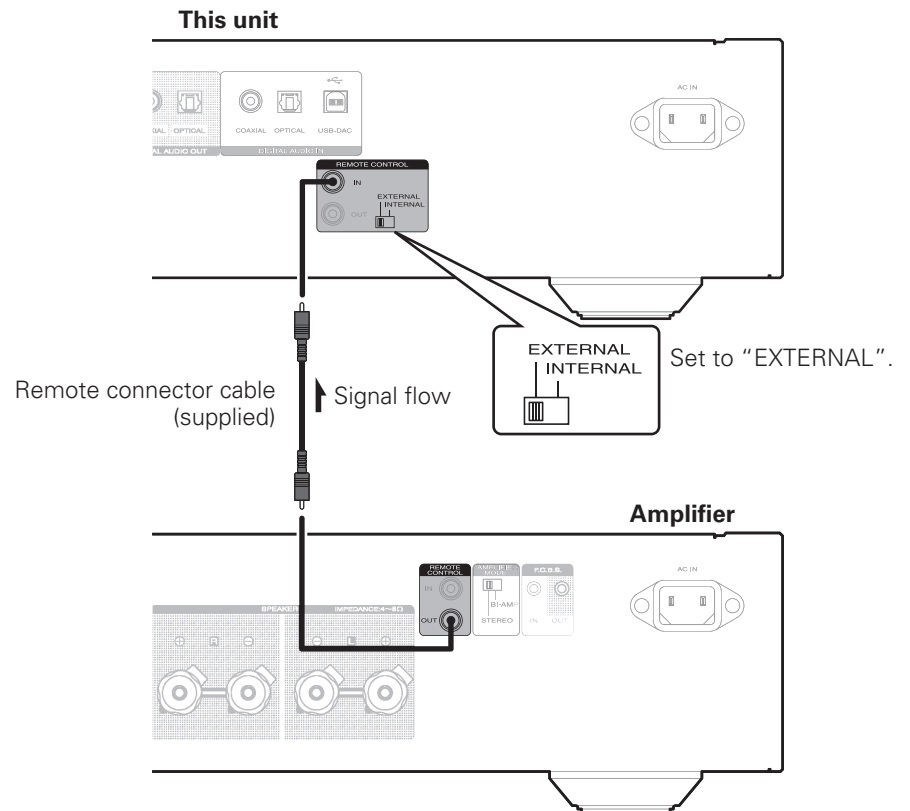

Connecting the timer device

This unit can perform timer play when an amplifier and timer device are connected to this unit (see page 24 "Timer Play").

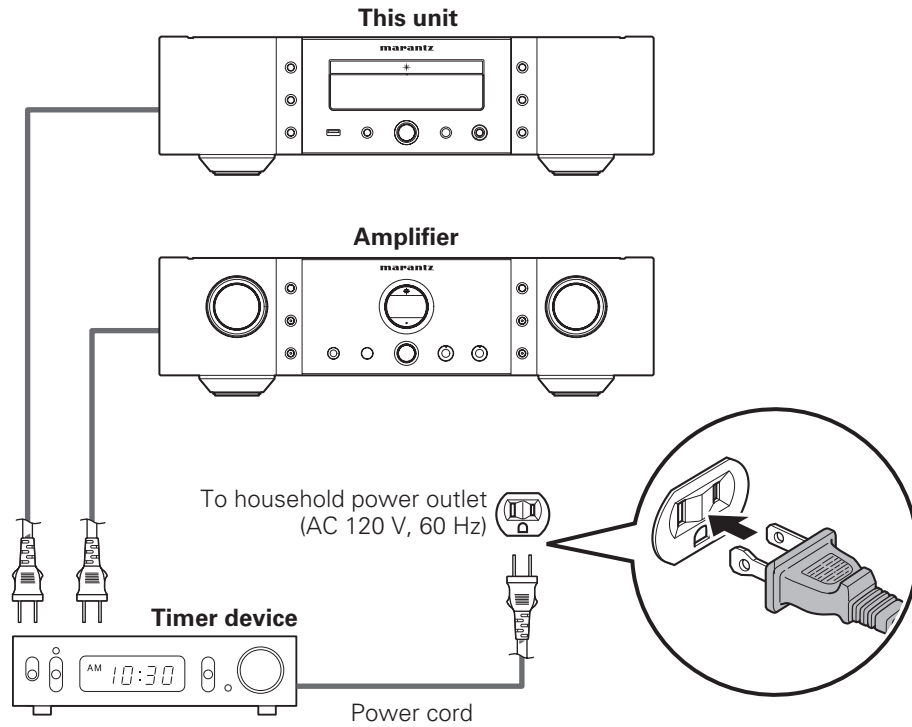

Connecting the power cord

Do not plug in the power cord until all connections have been completed.

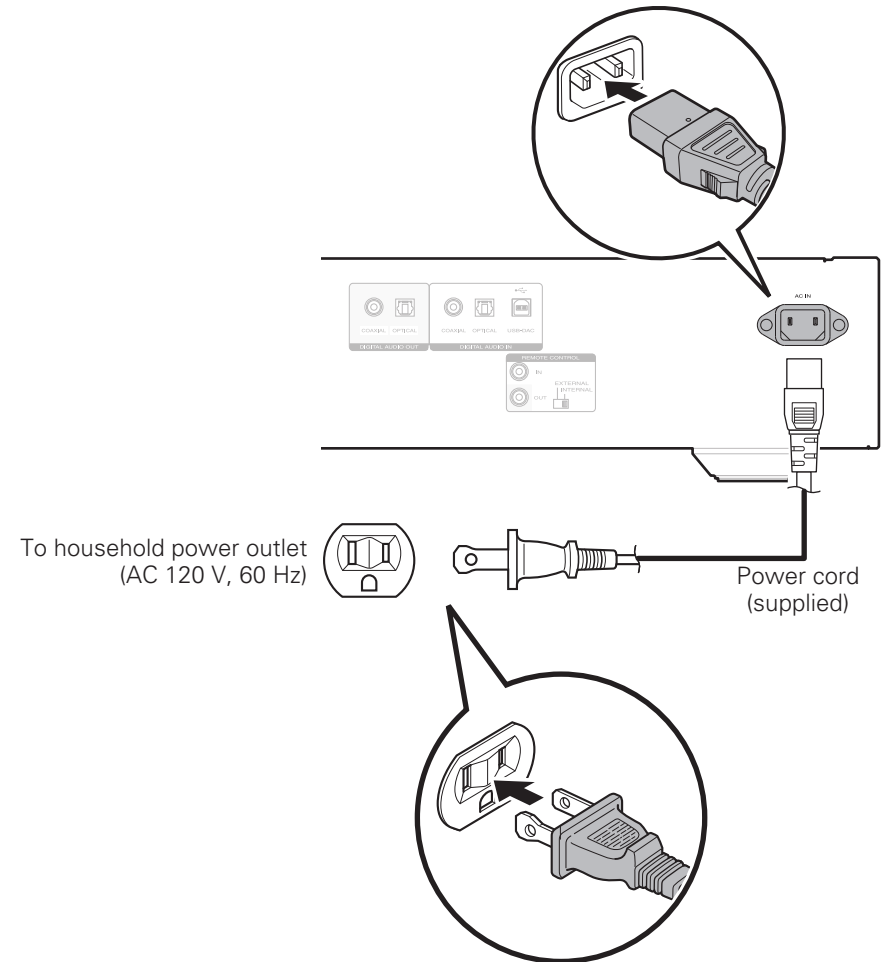

NOTE

- Insert the plugs securely. Loose connections will result in the generation of noise.
- Do not unplug the power cord while the unit is operating.
- Do not use a power cord other than the cord supplied with this unit.

Playback

Basic operation

Turning the power on

Press **⏻** on the unit.

A power on status is established.

When power is switched to standby

Press **⏻** CD.

A standby status is then established.

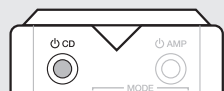

Before setting power to standby, make sure the disc tray is completely closed.

NOTE

- Do not force the tray in by hand while power is set to standby. This could cause a trouble.
- Even when power is set to standby, electrical current passes through some circuits. If you do not intend to use the unit for an extended period of time, unplug the power cord from the household power outlet.

Turning the power off

Press **⏻** on the unit.

The power turns off.

Switching the input source

This unit supports the following playback functions in addition to disc playback.

- Digital audio input signal playback
 - USB memory device file playback from the USB port in the front panel
 - iPod file playback from the USB port in the front panel
 - Computer file playback from the USB port in the rear panel
- Before playing back files from a connected device, perform the following operation to switch the input source.

Press **DISC/INPUT** to select the input source.

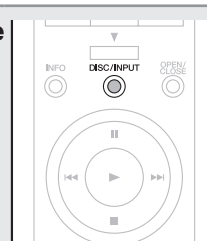

[Selectable modes]

Disc : Plays back the disc inside the disc tray (page 14).

USB : Plays back files on the device connected to the USB port on the front panel (page 18, 19).

USB-DAC : Connect a computer to the USB port (USB-DAC) on the rear panel, and use this unit as a D/A converter (page 20).

Coaxial : Connect a digital device to the COAXIAL connector on the rear panel, and use this unit as a D/A converter (page 23).

Optical : Connect a digital device to the OPTICAL connector on the rear panel, and use this unit as a D/A converter (page 23).

Switching the sound mode (Playback layer)

Some Super Audio CD discs have 2 layers. Before playback, perform the operation below to select the playback layer. For details on the Super Audio CD, see "Super Audio CD" (page 30).

1 Press DISC/INPUT to change the input source to "Disc".

2 Insert a disc.

- Press OPEN/CLOSE to open and close the disc tray.
- You can also close the disc tray by pressing **▶**, then starts playback automatically.

3 Press OPEN/CLOSE to open and close the disc tray.

4 Press SOUND MODE and switch to the layer you want to set.

[Selectable items]

STEREO : Plays back the 2-channel area of the Super Audio CD (the default setting).

MULTI : Plays back the multi-channel area of the Super Audio CD. Multi-channel is downmixed to 2-channel.

CD : Plays back the CD layer of the Super Audio CD.



❑ Setting the playback sound mode in advance (Start sound mode)

When purchased, the sound mode setting is "STEREO". The procedure for specifying a different first-priority layer is given below.

With no disc in the disc tray, press SOUND MODE, then switch to the desired layer setting.

- If a disc that does not contain the layer set for top priority playback is loaded, the contents recorded on another layer are displayed automatically.

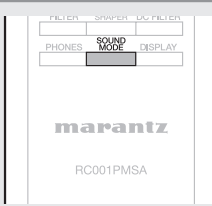

- This unit memorizes the setting. Even if you open/close the disc tray or turn this unit off and on, the setting remains in effect.
- The layer detection order is as follows for discs without an area set for the first-priority layer or discs without any layer.
 - ① STEREO
 - ② MULTI
 - ③ CD

Playing CDs

Playing Super Audio CDs or CDs

1 Press DISC/INPUT to change the input source to "Disc".

2 Insert a disc.

- Press OPEN/CLOSE to open and close the disc tray.
- You can also close the disc tray by pressing ►, then starts playback automatically.

3 When playing back a Super Audio CD, press SOUND MODE, and select the layer that you want to play back.

[Selectable items]

STEREO :Plays back the 2-channel area of the Super Audio CD (the default setting).

MULTI :Plays back the multi-channel area of the Super Audio CD. Multi-channel is downmixed to 2-channel.

CD :Plays back the CD layer of the Super Audio CD.

4 Press ►

The ► display lights, and playback begins.

- When all of the tracks recorded on the disc have finished playing back, playback stops automatically.



❑ Stopping playback

Press ■.

❑ Stopping playback temporarily

Press II.

- The II indicator lights.
- To restart playback, press ►.

❑ Fast-forwarding and Fast-reversing (Searching)

The search is started by holding down I◀◀, ▶▶I during playback.

Normal playback resumes when the button is released.

❑ Moving to the beginning of tracks (Skipping)

During playback, press I◀◀ or ▶▶I.

- The disc is skipped the number of tracks equal to the number of times the button is pressed.
- When you press I◀◀ once, playback restarts from the beginning of the current track.

❑ Playing a specific track (Direct searching)

Use 0 – 9, +10 to select the track.

Example: Track 4 : Press 4

Example: Track 12 : Press +10 and 2

Example: Track 20 : Press +10, +10 and 0

Having the display and the illumination lamp off

The display circuit operation can be stopped to minimize noise from the display and the display circuit which could interfere with the analog audio output signal.

During playback, press DISPLAY.

- Each time you press DISPLAY, the display and the illumination lamp (blue) switch on/off at the same time.

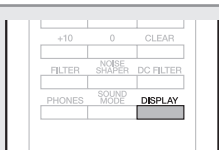

- When the display is switched off, the "DISPLAY OFF" indicator lights.
- If you press DISPLAY at any time other than during playback, the display and the illumination lamp (blue) do not light off.

NOTE

During stop mode, the display information does not turn off. The information is turned off only during playback.

Having the illumination lamp always off

The following procedure makes the illumination lamp always off regardless of the display on/off operation.

Press and hold DISPLAY for two seconds and longer while display is lighted.

- Press and hold DISPLAY for two seconds and longer while the lamp is always off to return to the normal setting.

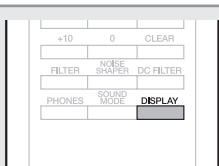

Switching the display

Displays text and time information stored on media.

- The display content varies according to the media. (The text information is only displayed for Super Audio CD.)
- The display content during playback and when stopped varies according to the media.
- Text information displays in a scroll format.
- Characters that can be displayed are uppercase/lowercase alphabets, numbers, and some symbols.

Press INFO.

The display switches each time the button is pressed.



[When stopped]

Super Audio CD :

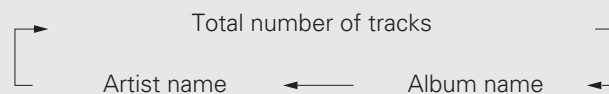

CD : Disabled

[During playback (pause)]

Super Audio CD :

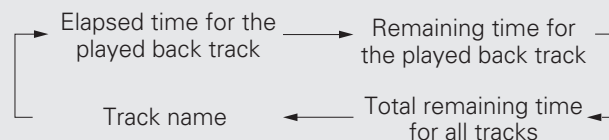

CD :

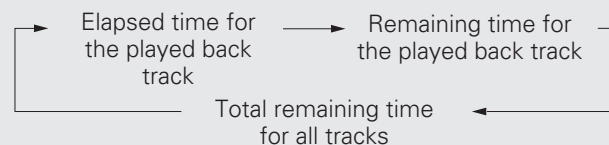

Repeat playback

Press REPEAT to select repeat mode.



[Selectable items]

Repeat 1 (1-track repeat) : Only 1 track is played repeatedly.

Repeat All (All-track repeat) : All tracks are played repeatedly.

Not Displayed (Repeat off) : Normal playback resumes.

Random playback

1 During stop mode, press **RANDOM**.

The "RNDM" indicator on the display lights.

2 Press **▶**.

The tracks start playing in random order.



❑ Stopping random playback

Press **RANDOM** during stop mode.
The "RNDM" indicator on the display goes off.

NOTE

- Each press of **▶▶** during random play changes the track in random manner.
- The random playback mode is canceled if you set power to standby, turn off power, or open the disc tray.

Playing tracks in a specific order (Program playback)

1 During stop mode, press **PROGRAM**.

"PROG" lights in the display, and the mode switches to program playback mode.

2 Use **0 – 9, +10** to select the tracks you want to program.

[Example]

To program tracks 3 and 12 to be played in that order, press 3, +10, and 2 one after the other.

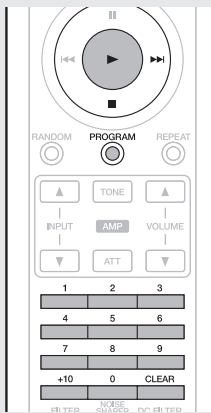

3 Press **▶**.

Playback starts in the programmed order.

❑ Adding tracks for program playback

Tracks can be added to the end of program when program is remaining ("PROG" indicator is lighting up) and in stop mode.

Use 0 – 9, +10 to select the tracks you want to program.

❑ Checking programmed track orders

While stopped, press **▶▶**.

Each time you press it, tracks are displayed in the order in which they are programmed.

❑ Canceling a track from program playback

While stopped, press **CLEAR**.

When **CLEAR** is pressed, tracks are deleted in order from the last programmed track.

❑ Clearing the all programmed track

Press **PROGRAM** during stop mode.

- Program can also be cleared by pressing **OPEN/CLOSE** on the main unit to open the disc tray.



You can specify up to 20 tracks each for program playback.

NOTE

- Programmed playback is not possible with MP3 and WMA files.
- The program playback mode is canceled if you set power to standby, turn off power, or open the disc tray.

Stopping digital outputs

Stops all media and source digital signal outputs from the rear panel's digital audio output connectors (COAXIAL, OPTICAL) to minimize digital audio output circuit noise which could interfere with the analog audio output signal.

1 During stop mode, press **MENU**.

2 Use **△▽** to select "Digital Out", and press **ENTER**.

3 Use **△▽** to select "Off", and press **ENTER**.

[Selectable items]

On : Outputs the digital signal.

Off : Digital signal is not output.

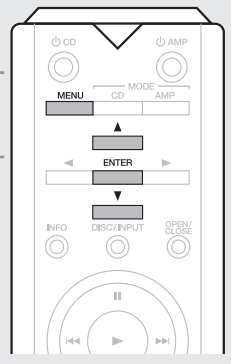

- When digital output is turned off, the "D OFF" indicator lights up on the display.
- The "Digital Out" has a memory retention function where the settings remain stored and unchanged even when the disc is changed or the power is turned off.

Playing DATA CDs

There are many music distribution sites on the Internet allowing you to download music files in MP3 or WMA (Windows Media® Audio) formats. The music (files) downloaded from such sites can be stored on CD-R or CD-RW discs and played on the unit.

Playing files

1 Load the CD-R / CD-RW containing MP3 or WMA type audio files to the disc tray (☞ page 14).

2 At the menu's "Play File" item (☞ page 25), select the "All" or "Folder".

3 Press ►. Playback starts.

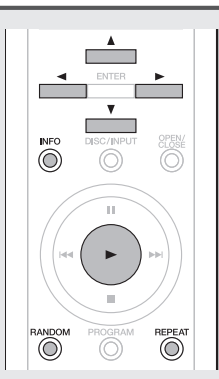

☐ Changing the playback folder

Use Δ∇ to select the desired folder.

☐ Changing the playback file

Use ◀▶ to select the desired file.

☐ Switching the display

During playback, press INFO.

☐ Playing back MP3 and WMA files randomly (random playback)

While stopped, press RANDOM.

- During random playback, the playback range becomes "All".

☐ Playing back MP3 and WMA files repeatedly (folder/disc repeat playback)

Press REPEAT.

☐ Files that can be played back

- See "DATA CD" (☞ page 30).



- Folder and file names can be displayed as titles. Up to 11 alphanumeric characters and underscores can be displayed. Characters which cannot be displayed appear as asterisks.
- The following characters can be displayed.

```
A-Z, a-z, 0-9, ! " # $ % & ; : < > ? @ \
[ ] _ ` | { } ~ ^ ' ( ) * + , - . / = (Space)
```

Playback iPod

With the unit, you can listen to music on an iPod and you can also operate the iPod with the main unit or the remote control.



“Made for iPod” and “Made for iPhone” mean that an electronic accessory has been designed to connect specifically to iPod or iPhone, respectively, and has been certified by the developer to meet Apple performance standards. Apple is not responsible for the operation of this device or its compliance with safety and regulatory standards.

iPhone, iPod, iPod classic, iPod nano, iPod shuffle, and iPod touch are trademarks of Apple Inc., registered in the U.S. and other countries.

• Individual users are permitted to use iPhone, iPod, iPod classic, iPod nano, iPod shuffle, and iPod touch for private copy and playback of non-copyrighted contents and contents whose copy and playback is permitted by law. Copyright infringement is prohibited by law.

Playing an iPod

1 Press **DISC/INPUT** to change the input source to “USB”.



2 Connect the iPod to the USB port on the front panel of this unit (page 10).

Select the mode to control

1 Press **MENU** during stop mode.

2 Use Δ/∇ to select “iPod Ctrl”, and press **ENTER**.

3 Use Δ/∇ to select the mode to operate, and press **ENTER**.

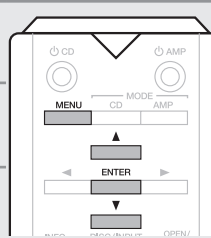

[Selectable items]

Direct : Control using the iPod.

Remote : Control using this unit and the remote control.

Display mode		Direct	Remote
Display location		iPod display	Main unit display
Playable files	Audio file	○	○
	Video file	○	×
Active buttons	Remote control and Main unit (This unit)	○	○
	iPod	○	×

Select the file to playback

Use Δ/∇ to select an item and press **ENTER** to select a music file you want to play back.

Starts the playback of selected file.

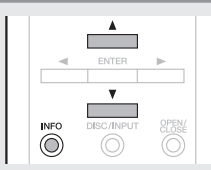

Remote control and iPod button relations

Remote control buttons	iPod buttons	Operation on the unit
▶	▶▶	Playback
⏸	⏸	Pause
■	–	Stop
⏮, ⏭	⏮, ⏭	Previous / Next
REPEAT	–	Switches the repeat function
RANDOM	–	Switches the shuffle function
INFO	–	Switches the display (Remote mode)
⏮, ⏭ (Press and hold)	⏮, ⏭ (Press and hold)	Fast-reverse / Fast-forward
Δ/∇	Click Wheel	Moves up / down the cursor
◀	Menu	Calls the menu/returns from the menu
▶ or ENTER	Select	Confirm the settings / playback

NOTE

- Marantz will accept no responsibility whatsoever for any loss of iPod data.
- Depending on the type of iPod and the software version, some functions may not operate.

Switching the display

During playback, press **INFO**.

- Switching between the title name, artist name and album name.

Disconnecting the iPod

1 Press ■.

2 Disconnect the iPod cable from the USB port.



Playing a USB memory device

Playing files stored on USB memory devices

1 Press DISC/INPUT to change the input source to "USB".

2 Connect the USB memory device to the USB port on the front panel of this unit (page 10).

3 Use Δ / ∇ to select a file/folder you want to play back and press ENTER.

4 Use Δ / ∇ to select a file and press ENTER. Playback starts.

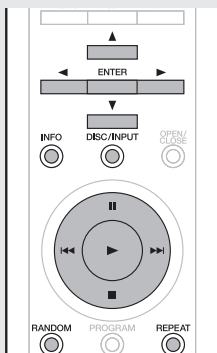

USB operation

Remote control buttons	Operation on the unit
\blacktriangleright	Playback
II	Pause
\blacksquare	Stop
Δ / ∇	Moves up / down the cursor
\triangleleft	Calls the menu / returns from the menu
$\text{I} \lll, \ggg \text{I}$	Previous / Next (Press and hold) Fast-reverse / Fast-forward
REPEAT	Switches the repeat function
RANDOM	Switches the random function
INFO	Switches the display
ENTER or \blacktriangleright	Confirm the settings/playback



- When the menu's "USB Resume" (page 25) is on, playback starts automatically when a USB memory device is connected.
- When a USB memory device is connected to this unit, playback starts automatically when "USB" input source switching occurs.

Stopping playback

Press \blacksquare .

Stopping playback temporarily

Press II .

- The II indicator lights.
- To restart playback, press \blacktriangleright .

To switch file during playback

- Use $\text{I} \lll$ or $\ggg \text{I}$ to select the file.

Fast-forwarding and fast-reversing (Searching)

Press and hold $\text{I} \lll$ or $\ggg \text{I}$ during playback.

- When you remove your finger from the button, normal playback is resumed.
- When normal playback is resumed after searching, the sound may be interrupted momentarily.

Repeat playback

Press REPEAT.

Random playback

Press RANDOM.

- To cancel random playback, press RANDOM. The "RNDM" indicator goes dark and random playback is canceled.

Switching the display

During playback, press INFO.

NOTE

- Marantz will take no responsibility whatsoever for any loss or damage to data on a USB memory device when using it connected to the unit.
- USB memory devices will not work via a USB hub.
- Marantz does not guarantee that all USB memory devices will operate or be supplied power. When using a USB portable hard disk that can draw power from an AC adapter, we recommend using the AC adapter.

Files that can be played back

- See "USB memory device" (page 30).

Removing the USB memory device

1 Press \blacksquare to stop playback.

2 Check that the communication indicator on the USB memory device is not flashing, then pull out the USB memory device.

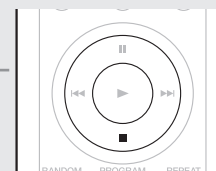

NOTE

Do not pull out the USB memory device if the communication indicator on the USB memory device is still flashing. Doing so may damage the USB memory device and the data recorded on the device.

Using as a D/A converter

Digital audio signals input from an external device or computer into this unit can be converted and output as analog signals using this unit (D/A converter).

- DSD is a registered trademark.
- Microsoft, Windows XP, Windows Vista, Windows 7 and Windows 8 are either registered trademarks or trademarks of Microsoft Corporation in the United States and/or other countries.
- Apple, Macintosh and Mac OS are trademarks of Apple Inc., registered in the U.S. and other countries.

Connecting and playing back from a computer (USB-DAC)

- You can enjoy high-quality audio playback from this unit's D/A converter by inputting PCM signal or DSD signal music files into this unit from a computer via USB connection.
- In order to use USB-DAC playback, install the dedicated driver onto your computer to enable your computer and this unit to communicate.
- Drivers do not need to be installed for Mac OS.
- Also, you can use whichever commercially available or downloadable player software you like to playback files on your computer.

❑ Installing the dedicated driver (Windows OS only)

Installing the driver software

1 Disconnect the USB cable between your computer and the unit.

- The driver software cannot be installed correctly if your computer is connected to the unit by a USB cable.
- If the unit and your computer are connected by a USB cable and the computer is switched on before installation, disconnect the USB and restart the computer.

2 Download the dedicated driver from the "Download" section of the SA-14S1 page of the Marantz website onto your computer.

3 Unzip the downloaded file, select the 32-bit or 64-bit exe file that matches your Windows operating system, and double-click the file.

4 Install the driver.

- ① Select the language to use for the installation.
- ② Click "OK".



- ③ The wizard menu is displayed. Click "Next".



- ④ Read the Software Licensing Agreement, and click "I accept the terms in the license agreement".
- ⑤ Click "Next".

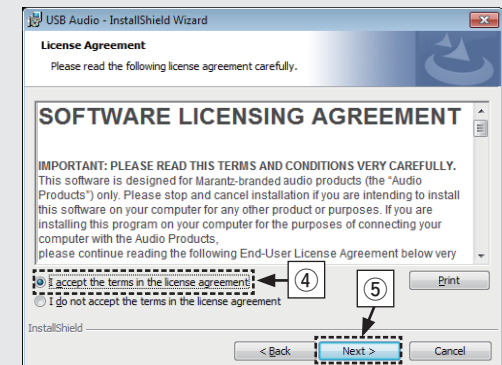

- ⑥ Click "Install" on the installation start dialog.
- The installation starts. Do not perform any operation on the computer until the installation is completed.

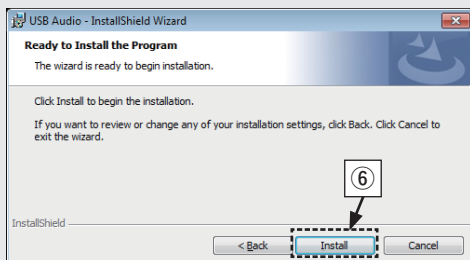

- ⑦ In the Windows security dialog, select "Always trust software from DandM Holdings Inc.".
- ⑧ Click "Install".



- ⑨ When the installation is completed, click "Finish".

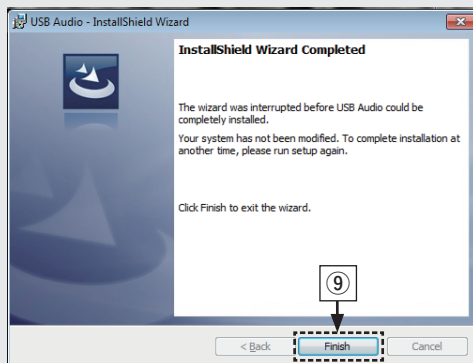

5 With the unit power off, connect the unit and computer using a USB cable (sold separately).

- For the connection procedure, refer to the "Connecting a PC or Mac" (page 11) section.

6 Press on this unit.

- When the unit power is turned on, the computer automatically finds and connects to the unit.

7 Press DISC/INPUT to change the input source to "USB-DAC" (page 13).

8 Checking the installed driver

- Click "Start" and click "Control Panel" on the computer.
 - The control panel setting list is displayed.
- Click "Sound".
 - The sound menu window is displayed.
- Check that there is a checkmark next to "Default Device" under "Marantz USB Audio" in "Speakers" of the "Playback" tab.
 - When there is a checkmark for a different device, click "Marantz USB Audio" and "Set Default".

9 Checking audio output

Outputs a TEST signal from the computer and checks the audio output from the USB-DAC function.

- Select "Speakers" and click "Properties".
 - The Speakers Properties window is displayed.

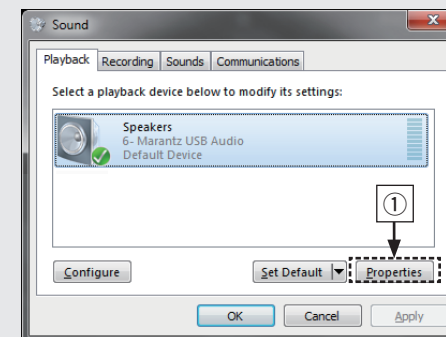

- Click "Advanced".
 - Select the sampling rate and bit rate to be applied to the D/A converter, and click "Apply".
- Click "Test".
 - If the audio is output from the this unit, the setup is completed.

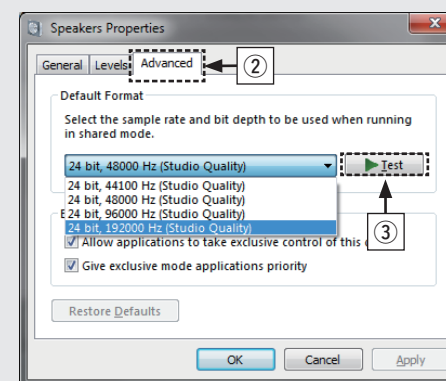

NOTE

- The dedicated driver must be installed in the computer before this unit is connected to a computer. Operation will not occur correctly if connected to the computer before the dedicated driver has been installed. Moreover, if the computer is running Windows XP as its OS, the computer's speed will decrease significantly, and a computer restart may be required.
- Operation may fail in some computer hardware and software configurations.

Computer (recommended system)**OS**

- Windows® XP Service Pack3, Windows® Vista, Windows 7 or Windows 8
- Mac OS X 10.6.4 or later.

USB

- USB 2.0: USB High speed/USB Audio Class Ver.2.0

NOTE

If the computer you use is "Mac OS", please check if the "USB High Speed Audio" format is set below "192000.0 Hz" using the "Audio MIDI Setup".

Playback

Install the desired player software on your computer beforehand.
Use the rear panel USB port to connect this unit to a personal computer. For the connection procedure, refer to the "Connecting a PC or Mac" (page 11) section.

1 Press DISC/INPUT to change the input source to "USB-DAC" (page 13).

Start playback on the computer's player software.

2 The input digital audio signal is displayed as shown.
"USB: ****k". or
"USB:DSD ***M"
(* ** * indicates the sampling frequency.)

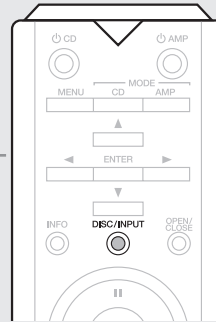

- If the sampling frequency cannot be detected, "Signal Unlock" will be displayed.
- When "USB: XXXXX" is displayed on this unit, wait for approximately 10 seconds, and then start and operate the music playback software on the computer. This unit functions as a D/A converter.

NOTE

- Perform operations such as playback and pause on the computer. At this time, you cannot perform operations with buttons on this unit or the remote control.
- You can also control the volume and equalizer on the computer. Enjoy playing music at the desired volume.
- When this unit is functioning as a D/A converter, sound is not output from the computer's speakers.
- If the computer is disconnected from this unit while the computer music playback software is running, the playback software may freeze. Always exit the playback software before disconnecting the computer.
- When an abnormality occurs on the computer, disconnect the USB cable and restart the computer.
- The sampling frequency of the music playback software and sampling frequency displayed on this unit may differ.
- Use a cable that is 10 ft/3 m or less to connect to the computer.

Files that can be played back

- See "D/A converter" (page 31).

Using as a D/A converter

Connect and playback from a devices with digital audio connectors (Coaxial/Optical)

1 Connect devices with digital audio connectors to this unit (☞ page 9).

2 Press DISC/INPUT to change the input source to "Coaxial" or "Optical" (☞ page 13).

The input digital audio signal is displayed as shown.

"Coax: *****k" or "Opt : *****k"

(***** indicates the sampling frequency.)

• If the sampling frequency cannot be detected, "Unlock" will be displayed.

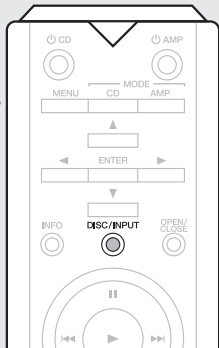

Files that can be played back

• See "D/A converter" (☞ page 31).

NOTE

- Do not input non-PCM signals, such as Dolby Digital, and DTS. This causes noise and could damage the speakers.
- If the sampling frequency switches, such as from A mode to B mode in a CS broadcast, muting may operate for 1 – 2 seconds, cutting the sound.

Specifying the desired sound quality

This unit is equipped with a sound quality adjusting function which allows users to enjoy the desired playback sound quality.
 • This setting remains effective even if the power is turned off.

Switching the filter characteristics

2 filter characteristic types can be selected for Super Audio CD playback, and for audio CD playback. The 2 filter characteristics types are explained below.

Filter Type	Audio CD	Super Audio CD
FIL 1	Offers a short impulse response for both pre-echo and post-echo. Suitable for large-information-content audio. Produces a deep sound image with clearly-defined positional relationships of the audio sources.	Precisely reproduces high resolution audio that has large information content.
FIL 2	This is a long coefficient FIR filter with symmetric pre-echo and post-echo in the impulse response. Resembles analog sound quality.	Attenuates portions that exceed 100 kHz. Characterized by a well-balanced, smooth sound.

Press FILTER.

• The setting cycles through the 2 modes (FIL1 / FIL 2) as shown below each time the button is pressed.

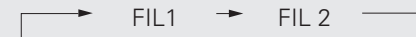
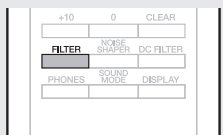

NOTE

The filter characteristics have a last memory function. These settings remain in memory even if a disc change occurs, or if the power is turned off.

Settings

Menu map

By default, this unit has recommended settings defined. You can customize this unit based on your existing system and your preferences.

Setting items	Description	Page
Timer Play	Switches the timer playback function on/off.	24
Play File	Disc	Switches a file media playback range ("All" or "Folder").
	USB	Switches a file media playback range ("All" or "Folder").
Disp Info	iPod	Sets the iPod information that displays during playback.
	USB	Sets the USB memory device information that displays during playback.
iPod Ctrl	Switches the iPod's operation mode.	25
USB Resume	Switches the USB memory device resume playback on/off.	25
Digital Out	Switches the digital audio output on/off.	25
Auto Stnby	Switches the auto standby function on/off.	25

Menu operation

1 Press MENU during stop mode.

The menu is displayed on the display of this unit.

2 Use Δ / ∇ to select the menu to be set or operated, and then press ENTER.

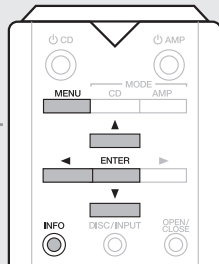

3 Use Δ / ∇ change to desired setting.

4 Press ENTER to enter the setting.

- To return to the previous item, press \triangleleft .
- Exiting the Menu, press MENU while the menu is displayed. The menu display disappears.

Timer Play

This unit can perform timer play by cooperating with your audio timer (see page 12 "Connecting the timer device").

On : Timer play is set.

Off (Default) : Timer play is not set.

Using the timer play function

1. Turn on the power of the connected components.
2. Load a disc or connect an iPod or USB memory device.
3. Switch the amplifier's function to input from the connected unit.
4. Set the audio timer for the desired times.
5. Turn the timer on.
The power of the components connected to the timer turns off.
When the set time is reached, the power of the different components automatically turns on and playback starts from the first track.

NOTE

- For connection to audio timer and its operation, please refer to the instruction manual of your audio timer.
- The timer play does not support the random play or program play.

Play File

Sets the playback range of files recorded on the disc or a USB memory device.

Disc

Selects whether all files or files within a specific folder are to be played during a disc playback.

All (Default) : All files on the Disc are played.

Folder : Files within a selected folder are played.

USB

Selects whether all files or files within a specific folder are to be played during a USB memory device playback.

All (Default) : All files on the USB memory device are played.

Folder : Files within a selected folder are played.

Disp Info

Sets the information displayed during iPod or USB memory device playback.

iPod

Sets the information displayed during iPod playback.

Time (Default) : Displays the time information.

Title : Displays the title name.

Artist : Displays the artist name.

Album : Displays the album name.



Press INFO to switch the information during playback.

USB

Sets the information displayed during USB memory device playback.

Time (Default) : Displays the time information.

Title : Displays the title name.

Artist : Displays the artist name.

Album : Displays the album name.



Press INFO to switch the information during playback.

iPod Ctrl

Specifies whether iPod operation is to be performed from the unit or at the iPod.

Direct (Default) : Control using the iPod.

Remote : Control using this unit and the remote control.

USB Resume

This unit stores the point at which playback of a file was stopped previously, and starts playback from the same point the next time playback is started.

On (Default) : Resume playback is set.

Off : Resume playback is not set.

NOTE

- Resume playback works even if the USB memory device is disconnected and then reconnected. However, if a different USB memory device is connected, the resume information for the previous USB memory device is deleted.
- The resume information may be deleted when the USB memory device is removed and files are added or deleted.

Digital Out

Setting for the digital output.

On (Default) : Enable the digital output.

Off : Disable the digital output.

Auto Stnby

A standby status is established at the unit if a stopped status or a no external input signal status continues for 30 minutes or more.

On (Default) : Enable Auto Standby mode.

Off : Disable Auto Standby mode.

Tips

Tips

- ❑ **I want to adjust the tone myself**
 - Switch the filter characteristics (👉 page 23).

- ❑ **I want to enjoy analog output audio at a higher sound quality**
 - Turn the display off to reduce the effects of the display and display circuit on the analog audio output signal (👉 page 15).
 - Turn the digital output off to reduce the effects of the digital audio output circuit on the analog audio output signal (👉 page 16).

- ❑ **I want to display Super Audio CD TEXT**
 - This unit is compatible with Super Audio CD TEXT. Press the INFO button to switch the display information.

- ❑ **I want to turn the illumination lamp off**
 - Change the settings so that the illumination lamp is always off (👉 page 15).

- ❑ **I want to play only the specified folder**
 - In "Play File" of the menu, specify the playback range "Folder" (👉 page 25).

- ❑ **I want to stop the USB memory device from automatically starting playback**
 - Set "USB Resume" to "Off" in the menu (👉 page 25).

- ❑ **I want to display information such as the title of the file played on the iPod on this unit's display**
 - Set "iPod Ctrl" to "Remote" in the menu (👉 page 25).

- ❑ **I want to playback WAV files**
 - This unit can playback WAV files that are stored on a USB memory device (👉 page 19, 30).

- ❑ **I want to control a Marantz amplifier using this unit's remote control**
 - Switch the control mode of the remote control (👉 page 6).
 - Also refer to the amplifier owner's manual.

Troubleshooting

- ❑ **Are the connections correct?**
- ❑ **Is the unit being operated as described in the owner's manual?**
- ❑ **Are the other components operating properly?**

If this unit does not operate properly, check the items listed in the table below. If the problem persists there may be a malfunction.

In that case, disconnect the power immediately and contact your retail outlet.

Contents

Power does not turn on / Power is turned off	(27)
Operations cannot be performed through the remote control unit	(27)
Display on this unit shows nothing	(27)
No sound comes out	(27)
Sound is interrupted or noise occurs	(28)
CDs cannot be played back	(28)
iPod cannot be played back	(28)
USB memory devices cannot be played back	(29)
File names on the iPod/USB memory device are not displayed properly	(29)
PC or Mac files cannot be played back	(29)

❑ Power does not turn on / Power is turned off

Symptom	Cause	Page
Power is not turned on.	• Check whether the power plug is correctly inserted into the power outlet.	12
	• This unit is in standby mode. Press the  CD button on the remote control.	13
Power automatically turns off.	• The Auto Standby mode is set. The Auto Standby mode switches the unit to standby mode when the unit is not operated for approximately 30 minutes. To disable Auto Standby mode, set "Auto Standby" on the menu to "Off".	25

❑ Operations cannot be performed through the remote control unit

Symptom	Cause	Page
Operations cannot be performed through the remote control unit.	• Batteries are worn out. Replace with new batteries.	2
	• Operate the remote control unit within a distance of about 23 ft/7 m from this unit and at an angle of within 30°.	2
	• Remove any obstacle between this unit and the remote control unit.	–
	• Insert the batteries in the proper direction, checking the ⊕ and ⊖ marks.	2
	• The set's remote control sensor is exposed to strong light (direct sunlight, inverter type fluorescent bulb light, etc.). Move the set to a place in which the remote control sensor will not be exposed to strong light.	–
	• When using a 3D video device, the remote control unit of this unit may not function due to effects of infrared communications between units (such as TV and glasses for 3D viewing). In this case, adjust the direction of units with the 3D communications function and their distance to ensure they do not affect operations from the remote control unit of this unit.	–
	• Press the CD MODE button to switch the remote control operating mode to "CD".	6
• When using this unit independently, set the switch to "INTERNAL".	11	

❑ Display on this unit shows nothing

Symptom	Cause	Page
Display is off.	• Press DISPLAY, and change the setting to "On".	15

❑ No sound comes out

Symptom	Cause	Page
No sound is produced or sound is distorted.	• Check the connections for all devices.	8, 9,
	• Insert connection cables all the way in.	10, 11
	• Check that input connectors and output connectors are not reversely connected.	–
	• Check cables for damage.	–
	• Check the amplifier's functions and controls and adjust as necessary.	–

❑ Sound is interrupted or noise occurs

Symptom	Cause	Page
During playback from the USB memory device, sound is occasionally interrupted.	<ul style="list-style-type: none"> When the transfer speed of the USB memory device is slow, sound may occasionally be interrupted. 	–

❑ CDs cannot be played back

Symptom	Cause	Page
Cannot playback when the play button is pressed, or cannot correctly play back a specific part of the disc.	<ul style="list-style-type: none"> The CD is dirty or scratched. Either clean the CD, or insert a different CD. 	32
Cannot playback CD-R/CD-RW.	<ul style="list-style-type: none"> CDs cannot be played back unless they have been finalized. Use a finalized disc. This may be caused by poor recording conditions, or the disc itself may be of poor quality. Use a correctly recorded disc. The DATA CD playback function of this unit only supports playback of MP3 and WMA files. 	33 – 30
"0 0:00" is displayed.	<ul style="list-style-type: none"> "0 0:00" is displayed if a disc that cannot be played is loaded. 	32
"No Disc" is displayed.	<ul style="list-style-type: none"> "No Disc" is displayed if the disc is loaded upside-down or if no disc is loaded. 	32

❑ iPod cannot be played back

Symptom	Cause	Page
iPod cannot be connected or "Check iPod" is displayed.	<ul style="list-style-type: none"> When using iPod by connecting it to the USB port, some iPod variations are not supported. When iPod is connected by using a USB cable other than the genuine cable, iPod may not be recognized. Use a genuine USB cable. 	10 –

❑ USB memory devices cannot be played back

Symptom	Cause	Page
"No Device", "Check FS" or "Check Device" is displayed.	<ul style="list-style-type: none"> This unit may not recognize the USB memory device due to poor connection, etc. Make sure that the connection is made properly by taking actions such as disconnecting and reconnecting the USB memory device. USB memory devices of a mass storage class are supported. This unit does not support a connection through a USB hub. Connect the USB memory device directly to the USB port. The USB memory device must be formatted to FAT16 or FAT32. Not all USB memory devices are guaranteed to work. Some USB memory devices are not recognized. When using a type of portable hard disc drive compatible with the USB connection that requires power from an AC adapter, use the AC adapter that came with the drive. 	10 – – –
Files on the USB memory device are not displayed or "Empty" is displayed.	<ul style="list-style-type: none"> Files of a type not supported by this unit are not displayed. This unit can display a file structure with up to 8 levels and up to 700 folders and up to 65,535 files. Modify the folder structure of the USB memory device. When multiple partitions exist on the USB memory device, only files on the first partition are displayed. 	30 – –
Files on a USB memory device cannot be played.	<ul style="list-style-type: none"> Files are created in a format that is not supported by this unit. Check the formats supported by this unit. You are attempting to play a file that is copyright protected. Files that are copyright protected cannot be played on this unit. When "< Not Support" is displayed, use the < button on the remote control unit to select a different file. 	30 – –

❑ File names on the iPod/USB memory device are not displayed properly

Symptom	Cause	Page
The file names are not displayed properly ("***", etc.).	<ul style="list-style-type: none"> Characters that cannot be displayed are used. This is not a malfunction. On this unit, characters that cannot be displayed are replaced with a "*". 	–





❑ PC or Mac files cannot be played back

Symptom	Cause	Page
The PC or Mac cannot recognize this unit.	<ul style="list-style-type: none"> Check the OS of the PC or Mac connected to this unit. A specialized driver needs to be installed when using a Windows PC. 	11 –
"Unsupported" is displayed.	<ul style="list-style-type: none"> "Unsupported" is displayed when audio signals that are not supported by this unit are input. Check the settings on your computer or player software. If the computer you use is "Mac OS", please check if the "USB High Speed Audio" format is set below "192000.0 Hz" using the "Audio MIDI Setup". 	– –

Appendix

Playable media

Discs

Playable media	
Super Audio CD	
CD	
CD-R	
CD-RW	

Super Audio CD

There are three types of Super Audio CDs:

- ① Single layer discs
Single layer Super Audio CD with just an HD layer.
- ② Dual layer discs
Super Audio CD with a double HD layer, offering extended playing time and high sound quality.
- ③ Hybrid discs
Two-layer Super Audio CD with an HD layer and a CD layer.
The signals on the CD layer can be played on a regular CD player.

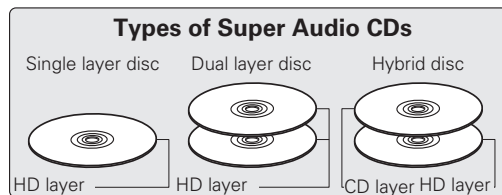

The HD layer is a layer of high density signals for Super Audio CDs.

The CD layer is the layer of signals that can be read on a regular CD player.



When "Multi-channel" is selected, down-mixed audio is output to the L and R channels.

NOTE

- Some discs and some recording formats may not be playable.
- Non-finalized discs cannot be played.

DATA CD

CD-R and CD-RW discs created in the format described below can be played.

Writing software format

ISO9660 level 1, 2

Expansion format (Juliet.Romeo)

- When written in other formats, it may not be possible to play the disc properly.

Playable files

Playable files (Extension)	File specification
MP3 (.mp3)	<ul style="list-style-type: none"> • Sampling frequency : 32 / 44.1 / 48 kHz • Bit rate : 32 kbps to 320 kbps • Format : MPEG1 Audio Layer 3
WMA (.wma)	<ul style="list-style-type: none"> • Sampling frequency : 32 / 44.1 / 48 kHz • Bit rate : 64 kbps to 192 kbps • Format : Windows Media Audio

Maximum number of playable files and folders

Maximum number of files: 1,000

Maximum number of folders: 255

NOTE

- Be sure to give files the extension ".mp3" or ".wma". Files with any other extensions or files with no extensions cannot be played.
- Recordings you have made should only be used for your personal enjoyment, and as per copyright laws may not be used in other ways without permission of the copyright holder.

USB memory device

USB-compatible file systems

FAT16 or FAT32

- If the USB memory device is divided into multiple partitions, only the top drive can be selected.

Tag data

ID3-TAG (Ver.1.x and 2.x)

WMA-TAG

AAC-TAG

The title, artist, and album tag data are supported.

Playable files

Playable files (Extension)	File specification
MP3 (.mp3)	<ul style="list-style-type: none"> • Sampling frequency : 32 / 44.1 / 48 kHz • Bit rate : 32 kbps to 320 kbps • Format : MPEG1 Audio Layer 3
WMA (.wma)	<ul style="list-style-type: none"> • Sampling frequency : 32 / 44.1 / 48 kHz • Bit rate : 48 kbps to 320 kbps • Format : Windows Media Audio
AAC (.m4a)	<ul style="list-style-type: none"> • Sampling frequency : 32 / 44.1 / 48 kHz • Bit rate : 64 kbps to 192 kbps • Format : Advanced Audio Codec
Linear PCM (.wav)	<ul style="list-style-type: none"> • Sampling frequency : 32 / 44.1 / 48 kHz • Bit length : 16 bit • Format : Linear PCM

Maximum number of playable files and folders

Maximum number of files: 65,535

Maximum number of folders: 700



- Only music files that are not copyright-protected can be played on this set.
- Contents downloaded from pay sites on the Internet are copyright protected. Also, files encoded in WMA format when ripped from a CD, etc., on a computer may be copyright protected, depending on the computer's settings.
- When audio from files in the USB memory device is output from the digital audio output connector, the sampling frequency is converted to 44.1 kHz for output.

NOTE

- It is not compatible with an MP3 player, digital camera, a USB memory device for a mobile phone, etc.
- The unit cannot charge a USB memory device.

Playback order of files (DATA CD / USB memory device)

When there are multiple folders containing music files, the playback order of folders is automatically set when this unit reads the media. The files in each folder are played back in the order in which the files were recorded on the media, from the oldest date and time.

CD-R/CD-RW

For playback of files on CD-R or CD-RW, files in all folders on the first layer are played first, next on the second layer, then next on the third layer, and so on in this order.

USB memory device

For playback of files recorded on USB memory device, files in the first folder on the first layer are played first, next folders on the second layer in the folder, then next on the third layer, and so on in this order. Then accordingly files on another first layer are played.



- The playback order displayed on a PC may differ from the actual playback order.
- The playback order with a CD-R/CD-RW may differ, depending on the writing software.

NOTE

The playback order may differ from the order in which the folders or files were recorded if you delete or add a folder or file on USB memory device. This occurs because of data recording specifications and is not a malfunction.

About Folders and Files

Files, such as MP3/WMA etc., recorded on CD-R/RW and USB memory device are divided into large segments (folders) and small segments (files). Files are stored in folders, and folders can be placed for storage in a hierarchy. The unit can recognize up to 8 levels of folders.

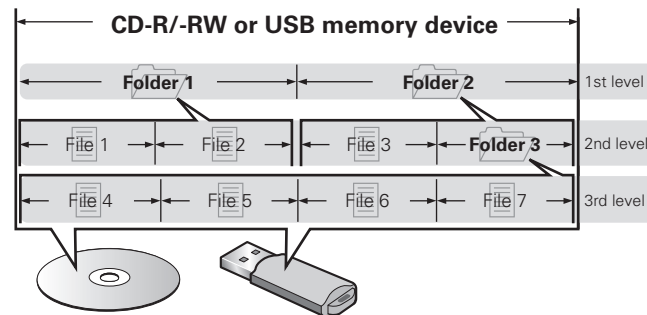

When writing MP3/WMA etc. files on a CD-R/RW disc, set the writing software's format to "ISO9660". The files may not play properly if they are recorded in other formats. For details, refer to the instructions of your writing software.

D/A converter

Supported audio formats

USB-DAC

Signal format	Specification
DSD (2-channel)	<ul style="list-style-type: none"> • Sampling frequency : 2.8224 MHz • Bit length : 1 bit
Linear PCM (2-channel)	<ul style="list-style-type: none"> • Sampling frequency : 32/44.1/48/88.2/96/176.4/192 kHz • Bit length : 16/24 bit

Coaxial/Optical

Signal format	Specification
Linear PCM (2-channel)	<ul style="list-style-type: none"> • Sampling frequency : 32/44.1/48/64/88.2/96/176.4/192 kHz • Bit length : 16/24 bit

Cautions on using media

Inserting a disc

- Place the disc in the tray, label side up.
- Make sure the disc tray is fully open when inserting the disc.
- Place the discs flat, 5 inch/12 cm discs in the outer tray guide (Figure 1), 3 inch/8 cm discs in the inner tray guide (Figure 2).

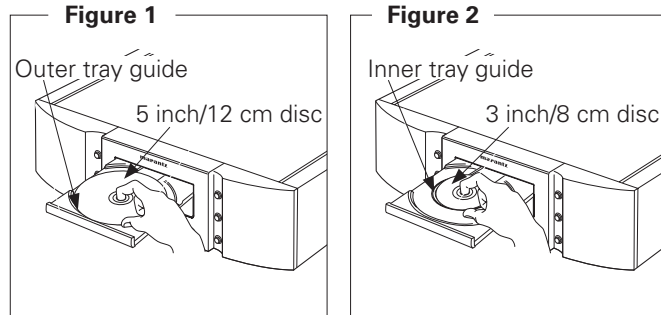

- Place 3 inch/8 cm discs in the inner tray guide without using an adapter.



- If you place a DVD or other disc that cannot be played by this unit in the disc tray, the tray does not open/close for about 1 minute. When that happens, press ▲ after "0 0:00" is displayed.
- If you place a disc that contains other than MP3 or WMA files, "0 0:00" is displayed.

NOTE

- Discs in special shapes (heart-shaped discs, octagonal discs, etc.) Only load one disc at a time. Loading two or more discs can damage the unit or scratch the discs.
- Do not use cracked or warped discs or discs that have been repaired with adhesive, etc.
- Do not use discs on which the sticky part of cellophane tape or labels is exposed or on which there are traces of where labels have been removed. Such discs can get caught inside the player and damage it.
- Do not use discs in special shapes, as they may damage the player.



- Do not push the disc tray in by hand when the power is off. Doing so could damage the set.

How to handle media

- Do not get fingerprints, oil or dirt on discs.
- Take special care not to scratch discs when removing them from their cases.
- Do not bend or heat discs.
- Do not enlarge the hole in the center.
- Do not write on the labeled (printed) surface with ball-point pens, pencils, etc., or stick new labels on discs.
- Condensation may form on discs if they are moved suddenly from a cold place (outdoors for example) to a warm place, but do not try to dry discs with a hairdryer, etc.
- Do not eject a USB memory device or turn off the unit while a USB memory device is being played. This may result in malfunction or loss of the USB memory device's data.
- Do not attempt to open or modify a USB memory device.
- USB memory device and files can be damaged by static electricity. Do not touch the metal contacts of an USB memory device with your fingers.
- Do not use warped USB memory device.
- After use, be sure to remove any disc or USB memory device, and store it in its proper case, to avoid dust, scratches and deformation.
- Do not store discs in the following places:
 1. Places exposed to direct sunlight for long periods of time
 2. Dusty or humid places
 3. Places exposed to heat from heaters, etc.

Cleaning discs

- If there are fingerprints or dirt on a disc, wipe them off before using the disc. Fingerprints and dirt can impair sound quality and cause interruptions in playback.
- Use a commercially available disc cleaning set or a soft cloth to clean discs.

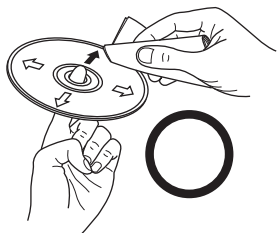

Gently wipe the disc from the inside towards the outside.

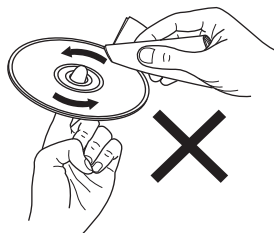

Do not wipe in a circular motion.

NOTE

Do not use record spray, antistatic agents, benzene, thinner or other solvents.

Explanation of terms

B

Bit rate

This is the amount of audio data recorded on a disc that is read in one second.

D

Dynamic range

The difference between the maximum, undistorted sound level and the minimum sound level that is discernible above the noise emitted by the device.

F

Finalizing

This process enables CDs recorded with a CD recorder or drive to be played by other players.

L

Linear PCM

This is an uncompressed PCM (Pulse Code Modulation) signal. This is the same system used for CD audio but uses 192 kHz, 96 kHz, and 48 kHz sampling frequencies on Blu-ray Disc or DVD and provides higher resolution than CD.

M

MP3 (MPEG Audio Layer 3)

This is an internationally standardized audio data compression scheme, based on the "MPEG-1" video compression standard. It compresses the data volume to about one eleventh its original size while maintaining sound quality roughly equivalent to a music CD.

S

Sampling frequency

Sampling involves taking a reading of a sound wave (analog signal) at regular intervals and expressing the height of the wave at each reading in digitized format (producing a digital signal).

The number of readings taken in one second is called the "sampling frequency". The larger the value, the closer the reproduced sound is to the original.

W

WMA (Windows Media Audio)

This is the audio compression technology developed by Microsoft Corporation.

To encode WMA files, only use applications authorized by Microsoft Corporation. If you use an unauthorized application, the file may not work properly.

Specifications

□ Audio performance

• Analog output

	[Super Audio CD]	[CD]
Channels:	2-channels	2-channels
Playable frequency range:	2 Hz – 100 kHz	2 Hz – 20 kHz
Playable frequency response:	2 Hz – 50 kHz (–3 dB)	2 Hz – 20 kHz
S/N:	109 dB (Audible range)	110 dB
Dynamic range:	109 dB (Audible range)	100 dB
Harmonic distortion:	0.0009 % (1 kHz, Audible range)	0.0015 % (1 kHz)
Wow & flutter:	Crystal accuracy	Crystal accuracy

• Output level (FIL2)

Unbalanced:	2.0 V (10 k Ω /ohms)	2.3 V (10 k Ω /ohms)
Headphone output:	32 mW / 32 Ω /ohms (variable maximum)	52 mW / 32 Ω /ohms (variable maximum)

• Digital output

output level (cinch JACK):	—	0.5 Vp-p (75 Ω /ohms)
output level (optical):	—	–19 dBm

• Optical Readout System

Laser:	AlGaAs	AlGaAs
Wave length:	650 nm	780 nm
Signal type:	1-bit DSD	16-bit Linear PCM
Sampling frequency:	2.8224 MHz	44.1 kHz

□ General

Power supply:	AC 120 V, 60 Hz
Power consumption:	37 W
	Standby: 0.3 W or less
Operating temperatures:	+5 °C – +35 °C
Operating humidity:	5 – 90 % (without dew)

For the purpose of improvement, the specifications and design are subject to change without notice.

Index

☞ A

Accessories	2
Auto Standby	25

☞ B

Bit rate	30, 31, 33
----------------	------------

☞ C

Connection	
Amplifier	8
AV receiver	9
D/A converter	9
iPod	10
Mac	11
PC	11
Power cord	12
Timer device	12
USB memory device	10

☞ D

DATA CD	30
Direct search	14
Display	5
Dynamic range	33

☞ F

Filter characteristics	23
Finalizing	33
Front panel	4

☞ I

Installing the driver software	20
--------------------------------------	----

☞ L

Linear PCM	33
------------------	----

☞ M

Menu map	24
MP3	33

☞ P

Playback	
CD	14
iPod	18
MP3	17
Super Audio CD	14
USB memory device	19
WMA	17
Playback mode	
Program playback	16
Random	16, 17, 19
Repeat	15, 17, 19

☞ R

Rear panel	5
Remote control	2
Inserting the batteries	2

☞ S

Sampling frequency	30, 31, 33
Searching	19
Stopping digital outputs	16
Switching the input source	13

☞ T

Tips	26
Troubleshooting	26
Turning the power on	13

Dimensions / Dimensions / Dimensions

Unit / Unité / Unidad / : inch / pouces / pulgadas (mm)

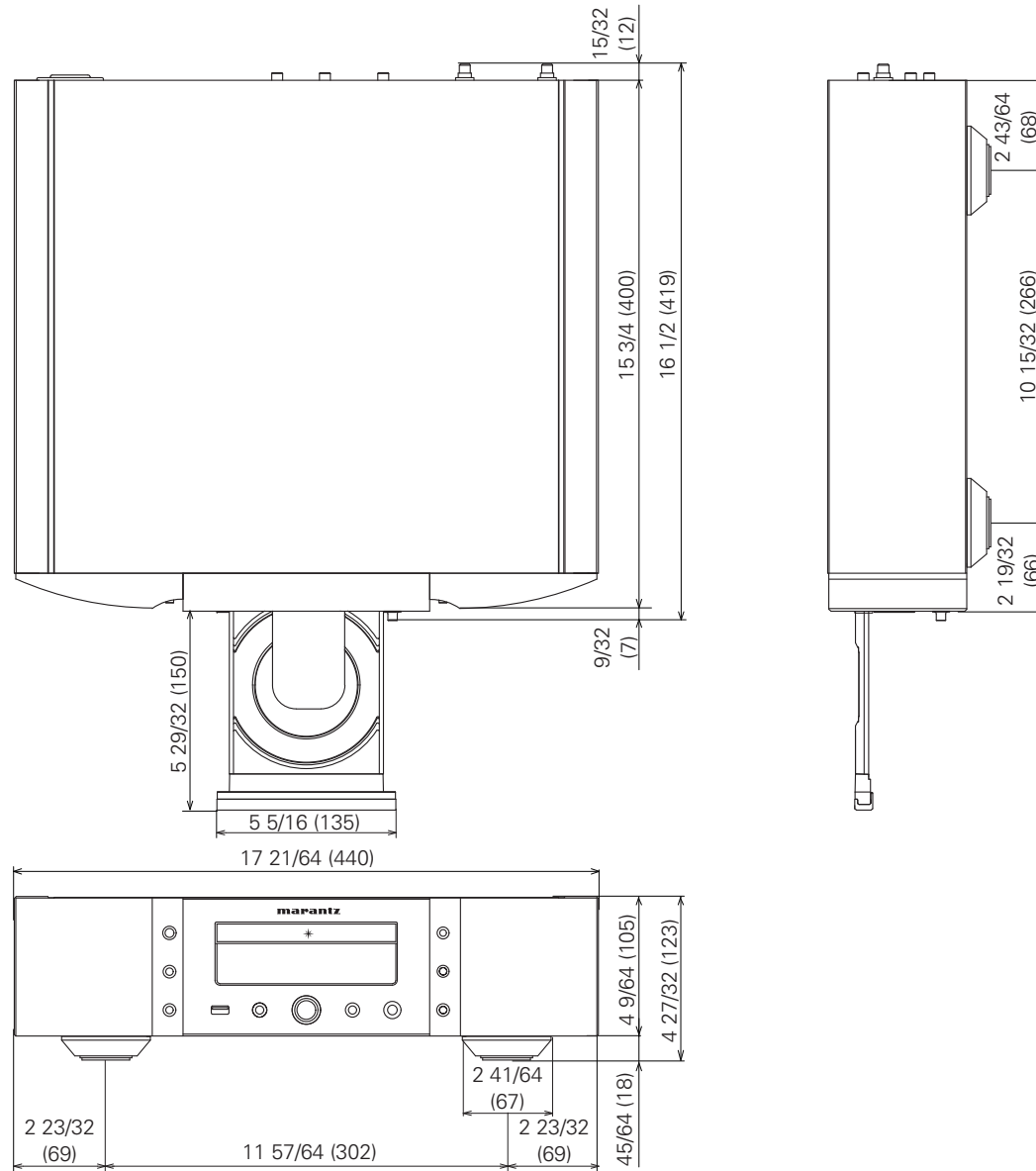

Weight / Poids / Peso / : 31 lbs 15 oz (14.5 kg)

www.marantz.com

You can find your nearest authorized distributor or dealer on our website.

marantz[®] is a registered trademark.

D&M Holdings Inc.
Printed in China 5411 11079 30AM

Free Manuals Download Website

<http://myh66.com>

<http://usermanuals.us>

<http://www.somanuals.com>

<http://www.4manuals.cc>

<http://www.manual-lib.com>

<http://www.404manual.com>

<http://www.luxmanual.com>

<http://aubethermostatmanual.com>

Golf course search by state

<http://golfingnear.com>

Email search by domain

<http://emailbydomain.com>

Auto manuals search

<http://auto.somanuals.com>

TV manuals search

<http://tv.somanuals.com>