

marantz®

Model DV7600 User Guide

Super Audio CD/DVD Player

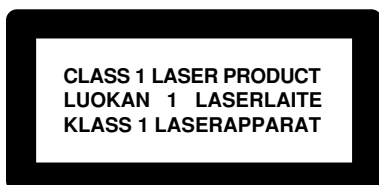

CONGRATULATIONS ON YOUR PURCHASE OF THIS FINE MARANTZ PRODUCT.

MARANTZ is on the leading edge of Super Audio CD, DVD research for consumer products and this unit incorporates the latest technological developments.

We are sure you will be fully satisfied with the Super Audio CD, DVD player.

Thank you for your support.

Please read through these operating instructions so you will know how to operate your model properly. After you have finished reading the instructions, put them away in a safe place for future reference.

Copy protection

Many DVD discs are encoded with copy protection. Because of this, you should only connect your DVD player directly to your TV, not to a VCR. Connecting to a VCR results in a distorted picture from copy-protected DVD discs.

This product incorporates copyright protection technology that is protected by methods claims of certain U.S. patents and other intellectual property rights owned by Macrovision Corporation and other rights owners.

Use of this copyright protection technology must be authorized by Macrovision Corporation, and is intended for home and other limited viewing uses only unless otherwise authorized by Macrovision Corporation.

Reverse engineering or disassembly is prohibited.

Operating Environment

Operating environment temperature and humidity:

+5°C to +35°C (+41°F to +95°F); less than 85%RH (cooling vents not blocked)

Do not install in the following locations

- Location exposed to direct sunlight or strong artificial light
- Location exposed to high humidity, or poorly ventilated location

This product is for general household purposes. Any failure due to use for other than household purposes (such as long-term use for business purposes in a restaurant or use in a car or ship) and which requires repair will be charged for even during the warranty period.

NOTE:

Changes or modifications not expressly approved by the party responsible for compliance could void the user's authority to operate the equipment.

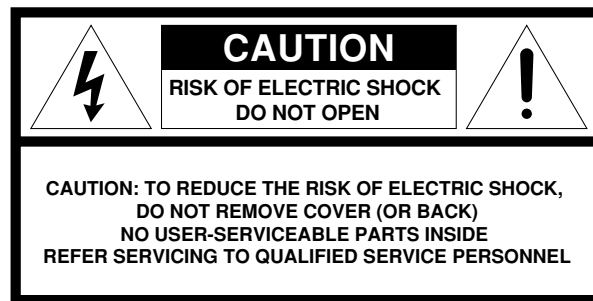

The lightning flash with arrowhead symbol, within an equilateral triangle, is intended to alert the user to the presence of uninsulated "dangerous voltage" within the product's enclosure that may be of sufficient magnitude to constitute a risk of electric shock to persons.



The exclamation point within an equilateral triangle is intended to alert the user to the presence of important operating and maintenance (servicing) instructions in the literature accompanying the appliance.

WARNING

TO REDUCE THE RISK OF FIRE OR ELECTRIC SHOCK, DO NOT EXPOSE THIS APPLIANCE TO RAIN OR MOISTURE.

CAUTION: TO PREVENT ELECTRIC SHOCK, MATCH WIDE BLADE OF PLUG TO WIDE SLOT, FULLY INSERT.

ATTENTION: POUR ÉVITER LES CHOCS ÉLECTRIQUES, INTRODUIRE LA LAME LA PLUS LARGE DE LA FICHE DANS LA BORNE CORRESPONDANTE DE LA PRISE ET POUSSER JUSQU'AU FOND.

LASER SAFETY

This unit employs a laser. Only a qualified service person should remove the cover or attempt to service this device, due to possible eye injury.

CAUTION : USE OF CONTROLS OR ADJUSTMENTS OR PERFORMANCE OF PROCEDURE OTHER THAN THOSE SPECIFIED HEREIN MAY RESULT IN HAZARDOUS RADIATION EXPOSURE.

CAUTION VISIBLE AND INVISIBLE LASER RADIATION WHEN OPEN AVOID EXPOSURE TO BEAM (WARNING LOCATION: INSIDE ON LASER COVERSIELD)

IMPORTANT SAFETY INSTRUCTIONS

READ BEFORE OPERATING EQUIPMENT (for U. S. A only)

This product was designed and manufactured to meet strict quality and safety standards. There are, however, some installation and operation precautions which you should be particularly aware of.

1. Read Instructions – All the safety and operating instructions should be read before the product is operated.
2. Retain Instructions – The safety and operating instructions should be retained for future reference.
3. Heed Warnings – All warnings on the product and in the operating instructions should be adhered to.
4. Follow Instructions – All operating and use instructions should be followed.
5. Cleaning – Unplug this product from the wall outlet before cleaning. Do not use liquid cleaners or aerosol cleaners. Use a damp cloth for cleaning.
6. Attachments – Do not use attachments not recommended by the product manufacturer as they may cause hazards.
7. Water and Moisture – Do not use this product near water-for example, near a bath tub, wash bowl, kitchen sink, or laundry tub, in a wet basement, or near a swimming pool, and the like.
8. Accessories – Do not place this product on an unstable cart, stand, tripod, bracket, or table. The product may fall, causing serious injury to a child or adult, and serious damage to the product. Use only with a cart, stand, tripod, bracket, or table recommended by the manufacturer, or sold with the product. Any mounting of the product should follow the manufacturer's instructions, and should use a mounting accessory recommended by the manufacturer.
9. CART – A product and cart combination should be moved with care. Quick stops, excessive force, and uneven surfaces may cause the product and cart combination to overturn.
10. Ventilation – Slots and openings in the cabinet are provided for ventilation and to ensure reliable operation of the product and to protect it from overheating, and these openings must not be blocked or covered. The openings should never be blocked by placing the product on a bed, sofa, rug, or other similar surface. This product should not be placed in a built-in installation such as a bookcase or rack unless proper ventilation is provided or the manufacturer's instructions have been adhered to.
11. Power Sources – This product should be operated only from the type of power source indicated on the marking label. If you are not sure of the type of power supply to your home, consult your product dealer or local power company. For products intended to operate from battery power, or other sources, refer to the operating instructions.
12. Grounding or Polarization – This product may be equipped with a polarized alternating-current line plug (a plug having one blade wider than the other). This plug will fit into the power outlet only one way. This is a safety feature. If you are unable to insert the plug fully into the outlet, try reversing the plug. If the plug should still fail to fit, contact your electrician to replace your obsolete outlet. Do not defeat the safety purpose of the polarized plug.
13. Power-Cord Protection – Power-supply cords should be routed so that they are not likely to be walked on or pinched by items placed upon or against them, paying particular attention to cords at plugs, convenience receptacles, and the point where they exit from the product.
14. Protective Attachment Plug – The product is equipped with an attachment plug having overload protection. This is a safety feature. See Instruction Manual for replacement or resetting of protective device. If replacement of the plug is required, be sure the service technician has used a replacement plug specified by the manufacturer that has the same overload protection as the original plug.
15. Outdoor Antenna Grounding – If an outside antenna or cable system is connected to the product, be sure the antenna or cable system is grounded so as to provide some protection against voltage surges and built-up static charges. Article 810 of the National Electrical Code, ANSI/NFPA 70, provides information with regard to proper grounding of the mast and supporting structure, grounding of the lead-in wire to an antenna discharge unit, size of grounding conductors, location of antenna-discharge unit, connection to grounding electrodes, and requirements for the grounding electrode. See Figure 1.
16. Lightning – For added protection for this product during a lightning storm, or when it is left unattended and unused for long periods of time, unplug it from the wall outlet and disconnect the antenna or cable system. This will prevent damage to the product due to lightning and power-line surges.

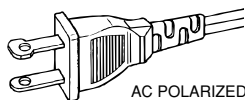

AC POLARIZED PLUG

17. Power Lines – An outside antenna system should not be located in the vicinity of overhead power lines or other electric light or power circuits, or where it can fall into such power lines or circuits. When installing an outside antenna system, extreme care should be taken to keep from touching such power lines or circuits as contact with them might be fatal.
18. Overloading – Do not overload wall outlets, extension cords, or integral convenience receptacles as this can result in a risk of fire or electric shock.
19. Object and Liquid Entry – Never push objects of any kind into this product through openings as they may touch dangerous voltage points or short-out parts that could result in a fire or electric shock. Never spill liquid of any kind on the product.
20. Servicing – Do not attempt to service this product yourself as opening or removing covers may expose you to dangerous voltage or other hazards. Refer all servicing to qualified service personnel.
21. Damage Requiring Service – Unplug this product from the wall outlet and refer servicing to qualified service personnel under the following conditions:
 - a. When the power-supply cord or plug is damaged.
 - b. If liquid has been spilled, or objects have fallen into the product.
 - c. If the product has been exposed to rain or water.
 - d. If the product does not operate normally by following the operating instructions. Adjust only those controls that are covered by the operating instructions as an improper adjustment of other controls may result in damage and will often require extensive work by a qualified technician to restore the product to its normal operation.
 - e. If the product has been dropped or damaged in any way, and
 - f. When the product exhibits a distinct change in performance – this indicates a need for service.
22. Replacement Parts - When replacement parts are required, be sure the service technician has used replacement parts specified by the manufacturer or have the same characteristics as the original part. Unauthorized substitutions may result in fire, electric shock, or other hazards.
23. Safety Check – Upon completion of any service or repairs to this product, ask the service technician to perform safety checks to determine that the product is in proper operating condition.
24. Wall or Ceiling Mounting – The product should be mounted to a wall or ceiling only as recommended by the manufacturer.
25. Heat – The product should be situated away from heat sources such as radiators, heat registers, stoves, or other products (including amplifiers) that produce heat.

FIGURE 1
EXAMPLE OF ANTENNA GROUNDING AS PER
NATIONAL ELECTRICAL CODE, ANSI/NFPA 70

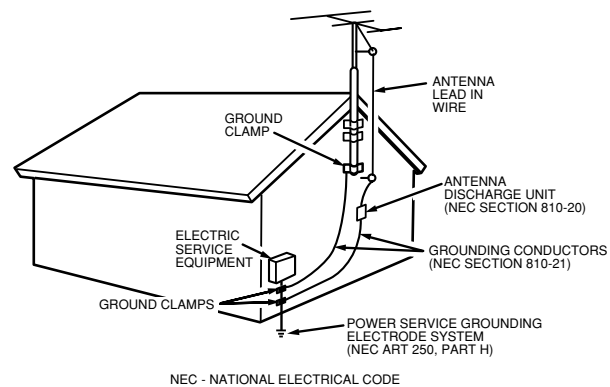

This Class B digital apparatus complies with Canadian ICES-003.

Cet appareil numérique de la Classe B est conforme à la norme NMB-003 du Canada.

FCC NOTE (for U. S. A only):

This equipment has been tested and found to comply with the limits for a Class B digital device, pursuant to Part 15 of the FCC rules. These limits are designed to provide reasonable protection against harmful interference in a residential installation. This equipment generates, uses and can radiate radio frequency energy and, if not installed and used in accordance with the instructions, may cause harmful interference to radio or television reception, which can be determined by turning the equipment off and on, the user is encouraged to try to correct the interference by one or more of the following measures.

- Reorient or relocate the receiving antenna.
- Increase the separation between the equipment and receiver.
- Connect this equipment into an outlet on a circuit different from that to which the receiver is connected.
- Consult the dealer or an experienced radio/TV technician for help.

NOTE: Changes or modifications may cause this unit to fall to comply with Part 15 of the FCC Rules and may void the user's authority to operate the equipment.

This Class B digital apparatus complies with Canadian ICES-003.

Cet appareil numérique de la Classe B est conforme à la norme NMB-003 du Canada.

This product satisfies FCC regulations when shielded cables and connectors are used to connect the unit to other equipment. To prevent electromagnetic interference with electric appliances, such as radios and televisions, use shielded cables and connectors for connections.

CE marking (for Europe only)

CE This product is in conformity with the EMC directive and low-voltage directive.

WARNINGS

- Do not expose the equipment to rain or moisture.
- Do not remove the cover from the equipment.
- Do not insert anything into the equipment through the ventilation holes.
- Do not handle the mains lead with wet hands.
- Do not cover the ventilation with any items such as tablecloths, newspapers, curtains, etc.
- No naked flame sources, such as lighted candles, should be placed on the equipment.
- When disposing of used batteries, please comply with governmental regulations or environmental public instruction's rules that apply in your country or area.
- Do not place anything about 0.1 meter above the top panel.
- Make a space of about 0.1 meter around the unit.
- No objects filled with liquids, such as vases, shall be placed on the apparatus.
- When the switch is in the OFF position, the equipment is not completely switched off from MAINS.

WARRANTY

For warranty information, contact your local Marantz distributor.

RETAIN YOUR PURCHASE RECEIPT

Your purchase receipt is your permanent record of a valuable purchase. It should be kept in a safe place to be referred to as necessary for insurance purposes of when corresponding with Marantz.

IMPORTANT

When seeking warranty service, it is the responsibility of the consumer to establish proof and date of purchase. Your purchase receipt or invoice is adequate for such proof.

FOR U.K. ONLY

This undertaking is in addition to a consumer's statutory rights and does not affect those rights in any way.

Disc Storage

Be careful not to harm the disc because the data on these discs is highly vulnerable to the environment.

- Do not keep under direct sunlight.
- Keep in a cool ventilated area.
- Store vertically.
- Keep in a clean protection jacket.

Maintenance of Cabinet

For safety reasons, be sure to disconnect the AC power cord from the AC outlet.

- Do not use benzene, thinner, or other solvents for cleaning.
- Wipe the cabinet with a soft cloth.

Table Of Contents

1 Before You Start	
Features	6
What's in the box	7
Putting the batteries in the remote control	7
Using the remote control	7
Discs compatible with this player	8
DVD-Video regions	9
MP3 compatibility information	9
JPEG compatibility information	9
2 Connecting Up	
Easy setup	10
Home theater video connections	11
Home theater audio connections	12
3 Controls & Displays	
Front panel	13
Display	14
Remote control	15
4 Getting Started	
Playing discs	16
Basic playback controls	16
Navigating DVD disc menus	17
Navigating Video CD PBC menus	17
5 Playing Discs	
Introduction	18
Finding what you want on a disc	18
Still Frame/Slow Play/Frame Advance Playback	20
Using the Page	21
Using the Random Play	21
Using the Repeat Play	22
Switching Super Audio CD Mode	23
Switching Camera Angles	23
Switching Subtitle Language	23
Switching Audio Language	24
Using the Zoom Function	24
Making a program list	26
Video Adjust	28
6 DVD Setup Menu	
Using the FL menu	30
Using the Setup Menu	31
Setting up the Video Setup	33
Setting up the HDMI Setup	37
Setting up the Audio Setup	39
Setting up the Speaker Setup	43
Setting up the SP Level Setup	44
Setting up the DISC Setup	44
Setting up the System Setup	46
Resetting the Player	47
7 Additional Information	
Handling discs	48
Storing discs	48
Discs to avoid	48
Cleaning the pickup lens	48
Problems with condensation	48
Hints on installation	49
Moving the player	49
Power cord caution	49
Glossary	50
Troubleshooting	52
Specifications	55

Features

An HDCP-compatible HDMI*¹ terminal is provided to ensure the very highest picture and digital sound quality by fully digital transmission.

This unit is equipped with an HDCP-compatible digital image output terminal (HDMI) to provide copyright protection.

Direct digital transmission without analog conversion of DVD image data makes it possible to enjoy real-life images without any image deterioration resulting from AD/DA conversion. The unit has also been designed to make it possible to handle the transmission of both digital video and digital audio with a single connector.

High quality 12-bit/216MHz Video D/A converter*²

The unit uses a Video D/A converter that performs D/A conversion of all video signals in 12-bits and can perform 8X over-sampling to let you enjoy beautiful video possible with DVD. Furthermore, NSV technology suppresses noise during DA conversion.

High quality 24-bit/192kHz DAC

The high specification 24-bit/192kHz DAC delivers dynamic, smooth and expansive analog sound from CDs and DVDs.

Superlative audio performance with Super Audio CD, DVD-Audio, Dolby*³ Digital and DTS*⁴ software

Logos:



The DV7600 delivers breathtaking sound quality with Super Audio CD, DVD-Audio, Dolby Digital and DTS discs.

SRS TruSurround*⁵

Logo: 

When used with stereo sources, SRS TruSurround creates a realistic surround-sound effect using just two speakers (see page 41).

MP3 compatibility

This player is compatible with CD-R, CD-RW and CD-ROM discs that contain MP3 audio tracks (see pages 9, 27).

JPEG compatibility

This player is compatible with CD-R, CD-RW and CD-ROM discs that contain JPEG data (see pages 9, 28).

*¹ HDMI, the HDMI logo and High-Definition Multimedia Interface are trademarks or registered trademarks of HDMI Licensing LLC.

*² "NSV" is a registered trademark of Analog Device Co. Ltd.

*³ Manufactured under license from Dolby Laboratories. "Dolby" and the double-D symbol are trademarks of Dolby Laboratories. Confidential unpublished works. © 1992-1997 Dolby Laboratories. All rights reserved.

*⁴ "DTS" and "DTS Digital Surround" are registered trademarks of Digital Theater Systems, Inc.

*⁵ TruSurround, SRS and the  symbol are trademarks of SRS Labs, Inc. TruSurround technology is incorporated under license from SRS Labs, Inc.

Before You Start

1

What's in the box

Thank you for buying this MARANTZ product. Please confirm that the following accessories are in the box when you open it.

- Remote control
- AAA/AR03 dry cell batteries x2
- Audio/Video cable (yellow/red/white)
- System control cable
- Power cable
- User Guide (this manual)
- Warranty card

Putting the batteries in the remote control

- 1 Open the battery compartment cover on the back of the remote control.

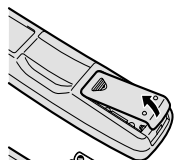

- 2 Insert two AAA/AR03 batteries into the battery compartment following the indications (+, -) inside the compartment.

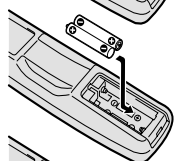

- 3 Close the cover.

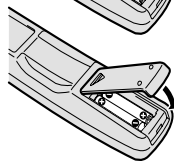

Note

Incorrect use of batteries can result in hazards such as leakage and bursting. Please observe the following:

- Don't mix new and old batteries together.
- Don't use different kinds of battery together—although they may look similar, different batteries may have different voltages.
- Make sure that the plus and minus ends of each battery match the indications in the battery compartment.
- Remove batteries from equipment that isn't going to be used for a month or more.

When disposing of used batteries, please comply with governmental regulations or environmental bylaws that apply in your country or area.

Using the remote control

Keep in mind the following when using the remote control:

- Make sure that there are no obstacles between the remote control and the remote sensor on the unit.
- Use within the operating range and angle, as shown.

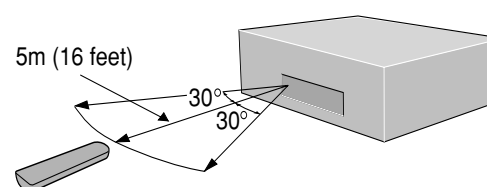

- Remote operation may become unreliable if strong sunlight or fluorescent light is shining on the unit's remote sensor.
- Remote controllers for different devices can interfere with each other. Avoid using remotes for other equipment located close to this unit.
- Replace the batteries when you notice a fall off in the operating range of the remote control.

Note

- When using this player independently, set a **REMOTE CONTROL** switch on the rear panel to **INT. (INTERNAL)** (see page 10).

English

7

Discs compatible with this player

Any disc that displays one of the following logos should play in this player. Other formats, including DVD-RAM, DVD-ROM, DVD+RW, DVD+R, CD-ROM (except those that contain MP3/JPEG files) and Photo CD will not play.

DVD-Video compatibility:

- Logos: 
- Single sided or double sided discs
- Single layer or dual layer discs
- Dolby Digital, DTS, MPEG or Linear PCM digital audio
- MPEG-2 digital video

Discs are generally divided into one or more titles. Titles may be further subdivided into chapters.

DVD-Audio compatibility:

- Logos: 
- Single sided discs
- Single layer or dual layer discs
- Linear or packed PCM digital audio
- Some discs may contain MPEG-2 video, and Dolby Digital, DTS or MPEG digital audio

Discs are generally divided into one or more groups. Groups may be further subdivided into tracks.

DVD-R compatibility:

This unit can play DVD-R discs. Please note the following points when using these discs:

- Logo: 
- This unit can play DVD-R discs recorded as DVD-Video format.

DVD-RW compatibility:

This unit can play DVD-RW discs. Please note the following points when using these discs:

- Logo: 
- This unit can play DVD-RW discs recorded as DVD-Video format.
- DVD-RW discs that were recorded with copy-once only permission cannot be played.

Audio CD compatibility:

- Logos: 
- 12cm (5in.) or 8cm (3in.) discs
- Linear PCM digital audio
- Audio CD, CD-R* and CD-RW* formats

CDs are divided into tracks.

*This unit can play CD-R and CD-RW discs recorded in Audio CD or Video CD format, or with MP3 audio files.

*Some copy-controlled CDs may not conform to official CD standards. They are special discs and may not play on the DV7600.

*DV7600 does not support the non-DVD side of a Dual Disc.

Video CD compatibility:

- Logo: 
- 12cm (5in.) or 8cm (3in.) discs
- MPEG-1 digital audio
- MPEG-1 digital video

Video CDs are divided into tracks.

Super VCD compatibility:

- Logo: 
- 12cm (5in.) or 8cm (3in.) discs
- MPEG-1 digital audio
- MPEG-2 digital video

Super VCDs are divided into tracks.

Super Audio CD compatibility:

- Logo: 
- Single layer, dual layer or Hybrid layer
- 12cm (5in.) or 8cm (3in.) discs
- Digital audio (DSD)

Super Audio CDs are divided into tracks.

DVD-Video regions

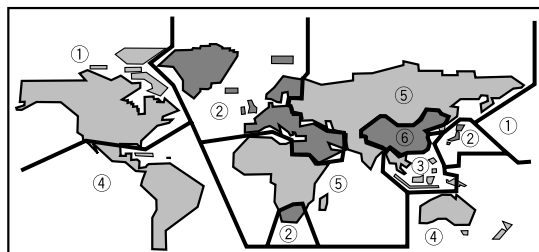

All DVD-Video discs carry a region mark on the case somewhere that indicates which region(s) of the world the disc is compatible with. Your DVD player also has a region mark, which you can find on the rear panel. Discs from incompatible regions will not play in this player. Discs marked **ALL** will play in any player.

MP3 compatibility information

- The CD-ROM must be ISO 9660 compatible.
- Files should be MPEG1 Audio Layer 3 format, 44.1 kHz or 48 kHz. Incompatible files will not play.
- This player is not compatible with MP3 PRO, ID3-Tag and packet write.
- This player cannot play DVD-R/RW discs with recorded MP3 music data.
- This player only plays tracks that are named with the file extension “.mp3” or “.MP3”.
- This player is not compatible with multi-session discs. If you try and play a multi-session disc, only the first session will be played.
- Use CD-R or CD-RW media for recording your MP3 files. The disc must be finalized in order to play.
- Audio encoded at 128Kbps should sound close to regular audio CD quality. Although this player will play lower bit-rate MP3 tracks, the sound quality becomes noticeably worse at lower bit-rates.
- Only the first 8 characters of folder and track names (excluding the “.mp3” extension) are displayed.
- This player can recognize about total 250 files/folder.
- Not compatible with variable bit-rate (VBR) files.

JPEG compatibility information

- While this player is designed to be able to handle image data recorded in JPEG format, no assurances are given that the player will be able to display image data recorded in all JPEG formats.
- This player cannot display progressive JPEG images.
- When writing JPEG files to CD-R/RW discs, always be sure to set the writing format to ISO 9660 Level 1.
- Always be sure to specify a file extension of “.JPG” or “.JPE” for JPEG files. The file will not be able to be displayed if a file extension other than “.JPG” or “.JPE” is specified or if no file extension is assigned to the file. (Note that this means that JPEG files created on a Macintosh will not be able to be displayed as is.)
- Depending on the file size and compression rate, some JPEG pictures cannot be displayed correctly.

Caution!

- DVD-R/RW and CD-R/RW discs recorded using a personal computer or a DVD or CD recorder may not play if the disc is damaged or dirty, or if there is dirt or condensation on the player's lens.
- If you record a disc using a personal computer, even if it is recorded in a compatible format, there are cases in which it may not play because of the settings of the application software used to create the disc. (Check with the software publisher for more detailed information.)
- Unfinalized DVD-R/RW discs cannot be played.
- Unfinalized CD-R/RW discs cannot be played.
- For more information on using DVD-R/RW and CD-R/RW discs, see “Handling discs” on **page 48**.
- Never try to replay anything other than a music CD (CDA format) or a CD-R/RW on which MP3 and/or JPEG files have been stored. Depending on the type of file, there may be times when doing so will result in problems or erroneous operation.
- There may be times when it is impossible to replay a CD-R/RW disc because of the characteristics of the disc being used or because of dirt or scratches on the disc.

Easy setup

This easy setup is the minimum set of connections you need to start watching DVD-Video discs. Both sound and picture are fed directly to your TV using the supplied Audio/Video cables. For other possible connections, see pages 11 -12.

⚠ Important

- Before making or changing any rear panel connections, make sure that all components are switched off and unplugged from the wall outlet.
- When connecting the component is turned on, do not unplug the power cord of this DVD player from the wall outlet. The speaker may be damaged.

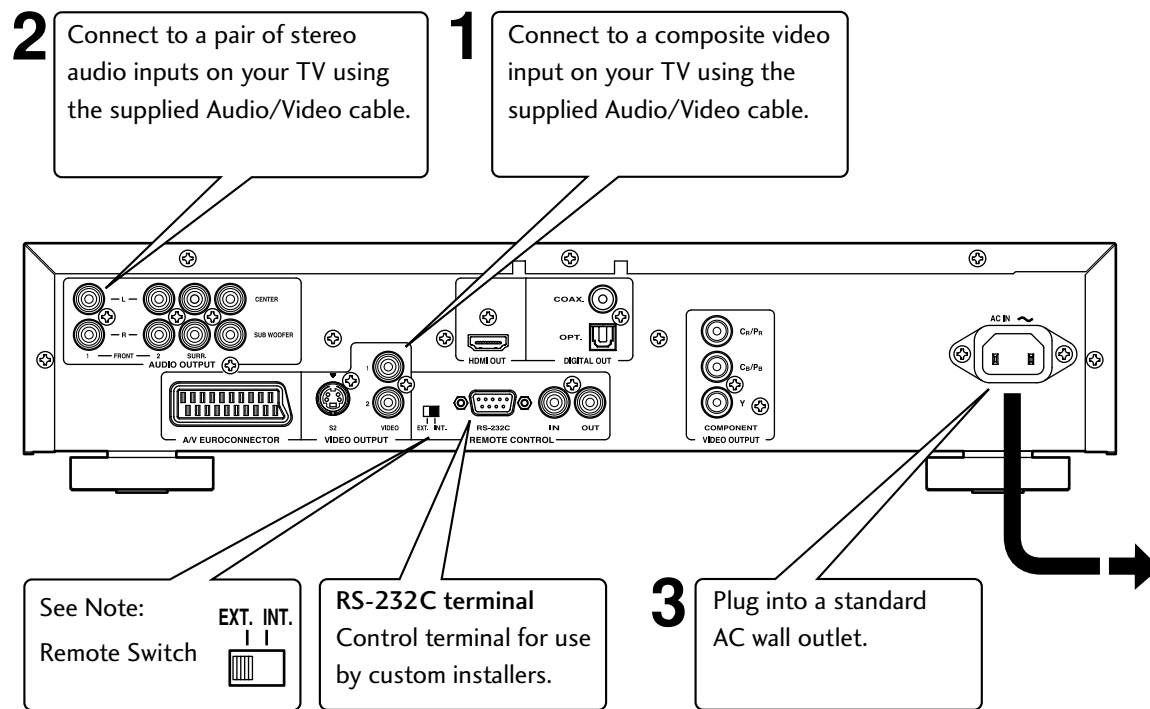

Connecting audio/video cables

Be sure to insert each plug fully for the best connection. The plugs and jacks are color-coded to make connection easier.

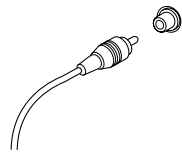

Connecting system control cables

By connecting this DVD player to another Marantz audio component using a supplied System control cable, you can remotely operate the components as a single system.

- When connecting to component with a remote sensor, be sure to connect the **REMOTE CONTROL IN** jack of this DVD player to the **REMOTE CONTROL OUT** jack of the component with the remote sensor.
- When connecting to component which is not equipped with a remote sensor, be sure to connect the component to the **REMOTE CONTROL OUT** jack of this DVD player.

📌 Note

- When connecting to a standard TV, select **4:3 L - Box** or **4:3 Pan Scan** in the TV Aspect setting (see page 33).
- Connect the video output of the player directly to your TV. Because the player is designed to support an Analog Protection System copy card, there are cases when proper playback will be not be possible if the player is connected to the TV through a VCR and images are recorded and played on the VCR.
- The player's video output and S2 output will not be progressive.
- **Remote switch**
When using this DVD player independently, set this switch to **INT. (INTERNAL)**. When using this DVD player in a system with a Marantz receiver equipped with a remote sensor, set the switch to **EXT. (EXTERNAL)**.

Home theater video connections

This player outputs video in a number of different ways. Choose the one most suitable for your system using the guide below.

Important

- Before making or changing any rear panel connections, make sure that all components are switched off and unplugged from the wall outlet.
- When connecting the component is turned on, do not unplug the power cord of this DVD player from the wall outlet. The speaker may be damaged.

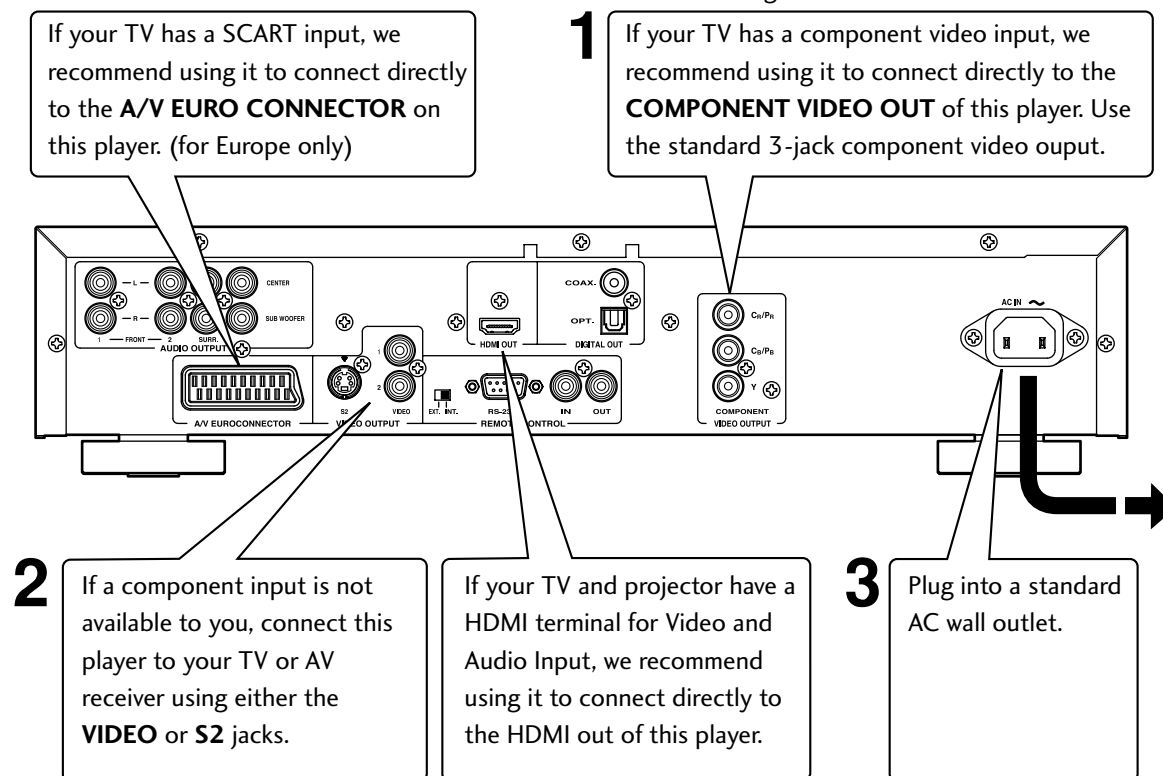

Connecting SCART (for Europe only) and S-Video cables

SCART and S-Video cables will only plug in one way, so make sure the plug is correctly lined up with the jack before inserting. Be sure to fully insert for a good connection.

Note

- The **A/V EURO CONNECTOR** connector can output composite, S-Video or RGB component video. If you connect just one TV, use the **A/V EURO CONNECTOR** connector. You can select the type of video output by changing the **Video Out** setting in the **Setup Menu** (page 36).

S-Video or composite video?

S-Video should give a better picture, so if you have an S-Video input, use it. S-Video cables are available from any good audio/visual dealer.

Connecting HDMI cables

With an HDMI cable, both uncompressed video data and digital audio data (e.g., LPCM or bit stream data such as Dolby

Digital, DTS, or MPEG data) can be transmitted with just a single connector.

By transmitting DVD image data directly as digital data without it being first converted into analog format, it becomes possible to provide the very finest in image quality (see pages 30, 37).

Note

- The HDMI output of this unit can be connected to a DVI jack on a TV or other device using a conversion adapter. In this case, it is necessary to use a TV or display with an HDCP-compatible DVI input. (see page 37)
- There may be no image output if connected to a TV or display that is not compatible with the above format.
- Refer to the instruction manual of the TV or display to be connected to this unit for detailed information regarding the HDMI terminal.
- When connecting a progressive input TV with the component output of the player, select **Progressive** in the Components Out setting (see page 36).

Home theater audio connections

This player outputs multi-channel audio in both analog and digital form. Check the manual for your amplifier/receiver to see what equipment it is compatible with (especially which digital formats—Dolby Digital, DTS, etc.—it can decode).

⚠ Important

- Before making or changing any rear panel connections, make sure that all components are switched off and unplugged from the wall outlet.
- When connecting the component is turned on, do not unplug the power cord of this DVD player from the wall outlet. The speaker may be damaged.

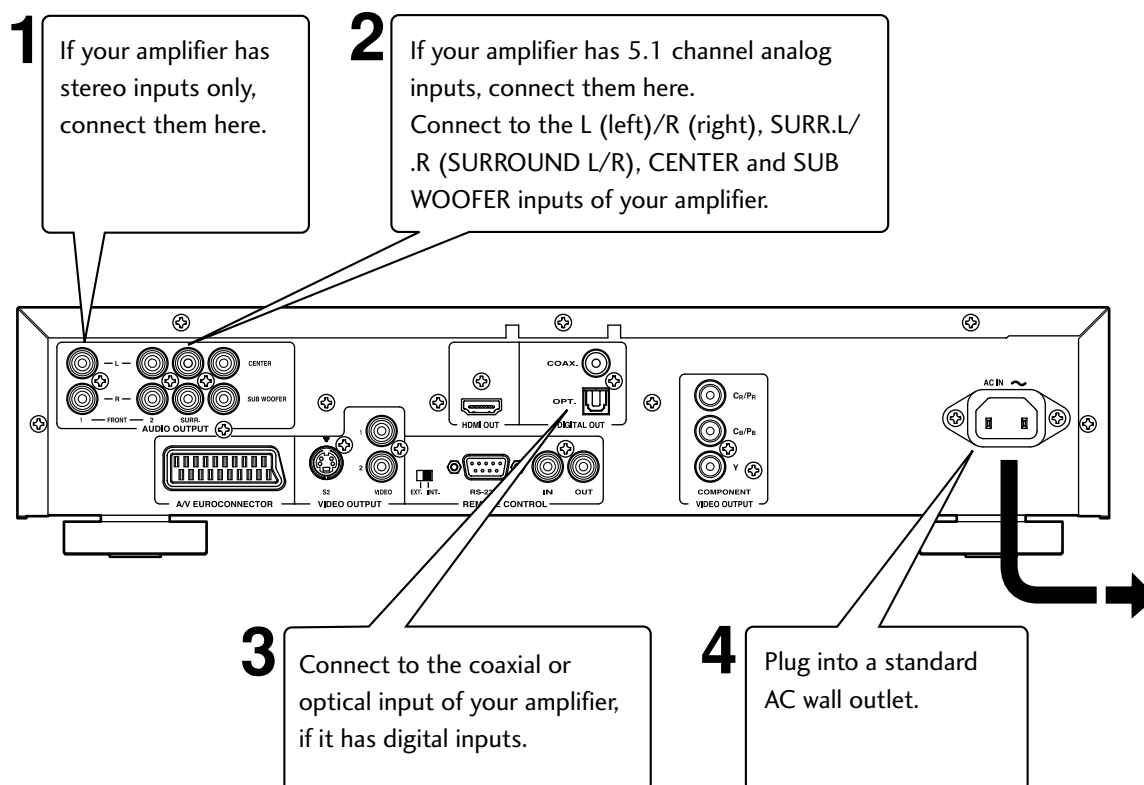

Connecting analog audio cables

Be sure to fully insert each plug for the best connection. The plugs and jacks are color-coded to make connection easier.

Connecting optical cables

Optical interconnects only plug in one way, so make sure the plug is correctly lined up with the jack before inserting. When inserting the plug, the protective shutter will open and you should hear it click into position when fully inserted. Be careful that you do not force the plug, because this could result in damage to the protective shutter, the cable, or the unit itself.

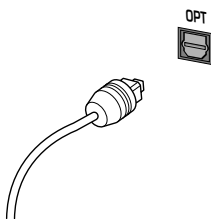

Connecting coaxial cables

Use an interconnect with a pin-type (also called RCA or phono) plug on each end to connect up digital coaxial-type jacks. Make sure that the plug is pushed fully home.

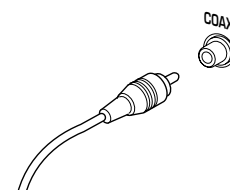

✎ Note

- If you listen to multichannel DVD-Audio through one of the digital outputs, it will be downmixed to stereo. Also, high sampling rate DVD-Audio (192kHz or 176.4kHz) will be downsampled to 96kHz, 88.2kHz, 48kHz or 44.1 kHz, depending on the disc (see [page 40](#)). Multi channel and high sampling rate DVD-Audio is only available through the analog outputs.
- All DVD-Audio and all Super Audio CD audio is output only through the analog outputs (see [pages 41-42](#)).

Front panel

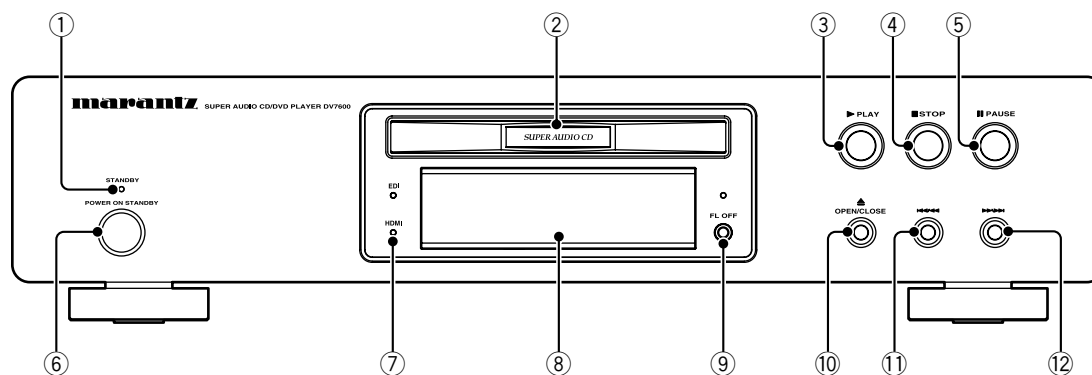

- 1 STANDBY indicator**
 - Lights when the unit is in standby.
- 2 Disc tray**
 - Place the disc here.
- 3 ► (PLAY)**
 - Begin the disc play.
- 4 ■ (STOP)**
 - Stops the disc play.
- 5 || (PAUSE)**
 - Pausing the disc play.
- 6 POWER ON/STANDBY**
 - Press to turn the power on, and press it again to STANDBY mode.
- 7 HDMI/DVI indicator**
 - When the connected device is HDMI compatible, the light flashes green. When it is DVI compatible, the light flashes red.
- 8 Display – page 14**
 - Operation indications are displayed here.
- 9 FL OFF**
 - Lights when the display is switched off using the **FL OFF** button and **DIMMER** button on the remote control.
- 10 ▲ (OPEN/CLOSE)**
 - Press to open and close the disc tray.
- 11 ◀◀ / ◀◀**
 - Press to skip reverse title/group, chapter, or track. You can also press and hold this button to scan the above.
- 12 ▶▶ / ▶▶**
 - Press to skip forward title/group, chapter, or track. You can also press and hold this button to scan the above.

Display

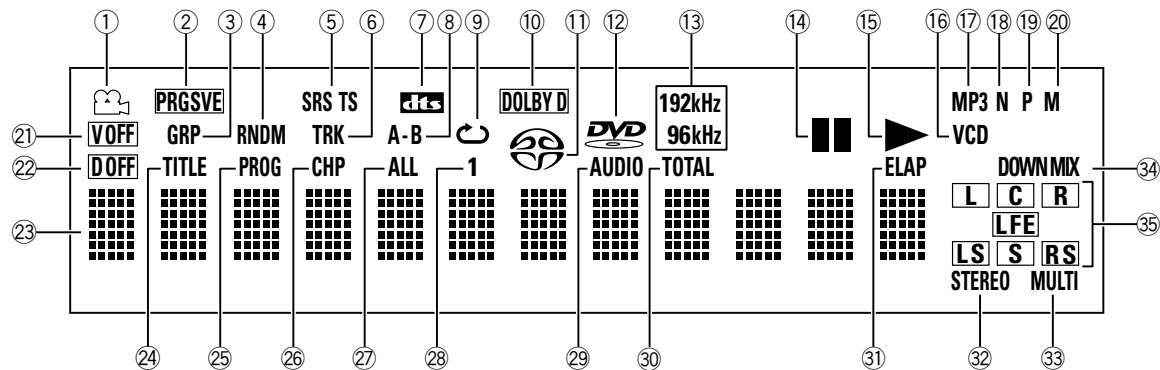

- 1 – Lights during a camera-angle section of a DVD-Video disc
 - 2 **PRGSVE** – Lights when unit is outputting progressive scan (non-interlaced) video
 - 3 **GRP** – Indicates that the number below in the character display is a DVD-Audio group number
 - 4 **RNDM** – Lights during random playback
 - 5 **SRS TS** – Lights when playing a disc with TruSurround switched on
 - 6 **TRK** – Indicates that the number below in the character display is a DVD-Audio, CD, Video CD or MP3 track number
 - 7 – Lights when a disc with DTS audio is playing
 - 8 **A-B** – Lights when A-B repeat has been selected
 - 9 – Lights during repeat play
 - 10 **DOLBY D** – Lights when a disc with Dolby Digital audio is playing
 - 11 – Lights when a Super Audio CD is loaded
 - 12 – Lights when a DVD is loaded
 - 13 **192kHz/96kHz** – Indicates a DVD disc containing high-sampling rate (192kHz/96kHz) audio is playing
 - 14 – Lights when a disc is paused
 - 15 – Lights when a disc is playing
 - 16 **VCD** – Lights when a Video CD is loaded
CD – Lights when a Audio CD is loaded
 - 17 **MP3** – Lights when replaying MP3 audio
 - 18 **N** – Lights when NTSC has been selected as the TV system
 - 19 **P** – Lights when PAL has been selected as the TV system
 - 20 **M** – Lights when 'Multi' has been selected as the TV system
 - 21 **V OFF** – Indicates that video output is turned off
 - 22 **D OFF** – Lights when the unit is set to Digital Out off
 - 23 **Character display**
 - 24 **TITLE** – Indicates that the number below in the character display is a DVD-Video title number
 - 25 **PROG** – Lights when replaying a program
 - 26 **CHP** – Indicates that the number below in the character display is a DVD-Video chapter number
 - 27 **ALL** – Lights when 'Repeat all' has been selected for VCD, CD or Super Audio CD
 - 28 **1** – Lights when track repeat has been selected for VCD, CD, Super Audio CD, or DVD-Audio
 - 29 **AUDIO** – Lights when a DVD-Audio disc is playing
 - 30 **TOTAL** – Indicates that the time shown in the character display is the total playing time of the disc
 - 31 **ELAP** – Lights when the elapsed time is being displayed for a title, chapter, or track
 - 32 **STEREO** – Lights when a Super Audio CD is playing stereo sounds
 - 33 **MULTI** – Lights when a Super Audio CD is playing multi-channel sounds
 - 34 **DOWN MIX** – Lights when multi-channel DVD-Audio, Dolby Digital, DTS or MPEG audio is downmixed, such as to two-channel stereo
- Note**
- Depending on the disc, the **DOWN MIX** is not displayed.
- 35 **L, C, R, LFE, LS, S, RS** – show which channels are recorded on the disc playing
- Note**
- The channel indications are not displayed during multi channel area playback of a Super Audio CD.

Remote control

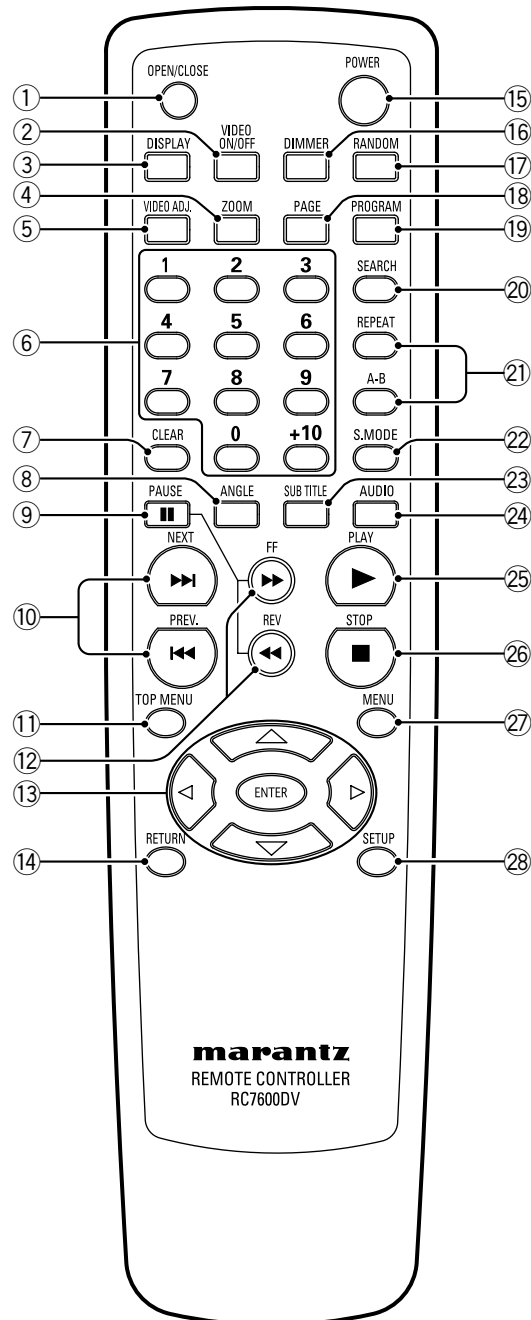

- 1 **OPEN/CLOSE** – Disc tray open/close – page 16
- 2 **VIDEO ON/OFF** – press to turn video output off and on
 - HDMI video output cannot be switched off.
- 3 **DISPLAY** – page 25
- 4 **ZOOM** – page 24
- 5 **VIDEO ADJ.** – Video adjust (pages 28–29)
- 6 **Number buttons**
- 7 **CLEAR** – page 26
- 8 **ANGLE** – page 23
- 9 **II (PAUSE)** – page 16
- 10 **◀◀ (PREV.)/▶▶ (NEXT)** – Skip – page 16
 - Allows you to search forward/backward through a disc. Use to skip the title, chapter or track.
- 11 **TOP MENU** – page 17
- 12 **◀◀ (REV)/▶▶ (FF)** – Scan – page 16
- 13 **Cursor (◀/▶/▲/▼) / ENTER button** – pages 17, 31
- 14 **RETURN** – page 17
- 15 **POWER** – switches the player on or into standby
- 16 **DIMMER** – Press to change the display brightness – page 13
- 17 **RANDOM** – pages 21, 27
- 18 **PAGE** – page 21
- 19 **PROGRAM** – page 26
- 20 **SEARCH** – page 18
- 21 **REPEAT** – page 22
 - A-B – page 22
- 22 **S.MODE** – page 23
- 23 **SUBTITLE** – page 23
- 24 **AUDIO** – page 24
- 25 **▶ (PLAY)** – page 16
- 26 **■ (STOP)** – page 16
- 27 **MENU** – page 17
- 28 **SETUP** – page 31

Note

- The **+10** button is not used on this set.

- This remote control supports two remote control codes: DVD1 and DVD2.
- When the unit is shipped from the factory, the remote control is set to DVD1.
- To set the remote control to DVD2, hold down both **■ (STOP)** button and **2** number button on the remote control for at least five seconds. (If the batteries in the remote control are replaced while the remote control is set to DVD2, the setting will revert to DVD1.)
- To set the remote control back to DVD1, hold down both **■ (STOP)** button and the **1** number button on the remote control for at least five seconds.
- To check which remote control code is set at any time, hold down both the Stop and Pause buttons; the current setting (either “DVD1” or “DVD2”) will be displayed in the display window on the main unit.
- Also set the REMOT CODE on the **FL menu** to the same setting as the remote control. (This setting is set to DVD1 when the unit is shipped from the factory.) (see page 30)

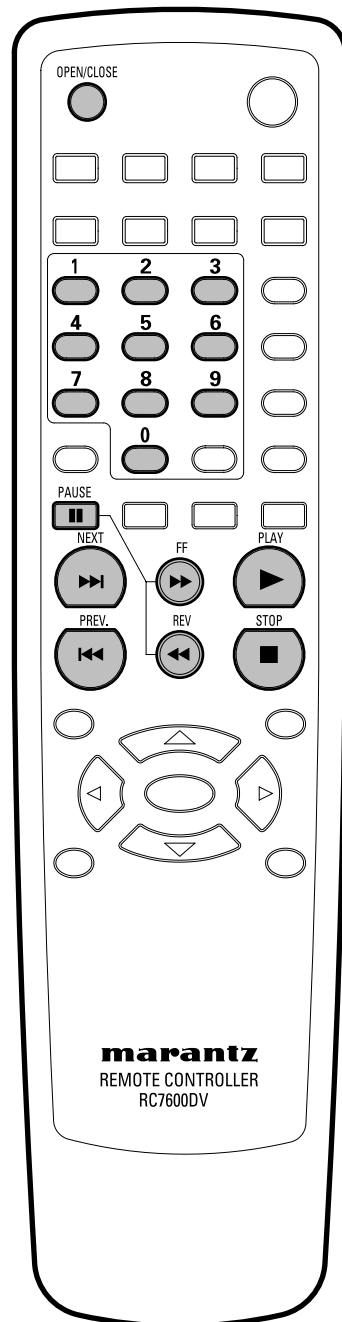

Playing discs

The basic playback controls for playing discs are covered here. Further functions are detailed in the next chapter.

Note

- Throughout this manual, the term 'DVD' means DVD-Video, DVD-Audio and DVD-R/RW. If a function is specific to a particular kind of DVD disc, it is specified.

1 Switch the player on.

If you're playing a DVD or Video CD, also turn on your TV and make sure that it is set to the correct video input.

2 Press OPEN/CLOSE to open the disc tray.

3 Load a disc.

Load a disc with the label side facing up, using the disc tray guide to align the disc (if you're loading a double-sided DVD disc, load it with the side you want to play face down).

4 Press ► (PLAY) to start playback.

If you're playing a DVD or Video CD, a menu may appear (see page 17).

Note

- For one-sided, two-layer discs containing movies, etc., there may be a short image stoppage at the point where the layers change. This is not a malfunction.

Basic playback controls

Button	What it does
►	Starts playback. DVD and Video CD: if the display shows RESUME , playback starts from the resume point.
⏸	Pauses a disc that's playing.
■	Stops playback. DVD: Display shows RESUME . Press ■ (STOP) again to cancel the resume function.
◀◀	1. Press for fast reverse scanning during play. 2. Press again to increase the scan speed. (Super Audio CD, Video CD and CD have 3 scan speeds; DVD have 4.) Press ► (PLAY) to resume normal playback.
▶▶	1. Press for fast forward scanning during play. 2. Press again to increase the scan speed. (Super Audio CD, Video CD and CD have 3 scan speeds; DVD have 4.) Press ► (PLAY) to resume normal playback.
◀◀	Skips to the start of the current track or chapter, then to previous tracks/chapters.
▶▶	Skips to the next track or chapter.
Numbers	Playback starts from selected track/chapter number.

Note

- If the power is interrupted during Resume STOP, Play or Pause, playback will start again from Resume Point when the power is restored, unless the disc tray is opened and the disc is removed.
- The sound is muted during fast forward/reverse scanning of DVD/VCD.

Important

While using the DVD playback controls, you may see the Ⓞ mark displayed on-screen. The Ⓞ mark means that the operation is not allowed by the player and disc.

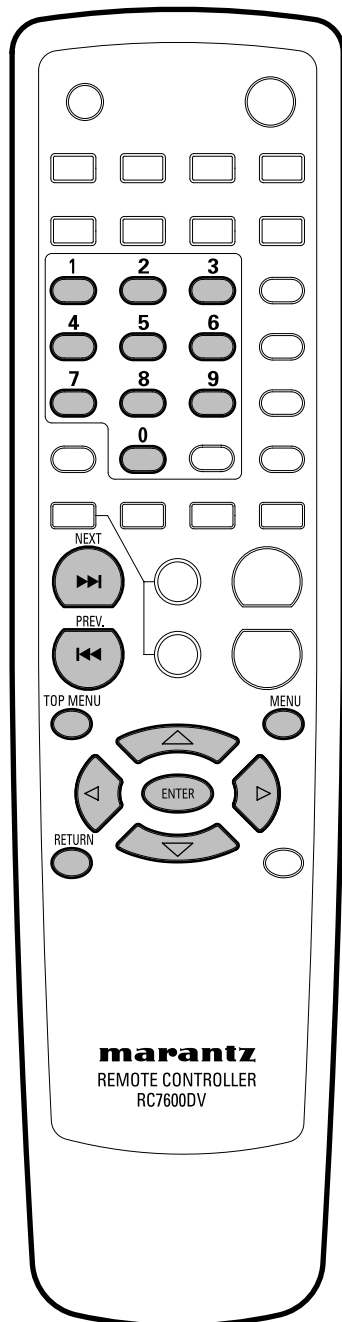

Navigating DVD disc menus

Many DVD discs contain menus. Sometimes these are displayed automatically when you start playback; others only appear when you press **MENU** or **TOP MENU**. For DVD Audio discs, use **TOP MENU**.

Note

- Some DVD-Audio discs feature a 'Bonus Group'. To access this group you have to input a password, which you can find on the disc's packaging. See **page 46** for more information.

Button	What it does
TOP MENU	Displays the 'top menu' of a DVD disc—this varies with the disc.
MENU	Displays a DVD disc menu—this varies with the disc and may be the same as the 'top menu'.
RETURN	Returns to the previously displayed menu screen.
Cursor (◀/▶/▲/▼)	Moves the cursor around the screen.
ENTER	Selects the current menu option.
Numbers	Selects a numbered menu option (some discs only).

Navigating Video CD PBC menus

Some Video CDs have menus from which you can choose what you want to watch. These are called PBC (Playback control) menus.

Press the **TOP MENU** to turn the PBC function on or off. If you press the **TOP MENU** during playback, playback will stop. If you press the number buttons in the PBC off mode, playback will start from the selected track.

Note

- Some discs don't allow PBC menus.

Button	What it does
RETURN	Displays the PBC menu.
Numbers	Selects a numbered menu option.
◀◀	Displays the previous menu page (if there is one).
▶▶	Displays the next menu page (if there is one).

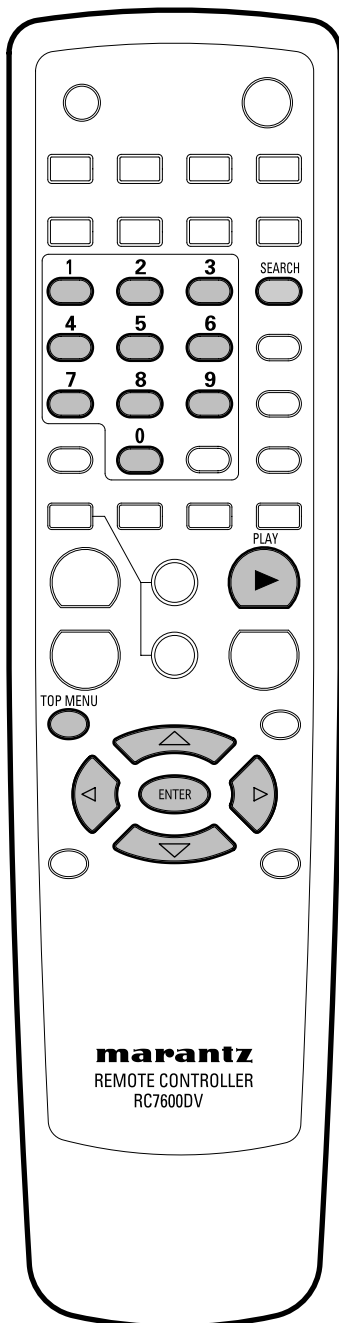

Introduction

- Many of the functions covered in this chapter apply to DVD discs, Video CDs, Super Audio CDs and CDs, although the exact operation of some varies slightly with the kind of disc loaded.
- When playing DVD discs, if the  icon appears on-screen when you try to use a particular function, either the player or the disc doesn't allow the use of that function.
- When playing Video CDs, some of the functions are not available in PBC mode. If you want to use them, press the **TOP MENU** to turn the PBC function off.

Finding what you want on a disc

DVD Video CD Super Audio CD CD

You can directly access any point on a disc using one of the search modes. Use these search modes while a disc is playing. Playback jumps to the point specified.

- 1 Press the **SEARCH** button during playback mode.

DVD-Video

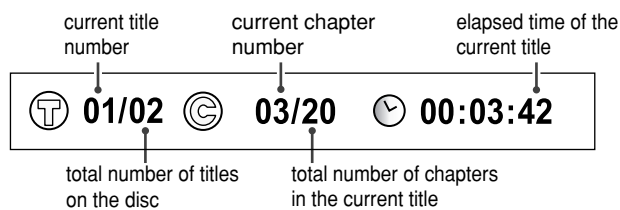

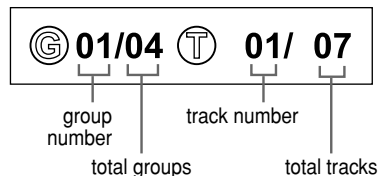

DVD-Audio

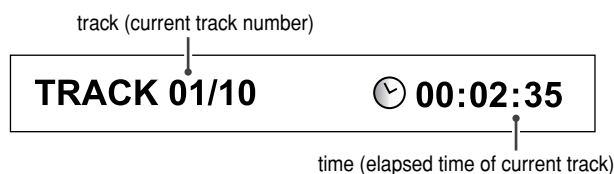

Video CD CD Super Audio CD



- 2 Use the cursor buttons ( ) to select the desired item.
- 3 You may use the number buttons of the remote control to directly access a title, chapter or to start the playback from the desired time.

Example:

To select Title/chapter 2, press 0 and 2.

To select a scene 2 hours 30 minutes 10 seconds from the beginning of the selected title, press 023010.

To select Track 5, press 5.

To select Track 12, press 1 and 2.

To select a part 1 minute 10 seconds from the beginning of the selected track, press 1, 1, 0.

4 Press ► (PLAY) button or the ENTER button.

 **Note**

- Some discs don't allow the Search mode.
- If you select numbers which don't exist on the disc, PROHIBITED icon  will be displayed.

In the STOP mode of DVD

Pressing the **SEARCH** button sets the title select mode on and the GUI display should look like this:

DVD-Video

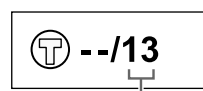

total number of titles

DVD-Audio

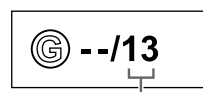

total groups

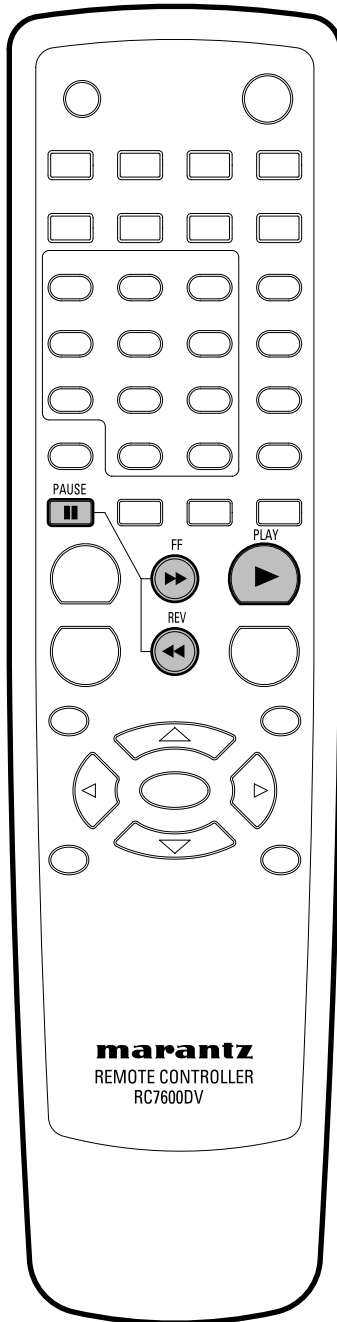

Still Frame/Slow Play/Frame Advance Playback

(DVD-Video)

The video images on DVD can be viewed as a still frame, played back at slow speeds and even advanced frame by frame (Forward only).

Viewing a Pausing Picture

Press **II (PAUSE)**.

To return to normal playback

When the picture playback is paused, pressing **▶ (PLAY)** restores normal playback operation.

Viewing slow playback

With this function, DVDs can be viewed in both forward and reverse direction.

Press **▶▶ (FF) during pause.**

- Slow playback is engaged.
- During slow playback, the speed of playback can be adjusted from 1/8 normal playback speed to 1/2 normal playback speed in 3 steps using **▶▶ (FF)**.

1/8 - 1/4 - 1/2
▶▶▶

Press **◀◀ (REV) during Pause.**

- Slow playback in the reverse direction is engaged.
- During slow playback, the speed of playback can be adjusted from 1/8 normal playback speed to 1/2 normal playback speed in 3 steps using **◀◀ (REV)**.

1/2 - 1/4 - 1/8
◀◀◀

To return to normal playback

When the picture is paused or during slow playback, pressing **▶ (PLAY)** restores normal playback operation.

Step Motion playback: Viewing one frame at a time

With this function, DVDs can only be moved in the forward direction.

Press **II (PAUSE)**.

Each time the button is pressed, a new frame will appear.

To return to normal playback

When viewing Step Motion playback, pressing **▶ (PLAY)** restores normal playback operation.

Note

- There is no sound picture playback is paused or during slow playback, or when advancing one frame at a time.
- Pausing picture, slow play, or Step Motion playback may not be possible with certain titles. In this case, the  mark is displayed.
- If a Browsable picture (**page 50**) is recorded on a DVD-Audio disc, Step Motion playback is possible.
- A short sound may be noticeable when switching to Slow Playback.
- When you press the Pause button during slow playback, it may advance a few frames past the frame where you want it to stop.

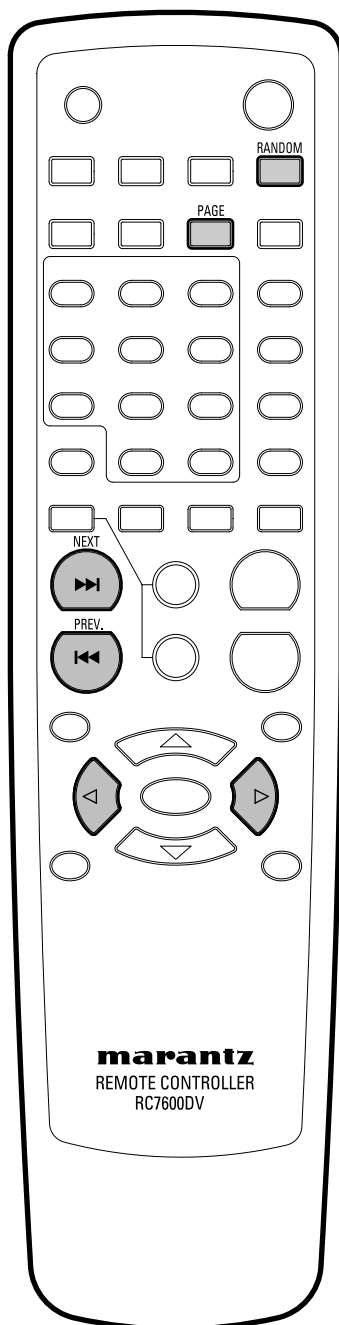

Using the Page

DVD-Audio

Press the **PAGE** button on the remote control during playback. You may select the image you want by moving the cursor button (◀/▶).

Note

- Some discs don't allow the Page function.

Using the Random Play

Video CD **CD** **Super Audio CD** **MP3**

Use the random play function to play tracks in a random order. You can't use random play with DVD-RW discs, DVD-Video or Video CD playing in PBC mode.

Press RANDOM button during playback.

- **Return to normal playback**
Press the **RANDOM** button again.

Tip

- During random play, the ◀◀ (PREV.) and ▶▶ (NEXT) buttons function a little differently to normal: ◀◀ (PREV.) returns to the beginning of the current track/chapter. You can't go back further than this. ▶▶ (NEXT) selects another track/chapter at random from those remaining.
- You can't use random play together with program or repeat play.

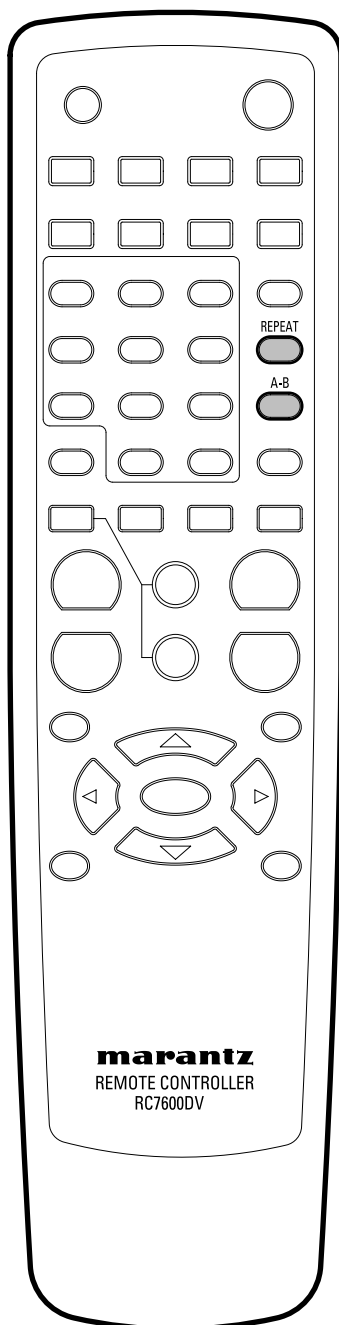

Using the Repeat Play

DVD-Audio DVD-Video Video CD CD Super Audio CD MP3

You can set the player to repeat individual tracks on CDs or Video CDs, Super Audio CDs, chapters or titles on DVD discs, or the whole disc. It's also possible to loop a section of a disc.

You can't use any repeat mode or looped play with a Video CD playing in PBC mode.

Note

- Some discs don't allow the Repeat function.

1 Press REPEAT during playback to select a repeat mode.

Each press switches the repeat mode:

DVD-Video

- CHAPTER REPEAT
- TITLE REPEAT
- OFF

DVD-Audio Video CD CD Super Audio CD

- REPEAT ONE
- REPEAT ALL
- REPEAT OFF

MP3

- DISC (default)
- FOLDER
- SINGLE REPEAT
- FOLDER REPEAT
- DISC REPEAT

Note

- **Folder**
The current folder will be played once.
- **Disc**
The disc will be played once.

2 To return to normal play, press REPEAT again, then select off.

Looping a section of a disc

DVD Video CD Super Audio CD

1 Press A-B once at the start of the section you want to repeat, then again at the end.

Playback immediately jumps back to the start point and plays the loop round and round.

- On a DVD disc, the start and end points of the loop must be in the same title/group.
- On Video CD/CD/Super Audio CD, the start and end points of the loop must be in the same track.

2 To resume normal playback, press A-B again.

Note

- There may be a slightly difference between point A and the location where playback actually resumes depend on the disc.

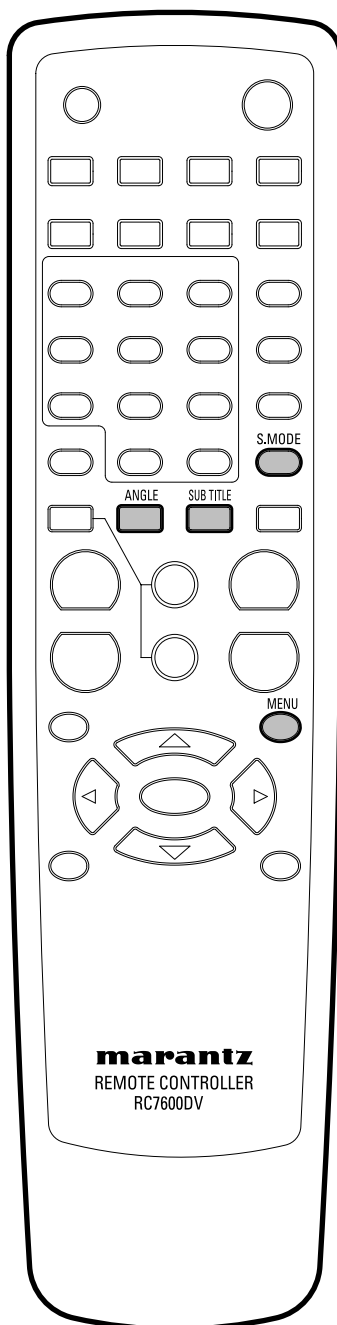

Switching Super Audio CD Mode

Super Audio CD

- Default setting: **Stereo**

Super Audio CD discs can be divided up into several different areas – stereo audio, Multi channel audio and, for hybrid Super Audio CDs, standard CD audio. The Super Audio CD Play setting enables you to select which area of the disc you want to play with the **S.MODE** button. To switch the Super Audio CD Mode, press **S.MODE** in the **STOP** mode.

Note

- If you select an area that isn't on the disc loaded, a different area of the disc will play. For example, if you choose standard CD audio but the disc loaded is not a hybrid Super Audio CD, the stereo Super Audio CD audio will play.

Switching Camera Angles

DVD-Video

Some DVD-Video discs feature scenes shot from two or more angles—check the disc box for details: it should be marked with a  icon if it contains camera-angle scenes.

- To switch the camera angle, press **ANGLE**.

Note

- When a scene recorded with multiple angles is played, “ANGLE AREA IN” briefly appears on the screen.
- When the multi-angle scene ends, “ANGLE AREA OUT” briefly appears on the screen.
- Depending on the disc, this feature may not work.
- To switch on/off the Angle Mark on the Setup Menu, the screen starts from Muti-Angle starting position.

Switching Subtitle Language

DVD-Video

Many DVD-Video discs have subtitles in one or more languages—the disc box will usually tell you which subtitle languages are available. You can switch subtitle language anytime during playback.

- To display/switch the subtitle language, press **SUBTITLE** repeatedly.

The current subtitle language is shown on-screen.

- To set subtitle preferences, see page 44.

Note

- It may take a few seconds till a selected subtitle appears on the screen.
- In some cases, a subtitle can not be turned off even if you select “OFF”.
- Some discs allow you to change subtitles only via the disc menu. In that case, press the “MENU” button and change the settings.
- Picture distortion may occur when changing the subtitles.

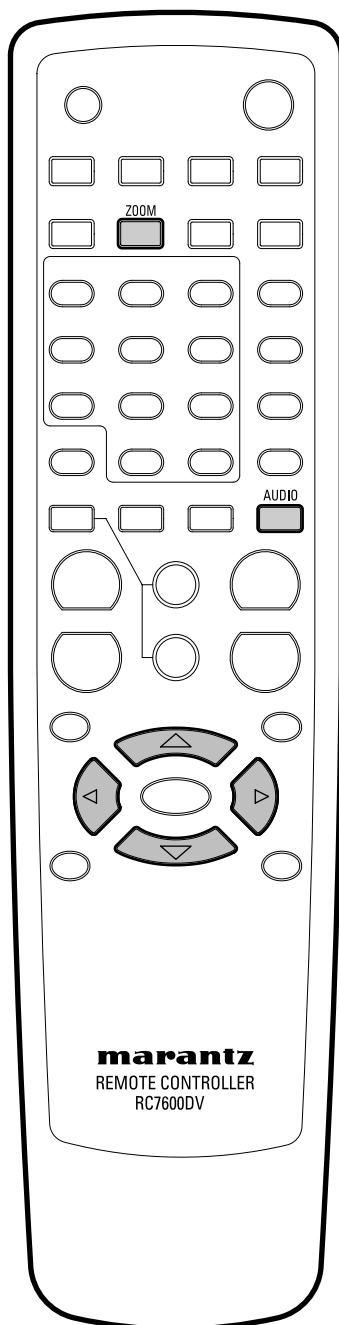

Switching Audio Language

(DVD-Video)

When playing a DVD-Video disc recorded with dialog in two or more languages, you can switch audio language anytime during playback.

- **To display/switch the audio language, press AUDIO repeatedly.**
The current audio language is shown on-screen.

the total number of the
audio included on the disc sound recording system

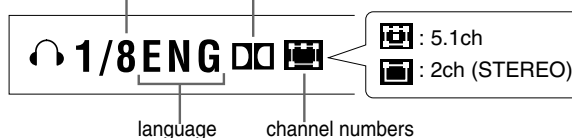

- **To set audio language preferences, see page 44.**

Note

- Depending on the disc, there are cases in which audio language cannot be switched during play. In this case, make changes using the DVD menu.
- Super Audio CD and MP3 cannot be switched.
- It may take a few seconds till a selected Audio Language is audible.
- Video distortion may occur when changing the Audio Language.

Switching audio channel

Depending on the disc, this feature may not work.

(DVD-Audio)

Depending on the disc, you may be able to switch channels when playing DVD-Audio discs—see the disc box for details.

- **To switch the audio channel, press AUDIO repeatedly.**

(Video CD)

On Video CDs you can switch between stereo, just the left channel or just the right channel.

- **To switch the audio channel, press AUDIO repeatedly.**
The current playback channel(s) are indicated on-screen.

Using the Zoom Function

(DVD-Video)

- 1 **During play or pause mode, press the ZOOM button on the remote control to zoom in X2/X4/X16/Normal in order.**
- 2 **Use the cursor buttons (▲/▼/◀/▶) to select the part of the screen you want to zoom in on.**

Note

- Zoom play cannot be used on some discs.
- Zoom will not operate properly for some scenes.
- Zooming may cause image deterioration or shaking.

Playing Discs

5

English

Press the **DISPLAY** button repeatedly during playback to display different information about the disc.

The display on screen change as follows:

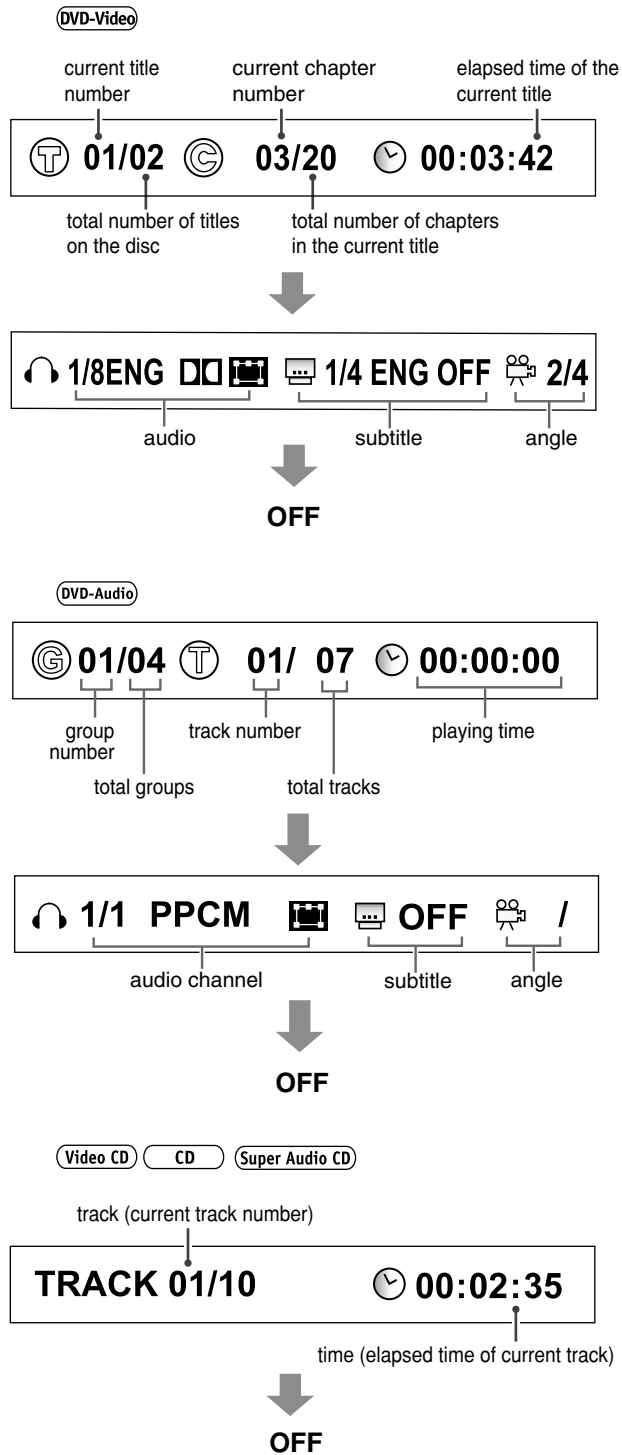

Note

The above information is not displayed with a Video CD playing in PBC mode.

The display on the front panel change as follows:

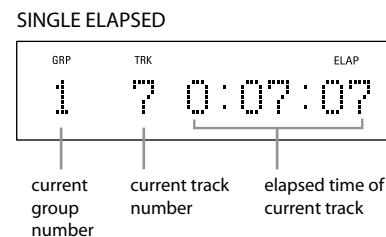
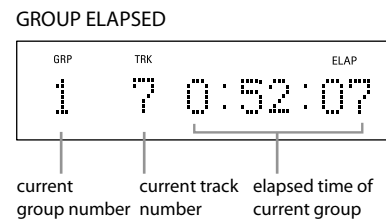
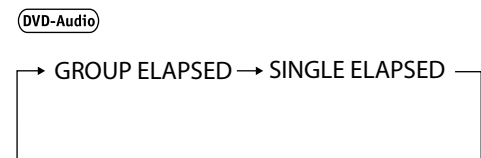
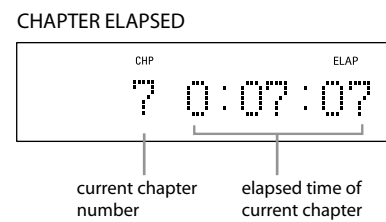
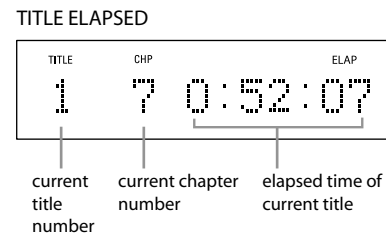
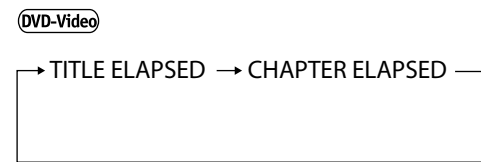

Video CD **CD** **Super Audio CD**

Only **SINGLE ELAPSED** time is displayed.

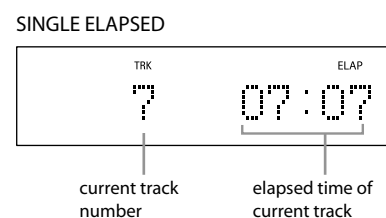

25

Making a program list

This feature lets you program the play order of tracks on a disc. You make a program list via display on the front panel, using the number buttons to enter tracks.

Note that programmed playback is not available for DVD.

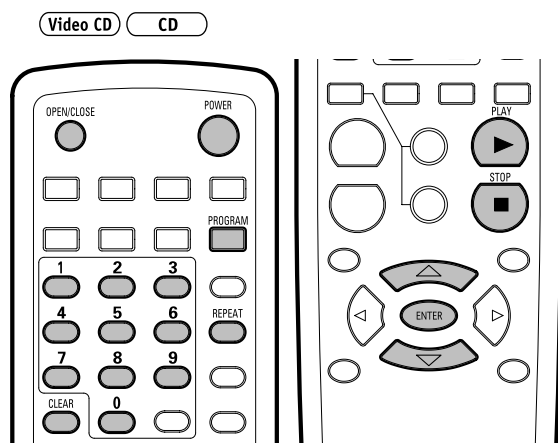

Use to 32 tracks can be programmed in the desired order.

- 1 Press the **PROGRAM** button in the stop mode.
- 2 Press the number buttons to select a track.

Example:

To select Track No.3, press 0 and 3.

- 3 Press the **ENTER** button.

The track is programmed.

Repeat steps 2 and 3 to program more tracks.

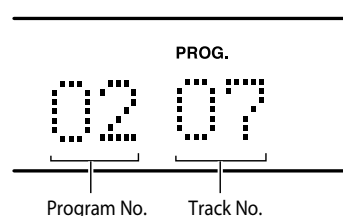

- 4 When the selection of track numbers has been finished, press the **▶ (PLAY)** button to start programmed playback.

- If you press the **REPEAT** button and select "REPEAT ALL", the programmed tracks will be played repeatedly.
- During programmed playback, the number buttons don't work.

To check the programmed content

In the stop mode, press the cursor buttons (**▲/▼**) repeatedly.

The programmed content (program number, track number and playback time) will be shown on the display in the programmed order.

To delete a programmed track

In the stop mode, press the cursor buttons (**▲/▼**) repeatedly until the programmed track to be deleted is displayed. Then press the **CLEAR** button. The selected track is deleted from the program and the track programmed next is moved to take its place, and is shown on the display.

To overwrite a programmed track

In the stop mode, press the cursor buttons (**▲/▼**) repeatedly until the programmed track to be changed is displayed. Select a new track number using the number buttons, and then press the **ENTER** button.

To add a track to the end of the program

In the stop mode, press the cursor button (**▲**) repeatedly until "--" is displayed. Select a track number using the number buttons, and then press the **ENTER** button. The track is added to the end of the program.

To resume normal playback

In the stop mode, press the **PROGRAM** button to resume normal playback. The "PROG." indicator will go off and the program mode will be cancelled.

However, the programmed content isn't lost. You can return to the programmed playback by pressing the **PROGRAM** button in the STOP mode and the **▶ (PLAY)** button.

To clear the programmed content

With the unit stopped and the "PROG." indicator lit, press the **CLEAR** button to clear the programmed content.

If one of the following buttons is pressed, the programmed content will also be cleared: **OPEN/CLOSE, POWER**

Note

- When in VCD 2.0 mode (PBC ON mode), this function does not work.
- You cannot program the CD area of a Super Audio CD.

Playing MP3s

This player can play MP3 files on a CD-ROM disc. MP3 is a popular audio format on computers and the Internet because file sizes are small (compared to uncompressed CD audio), while the sound quality remains surprisingly good.

- 1 When an MP3 disc is loaded, directories will be shown on the screen.

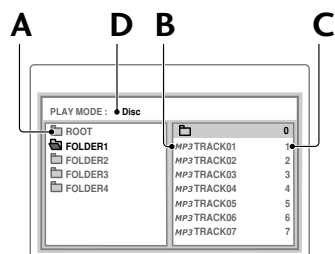

A directory's name

B file name

C file number

D play mode (See page 22)

- 2 Select a directory by pressing the ▲/▼/◀/▶ buttons and press the ► (PLAY) button or ENTER button.
- 3 Track numbers and titles (file names) will appear on the screen. Select the desired file by pressing the ▲/▼ or number buttons of the remote control and press the ► (PLAY) button. Playback will start from the selected track.

Note

- During playback, elapsed time of the current file is displayed on the front panel display.

Using Random Play

Press the **RANDOM** button during the Play mode.

To cancel the Random Play, press the **RANDOM** button again.

Using Repeat Play

Press the **REPEAT** button during playback.

See page 22 for more information.

Note

- Depending on the disc, the Random and Repeat functions may not work.
- Please refer to "Caution!" on page 9.

Playing JPEG

- 1 When a JPEG disc is loaded, directories will be shown on the screen.

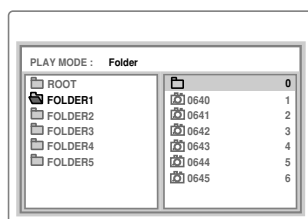

- 2 Select a directory by pressing the cursor buttons (▲/▼/◀/▶) and press the ► (PLAY) button or ENTER button.
- 3 File names will appear on the screen. Select the desired file by pressing the ▲/▼ or number buttons of the remote control and press the ► (PLAY) button. Slide show will start from the selected file.

Note

- Some files on the JPEG disc may be distorted during playback due to the configuration or characteristics of the disc.
- Please refer to "Caution" on page 9.

1) How to pause the display

Press **II** (PAUSE) button. To start playback, press ► (PLAY) button.

2) How to cue a still image to be displayed

Press the **SKIP** (▶▶) (NEXT) button to proceed to the next still image and press the **SKIP** (◀◀) (PREV.) button to return to the previous still image.

3) Changing the orientation of a still image

- Press the cursor button (▶) to rotate the image clockwise 90 degrees.
- Press the cursor button (◀) to rotate the image counter-clockwise 90 degrees.
- Press the cursor buttons (▲) to flip the image from top to bottom by 180 degrees.
- Press the cursor button (▼) to flip the image from right to left by 180 degrees.

4) Zoom playback

To zoom, press the **ZOOM** button during playback.

- Each time the **▶▶** (FF) button, the magnification level changes.
- Each time the **◀◀** (REV) button, the reduction level changes.

Note

- The picture is rendered in Still mode while zooming.
- Zoom play cannot be used on some discs.
- Zoom will not operate properly for some scenes.
- The Setup Key does not operate during thumbnail display.

Video Adjust

You can set the picture settings you desire and store them in the player's memory.

Selecting a preset

- 1 Press the **VIDEO ADJ.** button on the remote control.
- 2 Select "Memory Select".
- 3 Use the cursor buttons (◀/▶) to select a preset, and press **ENTER** button.

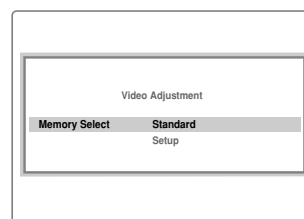

- **Standard** – optimized settings for a standard television set
- **Memory 1, 2, 3** – User presets (see below for more on these)

You can highlight a preset while a disc is playing (before you press **ENTER** to select it) to see the effect on the picture immediately.

Note

- Depending on the disc and your TV/monitor, the effect of these settings may not be clear.

Creating your own setting

- 1 Press the VIDEO ADJ. button on the remote control.
- 2 Select "Setup" and then press ENTER.

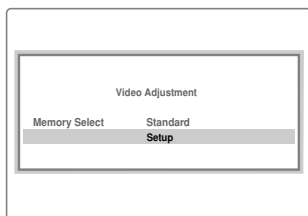

- 3 Use the cursor buttons (◀/▶) to select a Memory (Memory 1, 2, 3) to change/store a picture quality parameter.

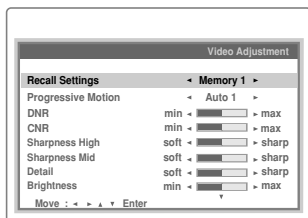

- 4 Use the cursor buttons (▲/▼) to select a picture quality parameter, then use the cursor buttons (◀/▶) to adjust that parameter.

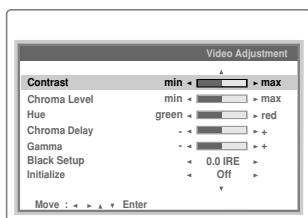

- **Progressive Motion** – When using progressive scan, this adjusts the motion and still picture quality. There are two modes: Auto and Video. In Auto mode, the player automatically distinguishes film-source material and video-source material. Set to the Video mode when you know the program you are watching is from video-source material (such as animations).
Auto 1: Standard setting
Auto 2: Setting for moving images
Auto 3: Setting for still images
Video 1: Standard setting
Video 2: Setting for moving images
Video 3: Setting for still images
- **DNR** – Adjusts the amount of noise reduction (NR) applied to the Y (brightness) component

- **CNR** – Adjusts the amount of noise reduction (NR) applied to the C (color) component
- **Sharpness High** – Adjusts the sharpness of the high-frequency (finely detailed) elements in the picture
- **Sharpness Mid** – Adjusts the sharpness of the mid-frequency (less detailed) elements in the picture
- **Detail** – Adjusts how sharp edges appear in the picture
- **Brightness** – Adjusts the image brightness
- **Contrast** – Adjusts the image contrast
- **Chroma Level** – Adjusts how saturated colors appear
- **Hue** – Adjusts the overall color balance between red and green
- **Chroma Delay** – Compensates for misalignment of the Y (brightness) and the C (color) components
- **Gamma** – Adjusts the brightness of the darker images in the picture
- **Black Setup** – Corrects floating black color
- **Initialize** – Returns to the default values

- 5 Press ENTER to save your changes.

Note

- Pressing **DISPLAY** while the VIDEO ADJUSTMENT screen is displayed shows one adjustment item, as given below, so that you can adjust the item while confirming its effect. Pressing **DISPLAY** again returns to the former setting.

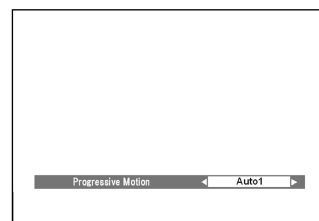

- **Chroma Delay** will not operate in **Composite Video out**, **S2 Video out** and **COMPONENT Video out** when **Interlace** is selected.

Using the FL menu

The FL menu has been designed to set "HDMI ON/OFF", "HDMI RESET" and "REMOT CODE".

The FL menu cannot be used if a disc is playing.

It is recommended to set the FL menu before loading a DVD.

If a DVD has been loaded, be sure to press ■ (STOP) twice before proceeding.

(If "RESUME" is displayed in the FL display, press ■ (STOP).)

Selecting the FL menu

Press **SETUP** for longer than 2 sec.

The **FL OFF** indicator on the player turns on and off.

FL menu is displayed in the FL display.

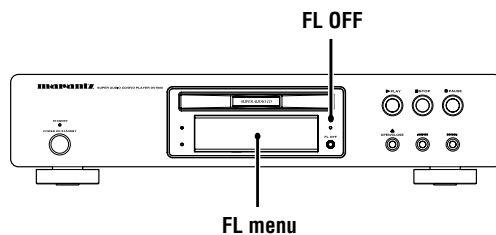

Use the cursor buttons (▲/▼) to select the FL menu you want as follows.

(Example)

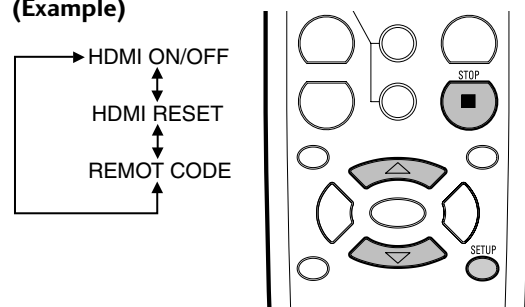

To exit the FL menu

When you have completed setting up the FL menu or if you want to exit the FL menu, press **SETUP** to close the FL menu.

HDMI ON/OFF setting

Select **HDMI ON/OFF**, then press **ENTER**.

Use the cursor buttons (▲/▼) to select **ON** or **OFF** as follows.

(Example)

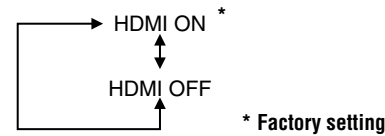

Press **ENTER** you want to set.

The menu selection is set.

Note

- If you want to use HDMI function, set the **HDMI** in the **SETUP** menu. (page 37)

HDMI RESET

Select **HDMI RESET**, then press **ENTER**.

"SURE" is displayed in the FL menu.

Press **ENTER** if you want to **RESET**.

The menu selection is set.

Note

- If images are not displayed properly on the TV or projector after making HDMI setting on the Setup menu, reset the set (see page 47). This will return the HDMI setting to the state before the setting was made.

REMOT CODE setting

Select **REMOT CODE**, then press **ENTER**.

Use the cursor buttons (▲/▼) down to select the type of **REMOT CODE** you want to set as follows.

(Example)

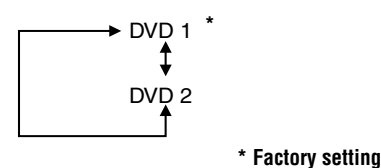

Press **ENTER** you want to set.

The menu select is set.

- The DVD player support two remote control codes: DVD 1 and DVD 2.
- Set the remote control code of the Remote Control to the same setting.
- See page 15 for more information.

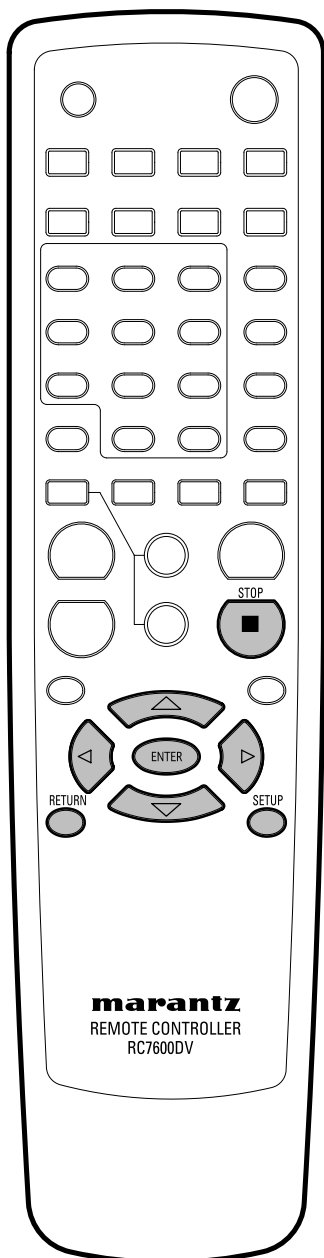

Using the Setup Menu

Before using the player, you should specify the settings to be used in accordance with the conditions under which the player is to be used.

Note that once changed, the settings will be saved and remain the same even after the power has been turned off until the settings are changed again.

The Setup menu gives you access to all the player's settings. Press **SETUP** to display/leave the menu and the cursor and **ENTER** buttons on the remote control to navigate and select options. The controls for each menu are shown at the bottom of the screen.

Note

- The language options shown in the on-screen display illustrations on the following pages may not correspond to those available in your country or region.

- 1 Press the **SETUP** button on the remote control. Select a tab using the cursor buttons (◀/▶).

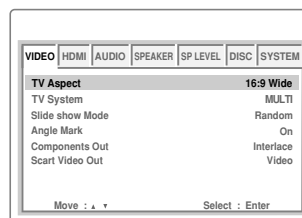

- 1 **Video:** Setup of the Display Options (page 33)
Use to select which type of screen you want to watch and several display options.

- 2 **HDMI:** Setup of the HDMI (page 37)

- 3 **Audio:** Setup of the Audio Options (page 39)

- 4 **Speaker:** Setup of the Speaker size and Distance (page 43)

- 5 **SP Level:** Setup of the Speaker Level (page 44)

- 6 **DISC:** Setup of the Language and several other options (page 44)

- 7 **System:** Setup of the Parental Level and several other options. (page 46)
Allows users to set the level necessary to prevent children from viewing unsuitable movies such as those with violence, adult subject matter, etc. and several other options.

- 2 Use the cursor buttons (▲/▼) on the remote control to access the different features.

- 3 Press the **ENTER** button as many times as necessary to select the desired option. To make the setup screen disappear after setting up, press the **SETUP** button again.

Note

- Depending on the disc, some Setup Menu selections may not work.
- Some settings can not be selected during playback and **RESUME** mode of DVD-Video. In that case, press the **STOP** button once or twice to stop playback completely.
- SETUP** button is not pressed during playback mode of DVD-Audio. In that case, press the **STOP** button one or twice to select RESUME mode or STOP mode.

Black dot (●) indicates the default setting

* It can be set only during STOP.

Video (page 33)

TV Aspect (page 33)

- 4:3 Pan Scan
- 4:3 L-Box
- 16:9 Wide
- 16:9 Squeeze

TV System (page 35)

- NTSC
- PAL
- MULTI

Slide show Mode (page 35)

- None
- Random
- TYPE 1 - 11

Angle Mark (page 35)

- On
- Off

Components Out (page 36)

- Progressive
- Interlace

SCART Video Out

(Europe Model Only) (page 36)

- Video
- S-Video
- RGB

Speaker* (page 43)

Front L/R Size (page 43)

- Large
- Small

Center Size (page 43)

- Large
- Small
- None

Rear LS/RS Size (page 43)

- Large
- Small
- None

LFE (Sub Woofer) (page 43)

- On
- None

Front L/R Distance (page 43)

10 ft/3.0m

Center Distance (page 43)

10 ft/3.0m

Rear LS/RS Distance (page 43)

10 ft/3.0m

LFE (Sub Woofer) Distance (page 43)

10 ft/3.0m

HDMI (page 37)

Resolution (page 37)

- VGA<640X480>
- 480p/576p(525p/625p)
- 720p(750p)
- 1080i(1125i)

Format (page 37)

- RGB-Normal
- RGB-Expand
- YCbCr-1 (4:4:4)
- YCbCr-2 (4:2:2)

TV Aspect (page 37)

- 4:3 Pan Scan
- 4:3 L-Box
- 16:9 Wide
- 16:9 Squeeze

Audio (page 38)

- Auto
- PCM
- OFF

SP Level (page 44)

Test Tone*

- Auto
- Off
- Manual

Front L Level

Center Level

Front R Level

Rear RS Level

Rear LS Level

LFE (Sub Woofer) Level

DISC (page 44)

Audio Language (page 44)

- English
- French
- Spanish
- Japanese
- German
- Italian
- Netherlands
- Others

Subtitle Language (page 44)

- English
- French
- Spanish
- Japanese
- German
- Italian
- Netherlands
- Others
- Off

DVD Menu Language (page 44)

- English
- French
- Spanish
- Japanese
- German
- Italian
- Netherlands
- Others

Player Mode* (page 45)

- DVD Audio
- DVD Video

Audio (page 39)

Digital Out (page 39)

- Bitstream
- PCM
- Off

MPEG Out (page 39)

- PCM
- Bitstream

PCM Down Sample (page 40)

- Off
- On

Audio Out* (page 41)

- 2 Channel (Lt/Rt)
- 2 Channel (Stereo)
- TruSurround
- 5.1 Channel

Audio DRC (page 42)

- Off
- On

System (page 46)

OSD Language (page 46)

- English
- Francais
- Espanol
- Deutsch
- Italiano

Parental Rating Level (page 46)

- Unlock
- Input Password

Parental Password (page 46)

- Change
- Old Password
- New Password
- Confirm Password

Defaults (page 46)

- Reset
- Input Password

Bonus Group (page 46)

- Input Password

Auto Power Off (page 46)

- On 30 min
- Off

Note

- **SETUP** button is not pressed during playback mode of DVD-Audio.

Setting up the Video Setup

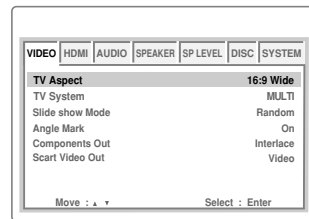

TV Aspect







- Default setting: **16:9 Wide**







If you have a widescreen TV, select the **16:9 Wide** setting—widescreen DVD software is then shown using the full screen area. When playing software recorded in conventional (4:3) format, the settings on your TV will determine how the material is presented—see the manual that came with your TV for details on what options are available. If your TV does not have settings for how 4:3 sources look, choose the **16:9 Squeeze** setting. The picture you see on your TV will be determined by the disc. See [page 34](#) for more information.



If you have a conventional TV, choose either **4:3 L-Box** or **4:3 Pan Scan**. In Letter Box mode, widescreen software is shown with black bars at the top and bottom of the screen. Pan & Scan chops the sides off widescreen material to make it fit the 4:3 screen (so even though the picture looks larger on the screen, you're actually seeing less of the movie).

Note

- Some discs will not allow you to change the aspect ratio.

When viewing on a standard TV or monitor			
Screen format of disc	Setting	Appearance	Appearance
16:9 	4:3 L - Box		The picture is shown in widescreen with black bars at the top and bottom of the screen.
	4:3 Pan Scan		The sides of the picture are cropped so that the picture fills the whole screen.
4:3 	16:9 Wide		The picture is squashed. Set to either Pan & Scan or Letter Box.
	16:9 Wide 4:3 L - Box 4:3 Pan Scan		The picture is presented correctly on any setting.

When viewing on a widescreen TV or monitor				
Screen format of disc	Player Setting	TV Setting	Appearance	
16:9 	16:9 Wide	Normal		The picture is squashed. Set your TV to 'Full'.
		Full		The picture is presented in widescreen.
4:3 	16:9 Wide	Normal		The picture is presented with black bars either side.
		Full		The picture is stretched. Set your TV to 'Normal'.

Choose this setting if you have a progressive scan-compatible TV and the aspect ratio cannot be changed.				
4:3 	16:9 Squeeze (This setting only has any effect with progressive output.)	Full		The picture is presented with black bars either side.

TV System

- Default setting: **MULTI**

The default setting of this player is **MULTI**, and unless you notice that the picture is distorted when playing some discs, you should leave it set to **MULTI**.

If you experience picture distortion with some discs, set the TV system to match your country or region's system. Doing this, however, may restrict the kinds of disc you can watch. The table below shows what kinds of disc are compatible with each setting (**MULTI**, **PAL** and **NTSC**).

Disc		Output format		
Type	Format	Position of TV SYSTEM		
		NTSC	PAL	MULTI
DVD	NTSC	NTSC	PAL	NTSC
	PAL	NTSC	PAL	PAL
Video CD/ Super VCD	NTSC	NTSC	PAL	NTSC
	PAL	NTSC	PAL	PAL
Super Audio CD		NTSC	PAL	NTSC
CD, No disc		NTSC	PAL	NTSC/PAL

Note

- When the selected format is changed to a different format from the TV format in which a program was recorded, the picture may become jerky and the upper and lower parts of the screen may disappear. The above setting should be specified to match the format of your own TV.

Slide show Mode

- Default setting: **Random**

When a JPEG file is played, you can enjoy twelve slideshow effects.

Press the **ENTER** button to select the desired mode from the following:

TYPE 1-11

- TYPE 1 : wipes from top to bottom
- TYPE 2 : wipes from bottom to top
- TYPE 3 : wipes from top/bottom to center
- TYPE 4 : wipes from center to top/bottom
- TYPE 5 : vertical blinds
- TYPE 6 : wipes from left to right
- TYPE 7 : wipes from right to left
- TYPE 8 : wipes from left/right to center
- TYPE 9 : wipes from center to left/right
- TYPE 10 : wipes from edge to center
- TYPE 11 : horizontal blinds

Random

Wipers randomly

None

No effect

Angle Mark

- Default setting: **On**

Select whether the angle message appears on the TV screen or not when a multi-angles scene is being played. You can change the angles using the **ANGLE** button.

Note

- To switch on/off the Angle Mark on the Setup Menu, the screen starts from Multi-Angle starting position.

Components Out

- Default setting: **Interlace**

Compared to a standard interlaced TV picture, a progressive scan TV is capable of stable, flicker-free images.

Set only if you connected the **COMPONENT VIDEO OUT** to a progressive scan-compatible TV or monitor.

- **Progressive** – Use this setting with TVs and monitors that have progressive scan component video inputs. Check the TV's instruction manual if you are not sure about this.
- **Interlace** – Use this setting with regular TVs that are not compatible with progressive scan. Check the TV's instruction manual if you are not sure about this.



Tip

If this player is set to output progressive-scan video, it's possible that the picture will appear stretched when playing discs recorded in 4:3 format. This happens when the TV's aspect ratio is set to 'Full'. To see the picture in its correct aspect ratio, change the TV setting to 'Normal'.

If your TV doesn't have settings to change the aspect ratio of the picture, set this player to **16:9 Squeeze**.



Note

- If you connect a TV that is not compatible with a progressive scan signal and choose one of the progressive scan settings, you will not be able to see any picture at all. With your TV connected using either the composite or S-Video terminals, choose the **Interlace** setting in the **Component Video** menu.
- Compatibility of this unit with progressive-scan TVs:
Note that not all high definition television sets are fully compatible with this unit and may cause artifacts to be displayed in the picture. In case of progressive scan picture problems, try switching the connection to the "STANDARD DEFINITION" output.

SCART Video Out (Europe Model only)

- Default setting: **Video**

These settings are only applicable if you're using the A/V EURO CONNECTOR SCART-type connector.



Important

If you make a setting here that is incompatible with your TV, the TV may not display any picture at all. If this happens either switch everything off and reconnect to the TV using either the supplied composite video cable, or an S-Video cable (see **pages 10-11** for more on this), or reset the unit (see **page 47** for how to do this).

- **Video** – Compatible with all TVs, but lowest quality of the three AV settings.
- **S-Video** – Almost the same quality as **RGB**, but can give better results if you are using a long SCART cable.
- **RGB** – If your TV is compatible, this setting gives the best picture quality.

Setting up the HDMI Setup

This setting is used when the unit is connected by HDMI or DVI with a TV or projector.

This setting is enabled only when the HDMI option of the FL menu is On. (page 30)

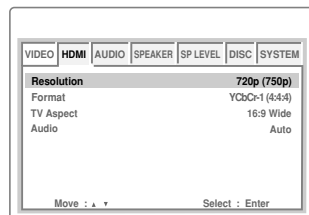

Resolution

- VGA <640 X 480>
- 480p/576p (525p/625p)
- 720p (750p)
- 1080i (1125i)

Select one of the above with the **ENTER** button.

Note

- The resolutions available for HDMI outputs depend on the connected TV or projector. For details, see the user's manual of your TV or projector.
- If, after changing the resolution, images are not displayed properly on the TV or projector, press and hold the **SETUP** button for two seconds to bring up the FL menu. Then set **HDMI RESET** to reset. (page 30)
- VGA can be outputted only when TV System is set to NTSC.
- When the resolution changes, the image may be corrupted or the output may take longer than normal.
- A higher number generally indicates better picture quality (480P/576P → 720P → 1080i).

Format

- RGB-Normal
- RGB-Expand
- YCbCr-1 (4:4:4)
- YCbCr-2 (4:2:2)

Select one of the above with the **ENTER** button.

Note

- Image data values in RGB-Normal format range between 16 (black) and 235 (white).
- Image data values in RGB-Expand format range between 0 (black) and 246 (white).
- The formats available for HDMI outputs depend on the connected TV or projector. For details, see the user's manual of your TV or projector.
- Only RGB-Normal and RGB-Expand can be selected for DVI outputs.
- When black rise to the surface depending on the display, black Setup in the Video Adjustment set to OIRE.
- YCbCr-1 (4:4:4) sends 8 bit data. YCbCr-2 (4:2:2) sends 10 bit data. If your TV or projector supports YCbCr-2 (4:2:2), you can enjoy the superior image quality of full 10 bit processing.

TV Aspect

- 4:3 L - Box
- 4:3 Pan Scan
- 16:9 Wide
- 16:9 Squeeze

Select one of the above with the **ENTER** button.

Note

- The TV aspect ratios available for HDMI outputs depend on the connected TV or projector. For details, see the user's manual of your TV or projector.
- Only **16:9 Wide** and **16:9 Squeeze** can be selected when the HDMI/DVI resolution is set to 720p or 1080i.
- When this TV Aspect is in effect, it also determines the aspect output of Composite Video, S-Video, and Component Video.

6 DVD Setup Menu

Setup Examples

Resolution (HDMI Setting)	Playback Disc			
	Disc Recorded in Squeeze Ratio		Disc Recorded in 4:3 Ratio	
	Aspect (HDMI Setting)	Monitor Settings	Aspect (HDMI Setting)	Monitor Settings
480p/576p (525p/625p)	16:9 Wide	Full/Squeeze	4:3 16:9 Wide	Standard Normal 4:3 Through
720p/1080i (750p/1125i)		Normal/Through	16:9 Squeeze	

Some monitors may use setting names that are different than those shown here.

Audio

- **Auto:** Audio is output as a bit stream when the connected device is set to Dolby Digital, DTS, or MPEG. Audio is output as linear PCM when the connected device is set to Linear PCM. If the connected device cannot accept bit streams, audio will be output as linear PCM.
 - **PCM:** Audio is converted to linear PCM.
 - **OFF:** HDMI output Audio = OFF
- Select the Digital Out (**page 12**) setting as described in "Setup Menu - Audio" (**page 39**).
- Select one of the above with the **ENTER** button.

Note

- Audio is not output from Super Audio CDs or DVD-Audio discs with CPPM protection.
- Audio is not output when the player is connected to a device with an HDCP-compatible DVI jack.
- All of PCM signal from digital out (**page 12**) is converted to 44.1 kHz/48kHz.
- Turn the power on the front panel **OFF** during play or pause. Noise from a television etc. may come out.
- When HDMI Audio is set to Auto or PCM, the Digital Out (**page 12**) setting is as per HDMI Audio.

HDMI Audio Output

Audio Formats		HDMI Setting (Audio)		
		Auto	PCM	OFF
DVD	Dolby Digital	Dolby Digital* ¹	2 Channel DOWNMIX	OFF
	Linear PCM	Left/Right	Left/Right	OFF
	DTS	DTS* ¹	2 Channel DOWNMIX	OFF
	MPEG	MPEG* ¹	Left/Right	OFF
DVD-Audio	With CPPM protection	* ²	* ²	OFF
	Without CPPM protection	* ²	* ²	OFF
CD/MP3/Super Audio CD* ³		Left/Right		OFF
DTS CD		DTS* ¹	2 Channel DOWNMIX	OFF
Video CD		Left/Right		OFF

*¹: The player automatically switches to PCM output when the connected device does not support Dolby Digital, DTS, or MPEG bit streams.

*²: Output will be 48kHz/16-bit or 44.1kHz/16-bit.

Multi-channel PCM sources are down mixed to channel 2. (A source whose down-mixing is prohibited is only output to FL/FR.)

*³: Audio is not output from Super Audio CDs. This applies to only play the CD Audio part.

Setting up the Audio Setup

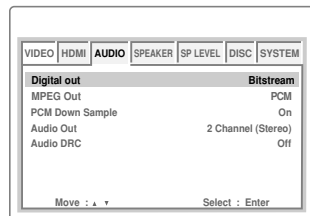

- * You only need to make Digital Out, MPEG Out and PCM Down Sample setting if you connected this system to another component (AV amplifier, etc.) using one of the digital outputs.
- * When HDMI is connected and the HDMI menu Audio setting is Auto or PCM, the Digital Out and MPEG Out settings are as per the HDMI menu Audio setting, and PCM Down Sample is always on.

Digital Out*

- Default setting: **Bitstream**

If your AV amplifier (or other connected component) is Dolby Digital compatible, and has a built in DTS decoder set to **Bitstream**, otherwise set to **PCM**. Check the manual that came with the other component if you're unsure whether it is Dolby Digital and DTS compatible.

If at any time you need to switch off the digital audio output, set this to **Off**. Note that you can't switch on/off the optical and coaxial outputs individually.

Note

- Super Audio CD will not output digital sound.
- If you set to **Bitstream** with a non-DTS compatible amplifier, noise will be output when you play a DTS disc.
- Set to **Bitstream** for Dolby Digital and DTS 5.1 channel analog output.
- Set to Off for DVD Audio 192/176.4/96/88.2 kHz Hi Sampling and 5.1 channel analog output.

MPEG Out*

- Default setting: **PCM**

If your AV amplifier (or other connected component) is compatible with MPEG audio, set this to **Bitstream**, otherwise set it to **PCM** (MPEG audio is converted to more compatible PCM audio).

Check the manual that came with the other component if you're unsure whether it is MPEG audio compatible.

PCM Down Sample*

- Default setting: **On**

If the digital input of your AV amplifier (or other connected component) is compatible with high sampling rates (96kHz), set this to **Off**, otherwise set it to **On** (96kHz audio is converted to a more compatible 48kHz). Check the manual that came with the other component if you're unsure whether it is 96kHz compatible.

 **Note**

- Even when set to **Off**, some discs will only output down sampled audio (48kHz/44.1kHz) through the digital outputs. High sampling rate DVD-Audio discs (192kHz or 176.4kHz) always output audio down sampled to 96kHz or 44.1kHz through the digital outputs.

PCM Down Sample

	Audio recording format		PCM Down Sample OFF		ON
			Copyright protected	Not copyright protected	
DVD-Video	PCM	48kHz	No output produced* ¹	48kHz	48kHz
		96kHz	No output produced	96kHz	48kHz
DVD-Audio	PCM	44.1kHz	No output produced* ²	44.1kHz	44.1kHz
		48kHz	No output produced* ¹	48kHz	48kHz
		88.2kHz	No output produced	44.1kHz	44.1kHz
		96kHz	No output produced	96kHz	48kHz
		176.4kHz	No output produced	44.1kHz	44.1kHz
		192kHz	No output produced	96kHz	48kHz
Video CD	MPEG1		44.1kHz		44.1kHz
Audio CD	44.1kHz		44.1kHz		44.1kHz
MP3 CD	MP3 (MPEG-1 Audio Layer 3)		44.1, 48kHz		44.1, 48kHz
Super Audio CD	DSD (Direct Stream Digital)		No output produced* ³		No output produced* ³

*¹: Output will be produced from 48kHz/16-bit source.

*²: Output will be produced from 44.1kHz/16-bit source.

*³: Output will consist of 44.1kHz linear PCM output when replaying CD layer.

- When digital output is turned off, no digital audio data will be output from the digital audio output terminal (see [page 39](#)).

Audio Out

- Default setting: **2 Channel (Stereo)**

If you connected this player to your amplifier using the 5.1 channel analog outputs (front, surround, center and subwoofer outs), set this to **5.1 Channel**; if you connected only the stereo outputs, set to **2 Channel (Stereo)**.

- **2 Channel (Lt/Rt)**

Used to specify that DTS multi-channel input or Dolby Digital multi-channel input is to be downmixed into a format compatible with the Dolby Surround matrix format. This option may be selected to enjoy surround sound when the player is connected to Dolby Surround-compatible AV amplifier.

- **TruSurround**

If you connected your DVD player using only the stereo analog outputs, you can simulate surround sound.

Note

- Works with DVD-Video and VCD only.
- The digital audio output is processed by TruSurround when playing 2 channel Dolby Digital DVDs or Video CDs with TruSurround. It is recommended that Audio Out is set to **2 channel (stereo or Lt/Rt)** when connecting the player to your amp using a coaxial or optical connection.
- How good the surround effect is varies with the disc.
- When **TruSurround** is selected, the audio can be output only for the L/R channels on the Front.

Note

- Even if you set **Audio Out** to **5.1 Channel**, you'll only get sound from all speakers when playing a multi-channel DVD-Audio disc, multi-channel Super Audio CD disc, Dolby Digital or DTS encoded DVD disc.
- Set Digital Out (**page 39**) to **Bitstream** for Dolby Digital and DTS 5.1 channel analog output.
- Set Digital Out (**page 39**) to **Off** for DVD Audio 192/176.4/96/88.2 kHz Hi Sampling and 5.1 channel analog output.
- When you set it to 5.1 Channel, the overall output level may sound quieter than when set to **2 Channel (Stereo, Lt/Rt)** or **TruSurround**.
- If you set to **2 Channel (Stereo), 2 Channel (Lt/Rt), TruSurround**, Dolby Digital and DTS are mixed down to two channels so you still hear all the audio recorded on the disc.
- Some DVD-Audio discs don't allow down-mixing of audio. These discs always output multi-channel audio regardless of the setting made here.
- Change can be made only in the stop mode. When RESUME is indicated on the display, put the player in the STOP mode by pressing ■ **(STOP)** button.

SRS TruSurround

SRS TruSurround uses technology that simulates multichannel surround sound using only two speakers.



6 DVD Setup Menu

About source audio output

When the source output mode has been switched between the **5.1 Channel** and **2 Channel (Stereo or Lt/Rt)** mode settings using the **Audio Out** setting in the Setup screen **Audio** menu, audio output for each source will be as shown in the following table.

AUDIO CONTENTS	OUTPUT MODE	AUDIO OUT (2 CH)	AUDIO OUT (5.1 CH)			
		L, R (Front L,R)	Center	Surround L,R	Sub Woofer	
DVD	Dolby Digital	5.1 CH	Front Lch, Rch	Center	Surround LS, RS	LFE
		Other	2 ch DOWNMIX Lch, Rch or Lt/Rt	MUTE		
	LPCM	5.1 CH/Other	Lch, Rch	MUTE		
		5.1 CH	Front Lch, Rch	Center	Surround LS, RS	LFE
	DTS	5.1 CH	Front Lch, Rch	Center	Surround LS, RS	LFE
		Other	2 ch DOWNMIX Lch, Rch or Lt/Rt	MUTE		
	MPEG	5.1 CH	Front Lch, Rch	Center	Surround LS, RS	LFE
		Other	2 ch DOWNMIX Lch, Rch	MUTE		
	DVD -Audio ³	5.1 CH	Front Lch, Rch	Center	Surround LS, RS	LFE
		Other	2 ch DOWNMIX Lch, Rch ¹	MUTE		
	CD	5.1 CH/Other	Lch, Rch	MUTE		
	Super Audio CD	5.1 CH	Front Lch, Rch	Center	Surround LS, RS	LFE
Other		2 ch DOWNMIX Lch, Rch	MUTE			
Video CD	5.1 CH/Other	Lch, Rch	MUTE			
DVD-RW	5.1 CH/Other	Lch, Rch ²	MUTE			

¹: Discs that prohibit downmixing will be output as 5.1 channel even if **2 Channel (Stereo)** is selected.

²: If the sound is mono, Lch and Rch audio will be the same.

³: Set Digital Out (**page 39**) to **Off** for DVD Audio 192/176.4/96/88.2 kHz Hi Sampling and 5.1 channel analog output.

Audio DRC

- Default setting: **Off**

When watching Dolby Digital DVDs at low volume, it's easy to lose the low level sounds completely, including some of the dialog. Switching on Audio DRC (Dynamic Range Compression) can help things by bringing up the low level sounds, while keeping the lid on high level peaks.

The **Off** setting leaves the original dynamics intact; **On** 'squashes' the dynamics; but exactly how much difference you can hear between the settings will depend on the material you're watching.

Remember

- Audio DRC is only effective with Dolby Digital audio sources.
- The effect of Audio DRC depends on your speakers and AV amplifier settings.

Setting up the Speaker Setup

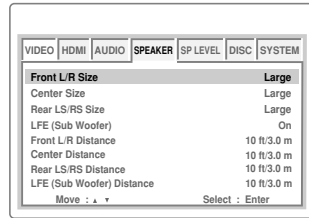

- Default setting: **Front L/R: Large | Center: Large | LFE (Sub Woofer): On | Rear LS/RS: Large**
- Change can be made only in the stop mode. When RESUME is indicated on the display, put the player in the STOP mode by pressing ■ **(STOP)** button.
- This setting can be set only Audio Out is set to 5.1 Channel.

Size

You only need to make this setting if you connected this player to your amplifier using the 5.1 channel analog outputs. This setting does not affect digital audio output.

Follow the on-screen displays to describe which speakers are in your system and their sizes and positions.

Set the size of your speakers in the Speaker Size screen. The front left/right (**L/R**), center (**C**) and rear left/right (**LS/RS**) speakers can each be set to **Large**, **Small** or **Off**. Set a speaker to **Large** if the main speaker cone is 12cm or more; set to **Small** if it's less than 12cm.

The **LFE (Sub Woofer)** can only be set to **On** or **Off**.

Distance

- Default setting: **10 ft/3.0 m**

Set the distance from your main listening position to each speaker in the Distance screen. The distance setting for any speaker that was set to **Off** in the Speaker screen will be disappeared. For the other speakers, enter the distance to the nearest 1 feet/0.3m. You can set the distance between 1.0 feet/0.3m and 30 feet /9.0m.

Note

- This setting does not apply to Super Audio CD playback.
- The maximum differences in speaker distance for which adjustment is possible is 15 feet/ 4.5m.

Setting up the SP Level Setup

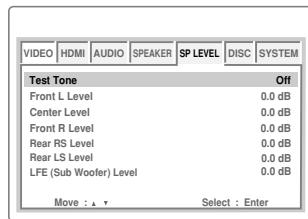

You may want to make this setting if you connected this player to your amplifier using the 5.1 channel analog outputs.

If you want to adjust the relative volume levels of any of the speakers, adjustment is in the range of -6dB to +6dB, in steps of 0.5dB.

- When you adjust it, the overall output level may sound quieter than when Audio out is set to **2 Channel (Stereo, Lt/Rt)** or **TruSurround**. This is not a malfunction.

To help you gauge the correct gain levels, set the **Test Tone** to **Manual** (test tone from just that speaker) or **Auto** (test tone from each speaker in turn), then adjust the gain so that all speakers appear to be the same volume from your listening position.

Follow the on-screen displays to select speakers and set the Output Levels.

- Many AV amplifiers allow you to make similar settings at the amplifier stage. In this case, set the output levels at the player or the amplifier, not both.
- As the test tone plays through a speaker, its name is highlighted in yellow on-screen.
- For the Manual Test Tone procedure, use the cursor buttons (**▲/▼**) to select the Speaker, then press the **ENTER** button to output the test tone, and once again press the **ENTER** button to change the level.

Note

- **Test tone cannot be used if a disc is loaded** press open/close to open the disc tray, and remove a disc. Be sure to press the open/close to close the disc tray.
- Change can be made only in the stop mode. When RESUME is indicated on the display, put the player in the STOP mode by pressing **■ (STOP)** button.
- This setting can be set only Audio Out is set to 5.1 Channel.

Setting up the DISC Setup

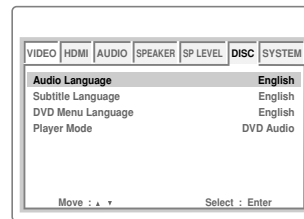

LANGUAGE settings

If you set the Audio Language, Subtitle Language and DVD Menu Language in advance, they will come up automatically every time you watch a movie.

- Default setting: **English**

The DVD format recognizes 136 different languages. Choose **Others** if you want to specify a language other than those listed, then follow the on-screen display to select a language. You may also want to refer to the Language code list on **page 45**.

Tip

You can switch between the languages and subtitle recorded on a DVD disc any time during playback using the **AUDIO** and **SUBTITLE** buttons. (This does not affect this setting.)

Note

- You cannot switch languages if there is only one language recorded on the disc. In this case, the **⊙** mark is displayed.
- For some discs, selection can be made using the DVD menu. In these cases, press **MENU** to display the DVD menu screen and then make your selection.
- If the selected language is not recorded on the disc, the original pre-recorded language is selected.

Language code list

Code	Language	Code	Language	Code	Language	Code	Language
6565	Afar	7079	Faroese	7678	Lingala	8375	Slovak
6566	Abkhazian	7082	French	7679	Laothian	8376	Slovenian
6570	Afrikaans	7089	Frisian	7684	Lithuanian	8377	Samoan
6577	Ameharic	7165	Irish	7686	Latvian, Lettish	8378	Shona
6582	Arabic	7168	Scots Gaelic	7771	Malagasy	8379	Somali
6583	Assamese	7176	Galician	7773	Maori	8381	Albanian
6588	Aymara	7178	Guarani	7775	Macedonish	8382	Serbian
6590	Azerbaijani	7185	Gujarati	7776	Malayalam	8385	Sendanese
6665	Bashkir	7265	Hausa	7778	Mongolian	8386	Swedish
6669	Byelorussian	7273	Hindi	7779	Moldavian	8387	Swahili
6671	Bulgarian	7282	Croatian	7782	Marathi	8465	Tamil
6672	Bihari	7285	Hungarian	7783	Malay	8469	Telugu
6678	Bengali; Bangla	7289	Armenian	7784	Maltese	8471	Tajik
6679	Tibetan	7365	Interlingua	7789	Burmese	8472	Thai
6682	Breton	7378	Indonesian	7865	Nauru	8473	Tigrinya
6765	Catalan	7383	Icelandic	7869	Nepali	8475	Turkmen
6779	Corsican	7384	Italian	7876	Dutch	8476	Tagalog
6783	Czech	7387	Hebrew	7879	Norwegian	8479	Tonga
6789	Welsh	7465	Japanese	7982	Oriya	8482	Turkish
6865	Danish	7473	Yiddish	8065	Panjabi	8484	Tatar
6869	German	7487	Javanese	8076	Polish	8487	Twi
6890	Bhutani	7565	Georgian	8083	Pashto, Puchto	8575	Ukrainian
6976	Greek	7575	Kazakh	8084	Portuguese	8582	Urdu
6978	English	7576	Greenlandic	8185	Quechua	8590	Uzbek
6979	Esperanto	7577	Cambodian	8277	Rhaeto-Romance	8673	Vietn/amese
6983	Spanish	7578	Kannada	8279	Romanian	8679	Volapük
6984	Estonian	7579	Korean	8285	Russian	8779	Wolof
6985	Basque	7583	Kashmiri	8365	Sanskrit	8872	Xhosa
7065	Persian	7585	Kurdish	8368	Sindhi	8979	Yoruba
7073	Finnish	7589	Kirghiz	8372	Serbo-Croatian	9072	Chinese
7074	Fiji	7665	Latin	8373	Singhalese	9085	Zulu

Player Mode

- Default setting: **DVD Audio**

Replay DVD Audio as DVD Video? (DVD replay method)

- **DVD Audio**
Should be selected when the player is to be used as a DVD audio player.
- **DVD Video**
Should be selected when the player is to be used as a DVD video player.

 Note

- Even when **DVD Video** has been selected, the selected setting will return to **DVD Audio** (i.e., to the default setting) when the disc table is opened or when the power is turned off.
- This setting can be set only in the stop mode.

Setting up the System Setup

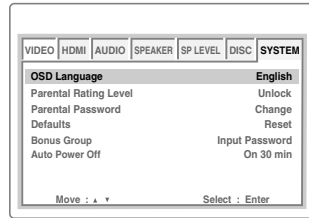

OSD Language

If you set the OSD Language in advance, it will come up automatically every time you watch a movie.

- Default setting: **English**

Parental Rating Level

The Parental Control function works in conjunction with DVDs that have been assigned a rating - which helps you control the types of DVDs that your family watches. There are up to 8 rating levels on a disc.

- Default setting: **Unlock**

- 1 **Select “Parental Rating Level” using the cursor buttons (▲/▼), then press the ENTER button.**
- 2 **Enter your password.**
- 3 **Use the ENTER button to select the desired “Parental Rating Level”.**

Note

- To change the parental control level, a correct password is needed to key in.
- If you have forgotten your password, press “2580”.

Parental Password

You can set a new password as follows:

- 1 **Use the cursor buttons (▲/▼) to select Parental Password.**
Press the **ENTER** button. The Change Password screen appears.
- 2 **Enter your old password.**
- 3 **Enter your new password. Re-enter the new password again.**
- 4 **Press the ENTER button.**

Note

- If you have forgotten your password, press “2580”.

Defaults

You can re-initialize the setting back to the factory defaults in the setup menu.

- 1 **Select “DEFAULTS” and press the ENTER button.**
- 2 **Enter your password using the numeric buttons.**
- 3 **Press the ENTER button.**

All the settings in the **SETUP** menu (except for Password) will be reset to the default settings.

- In case no picture is shown on the screen after resetting the unit, connect your TV via the **VIDEO** jack or **AV CONNECTOR** to display the Setup menu, and select the proper video output setting.

Bonus Group

Some DVD-Audio discs have an extra ‘bonus’ group that requires a 4-digit key number to access. See the disc packaging for details and the key number. When you try and play the bonus group, the key number input screen will automatically appear. Input the number.

Note

- If you eject the disc, switch the power off, or unplug the player, you will need to re-enter the key number.

Auto Power Off

- Default setting: **On 30 min**

If “On 30 min” is selected, the standby mode is automatically selected to save power if the player is left in the Stop mode for about 30 minutes.

Resetting the Player

Resetting the player returns all menu, picture and password settings to their factory defaults.

To reset the player, press and hold ■ (STOP) on the front panel until “RESET OK” is displayed on the display when pressing Power switch to turn the power on.

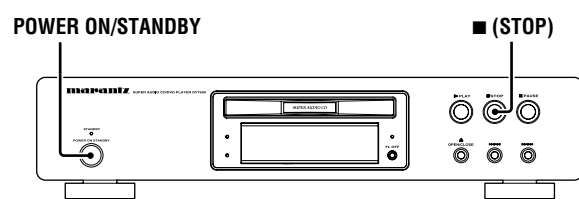

Note

- Static electricity or other external influences may cause malfunctioning of this unit. In this case, unplug the power cord and then plug back in. This will usually reset the unit for proper operation. If this does not correct the problem, please consult your nearest MARANTZ service center.
- If this operation is performed, all memories in which the **Program Memory (page 26)** and **Video Adjust's Memory (page 28)** have been entered are simultaneously erased. Be extremely careful before doing this operation.

Handling discs

When holding discs of any type, take care not to leave fingerprints, dirt or scratches on the disc surface. Hold the disc by its edge or by the center hole and edge.



Damaged or dirty discs can affect playback performance. Take care also not to scratch the label side of the disc. Although not as fragile as the recorded side, scratches can still result in a disc becoming unusable.

Should a disc become marked with fingerprints, dust, etc., clean using a soft, dry cloth, wiping the disc lightly from the center to the outside edge as shown in the diagram below.

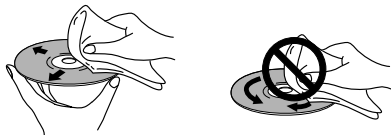

Wipe lightly from the center of the disc using straight strokes.

Don't wipe the disc surface using circular strokes.

If necessary, use a cloth soaked in alcohol, or a commercially available CD/DVD cleaning kit to clean a disc more thoroughly. Never use benzine, thinner or other cleaning agents, including products designed for cleaning vinyl records.

Storing discs

Although CDs and DVD discs are more durable than vinyl records, you should still take care to handle and store discs correctly. When you're not using a disc, return it to its case and store upright. Avoid leaving discs in excessively cold, humid, or hot environments (including under direct sunlight).

Don't glue paper or put stickers onto the disc, or use a pencil, ball-point pen or other sharp-tipped writing instrument. These could all damage the disc.



For more detailed care information see the instructions that come with discs.

Do not load more than one disc into the player.

Discs to avoid

Discs spin at high speed inside the player. If you can see that a disc is cracked, chipped, warped, or otherwise damaged, don't risk using it in your player—you could end up damaging the unit.

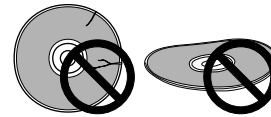

This unit is designed for use with conventional, fully circular discs only. Use of shaped discs is not recommended for this product.

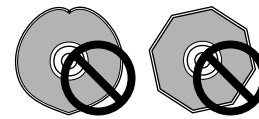

Cleaning the pickup lens

The DVD player's lens should not become dirty in normal use, but if for some reason it should malfunction due to dust or dirt, consult your nearest MARANTZ-authorized service center. Although lens cleaners for CD players are commercially available, we do not recommend using them since some may damage the lens.

Problems with condensation

Condensation may form inside the player if it is brought into a warm room from outside, or if the temperature of the room rises quickly. Although the condensation won't damage the player, it may temporarily impair its performance. For this reason you should leave it to adjust to the warmer temperature for about an hour before switching on and using.

Hints on installation

We want you to enjoy using this unit for years to come, so please bear in mind the following points when choosing a suitable location for it:

Do...

- ✓ Use in a well-ventilated room.
- ✓ Place on a solid, flat, level surface, such as a table, shelf or stereo rack.

Don't...

- ✗ Use in a place exposed to high temperatures or humidity, including near radiators and other heat-generating appliances.
- ✗ Place on a window sill or other place where the player will be exposed to direct sunlight.
- ✗ Use in an excessively dusty or damp environment.
- ✗ Place directly on top of an amplifier, or other component in your stereo system that becomes hot in use.
- ✗ Use near a television or monitor as you may experience interference—especially if the television uses an indoor antenna.
- ✗ Use in a kitchen or other room where the player may be exposed to smoke or steam.
- ✗ Use on a thick rug or carpet, or cover with cloth—this may prevent proper cooling of the unit.
- ✗ Place on an unstable surface, or one that is not large enough to support all four of the unit's feet.

Moving the player

If you need to move the player, first press **POWER ON/STANDBY** button on the front panel to turn the player off, then unplug the power cord. Never lift or move the unit during playback—discs rotate at a high speed and may be damaged.

Power cord caution

Handle the power cord by the plug part. Do not pull out the plug by tugging the cord, and never touch the power cord when your hands are wet, as this could cause a short circuit or electric shock. Do not place the unit, a piece of furniture, or other object on the power cord or pinch the cord in any other way. Never make a knot in the cord or tie it with other cords. The power cords should be routed so that they are not likely to be stepped on. A damaged power cord can cause a fire or give you an electric shock. Check the power cord once in a while. If you find it damaged, ask your nearest MARANTZ authorized service center or your dealer for a replacement.

Glossary

Analog audio

An electrical signal that directly represents sound. Compare this to digital audio which can be an electrical signal, but is an indirect representation of sound. See also *Digital audio*.

Aspect ratio

The width of a TV screen relative to its height. Conventional TVs are 4:3 (in other words, the screen is almost square); widescreen models are 16:9 (the screen is almost twice as wide as it is high).

Bonus Group (DVD-Audio only)

An 'extra' group on some DVD-Audio discs that requires a key number to access. See also *Group*.

Browsable pictures (DVD-Audio only)

A feature of some DVD-Audio discs in which the user can browse still pictures recorded on the disc as the audio is played. See also *Slideshow*.

Chapter (DVD-Video, DVD-RW)

Just as a book is split up into several chapters, a title on a DVD disc is usually divided into chapters. See also *Title*.

Digital audio

An indirect representation of sound by numbers. During recording, the sound is measured at discrete intervals (44,100 times a second for CD audio) by an analog-to-digital converter, generating a stream of numbers. On playback, a digital-to-analog converter generates an analog signal based on these numbers. See also *Sampling frequency* and *Analog audio*.

Dolby Digital

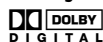

Using a maximum of 5.1 channels of audio, this high quality surround system is used in many of the finer movie theaters around the world.

DTS



DTS stands for Digital Theater System. DTS is a surround system different from *Dolby Digital* that has become a popular surround sound format for movies.

Dynamic range

The difference between the quietest and loudest sounds possible in an audio signal (without distorting or getting lost in noise). Dolby Digital and DTS soundtracks are capable of a very wide dynamic range, delivering dramatic cinema-like effects.

File extension

A tag added to the end of a filename to indicate the type of file. For example, ".mp3" indicates an MP3 file.

Group (DVD-Audio only)

A collection of tracks on a DVD-Audio disc. Equivalent to a DVD-Video title. See also *Title* and *Track*.

HDCP

HDCP is the acronym for High-bandwidth Digital Content Protection.

It is an encrypting method for DVI-use images and its purpose is the protection of image content against illegal copying. Receiving the encrypted signals requires a display with HDCP-compatible DVI input.

HDMI

HDMI (High-Definition Multimedia Interface) is an interface that expands DVI for next-generation digital audiovisual devices.

HDMI terminals can simultaneously transmit uncompressed digital images and the digital audio signals of Dolby Digital DTS, Linear PCM, etc.

Interlaced video

A method of displaying a picture in which odd-numbered lines are updated in one pass, then even-numbered lines updated in the next. See also *Progressive scan video*.

MP3

MP3 (MPEG1 audio layer 3) is a compressed audio file format. Files are recognized by their file extension ".mp3" or ".MP3".

MPEG audio

An audio format used on Video CDs and some DVD discs. This unit can convert MPEG audio to PCM format for wider compatibility with digital recorders and AV amplifiers. See also *PCM*.

MPEG video

The video format used for Video CDs and DVDs. Video CDs uses the older MPEG-1 standard, while DVD uses the newer and much better quality MPEG-2 standard.

Multi-session

A CD-R/RW that contains two or more 'sessions'. Each session is a complete recording process, so each session is read as a complete disc. This player can only read the first session on a disc.

Optical digital output

A jack that outputs digital audio in the form of light pulses. Connect components with optical digital jacks using a special optical cord, available from good audio dealers.

Packed PCM (DVD-Audio only)

A lossless compression system that enables more PCM audio to be stored on a DVD-Audio disc than would otherwise be possible.

PCM (Pulse Code Modulation)

The most common system of encoding digital audio, found on CDs and DAT. Excellent quality, but requires a lot of data compared to formats such as Dolby Digital and MPEG audio. For compatibility with digital audio recorders (CD, MD and DAT) and AV amplifiers with digital inputs, this unit can convert Dolby Digital, DTS and MPEG audio to PCM. See also *Digital audio*.

PBC (PlayBack Control) (Video CD only)

A system of navigating a Video CD through on-screen menus recorded onto the disc. Especially good for discs that you would normally not watch from beginning to end all at once—karaoke discs, for example.

Progressive scan video

Also called non-interlaced video, this method of displaying a picture updates all the lines in one pass, resulting in a more stable, flicker-free image than interlaced video (for a given scanning rate). See also *Interlaced video*.

Regions (DVD-Video only)

These associate discs and players with particular areas of the world. This unit will only play discs that have compatible region codes. You can find the region code of your unit by looking on the rear panel. Some discs are compatible with more than one region (or all regions).

Sampling frequency

The rate at which sound is measured to be turned into digital audio data. The higher the rate, the better the sound quality, but the more digital information is generated. Standard CD audio has a sampling frequency of 44.1 kHz, which means 44,100 samples (measurements) per second. See also *Digital audio*.

Slideshow (DVD, Video CD)

A feature of some DVD discs in which still pictures recorded on the disc cycle automatically as the audio is played. See also *Browsable pictures*.

Super Audio CDs

This is a high audio quality pure audio standard with more data recorded based on CD standards. There are three different types of super audio CD discs, single layer, dual layer and hybrid. Hybrid discs have the structure of both CD and super audio CD discs.

Title (DVD-Video only)

A collection of chapters on a DVD-Video disc. Equivalent to a DVD-Audio group. See also *Chapter* and *Group*.

Track

Audio CDs, Video CDs and DVD-Audio discs all use tracks to divide up the content of a disc. The DVD-Video equivalent is called a chapter. See also *Chapter* and *Group*.

Troubleshooting

Incorrect operation is often mistaken for trouble or malfunction. If you think that there is something wrong with this unit, check the points below. Sometimes the trouble may lie in another component. Inspect the other components and electrical appliances being used. If the trouble cannot be rectified after checking the items below, ask your nearest MARANTZ authorized service center or your dealer to carry out repair work.

The disc is ejected automatically after loading.

- Dirty or damaged disc.
See **page 48** for disc care information.
- Disc not seated properly in the disc guide.
Align the disc properly.
- Incompatible region number.
If the region number on a DVD-Video disc does not match the number on the player, the disc cannot be used (**page 9**).
- Condensation inside the player.
Allow time for condensation to evaporate. Avoid using the player near an air-conditioning unit.

Playback is not possible.

- Disc is loaded upside down.
Reload the disc with the label side face-up.

Cannot play DVD-RW disc.

- DVD-RW disc with DVD-Video format only can be played.

DVD-Audio playback stops.

- The disc may have been illegally copied.

⊘ mark appears on screen.

- The operation is prohibited by the player.
- The selected function does not operate for that disc.

Picture playback stops and the operation buttons cannot be used.

- Press ■ (**STOP**), then start playback again ► (**PLAY**).
- Switch the power off once using the front panel **POWER ON/STANDBY** and then switch on again using the front panel **POWER ON/STANDBY**.

New settings made in the Setup screen menus while a disc is playing are ineffective.

- Some settings can be changed while a disc is playing, but are not effective until the disc is stopped then restarted. This is not a malfunction.
Make the same setting when the player is stopped.
Press ■ (**STOP**), then restart playback ► (**PLAY**).
Note that making settings in the Setup screen menus may cancel the **RESUME** function.

Settings are canceled.

- When the power is cut due to power failure or by unplugging the power cord, settings will be canceled.
Before unplugging the power cord, press the **POWER** button on the remote control and check that **STANDBY** indicator on the front panel is lit.

No picture/No color.

- Incorrect video connections.
Check that connections are correct and that plugs are inserted fully.
- TV/monitor or AV amplifier settings are incorrect.
Check the instruction manual of the connected equipment.
- The **Components Out** menu is set to **Progressive** but your TV/monitor is not compatible with progressive scan.
Reconnect the player to your TV using a composite or S-Video cord and set the TV to the appropriate input. Now choose the Interlace setting in the **Components Out** menu, then switch the TV input back to the component input. (**page 36**)
- Check the **VIDEO ON/OFF** button on the remote control (**page 15**).

Screen is stretched or aspect does not change.

- The **TV Aspect** setting in the Setup menu is incorrect.
Set the **TV Aspect** option to match the TV/monitor you're using (**page 33**).

Picture disturbance during playback or dark.

- This player is compatible with Macro-Vision System copy guard. Some discs include a copy prevention signal, and when this type of disc is played back, stripes etc., may appear on some sections of the picture depending on the TV. This is not a malfunction.
- Discs respond differently to particular player functions. This may result in the screen becoming black for a brief instant or shaking slightly when the function is executed.

These problems are largely due to differences between discs and disc content and are not malfunctions of this player.
- When using progressive-scan

If your TV is connected using the **COMPONENT VIDEO OUT** jacks, set the **Components Out** menu to **Interlace** (page 36).

When recorded on a VCR or passed through an AV selector, there is disturbance in the playback picture.

- Due to the player's copy protection circuits, connection of this device through a VCR or an AV selector may prevent recording or cause picture problems. This is not a malfunction.

The remote control doesn't seem to work.

- The remote control is too far from the player, or the angle with the remote sensor is too wide.

Use the remote control within its operating range (page 7).
- The batteries are exhausted.

Put in new batteries (page 7).

Cannot listen to high-sampling rate audio through the digital output.

- **Linear PCM Out** is set to **PCM Down Sample On**. Set to **Off**.
- As a copy-protection measure, some DVDs do not output 96kHz audio.

In this case, even if **Off** is selected, the player automatically outputs the audio at 48kHz. This is not a malfunction.

No audio, or audio is distorted.

- Some DVD discs do not output digital audio.

Switch your amplifier to the player's analog outputs.
- Dirt, dust, etc. on the disc.

Clean the disc (page 48).
- Interconnects are not fully inserted into the terminals (or are not connected).

Check that all interconnects are firmly inserted.
- Dirty or oxidized plugs/terminals.

Clean the plugs/terminals.
- Incorrect audio cable connection.

Check the audio connections (pages 10–12).
- Player's output is connected to the amplifier's phono (turntable) inputs.

Connect to any set of inputs *except* phono.
- The disc is paused.

Press ► (**PLAY**) to exit the pause mode.
- Incorrect amplifier settings.

Check that the volume is turned up, that the speakers are on, the input function set correctly, etc.
- The **Audio Out** setting is incorrect.

If there is no dialog from the front L/R speakers, set **Audio Out** to **2 Channel**. If there is no output from the rear, center and subwoofer speakers, set **Audio Out** to **5.1 Channel** (pages 41–42).
- The player is set to 5.1ch playback, but sound is only 2ch.

Check that 2ch playback is not selected in the disc's menu.

The analog audio is OK, but there appears to be no digital audio signal.

- Incorrect **Audio Setup** menu settings.

Make sure that the **Digital Out** setting is set to **Bitstream/PCM** (page 39).

Noticeable difference in DVD and CD volume.

- DVDs and CDs use different recording methods. This is not a malfunction.

Cannot play multi-channel audio.

- Make sure that **5.1 Channel** is selected in the **Audio Out** menu (pages 41-42).
- Check that the settings in the **Speaker Setting** screen are correct (page 43).
- Check the audio options available from the disc's menu.

No digital audio output.

- Check that **Digital Out** setting is set to **Bitstream/PCM** (page 39).
- Some DVD-Audio discs prohibit digital audio output.
- No digital audio is output when playing Super Audio CDs.

Cannot output 192kHz or 176.4kHz digital audio.

- The player does not output digital audio at these sampling rates.
- Only 48/44.1 kHz output is available when HDMI is connected.

Cannot output 96kHz or 88.2kHz digital audio.

- Check that the **PCM Down Sample** setting is not set to **On** (page 40).
- Some discs are digital copy protected and do not output high sampling rate digital audio.
- Only 48/44.1 kHz output is available when HDMI is connected.

No DTS audio output.

- If this unit is connected to a non-DTS compatible amplifier or decoder using a digital audio cable, set **Digital Out** to **PCM** in the Setup menu. If you do not do this, noise will be output if you try and play a DTS disc.
- If this unit is connected to a DTS-compatible amplifier or decoder using a digital audio cable, check the amplifier settings, and that the cable is properly connected.
- If a TV or projector compatible with PCN only is connected when HDMI is connected, DTS will not be available.

Audio mix does not sound right or sounds incomplete (for example, inaudible dialog).

- Incorrect Setup menu settings.
 - Make sure that **2 Channel** output is selected for the **Audio Out** menu option if you've connected to the stereo inputs on your amplifier or TV (pages 41-42).
- If the power is switched off before exiting the Setup menu, the settings are not stored.
 - Make sure that you exit the Setup menu after changing any settings before switching off.

The disc containing the MP3 tracks won't play.

- If the disc is a recordable CD, make sure that the disc is finalized.
 - Check that the track(s) are in the MPEG1 Audio Layer 3 format.
 - Check that the sampling rate of the track(s) are 44.1 or 48kHz.

Some MP3 tracks appear to be missing from a disc.

- If a track name does not end in ".mp3" or ".MP3", this player will not recognize it as an MP3 track.
- This player only recognizes about 250 files on a disc. If there are more titles than this, you will not be able to play them.
- This player is not compatible with multi-session discs. If the disc is multi-session, you will only be able to play tracks recorded onto the first session.

Specifications

General

System
 DVD-Video, DVD-Audio, DVD-R/RW, Video CD, Super Audio CD, CD, MP3 files and JPEG files

Power requirements
 USA AC120 V, 60Hz/Europe AC230 V, 50/60Hz

Power consumption USA 28 W/Europe 29 W

Weight 4.6 kg (10 lb 2 oz)

Dimensions 440 (W) x 96.3 (H) x 305.5 (D) mm
 (17.3 (W) x 3.8 (H) x 12 (D) in.)

Operating temperature +5°C to +35°C (+41°F to +96°F)

Operating humidity 5% to 85% (no condensation)

S-Video output

Y (luminance) - Output level 1 Vp-p (75 Ω)

C (color) - Output level 286 mVp-p (75 Ω)

Jacks S-VIDEO jack

Video output (2 individual outputs)

Output level 1 Vp-p (75 Ω)

Jacks RCA jack

Component video output (Y, C_B/P_B, C_R/P_R)

Output level Y: 1.0 Vp-p (75 Ω)
 C_B/P_B, C_R/P_R: 0.7 Vp-p (75 Ω)

Jacks RCA jacks

HDMI output

Output Terminal 19-pin

21-pin connector assignment (Europe model only)

AV connector output 21-pin connector

This connector provides the video and audio signals for connection to a compatible color TV or monitor.

20 18 16 14 12 10 8 6 4 2

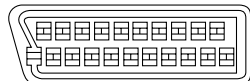

21 19 17 15 13 11 9 7 5 3 1

PIN no.

1	Audio 2/R out	11	G out
3	Audio 1/L out	15	R or C out
4	GND	17	GND
7	B out	19	Video out or Y out
8	Status	21	GND

Audio output

Output level
 During audio output 2 Vrms (1 kHz, 0 dB)

Number of channels 2

Jacks RCA jack

Audio output (multi-channel / L, R, C, SW, LS, RS)

Output level
 During audio output 2 Vrms (1 kHz, 0 dB)

Number of channels 6

Jacks RCA jack

Audio characteristics

Frequency response 4Hz to 44kHz (DVD fs: 96kHz)
 4Hz to 88kHz (DVD-Audio fs: 192kHz)

S/N ratio 125 dB

Dynamic range 110 dB

Total harmonic distortion 0.0012 %

Wow and flutter: Limit of measurement (±0.001% W. PEAK)
 or lower

Digital output

Optical digital output Optical digital jack

Coaxial digital output RCA jack

Other terminals

Control in/out RCA jacks

RS232C 1

Accessories

Remote control 1

AAA/AR03 dry cell batteries 2

Audio/Video cable (yellow/red/white) 1

System control cable 1

Power cable 1

User Guide (this manual) 1

Warranty card

Note: The specifications and design of this product are subject to change without notice, due to improvement.

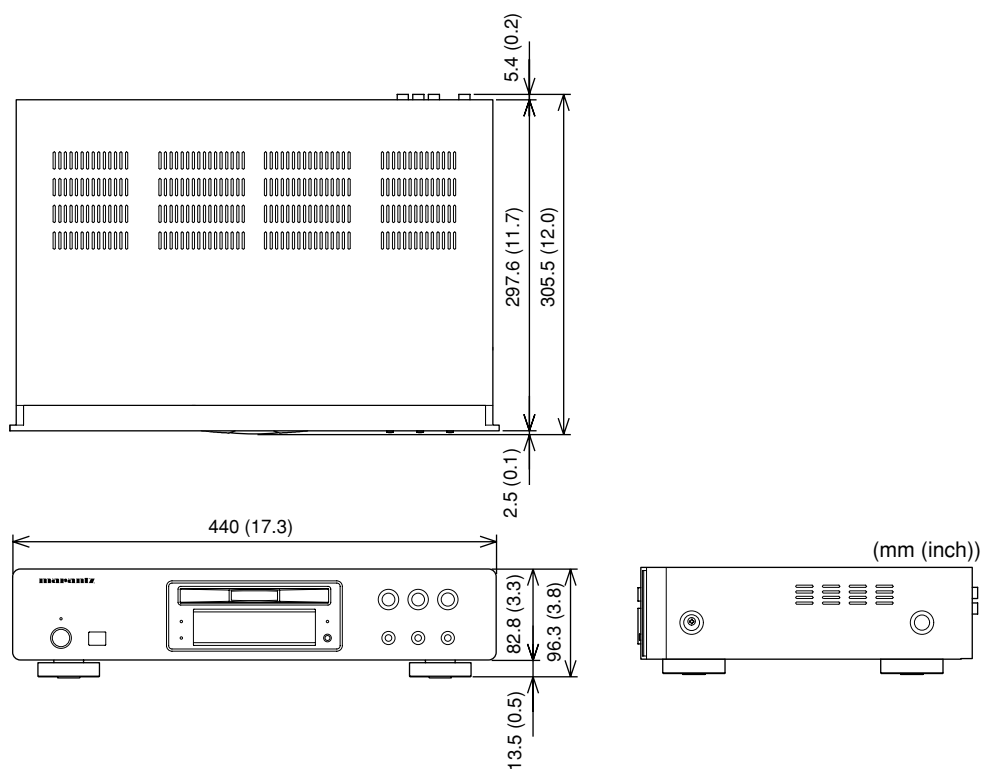

www.marantz.com

You can find your nearest authorized distributor or dealer on our website.

U.S.A. Marantz America, Inc. 1100 Maplewood Drive, Itasca, IL 60143, U.S.A.

EUROPE Marantz Europe B.V. P.O. Box 8744, 5605 LS Eindhoven, The Netherlands

marantz[®] is a registered trademark.



Printed in China

2005/05 PMC 00M25BW851250

Free Manuals Download Website

<http://myh66.com>

<http://usermanuals.us>

<http://www.somanuals.com>

<http://www.4manuals.cc>

<http://www.manual-lib.com>

<http://www.404manual.com>

<http://www.luxmanual.com>

<http://aubethermostatmanual.com>

Golf course search by state

<http://golfingnear.com>

Email search by domain

<http://emailbydomain.com>

Auto manuals search

<http://auto.somanuals.com>

TV manuals search

<http://tv.somanuals.com>