

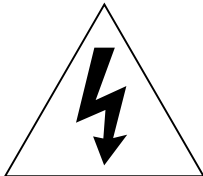

marantz®

Model SC-7S2 User Guide

Stereo Control Amplifier

	CAUTION RISK OF ELECTRIC SHOCK DO NOT OPEN	
CAUTION: TO REDUCE THE RISK OF ELECTRIC SHOCK, DO NOT REMOVE COVER (OR BACK) NO USER-SERVICEABLE PARTS INSIDE REFER SERVICING TO QUALIFIED SERVICE PERSONNEL		

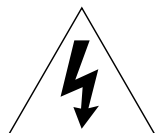

The lightning flash with arrowhead symbol within an equilateral triangle is intended to alert the user to the presence of uninsulated "dangerous voltage" within the product's enclosure that may be of sufficient magnitude to constitute a risk of electric shock to persons.



The exclamation point within an equilateral triangle is intended to alert the user to the presence of important operating and maintenance (servicing) instructions in the literature accompanying the product.

WARNING

**TO REDUCE THE RISK OF FIRE OR ELECTRIC SHOCK,
DO NOT EXPOSE THIS APPLIANCE TO RAIN OR MOISTURE.**

**CAUTION: TO PREVENT ELECTRIC SHOCK, MATCH WIDE
BLADE OF PLUG TO WIDE SLOT, FULLY INSERT.**

**ATTENTION: POUR EVITER LES CHOCS ELECTRIQUES,
INTRODUIRE LA LAME LA PLUS LARGE DE LA FICHE DANS
LA BORNE CORRESPONDANTE DE LA PRISE ET
POUSSER JUSQU'AU FOND.**

IMPORTANT SAFETY INSTRUCTIONS

READ BEFORE OPERATING EQUIPMENT

This product was designed and manufactured to meet strict quality and safety standards. There are, however, some installation and operation precautions which you should be particularly aware of.

1. Read these instructions.
2. Keep these instructions.
3. Heed all warnings.
4. Follow all instructions.
5. Do not use this apparatus near water.
6. Clean only with dry cloth.
7. Do not block any ventilation openings. Install in accordance with the manufacture's instructions.
8. Do not install near any heat sources such as radiators, heat registers, stoves, or other apparatus (including amplifiers) that produce heat.
9. Do not defeat the safety purpose of the polarized or grounding-type plug. A polarized plug has two blades with one wider than the other. A grounding type plug has two blades and a third grounding prong. The wide blade or the third prong are provided for your safety. If the provided plug does not fit into your outlet, consult an electrician for replacement of the obsolete outlet.



10. Protect the power cord from being walked on or pinched particularly at plugs, convenience receptacles, and the point where they exit from the apparatus.
11. Only use attachments/accessories specified by the manufacturer.
12. Use only with the cart, stand, tripod, bracket, or table specified by the manufacturer, or sold with the apparatus. When a cart is used, use caution when moving the cart/apparatus combination to avoid injury from tip-over.
13. Unplug this apparatus during lightning storms or when unused for long periods of time.
14. Refer all servicing to qualified service personnel. Servicing is required when the apparatus has been damaged in any way, such as power-supply cord or plug is damaged, liquid has been spilled or objects have fallen into the apparatus, the apparatus has been exposed to rain or moisture, does not operate normally, or has been dropped.

Additional Safety Information!

- This product should not be placed in a built-in installation such as a bookcase or rack unless proper ventilation is provided or the manufacturer's instructions have been adhered to.
- Apparatus shall not be exposed to dripping or splashing and that no objects filled with liquids, such as vases, shall be placed on the apparatus.
- When the switch is in the OFF position, the apparatus isn't completely switched-off from the MAINS.
- The equipment shall be installed near the Socket-Outlet and shall be easily accessible.

ENGLISH

WARRANTY

For warranty information, contact your local Marantz distributor.

RETAIN YOUR PURCHASE RECEIPT

Your purchase receipt is your permanent record of a valuable purchase. It should be kept in a safe place to be referred to as necessary for insurance purposes or when corresponding with Marantz.

IMPORTANT

When seeking warranty service, it is the responsibility of the consumer to establish proof and date of purchase. Your purchase receipt or invoice is adequate for such proof.

FOR U.K. ONLY

This undertaking is in addition to a consumer's statutory rights and does not affect those rights in any way.

FRANÇAIS

GARANTIE

Pour des informations sur la garantie, contacter le distributeur local Marantz.

CONSERVER L'ATTESTATION D'ACHAT

L'attestation d'achat est la preuve permanente d'un achat de valeur. La conserver en lieu sûr pour s'y reporter aux fins d'obtention d'une couverture d'assurance ou dans le cadre de correspondances avec Marantz.

IMPORTANT

Pour l'obtention d'un service couvert par la garantie, il incombe au client d'établir la preuve de l'achat et d'en corroborer la date. Le reçu ou la facture constituent des preuves suffisantes.

DEUTSCH

GARANTIE

Bei Garantiefragen wenden Sie sich bitte an Ihren Marantz-Händler.

HEBEN SIE IHRE QUITTING GUT AUF

Die Quittung dient Ihnen als bleibende Unterlage für Ihren wertvollen Einkauf. Das Aufbewahren der Quittung ist wichtig, da die darin enthaltenen Angaben für Versicherungszwecke oder bei Korrespondenz mit Marantz angeführt werden müssen.

WICHTIG!

Bei Garantiefragen muß der Kunde eine Kaufunterlage mit Kaufdatum vorlegen. Ihre Quittung oder Rechnung ist als Unterlage ausreichend.

CE MARKING



English

The SC7S2/N1G is in conformity with the EMC directive and low-voltage directive.



Français

Le SC7S2/N1G est conforme à la directive EMC et à la directive sur les basses tensions.



Deutsch

Das Modell SC7S2/N1G entspricht den EMC-Richtlinien und den Richtlinien für Niederspannungsgeräte.

English

WARNINGS

- Do not expose the equipment to rain or moisture.
- Do not remove the cover from the equipment.
- Do not insert anything into the equipment through the ventilation holes.
- Do not handle the mains cord with wet hands.
- Do not cover the ventilation with any items such as tablecloths, newspapers, curtains, etc.
- No naked flame sources, such as lighted candles, should be placed on the equipment.
- When disposing of used batteries, please comply with governmental regulations or environmental public instruction's rules that apply in your country or area.
- Make a space of about 0.2 meter around the unit.
- No objects filled with liquids, such as vases, shall be placed on the equipment.
- When the switch is in the OFF position, the equipment is not completely switched off from MAINS.
- The equipment shall be installed near the power supply so that the power supply is easily accessible.

Français

AVERTISSEMENTS

- Ne pas exposer l'appareil à la pluie ni à l'humidité.
- Ne pas essayer de retirer le boîtier de l'appareil.
- Ne rien insérer dans l'appareil par les orifices de ventilation.
- Ne pas manipuler le cordon d'alimentation avec les mains mouillées.
- Ne pas recouvrir les ouïes de ventilation avec un objet quelconque comme une nappe, un journal, un rideau, etc.
- Ne placer aucune source de flamme nue, comme une bougie allumée, sur l'appareil.
- Pour mettre au rebut les piles usées, respecter les lois gouvernementales ou les règlements officiels concernant l'environnement qui s'appliquent à votre pays ou région.

- Veiller à ce qu'aucun objet ne soit à moins de 0,2 mètre des côtés de l'appareil.
- Aucun objet rempli de liquide, un vase par exemple, ne doit être placé sur l'appareil.
- Lorsque l'interrupteur est sur la position OFF, l'appareil n'est pas complètement déconnecté du SECTEUR (MAINS).
- L'appareil sera installé près de la source d'alimentation, de sorte que cette dernière soit facilement accessible.

Deutsch

WARNHINWEISE

- Das Gerät nicht Regen oder Feuchtigkeit aussetzen.
- Die Abdeckung nicht vom Gerät abnehmen.
- Keine Gegenstände durch die Belüftungsschlitze stecken.
- Das Netzkabel nicht mit feuchten oder nassen Händen anfassen.
- Decken Sie die Lüftungsöffnungen nicht mit einem Tischtuch, einer Zeitung, einem Vorhang usw. ab.
- Es dürfen keine Gegenstände mit offener Flamme, wie etwa brennende Kerzen, auf dem Gerät aufgestellt werden.
- Beachten Sie bei der Entsorgung der verbrauchten Batterien alle geltenden lokalen und überregionalen Regelungen.
- Auf allen Geräteseiten muß ein Zwischenraum von ungefähr 0,2 meter vorhanden sein.
- Auf das Gerät dürfen keine mit Flüssigkeiten gefüllte Behälter, wie etwa eine Vase, gestellt werden.
- Wenn der Schalter ausgeschaltet ist (OFF-Position), ist das Gerät nicht vollständig vom Stromnetz (MAINS) abgetrennt.
- Das Gerät sollte in der Nähe einer Netzsteckdose aufgestellt werden, damit es leicht an das Stromnetz angeschlossen werden kann.

TABLE OF CONTENTS

INSTRUCTION FOR USE 2

 FOREWORD 2

 EQUIPMENT MAINS WORKING SETTING 2

 COPYRIGHT 2

 PRECAUTIONS 2

 HOW TO USE BATTERY 2

ACCESSARIES 2

MAIN FEATURE OF PRODUCT 3

CONNECTIONS 4

 BALANCED TERMINAL 5

 BI-AMP (CONNECTION) 7

 COMPLETE BI-AMP CONNECTION 9

 INSTALLING THE SUPER AUDIO CD MULTI-CHANNEL AUDIO SPEAKERS 10

 (ITU) INTERNATIONAL TELECOMMUNICATION UNION 10

NAME AND FUNCTION 12

 FRONT PANEL 12

 DISPLAY SECTION 12

 REAR PANEL 13

 REMOTE CONTROLLER 14

STANDARD OPERATION 16

 HOW TO PLAY 16

 HOW TO RECORD 16

HOW TO OPERATE FUNCTION AND HOW TO SET UP 17

 ATTENUATE FUNCTION 17

 HOW TO SET UP THE ATTENUATION LEVEL 17

 TRIM ADJUSTMENT FUNCTION 18

SPECIFICATION 20

 SPECIFICATION 20

 DIMENSIONS 20

BLOCK DIAGRAM 20

TROUBLE SHOOTING 21

 ABOUT ERROR CODES 21

MAINTENANCE 21

A NOTE ABOUT RECYCLING



This product's packaging materials are recyclable and can be reused. This product and the accessories packed together are the applicable product to the WEEE directive except batteries.

Please dispose of any materials in accordance with your local recycling regulations. When discarding the unit, comply with your local rules or regulations. Batteries should never be thrown away or incinerated but disposed of in accordance with your local regulations concerning chemical wastes.

INSTRUCTION FOR USE

FOREWORD

This section must be read before any connection is made to the mains supply.

EQUIPMENT MAINS WORKING SETTING

Your Marantz product has been prepared to comply with the household power and safety requirements that exist in your area.

“SC-7S2/N1G” version product can be powered by 230 V AC only.

“SC-7S2/U1G” version product can be powered by 120 V AC only.

COPYRIGHT

Recording and playback of any material may require consent. For further information refer to the following:

- Copyright Act 1956
- Dramatic and Musical Performers Act 1958
- Performers Protection Acts 1963 and 1972
- any subsequent statutory enactments and orders

PRECAUTIONS

The following precautions should be taken when operating the equipment.

■ General Precautions

When siting the equipment ensure that:

- the ventilation holes are not covered;
- air is allowed to circulate freely around the equipment
- it is on a vibration free-surface;
- it will not be exposed to interference from an external source;
- it will not be exposed to excessive heat, cold, moisture or dust;
- it will not be exposed to direct sunlight;
- it will not be exposed to electrostatic discharges

Never place heavy objects on the equipment.

If a foreign body or water does enter the equipment, contact your nearest dealer or service centre.

Do not pull out the plug by pulling on the mains lead, hold the plug.

It is advisable when leaving the house, or during a thunderstorm, to disconnect the equipment from the mains supply.

HOW TO USE BATTERY

Improper use of batteries may cause the risk of fluid leakage or explosion.

Be specially careful in the following points.

- ① Insert the batteries with the correct and polarity as indicated inside the battery case.
- ② Do not use a brand-new battery and used battery together.
- ③ Dry cell batteries may produce different voltages even when their shapes are the same. Do not use different types of batteries together.
- ④ Some batteries are rechargeable and some are not. Be sure to read the caution and instructions described on each battery.
- ⑤ Used batteries should be disposed of in compliance with the treatment method specified for your local area.

ACCESSORIES

After opening the cover of the packing box, check that the following accessories are included.

- AC Power Cable

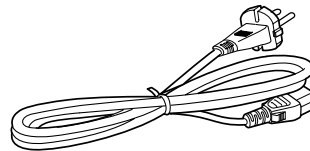

(Model SC-7S2/N1G)

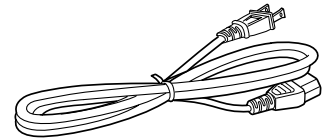

(Model SC-7S2/U1G)

- Remote Controller

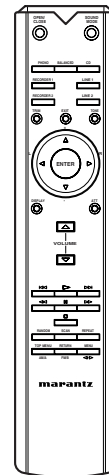

- AAA (R03) Batteries

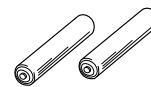

- Remote Cable



- Instruction Manual (this Copy)

MAIN FEATURE OF PRODUCT

■ The concept: channel separation for super wide range & dynamic audio

We think it's of the utmost importance to extend high frequency response as well as channel separation so you can hear the true meaning of "Super Audio."

This is why we have designed the input and output circuitry, volume control section, and power supply circuits according to this philosophy.

The result: an astonishing channel separation of over 100dB at 20kHz.

■ Fully balanced control amp with an linear volume control

The SC-7S2 is a full balanced, two-channel control amp providing the channel separation you need for Super Audio. Based on our own high quality four-gang active volume control we have developed an even better linear control volume that reduces gang errors from 0 to 100dB, ± 0.5 dB. By adding an additional HDAM SA (Hyper Dynamic Amplifier Module), we improved the Common Mode Reject Ratio (CMRR) dramatically, attaining an incredible ultra-wide frequency band of 150kHz and succeeded in producing the perfect control amplifier for Super Audio CD.

■ HDAM SA

The feedback impedance of the Current Feedback circuit was reduced to its minimum to make it faster. We developed a new Hyper Dynamic Amplifier Modules (HDAM), a separated module operating as a buffer for the amplifier. The SC-7S2 has four HDAM SA on each input-output buffer and another four units on the V/I converter.

■ Choke input system

In the power supply section, the choke input topology was adopted to drastically reduce rectifier harmonic noise. This system is especially suitable for a control amplifier in which very small signal amplification occurs.

■ Floating control bus system

We make it possible to synchronously drive two or more control amps by using a floating control bus system connected to as many as 6 sets of control amplifiers. We also enable you to trim levels using the remote control, making it easy to set up the optimal sound field on a multi-channel configuration. The highest achievable stereo performance can be accomplished when a system configured with two sets of SC-7S2 and four sets of MA-9S2 are connected in a bi-amped mode. You will experience superb sound with unbelievable channel separation.

CONNECTIONS

Connection 1 Stereo connection

➡ : Signal flow

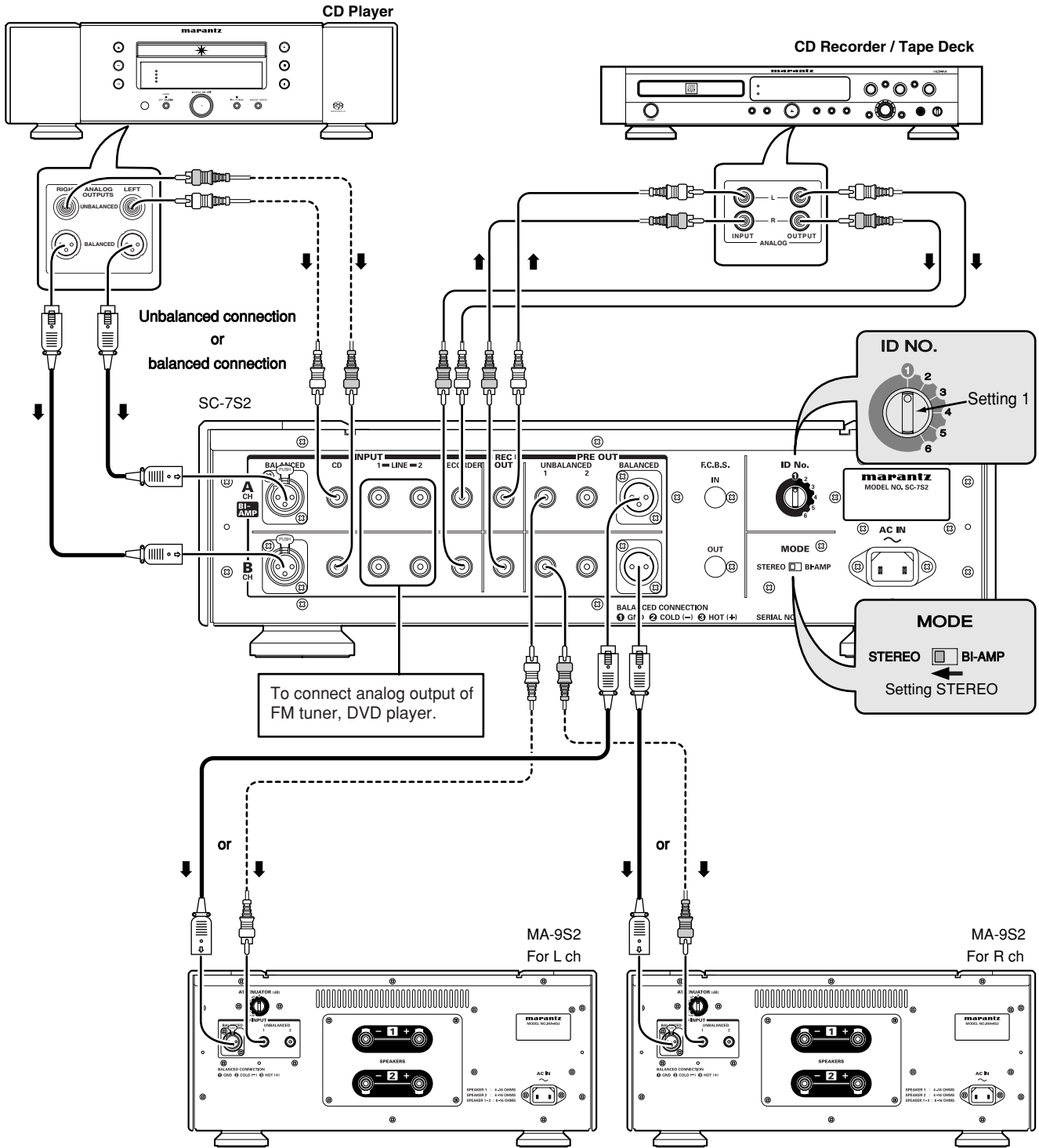

This connection can have options i.e. You may connect the units using either balanced or unbalanced cables to connect your CD and control Amp, as well as the SC-7S2 with MA-9S2s. But you can not inter match.

CONNECTIONS

**Connection 1–4 are recommended by Marantz for SC-7S2 with Marantz MA-9S2.
If using the MA-9S2s, Please read the instruction manual for the MA-9S2.
Name and Function → P13**

Standard set-up in using Marantz Monaural Power Amp MA-9S2.

Please refer to this connection in event of using other Power Amps also.

- SC-7S2 doesn't have Phono equalizer. So in the event of using a turn table, please use a Phono equalizer to connect with the SC-7S2.
- In event that stereo L ch signal has been wired with A ch input, the signal will come out of the pre-out of A ch. Please pay attention to L ch, R ch if SC-7S2 is connected with the other equipment.

BALANCED TERMINAL

- ① The balanced output connector uses a XLR connector.
- ② The XLR connector is internally wired in either of the following two systems.
 1. USA system (Pin 2 = COLD, Pin 3 = HOT)

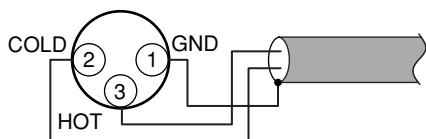

2. European system (Pin 2 = HOT, Pin 3 = COLD)

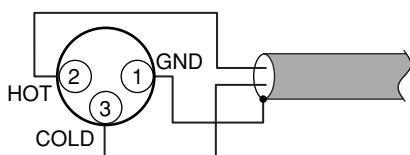

- ③ The SC-7S2 uses the USA system of 1.

When a preamp or main amplifier adopting the European system is connected using a cable with XLR balanced connectors, the reproduced signal may be inverted of phase.

In this case, correct the wiring of the one of the XLR connectors on the extremities of the cable to the USA system by exchanging the connections of pins 2 and 3. This will make it possible to play the signal with the correct phase.

CONNECTIONS

Connection 2 Bi-Amp connection (Make sure your speakers are designed for Bi-Amp capabilities)

➡: Signal flow

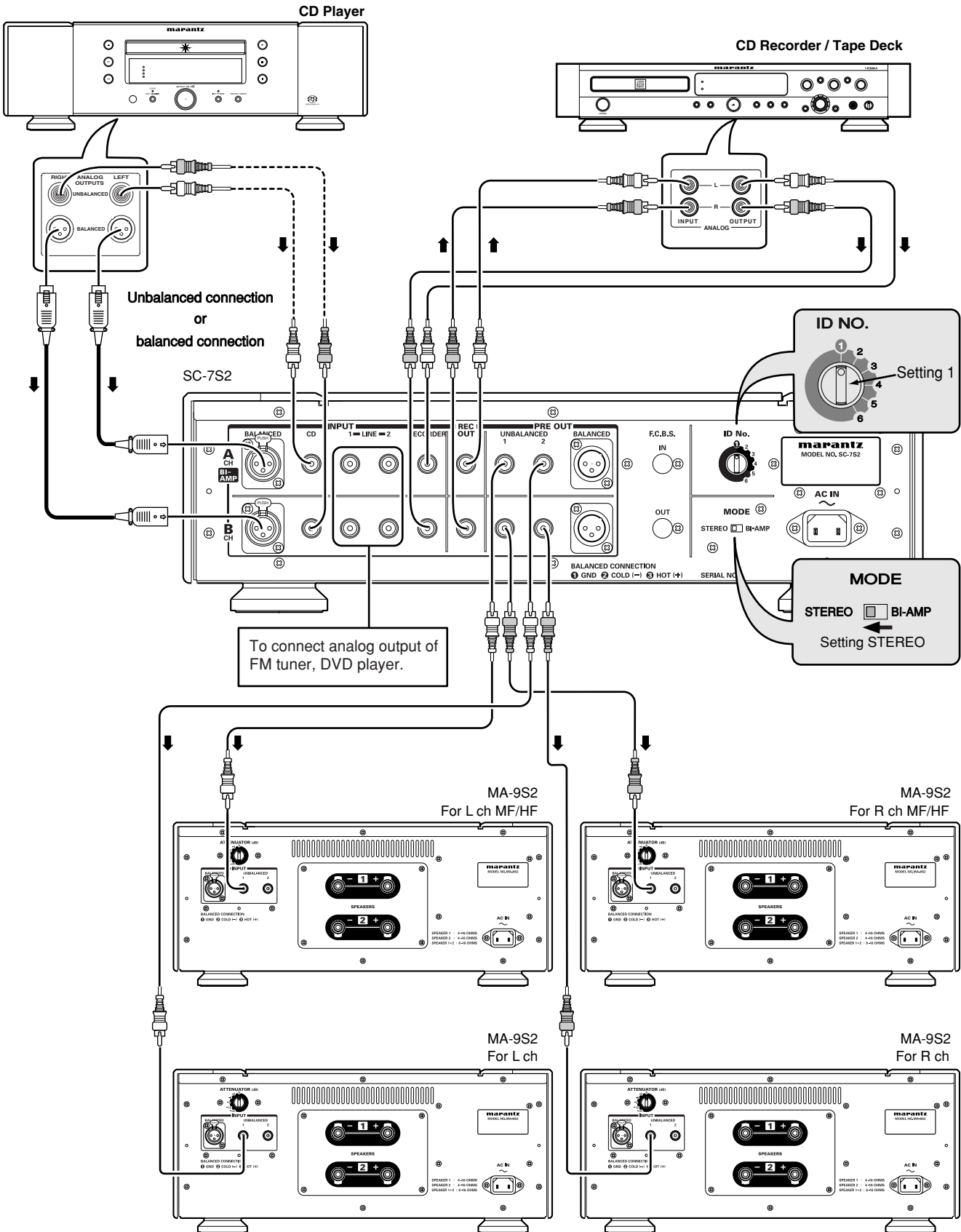

CONNECTIONS

This connection can have options i.e. You may connect the units using either balanced or unbalanced cables to connect your CD player and control Amp. But you can not inter match. Please select either way of connection.

Enhance the connection 1 to Bi-Amp connection, and drive the Bass speaker and Mid/High speakers with separate power Amplifiers.

BI-AMP (CONNECTION)

The benefits of Bi-Wiring; drive the Bass speaker and Mid/High speakers with separate power Amplifiers. Bi-Amping will lessen the burden of Power Amp impedance, so that back electromotive force between the Low and Mid/High signal can be lessened. We can expect drastic improvement of sound quality.

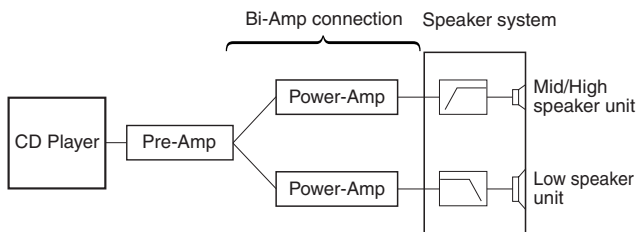

Caution

If the Mode switch on the S C-7S2 is set to stereo, then the unbalanced connections must be used.

CONNECTIONS

Connection 3 Complete Bi-Amp connection (Make sure your speakers are designed for Bi-Amp capabilities)

➔ : Signal flow

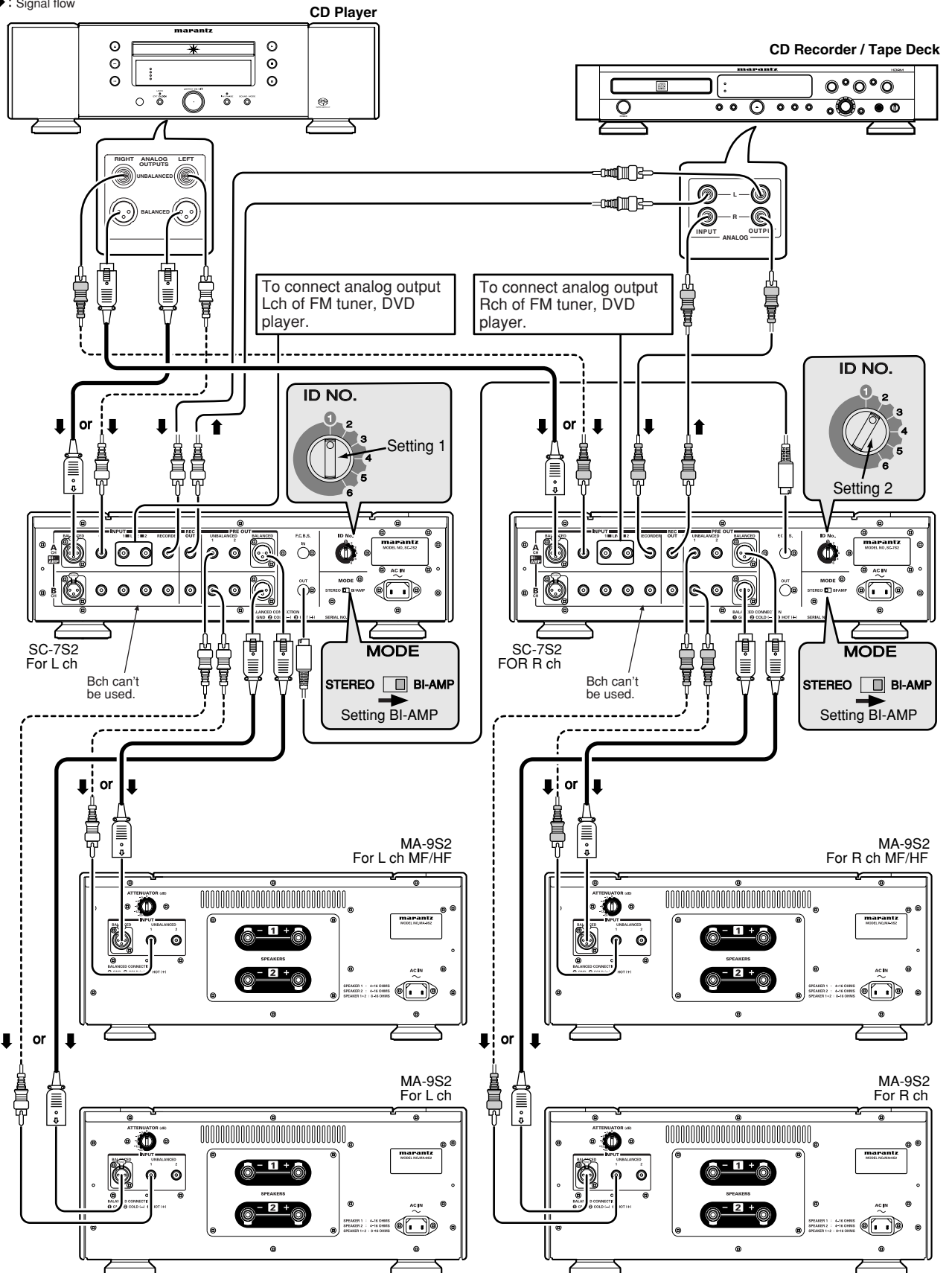

CONNECTIONS

This connection can have options i.e. You may connect the units using either balanced or unbalanced cables to connect your CD player and control Amp. But you can not inter match. Your Control Amp & Power Amp can also be wired the same way. Please select either way of connection.

COMPLETE BI-AMP CONNECTION

Enhance connection 2, by having one more control Amp. SC-7S2, this is a wiring which separates Mid/High signal and Low signal from the Pre-Amp section. In this event, the SC-7S2 is used as Monaural Pre-Amps. And separate Left/Right channels from the output terminal of CD player. As a result, influences between L channel and R channel Mid/High signal and Low signal will be eliminated.

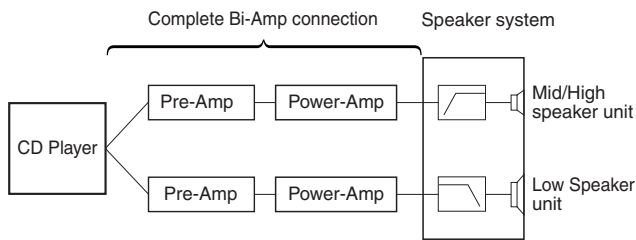

By connection with the remote cable, a maximum of 6 SC-7S2s can be operated together.

Caution

In the event of setting mode switch as <Bi-Amp>, B channel input can't be used.

CONNECTIONS

INSTALLING THE SUPER AUDIO CD MULTI-CHANNEL AUDIO SPEAKERS

In order to enjoy Super Audio CD multi-channel sound with the best possible acoustics, it is recommended that the speaker systems be laid out in compliance with the ITU-R BS.775-1 recommendation which is a standard formulated by the International Telecommunication Union (ITU).

Super Audio CD multi-channel discs are recorded and mixed in such a way that they will achieve the optimum effects when the speaker systems are laid out as per the ITU-R BS.775-1 recommendation.

- On Super Audio CD multi-channel discs, the music signals are basically recorded using 5 channels (or 3, 4 or 6 channels in some cases). In some instances, however, LFE (for the sub woofer) is recorded as a sixth channel. Each disc indicates how many channels have been recorded on it.
- The basic settings are 3 speakers for front and 2 for back since multi-channel discs have basically 5 channels. The 2-front, 1-center, and 2-surround speakers should be set on the circle from the listening point as shown below. When you use different sizes of speakers, please adjust the volume balances.
- The location of the sub-woofer in the picture is just to you a patter of settings. Sub-woofer can be located any place in your room. (See the users manual of your sub-woofer.)

(ITU) INTERNATIONAL TELECOMMUNICATION UNION

The ITU is a special organization of the United Nations. It consists of a number of organs, one of which is the Radio Broadcasting Section.

ITU-R BS in the recommendation which consists of standards relating to broadcasting (audio) operations, one of which is the ITU-R BS.775-1 which governs "multi-channel stereo sound systems."

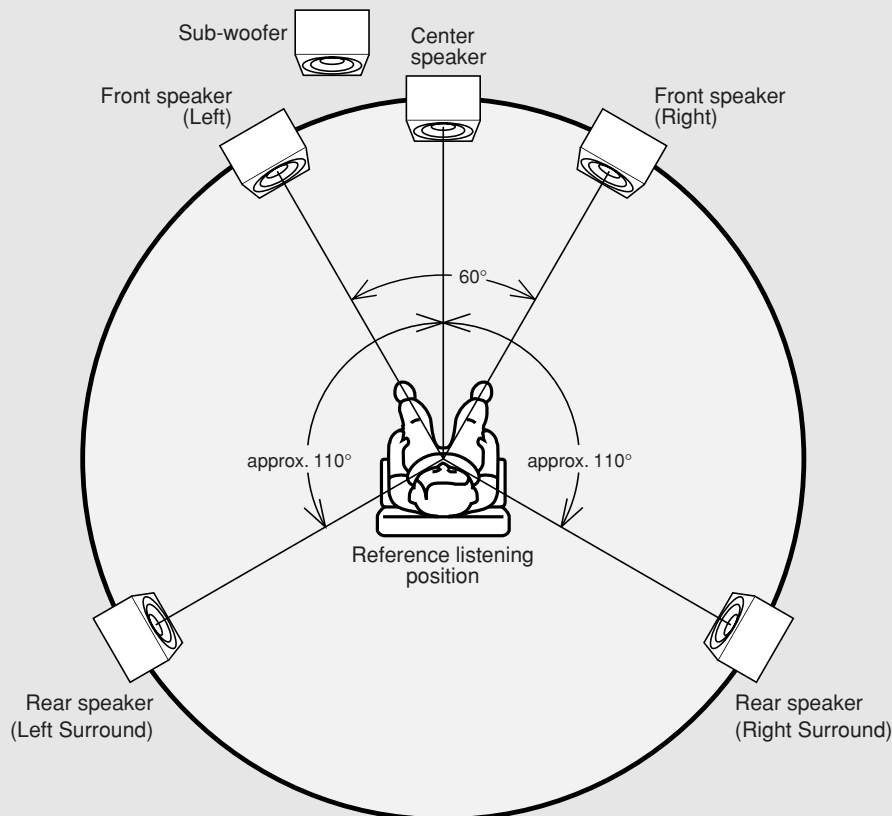

CONNECTIONS

Connection 4 5.1ch multi-channel connection

This Connection is standard for Multi-channel sound source. This will enable you to experience the high quality sound acoustic for the professional Home theatre and pure multi channel Super Audio CD. The complete system is controlled using 3 SC-7S2 Stereo Control Amplifiers.

The system can be enhanced to

- <3 units of SC-7S2 + 10 units of MA-9S2 + Active sub-woofer>
- <6 units of SC-7S2 + 10 units of MA-9S2 + Active sub-woofer>

Caution

- If you use an Active (powered) sub-woofer for LFE, please refer to the User's manual of the Active sub-woofer for set-up instructions. LFE (Low frequency Effect) is the channel for Low Frequency only.
- In case you use a Passive sub-woofer for LFE, a Monaural power Amp such as the MA-9S2 can be used to drive it.

➔ : Signal flow

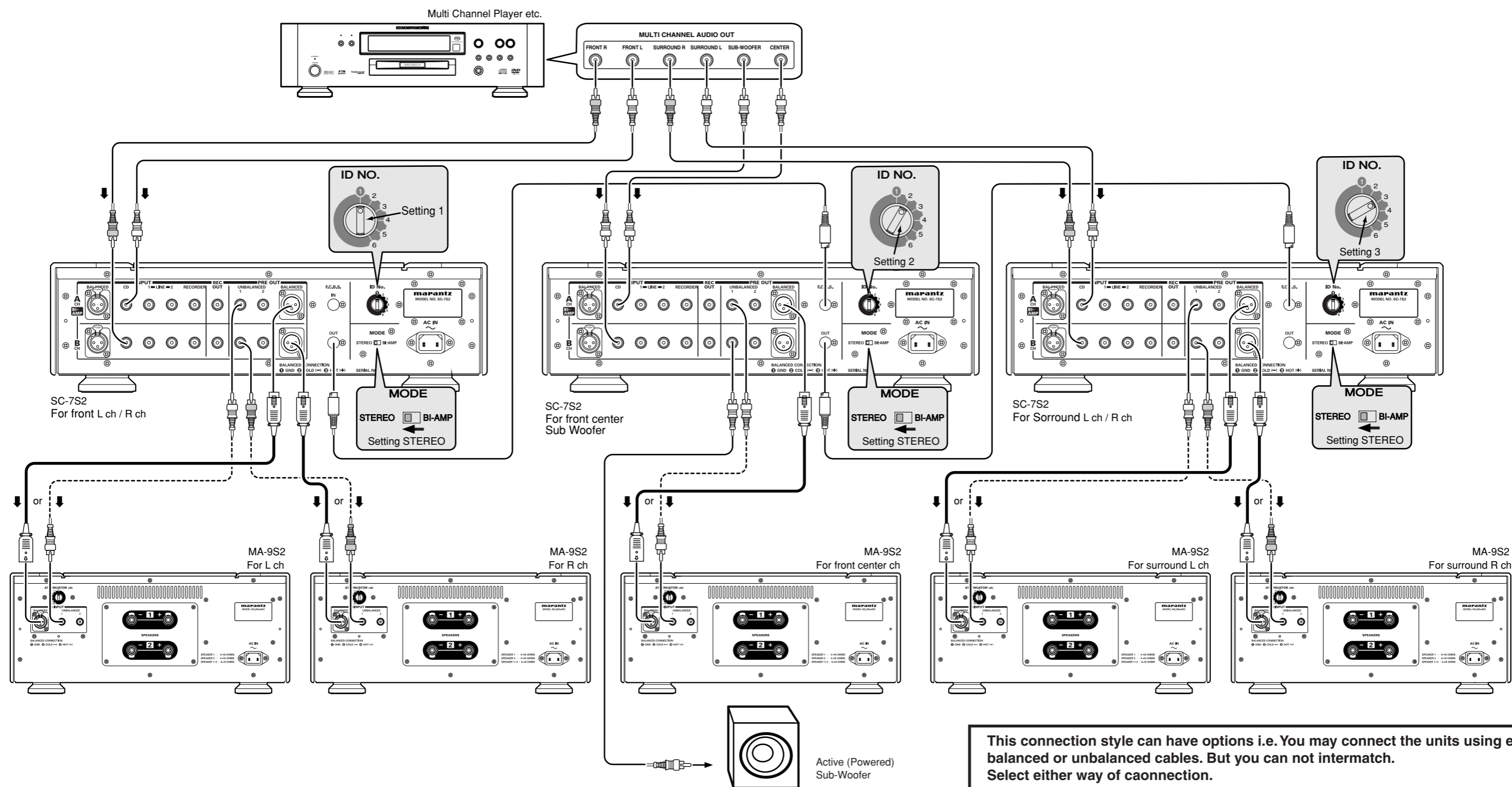

NAME AND FUNCTION

FRONT PANEL

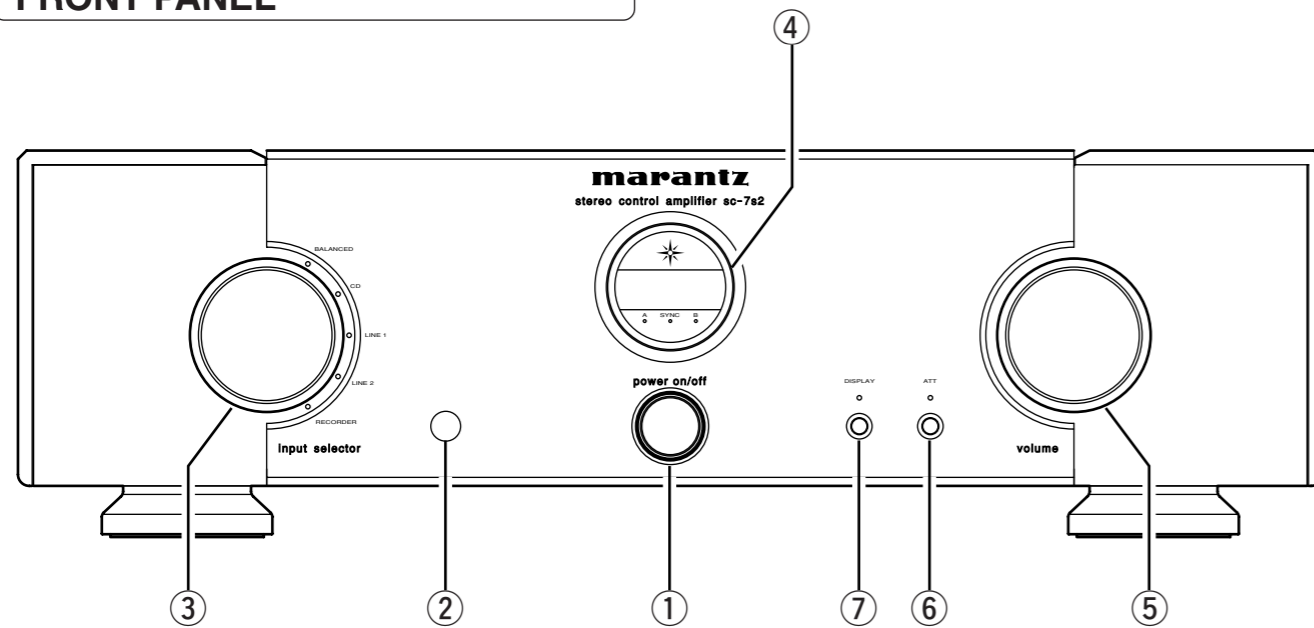

① Power switch

The switch is used to Power the unit ON and or OFF. Once the unit is powered On, the indicator of the Input Selector will illuminate for the source selected. The SC-7S2 will be ready in approximately 8 seconds.

② Remote control sensor

This is the IR (Infra Red) window which receives IR control signals being sent from the remote controller.
How to use remote control → p.14

③ Input selector knob

The input Selector Knob will determine what source is being played as well as well as able to be recorded. When the Source is selected, the Blue indicator will be illuminated to verify the source selected. When the unit is powered down, the last selected source will be held in memory. When the unit is powered on again, the last selected source will be selected. When RECORDER is selected, there will be no signal output, to the record output.

④ Display section

Displays the settings & volume level.

⑤ Volume knob

The Volume knob is used to increase & decrease the overall volume level. By turning the Volume Knob clockwise, the volume will be increased. By turning the Volume Knob counter clock-wise, the volume will decrease. When powering the unit off, the last volume setting will be memorized.

⑥ ATT (Attenuation) button, indicator

The ATT button is used to reduce the volume quickly, with just one touch. Once the button is pressed, the volume will be decreased. The Volume Display will begin blinking & the Volume Indicator above the ATT button will illuminate. If you press the ATT button again, the Volume Display will stop blinking & display the Volume level. You can decrease the volume by 20dB, 40dB & 60dB. Please refer to page 16 for further information regarding Attenuation functions.

⑦ Display button, indicator

This button is to turn off the Volume Indicator & the Light for the Volume Indicator. If the volume Indicator & light are on, and you press this button, they will both be turned off. Also, the light above this button will be illuminated. If you make any adjustment the Volume Indicator & Light will come on for 3 seconds, then shut off again. If you press this button again, the Volume Indicator & Light will be turned on and the light above this button, will shut off.

DISPLAY SECTION

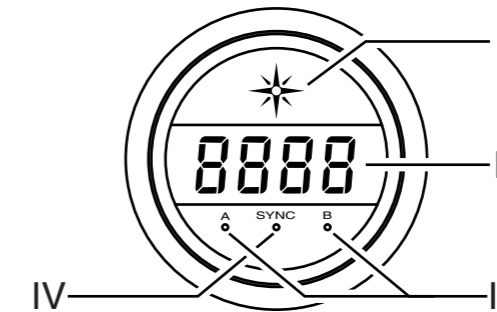

I Power indicator

This Indicator is to show if the power is on. When power is on, the blue light will be illuminated.

II Volume indicator

This will display the volume level and changes made to the volume with either the remote controller or the Volume Knob on the face of the unit. After 3 seconds of being powered on, the ID number will be displayed. The ID number is

changed by the ID switch on the rear panel of the unit. If the attenuate function or trim adjustment is being used, the levels will also be indicated. If using several SC-7S2s, and they are not connected properly, and error code will be indicated.

Error message → p20

III A/B CH Indicator

During trim adjustment, the indicator lights will be illuminated in accordance to the adjustments.

See Trim adjustment → p17

IV SYNC (Synchronized) Indicator

The indicator will be illuminated in accordance with the ID number setting.

- Green color illuminated:
ID No. is set up <1>.
- Red illuminated:
ID No. is set up 2-6 (several SC-7S2 are connected)
In this state, the unit can not be operated via the remote controller, or by the unit itself.
- Light off:
There is an error in the remote connections.
- Green or Red color will be flashing:
While trim is being adjusted.

When you use the remote control, please face it towards the SC-7S2.

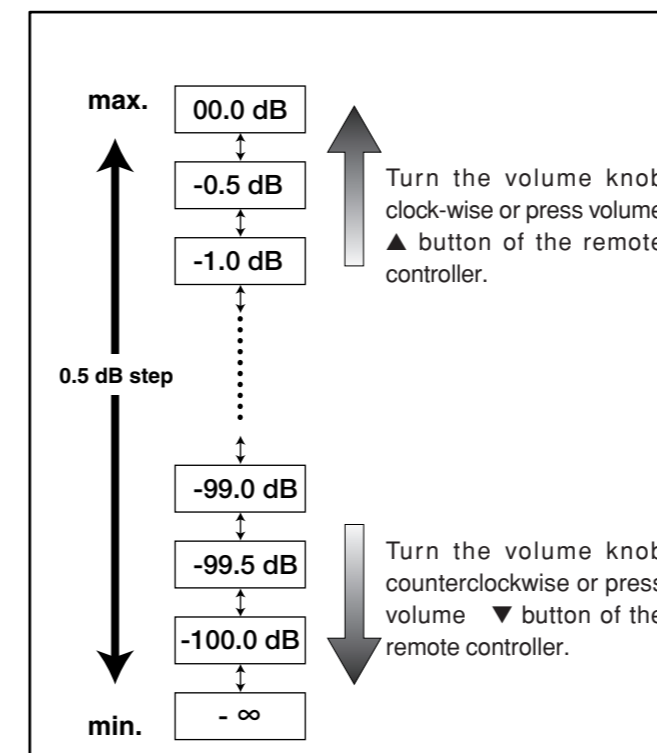

NAME AND FUNTION

REAR PANEL

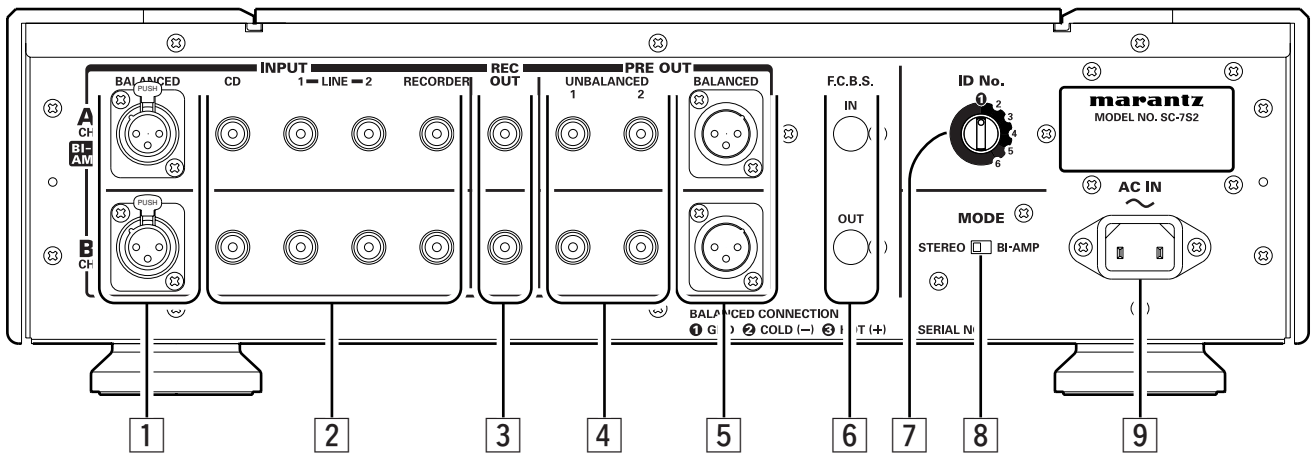
**1 Input Balanced terminal**

This terminal is to connect the components which have balanced outputs i.e. CD Player.
When Bi-Amping, terminal B can not be used.
Balanced terminal → p5

2 Input CD, Line 1, Line 2, Recorder (Unbalanced) terminal

This terminal is to connect the unbalanced terminals of components., i.e. CD etc.
When Bi-Amping, terminal B can not be used.

3 Rec out terminal

The terminal connects to the Input of Recording equipment i.e. CD Recorders, Tape Recorder etc.
When Bi-Amping, the signal being input to channel A, will be output to both A & B channels.

4 Pre out Unbalanced 1,2 terminal

This connects to the unbalanced inputs of a Power Amp.
When Bi-Amping, the signal being input to channel A, will be output to both A & B channels.

5 Pre out Balanced terminal

This terminal is connected to the Balanced input of the Power Amplifier. When Bi-Amping, the signal being input to channel A, will be output to both A & B channels.

6 F.C.B.S. In/Out terminal

These terminals are for connecting one or more SC-7S2s to each other. The IN is for receiving control signals. The OUT is for sending Control signals.

7 ID No. switch

Whilst several SC-7S2 are connected, to set up respective ID No. to distinguish each products.
When only 1 unit is used, the No. will be set 1. Initial setting is <1>.

This switch is to give ID numbers to each SC-7S2, when two or more are used. When using only 1, SC-7S2 the ID switch is set to 1. Factory setting is 1.

Trim adjustment in case of several units of SC-7S2 → p18
If using 2 or more SC-7S2s, you can use the trim Adjustment.
See page 18.

8 Mode switch

The switch to change Stereo mode and Bi-Amp mode.
Initial setting is <stereo>.

- In case SC-7S2 is used for normal 2 channel.
Setting <Stereo> mode.
- In case of complete Bi-Amp connection with 2 units of SC-7S2.
Setting <Bi-Amp> mode.
In case of <Bi-Amp> mode, the signal input from A channel will be out to both of A/B channels through Pre-out terminal and Rec out terminal.
Then, input terminal on B channel can not be used.

This switch is to switch between Stereo & Bi-Amp Mode.
Factory setting is Stereo. Stereo is used for using only 1 SC-7S2. If using 2 or more SC-7S2s, you will set the switch to Bi-Amp Mode. When Bi-Amping, the signal being input to channel A, will be outputted to both A & B channels through the Pre-out & REC out terminals. The B input terminal can not be used in Bi-Amp Mode.

9 AC IN socket

Connect to a household power outlet with supplied AC CORD.

NAME AND FUNTION

REMOTE CONTROLLER

This remote controller can control the SC-7S2 and Marantz Super Audio CD players and DVD players that have a remote control receptor. The operations possible by remote control may differ with each component, therefore see the instruction manual that came with the component.

Remote controller buttons are laid out as shown below.

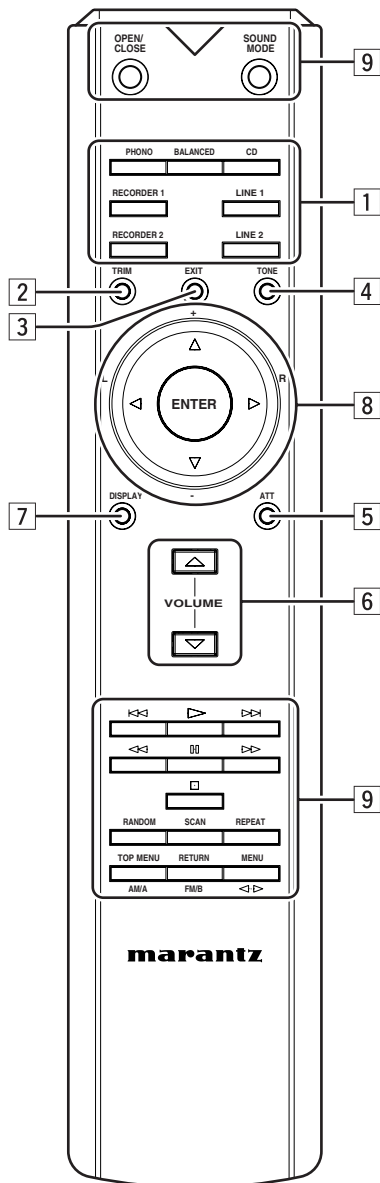

1 Input Selector Buttons

These buttons are for selecting the input source to use in playback.

This button is not available for use on the SC-7S2.

2 TRIM Button

This button starts trimming. When multiple SC-7S2s are connected by FCBS, this button selects the amplifier with which to perform trimming.

3 EXIT Button

This button ends the trimming mode when trimming is finished.

4 TONE Button

Not available for use.

5 ATT Button

This button attenuates volume level with one press.

6 Volume Buttons

▲ : This button increases the volume level.

▼ : This button decreases the volume level.

7 DISPLAY Button

This button turns the display ON and OFF.

8 Cursor Buttons

In the Trimming Mode

These buttons are for selecting the channel to trim and the trimming level.

ENTER : Not available for use.

▶/R : This button selects the R channel for trimming.

◀/L : This button selects the L channel for trimming.

▲/+ : This button increases the trimming level.

▼/- : This button decreases the trimming level.

Other Than the Trimming Mode

▶, ◀, ▲, ▼ and ENTER: These buttons are for selecting settings items on menu displays of Marantz DVD players, etc. For operations of supported Marantz products, see the tables on the following page and the instruction manual of the Marantz component.

9 Component Operating Buttons

These buttons are for operating Marantz Super Audio CD players, DVD players, etc. For operations of supported Marantz products, see the tables on the following page and the instruction manual of the Marantz component.

NAME AND FUNTION

The buttons in groups [8] and [9] are for operating Marantz products other than the SC-7S2, such as Super Audio CD players and DVD players. The function of each button changes to match the component selected as the input source from the input selector buttons [1]. When the CD and BALANCED buttons are pressed, the buttons in groups [8] and [9] function as indicated in the below table. These buttons can be used only when a Marantz Super Audio CD player is connected to the CD input or BALANCED INPUT jacks. When a compatible Marantz component is being used and is connected to the applicable terminal, the SC-7S2 remote controller can be used for basic operations of the connected component. For details on each of the functions, please refer to the instruction manual that came with the connected component.

Input keys of the remote controller	BALANCED	CD	LINE1	LINE2	RECORDER1	RECORDER2
Input Terminal of SC-7S2	BALANCED	CD	LINE1	LINE2	RECORDER	
Marantz model's category	CD Player	CD Player	Tuner	DVD Player	CD Recorder	Cassette Deck
OPEN/CLOSE	○		—	○	○	—
SOUND MODE	○		T-MODE	S-MODE	—	—
ENTER	○		○	○	—	—
▶	○		—	○	○	○
◀◀	○		PRESET-	○	○	○
▶▶	○		PRESET+	○	○	—
◀	○		TUNING-	○	○	—
▶	○		TUNING+	○	○	○
■	○		—	○	○	○
■	○		—	○	○	○
RANDOM	○		—	○	○	—
SCAN	AMS		PRESET SCAN	○	—	—
REPEAT	○		—	○	○	—
TOP MENU / AM / A	—		AM	TOP MENU	—	DECK A
RETURN / FM / B	—		FM	RETURN	—	DECK B
MENU / DIRECTION	MENU		MENU	MENU	—	DIRECTION
▲/+	—		—	▲	—	—
▼/-	—		—	▼	—	—
◀/L	—		—	◀	—	—
▶/R	—		—	▶	—	—

■ For use of Remote controller

Loading batteries

Before using the supplied remote controller for the first time, load the batteries in the remote controller. The batteries provided are used to verify the operations of the remote controller only.

- Remove the battery cover which is found on the back side of the remote control unit.

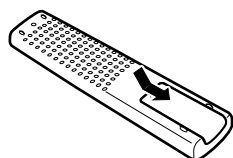

- Load the two new size "AAA" batteries inside the battery compartment while taking care to align their polarities correctly with the polarity markings (+ with + and - with -).

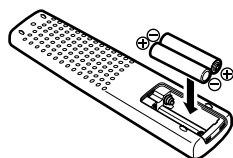

- Push the cover on the back side in the direction of the arrow to close.

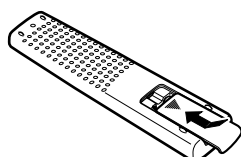

■ Operable range of Remote controller

Operate the remote controller within a distance of approx. 5 m from the infrared signal reception window (remote sensor) on the front of the SC-7S2.

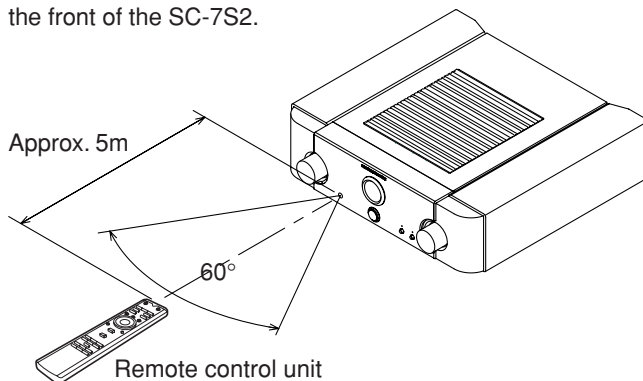

Caution

- Do not allow direct sunlight, an inverter fluorescent light or other strong source of light to shine onto the player's infrared signal reception window (remote sensor). Otherwise, the operation of the remote control unit may be disabled.
- Bear in mind that operating the remote control unit may cause other devices operated by infrared rays to be operated by mistake.
- The remote control unit cannot be operated if the space between the controller and the player's remote sensor is obstructed.
- Do not place any objects on top of the remote control unit. Doing so may cause one or more buttons to be held down which will cause the batteries to run down.

STANDARD OPERATION

HOW TO PLAY

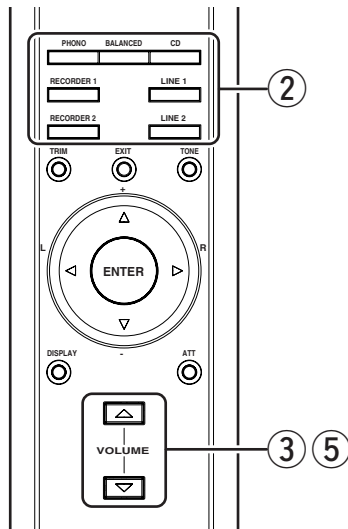
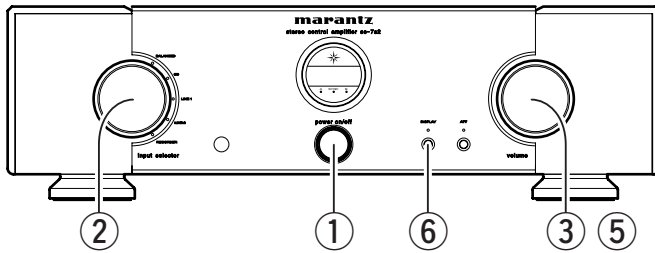

- ① Power on the SC-7S2. In case you have several SC-7S2s connected, please power on from the smaller No. of ID to the larger No.

Once the power is on, the Front display and input indicator for the currently selected source will be illuminated.

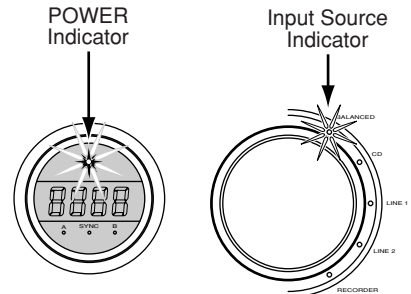

Upon initial turn on, the sound will be muted, for approximately 8 seconds.

- ② Select the input source by the input selector button or the Input select button on the Remote control.
- ③ It is recommended to turn the volume down to the minimum level after each use, before Powering the unit off.
- ④ Play music by operating equipments such as CD Players.
- ⑤ Adjust the volume by the buttons ▲/▼ of SC-7S2 or the remote controller.
- ⑥ If the display button is pressed, the volume indicator will be turned off.

HOW TO RECORD

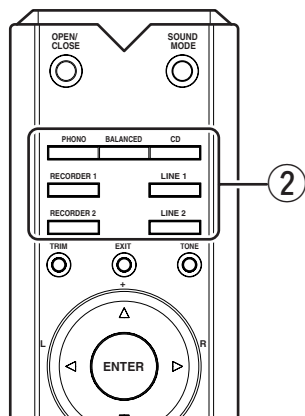
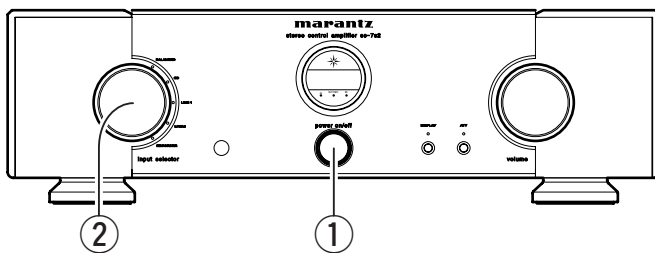

- ① Power on SC-7S2.
- ② Select the source you want to record via the Input selector on the SC-7S2, or the remote controller. Prepare for Playback of the selected source. Make sure your recording unit, is connected to the REC output terminal. Perform operations on your recording device to begin recording. If (RECORDER) is selected, for your input source, you will not be able to record, Because there is no analog output to the REC out.

HOW TO OPERATE FUNCTION AND HOW TO SET UP

ATTENUATE FUNCTION

With one touch, the volume can be decreased, instantly. The ATT button on the SC-7S2 or the remote controller, is used for this function.

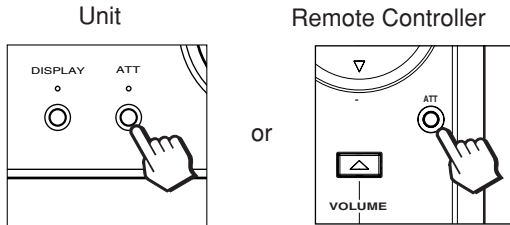

The volume will be indicated in the display window & the indicator above the ATT button will be illuminated.

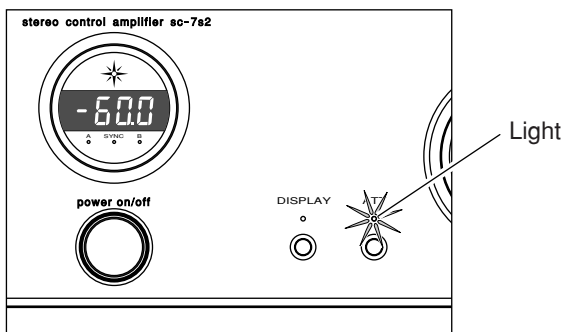

Factory setting is -20dB. But this can be changed to -40dB, or -60dB.

③ Press the ATT button, the attenuation level will be changed with every press.

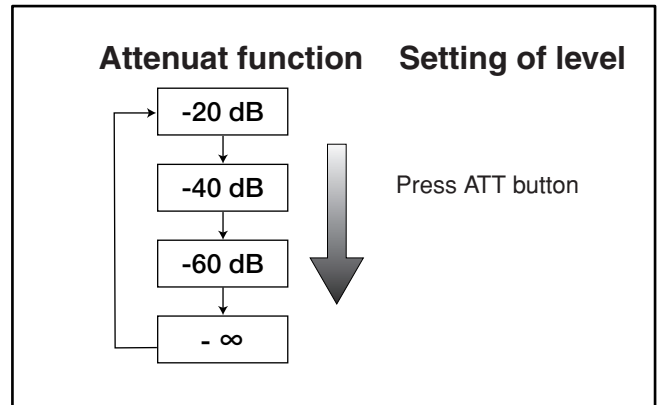
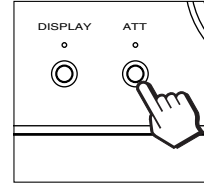

④ Unless the button is pressed within 2 seconds, the attenuation level will be fixed. Once the level is fixed, the display will turn back to the volume indication.

The setting will be memorized.

HOW TO SET UP THE ATTENUATION LEVEL

① Press ATT button for more than 2 seconds.

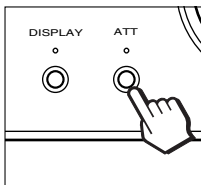

② The Indicator above the ATT button will begin to flash, the volume indication will be changed to the attenuation level setting.

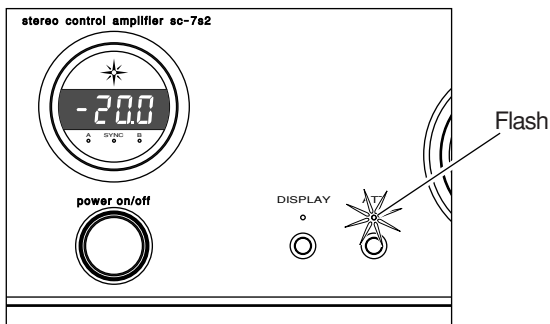

HOW TO OPERATE FUNCTION AND HOW TO SET UP

TRIM ADJUSTMENT FUNCTION

You can adjust the output level within -6.0dB+6.0dB (0.5dB step) for each channel.

How to adjust Trim setting In case of 1 unit

- ① Press the TRIM button on the remote controller. Then A ch indicator on the Front display will illuminate red, the Green colored Sync indicator will begin flashing. The Volume indicator will show the Trim adjustment level on the A ch.

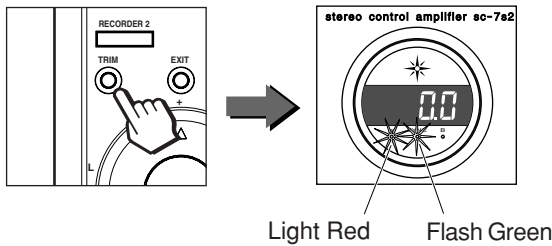

- ② Once the ▲ button on remote controller is pressed, The Trim adjustment level will be increased by 0.5 dB step, and the output level on the A ch will be increased.

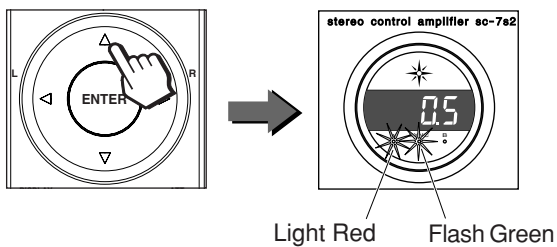

Once ▼ button on remote controller is pressed, the Trim adjustment level will be decreased by 0.5 dB step, and the output level on the A ch will be decreased.

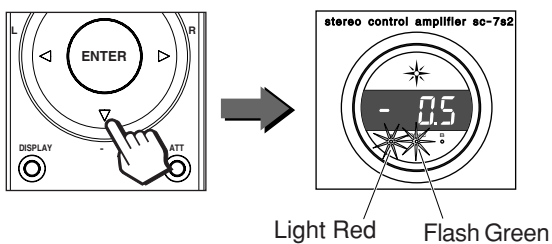

- ③ Once the ► button on remote controller is pressed, Indicator on the A ch will be turned off, the indicator on the B ch will be illuminated. Then Sync indicator remains flashing Green.

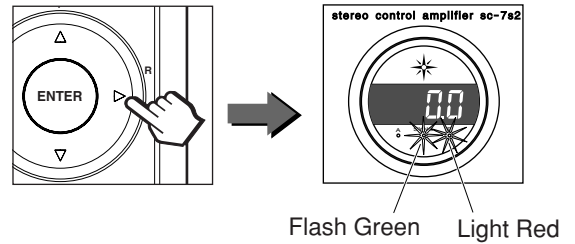

The Volume indicator will show the Trim level on the B ch. Once the ▲ button on the remote controller is pressed, the Trim adjustment level will be increased by 0.5 dB step, the output level on the B ch will be increased.

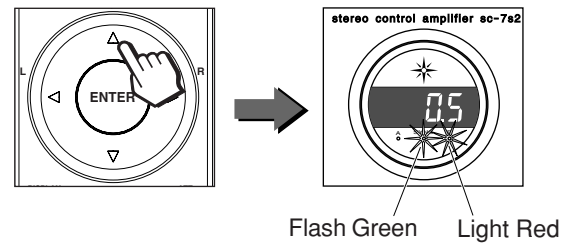

Once the ▼ button on the remote controller is pressed, the Trim adjustment level will be decreased by 0.5 dB step, the output level on the B ch will be decreased.

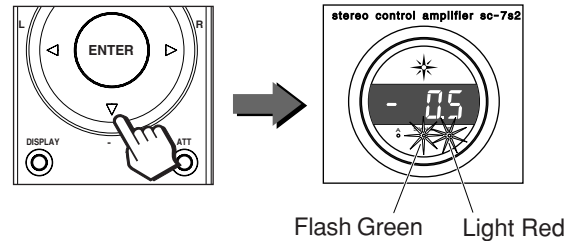

- ④ Once you have completed the trim adjustment, press the Exit Button on the remote controller. This concludes the adjustments and memorized them.

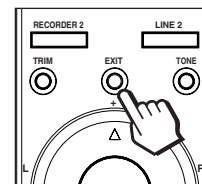

HOW TO OPERATE FUNCTION AND HOW TO SET UP

■ If using more than 1 SC-7S2

Set up the ID numbers to the respective SC-7S2s to identify each of the SC-7S2s.

- ① Set up the ID No. switch <1> for the main unit of the SC-7S2 to control others, which is called <Master> unit.
The ID No. set up will be indicated in the display window for 3 seconds when the unit is powered on.

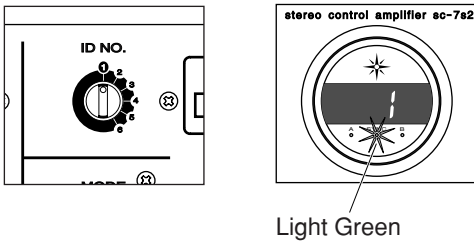

- ② Set up the other SC-7S2s <2>—<6> which will be controlled by the Master.
They are called <Slave> units.
The ID No. set up will be indicated in the display window for 3 seconds when the unit is powered on.

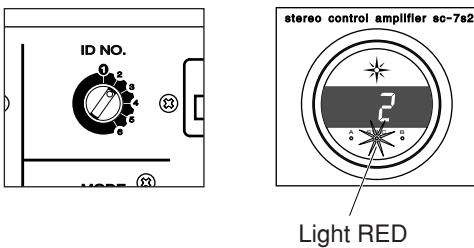

- ③ The Trim adjustment set by the Master, will be the same for all Slave SC-7S2s.
- ④ Once the set up for the Trim has been finished, press the TRIM button on the remote controller.
The trim adjustment will move from Master to Slave.
Then the indicator on the Front display of the Slave will illuminate Red, the Sync indicator will flash Red.

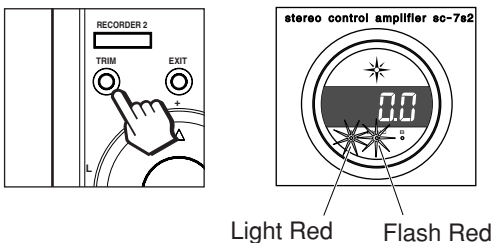

- ⑤ Please refer to p.18 for Trim adjustment.
If the whole system consist of more than 3 units, please repeat the same procedure and set up the remaining units.
Make sure to change the ID # in the SC-7S2 to match the ID # of the amplifier being adjusted.
- ⑥ Once you have completed the trim adjustment, press the EXIT button on the remote control. This concludes the adjustments and memorizes them.

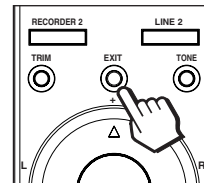

SPECIFICATION

SPECIFICATION

Maximum output voltage (20Hz-20kHz)	13.5V (BALANCED)
.....	13.5V (UNBALANCED)
Total harmonic distortion (20Hz-20kHz)	0.0015% (BALANCED)
.....	0.003% (UNBALANCED)
Frequency response (+0/-3dB)	3Hz-150kHz (BALANCED)
.....	3Hz-150kHz (UNBALANCED)
Input sensitivity/Input impedance	420mV/20kΩ (BALANCED)
.....	420mV/20kΩ (UNBALANCED)
Output impedance	70Ω (BALANCED)
.....	70Ω (UNBALANCED)
S/N (IHF-A)	105dB (BALANCED)
.....	108dB (UNBALANCED)
Channel separation (20kHz)	100dB (BALANCED)
.....	100dB (UNBALANCED)
Volume adjustment range	-∞, -100-0dB (0.5dB STEP)
Trim level adjustment range	±6dB (0.5dB STEP)
Attenuator setting level	-20, -40, -60, -∞dB
Supply voltage (SC-7S2/N1G)	AC 230 V 50Hz
(SC-7S2/U1G)	AC 120 V 60Hz
Power consumption (SC-7S2/N1G)	20W (0.1 A)
(SC-7S2/U1G)	20W (0.2 A)
Dimensions	W 459mm
.....	H 136mm
.....	D 441mm
Weight	21.8kg

DIMENSIONS

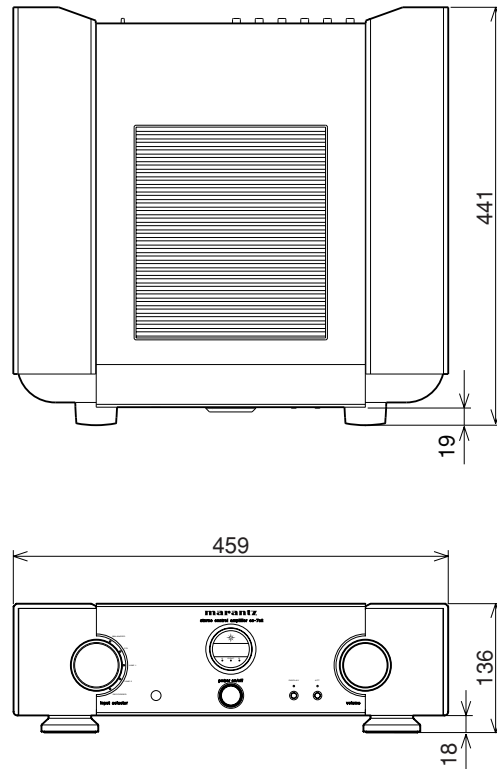

Unit: mm

BLOCK DIAGRAM

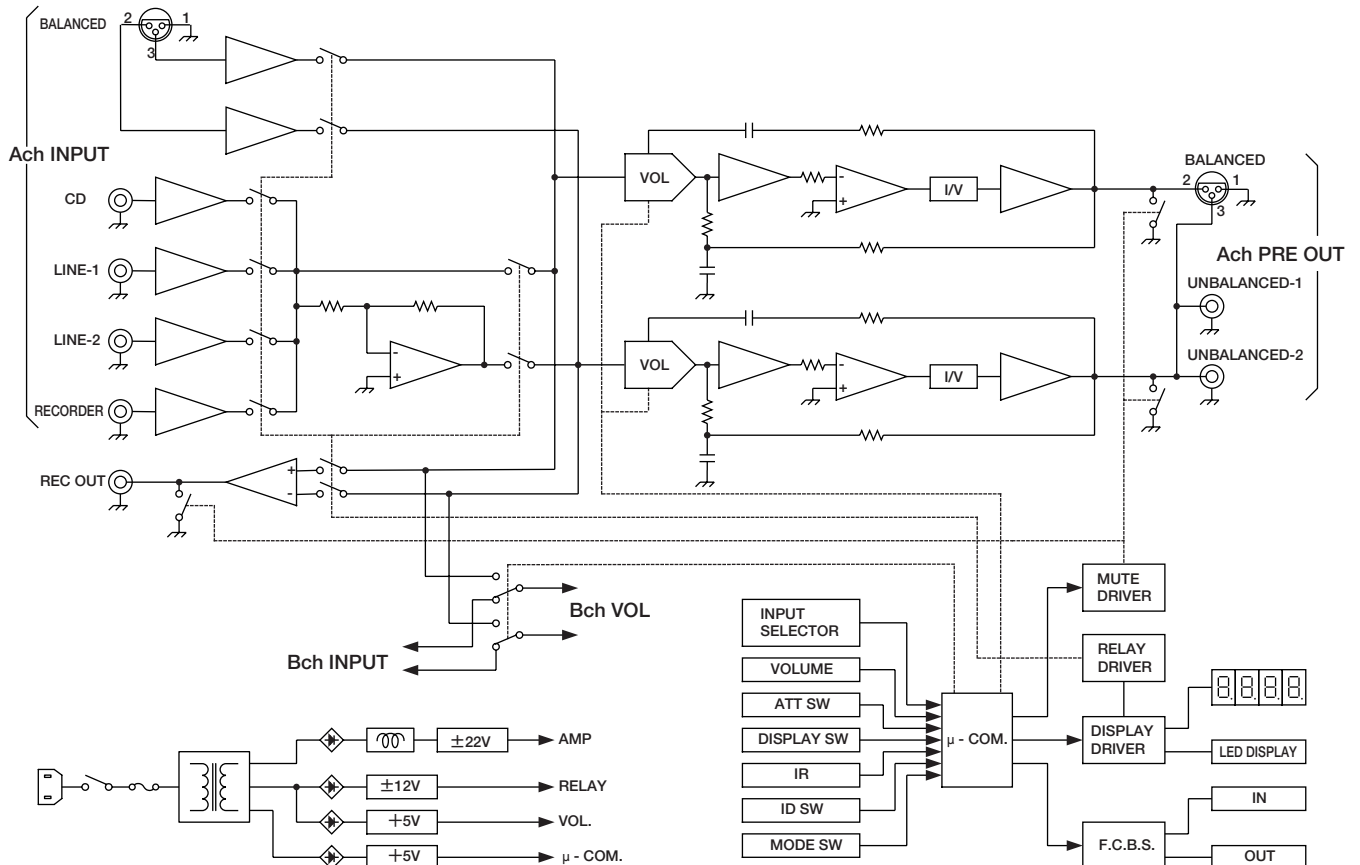

TROUBLE SHOOTING

Should faults occur, in many cases it is not necessary to consult your dealer or a Marantz technical service department. On the basis of the following checks you will be able to rectify a number of faults yourself without difficulty. If the fault cannot be remedied after the following checks, please consult your dealer or nearest Marantz service agent.

■ The unit does not turn ON

1. Is the power cable securely connected to both the connection terminal of this unit and an AC outlet?

■ Sound is not coming from the speakers

1. Has the wrong input source been selected with the INPUT SELECTOR on the front panel?
2. Is the ATTENUATOR feature set to ∞ and has it been worked?
3. Is the SYNC indicator on the front panel lit? Has the wrong ID No. been set? Is the remote cable wrongly connected?
4. Are connections cables correctly connected between the unit and player or power amplifier?
5. Is the power amplifier or input source wrongly set?
6. Are speaker cables properly connected between the power amplifier and the speaker system?
7. Are you using the player in the wrong way?

■ Stereo sound is not coming from the speakers

1. Is the MODE switch on the rear panel set to "BI-AMP"?

ABOUT ERROR CODES

If any of the error codes shown in the below table appear on the display on the front panel while using multiple SC-7S2s, there is something wrong with either the ID No. setting or the remote cable connection.

In such case, shut OFF power to the power amplifier, then shut OFF power to all SC-7S2s and check the ID No. setting and remote cable connection as explained in the What to do column below.

	Error code	Meaning	What to do
1	E02	ID No. 2 has been set for multiple units.	Set the ID No. switch so that multiple units do not share the same ID No.
2	E03	ID No. 3 has been set for multiple units.	
3	E04	ID No. 4 has been set for multiple units.	
4	E05	ID No. 5 has been set for multiple units.	
5	E06	ID No. 6 has been set for multiple units.	
6	E11	Communication is not possible between ID No. 1 (master) and ID Nos. 2 ~ 6 (slaves).	Is power to ID No. 1 ON? Check the IN/OUT connections of the remote cable and properly connect as necessary.
7	E12	ID No. 1 (master) has been set for multiple units.	Set the ID No. switch so that multiple units do not share the same ID No.

MAINTENANCE

The section describes the care and maintenance tasks that must be performed to optimize the operation of your Marantz equipment.

■ Cleaning of equipment external surfaces

The exterior finish of your unit will last indefinitely with proper care and cleaning. Never use scouring pads, steel wool, scouring powders or harsh chemical agents (e.g., lye solution), alcohol, thinner, benzene, insecticide or other volatile substances as these will mar the finish of the equipment. Likewise, never use cloths containing chemical substances. If the equipment get dirty, wipe the external surfaces with a soft, lint-free cloth.

If the equipment becomes heavily soiled:

- dilute some washing up liquid in water, in a ratio of one part detergent to six parts water.
- dip a soft, lint free in the solution and wring the it is damp.
- wipe the equipment with the damp cloth.
- dry the equipment by wiping it with a dry cloth.



■ Repairs

Only the most competent and qualified service technicians should be allowed to service the factory-trained warranty station personnel have the knowledge and special facilities needed for repair and calibration of this precision equipment. After the warranty period has expired, repairs will be performed for a charge if the equipment can be returned to normal operation. In the event of difficulty, refer to your dealer or write directly to the nearest location to you that is listed on the Marantz Authorized Service Station list. If writing, please include the model and serial number of the equipment together with a full description of what you think is abnormal about the equipment's behaviour.

www.marantz.com

You can find your nearest authorized distributor or dealer on our website.

marantz[®] is a registered trademark.

Free Manuals Download Website

<http://myh66.com>

<http://usermanuals.us>

<http://www.somanuals.com>

<http://www.4manuals.cc>

<http://www.manual-lib.com>

<http://www.404manual.com>

<http://www.luxmanual.com>

<http://aubethermostatmanual.com>

Golf course search by state

<http://golfingnear.com>

Email search by domain

<http://emailbydomain.com>

Auto manuals search

<http://auto.somanuals.com>

TV manuals search

<http://tv.somanuals.com>