

# marantz®

**Model SR4400 User Guide**

---

AV Surround Receiver

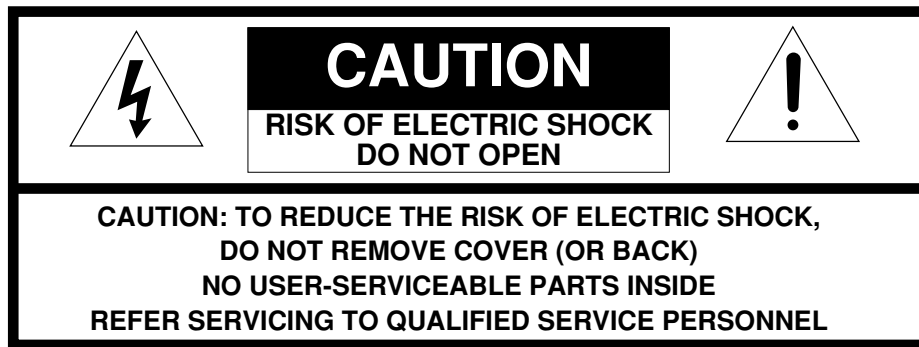

The lightning flash with arrowhead symbol within an equilateral triangle is intended to alert the user to the presence of uninsulated "dangerous voltage" within the product's enclosure that may be of sufficient magnitude to constitute a risk of electric shock to persons.



The exclamation point within an equilateral triangle is intended to alert the user to the presence of important operating and maintenance (servicing) instructions in the literature accompanying the product.

## WARNING

**TO REDUCE THE RISK OF FIRE OR ELECTRIC SHOCK,  
DO NOT EXPOSE THIS PRODUCT TO RAIN OR MOISTURE.**

**CAUTION: TO PREVENT ELECTRIC SHOCK, MATCH WIDE BLADE OF PLUG  
TO WIDE SLOT, FULLY INSERT.**

**ATTENTION: POUR ÉVITER LES CHOC ÉLECTRIQUES, INTRODUIRE LA  
LAME LA PLUS LARGE DE LA FICHE DANS LA BORNE CORRESPONDANTE  
DE LA PRISE ET POUSSER JUSQU'AU FOND.**

### NOTE TO CATV SYSTEM INSTALLER:

This reminder is provided to call the CATV (Cable-TV) system installer's attention to Section 820-40 of the NEC which provides guidelines for proper grounding and, in particular, specifies that the cable ground shall be connected to the grounding system of the building, as close to the point of cable entry as practical.

### NOTE:

This equipment has been tested and found to comply with the limits for a Class B digital device, pursuant to Part 15 of the FCC Rules. These limits are designed to provide reasonable protection against harmful interference in a residential installation. This equipment generates, uses and can radiate radio frequency energy and, if not installed and used in accordance with the instructions, may cause harmful interference to radio communications. However, there is no guarantee that interference will not occur in a particular installation. If this equipment does cause harmful interference to radio or television reception, which can be determined by tuning the equipment off and on, the user is encouraged to try to correct the interference by one or more of the following measures:

- Reorient or relocate the receiving antenna.
- Increase the separation between the equipment and receiver.
- Connect the equipment into an outlet on a circuit different from that to which the receiver is connected.
- Consult the dealer or an experienced radio/TV technician for help.

### NOTE:

Changes or modifications not expressly approved by the party responsible for compliance could void the user's authority to operate the equipment.

# IMPORTANT SAFETY INSTRUCTIONS

## READ BEFORE OPERATING EQUIPMENT

This product was designed and manufactured to meet strict quality and safety standards. There are, however, some installation and operation precautions which you should be particularly aware of.

1. Read these instructions - All the safety and operating instructions should be read before the product is operated.
2. Keep these instructions - The safety and operating instructions should be kept for future reference.
3. Heed all warnings - All warnings on the product and in the operating instructions should be adhered to.
4. Follow all instructions - All operating and use instructions should be followed.
5. Do not use this apparatus near water - Do not use this product near water-for example, near a bath tub, wash bowl, kitchen sink, or laundry tub, in a wet basement, or near a swimming pool, and the like.
6. Clean only with dry cloth - Unplug this product from the wall outlet before cleaning. Do not use liquid cleaners or aerosol cleaners. Use a dry cloth for cleaning.
7. Do not block any ventilation openings. Install in accordance with the manufacture's instructions.
8. Do not install near any heat sources such as radiators, heat registers, stoves, or other apparatus (including amplifiers) that produce heat.
9. Do not defeat the safety purpose of the polarized or grounding-type plug. A polarized plug has two blades with one wider than the other. A grounding type plug has two blades and a third grounding prong. The wide blade or the third prong are provided for your safety. If the provided plug does not fit into your outlet, consult an electrician for replacement of the obsolete outlet.
10. Protect the power cord from being walked on or pinched particularly at plugs, convenience receptacles, and the point where they exit from the apparatus.
11. Only use attachments/accessories specified by the manufacturer.
12. Use only with the cart, stand, tripod, bracket, or table specified by the manufacturer, or sold with the apparatus. When a cart is used, use caution when moving the cart/apparatus combination to avoid injury from tip-over.
13. Unplug this apparatus during lightning storms or when unused for long periods of time.
14. Refer all servicing to qualified service personnel. Servicing is required when the apparatus has been damaged in any way, such as power-supply cord or plug is damaged, liquid has been spilled or objects have fallen into the apparatus, the apparatus has been exposed to rain or moisture, does not operate normally, or has been dropped.
15. This product should not be placed in a built-in installation such as a bookcase or rack unless proper ventilation is provided or the manufacturer's instructions have been adhered to.
16. Apparatus shall not be exposed to dripping or splashing and that no objects filled with liquids, such as vases, shall be placed on the apparatus.

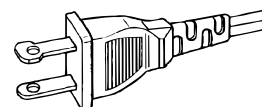

AC POLARIZED PLUG

This Class B digital apparatus complies with Canadian ICES-003.

Cet appareil numérique de la Classe B est conforme à la norme NMB-003 du Canada.

# TABLE OF CONTENTS

<b>INTRODUCTION.....</b>	<b>2</b>	<b>BASIC OPERATION (PLAY BACK) ..</b>	<b>21</b>
CAUTIONS ON INSTALLATION .....	2	SELECTING AN INPUT SOURCE .....	21
<b>DESCRIPTION.....</b>	<b>2</b>	SELECTING THE SURROUND MODE .....	21
<b>FEATURES .....</b>	<b>3</b>	ADJUSTING THE MAIN VOLUME .....	21
<b>ACCESSORIES .....</b>	<b>3</b>	ADJUSTING THE TONE(BASS & TREBLE) CONTROL ..	21
<b>FRONT PANEL .....</b>	<b>4</b>	TEMPORARILY TURNING OFF THE SOUND .....	21
FL DISPLAY .....	4	USING THE SLEEP TIMER .....	21
<b>REAR PANEL .....</b>	<b>5</b>	NIGHT MODE .....	22
<b>REMOTE CONTROL OPERATION .....</b>	<b>6</b>	<b>SURROUND MODE.....</b>	<b>22</b>
FUNCTION AND OPERATION .....	6	<b>OTHER FUNCTION .....</b>	<b>25</b>
PROGRAMMING THE REMOTE CONTROLLER .....	7	ATTENUATION TO ANALOG INPUT SIGNAL .....	25
OPERATION OF REMOTE CONTROL UNIT .....	8	LISTENING OVER HEADPHONES .....	25
GENERAL INFROMATION OF RC5400SR TO SR4400 ...	9	DIMMER (DISPLAY) .....	25
<b>CONNECTIONS.....</b>	<b>10</b>	SELECTING ANALOG AUDIO INPUT OR DIGITAL AUDIO	
SPEAKER PLACEMENT .....	10	INPUT .....	25
CONNECTING SPEAKERS .....	10	RECORDING AN ANALOG SOURCE .....	25
CONNECTING AUDIO COMPONENTS .....	11	HT-EQ .....	25
CONNECTING VIDEO COMPONENTS .....	12	6.1 CH INPUT.....	25
ADVANCED CONNECTING .....	13	<b>BASIC OPERATION (TUNER) .....</b>	<b>26</b>
CONNECTING REMOTE CONTROL JACKS .....	13	LISTENING TO THE TUNER .....	26
CONNECTING THE ANTENNA TERMINALS .....	14	PRESET MEMORY .....	26
<b>SETUP .....</b>	<b>15</b>	<b>TROUBLESHOOTING .....</b>	<b>28</b>
SETUP MENU SYSTEM .....	15	<b>TECHNICAL SPECIFICATIONS .....</b>	<b>30</b>
ENTER THE DESIRED MENU ITEM OF		<b>DIMENSION .....</b>	<b>30</b>
THE SETUP MENU .....	15		
SIMPLE SETUP .....	16		
1. INPUT SETUP (ASSIGNABLE DIGITAL INPUT) .....	16		
2. SPEAKER SETUP .....	17		
3. PREFERENCE .....	19		
4. PL II (DOLBY PRO LOGIC II) .....	19		
5. CS II (CIRCLE SURROUND II) .....	20		
6. 6.1 CH INPUT LEVEL .....	20		
7. SURROUND .....	20		

## INTRODUCTION

Thank you for purchasing the Marantz SR4400 Surround receiver.

This remarkable component has been engineered to provide you with many years of home theater enjoyment. Please take a few minutes to read this manual thoroughly before you connect and operate the SR4400.

As there are a number of connection and configuration options, you are encouraged to discuss your own particular home theater setup with your Marantz A/V specialist dealer.

## CAUTIONS ON INSTALLATION

For heat dispersal, leave at least 20 cm/8 inch of space between the top, back and sides of this unit and the wall or other components.

- Do not obstruct the ventilation holes.

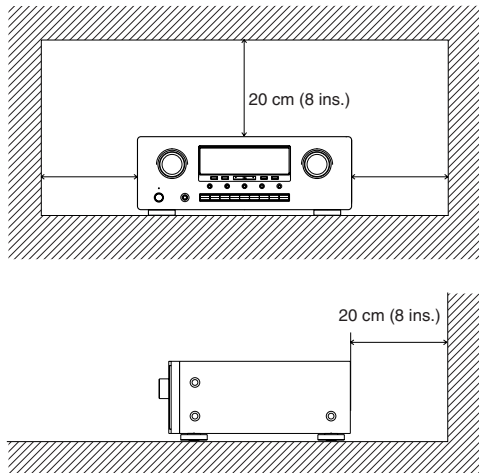

## DESCRIPTION



DTS was introduced in 1994 to provide 5.1 channels of discrete digital audio into home theater systems.

DTS brings you premium quality discrete multi-channel digital sound to both movies and music. DTS is a multi-channel sound system designed to create full range digital sound reproduction.

The no compromise DTS digital process sets the standard of quality for cinema sound by delivering an exact copy of the studio master recordings to neighborhood and home theaters.

Now, every moviegoer can hear the sound exactly as the moviemaker intended.

DTS can be enjoyed in the home for either movies or music on of DVD's, LD's, and CD's.

"DTS" and "DTS Digital Surround" are registered trademarks of Digital Theater Systems, Inc.



The advantages of discrete multichannel systems over matrix are well known.

But even in homes equipped for discrete multichannel, there remains a need for high-quality matrix decoding. This is because of the large library of matrix surround motion pictures available on disc and on VHS tape; and analog television broadcasts.

The typical matrix decoder of today derives a center channel and a mono surround channel from two-channel matrix stereo material. It is better than a simple matrix in that it includes steering logic to improve separation, but because of its mono, band-limited surround it can be disappointing to users accustomed to discrete multichannel.

Neo:6 offers several important improvements as follow,

- Neo:6 provides up to six full-band channels of matrix decoding from stereo matrix material. Users with 6.1 and 5.1 systems will derive six and five separate channels, respectively, corresponding to the standard home-theater speaker layouts.
- Neo:6 technology allows various sound elements within a channel or channels to be steered separately, and in a way which follows naturally from the original presentation.

- Neo:6 offers a music mode to expand stereo nonmatrix recordings into the five- or six-channel layout, in a way which does not diminish the subtlety and integrity of the original stereo recording.



DTS-ES Extended Surround is a new multi-channel digital signal format developed by Digital Theater Systems Inc. While offering high compatibility with the conventional DTS Digital Surround format, DTS-ES Extended Surround greatly improves the 360-degree surround impression and space expression thanks to further expanded surround signals. This format has been used professionally in movie theaters since 1999. In addition to the 5.1 surround channels (FL, FR, C, SL, SR and LFE), DTS-ES Extended Surround also offers the SB (Surround Back) channel for surround playback with a total of 6.1 channels. DTS-ES Extended Surround includes two signal formats with different surround signal recording methods, as DTS-ES Discrete 6.1 and DTS-ES Matrix 6.1.

"DTS", "DTS-ES Extended Surround" and "Neo:6" are trademarks of Digital Theater Systems, Inc.



Dolby Digital identifies the use of Dolby Digital (AC-3) audio coding for such consumer formats as DVD and DTV. As with film sound, Dolby Digital can provide up to five full-range channels for left, center, and right screen channels, independent left and right surround channels, and a sixth ("1") channel for low-frequency effects.

Dolby Surround Pro Logic II is an improved matrix decoding technology that provides better spatiality and directionality on Dolby Surround program material; provides a convincing three-dimensional soundfield on conventional stereo music recordings; and is ideally suited to bring the surround experience to automotive sound. While conventional surround programming is fully compatible with Dolby Surround Pro Logic II decoders, soundtracks will be able to be encoded

specifically to take full advantage of Pro Logic II playback, including separate left and right surround channels. (Such material is also compatible with conventional Pro Logic decoders.)

Dolby Digital EX creates six full-bandwidth output channels from 5.1-channel sources. This is done using a matrix decoder that derives three surround channels from the two in the original recording. For best results, Dolby Digital EX should be used with movies soundtracks recorded with Dolby Digital Surround EX.

Manufactured under license from Dolby Laboratories. "Dolby", "Pro Logic", and the double-D symbol are trademarks of Dolby Laboratories.



Circle Surround II (CS-II) is a powerful and versatile multi-channel technology. CS-II is designed to enable up to 6.1 multi-channel surround sound playback from mono, stereo, CS encoded sources and other matrix encoded sources. In all cases the decoder extends it into 6 channels of surround audio and a LFE/subwoofer signal. The CS-II decoder creates a listening environment that places the listener "inside" music performances and dramatically improves both hi-fi audio conventional surround-encoded video material. CS-II provides composite stereo rear channels to greatly improve separation and image positioning – adding a heightened sense of realism to both audio and A/V productions.

CS-II is packed with other useful feature like dialog clarity (SRS Dialog) for movies and cinema-like bass enrichment (TruBass). CS-II can enable the dialog to become clearer and more discernable in movies and it enables the bass frequencies contained in the original programming to more closely achieve low frequencies – overcoming the low frequency limitations of the speakers by full octave.

SRS Circle Surround II, SRS Dialog, SRS TruBass, SRS and  symbol are trademarks of SRS Labs, Inc.

SRS Circle Surround II, SRS Dialog and SRS TruBass technology are incorporated under license from SRS Labs, Inc.

## FEATURES

### **BUILT-IN 6 CHANNEL POWER AMPLIFIER**

80 watts to each of the six main channels ; the power amp section features an advanced, premium high- storage power supply capacitors, and fully discrete output stages housed in cast aluminum heat sinks .

All channels are equipped the large size screw type speaker terminals.

### **96 kHz/24-BIT D/A CONVERTER FOR ALL CHANNELS**

High performance digital circuitry with 96 kHz / 24-bit D/A converter for all 7 channels.

### **SIMPLE SETUP FUNCTION**

This unit has Simple Setup function for easy setup. You can setup all speaker settings by just selecting your room size and the number of your speakers with Simple Setup function. You can also setup customized settings just like conventional AV amplifiers.

### **DTS-ES**

**DTS-ES** decoder built in to decode the impeccable 6.1-channel discrete digital audio from DTS-ES encoded DVD-Video discs, DVD-Audio discs and CDs.

### **DOLBY DIGITAL EX**

**Dolby Digital EX** decoder built in to create six full-band width output channels from the 5.1-channel digital audio of DVDs, Digital TV, HDTV, satellite broadcasts and other sources.

### **DOLBY PRO LOGIC II**

**Dolby Pro Logic II** decoder provides better spatiality and directionality on Dolby Surround program material and provides a convincing three-dimensional sound field on conventional stereo music recordings.

### **DTS-NEO:6**

**DTS-Neo:6** decoder built in to decode 6.1-channel surround sound from any stereo material.

### **CIRCLE SURROUND II**

**CIRCLE SURROUND II** decoder built in to decode 6.1-channel surround sound from any stereo or passive matrix-encoded material.

### **SOURCE DIRECT MODE**

**Source Direct mode** bypasses, tone controls and bass management for purest audio quality.

### **HT-EQ (HOME THEATER EQUALIZER) EQUIPPED**

In a theater, center speaker is set behind the screen and it attenuates high frequency sound so high tone is recorded emphasized. This unit has HT-EQ (Home Theater Equalizer) function. It enables to play a movie in your home just like its creator wanted.

### **6.1 CHANNEL PRE-AMP OUTPUTS**

**6.1 channel pre-amp outputs** for connection to external components such as a subwoofer and external power amplifiers.

### **6.1CH DIRECT INPUT**

**6.1ch direct inputs** accommodate future multi-channel sound formats or an external digital decoder. (SACD, DVD-Audio, ...etc)

### **4 DIGITAL INPUTS AND 2 DIGITAL OUTPUTS**

**4 Digital inputs** for connection to other sources, such as DVD player, Satellite tuner, CD player, CD recorder or MD deck.

**2 Digital outputs** for connection to CD recorder or MD deck.

### **30 STATION RANDOM ACCESS PRESET TUNING**

High-quality AM/FM tuner with 30 station random access preset tuning.

## ACCESSORIES

### **Remote Controller RC5400SR**

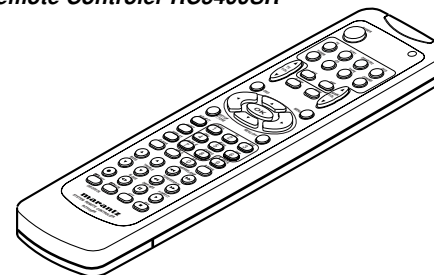

### **AAA-size batteries X 2**

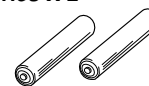

### **AM Loop Antenna**

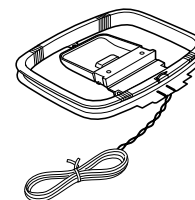

### **FM Antenna**

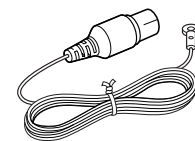

### **Warranty card (USA, CANADA)**

### **User Guide**

## FRONT PANEL

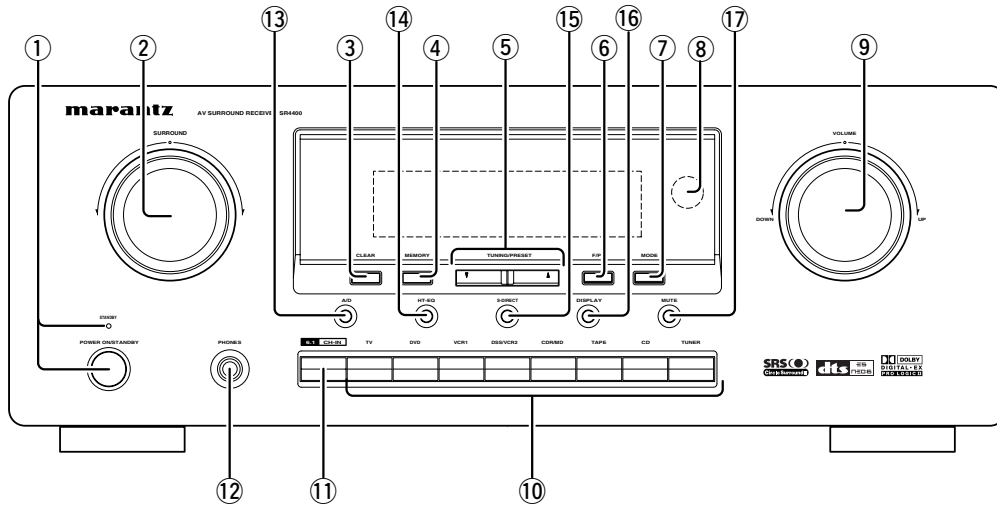

**① POWER switch and STANDBY indicator**  
When this switch is pressed once, the unit turns ON and display appears on the display panel. When pressed again, the unit turns OFF and the STANDBY indicator lights. When the STANDBY indicator is turned on, the unit is NOT disconnected from the AC power.

**② SURROUND MODE Selector knob**  
When this knob is turned, the surround mode is switched sequentially.

**Note:**

- Available surround mode is depending on the input signal.

**③ CLEAR button**  
Press this button to cancel the station-memory setting mode or preset scan tuning.

**④ MEMORY button**  
Press this button to enter the tuner preset memory numbers or station names.

**⑤ TUNING UP / DOWN buttons**  
Press these buttons to change the frequency or the preset number.

**⑥ F/P (FREQUENCY / PRESET) button**  
During reception of AM or FM, you can change the function of the UP/DOWN buttons for scanning frequencies or selecting preset stations by pressing this button.

**⑦ MODE button**  
Press this button to select the auto stereo mode or mono mode when the FM band is selected. The "AUTO" indicator lights in the auto stereo mode.

**⑧ Infrared receiving (IR) sensor window**  
This window receives infrared signals for the remote control unit.

**⑨ VOLUME control knob**  
Adjusts the overall sound level. Turning the control clockwise increases the sound level.

**⑩ INPUT FUNCTION SELECTOR buttons (AUDIO/ VIDEO)**  
These buttons are used to select the input sources. The video function selector, such as TV, DVD, VCR1 and DSS/VCR2, selects video and audio simultaneously. Audio function sources such as CD, TAPE, CDR/MD, TUNER, and 6.1CH-IN may be selected in conjunction with a Video source.

This feature (Sound Injection) combines a sound from one source with a picture from another. Choose the video source first, and then choose a different audio source to activate this function. Press **TUNER** button to switch the between FM or AM.

**⑪ 6.1CH IN button**  
Press this button to select the output of an external multi channel decoder. Press this button again to return the previous function.

**⑫ PHONES jack for stereo headphones**  
This jack may be used to listen to the SR4400's output through a pair of headphones. Be certain that the headphones have a standard 1 / 4" stereo phone plug. Note that the speakers will automatically be turned off when the headphone jack is in use.

**Notes:**

- When using headphones, the surround mode will automatically change to STEREO.
- The surround mode returns to the previous setting as soon as the plug is removed from the jack.

**⑬ A/D (Analog/Digital) SELECTOR button**  
This is used to select between the analog and digital inputs.

**Note:**

- This button is not used for an input source that is not set to a digital input in the system setup menu.

**⑭ HT-EQ button**  
Used to turn on or off HT (Home Theater)-EQ mode when the surround mode is set as AUTO, DOLBY, DTS or STEREO. This mode compensates for the audio portion of a movie sounding "bright". When this button is pressed, "EQ" indicator lights up.

**⑮ S- (Source) DIRECT button**  
When this button is pressed, the tone control circuitry is bypassed as well as Bass Management.

**Notes:**

- The surround mode is automatically switched to AUTO when the source direct function is turned on.
- S-DIRECT is turned off when the other surround mode is selected with the SURROUND mode selector knob or the surround mode buttons of the remote controller.

- Additionally, Speaker Configurations are fixed automatically as follow.  
(Front SPKR = Large, Center SPKR = Large, Surround SPKR = Large, Sub woofer = On)

**⑯ DISPLAY button**  
When this button is pressed once, the display is dimmed. When this button is pressed twice, the display is turned off and "DISP" indicator lights up. Press this button again to turn the display ON again.

**⑰ MUTE button**  
Press this button to mute the output to the speakers and headphones. Press it again to return to the previous volume level.

## FL DISPLAY

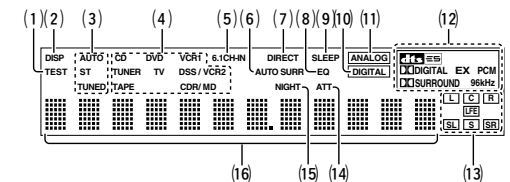

**(1) TEST tone indicator**  
This indicator blinks in generating the test tone in speaker level setup.

**(2) DISP (Display Off) indicator**  
This indicator lights when the SR4400 is in the display off condition.

**(3) TUNER's indicators**  
**AUTO** : This indicator illuminates when the tuner's Auto mode is in use.  
**ST(Stereo)** : This indicator illuminates when an FM station is being tuned in stereo condition.  
**TUNED** : This indicator illuminates when a station is being received with sufficient signal strength to provide acceptable listening quality.

**(4) INPUT SOURCE indicators**  
These indicators show the current input source.

**(5) 6.1 CHANNEL DIRECT IN indicator**

This indicator lights up when the 6.1CH-IN has been selected as a input source.

**(6) AUTO.SURR (Auto Surround mode) indicator.**

This indicator illuminates to show that the AUTO SURROUND mode is in use.

**(7) DIRECT (Source direct) indicator**

This indicator lights when the SR4400 is in the SOURCE DIRECT mode.

**(8) EQ mode indicator**

This indicator lights when the HT-EQ function is active.

**(9) SLEEP timer indicator**

This indicator lights when the seep timer function is in use.

**(10) DIGITAL Input Indicator**

This indicator lights when digital input has been selected.

**(11) ANALOG input indicator**

This indicator lights when an analog input source has been selected.

**(12) SIGNAL FORMAT indicators**

**DIGITAL, EX, SURROUND, dts, ES, PCM and 96kHz**

When the selected input is a digital source, some of these indicators will light to display the specific type of signal in use.

**(13) ENCODED CHANNEL STATUS indicators**

These indicators display the channels that are encoded with a digital input signal. If the selected digital input signal is Dolby Digital 5.1ch or DTS 5.1ch, "L", "C", "R", "SL", "SR" and "LFE" will light up. If the digital input signal is 2 channel PCM-audio, "L" and "R" will be displayed.

If Dolby Digital 5.1ch signal with Surround EX flag or DTS-ES signal comes in, "L", "C", "R", "SL", "S", "SR" and "LFE" will show.

**(14) ATT (Attenuation) indicator**

This indicator lights when the attenuation function is active.

**(15) NIGHT mode indicator**

This indicator lights when the SR4400 is in the Night mode, which reduces the dynamic range of digital program material at low volume levels.

**(16) Main Information Display**

This display shows messages relating to the status, surround mode, tuner, volume level or other aspects of unit's operation.

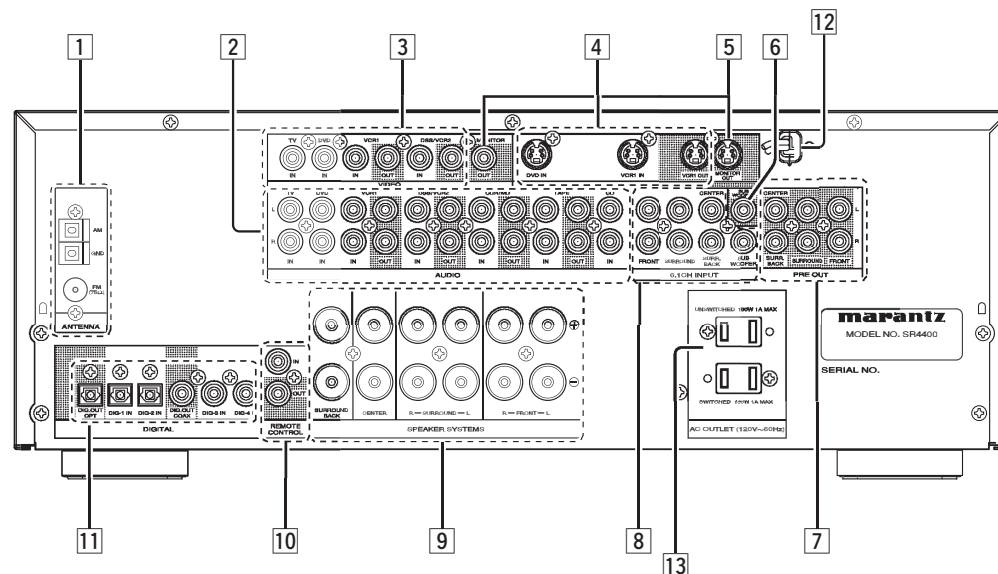
**REAR PANEL****1 FM antenna terminal (75 ohms)**

Connect an external FM antenna with a coaxial cable, or a cable network FM source.

**AM antenna and ground terminals**

Connect the supplied AM loop antenna. Use the terminals marked "AM" and "GND". The supplied AM loop antenna will provide good AM reception in most areas. Position the loop antenna until you hear the best

**2 AUDIO IN/OUT (CD, TAPE, CDR/MD, TV, DVD, VCR1, DSS/VCR2)**

These are the analog audio inputs and outputs. There are 7 audio inputs (4 of which are linked to video inputs) and 4 audio outputs (2 of which are linked to video outputs). The audio jacks are nominally labeled for cassette tape decks, compact disc players, DVD players and etc.... The audio inputs and outputs require RCA-type connectors.

**3 VIDEO IN/OUT (TV, DVD, VCR1 and DSS/VCR2)**

There are 4 composite video inputs and 2 composite video outputs. Connect VCR, DVD player, and other video components to the video input.

The output channels can be used to be connected to video recorder for making recordings.

**4 S-VIDEO IN/OUT**

There are 2 S-VIDEO inputs and one S-VIDEO output.

Connect VCR, DVD player, and other video components to the S-VIDEO input.

The output channel can be used to be connected to video recorder for making recordings.

S-VIDEO sources can be viewed through the S-VIDEO output, and composite sources can only be viewed through the composite output.

**5 MONITOR OUT**

There are 2 monitor outputs and each one includes both composite video and S-video configurations.

**6 Subwoofer Output**

Connect this jack to the line level input of a powered subwoofer. If an external subwoofer amplifier is used, connect this jack to the subwoofer amplifier input. If you are using two subwoofers, either powered or with a 2 channel subwoofer amplifier, connect a "Y" connector to the subwoofer output jack and run one cable from it to each subwoofer amplifier.

**7 Preamp Outputs (L, R, SL, SR, SB, C)**

Jacks for L (front left), R (front right), C (Center), SL (surround left), SR (surround right) and SB (surround back). Use these jacks for connection to some external power amplifiers.

**8 6.1 CHANNEL INPUT**

By connecting a DVD Audio player, SACD multi channel player, or other component that has a multi channel port, you can playback the audio with 5.1 channel or 6.1 channel output.

**9 Speaker outputs terminals**

Six terminals are provided for the front left, front right, front center, surround left, surround right and surround back speakers.

**10 REMOTE CONT. IN/OUT terminals**

Connect to a Marantz component equipped with remote control (RC-5) terminals.

**11 DIGITAL INPUT (Dig.1 - 4) / OUTPUT (coaxial, optical)**

These are the digital audio inputs and outputs. There are 2 digital inputs with coaxial jacks, 2 with optical jacks. The inputs accept digital audio signals from a compact disc, LD, DVD, or other digital source component. For digital output, there is 1 coaxial output and 1 optical output. The digital outputs can be connected to MD recorders, CD recorders, DAT decks, or other similar components.

**12 Power cable**

Connect to AC power outlet. SR4400 can be powered by 120 V AC only.

**Caution:**

- In order to avoid potential turn-off thumps, anything plugged in here should be powered up before the SR4400 is turned on.

**13 AC OUTLETS**

Connect the AC power cables of components such as a DVD and CD player to these outlets. SWITCHED and UNSWITCHED outlets are provided.

The one marked SWITCHED provides power only when the SR4400 is turned on and is useful for components which you use every time you play your system.

The one marked UNSWITCHED is always live as long as the SR4400 is plugged into a live outlet.

A component connected here may be left on permanently, or may be switched off with its own power switch.

**Caution:**

- In order to avoid potential turn-off thumps, anything plugged in here should be powered up before the SR4400 is turned on.
- The capacity of these AC outlets are 100W. Do not connect devices that consume electricity more than the capacity to these AC outlets. If total power consumption of connected devices exceeds the capacity, protection circuit shuts down the power supply.

**REMOTE CONTROL OPERATION**

**FUNCTION AND OPERATION**

The provided remote control unit is a universal remote controller. The **POWER** button, numeric buttons and control buttons are used in common across different input source components.

The input source controlled with the remote control unit changes when one of the input selector buttons is pressed.

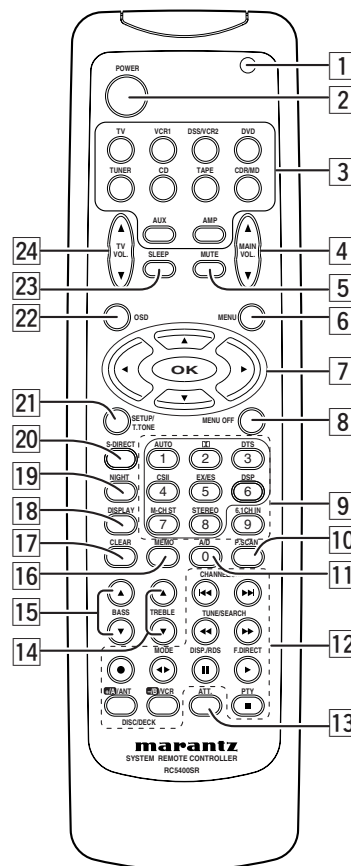

**1 Transmitting indicator**

Lights up during a button is pressed and an infrared signal is sending.

**2 (Main) POWER buttons**

Press to switch the power of the SR4400 ON or OFF after pressing the **AMP** button.

**3 Input selector buttons/ FUNCTION SELECTOR buttons (AUDIO/VIDEO INPUT)**

These buttons are used to select a Audio or Video source component. Press one of these buttons once to change the function of the remote control. Press same button within 2 seconds, the input function of the SR4400 is changed.

**Note:**

- CDR/MD button is set CDR function at initial. To switch MD function, press and hold down **CDR/MD** button and press **2** button.
- To return CDR function, press and hold down **CDR/MD** button and press **1** button.
- **AUX** button is unavailable for SR4400.

**4 MAIN VOLUME UP (▲) /DOWN (▼) buttons**

Main volume control of the SR4400. The front, surround, center and subwoofer channel volumes controlled by these buttons simultaneously.

**5 MUTE button**

Muting button of the SR4400. Press this button decrease the sound temporarily. Press this button again to return to the previous sound. When this button is pressed, "MUTE" indicator lights up.

**6 MENU button**

This button is used to enter the SETUP MAIN MENU.

**7 Cursor buttons (◀, ▶, ▲, ▼, OK)**

Use these button when operating the SETUP MAIN MENU. See page 15.

**8 MENU OFF button**

This button is used to exit from the SETUP MAIN MENU.



## 9 Numeric buttons 1 to 9 (A, B, C ... Z, -) / Surround mode buttons

### Numeric buttons

These buttons are used to enter figures in the selection of a tuner preset station and station name preset or to set select a CD track number, etc. The functions of these buttons are dependent on the function button selected.

### Surround mode buttons (when AMP mode is selected)

These buttons are used to select the surround mode.

#### Note:

- The surround mode is set to 6-Stereo mode by pressing **M-CH ST** button.

## 10 P.SCAN (preset scan) button (when TUNER mode is selected)

This button is used to start preset scan when SR4400 is selected TUNER mode.

## 11 0 / A/D button

### 0 button

This button is used to enter the number "0"

### A/D button (when AMP mode is selected)

This is used to switch between the analog and digital inputs.

## 12 CONTROL buttons

These buttons are used when operating the CD player, TAPE deck, etc. The function of these buttons are dependent on the function button selected.

For the controllable functions of each input function, please refer to controllable function table on the page 9.

## 13 ATT (attenuator) button

When the input signal is too high and the voice distorts even by throttling the SR4400 VOLUME control, turn on this function. "ATT" is indicated when this function is activated.

The input level is reduced. Attenuator is invalid for use with the output signal of "REC OUT".

#### Note:

- This function is unavailable during the digital input is selected.

## 14 TREBLE UP (▲) /DOWN (▼) buttons

These buttons are used to adjust the tone control of high frequency sound for left and right speaker.

## 15 BASS UP (▲) /DOWN (▼) buttons

These buttons are used to adjust the tone control of low frequency sound for left, right and subwoofer speaker.

## 16 MEMO button

Memory enable button for various preset functions.

## 17 CLEAR button

This button is used to cancel for certain memory or programming operations.

## 18 DISPLAY button

When this button is pressed once, the display is dimmed.

When this button is pressed twice, the display is turned off and the "DISPLAY OFF" indicator lights up.

Press this button again to turn on the display again.

## 19 NIGHT button

Pressing this button prevents the Dolby Digital signal from playback at a loud voice. This function reduces the voice by 1/3 to 1/4 at maximum. Thus, it eliminates the occurrence of an abruptly loud voice at night. However, the function is valid only for the case when the Dolby Digital signal is entered into OPTICAL or COAXIAL and data to compress the voice exists in the signal to be played back.

When this button is pressed, "NIGHT" indicator lights up.

## 20 S- ( Source) DIRECT button

When this button is pressed, the tone control circuit is bypassed as well as Bass Management.

## 21 SETUP / T.TONE button

Test tone function is used for adjusting the balance between the volume levels of speaker channels. Press **AMP** button and press this button to enter the test tone mode.

## 22 OSD button

#### Note:

- This button is unavailable for SR4400.

## 23 SLEEP (sleep timer) button

This button is used for setting the sleep timer. It can be operated the same way as the button in unit.

## 24 TV VOLUME UP (▲) /DOWN (▼) buttons

These buttons increase or decrease TV's volume.

## PROGRAMMING THE REMOTE CONTROLLER

The remote controller RC5400SR must be programmed to use the codes for your appliances of different brands. This is done by keying in a 4-digit code or by scanning the codes until the correct one is found. We recommend to using the 4-digit code. This mode is faster and more reliable. The code scanning method should be used only if you cannot find the code for one of your appliances. The codes are listed at the end of this book.

#### Important:

- Use the remote control buttons for programming, not the buttons of the receiver or other appliances.
- Some codes may be not match your equipment. In this case, your equipment cannot be controlled with this remote controller.

## PROGRAMMING WITH THE 4-DIGIT CODE

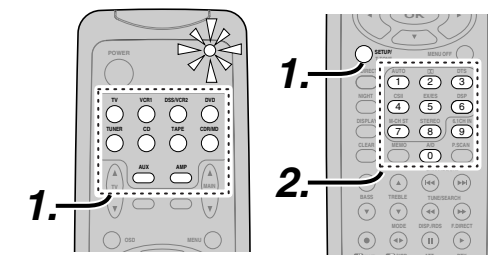

- Press and hold down the function button for the appliance which should be controlled and press **SETUP** until the indicator blinks twice.
- Press the 4-digit code for appliance (code table at the end of this book)
- When the procedure is successful, the indicator will blink twice.

#### Note:

- If the indicator did not blink twice, then repeat steps 1 through 2 and try entering the same code again.

**SCANNING THE CODE TABLE**

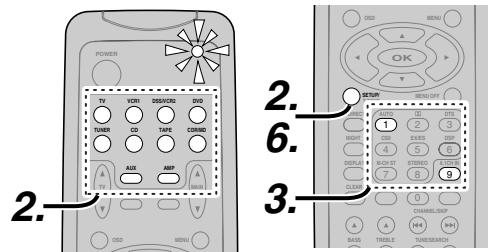

1. Switch on the appliance which should be controlled.
2. Press and hold down the function button for appliance which should be controlled and press **SETUP** until the indicator blinking twice.
3. Press the code **9 - 9 - 1**. The indicator will blink twice.
4. Aim the remote control at the appliance and slowly alternate between pressing **POWER** and the function button for the appliance.
5. Stop when the appliance turns off.
6. Press **SETUP** once to lock in the code.

**CHECKING THE CODE**

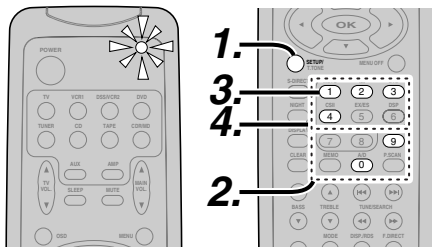

1. Press and hold down the function button for appliance which should be controlled and press **SETUP** until the indicator blinking twice.
2. Press the code **9 - 9 - 0**. The indicator will blink twice.
3. To view the code for first digit, press **1** once. Wait 3 seconds, count the indicator blinks (e.g. 3 blinks = 3) and write down the number.  
**Note:** If a code digit is "0", the indicator will not blink.
4. Repeat step 3 three more times for remaining digits. Use **2** for the second digit, **3** for the third digit, and **4** for the fourth digit.

**RESETTING THE ALL CODE**

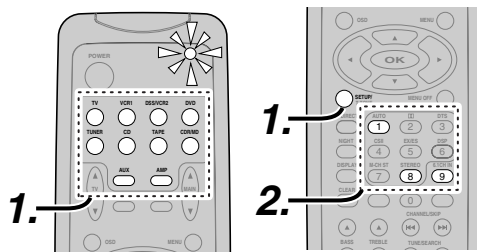

1. Press and hold down the any function button and press **SETUP** until the indicator blinking twice.
  2. Press the code **9 - 8 - 1**. The indicator will blink twice. Then, RC5400SR will return to the factory preset code.
- Note:** After this procedure, the selected function button is set initial code and other function buttons are set initial code too.

Once you have found and the codes for your various appliances, you may want to write them down here.

- TV -----
- VCR -----
- DSS -----
- DVD -----
- CD -----
- TAPE -----
- CDR -----
- MD -----

**OPERATION OF REMOTE CONTROL UNIT**

**REMOTE CONTROL**

The distance between the transmitter of the remote control unit and the IR SENSOR of the SR4400 should be less than about 5 meters. If the transmitter is pointed to a direction other than the IR SENSOR or if there is an obstacle between them, remote control may not be possible.

3. Close until it clicks.

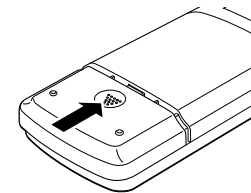

**Remote-controllable range**

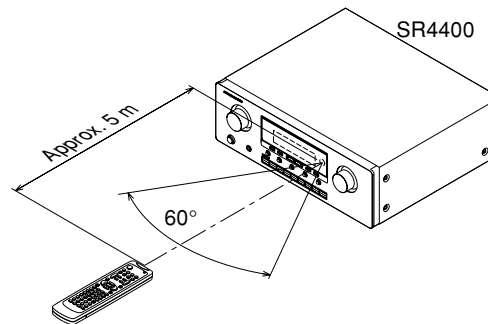

Remote control unit (RC5400SR)

**LOADING BATTERIES**

The life of the batteries used with the remote control unit is about 4 months with normal use. Also be sure to replace batteries earlier when you notice that they are getting weak.

1. Remove the back cover.

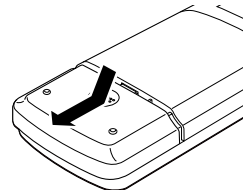

2. Insert the new batteries (AAA type) with correct  $\oplus$  and  $\ominus$  polarity.

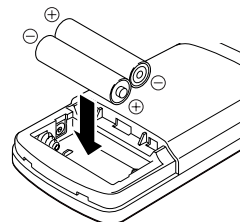

## GENERAL INFORMATION OF RC5400SR TO SR4400

To control the SR4400 by your RC5400SR, you have to select the device AMP or TUNER by function selector button. Please refer as below for the details in AMP and TUNER mode.

### AMP MODE

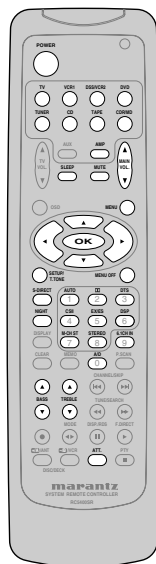

POWER	Turns the SR4400 on and off
Function selector *	Selects a particular source component AUX button is unavailable for SR4400.
SLEEP *	Sets the sleep timer function
MUTE *	Decreases the sound temporarily
VOL ▲▼ *	Adjusts the over all sound level
MENU	Enters the SETUP MENU
Cursor	Moves the cursor for setting in SETUP MENU
OK	• Enters the SETUP MENU • Confirms the setting in SETUP MENU
SETUP/T.TONE	Enters the test tone mode for setting the Speaker Level Setup
MENU OFF	Exits from the SETUP MENU
S-DIRECT *	Selects the Source Direct mode
NIGHT *	Turns on or off NIGHT mode
Surround mode (1-8)	Selects the surround mode
6.1CH-IN (9)	Selects the 6.1CH IN
A/D (0)	Switches between the analog and digital inputs
BASS ▲▼ *	Adjusts the tone control of low frequency sound
TREBLE ▲▼ *	Adjusts the tone control of high frequency sound
ATT *	Reduces the input level

\* These buttons are used to control SR4400 in any function mode.

### TUNER MODE



TUNER	Selects a frequency band
0-9	Inputs the numeric
CLEAR	Clears the inputting
MEMO	Enters the tuner preset memory numbers
P.SCAN	Starts preset scan
CHANNEL/SKIP	• Selects a preset station • Changes a PTY type
◀◀ / ▶▶	
TUNE/SEARCH	Tunes a station
◀◀ / ▶▶	
MODE ◀▶	Selects the auto stereo mode or mono mode
F.DIRECT ▶	Selects the "Frequency direct input"

## THE CONTRABLE FUNCTION TABLE



	TV	VCR	DVD	DSS	CD	TAPE	CDR	MD
POWER	POWER	POWER	POWER	POWER	POWER	POWER	POWER	POWER
MENU	CALL UP MENU	CALL UP MENU	CALL UP MENU	CALL UP MENU	-	-	-	-
Cursor	Cursor	Cursor	Cursor	Cursor	-	-	-	-
OK	OK	OK	OK	OK	-	-	-	-
SETUP/T.TONE	-	-	SETUP MENU	-	-	-	-	-
MENU OFF	-	CANCEL MENU	-	CANCEL MENU	-	-	-	-
0 - 9	INPUT NUMERIC	INPUT NUMERIC	INPUT NUMERIC	INPUT NUMERIC	INPUT NUMERIC	INPUT NUMERIC	INPUT NUMERIC	INPUT NUMERIC
CLEAR	INPUT CLEAR	TAPE SPEED	INPUT CLEAR	-	INPUT CLEAR	INPUT CLEAR	INPUT CLEAR	INPUT CLEAR
MEMO	-	-	CALL PROGRAM	-	CALL PROGRAM	CALL PROGRAM	-	CALL PROGRAM
CHANNEL/SKIP ◀◀	CH-	PREV	PREV	-	PREV	PREV	PREV	PREV
CHANNEL/SKIP ▶▶	CH+	NEXT	NEXT	-	NEXT	NEXT	NEXT	NEXT
TUNE/SEARCH ◀◀	-	REWIND	REWIND	-	REWIND	REWIND	REWIND	REWIND
TUNE/SEARCH ▶▶	-	FF	FF	-	FF	FF	FF	FF
● (REC)	-	REC	-	-	-	REC	REC	REC
MODE ◀▶	-	-	-	-	-	DIRECTION	-	-
DISP/RDS ■	CH DISPLAY	PAUSE	PAUSE	-	PAUSE	PAUSE	PAUSE	PAUSE
F.DIRECT ▶	-	PLAY	PLAY	-	PLAY	PLAY	PLAY	PLAY
+A/ANT	VIDEO	TV/VCR	DISC+	-	DISC+	DECK A	-	-
+B/VCR	VIDEO	TV/VCR	DISC+	-	DISC-	DECK B	-	-
PTY ■	-	STOP	STOP	-	STOP	STOP	STOP	STOP

# CONNECTIONS

## SPEAKER PLACEMENT

The ideal surround speaker system for this unit is 7-speaker systems, using front left and right speakers, a center speaker, surround left and right speakers, a surround back and a subwoofer.

For best results we recommend that all front speakers be of the same type, with identical or similar driver units. This will deliver smooth pans across the front sound stage as the action moves from side to side.

Your center channel speaker is very important as over 80 % of the dialog from a typical motion picture emanates from the center channel.

It should possess similar sonic characteristics to the main speakers. Surround channel speakers need not be identical to the front channel speakers, but they should be of high quality.

The surround center speaker is useful for playback of Dolby Digital Surround EX or DTS-ES. One of the benefits of both Dolby Digital (AC-3) and DTS is that surround channels are discrete full range, while they were frequency limited in earlier "Pro Logic" type systems.

Bass effects are an important part of home theater. For optimal enjoyment a subwoofer should be used as it is optimized for low frequency reproduction. If you have full range front speakers, however, they may be used in place of a subwoofer with proper setting of the switches in the menu system.

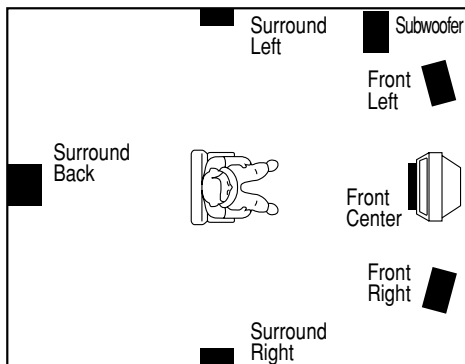

### Front left and right speakers

We recommend to set the front L and R speakers with 45-60 degrees from the listening position.

### Center speaker

Align the front line of the center speaker with the front L/R speakers. Or place the center speaker a little backward from the line.

### Surround left and right speakers

Place the speakers right beside of the listening position or a little forward. Do not place the speakers backward of the listening position.

### Surround back speaker

Place the speaker behind of the listening position.

### Subwoofer

We recommend to use a sub-woofer to have maximum bass effect. Sub-woofer bears only low frequency range so you can place it anywhere in the room.

### HEIGHT OF THE SPEAKER UNITS

#### Front left and right speakers, and a center speaker

Align the tweeters and mid-range drivers on the three front speakers on the same height as well as possible.

#### Surround left and right speakers, and surround back speaker

Place the surround left, right and surround back speakers higher to your ears (2 Ft. - 3 Ft. (70cm - 1m)). Also place the speakers on the same height.

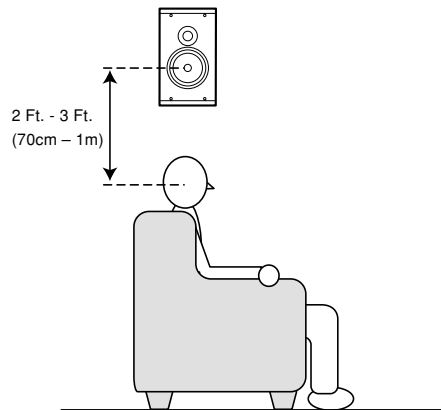

#### Note:

- Use magnetically-shielded speakers for front left, right and the center speakers when the speakers are installed near the TV and the TV is a monitor type.

## CONNECTING SPEAKERS

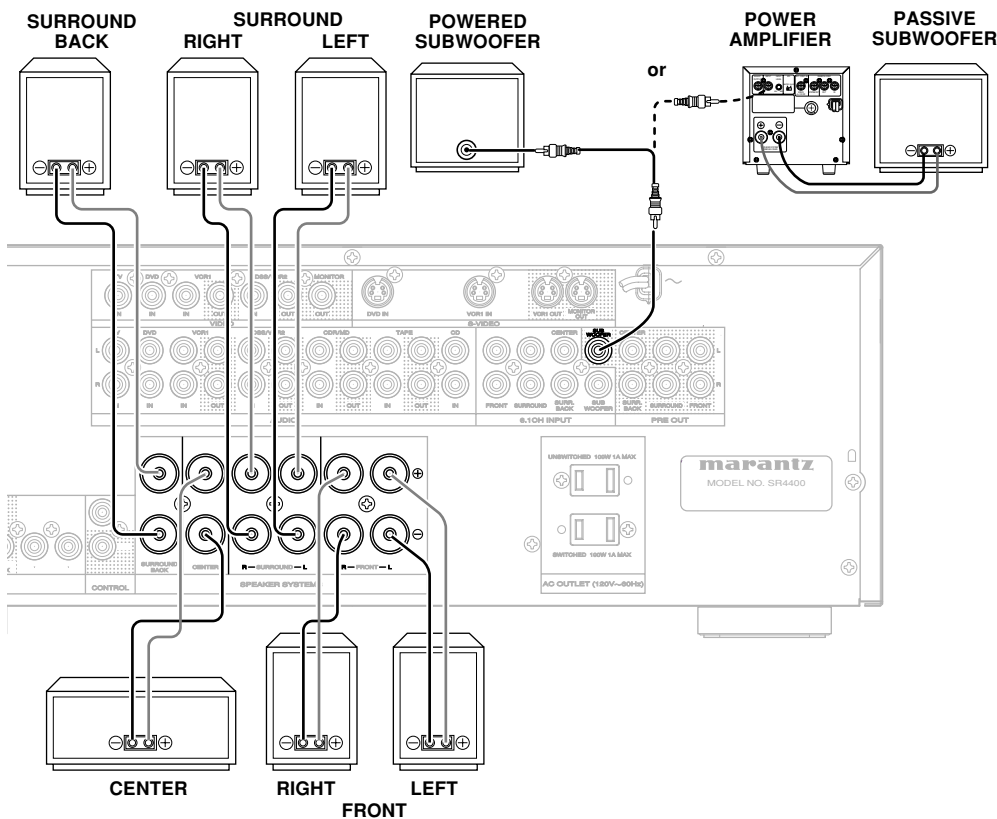

### CONNECTING BANANA PLUG

Banana plug connections are also possible. Tighten the knob by turning clockwise and then insert the banana plug.

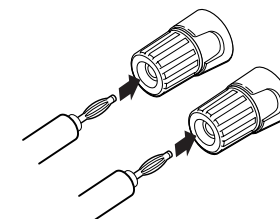

**CONNECTING SPEAKER WIRE**

1. Strip away approx. 10 mm of wire insulation.
2. Twist the bared wire ends tight to prevent short circuits.
3. Loosen the knob by turning counterclockwise.
4. Insert the bare part of the wire into the hole in the side of each terminal.
5. Tighten the knob by turning clockwise to secure the wire.

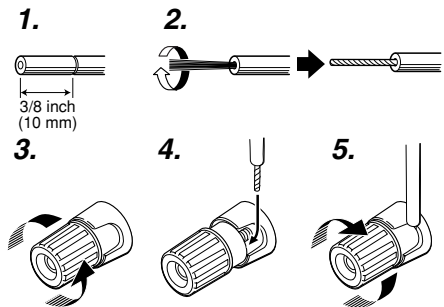

**Cautions:**

- Be sure to use speakers with the specified impedance shown on the rear panel of this unit.
- To prevent damage to circuitry, do not let the bare speaker wires touch each other and do not let them touch any metal part of this unit.
- Do not touch the speaker terminals when the power is on. It may cause electric shocks.
- Do not connect more than one speaker cable to one speaker terminal. Doing so may damage this unit.

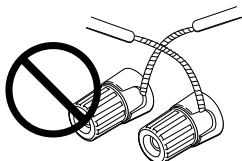

**Note:**

- Be sure to connect the positive and negative cables for the speaker properly. If they are miss-connected, the signal phase will be reversed and the signal quality will be corrupted.

**CONNECTING A SUBWOOFER**

Use the PRE OUT SUBWOOFER jack to connect a powered subwoofer (power amplifier built in). If your subwoofer is passive type (power amplifier is not built in), connect a monaural power amplifier to the PRE OUT SUBWOOFER jack and connect the subwoofer to the amplifier.

**CONNECTING AUDIO COMPONENTS**

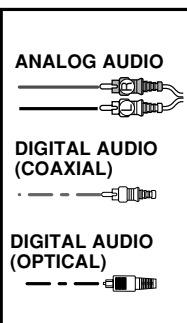
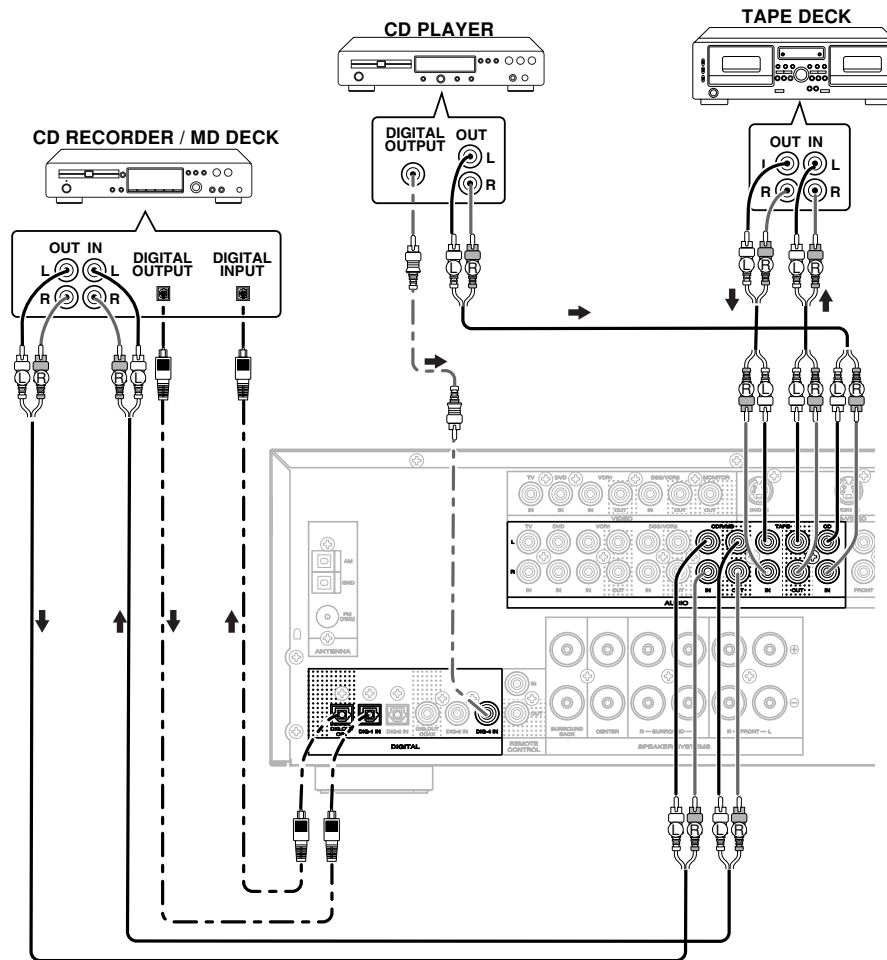

The output audio signal from the TAPE OUT jack and the CD-R/MD OUT jack is the sound source currently selected.

**Caution:**

- Do not connect this unit and other components to mains power until all connections between components have been completed.

**Notes:**

- Insert all plugs and connectors securely. Incomplete connections may make noise.
- Be sure to connect the left and right channels properly. Red connectors are for the R(right) channel, and white connectors are for the L(left) channel.
- Be sure to connect input and output properly.
- Refer to the instructions for each component that is connected with this unit.
- Do not bind audio/video connection cables with power cords and speaker cables will result in generating hum or other noise.

**CONNECTING DIGITAL AUDIO COMPONENTS**

- There are four digital inputs, two coaxial jacks and two optical jacks, on the rear panel. You can use these jacks to input PCM, Dolby Digital and DTS bitstream signals from a CD, DVD, or other digital source components.
- There are one digital output with coaxial jack and one with optical jack on the rear panel. These jacks can be connected to CD recorder, MD deck.
- Setup the digital audio format of DVD player, or other digital source component. Refer to the instructions for each component to be connected to digital input jacks.
- Use fiber optical cables(optical) for DIG-1,2 input jacks. Use 75 ohms coaxial cables(for digital audio or video) for DIG-3,4 input jacks.
- You can designate the input for each digital input/output jacks according to your component. See page 16.

**Notes:**

- There is no Dolby Digital RF input jack. Please use an external RF demodulator Dolby Digital decoder when connecting the Dolby Digital RF output jack of the video disc player to the digital input jack.
- The digital signal jacks on this unit conform to the EIA standard. If you use a cable that does not conform to this standard, this unit may not function properly.
- Each type of audio jack works independently. Signals input through the digital and analog jacks are output through the corresponding digital and analog jacks, respectively.

CONNECTING VIDEO COMPONENTS

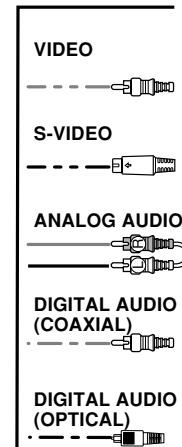
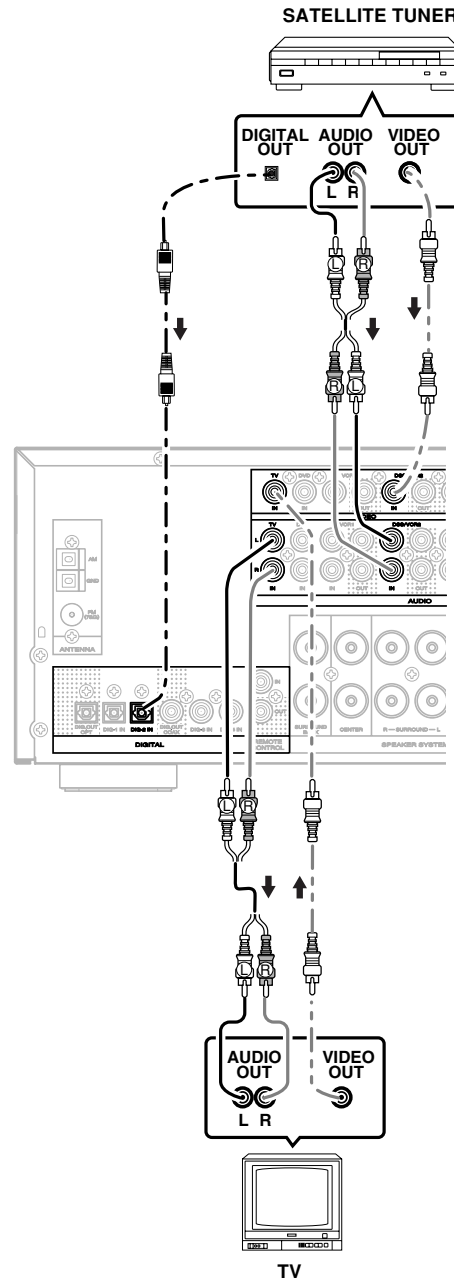
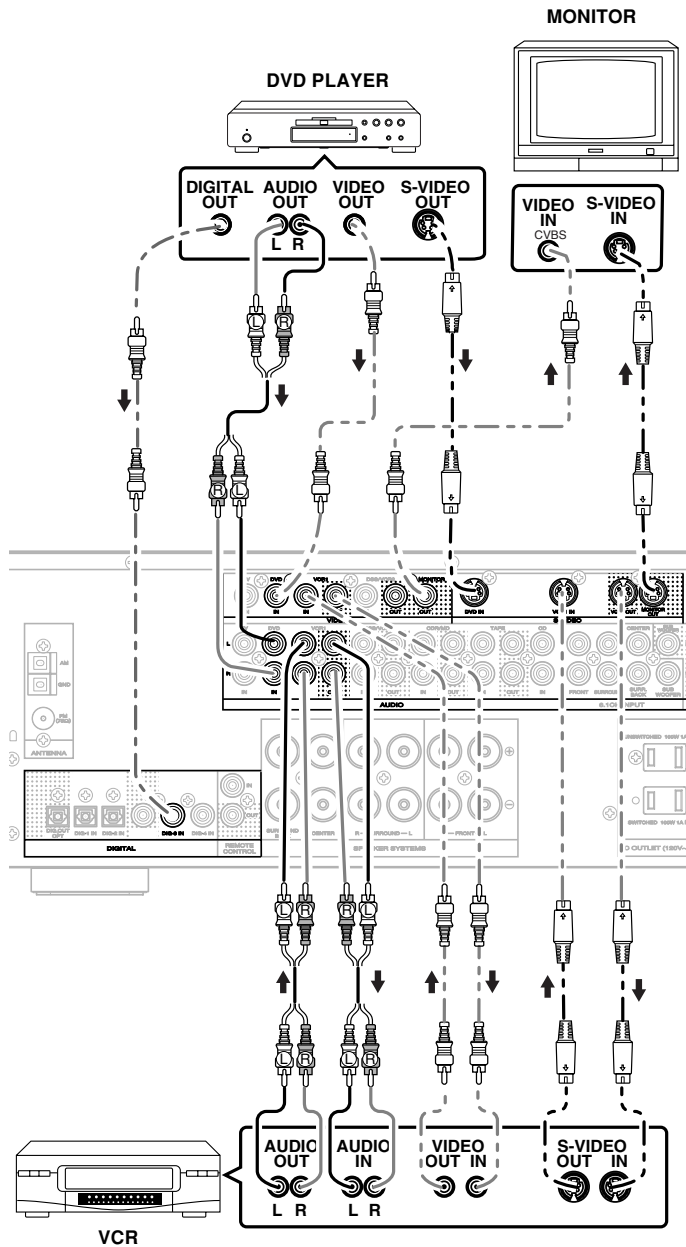

VIDEO, S-VIDEO JACKS

There are two types of video jacks on the rear panel.

VIDEO jack

The video signal for the VIDEO jacks is the conventional composite video signal.

S-VIDEO jack

The video signal is separated into luminance(Y) and color(C) signals for the S-VIDEO jack. The S-VIDEO signals enables high-quality color reproduction. If your video component has an S-VIDEO output, we recommend to use it. Connect the S-VIDEO output jack on your video component to the S-VIDEO input jack on this unit.

Notes:

- Be sure to connect the left and right audio channels properly.  
Red connectors are for the R(right) channel, and white connectors are for L(left) channel.
- Be sure to connect input and output of video signal properly.
- Each type of video jack works independently. Signals input to the VIDEO(composite) and S-VIDEO jacks are output to the corresponding VIDEO(composite) and S-VIDEO jacks, respectively.
- You may need to setup the digital audio output format of your DVD player, or other digital source component. Refer to the instructions of the each component connected to the digital input jacks.
- There is no Dolby Digital RF input jack. Please use an external RF demodulator with Dolby Digital decoder to connect a video disc player with the Dolby Digital RF output jack to the digital input jack on this unit.

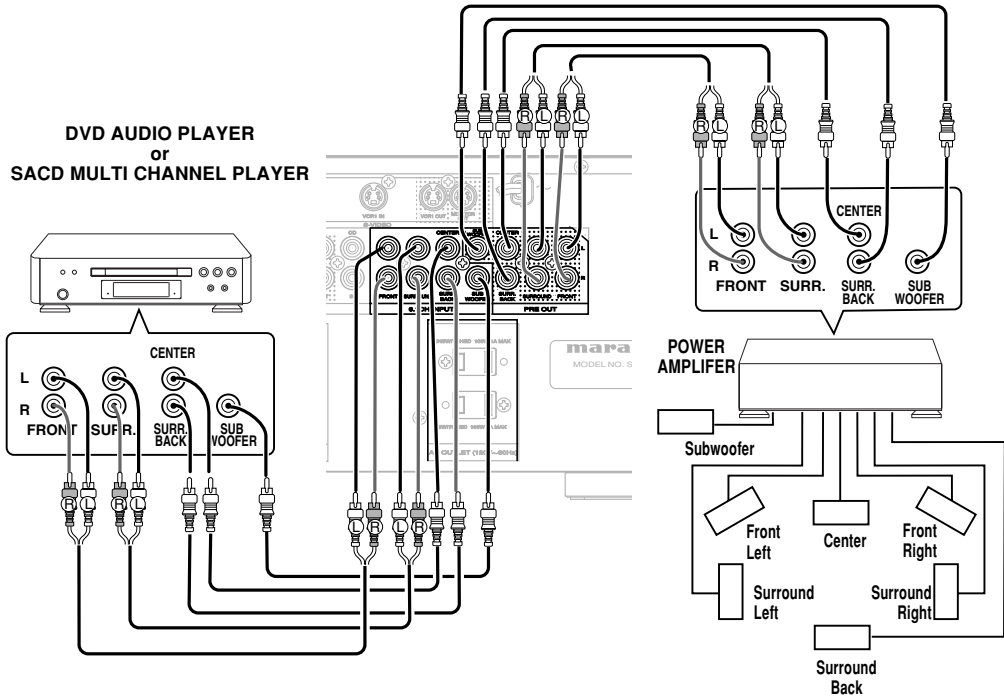

**CONNECTING MULTI CHANNEL AUDIO SOURCE**

The 6.1CH INPUT jacks are for multi channel audio source such as SACD multi channel player, DVD audio player or external decoder. If you use these jacks, switch on 6.1CH INPUT and setup 6.1CH INPUT level by using SETUP MAIN MENU. See page 20.

**CONNECTING EXTERNAL POWER AMPLIFIER**

The PREOUT jacks are for connecting external power amplifiers, you can have better sound quality. Be sure to connect each speaker to the corresponding external power amplifier.

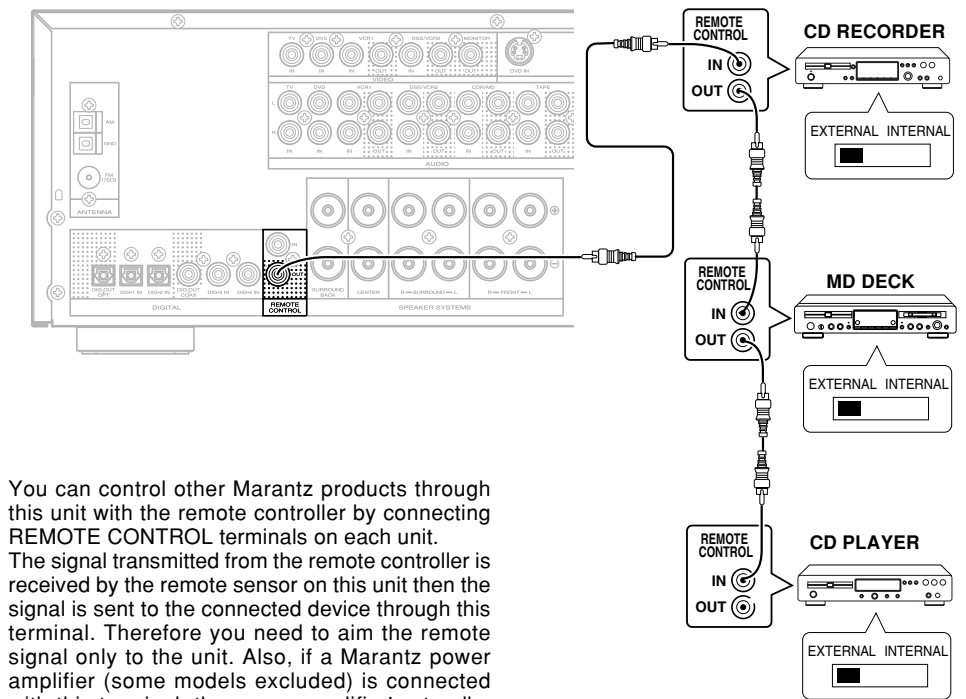

You can control other Marantz products through this unit with the remote controller by connecting REMOTE CONTROL terminals on each unit. The signal transmitted from the remote controller is received by the remote sensor on this unit then the signal is sent to the connected device through this terminal. Therefore you need to aim the remote signal only to the unit. Also, if a Marantz power amplifier (some models excluded) is connected with this terminal, the power amplifier's standby function is synchronized by pressing the **POWER** button on the remote.

Set the REMOTE CONTROL SWITCH on the units other than this unit to EXT.(EXTERNAL) for this feature.

## CONNECTING THE ANTENNA TERMINALS

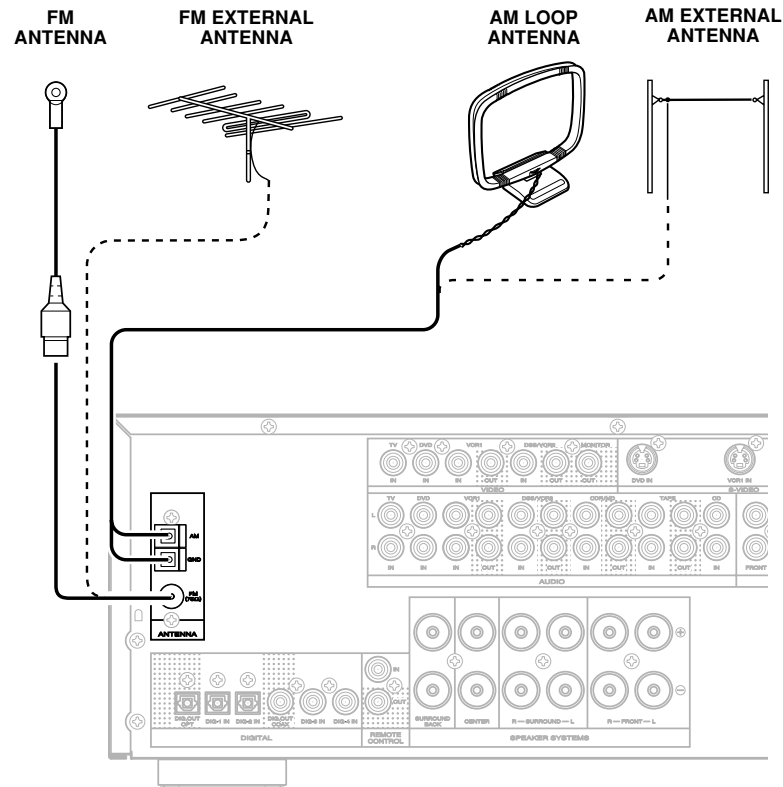

## ASSEMBLING THE AM LOOP ANTENNA

1. Release the vinyl tie and take out the connection line.
2. Bend in the reverse direction.
3. Inserting into the hole to attach the loop antenna to the antenna stand.
4. With the antenna on top any stable surface.

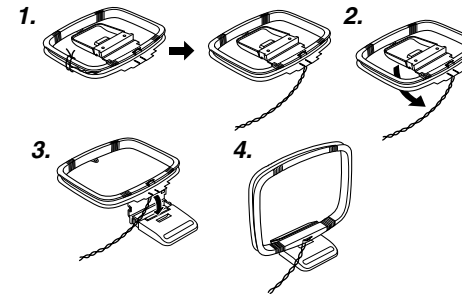

## CONNECTING THE SUPPLIED ANTENNAS

**Connecting the supplied FM antenna**

The supplied FM antenna is for indoor use only. During use, extend the antenna and move it in various directions until the clearest signal is received.

Fix it with push pin or similar implements in the position that will cause the least amount of distortion.

If you experience poor reception quality, an outdoor antenna may improve the quality.

**Connecting the supplied AM loop antenna**

The supplied AM loop antenna is for indoor use only.

Set it in the direction and position where you receive the clearest sound. Put it as far away as possible from the unit, televisions, speaker cables, and power cords.

If you experience poor reception quality, an outdoor antenna may improve the quality.

1. Press and hold down the lever of the AM antenna terminal.
2. Insert the bared wire into the antenna terminal.
3. Release the lever.

## CONNECTING AN FM OUTDOOR ANTENNA

**Notes:**

- Keep the antenna away from noise sources (neon signs, busy roads, etc.).
- Do not put the antenna close to power lines. Keep it well away from power lines, transformers, etc.
- To avoid the risk of lightning and electrical shock, grounding is necessary.

## CONNECTING AN AM OUTDOOR ANTENNA

An outdoor antenna will be more effective if it is stretched horizontally above a window or outside.

**Notes:**

- Do not remove the AM loop antenna.
- To avoid the risk of lightning and electrical shock, grounding is necessary.



# SETUP

After all components are connected, initial setup must be performed.

## SETUP MENU SYSTEM

The SR4400 incorporates a menu on the front display, which makes various operations possible by using the cursor ( $\blacktriangle$ ,  $\blacktriangledown$ ,  $\blacktriangleleft$ ,  $\blacktriangleright$ ) and **OK** buttons on the remote control.

## ENTER THE DESIRED MENU ITEM OF THE SETUP MENU

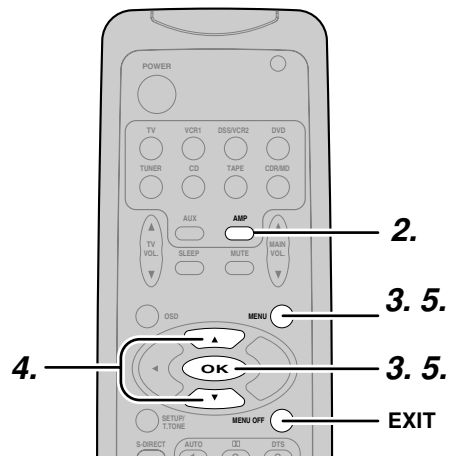

1. Turn on this unit.
2. Press the **AMP** button of the remote control to set the amp mode.
3. Press the **MENU** button or the **OK** button to enter the SETUP MENU. SIMPLE SETUP is displayed and you can enter the SIMPLE SETUP menu by pressing the **MENU** button or the **OK** button.
4. Press the  $\blacktriangle$  or  $\blacktriangledown$  cursor button to select the MAIN MENU item.
5. Press the **OK** button or the **MENU** button to enter the desired menu item.

After finishing all setup, press the **MENU OFF** button to exit the SETUP MENU.

## MENU STRUCTURE

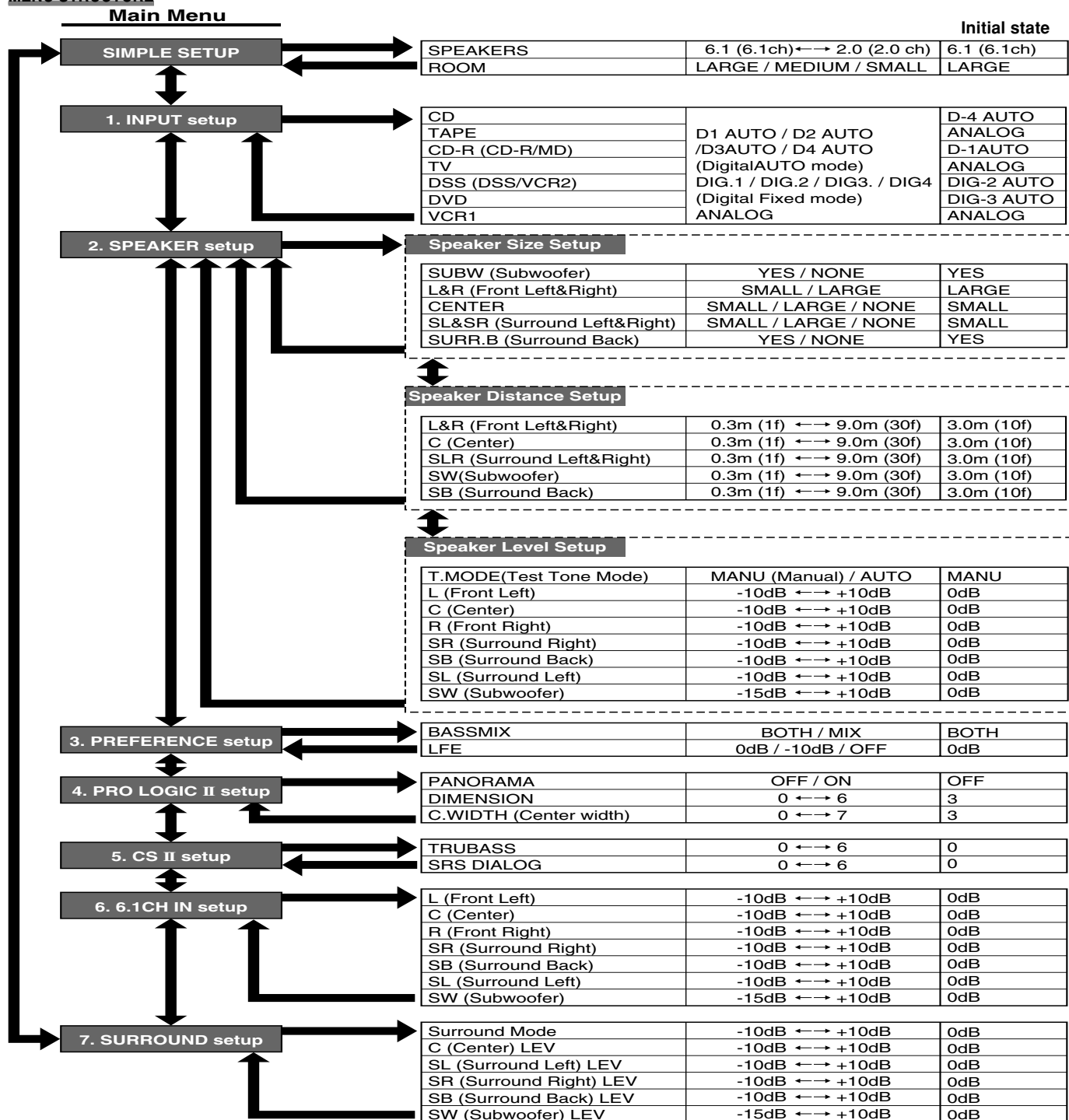

## SIMPLE SETUP

You can setup the speaker conditions quickly with SIMPLE SETUP menu. In this menu, the number of speakers and speaker delay time can be set. These settings can be changed more detail in "2. SPEAKER SETUP" menu.

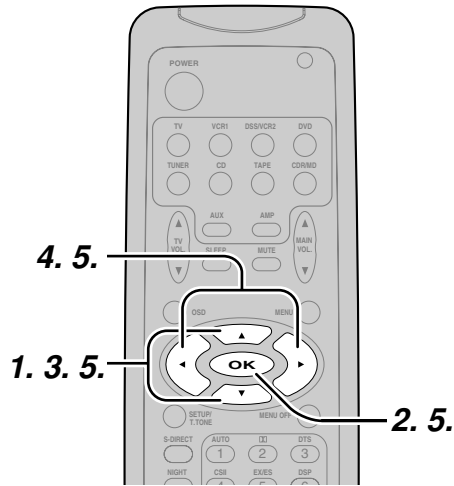

1. Select "SIMPLE SETUP" in SETUP MAIN MENU with the ▲ or ▼ cursor button.
2. Press the OK button to enter the menu.
3. Press the ▲ or ▼ cursor button to select a desired item.
4. Press ◀ or ▶ cursor button to select the speaker number or room size.
5. When you select "TO MAIN MENU" by pressing the ▲ or ▼ cursor button, you can return the SETUP MAIN MENU by pressing the OK button.  
Or press the ◀ or ▶ cursor button to select "EXIT", then press the OK button to exit the SETUP MENU.

**Note**

- All Simple Setup menu is reset when the speaker setting is changed with Speaker Setup menu.

### MENU STRUCTURE of Simple Setup

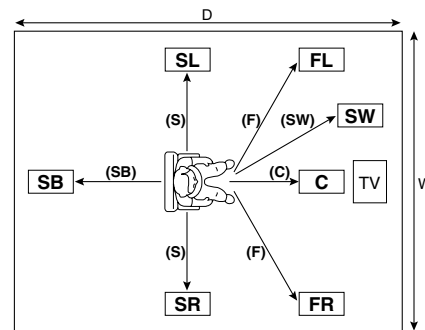
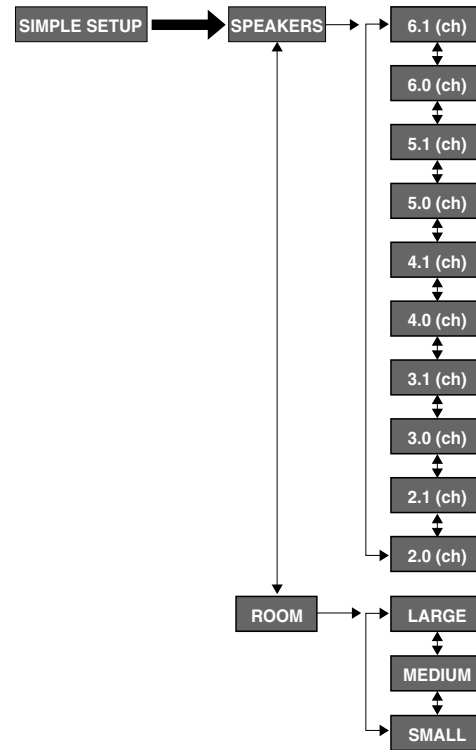

### The relation of the speakers number and connected speaker

CHANNEL	Front L/R (F)	Front Center (C)	Surround L/R (S)	Surround Back (SB)	Sub woofer (SW)
6.1 ch	LARGE	SMALL	SMALL	YES	YES
6.0 ch	LARGE	SMALL	SMALL	YES	NONE
5.1 ch	LARGE	SMALL	SMALL	NONE	YES
5.0 ch	LARGE	SMALL	SMALL	NONE	NONE
4.1 ch	LARGE	NONE	SMALL	NONE	YES
4.0 ch	LARGE	NONE	SMALL	NONE	NONE
3.1 ch	LARGE	SMALL	NONE	NONE	YES
3.0 ch	LARGE	SMALL	NONE	NONE	NONE
2.1 ch	LARGE	NONE	NONE	NONE	YES
2.0 ch	LARGE	NONE	NONE	NONE	NONE

### The relation of the room size and floor space

SIZE	Floor space	Width (W)	Depth (D)	Imaging Distance	
				Front (F)	Imaging Distance
SMALL	10 m <sup>2</sup>	2.7 m	3.6 m	Front (F)	6 ft. (1.8 m)
				Center (C)	5 ft. (1.5 m)
				Surround (S)	4 ft. (1.2 m)
				Sub Woofer (SW)	5 ft. (1.5 m)
MEDIUM	16 m <sup>2</sup>	3.6 m	4.5 m	Front (F)	7 ft. (2.1 m)
				Center (C)	6 ft. (1.8 m)
				Surround (S)	5 ft. (1.5 m)
				Sub Woofer (SW)	6 ft. (1.8 m)
LARGE	24 m <sup>2</sup>	4.5 m	5.4 m	Front (F)	9 ft. (2.7 m)
				Center (C)	8 ft. (2.4 m)
				Surround (S)	7 ft. (2.1 m)
				Sub Woofer (SW)	8 ft. (2.4 m)

The relation of the room size and floor space is a roughly standard.

## 1. INPUT SETUP (ASSIGNABLE DIGITAL INPUT)

Four digital inputs can be assigned as the desired source. Use this menu to select the digital input jack to be assigned to the input source. The Input Setup consists of 9 items, which are as below.

- **D1AUTO to D4AUTO : Digital AUTO mode**  
If the input signal from the selected source is digital signal, this unit chooses a digital input automatically.
- **DIG.1 to DIG.4 : Digital FIXED mode**  
The SR4400 chooses a digital input regardless of a input signal from the selected source.
- **ANA : Analog mode**

Use this menu to select the digital input jack to be assigned to the input source.

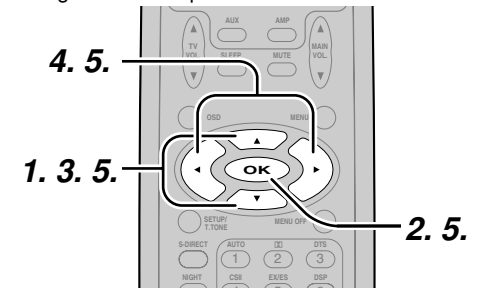

1. Select "1.INPUT" in SETUP MAIN MENU with the ▲ or ▼ cursor button.
2. Press the OK button to enter the menu.
3. Press the ▲ or ▼ cursor button to select the input source.
4. Press ◀ or ▶ cursor button to select the input function. Select "DxAUTO", "DIG.x" or "ANA" for input sources.
5. If you finish these setup, press the ▲ or ▼ cursor button to select "TO MAIN MENU" then press the OK button to return the SETUP MAIN MENU.  
Or press the ◀ or ▶ cursor button to select "EXIT" then press the OK button to exit the SETUP MENU.

**Notes:**

- When a DTS-LD or DTS-CD is playing, this setup is not available. This is to avoid noise being generated from the analog input.
- If “Dx-AUTO” is selected and a DVD, compact disc or LD is fast forwarded during playback, decoded signals may produce a skipping sound. In such cases, change the setting to DIGITAL.
- Same digital input function cannot be set. In this case, the previous setting is set to ANALOG. Same digital input number cannot be set in Digital AUTO mode and Digital Fixed mode. For example, D1AUTO and DIG.1 are not set at same time.

**2. SPEAKER SETUP**

After you have installed the SR4400, connected all the components, and determined the speaker layout, it is now time to perform the settings in the Speaker Setup menu for the optimum sound acoustics for your environment and speaker layout. Before you perform the following settings, it is important that you first determine the following characteristics:

**SPEAKER SIZE**

When setting the speaker size in the SPEAKER SIZE sub-menu, use the guidelines given below.

**Large:**

The complete frequency range for the channel you are setting will be output from the speaker.

**Small:**

Frequencies of the channel you are setting lower than approx. 100Hz will be output from the subwoofer.

If the Subwoofer is set to “NONE” and the front speakers are set to “Large,” then the sound may be output from both the left and right speakers.

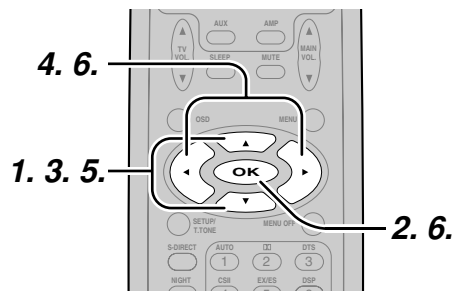

1. Select “2.SPEAKER” in SETUP MAIN MENU with ▲ or ▼ cursor button,
2. Press the OK button to enter the menu. The first sub-menu item is “Speaker Size” setup.
3. Press ▲ or ▼ cursor button to select the each speaker.
4. Press ◀ or ▶ cursor button to select the setting of size to each speaker.
5. If you finish these setup, press the ▲ or ▼ cursor button to select “NEXT”.
6. Press the OK button to enter the next “Speaker Distance” setup. Or press the ◀ or ▶ cursor button to select “EXIT” then press the OK button to exit the SETUP MENU. Or press the ◀ or ▶ cursor button to select “TO MAIN MENU” then press the OK button to return the SETUP MAIN MENU.

**MENU STRUCTURE of Speaker Size setup**

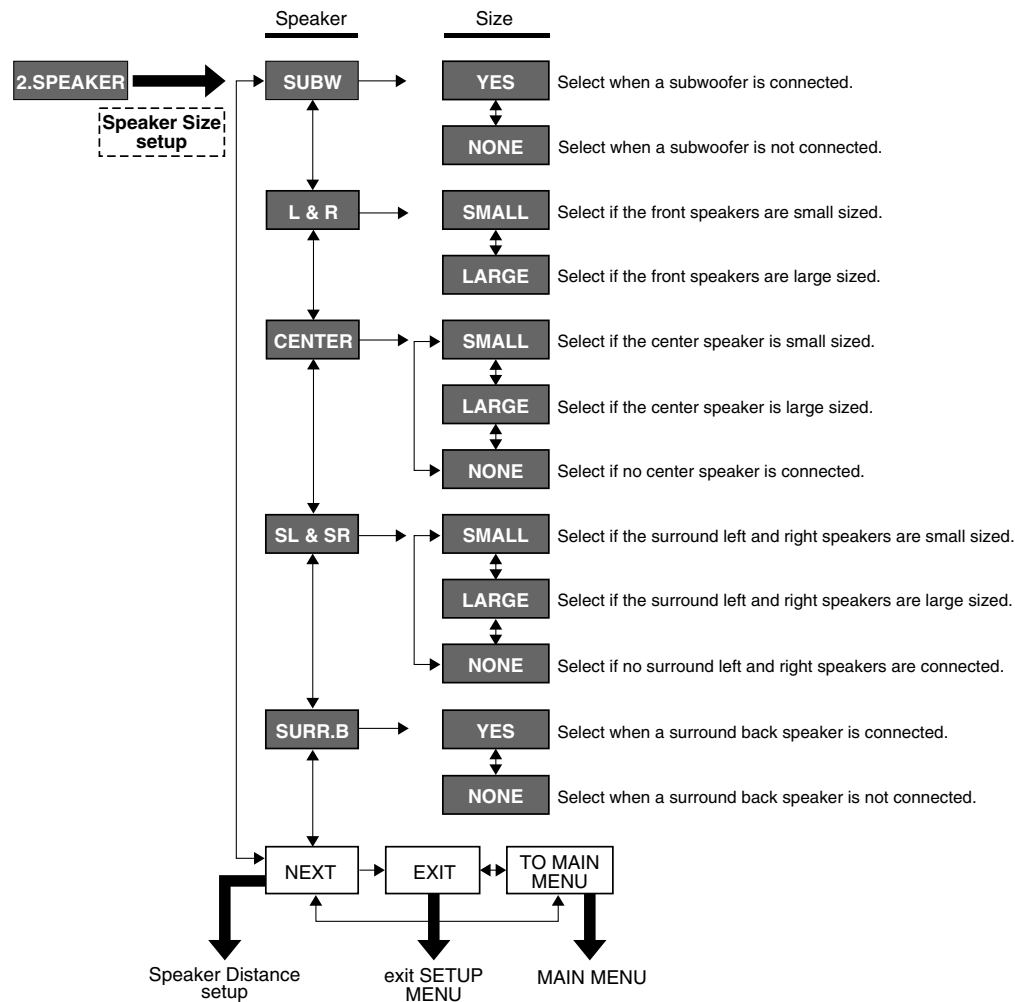

**SPEAKER DISTANCE**

Use this parameter to specify the distance of each speaker’s position from the listening position. The delay time is automatically calculated according to these distances. Begin by determining the ideal or most commonly used seating position in the room. This is important for the timing of the acoustics to create the proper sound space that the SR4400 and today’s sound systems are able to produce. Note that the speakers that you selected “None” for in the Speaker Config sub-menu will not appear here.

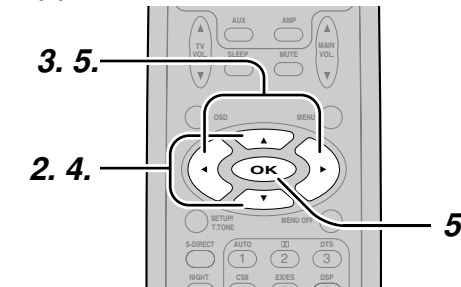

1. Enter to the “Speaker Distance setup” from the previous “Speaker Size setup”.
2. Press ▲ or ▼ cursor button to select the each speaker.
3. Press ◀ or ▶ cursor button to set the distance from your listening position for each speaker.
4. After finishing the Speaker Distance setup, press the ▲ or ▼ cursor button to select “NEXT”.
5. Press the OK button to enter the next “Speaker Level” setup. Or press the ◀ or ▶ cursor button to select “EXIT” then press the OK button to exit the SETUP MENU. Or press the ◀ or ▶ cursor button to select “TO MAIN MENU” then press the OK button to return the SETUP MAIN MENU. Or press the ◀ or ▶ cursor button to select “RETURN” then press the OK button to return the previous “Speaker Distance” setup.

**L&R :**  
Set the distance from the front left and right speakers to your normal listening position between 1 and 30 feet in 1.0 foot interval (0.3 to 9 meters in 0.3-meter intervals).

**C :**  
Set the distance from the center speaker to your normal listening position between 1 and 30 feet in 1.0 foot interval (0.3 to 9 meters in 0.3-meter intervals).

**SLR:**  
Set the distance from the surround left and right speaker to your normal listening position between 1 and 30 feet in 1.0 foot interval (0.3 to 9 meters in 0.3-meter intervals).

**SW :**  
Set the distance from the subwoofer to your normal listening position between 1 and 30 feet in 1.0-foot intervals (0.3 to 9 meters in 0.3-meter intervals).

**SB:**  
Set the distance from a surround back speaker to your normal listening position between 1 and 30 feet in 1.0-foot intervals (0.3 to 9 meters in 0.3-meter intervals).

**Note**  
• Speakers that you selected “No” or “None” for in the Speaker Size menu will not appear.

**MENU STRUCTURE of Speaker Distance setup**

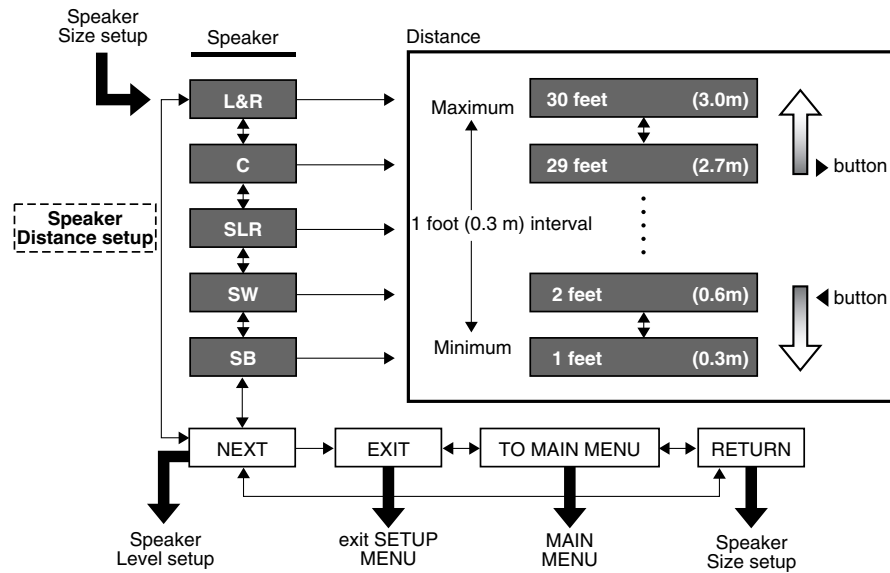

**SPEAKERS LEVEL**

Here you will set the volume for each speaker so that they are all heard by the listener at the same level.

**Note:**

- The speaker level settings is not available in 6.1channel input mode and S-Direct mode.

**TEST MODE :** Selects “MANU (manual)” or “AUTO” for generating mode of test tone ◀ or ▶ cursor button.

If you select “AUTO” by pressing the ▼ button, the test tone will be cycled through in a circular pattern which is L (Left) → C (Center) → R (Right) → SR (Surround Right) → SB (Surround Back) → SL (Surround Left) → SW (Subwoofer) → L →.. increments of 2 seconds for each channel.

Using the ◀ and ▶ cursor buttons, adjust the volume level of the noise from the speaker so that it is the same level for all speaker.

When you select “TO MAIN MENU” by pressing the OK button, you can return the SETUP MAIN MENU by pressing the OK button . Or press the ▲ or ▼ cursor button to select “EXIT” then press the OK button to exit the SETUP MENU.

Or press the ◀ or ▶ cursor button to select “RETURN” then press the OK button to return the previous “SPEAKER DISTANCE” setup.

If you select “MANU”, adjust the output level of each speaker as follow.

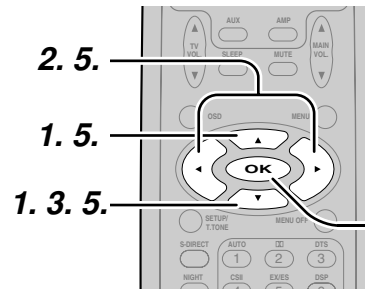

**1.** When you select “MANUAL” in T.MODE menu by pressing the ▲ or ▼ button, this unit will emit a pink noise from the front left speaker. At this time, adjust the desired level of the master volume. Remember the level of this noise and then press the ▼ button. This unit will emit the pink noise from the center speaker.

**2.** Using the ◀ and ▶ cursor buttons, adjust the volume level of the noise from the center speaker so that it is the same level as the front left speaker (Note that this can be adjusted to any level between -10 and +10 dB in 1dB intervals).

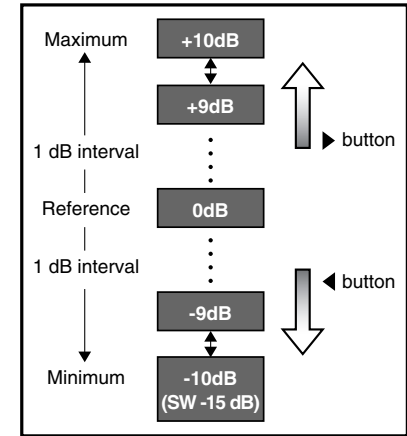

**3.** Press the ▼ cursor button again. This unit will now emit the pink noise from the front right speaker.

**4.** Repeat steps 2 and 3 above for the front right and other speakers until all speakers are adjusted to the same volume level.

**5.** When you select “TO MAIN MENU” by pressing the OK button, you can return the SETUP MAIN MENU by pressing the OK button . Or press the ▲ or ▼ cursor button to select “EXIT” then press the OK button to exit the SETUP MENU.

Or press the ◀ or ▶ button to select “RETURN” then press the OK button to return the previous “SPEAKER DISTANCE” setup.

**Notes:**

- Speakers that you selected "None" for in the Speaker Size Setup menu will not appear.
- The setup level for each channel is memorized for reproduction in all surround mode.
- To adjust the speaker levels for 6.1-channel input sources, you will need to use the 6.1CH Level Input setup menu.

**MENU STRUCTURE of Speaker Level setup**

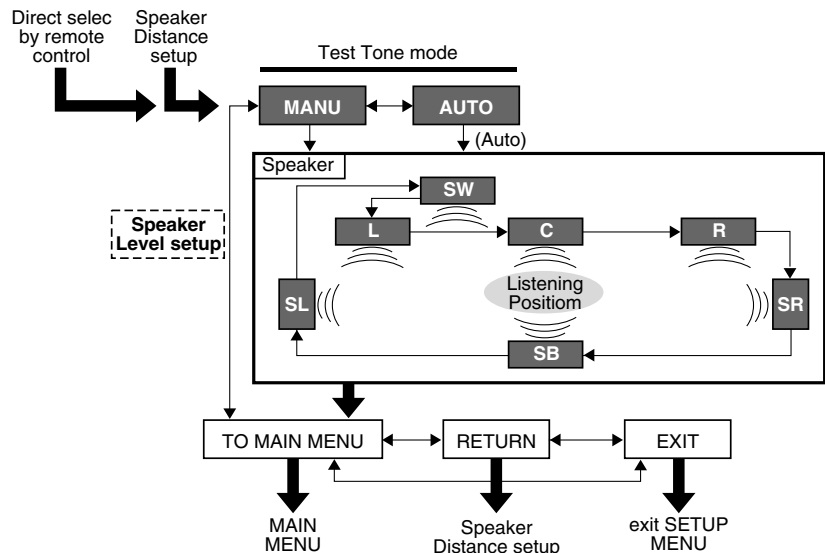

**3. PREFERENCE**

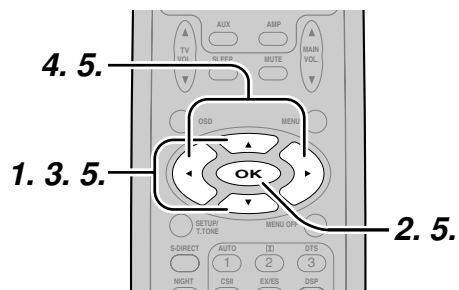

1. Select "3. PREFERENCE" in SETUP MAIN MENU with ▲ or ▼ cursor button.
2. Press the OK button.
3. Press ▲ or ▼ cursor button to select a desired item.

4. Press ◀ or ▶ cursor button to adjust.
5. When you select "TO MAIN MENU" by pressing the ▲ or ▼ button, you can return the SETUP MAIN MENU by pressing the OK button . Or press the ◀ or ▶ cursor button to select "EXIT" then press the OK button to exit the SETUP MENU.

**BASS MIX**

- The bass mix setting is only valid when "LARGE" is set for the front speakers and "YES" is set for the subwoofer at stereo playback .
  - When the "BOTH" is selected, the low frequency signal range of "LARGE" are produced simultaneously from those channels and the subwoofer channel.
- When actual low frequency sound volume is weak depending on room size, use this function to fill low frequency sound equally in the room.

- When "Mix" is selected, subwoofer output is determined depending on the speaker sizes for each channels. If the front speaker size is set to "Large", subwoofer output is only the LFE signal contained in Dolby Digital or DTS processed signals.

**Note:**

- When Front speaker is set "SMALL", then BASS MIX is set "MIX". (The display appears "BASS MIX = \*\*\*".)

**LFE**

- Select the output level of the LFE signal included in the Dolby Digital signal or the DTS signal. Select 0dB, -10 dB or OFF with Left or Right cursor button.
- This setting is available during a digital signal is playback.

**MENU STRUCTURE of PREFERENCE setup**

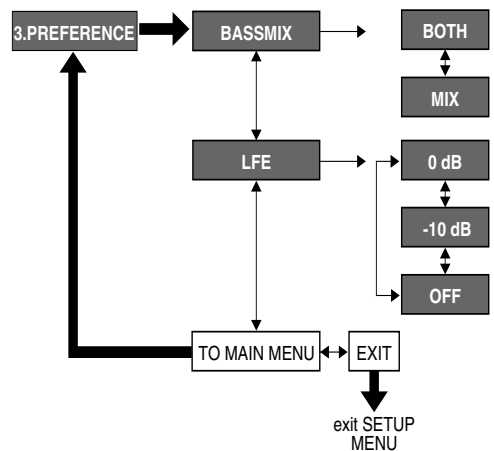

**4. PL II (DOLBY PRO LOGIC II)**

In this mode, the SR4400 includes three controls to fine-tune the sound-field as follow.

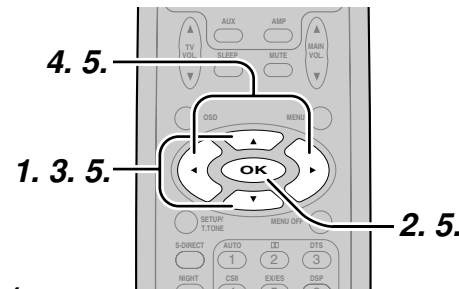

1. Select "4.PRO LOGIC II" in SETUP MAIN MENU with ▲ or ▼ cursor button.
2. Press the OK button.
3. Press ▲ or ▼ cursor button to select a desired item.
4. Press ◀ or ▶ cursor button to select the mode or set the level.
5. When you select "TO MAIN MENU" by pressing the ▲ or ▼ button, you can return the SETUP MAIN MENU by pressing the OK button . Or press the ◀ or ▶ cursor button to select "EXIT" then press the OK button to exit the SETUP MENU.

**PANORAMA:**

Select the Panorama mode On or Off with ◀ or ▶ cursor button. Panorama wraps the sound of the front left and right speakers around you for an exciting perspective.

**DIMENSION:**

Set the Dimension level between 0 and 6 level in 1 level interval with ◀ or ▶ cursor button. Adjust the soundfield either towards the front or towards the rear. This can be useful to help achieve a more suitable balance from all the speakers with certain recordings.

**C WIDTH:**

Set the Center width level between 0 and 7 level in 1 level interval with ◀ or ▶ cursor button. Center Width allows you to gradually spread the center channel sound into the front left and right speakers. At its widest setting, all the sound from the center is mixed into the left and right. This control may help achieve a more spacious sound or a better blend of the front image. If "NONE" was selected for the Center speaker setting in the Speaker size, then this setting will not appear.

**Note:**

- When Center speaker is set "None", then C.WIDTH is set "7". (The display appears "C.WIDTH = \*\*\*".)

**MENU STRUCTURE of PRO LOGIC II setup**

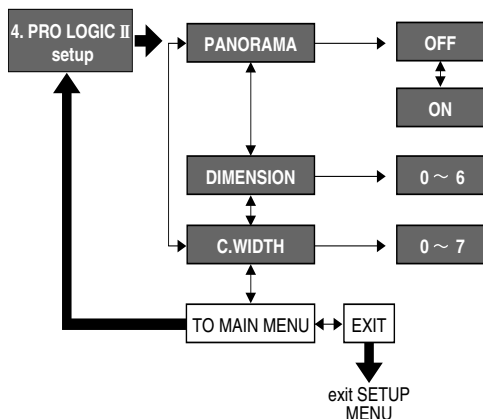

**5. CS II (CIRCLE SURROUND II)**

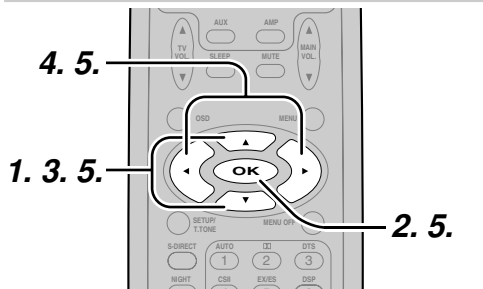

1. Select "5. CS II" in SETUP MAIN MENU with ▲ or ▼ cursor button.
2. Press the OK button to enter this menu.
3. Press ▲ or ▼ cursor button to select desired item.
4. Press ◀ or ▶ cursor button to set the level.
5. When you select "TO MAIN MENU" by pressing the ▲ or ▼ button, you can return the SETUP MAIN MENU by pressing the OK button . Or press the ◀ or ▶ cursor button to select "EXIT" then press the OK button to exit the SETUP MENU.

**TRUBASS:**

Set the TRUBASS level between 0 and 6 level in 1 level interval with ◀ or ▶ cursor button. TRUBASS produced by the speakers to be an octave below the actual physical capabilities of the speakers adding exciting, deeper bass effects.

**SRS DIALOG:**

Set the SRS DIALOG level between 0 and 6 level in 1 level interval with ◀ or ▶ cursor button. This can be popped out of the surround audio effects allowing the listener to easily discern what the actors say. If "NONE" was selected for the Center speaker setting in the Speaker size, then this setting will not appear.

**MENU STRUCTURE of CS II setup**

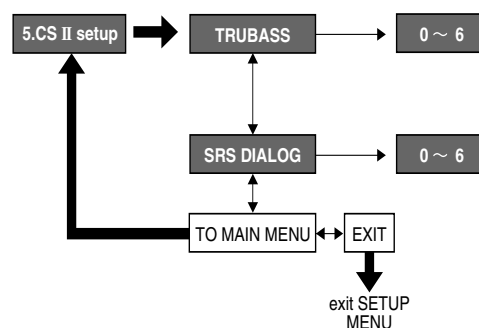

**6. 6.1 CH INPUT LEVEL**

This sub-menu is to adjust the speaker levels for 6.1-channel input sources. Here you will adjust the volume for each channel so that they are all heard by the listener at the same level.

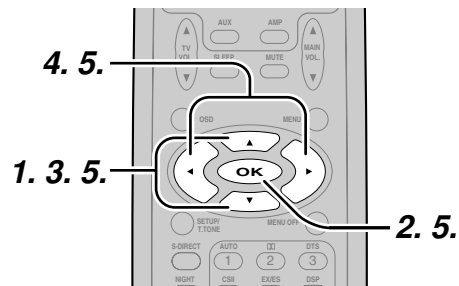

1. Select "6. 6.1 CH IN" in SETUP MAIN MENU with ▲ or ▼ cursor button.
2. Press the OK button to enter this menu.
3. Press ▲ or ▼ cursor button to select desired channel.
4. Using the ◀ or ▶ cursor button, adjust the volume level of each channel.

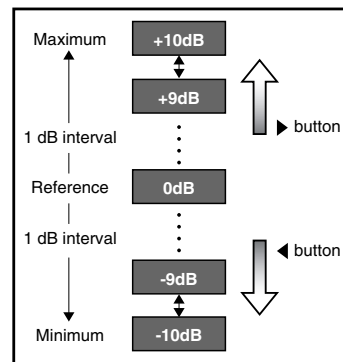

5. When you select "TO MAIN MENU" by pressing the ▲ or ▼ button, you can return the SETUP MAIN MENU by pressing the OK button . Or press the ◀ or ▶ cursor button to select "EXIT" then press the OK button to exit the SETUP MENU.

**Note:**

- The condition of these setup will be memorized to 6.1CH INPUT source.

**MENU STRUCTURE of 6.1CH IN setup**

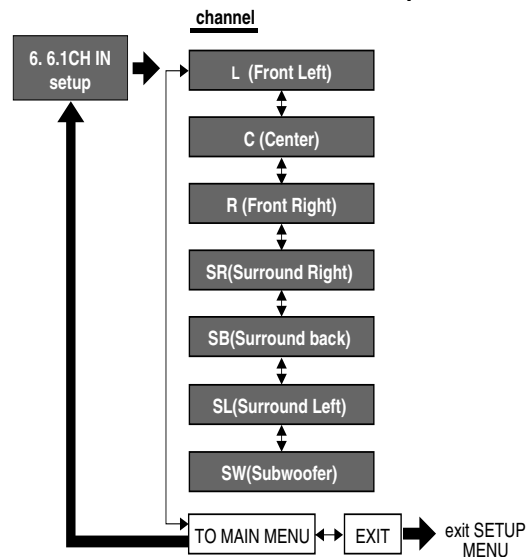

**7. SURROUND**

This sub menu is to adjust channel levels for each surround setting groups. There are three surround setting groups shown below. Therefore if settings for a surround mode are changed, settings for all other surround modes in the same group are also changed.

**Surround setting group**

- 1 : AUTO, DOLBY, DTS, EX/ES, VIRTUAL, STEREO
- 2 : Multi-ch stereo
- 3 : CS II

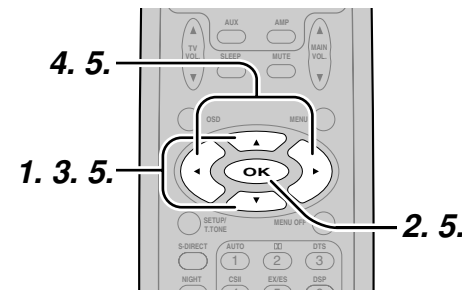

1. Select "7. SURROUND" in SETUP MAIN MENU with ▲ or ▼ cursor button.
2. Press the OK button.
3. To select a desired item, press ▲ or ▼ cursor button.
4. Using the ◀ or ▶ cursor button to select the mode or adjust the volume level of each speaker.
5. When you select "TO MAIN MENU" by pressing the ▲ or ▼ button, you can return the SETUP MAIN MENU by pressing the OK button . Or press the ◀ or ▶ cursor button to select "EXIT" then press the OK button to exit the SETUP MENU.

**SURR-MODE :**

Select the desired surround mode with ◀ or ▶ cursor button.

- If one of the following modes is selected, all other modes are also set to the same. AUTO, DOLBY, DTS, EX/ES, VIRTUAL, STEREO.

**SURR. L/R :**

Adjust the volume level of the surround left/right speaker between -10 dB and +10 dB in 1 level interval with ◀ or ▶ cursor button.

- If "None" was selected for the Surround L/R speaker setting in the Speaker size, then this setting will not appear.

**SURR. BACK :**

Adjust the volume level of the surround back speaker between -10 dB and +10 dB in 1 level interval with ◀ or ▶ cursor button.

- If “None” was selected for the Surround back speakers setting in the Speaker size, then this setting will not appear.

**CENTER :**

Adjust the volume level of the center speaker between -10 dB and +10 dB in 1 level interval with ◀ or ▶ cursor button.

- If “None” was selected for the Center speaker setting in the Speaker size, then this setting will not appear.

**SUB W :**

Adjust the volume level of the subwoofer speaker between -15 dB and +10 dB in 1 level interval with ◀ or ▶ cursor button.

- If “None” was selected for the Subwoofer speaker setting in the Speaker size, then this setting will not appear.

When you select “TO MAIN MENU” by pressing the ▲ or ▼ button, you can return the SETUP MAIN MENU by pressing the OK button.

**Note:**

- SURR.L/R, SURR. BACK, CENTER and SUB W volume level are synchronized with SETUP MAIN MENU Speaker Level. (Page 18)

**MENU STRUCTURE of SURROUND setup**

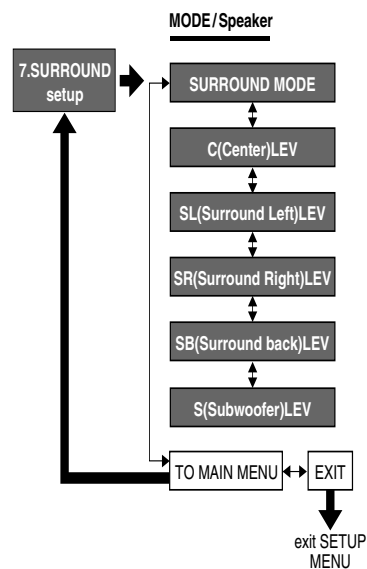

**BASIC OPERATION (PLAY BACK)**

**SELECTING AN INPUT SOURCE.**

Before you can listen to any input media, you must first select the input source at the SR4400.

**E.G. : DVD**

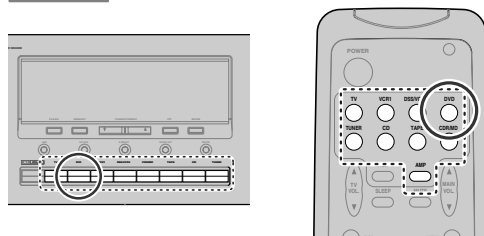

To select DVD, simply press the **DVD** button on the front panel or press **DVD** button on the remote. After you have selected DVD, simply turn on the DVD player and play the DVD.

- The input name will appear in the display on the front-panel.
- As the input is changed, the SR4400 will automatically switch to the digital input, surround mode, attenuation, and night mode status that were entered during the configuration process for that source.
- When an audio source is selected, the last video input used remains routed to the **VCR1 & DSS/ VCR2** Outputs and **Monitor** Outputs. This permits simultaneous viewing and listening to different sources.
- When a Video source is selected, the video signal for that input will be routed to the **Monitor Outputs** jack and will be viewable on a TV monitor connected to the SR4400.

**SELECTING THE SURROUND MODE**

**E.G. : AUTO SURROUND**

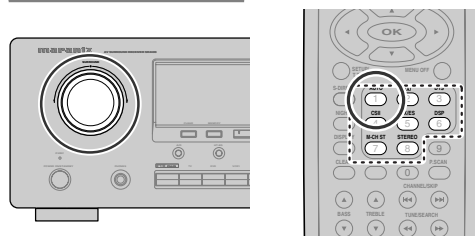

To select the surround mode during playback, turn the **SURROUND** knob on the front panel or press the surround mode button on the remote .

**ADJUSTING THE MAIN VOLUME**

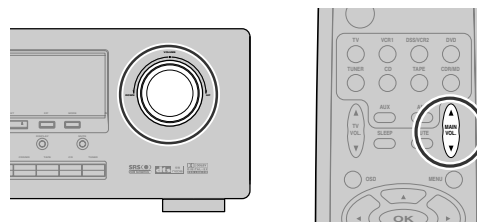

Adjust the volume to a comfortable level using the **VOLUME** control knob on the front panel or **MAIN VOL. ▲ / ▼** buttons on the remote.

To increase the volume, turn the **VOLUME** knob to clockwise or press **MAIN VOL. ▲** button on the remote, to decrease the volume, turn it to counterclockwise or press **MAIN VOL. ▼** button on the remote.

**Notes:**

- The volume can be adjusted within the range of -∞ to +18 dB, in steps of 1 dB.
- However, when the channel level is set as described on page 18, if the volume for any channel is set at +1 dB or greater, the volume cannot be adjusted up to +18 dB.

(In this case the maximum volume adjustment range is “+18 dB - Maximum value of channel level)

**ADJUSTING THE TONE(BASS & TREBLE) CONTROL.**

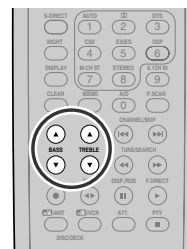

During a listening session you may wish to adjust the Bass and Treble Control to suit your listening tastes or room acoustics.

To adjust the bass effect , press **BASS▲** or **BASS▼** on the remote.

To adjust the treble effect , press **TREBLE▲** or **TREBLE▼** on the remote.

**Notes :**

- The tone control function can work for the front left and front right speakers.
- When Source Direct mode is set, tone control is disable.

**TEMPORARILY TURNING OFF THE SOUND**

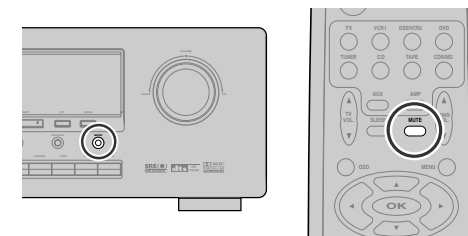

To temporarily silence all speaker outputs such as when interrupted by a phone call, press the **MUTE** button on the front panel or remote.

This will interrupt the output to all speakers and the head-phone jack, but it will not affect any recording or dubbing that may be in progress.

When the system is muted, the display will show “MUTE” .

Press the **MUTE** button again to return to normal operation.

**USING THE SLEEP TIMER**



To program the SR4400 for automatic standby, press **SLEEP** buton on the remote.

Each press of the button will increase the time before shut down in the following sequence.

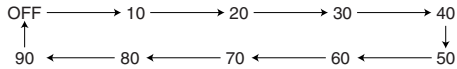

The sleep time will be shown for a few seconds in the display on the front panel, and it will count down until the time has elapsed.

When the programmed sleep time has elapsed, the unit will automatically turn off.

Note that the **SLEEP** indicator on the display will light up when the Sleep function is programmed. To cancel the Sleep function, press the **SLEEP** button until the display shows to “**SLEEP OFF**” and the SLEEP indicator disappear.

## NIGHT MODE



Press the **NIGHT** button on the remote to turn on the NIGHT mode.

Selecting the Night Mode ON is effective in Dolby Digital only, and it compresses the dynamic range. This softens loud passages such as sudden explosions, to help prevent disturbing others late at night.

To turn off the Night mode, press the **NIGHT** button again.

## SURROUND MODE

The SR4400 is equipped with many surround modes. These are provided to reproduce a variety of surround sound effects, according to the content of the source to be played.

The available surround modes may be restricted depending on the input signal and speaker setup. When using the remote control, press **AMP** button and press the desired surround mode button.

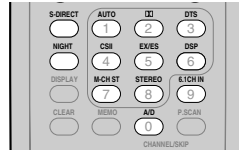

### AUTO

When this mode is selected, the receiver determines whether the digital input signal is Dolby Digital, Dolby Digital Surround EX, DTS, DTS-ES or PCM-audio.

Surround EX & DTS-ES will operate for multi channel source that has a Dolby Digital Surround EX or DTS-ES auto trigger flag in the digital signal. When a Dolby Digital or DTS signal is input, the number of channels for which the corresponding signal is encoded will be played.

Inputting a Dolby Digital two channel signal with Dolby surround status automatically subjects that signal to Pro Logic II movie processing before play.

PCM 96 kHz source material can be played in this mode.

#### Notes:

- When you use this mode with certain DVD and CD players, performing operations such as “Skip” or “Stop” may momentarily interrupt the output.
- When the signal is not decoded is input for using mode, the mode is changed to AUTO mode automatically. Refer to page 24 to confirm the available decoding mode.

### DD MODE

*(Dolby Digital, Pro Logic II MOVIE, Pro Logic II MUSIC, Pro Logic)*

This mode is used with source materials encoded in Dolby Digital and Dolby Surround.

### DOLBY DIGITAL

This mode is enabled when playing source materials encoded in Dolby Digital. Playing multi-channel encoded 5.1-channel Dolby Digital sources provides five main audio channels (left, center, right, surround left and surround right)

and Low Frequency Effect channel. Dolby Digital EX decoding is not available in this mode.

Dolby Pro Logic II brings the excitement of surround sound to any stereo mix, while making existing Dolby Surround mixes sound more like discrete 5.1 channels Surround sound.

Dolby Pro Logic II has below 3 modes.

#### Pro Logic II MOVIE

This mode provides 5.1 channel surround sound from Dolby Surround encoded stereo movie sound tracks.

#### Pro Logic II MUSIC

This mode provides 5.1 channel surround sound from conventional stereo sources, analog or digital, such as CD, tape, FM, TV, stereo VCR, etc.

#### Pro Logic

This mode emulated original Dolby Pro Logic decoding (3/1 surround) suit for Dolby Surround encoded stereo movie soundtracks.

#### Notes:

- Pro Logic II mode is available to 2ch input signal which is encoded Dolby Digital or PCM format.
- PCM-audio signals can be subjected to Pro Logic processing when the sampling frequency is 32 kHz, 44.1 kHz or 48 kHz.

### EX/ES

This mode provides 6.1 channel surround for DOLBY DIGITAL EX, DTS-ES encoded source material such as DVD.

This mode cannot be used when an analog input has been selected.

#### Dolby Digital EX

In a movie theater, film soundtracks that have been encoded with Dolby Digital surround EX technology are able to reproduce an extra channel which has been added during the mixing of the program.

This channel, called Surround Back, places sounds behind the listener in addition to the currently available front left, front center, front right, surround right, surround left and subwoofer channels.

This additional channel provides the opportunity for more detailed imaging behind the listener and brings more depth, spacious ambience and sound localization than ever before.

Dolby Digital EX is not available in the system without surround back speaker.

#### DTS-ES (Discrete 6.1, Matrix 6.1)

DTS-ES adds the surround back channel audio to the DTS 5.1-channel format to improve the acoustic positioning and makes acoustic image movement more natural with the 6.1-channel reproduction.

This receiver incorporates a DTS-ES decoder, which can handle DTS-ES Discrete-encoded and DTS-ES Matrix-encoded program sources from DVD, etc..

DTS-ES Discrete 6.1 features digital discrete recording of all channels including the surround back channels and higher quality of audio reproduction.

DTS-ES is not available in the system without surround back speaker.

### dts MODE

*(dts, Neo:6 Cinema, Neo:6 Music)*

This mode is for DTS encoded source materials such as LASER DISC, CD, and DVD and some 2channel signal source.

**dts** : This mode is enabled when playing source materials encoded in dts multi channel.

Playing multi-channel encoded 5.1-channel dts sources provides five main audio channels (left, center, right, surround left and surround right) and Low Frequency Effect channel.

dts-ES decoding is not available in this mode.

The DTS mode cannot use when an analog input has been selected.

### Neo:6 Cinema, Neo:6 Music

This mode decodes 2-channel signals into 6-channel signals using high-accuracy digital matrix technology.

The DTS NEO:6 decoder has near-discrete properties in the frequency characteristics of the channels as well as in channel separation.

According to the signals to be played back, DTS NEO:6 uses either the NEO:6 CINEMA mode optimized for movie playback or the NEO:6 MUSIC mode optimized for music playback.

#### Note:

- PCM-audio (32 kHz, 44.1 kHz or 48 kHz) and analog source material can playback in this mode.

### MULTI CH. ST

This mode is used to create a wider, deeper and more natural soundstage from two channel source material.

This is done by feeding the left channel signal to both left front and left surround speaker and the right channel signal to both right front and right surround speaker. Additionally, the center channel reproduces a mix of the right and left channel.



**CIRCLE SURROUND II (CSII-CINEMA, CSII-MUSIC, CSII-MONO)**

Circle Surround is designed to enable multi-channel surround sound playback of non-encoded and multi-channel encoded material.

Backward compatibility provides listeners with up to 6.1 channels of surround performance from entire collection of music and film, including broadcast, videotape and stereo recorded music. Regarding to source material, you can select **CSII-Cinema** mode, **CSII-Music** mode or **CSII-Mono** mode.

**Note:**

- PCM-audio (32 kHz, 44.1 kHz or 48 kHz) and analog source material can playback in this mode.

**VIRTUAL**

This mode creates a virtualized surround sound experience from a two-speaker (front L and R) playback system playing any multi-channel audio source (such as found on DVDs and digital broadcasts), including Dolby Digital, Dolby Pro Logic or DTS.

**DSP SURROUND (MOVIE, HALL, STADIUM, MATRIX)**

These modes provide surround effect processing from each input source material.

They will produce theater, concert hall and stadium like atmospheres. Select as your taste desires.

**Note:**

- When using the remote control, press the numeric button **6 (DSP)** to change the surround effect.
- PCM-audio (32 kHz, 44.1 kHz or 48 kHz) and analog source material can playback in this mode.

**STEREO**

This mode bypasses all surround processing.

Stereo program sources the left and right channels play normally when PCM-audio or analog stereo is input.

With Dolby Digital and DTS sources, the 5.1 multi-channels are converted to two channel stereo. 96 kHz PCM source material can be playback in stereo mode.

**S (SOURCE) - DIRECT**

In the source direct mode, the tone control circuit and bass management configuration are bypassed for full range frequency response and the purist audio reproduction.

96 kHz PCM source material can be play back in this mode.

**Notes:**

- Internal speaker size is setup to front L/R = Large, Center = Large, Surround L/R = Large and Subwoofer = yes automatically. Tone controls and additional processing are also defeated.
- When you use this mode with certain DVD and CD players, performing operations such as "Skip" or "Stop" may momentarily interrupt the output.

**CAUTION*****NOTE for DTS signal***

- \* Connected DVD-player, laser-disc player or CD-player needs to support DTS-digital output. You may not be able to play some DTS source signals from certain CD players and LD players even if you connect the player to the SR4400 digitally. This is because the digital signal has been processed (such as the output level, sampling frequency, or frequency response) and the SR4400 cannot recognize the signal as DTS data.
- \* Depending on the player used, DTS play may produce short noise. This is not a malfunction. In such cases, select the surround mode the "DTS" or "DTS-ES".
- \* While signals from DTS-laser disc or CD are playing in another Surround mode, you cannot switch to digital input or from digital input to analog input by INPUT SETUP in SETUP MAIN MENU or A/D button.
- \* The outputs for the VCR 1 OUT, DSS/VCR 2 OUT, TAPE OUT, and CD-R OUT output analog audio signals. Do not record from CDs or LDs that support DTS using these outputs. If you do, the DTS-encoded signal will be recorded as noise.

***NOTE for Dolby Digital Surround EX signal***

- \* When playing Dolby Digital Surround EX-encoded software in 6.1 channels, it is required to set the EX/ES mode.
- \* Note that some of Dolby Digital Surround EX-encoded software does not contain the identification signal. In this case, set the EX/ES mode manually.

***NOTE for 96kHz PCM audio***

- \* AUTO, Source- DIRECT, and STEREO modes can be used when playing PCM signals with a sampling frequency of 96 kHz (such as from DVD-Video discs that contain 24 bit, 96 kHz audio). If such signals are input during playback in one of the other surround modes, output from SR4400 will be muted.
- \* Certain DVD player models inhibit digital output. For details, refer to the player's operation manual.
- \* Some DVD formatted discs featured copy protection. When using such disc, 96 kHz PCM signal is not output from the DVD player. For details, refer to the player's operation manual.

***The relation between the selected surround mode and the input signal***

The surround mode is selected with the surround mode knob on SR4400 or the remote control unit. However, the sound you hear is subject to the relationship between the selected surround mode and input signal. That relationship is as next page;

Surround Mode	Input Signal	Decoding	Output Channel					Front information display		
			L/R	C	SL SR	SB	SW	Dot matrix display	Signal format indicators	Channel status
AUTO	Dolby Surr. EX	Dolby Digital EX	○	○	○	○	○	DOLBY D EX	□□ DIGITAL, EX	L, C, R, SL, SR, S, LFE
	Dolby D (5.1ch)	Dolby Digital 5.1	○	○	○	-	○	DOLBY D	□□ DIGITAL	L, C, R, SL, SR, LFE
	Dolby D (2ch)	Dolby Digital 2.0	○	-	-	-	○	DOLBY D	□□ DIGITAL	L, R
	Dolby D (2ch Surr)	Pro Logic II movie	○	○	○	-	○	DOLBY PL II MV	□□ DIGITAL, □□ SURROUND	L, R, S
	DTS-ES	DTS-ES	○	○	○	○	○	DTS-ES Disc or DTS-ES Mtrx	dts, ES	L, C, R, SL, SR, S, LFE
	DTS (5.1ch)	DTS 5.1	○	○	○	-	○	DTS	dts	L, C, R, SL, SR, LFE
	PCM (Audio)	PCM (Stereo)	○	-	-	-	○	STEREO	PCM	L, R
	PCM 96kHz	PCM (96kHz Stereo)	○	-	-	-	○	STEREO	PCM, 96kHz	L, R
	Analog	Stereo	○	-	-	-	○	STEREO	ANALOG	-
	S-DIRECT	Dolby D Surr. EX	Dolby Digital EX	○	○	○	○	○	DOLBY D EX	□□ DIGITAL, EX
Dolby D (5.1ch)		Dolby Digital 5.1	○	○	○	-	○	DOLBY D	□□ DIGITAL	L, C, R, SL, SR, LFE
Dolby D (2ch)		Dolby Digital 2.0	○	-	-	-	○	DOLBY D	□□ DIGITAL	L, R
Dolby D (2ch Surr)		Pro Logic II movie	○	○	○	-	○	DOLBY PL II MV	□□ DIGITAL, □□ SURROUND	L, R, S
DTS-ES		DTS-ES	○	○	○	○	○	DTS-ES Disc or DTS-ES Mtrx	dts, ES	L, C, R, SL, SR, S, LFE
DTS (5.1ch)		DTS 5.1	○	○	○	-	○	DTS	dts	L, C, R, SL, SR, LFE
PCM (Audio)		PCM (Stereo)	○	-	-	-	○	STEREO	PCM	L, R
PCM 96kHz		PCM (96kHz Stereo)	○	-	-	-	○	STEREO	PCM, 96kHz	L, R
Analog		Stereo	○	-	-	-	○	STEREO	ANALOG	-
EX/ES		Dolby D Surr. EX	Dolby Digital EX	○	○	○	○	○	DOLBY D EX	□□ DIGITAL, EX
	Dolby D (5.1ch)	Dolby Digital EX	○	○	○	○	○	DOLBY D EX	□□ DIGITAL	L, C, R, SL, SR, LFE
	DTS-ES	DTS-ES	○	○	○	○	○	DTS-ES Disc or DTS-ES Mtrx	dts, ES	L, C, R, SL, SR, S, LFE
	DTS (5.1ch)	DTS-ES	○	○	○	○	○	DTS-ES Mtrx	dts	L, C, R, SL, SR, LFE
DOLBY (PLII MOVIE) (PLII MUSIC) (PRO LOGIC)	Dolby D Surr. EX	Dolby Digital 5.1	○	○	○	-	○	DOLBY D	□□ DIGITAL, EX	L, C, R, SL, SR, S, LFE
	Dolby D (5.1ch)	Dolby Digital 5.1	○	○	○	-	○	DOLBY D	□□ DIGITAL	L, C, R, SL, SR, LFE
	Dolby D (2ch)	Pro Logic II	○	○	○	-	○	DOLBY PL	□□ DIGITAL	L, R
	Dolby D (2ch Surr)	Pro Logic II	○	○	○	-	○	or DOLBY PLII MV	□□ DIGITAL, □□ SURROUND	L, R, S
	PCM (Audio)	Pro Logic II	○	○	○	-	○	or DOLBY PLII MS	PCM	L, R
	Analog	Pro Logic II	○	○	○	-	○		ANALOG	-
DTS (Neo:6 Cinema) (Neo:6 Music)	DTS-ES	DTS 5.1	○	○	○	-	○	DTS	dts, ES	L, C, R, SL, SR, S, LFE
	DTS (5.1ch)	DTS 5.1	○	○	○	-	○	DTS	dts	L, C, R, SL, SR, LFE
	PCM (Audio)	Neo:6	○	○	○	○	○	NEO:6 CINEMA or NEO:6 MUSIC	PCM	L, R
	Analog	Neo:6	○	○	○	○	○		ANALOG	L, R
CSII CINEMA CSII MUSIC CSII MONO	PCM (Audio)	CSII	○	○	○	○	○	CSII CINEMA	PCM	L, R
	Analog	CSII	○	○	○	○	○	or CSII MUSIC or CSII MONO	ANALOG	-
STEREO	Dolby Surr. EX	Stereo	○	-	-	-	○	STEREO	□□ DIGITAL, EX	L, C, R, SL, SR, S, LFE
	Dolby D (5.1ch)	Stereo	○	-	-	-	○	STEREO	□□ DIGITAL	L, C, R, SL, SR, LFE
	Dolby D (2ch)	Stereo	○	-	-	-	○	STEREO	□□ DIGITAL	L, R
	Dolby D (2ch Surr)	Stereo	○	-	-	-	○	STEREO	□□ DIGITAL, □□ SURROUND	L, R, S
	DTS-ES	Stereo	○	-	-	-	○	STEREO	dts, ES	L, C, R, SL, SR, S, LFE
	DTS (5.1ch)	Stereo	○	-	-	-	○	STEREO	dts	L, C, R, SL, SR, LFE
	PCM (Audio)	Stereo	○	-	-	-	○	STEREO	PCM	L, R
	PCM 96kHz	Stereo	○	-	-	-	○	STEREO	PCM, 96kHz	L, R
	Analog	Stereo	○	-	-	-	○	STEREO	ANALOG	-
	VIRTUAL	Dolby Surr. EX	Virtual	○	-	-	-	○	VIRTUAL	□□ DIGITAL, EX
Dolby D (5.1ch)		Virtual	○	-	-	-	○	VIRTUAL	□□ DIGITAL	L, C, R, SL, SR, LFE
Dolby D (2ch)		Virtual	○	-	-	-	○	VIRTUAL	□□ DIGITAL	L, R
Dolby D (2ch Surr)		Virtual	○	-	-	-	○	VIRTUAL	□□ DIGITAL, □□ SURROUND	L, R, S
DTS-ES		Virtual	○	-	-	-	○	VIRTUAL	dts, ES	L, C, R, SL, SR, S, LFE
DTS (5.1ch)		Virtual	○	-	-	-	○	VIRTUAL	dts	L, C, R, SL, SR, LFE
PCM (Audio)		Virtual	○	-	-	-	○	VIRTUAL	PCM	L, R
Analog	Virtual	○	-	-	-	○	VIRTUAL	ANALOG	-	
MULTI CH ST	Dolby Surr. EX	Dolby Digital EX	○	○	○	○	○	M-CH STEREO	□□ DIGITAL, EX	L, C, R, SL, SR, S, LFE
	Dolby D (5.1ch)	Dolby Digital EX	○	○	○	○	○	M-CH STEREO	□□ DIGITAL	L, C, R, SL, SR, LFE
	Dolby D (2ch)	Multi Channel Stereo	○	○	○	-	○	M-CH STEREO	□□ DIGITAL	L, R
	Dolby D (2ch Surr)	Multi Channel Stereo	○	○	○	-	○	M-CH STEREO	□□ DIGITAL, □□ SURROUND	L, R, S
	DTS-ES	DTS-ES	○	○	○	○	○	M-CH STEREO	dts, ES	L, C, R, SL, SR, S, LFE
	DTS (5.1ch)	DTS-ES	○	○	○	○	○	M-CH STEREO	dts	L, C, R, SL, SR, LFE
	PCM (Audio)	Multi Channel Stereo	○	○	○	-	○	M-CH STEREO	PCM	L, R
Analog	Multi Channel Stereo	○	○	○	-	○	M-CH STEREO	ANALOG	-	
DSP SURROUND (MOVIE) (HALL) (STADIUM) (MATRIX)	PCM (Audio)	DSP	○	○	○	-	○	MOVIE or HALL or STADIUM or MATRIX	PCM	L, R
	Analog	DSP	○	○	○	-	○		ANALOG	-

**Dolby Surr.EX:**

Dolby Digital stream with Surround EX flag

**DTS-ES:**

DTS digital stream with ES flag.

**Dolby D(2ch Surr) :**

2channel Dolby Digital stream with Dolby Surround flag

L/R = Front Left and Right speakers

C = Center speaker

SL/SR = Surround Left and Right speakers

SB = Surround back speaker

SW = Sub woofer speaker

# OTHER FUNCTION

## ATTENUATION TO ANALOG INPUT SIGNAL



When the input signal is too high and the voice distorts even by throttling the SR4400 VOLUME control, turn on this function. "ATT" is indicated when this function is activated. "ATT" indicator will light up when this function is activated. The signal-input level is reduced by about the half. Attenuation will not work with the output signal of TAPE-OUT, CD-R/MD-OUT, VCR1-OUT and DSS/VCR2-OUT. This function is memorized for each individual input source.

## LISTENING OVER HEADPHONES

This jack may be used to listen to the SR4400's output through a pair of headphones. Be certain that the headphones have a standard 1/4" stereo phone plug. (Note that the main room speakers will automatically be turned off when the headphone jack is in use.)

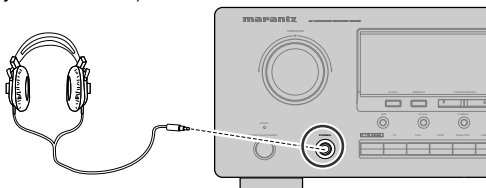

**Notes:**

- When using headphones, the surround mode will automatically change to STEREO.
- The surround mode returns to the previous setting as soon as the plug is removed from the jack.

## DIMMER (DISPLAY)

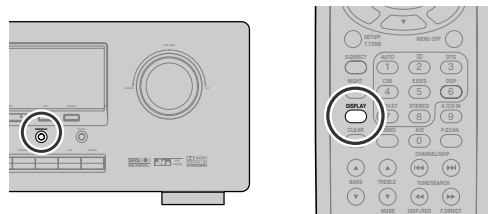

You can change the display brightness of the front display. Press the **DISPLAY** button to change the brightness. When this button is pressed, the brightness is changed in the following sequence. → dimmed → Display Off → normal → dimmed ...

**Note:**

- Only DISP indicator will light up on the front display in display off condition

## SELECTING ANALOG AUDIO INPUT OR DIGITAL AUDIO INPUT

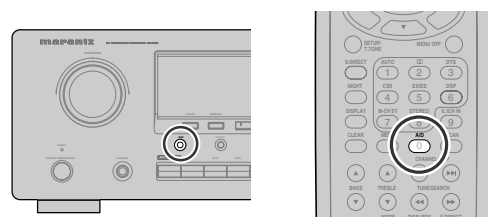

If you have already assign any digital input to input source.

You can select temporarily the audio input mode for each input source with the **A/D** button on the remote controller or front panel.

When this button is pressed, the input mode is switched in the following sequence.

→ Digital Auto → Digital → Analog → Digital Auto....

In Digital Auto mode, the types of signals being input to the digital and analog input jacks for the selected input source are detected automatically. If no digital signal is being input, the analog input jacks are selected automatically.

In Digital mode, input is fixed to an assigned digital input terminal.

In analog mode, the analog input jacks are selected.

This selecting is temporarily, so the result will not be stored in memory.

If you need to change input mode completely, use **SYSTEM SETUP** in **SETUP** menu system. (see page 16)

## RECORDING AN ANALOG SOURCE

In normal operation, the audio or video source selected for listening through the SR4400 is sent to the record outputs.

This means that any program you are watching or listening to may be recorded simply by placing machines connected to the outputs for **TAPE OUT**, **CD-R/MD OUT**, **VCR1 OUT**, and **DSS/VCR2 OUT** in the record mode.

*To record the input source signal you are currently watching or listening to*

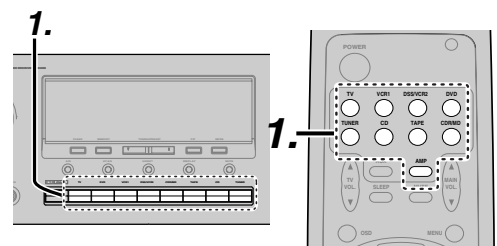

1. Select the input source to record by pressing the corresponding **input selector** button. The input source is now selected and you may watch or listen to it as desired.
2. Outputs the currently selected input source signal to the **TAPE OUT**, **CD-R/MD OUT**, **VCR1 OUT**, and **DSS/VCR2 OUT** outputs for recording.
3. Start recording at the recording component as desired.

**Notes:**

- If you change the input source during recording, you will record the signals from the newly selected input source.
- You cannot record the surround effects.

## HT-EQ

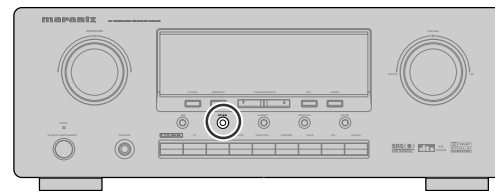

Press the **HT-EQ** button on the front panel to turn on the HT-EQ mode.

The tonal balance of a film soundtrack will be excessively bright and harsh when played back over audio equipment in the home. This is because film soundtracks were designed to be played back in large movie theater environments.

Activating the HT-EQ feature when watching a film made for movie theaters corrects this and restores the correct tonal balance.

The HT-EQ feature can be activated only while in Dolby Pro Logic Mode, or while decoding Dolby Digital or DTS encoded material.

## 6.1 CH INPUT.

The SR4400 is equipped for future expansion through the use of Multi channel SACD multi channel player or DVD-Audio player.

This is selected, the input signals connected to the Front left, Front right, Center, Surround left, Ssurround right and Surround back channels of the 6.1 CH. In jacks are output directly to the front (left and right), center, surround (left and right) and surround back speaker systems as well as the pre-out jacks without passing through the surround circuitry.

In addition, the signal input to the SW (subwoofer) jack is output to the PRE OUT SW (subwoofer) jack.

When 6.1 CH. INPUT is selected, the last video input used remains routed to the Monitor Outputs. This permits simultaneous viewing with video sources.

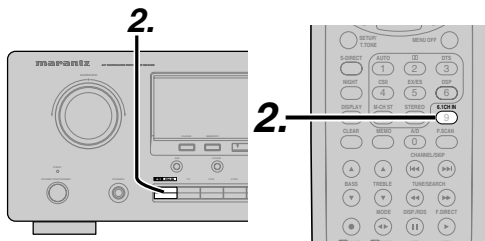

1. Select a desired Video source to decide the routed video signal to the Monitor Outputs .
2. Press the **6.1 CH-IN** button on the front panel or on the remote to switch the 6.1 channel input.
3. If necessary to adjust the output level of each channel, use "6.1 Ch. INPUT LEVEL" in SETUP menu system as desired. Adjust the speaker output levels so that you can hear the same sound level from each speaker at the listening position. For the front left, front right, center, surround left, surround right and surround back speakers, the output levels can be adjusted between -10 to +10 dB. The subwoofer can be adjusted between -15 and +10 dB. These adjusting result will be stored to 6.1 Ch. INPUT condition. (see to page 20)
4. Adjust the main volume with the MAIN VOLUME knob or the VOL buttons on the remote.

To cancel the 6.1 Ch. INPUT setting, press the **6.1 CH-IN** button on the front panel or on the remote.

**Notes:**

- When the 6.1 Ch. Input is in use, you may not select a surround mode, as the external decoder determines processing.
- In addition, there is no signal at the record outputs when the 6.1 Ch. Input is in use.

# BASIC OPERATION (TUNER)

## LISTENING TO THE TUNER

Frequency scan step for AM is selectable. Default setup is 10 kHz step, if your country's standard is 9 kHz step, Press **TUNER** button on the remote more than 6 seconds. Scan step will change.

**Note:**

- Preset memory for the tuner will clear by changing this setup.

## AUTO TUNING

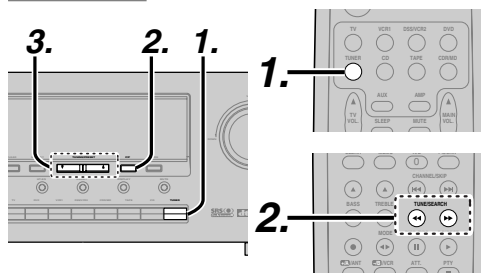

**(Using the SR4400)**

1. To select tuner and desired band (FM or AM), press the **TUNER** button on the front panel.
2. Press the **F/P**(Frequency/Presets) button on the front panel to appears frequency on the display.
3. Press the **TUNING ▲** or **▼** button on the front panel for more than 1 second to start the Auto tuning function.
4. Automatic searching begins then stops when a station is tuned in.

**(Using the remote control unit)**

1. To select tuner and desired band (FM or AM), press the **TUNER** button twice within in two seconds on the remote.
2. Press **◀** or **▶** more than 1 second on the remote.
3. Automatic searching begins then stops when a station is tuned in.

If tuning does not stop at the desired station, use to the "Manual tuning" operation.

## MANUAL TUNING

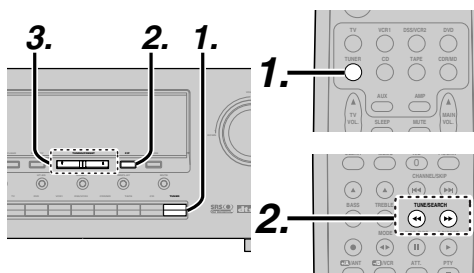

**(Using the SR4400)**

1. To select tuner and desired band (FM or AM), press the **TUNER** button on the front panel
2. Press the **F/P**(Frequency/Presets) button on front panel to appears frequency on the display.
3. Press the **TUNING ▲** or **▼** button.

**(Using the remote control unit)**

1. To select tuner and desired band (FM or AM), press **TUNER** button twice within in two seconds on the remote.
2. Press **◀** or **▶** on the remote to tune in the desired station.

## DIRECT FREQUENCY CALL

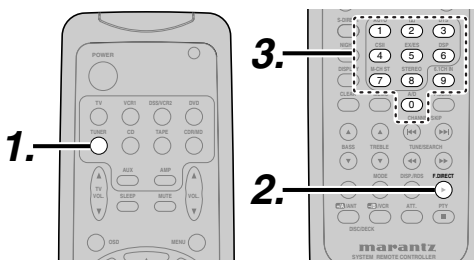

1. To select tuner and desired band (FM or AM), press the **TUNER** on the remote.
2. Press the **F.DIRECT** button on the remote, display will show "FREQ ---".
3. Input your desired station's frequency with **numeric buttons** on the remote.
4. The desired station will automatically be tuned.

## (FM) TUNING MODE (AUTO STEREO OR MONO)

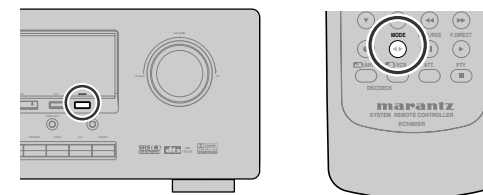

When in the auto stereo mode, **AUTO** indicator keeps to light on the display. The **"ST"** indicator lights on when a stereo broadcast is tuned in. At open frequencies, the noise is muted and the **"TUNED"** and **"ST"** indicators turn off. If the signal is weak, it may be difficult to tune into the station in stereo. In such a case, press the **MODE** button on the front panel or on the remote. **"AUTO"** indicators turn off, FM stereo broadcasts are received in monaural and the **"ST"** indicator turns off. To return to auto stereo mode, press the **MODE** button on the front panel or on the remote again. **AUTO** indicator lights on the display.

## PRESET MEMORY

With this unit you can preset up to 30 FM/AM stations in any order. For each station, you can memorize the frequency and reception mode if desired.

## AUTO PRESET MEMORY

This function automatically scans the FM and AM band and enters all stations with proper signal strength into the memory.

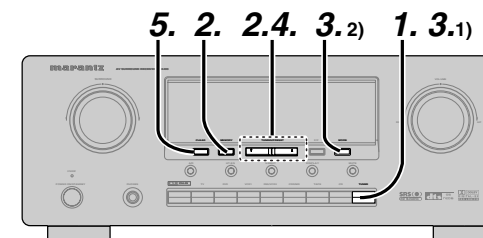

1. To select FM, press the **TUNER** button on the front panel.
2. While pressing the **MEMORY** button, press the **TUNING ▲** button to up.

“AUTO PRESET” will appear on the display, and scanning starts from lowest frequency.

- Each time the tuner finds a station, scanning will pause and the station will be played for five seconds. During this time, the following operations are possible.
  - The band can be changed by **TUNER** button .
- If no button is pressed during this period, the current station is memorized in location Preset 02. If you wish to skip the current station, press the **TUNING ▲** button during this period, this station is skipped and auto presetting continues.
- Operation stops automatically when all 30 preset memory positions are filled or when auto scanning attains the highest end of all bands. If you desire to stop the auto preset memory at anytime, press the **CLEAR** button.

**MANUAL PRESET MEMORY**

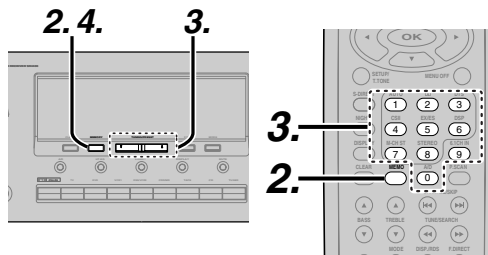

(Using the SR4400)

- Tune into the radio station you desire (Refer to the “MANUAL TUNING” or “AUTO TUNING” section).
- Press the **MEMORY** button on the front panel. “- -” (preset number) starts blinking on the display.
- Select the preset number by pressing the **TUNING ▲** or **▼** button, while this is still blinking (approx. 5 seconds)
- Press the **MEMORY** button again to enter. The display stops blinking. The station is now stored in the specified preset memory location.

(Using the remote control unit)

- Tune into the radio station you desire (Refer to the “MANUAL TUNING” or “AUTO TUNING” section).
- Press the **MEMO** button on the remote unite. “- -” (preset number) starts blinking on the display.
- Enter the desired preset number by pressing **numeric buttons**.

**Note:**

- When entering a single digit number (2 for example), either input “02” or just input “2” and wait for a few seconds.

**RECALLING A PRESET STATION**

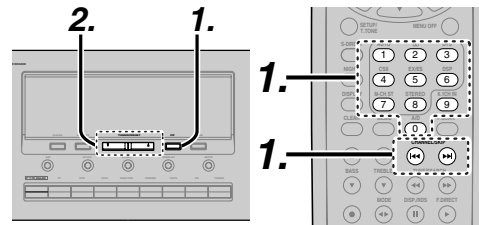

(Using the SR4400)

- Press the **F/P** button to show the preset station on the display.
- Select the desired preset station by pressing the **TUNING ▲** or **▼** button on the front panel

(Using the remote control unit)

- Press the **◀** or **▶** button to select the desired preset station, or input your desired preset channel with **numeric buttons** on the remote.

**PRESET SCAN**

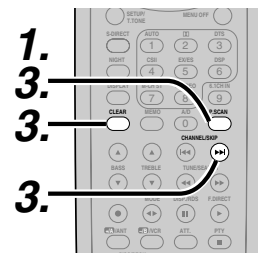

(Using the remote control unit)

- Press the **P.SCAN** on remote. “PRESET SCAN” appears on the display and then the preset station with the lowest preset number is recalled first.
- Preset stations are recalled in sequence (No.1 → No.2 → etc.) for 5 seconds each. No stored preset number will be skipped.
- You can fast forward the preset stations by pressing the **▶▶** continuously. When the desired preset station is received, cancel the preset scan operation by pressing the **CLEAR** or **P.SCAN**.

**CLEARING STORED PRESET STATIONS**

You can remove preset stations from memory using the following procedure.

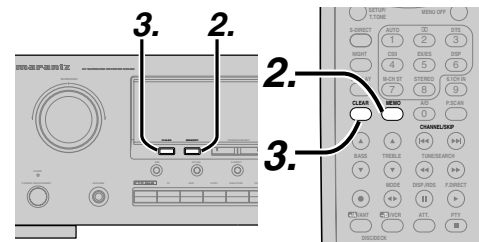

- Recall the preset number to be cleared with the method described in “RECALLING” a preset station.
- Press the **MEMORY** button on the front panel or press **MEMO** button on the remote.
- Stored preset number blinks in the display for 5 seconds. While blinking, press the **CLEAR** button on the front panel or press **CLEAR** on the remote unit.
- “xx CLEAR” appears on the display to indicate that the specified preset number has been cleared.

**Notes:**

- To clear stored all preset stations, press and hold the **CLEAR** and the **F/P** buttons for two seconds.

**NAME INPUT OF THE PRESET STATION**

This function allows the name of each preset channel to be entered using alphanumeric characters. Before name inputting, need to store preset stations with the preset memory operation.

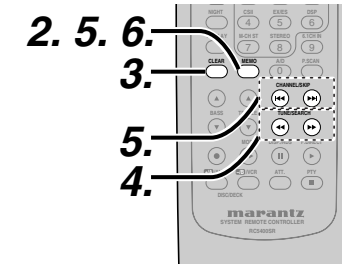
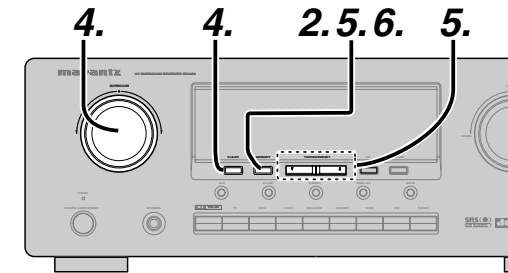

- Recall the preset number to be inputted name with the method described in “RECALLING” a preset station.
- Press the **MEMORY** button on the front panel or press **MEMO** on the remote for more than 3 seconds.
- The left most column of the station name indicator flashes, indicating the character entry ready status.
- When the **SELECT** knob is turned or press **◀** / **▶▶** button on the remote, alphabetic and numeric characters will be displayed in the following order:  
**A → B → C ... Z → 1 → 2 → 3 ..... 0 → - → + → / → (Blank) → A**

UP →  
← DOWN

- To clear the input charcter, press the **CLEAR** button on the front panel or on the remote.
- After selecting the first character to be entered, press the **MEMORY** button on the front panel, or press **MEMO** button on the remote. The entry in this column is fixed and the next column starts to flash. Fill the next column same as.

To move back and forth between the characters, press the **TUNING ▲ / ▼** button or press **◀ / ▶** buttons on the remote.

**Note:**

- Unused columns should be filled by entering blanks.

6. To save name, press the **MEMORY** button, press **MEMO** button on the remote for more than 2 seconds.

- You can input the alphabetic and numeric characters with the ten keypad of the remote control in the previous step 4 and 5.

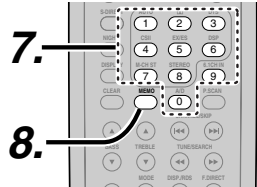

7. Enter the character using the ten keypad. For example, to enter "A":

1) Press the "1" button. "A" appears on the display column.

2) Every time the 1 button is pressed, the displayed character changes in the order: **A → B → C → 1 → A...**

Pressing buttons other than the "1" button cause different characters to be displayed in a similar way, so that other alphanumeric characters can be entered. To enter a blank or space, press the "9" button.

8. When the desired character is displayed, press the **MEMO** button to confirm the entry in this column and move to the next column. After having filled all of the 8 columns, press the **MEMO** button, for more than 1 second to confirm the entry.

# TROUBLESHOOTING

**In case of trouble, check the following before calling for service:**

1. Are the connections made properly ?
2. Are you operating the unit properly following user's guide ?
3. Are the power amplifiers and speaker working properly ?

If the unit does not operate properly, check items shown in the following table.

If your trouble cannot be recovered with the remedy actions listed in the following table, malfunction of the internal circuitry is suspected; immediately unplug the power cable and contact your dealer, nearest Marantz distributor or the Marantz Service Center in your country.

SYMPTOM	CAUSE	REMEDY
SR4400 cannot be turned up.	The power plug is not connected.	Connect the power plug to the outlet.
No sound and picture are output even when power is on.	Mute is on.	Cancel mute using the remote control unit.
	The input cable is not connected correctly.	See the connection diagram and connect the cables correctly.
	The master volume control is turned all the way down.	Adjust the master volume.
	The function selector position is wrong.	Select correct position.
Speaker does not outputting any sound.	The headphones are connected to the headphone jack.	Disconnect the headphones. (Speakers will not output sound when headphones are connected.)
Sound and pictures from other than equipment selected with the function selector.	Input cable connected incorrectly.	Connect the cable correctly by referring to the connection diagram.
Sound from the wrong channel is output from the speaker.	Speaker cable connected incorrectly.	Connect the cable correctly by referring to the connection diagram.
No sound is output from the center speaker.	The center speaker cable connection is incomplete.	Connect the cable correctly.
	STEREO has been selected for Surround mode.	When STEREO is selected for Surround mode, no sound will be output from the center speaker. Set another Surround mode.
	Center = NONE has been selected in SETUP mode.	Make the correct setting.
No sound is output from the surround speakers.	The surround speaker cable connection is incomplete.	Connect the cable correctly.
	STEREO has been selected for Surround mode.	When STEREO has been selected for Surround mode, no sound will be output from the surround speaker. Set another Surround mode.
	Surround = NONE has been selected in SETUP mode.	Make the correct setting.
No sound is output from the surround back	The surround back speaker cable connection is incomplete.	Connect the cable correctly.
	Surround mode is not EX/ES mode.	Set surround mode EX/ES.
	Surround back = NONE has been selected in SPEAKERS SIZE SETUP.	Make the correct setting.
Can not select EX/ES mode.	Surround back = NONE has been selected in SPEAKERS SIZE SETUP.	Make the correct setting.
	Input signal is incompatible.	Use 5.1 channel source.
Can not select Pro Logic II mode.	Input signal is incompatible.	Use 2 channel Dolby Digital input signal, PCM input signal or analog input signal.
Can not select Neo:6 mode.	Input signal is incompatible.	Use PCM input signal or analog input signal.

SYMPTOM	CAUSE	REMEDY
Can not select CSII mode.	Input signal is incompatible.	Use PCM input signal or analog input signal.
No output to Sub Woofer Out.	Sub-woofer = NONE has been selected in SETUP mode.	Select Sub-woofer = YES.
Noise is produced during DTS-encoded CD or laser disc play.	Analog has been selected for input.	Be sure to perform digital connection, select digital input, then play.
A specific channel does not produce output.	Nothing recorded on source.	Check the encoded channel on the source side.
FM or AM reception fails.	Antenna connection is incomplete.	Correctly connect the indoor FM and AM antennas to FM and AM antenna outlets.
Noise is heard during AM reception.	Reception is affected by other electrical fields.	Try changing location where the AM indoor antenna is set up.
Noise is heard during FM reception.	The radio waves from the broadcasting station are weak.	Install an FM outdoor antenna.
Cannot get programmed station when the PRESET button is pressed.	Preset data has been erased.	Disconnecting power plug for long periods of time will erase preset data. If that happens, input the preset data again.
Control with the remote control unit fails.	Batteries are consumed.	Replace all the batteries with new ones.
	Remote controller's function-key setting is wrong.	Select different position from which equipment will be controlled.
	The distance between this SR4400 and the remote commander is too far.	Move closer to this SR4400.
	Something is blocking SR4400 and the remote commander.	Remove offending object.

**GENERAL MALFUNCTION**

If the equipment malfunctions, this may be because an electrostatic discharge or AC line interference has corrupted the information in the equipment memory circuits. Therefore:

- disconnect the plug from the AC line supply
- after waiting at least three minutes, reconnect the plug to the AC line supply
- re-attempt to operate the equipment

**Memory backup**

- In case a power outage occurs or the power cord is accidentally unplugged, the SR4400 is equipped with a backup function to prevent memory data such as the preset memory from being erased.

**HOW TO RESET THE UNIT**

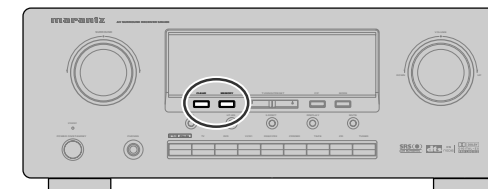

Should the operation or display seem to be abnormal, reset the unit with the following procedure.

The SR4400 is turned on, press and hold the **CLEAR** and **MEMORY** buttons simultaneously for 3 seconds or more.

Remember that the procedure will reset the settings of the function selector, Surround mode, delay time, TUNER PRESET etc., to their initial settings.

# TECHNICAL SPECIFICATIONS

## FM TUNER SECTION

Frequency Range ..... 87.5 - 108.0 MHz  
 Usable Sensitivity ..... IHF 1.8  $\mu$ V/16.4 dBf  
 Signal to Noise Ratio ..... Mono/Stereo 76/72 dB  
 Distortion Mono/Stereo ..... Mono/Stereo 0.2/0.3 %  
 Stereo Separation ..... 1 kHz 45 dB  
 Alternate Channel Selectivity .....  $\pm$  400 kHz 60 dB  
 Image Rejection ..... 98 MHz 70 dB  
 Tuner Output Level ..... 1 kHz,  $\pm$  75 kHz Dev800 mV

## AM TUNER SECTION

Frequency Range ..... 520 - 1710 kHz  
 Signal to Noise Ratio ..... 50 dB  
 Usable Sensitivity ..... Loop 500  $\mu$  V/m  
 Distortion ..... 400 Hz, 30 % Mod. 0.5 %  
 Selectivity .....  $\pm$  20 kHz 70 dB

## AUDIO SECTION

Power Output (20Hz – 20kHz / THD=0.08%)  
 Front L&R ..... 8ohms 80W/Ch  
 Center ..... 8ohms 80W/Ch  
 Surround L&R ..... 8ohms 80W/Ch  
 Surround Back ..... 8ohms 80W/Ch

Front L&R ..... 6ohms 95W/Ch  
 Center ..... 6ohms 95W/Ch  
 Surround L&R ..... 6ohms 95W/Ch  
 Surround Back ..... 6ohms 95W/Ch

Input Sensitivity/Impedance ..... 360 mV/ 47 kohms  
 Signal to Noise Ratio (Analog Input/Source Direct) ..... 95 dB  
 Frequency Response  
 (Analog Input/Source Direct) ..... 8Hz-70kHz( $\pm$ 3dB)  
 (Digital Input/96kHz PCM) ..... 8Hz-45kHz( $\pm$ 3dB)

## VIDEO SECTION

Television Format ..... NTSC  
 Input Level/Impedance ..... 1 Vp-p/ 75 ohms  
 Output Level/Impedance ..... 1 Vp-p/ 75 ohms  
 Video Frequency Response ..... 5 Hz to 8 MHz (– 1 dB)  
 Signal to Noise Ratio ..... 60 dB

## GENERAL

Power Requirement ..... AC 120 V 60 Hz  
 Power Consumption ..... 325W  
 Weight ..... 27.6 lbs (12.5 Kg)

## ACCESSORIES

Remote Control Unit RC5400SR ..... 1  
 AAA-size batteries ..... 2  
 FM Antenna ..... 1  
 AM Loop Antenna ..... 1  
 Warranty Card (for USA) ..... 1  
 Warranty Card (for CANADA) ..... 1  
 User Guide ..... 1

Specifications subject to change without prior notice.

# DIMENSION

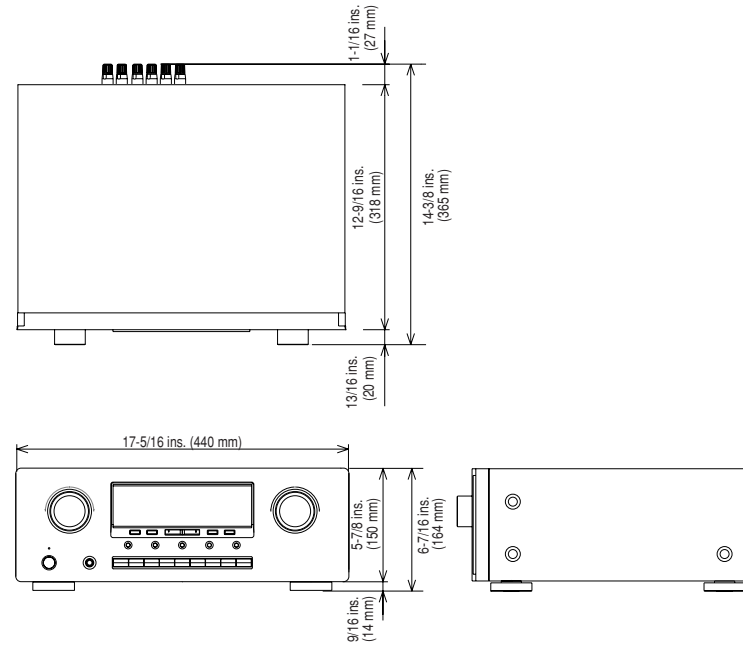



# SETUP CODES

## CD

Aiwa .....	0151, 0184
Burmester .....	0447
California Audio Labs .....	0056, 0330
Carver .....	0184, 0206, 0326, 0464
DKK .....	0027
Denon .....	0030
Emerson .....	0332
Fisher .....	0201, 0206
Garrard .....	0420, 0447
Genexxa .....	0059, 0332
Harman/Kardon .....	0184, 0200
Hitachi .....	0059
JVC .....	0099
Kenwood .....	0055, 0064, 0217
Krell .....	0184
LXI .....	0332
Linn .....	0184
Luxman .....	0062, 0120, 0293, 0354, 0355, 0457, 0459, 0510, 0516
MCS .....	0056
MTC .....	0447
Magnavox .....	0184, 0332
Marantz .....	0056, 0184, 0207, 1207, 0999,
Mission .....	0184
NAD .....	0046, 0326, 0343, 0747, 0748
NSM .....	0184
Nakamichi .....	0106, 0174, 0466, 0471, 0691
Nikko .....	0201
Onkyo .....	0128
Optimus .....	0027, 0059, 0064, 0172, 0206, 0332, 0447, 0464, 0495
Panasonic .....	0056, 0330
Parasound .....	0447
Philips .....	0184
Pioneer .....	0059, 0271, 0332, 0495
Polk Audio .....	0184
Proton .....	0184
QED .....	0184
Quasar .....	0056
RCA .....	0059, 0080, 0206, 0332, 0495, 0791
Realistic .....	0206, 0207, 0447
Rotel .....	0184, 0447
SAE .....	0184
Sansui .....	0184, 0332
Sanyo .....	0206

Scott .....	0332
Sears .....	0332
Sharp .....	0064, 0207
Sherwood .....	0207
Sonic Frontiers .....	0184
Sony .....	0027, 0212
Soundesign .....	0172
Tascam .....	0447
Teac .....	0201, 0207, 0420, 0447
Technics .....	0056, 0330
Toshiba .....	0046, 0326
Victor .....	0099
Wards .....	0080, 0184
Yamaha .....	0063, 0214
Yorx .....	0488

## MD PLAYERS

Denon .....	1900
Kenwood .....	1708, 1853
Marantz .....	1207
Onkyo .....	1895
Optimus .....	1090
Pioneer .....	1090
Sharp .....	1888
Sherwood .....	1094
Sony .....	1517
Yamaha .....	1915

## CDR

Marantz .....	0999
---------------	------

## TAPE

Aiwa .....	0056, 0224
Carver .....	0056
Denon .....	0103
Garrard .....	0335, 0336
Harman/Kardon .....	0056, 0209
JVC .....	0271, 0300
Kenwood .....	0097
Magnavox .....	0056
Marantz .....	0056
NAD .....	0171
Onkyo .....	0162, 0309
Optimus .....	0054, 0247

Panasonic .....	0256
Philips .....	0056
Pioneer .....	0054, 0126, 0247
Polk Audio .....	0056
RCA .....	0054, 0247
Samsung .....	0418, 0419
Sansui .....	0056
Sony .....	0197, 0270, 0318
Teac .....	0307, 0335, 0336, 0418, 0419
Technics .....	0256
Victor .....	0300
Wards .....	0054
Yamaha .....	0121, 0124

## SAT (DSS)

AlphaStar .....	0799
Echostar .....	0802, 1032
Expressvu .....	0802
General Instrument .....	0388, 0654, 0896
HTS .....	0802
Hitachi .....	0846
Hughes Network Systems .....	0776
JVC .....	0802
Jerrold .....	0388, 0654
Magnavox .....	0749, 0751
Memorex .....	0751
Next Level .....	0896
Panasonic .....	0728
Philips .....	0749, 0751, 1103
Primestar .....	0388, 0654
RCA .....	0170, 0419, 0593, 0882
Radio Shack .....	0896
Sony .....	0666
Star Choice .....	0896
Toshiba .....	0776, 0817
Uniden .....	0749, 0751
Zenith .....	0883

## TV

AOC .....	0046, 0057
Admiral .....	0120, 0490
Aiko .....	0119
Akai .....	0057
Alaron .....	0206
Ambassador .....	0204
America Action .....	0207
Anam .....	0207

Audiovox .....	0119, 0207, 0478, 0650
Baysonic .....	0207
Belcor .....	0046
Bell & Howell .....	0043, 0181
Bradford .....	0207
Brockwood .....	0046
Broksonic .....	0263, 0490
CXC .....	0207
Candle .....	0057, 0083
Carnivale .....	0057
Carver .....	0081
Celebrity .....	0027
Cineral .....	0119, 0478
Citizen .....	0057, 0083, 0087, 0119
Concerto .....	0083
Contec .....	0207
Craig .....	0207
Crosley .....	0081
Crown .....	0207
Curtis Mathes .....	0043, 0057, 0074, 0078, 0081, 0083, 0087, 0120, 0172, 0181, 0193, 0478, 1174, 1374
Daewoo .....	0046, 0119, 0478, 0650, 0651
Daytron .....	0046
Denon .....	0172
Dumont .....	0044, 0046
Dwin .....	0747, 0801
Electroband .....	0027
Emerson .....	0046, 0181, 0204, 0205, 0206, 0207, 0263, 0490, 0650, 0651
Envision .....	0057
Fisher .....	0181
Fujitsu .....	0206, 0710
Funai .....	0206, 0207
Futuretech .....	0207
GE .....	0074, 0078, 0120, 0205, 0478, 1174, 1374
Gibraltar .....	0044, 0046, 0057
GoldStar .....	0046, 0057, 0083, 0205
Gradiente .....	0080, 0083
Grunpy .....	0206, 0207
Hallmark .....	0205
Harley Davidson .....	0206
Harman/Kardon .....	0081
Harvard .....	0207
Hitachi .....	0043, 0083, 0172
Infinity .....	0081
Inteq .....	0044
JBL .....	0081
JCB .....	0027

JVC .....	0080	Sampo .....	0057	Audiovox .....	0064	Magnin .....	0267
KEC .....	0207	Samsung .....	0046, 0057, 0083, 0087, 0205	Beaumarck .....	0267	Marantz .....	0062, 0108, 1408
KTV .....	0057, 0207	Sansei .....	0478	Bell & Howell .....	0131	Marta .....	0064
Kenwood .....	0046, 0057	Sansui .....	0490	Broksonic .....	0148, 0211, 0236, 0506	Matsushita .....	0062, 0189
LG .....	0083	Sanyo .....	0181	CCE .....	0099, 0305	Memorex .....	0027, 0062, 0064, 0066, 0074, 0075, 0131, 0189, 0236, 0267, 0506, 1064, 1189, 1289
LXI .....	0074, 0081, 0181, 0183, 0205	Scimitsu .....	0046	Calix .....	0064	Minolta .....	0069
Logik .....	0043	Scotch .....	0205	Canon .....	0062	Mitsubishi .....	0070, 0075, 0094
Luxman .....	0083	Scott .....	0046, 0205, 0206, 0207, 0263	Carver .....	0108	Motorola .....	0062, 0075
MGA .....	0046, 0057, 0177, 0205	Sears .....	0074, 0081, 0083, 0181, 0183, 0205, 0206	Cineral .....	0305	Multitech .....	0027, 0099
MTC .....	0046, 0057, 0083, 0087	Semivox .....	0207	Colt .....	0099	NAD .....	0085
Magnavox .....	0057, 0081, 0206, 1281	Semp .....	0183	Craig .....	0064, 0074, 0099, 0267	NEC .....	0094, 0131
Majestic .....	0043	Sharp .....	0120, 0192, 0715	Curtis Mathes .....	0062, 0087, 0189	Nikko .....	0064
Marantz .....	0057, 0081, 1581	Shogun .....	0046	Cybernex .....	0267	Noblex .....	0267
Matsushita .....	0277	Signature .....	0043	Daewoo .....	0072, 0305	Olympus .....	0062
Megatron .....	0172, 0205	Sony .....	0027	Denon .....	0069	Optimus .....	0064, 0075, 0085, 0131, 0189, 0459, 1075, 1089, 1189, 1289
Memorex .....	0043, 0083, 0177, 0181, 0205, 0206, 0277, 0490	Soundesign .....	0205, 0206, 0207	Dynatech .....	0027	Orion .....	0211, 0236, 0506
Midland .....	0044, 0074, 0078	Starlite .....	0207	Electrohome .....	0064	Panasonic .....	0062, 0189, 0252, 0643, 1089, 1189, 1289
Mitsubishi .....	0046, 0120, 0177, 0205	Supreme .....	0027	Electrohome .....	0064	Penney .....	0062, 0064, 0069, 0267
Motorola .....	0120	Sylvania .....	0057, 0081	Emerex .....	0059	Pentax .....	0069
Multitech .....	0207	TMK .....	0083, 0204, 0205	Emerson .....	0027, 0064, 0070, 0148, 0211, 0236, 0305, 0506	Philco .....	0062, 0236, 0506
NAD .....	0183, 0193, 0205	TNCi .....	0044	Fisher .....	0074, 0131	Philips .....	0062, 0108, 0645, 1108, 1208
NEC .....	0046, 0057, 0083	Tandy .....	0120	Fuji .....	0062	Pilot .....	0064
NTC .....	0119	Technics .....	0078, 0277	Funai .....	0027	Pioneer .....	0085, 0094
Nikko .....	0057, 0119, 0205	Technol Ace .....	0206	GE .....	0062, 0075, 0087, 0267	Polk Audio .....	0108
Onwa .....	0207	Techwood .....	0078, 0083	Garrard .....	0027	Profitronic .....	0267
Optimus .....	0181, 0193, 0277	Teknika .....	0043, 0046, 0081, 0083, 0087, 0119, 0177, 0206, 0207	Go Video .....	0459	Proscan .....	0087
Optonica .....	0120, 0192	Telefunken .....	0083	GoldStar .....	0064	Protec .....	0099
Orion .....	0206, 0263, 0490	Toshiba .....	0087, 0181, 0183, 1283	Gradiente .....	0027	Pulsar .....	0066
Panasonic .....	0078, 0277	Vector Research .....	0057	Hi-Q .....	0074	Quasar .....	0062, 0189, 1189
Penney .....	0046, 0057, 0074, 0078, 0083, 0087, 0183, 0205, 1374	Victor .....	0080	Harley Davidson .....	0027	RCA .....	0062, 0069, 0075, 0085, 0087, 0267
Philco .....	0046, 0057, 0081, 0172, 0490	Vidikron .....	0081	Harman/Kardon .....	0108	Radio Shack .....	0027, 1064
Philips .....	0081	Vidtech .....	0046, 0205	Harwood .....	0099	Radix .....	0064
Pilot .....	0046, 0057	Wards .....	0043, 0046, 0057, 0081, 0083, 0192, 0205, 0206	Hitachi .....	0027, 0069	Randex .....	0064
Pioneer .....	0193, 0706	White Westinghouse .....	0490, 0650, 0651	Hughes Network Systems .....	0069	Realistic .....	0027, 0062, 0064, 0074, 0075, 0131
Portland .....	0046, 0119	Yamaha .....	0046, 0057	JVC .....	0094	ReplayTV .....	0641, 0643
Prism .....	0078	Zenith .....	0043, 0044, 0119, 0490, 0651	KEC .....	0064, 0305	Runco .....	0066
Proscan .....	0074			KLH .....	0099	STS .....	0069
Proton .....	0205			Kenwood .....	0094	Samsung .....	0072, 0267
Pulsar .....	0044, 0046			Kodak .....	0062, 0064	Sanky .....	0066, 0075
Quasar .....	0078, 0192, 0277			LXI .....	0064	Sansui .....	0027, 0094, 0236, 0506
RCA .....	0046, 0074, 0078, 0117, 0120, 0706, 1074, 1174, 1274, 1374, 1474			Lloyd's .....	0027	Sanyo .....	0074, 0131, 0267
Radio Shack .....	0046, 0057, 0074, 0083, 0181, 0192, 0205, 0207			Logik .....	0099	Scott .....	0070, 0072, 0148, 0211
Realistic .....	0046, 0057, 0083, 0181, 0192, 0205, 0207			MEI .....	0062	Sears .....	0027, 0062, 0064, 0069, 0074, 0131
Runco .....	0044, 0057, 0630			MGA .....	0070, 0267	Semp .....	0072
SSS .....	0046, 0207			MGN Technology .....	0267	Sharp .....	0075
				MTC .....	0027, 0267	Shintom .....	0099
				Magnasonic .....	0305		
				Magnavox .....	0027, 0062, 0066, 0108		

## VCR

Admiral .....	0075, 0236
Adventura .....	0027
Aiko .....	0305
Aiwa .....	0027, 0064
America Action .....	0305
American High .....	0062
Asha .....	0267

Shogun .....	0267
Singer .....	0099
Sony .....	0027, 0059, 0062, 1059
Sylvania .....	0027, 0062, 0070, 0108
Symphonic .....	0027
TMK .....	0267
Teac .....	0027
Technics .....	0062, 0189
Teknika .....	0027, 0062, 0064
Thomas .....	0027
Tivo .....	0645
Toshiba .....	0070, 0072
Totevision .....	0064, 0267
Unitech .....	0267
Vector .....	0072
Video Concepts .....	0072
Videosonic .....	0267
Wards .....	0027, 0062, 0069, 0074, 0075, 0087, 0099, 0108, 0267
White Westinghouse .....	0099, 0236, 0305
XR-1000 .....	0027, 0062, 0099
Zenith .....	0027, 0066, 0236, 0506

## DVD

Aiwa .....	0668
Apex .....	0699
Denon .....	0517, 0661
Fisher .....	0697
GE .....	0549
Harman/Kardon .....	0609
Hitachi .....	0691
Hiteker .....	0699
JVC .....	0585, 0650
Kenwood .....	0561, 0709
Magnavox .....	0530, 0702
Marantz .....	0566
Mitsubishi .....	0548
Onkyo .....	0530, 0654
Optimus .....	0598
Oritron .....	0678
Panasonic .....	0517, 0659
Philips .....	0530, 0566
Pioneer .....	0552, 0598, 0659
Proscan .....	0549
RCA .....	0549, 0598
Samsung .....	0600
Sharp .....	0657
Sony .....	0560
Technics .....	0517
Theta Digital .....	0598
Toshiba .....	0530
Yamaha .....	0517, 0572
Zenith .....	0530, 0618

## **www.marantz.com**

You can find your nearest authorized distributor or dealer on our website.

---

<b>JAPAN</b>	Marantz Japan, Inc.	35-1 Sagami Ohno 7-Chome, Sagamihara-shi, Kanagawa 228-8505, Japan
<b>U.S.A.</b>	Marantz America, Inc.	1100 Maplewood Drive, Itasca, IL 60143, U.S.A.
<b>EUROPE</b>	Marantz Europe B.V.	P.O. Box 8744, 5605 LS Eindhoven, The Netherlands

---

Manufactured under license from Dolby Laboratories. "Dolby", "Pro Logic", and the double-D symbol are trademarks of Dolby Laboratories. "DTS", "DTS-ES Extended Surround" and "Neo:6" are trademarks of Digital Theater Systems, Inc.

**marantz**<sup>®</sup> is a registered trademark.



## Free Manuals Download Website

<http://myh66.com>

<http://usermanuals.us>

<http://www.somanuals.com>

<http://www.4manuals.cc>

<http://www.manual-lib.com>

<http://www.404manual.com>

<http://www.luxmanual.com>

<http://aubethermostatmanual.com>

Golf course search by state

<http://golfingnear.com>

Email search by domain

<http://emailbydomain.com>

Auto manuals search

<http://auto.somanuals.com>

TV manuals search

<http://tv.somanuals.com>