

DIGITAL CAMERA

OLYMPUS[®]

FE-330/X-845/C-550

Advanced Manual

Quick Start Guide

Get started using your camera right away.

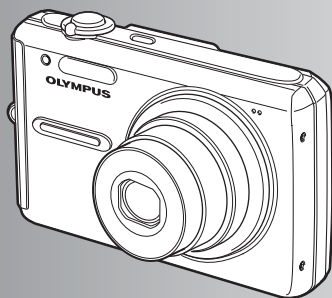

Button operations

Menu operations

Printing pictures

Using OLYMPUS Master

Getting to know your camera better

Appendix

- Thank you for purchasing an Olympus digital camera. Before you start to use your new camera, please read these instructions carefully to enjoy optimum performance and a longer service life. Keep this manual in a safe place for future reference.
- We recommend that you take test shots to get accustomed to your camera before taking important photographs.
- In the interest of continually improving products, Olympus reserves the right to update or modify information contained in this manual.
- The screen and camera illustrations shown in this manual were produced during the development stages and may differ from the actual product.

Download from www.Somanuals.com. All Manuals Search And Download.

Quick Start Guide	P. 3	
Button operations	P. 11	Test out the functions of the camera buttons by following along with the illustrations.
Menu operations	P. 18	Learn about the menus that control the functions and settings for basic operation.
Printing pictures	P. 30	Learn how to print pictures you have taken.
Using OLYMPUS Master	P. 35	Learn how to transfer and save pictures to a computer.
Getting to know your camera better	P. 39	Find out more about camera operations and how to take better pictures.
Appendix	P. 47	Read about convenient functions and safety precautions to use your camera more effectively.

Gather these items (box contents)



Digital Camera



Strap

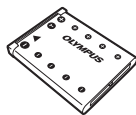

Lithium Ion Battery
(LI-42B)



Battery Charger
(LI-40C)

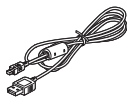

USB Cable

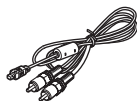

AV Cable



OLYMPUS Master 2
CD-ROM

Items not shown: Advanced Manual (this manual), Basic Manual, and the Warranty Card. Contents may vary depending on purchase location.

Attach the strap

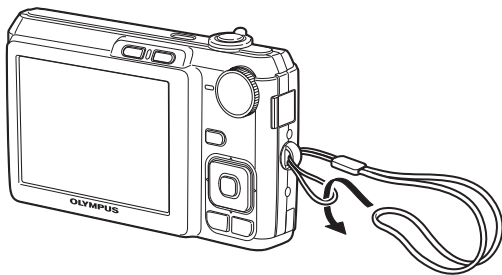

- Pull the strap tight so that it does not come loose.

Prepare the camera

a. Charge the battery.

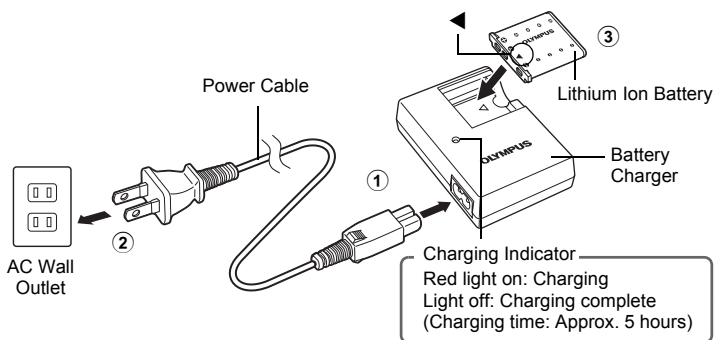

- Battery comes partially charged.

b. Insert the battery and the xD-Picture Card (optional) into the camera.

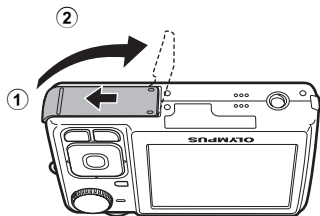

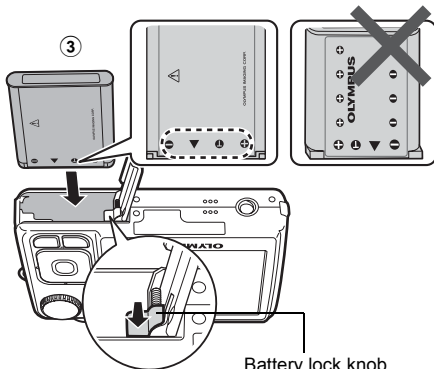

Battery lock knob

- To remove the battery, press the battery lock knob in the direction of the arrow.

- Insert the battery by putting in the ▼ marked side first, with the - marks toward the end of the camera, the + marks toward the center of the camera.

If you insert the battery incorrectly, you may not be able to remove it. Do not use force. Contact authorized distributors/service centers. Damage to the battery exterior (scratches, etc.) may produce heat or an explosion.

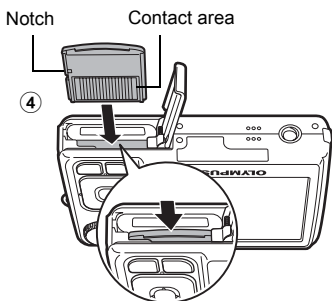

- Orient the card as shown in the illustration and insert it straight into the card slot. Insert the card until it clicks into place.

- To remove the card, push the card all the way in, release slowly, grasp the card and remove it.

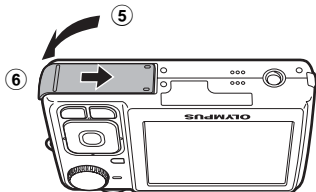

- With this camera, you can take pictures without inserting the optional xD-Picture Card™ (hereinafter referred to as “the card”). If you take pictures without inserting the card, the pictures will be stored in the internal memory. For details on the card, please refer to “The card” (P. 48).

Turn the camera on

This explains how to turn on the camera in shooting mode.

a. Set the mode dial to **AUTO**.

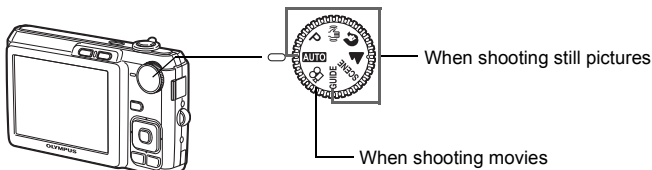

Still picture shooting modes

AUTO	The camera automatically determines the optimum settings for shooting pictures.
P	The camera automatically sets the optimum aperture value and shutter speed.
	This function reduces blur incurred by a moving subject or camera shake when taking pictures.
	Suitable for taking pictures of people.
	Suitable for taking pictures of a landscape.
SCENE	Select from 11 available scene modes, according to the shooting conditions.
GUIDE	Use the shooting guide displayed on the screen to shoot pictures according to the situation.

b. Press the **POWER** button.

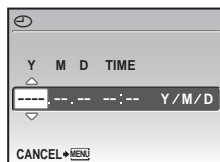
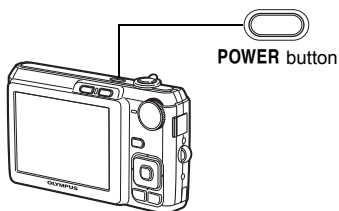

- This screen is displayed if the date and time are not set.

- To turn off the camera, press the **POWER** button once again.

Hint

The directions of the arrow pad is indicated with $\Delta \nabla \leftarrow \rightarrow$ in the supplied instruction manual.

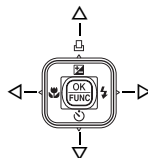

Set the date and time

The date and time screen

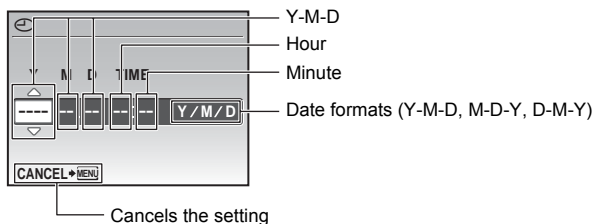

a. Press the and buttons to select [Y].

- The first two digits of the year are fixed.

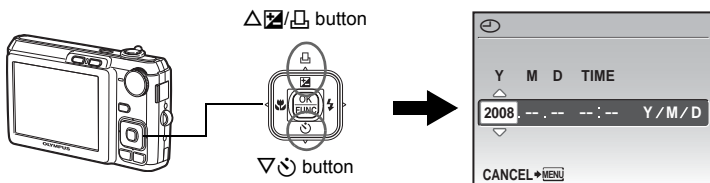

b. Press the button.

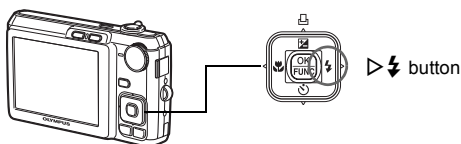

c. Press the and buttons to select [M].

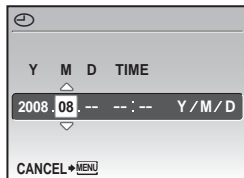

- d. Press the button.
- e. Press the and buttons to select [D].

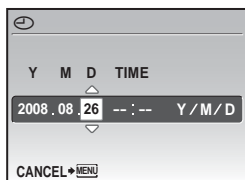

- f. Press the button.
- g. Press the and buttons to select the hours and minutes.
- The time is displayed in the 24-hour format.

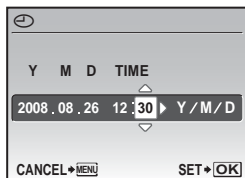

- h. Press the button.
- i. Press the and buttons to select [Y/M/D].

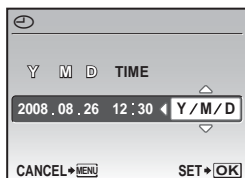

- j. After all settings have been set, press .
- For a more accurate setting, press when the time signal hits 00 seconds.

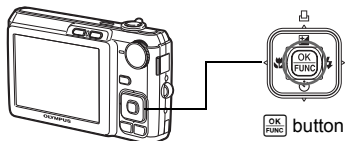

The number of storable still pictures is displayed.

Take a picture

a. Hold the camera.

Horizontal grip

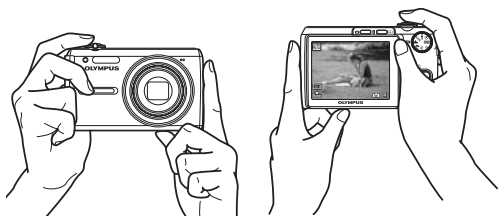

Vertical grip

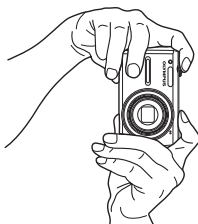

b. Focus.

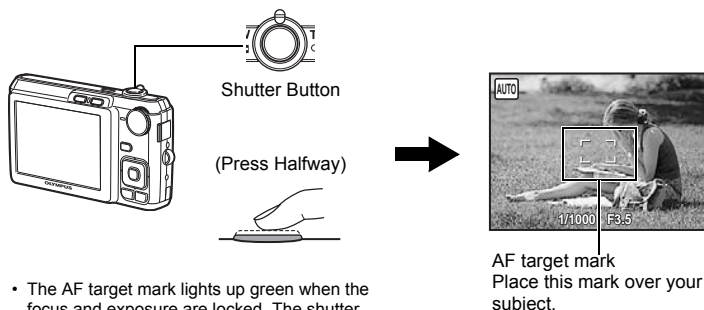

- The AF target mark lights up green when the focus and exposure are locked. The shutter speed and aperture value are also displayed.
- If the AF target mark blinks in red, the focus is not adjusted properly. Try locking the focus again.

c. Shoot.

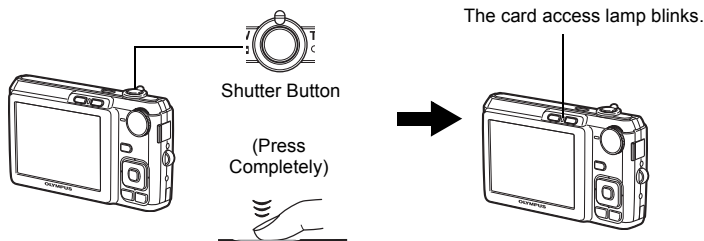

Review your pictures

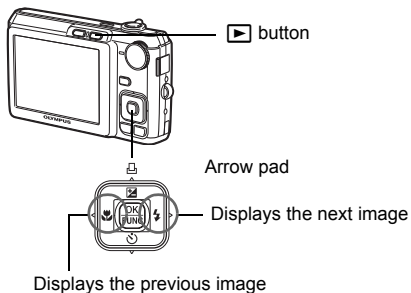

- a. Press the  button.

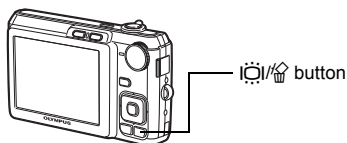

Erase pictures

- a. Press the  and  buttons to display the picture you want to erase.
- b. Press the  button.



- c. Press the   button, select [YES], and press .

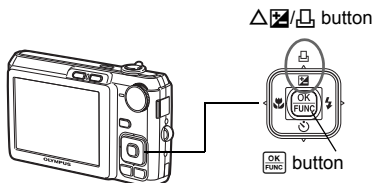

Button operations

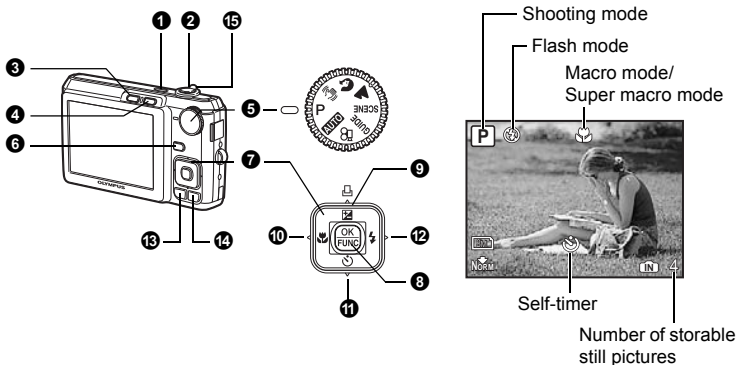

1 POWER button

Turning the camera on and off



Power on: Camera turns on in shooting mode.

- Lens extends
- Monitor turns on

2 Shutter button

Shooting pictures/Recording movies

Shooting still pictures

Set the mode dial to a setting other than , and lightly press the shutter button (halfway). The AF target mark lights up green when the focus and exposure are locked (focus lock). The shutter speed and aperture value are displayed (only when the mode dial is set to **AUTO**, **P** or ). Now press the shutter button all the way (completely) to shoot a picture.



AF target mark

Locking the focus and then composing the shot (focus lock)

Compose your picture with the focus locked, and then fully press the shutter button to shoot a picture.

- If the AF target mark blinks red, the focus is not adjusted properly. Try locking the focus again.

Recording movies

Set the mode dial to  and lightly press the shutter button to lock the focus. Then, press the shutter button completely to start recording. Press the shutter button again to stop recording.

3 button (Shooting)

Selecting shooting mode/Turning the camera on

Shooting mode is selected.

This function is used to set the camera to turn on in shooting mode when  is pressed with the camera off.

 “/ Turning on the camera with the  or  button” (P. 28)

4 button (Playback)

Selecting playback mode/Turning the camera on

The last picture taken is displayed.

• Press the arrow pad to view other pictures.

• Use the zoom lever to switch between close-up playback and index display.

This function is used to set the camera to turn on in playback mode when  is pressed with the camera off.

 “/ Turning on the camera with the  or  button” (P. 28)

Playing back movies

Select the movie in the playback mode and press  to play.



Operations during movie playback



Playing time/Total recording time

△: Increases the volume.

▽: Reduces the volume.

▷: Fast forwards playback when pressed and held.

◁: Rewinds playback when pressed and held.

• Press  to pause the playback.

Operations during pause



△: Displays the first frame.

▽: Displays the last frame.

▷: Plays when pressed and held.

◁: Plays the movie in reverse when pressed and held.

• To resume the movie, press .

• To cancel the playback of the movie in the middle of it or during pause, press **MENU**.

Set the mode dial to the desired shooting mode.

AUTO Shooting pictures with automatic settings

The camera determines the optimum settings for shooting pictures. [CAMERA MENU] settings such as ISO sensitivity cannot be changed.

P Set the optimum aperture value and shutter speed

The camera automatically sets the optimum aperture value and shutter speed for the brightness of the subject. [CAMERA MENU] settings such as ISO sensitivity can be changed.

(i) Shooting pictures using digital image stabilization

This function reduces the blur incurred by a moving subject or camera shake when taking pictures.

(P) Shooting pictures according to the situation

Use PORTRAIT and LANDSCAPE to shoot pictures with the optimal settings.

SCENE Shooting pictures by selecting a scene mode according to the situation

Select from 11 available scene modes, according to the shooting conditions. Press **OK** to set.

☞ NIGHT+PORTRAIT / 🏃 SPORT / 🏠 INDOOR / 🕯 CANDLE /
 👤 SELF PORTRAIT / 🌅 SUNSET / 🎆 FIREWORKS / 🪞 BEHIND GLASS /
 🍴 CUISINE / 📄 DOCUMENTS / 🏠 AUCTION



- The scene selection screen displays sample images and the shooting mode to best suit the situation.
- To switch to a different scene mode after a scene mode has been selected, press **MENU** to select [SCENE] from the top menu and display the scene selection screen.
- By switching to another scene, most settings will be changed to the default settings of each scene.

GUIDE Follow the shooting guide

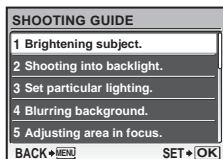

Follow the shooting guide displayed on the screen to set the target items.

- Press **MENU** to display the shooting guide again.
- To change the setting without using the shooting guide, set the shooting mode to another one.
- The content set using the shooting guide will change to the default setting by pressing **MENU** or changing the mode using the mode dial.

Recording movies

Audio is recorded with the movie.

- During audio recording, only the digital zoom can be used. To record the movie with the optical zoom, set [M] (movie) to [OFF].

 “M (movie) Recording movies with or without sound” (P. 22)



This icon lights during movie recording.

The remaining recording time is displayed. When the remaining recording time reaches 0, recording stops.

6 DISP./ button Changing the information on display/Display the menu guide

DISP. Changing the information displays

Press DISP. to change the display in the following order.

Shooting mode

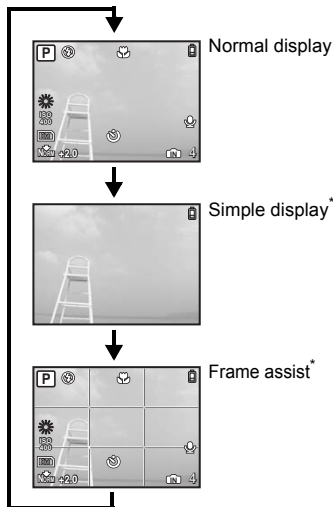

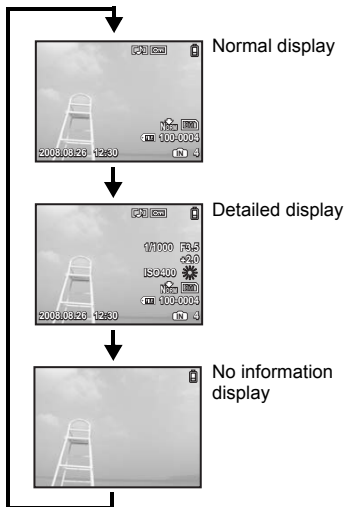

Playback mode

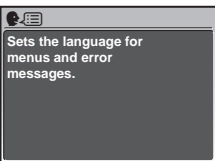

* This is not displayed when the mode dial is set to  or GUIDE.

Displaying the menu guide



With a menu item highlighted, press and hold down  to display the menu guide which will provide more information on the function or setting.

7 Arrow pad (△▽◀▶)

Use the arrow pad to select scenes, items on the menus, and to play back pictures.

8 button (OK/FUNC)

Displays the Function Menu which contains the functions and settings used during shooting. This button is also used to confirm your selection.

The functions you can set with the Function Menu

- ☞ “WB Adjusting the color of a picture” (P. 21)
- ☞ “ISO Changing the ISO sensitivity” (P. 22)
- ☞ “IMAGE QUALITY Changing the image quality” (P. 20)

Function Menu



The current camera settings are displayed.

△▽: Select the function to be set.

◀▶: Select a setting, and press .

9 button

Changing picture brightness (Exposure compensation)/ Printing pictures

Shooting mode: Changing picture brightness

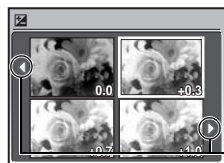

Press  in shooting mode, use the arrow pad to select preferred brightness, and press .

- Adjustable from -2.0 EV to +2.0 EV

Use  to change the display.

Playback mode: Printing pictures

Display a picture to print out in playback mode, connect the camera to the printer, and then press  to print the picture.



- ☞ “Direct printing (PictBridge)” (P. 30)

10 button

Shooting pictures close to the subject (Macro mode)

Press  in shooting mode to select the macro mode.



Press  to set.

OFF	Macro off	Cancels macro mode.
	Macro mode	This mode lets you shoot from as close as 10 cm/3.9 in. (when the zoom is set for the zoom-out angle) and as close as 60 cm/23.6 in. (when the zoom is set for the zoom-in angle) to your subject.
	Super macro mode	This mode lets you shoot from as close as 3 cm/1.2 in. to your subject. The zoom position is fixed automatically and cannot be changed.

- Zoom and flash cannot be used in super macro mode.

Download from Www.Somanuals.com. All Manuals Search And Download.



11  **button****Self-timer shooting**



Press  in shooting mode to select ON or OFF for the self-timer.
Press  to set.

OFF	Cancel the self-timer.
ON	Set the self-timer.

- After setting the self-timer, press the shutter button completely. Then, the self-timer lamp lights for approximately 10 seconds, blinks for approximately 2 seconds, and the shutter is released.
- To cancel the self-timer, press .
- Self-timer shooting is automatically canceled after one shot.

12  **button****Flash shooting**

Press  in shooting mode to select the flash mode.
Press  to set.

AUTO	Flash auto	The flash fires automatically in low light or backlight conditions.
	Red-eye reduction flash	This emits pre-flashes for red-eye reduction.
	Fill-in flash	The flash fires regardless of the available light.
	Flash off	The flash does not fire.

13 **MENU** button**Displaying the top menu**

Displays the top menu.

14  **button****Increasing the brightness of the monitor (Backlight boost)/
Erasing pictures**** Increasing the brightness of the monitor (Backlight boost)**

The monitor lights brighter when  is pressed in shooting mode. If there is no operation for 10 seconds, it dims back to the original brightness.

- When [BRIGHT] is selected in , the monitor brightness does not change.

 Erasing pictures

In playback mode, select the picture you want to erase, and press .

- Once erased, pictures cannot be restored. Check each picture before erasing to avoid accidentally erasing pictures you want to keep.

 "Protecting pictures" (P. 25)

Shooting mode: Zooming in on your subject

Optical zoom: 5×

Digital zoom: 4× (optical zoom × digital zoom: Max. 20×)

Zoom out:

Turn the zoom lever to the W-side.

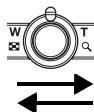
**Zoom in:**

Turn the zoom lever to the T-side.

Zoom bar

The zoom bar appears white when the current zoom position is within the optical zoom area. When the digital zoom activates, the zoom bar appears yellow and the image is further enlarged.

Playback mode: Switching the picture display**Single-frame playback**

- Use the arrow pad to browse pictures.

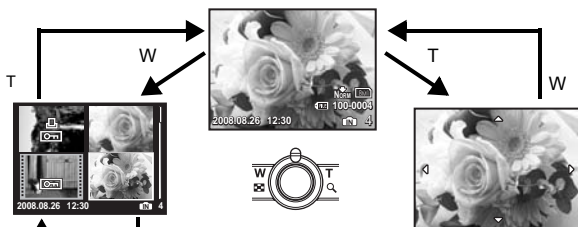
**Index display**

- Use the arrow pad to select a picture for playback, and press to play back the single-frame of the picture selected.

Close-up playback

- Turn and hold the zoom lever to the T-side to incrementally zoom in (up to 10 times the original size), and to the W-side to zoom out.
- Press the arrow pad during close-up playback to scroll the picture in the indicated direction.
- When returning to the single-frame playback, press .

Menu operations

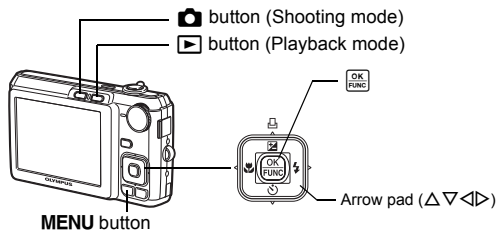

About the menus

Press **MENU** to display the top menu on the monitor.

- The contents displayed on the top menu differ according to the mode.

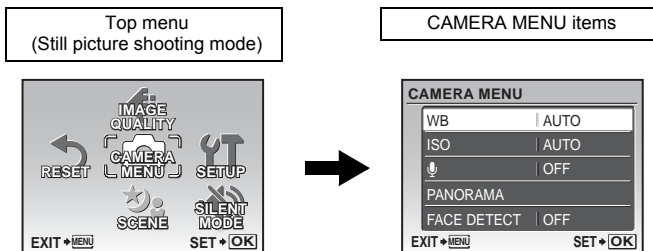

- Select [CAMERA MENU], [PLAYBACK MENU], [EDIT], [ERASE] or [SETUP] and press **OK FUNC**. The screen for selecting the menu item is then displayed.
- When the mode dial is set to **GUIDE** and the settings are made by following the shooting guide, press **MENU** to display the shooting guide screen.

Operation guide

During menu operations, the buttons and their respective functions are displayed at the bottom of the screen. Follow these guides to navigate the menus.

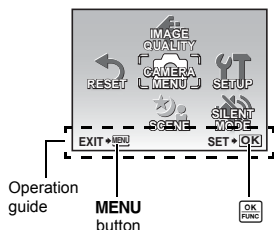

- BACK → MENU** : Moves back one menu.
- EXIT → MENU** : Exits the menu.
- SET → OK** : Sets the selected item.

Using the menus

This explains how to use the menus with the [POWER SAVE] setting as an example.

1 Set the mode dial to a setting other than GUIDE.

2 Press MENU to display the top menu. Press \triangleright to select [SETUP], and press $\boxed{\text{OK/FUNC}}$.

- [POWER SAVE] is on a menu in [SETUP].



3 Press \triangle/∇ to select [POWER SAVE], and press $\boxed{\text{OK/FUNC}}$.

- Unavailable settings cannot be selected.
- Press \triangleleft on this screen to move the cursor to the page display. Press \triangle/∇ to change the page. To return to the item selection screen, press \triangleright or $\boxed{\text{OK/FUNC}}$.

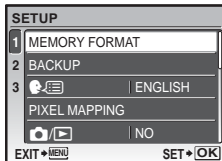

Page display: _____
This mark is displayed when there are more menu items on the next page.

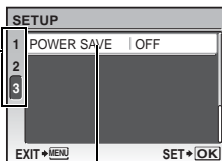

The selected item is displayed in a different color.

4 Press \triangle/∇ to select [OFF] or [ON], and press $\boxed{\text{OK/FUNC}}$.

- The menu item is set and the previous menu is displayed. Press MENU repeatedly to exit the menu.
- To cancel any changes and continue operating the menus, press MENU without pressing $\boxed{\text{OK/FUNC}}$.

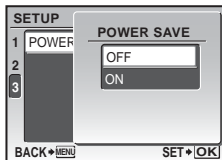

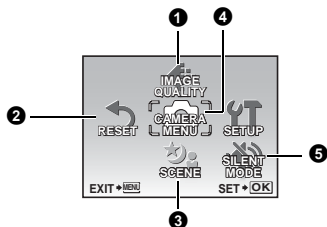

4 CAMERA MENU

WB
ISO
📷 (still picture)
📷 (movie)
PANORAMA*
FACE DETECT

* An Olympus xD-Picture Card is required.

- Some functions are not available according to the selected mode.
- 👉 “Functions available in shooting modes and scenes” (P. 46)
- 👉 “SETUP menus” (P. 27)
- The factory default settings are displayed in gray ().

1 IMAGE QUALITY

Changing the image quality

This function allows you to set [IMAGE SIZE] and [COMPRESSION].

Still picture image quality and their applications

IMAGE SIZE	Application
8M 3264 × 2448	• Suitable for printing pictures over A3 (11 × 17 in.).
5M 2560 × 1920	• Suitable for printing pictures at A4 (8.5 × 11 in.).
3M 2048 × 1536	• Suitable for printing pictures up to A4 (8 × 11 in.).
2M 1600 × 1200	• Suitable for printing pictures at A5 (5 × 7 in.).
1M 1280 × 960	• Suitable for printing pictures at postcard size.
VGA 640 × 480	• Suitable for viewing pictures on a TV or using pictures on emails and web sites.
16:9 1920 × 1080	• Suitable for playing pictures at Wide screen TV.

COMPRESSION

FINE FINE	• Shooting at high quality.
NORM NORMAL	• Shooting at normal quality.

Movie image quality

IMAGE SIZE

VGA 640 × 480
QVGA 320 × 240

- 👉 “Number of storable still pictures and recording length of movies” (P. 42)

2 RESET

Changing the shooting functions back to default settings

NO / YES

Restore shooting functions back to default settings.

Functions restored to the factory default settings

Function	Factory default setting	Ref. Page
SCENE	NIGHT+PORTRAIT	P. 13
DISP.	Normal display	P. 14
	0.0	P. 15
	OFF	P. 15
	OFF	P. 16
	AUTO	P. 16
IMAGE SIZE (Still picture/ Movie)	/	P. 20
COMPRESSION		P. 20
WB	AUTO	P. 21
ISO	AUTO	P. 22
(still picture)	OFF	P. 22
(movie)	ON	P. 22
FACE DETECT	OFF	P. 23

3 SCENE (Scene) Shooting pictures by selecting a scene according to the situation

The scene selection screen displays sample images and the shooting mode to best suit the situation. This can be set only when the mode dial is set to **SCENE**.

- By switching to another scene, most settings will be changed to the default settings of each scene.

"SCENE Shooting pictures by selecting a scene mode according to the situation" (P. 13)

4 CAMERA MENU

WBAdjusting the color of a picture

AUTO		The white balance is adjusted automatically for natural color, regardless of the light source.
	Sunny day	For shooting under a clear sky.
	Cloudy day	For shooting under a cloudy sky.
	Tungsten light	For shooting under tungsten lighting.
	Fluorescent lamp 1	For shooting under daylight fluorescent lamp. (This type of lamp is mainly used in homes.)
	Fluorescent lamp 2	For shooting under a neutral white fluorescent lamp. (This type of lamp is mainly used in desk lamps.)
	Fluorescent lamp 3	For shooting under a white fluorescent lamp. (This type of lamp is mainly used in offices.)

ISO Changing the ISO sensitivity

AUTO	Sensitivity is automatically adjusted according to the conditions of the subject.
64/100/200/400/ 640	A low value lowers the sensitivity for daylight shooting of clear, sharp pictures. The higher the value, the better the camera's light sensitivity and ability to shoot with a fast shutter speed and in low light conditions. However, high sensitivity introduces noise into the resulting picture, which may give it a grainy appearance.

🎤 (still picture) Recording sound with still pictures

OFF / ON

When activated [ON], the camera will record about 4 seconds of audio after the picture is taken.

When recording, aim the camera microphone at the source of the sound you want to record.

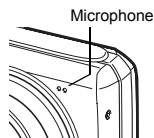

🎤 (movie) Recording movies with or without sound

OFF / ON

When [ON] (sound is recorded) is selected, the optical zoom cannot be used during movie recording. Only the digital zoom can be used.

PANORAMA Creating a panoramic picture

Panorama shooting lets you create a panoramic picture, using the OLYMPUS Master software on the provided CD-ROM. An Olympus xD-Picture Card is required for panorama shooting.

Connects pictures from left to right

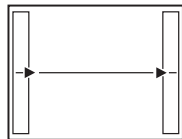

▷: The next picture is connected at the right edge.
◁: The next picture is connected at the left edge.

Connects pictures from bottom to top

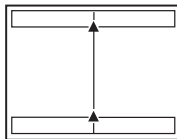

△: The next picture is connected at the top.
▽: The next picture is connected at the bottom.

Use the arrow pad to specify at which edge you want to connect the pictures; and then compose your shots so that the edges of the pictures overlap. The part of the previous picture where it will be joined to the next picture does not remain in the frame. You have to remember what the part in the frame looked like and take the next picture so it overlaps.



- Press **OK** / **FUNC** to exit.
- Panorama shooting is possible for up to 10 pictures. The warning mark (🚫) is displayed after 10 pictures have been taken.

FACE DETECT Focusing on a face

OFF /ON

The camera searches for a face within the frame and focuses on it.

- A face may not be detected depending on the subject.

5 SILENT MODE

Muting operational sounds

OFF /ON

This function allows you to mute operational sounds during shooting and playback (e.g. warning beeps, shutter sounds, etc.).

Playback mode menu

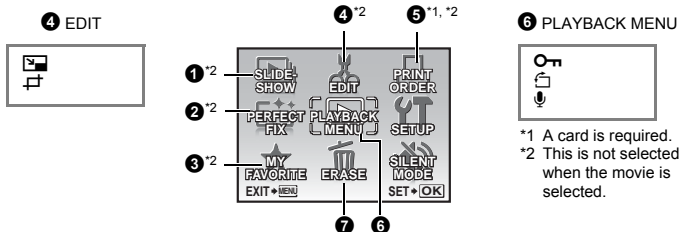

👉 “SETUP menus” (P. 27)

👉 “SILENT MODE Muting operational sounds” (P. 23)

- The factory default settings are displayed in gray ().

1 SLIDESHOW

Playing back pictures automatically

Press **OK** **FUNC** to start the slideshow.

- Only the first frame of each movie is displayed.
- To cancel the slideshow, press **OK** **FUNC** or **MENU**.

2 PERFECT FIX

Editing images

The recorded image is corrected and saved as a new one.

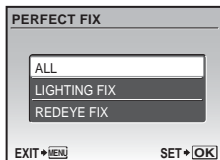

- Use Δ / ∇ to select the effect you want to apply, and press **OK** **FUNC**.
- Use \leftarrow / \rightarrow to display picture you want to edit and press **OK** **FUNC**.

ALL	Lighting fix and red-eye fix are activated together.
LIGHTING FIX	Edit only the portions that photographed dark when there is backlighting.
REDEYE FIX	Corrects a subject with red-eye.

- Movies, pictures shot by another camera, and previously fixed or edited pictures cannot be corrected.
- When edited pictures are displayed, the picture cannot be re-edited.
- Depending on the picture, the editing may not be effective.
- Editing an image may cause it to suffer a minor loss in quality.

Download from www.Somanuals.com. All Manuals Search And Download.

3 MY FAVORITE

Viewing and registering pictures in My Favorite

Registers and plays back your favorite still pictures as new ones in the internal memory. Up to 9 pictures can be registered.

- Registered pictures will not be erased even if the internal memory is formatted.
-  "Erasing pictures registered in MY FAVORITE" (P. 24)



Note

- Registered pictures cannot be edited, printed, copied to a card, transferred to a computer, or viewed on a computer.

VIEW FAVORITE..... Viewing registered pictures

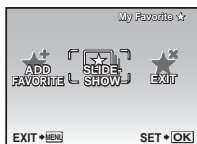

- Select [VIEW FAVORITE] to display pictures registered in MY FAVORITE. Use the arrow pad to browse pictures.
- Press **MENU** to select [ADD FAVORITE] or [SLIDESHOW].



ADD FAVORITE	Adds pictures to My Favorite. <ul style="list-style-type: none">Select a picture with \triangleleft and \triangleright, and press .
SLIDESHOW	Plays back registered pictures automatically. <ul style="list-style-type: none">Press  to exit the slideshow.
EXIT	Reverts to normal playback mode.

Erasing pictures registered in MY FAVORITE

YES/ NO

- Use the arrow pad to select the picture to be erased, and press . Select [YES], and press .
- Even if pictures registered in MY FAVORITE are erased, original pictures in the internal memory or the card may not be erased.

SET Registering favorite pictures



- Select a picture with \triangleleft and \triangleright , and press .

4 EDIT

..... Changing the size of pictures

VGA 640 × 480/ QVGA 320 × 240

This changes the image size of a picture and saves it as a new file.

..... Cropping a picture

Crop a picture, and save the cropped picture as a new picture.



- Use $\langle \triangleright \rangle$ to select a picture to be cropped and press $\boxed{\text{OK FUNC}}$.
- Use the arrow pad and zoom lever to adjust the position and size of the area-selection box, and press $\boxed{\text{OK FUNC}}$.

5 PRINT ORDER

Making print reservations (DPOF)

This function allows you to save printing data (the number of prints and the date and time information) with the pictures stored on the card.

☞ "Print settings (DPOF)" (P. 32)

6 PLAYBACK MENU

..... Protecting pictures

OFF / ON



Protected pictures cannot be erased using [ERASE], [SEL. IMAGE] or [ALL ERASE], but they are all erased by formatting.

- Select the picture with $\langle \triangleright \rangle$, and protect it by selecting [ON] with $\Delta \nabla$. You can protect several frames in succession. When a picture is protected, ON will be displayed on the monitor.

..... Rotating pictures

$\boxed{\text{+90°}}$ / $\boxed{\text{0°}}$ / $\boxed{\text{-90°}}$

Pictures taken with the camera held vertically are displayed horizontally. This function lets you turn such pictures so that they are displayed vertically. New picture orientations are saved even when the power is turned off.



Select a picture with $\langle \triangleright \rangle$, and select [$\boxed{\text{+90°}}$]/ $\boxed{\text{0°}}$]/ $\boxed{\text{-90°}}$] with $\Delta \nabla$ to rotate pictures. You can rotate several frames in succession.

..... Adding sound to still pictures

YES /NO



Sound is recorded for about 4 seconds.

- Use the arrow pad <|> to select a picture, select [YES] with $\Delta \nabla$ to begin recording, then press $\boxed{\text{OK FUNC}}$.
- The [BUSY] bar will be temporarily displayed.

7 ERASE

Erasing selected pictures/Erasing all pictures

Protected pictures cannot be erased. Cancel protection before erasing protected pictures. Once erased, pictures cannot be restored. Check each picture before erasing to avoid accidentally erasing pictures you want to keep.

- When erasing pictures in the internal memory, do not insert the card into the camera.
- When erasing pictures from the card, insert the card into the camera in advance.
- You can confirm on the monitor whether the internal memory or card is being used.

"Using the internal memory or card" (P. 48)

SEL. IMAGE Erasing by selecting the single-frame



- Use the arrow pad to select the picture, and press $\boxed{\text{OK FUNC}}$ to mark \checkmark on your selection.
- To cancel the selection, press $\boxed{\text{OK FUNC}}$ again.
- When the selection is completed, press $\boxed{\text{DISP/GO}}$.
- Select [YES], and press $\boxed{\text{OK FUNC}}$.

ALL ERASE Erasing all the pictures in the internal memory or on the card

- Select [YES], and press $\boxed{\text{OK FUNC}}$.

SETUP menu

Shooting mode

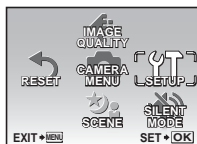

Playback mode

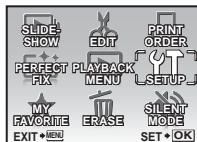

SETUP

MEMORY FORMAT (FORMAT^{*1})
BACKUP^{*1}
PIXEL MAPPING^{*2}
MENU COLOR
SOUND SETTINGS
VIDEO OUT
POWER SAVE

*1 A card is required.

*2 You cannot select this item in playback mode.

- The factory default settings are displayed in gray ().

MEMORY FORMAT (FORMAT)Formatting the internal memory or card

All existing data, including protected pictures, are erased when the internal memory or card is formatted (images registered to "My Favorite" are not erased). Make sure that you save or transfer important data to a computer before formatting.

- Make sure there is no card inserted in the camera when formatting the internal memory.
- Be sure that the card is inserted in the camera when formatting the card.
- Before using non-Olympus cards or cards which have been formatted on a computer, you must format them with this camera.

BACKUPCopying pictures in the internal memory to the card

Insert the optional card into the camera. Copying data does not erase the picture in the internal memory.

- It takes some time to back up data. Check that the battery is not empty before starting the copy.

.....Selecting a display language



You can select a language for on-screen display. Available languages vary depending on the area where you purchased this camera.

PIXEL MAPPING **Adjusting the image processing function**

The pixel mapping feature allows the camera to check and adjust the CCD and image processing functions. It is not necessary to operate this function frequently. Approximately once a year is recommended. Wait at least one minute after taking or viewing pictures to allow the pixel mapping function to perform properly. If you turn the camera off during pixel mapping, start again.

Select [PIXEL MAPPING]. When [START] is displayed, press .

 /  **Turning on the camera with the  or  button**

YES	Pressing  turns on the camera and starts the camera in the shooting mode. Pressing  turns on the camera and starts the camera in the playback mode.
NO	The power is not turned on. To turn on the camera, press POWER .

MENU COLOR **Setting the menu screen color and background**

NORMAL / COLOR1 / COLOR2 / COLOR3 / MY FAVORITE

- Select [MY FAVORITE] and press  to set a still picture registered in “My Favorite” as the background.

 “SET Registering favorite pictures” (P. 24)

SOUND SETTINGS **Setting the sound output from the camera**

You can set the following with [SOUND SETTINGS].

- Setting the volume of the button operation sound. (BEEP)
- Selecting the volume of the shutter button. (SHUTTER SOUND)
- Adjusting the volume of the camera warning sound. (■)))
- Adjusting the volume during playback. ( VOLUME)

BEEP	OFF (No sound) /	LOW / HIGH
SHUTTER SOUND	OFF (No sound) /	LOW / HIGH
■)))	OFF (No sound) /	LOW / HIGH
 VOLUME	OFF (No sound) /	1 / 2 / 3 / 4 / 5

- You can set all the sounds muted at once by setting [SILENT MODE].

 “SILENT MODE Muting operational sounds” (P. 23)

 **Adjusting the monitor brightness**

BRIGHT/ NORMAL

..... **Setting the date and time**

The date and time is saved with each image and is used in the file name. If the date and time are not set, the  screen is displayed each time the camera is turned on.

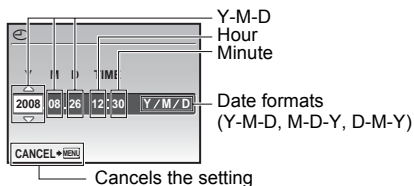

- The first two digits of [Y] are fixed.
- The time is displayed in the 24-hour format.
- To set the time precisely, with the cursor on either "Minute" or "Y/M/D", press  as the time signal strikes 00 seconds.

VIDEO OUT **Playing back pictures on a TV**

NTSC /PAL

The factory default settings differ according to the region where the camera is sold.

To play back camera images on a TV, set the video output according to your TV's video signal type.

- TV video signal types differ by country/region. Check the video signal type before connecting the camera to the TV.

NTSC: North America, Taiwan, Korea, Japan

PAL: European countries, China

Playing back pictures on a TV

Turn off the camera and the TV before connecting.

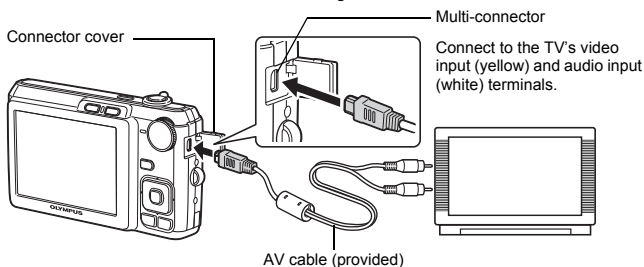

Settings on the camera

Turn the camera on and press  to select the playback mode.

- The last picture taken is displayed on the TV. Use the arrow pad to select the picture you want to display.

Settings on the TV

Turn the TV on and set it to video input mode.

- For details of switching to video input, refer to your TV's instruction manual.
- Images and the information displayed on the screen may be cropped depending on the TV's settings.

POWER SAVE **Setting the camera to the power save mode**

OFF /ON

When no operation has been performed for approximately 10 seconds while in shooting mode, the monitor automatically shuts off. Pressing the zoom lever or other buttons restores the camera from power save mode.

Printing pictures

Direct printing (PictBridge)

By connecting the camera to a PictBridge-compatible printer, you can print out pictures directly.

EASY PRINT..... Prints the picture displayed in the monitor by using the standard settings of your printer.

CUSTOM PRINT..... Prints with the various print settings available on your printer.

- PictBridge is a standard for connecting digital cameras and printers of different makers and printing out pictures directly. To find out if your printer is compatible with PictBridge, refer to the printer's instruction manual.
- For printer's standard settings, available printing modes, the setting items such as paper sizes, and printer's specifications such as available types of paper, how to install the papers and ink cassettes, etc., refer to the printer's instruction manual.

EASY PRINT

- 1** In playback mode, display the picture you want to print out on the monitor.
- 2** Turn the printer on and plug the USB cable provided with the camera into the multi-connector of the camera and the printer's USB port.

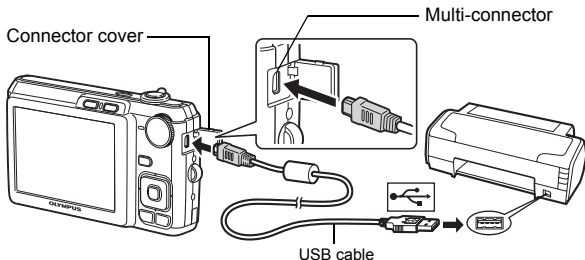

- The [EASY PRINT START] screen is displayed.

3 Press Δ \square \square .

- Printing starts.
- When printing is finished, the picture selection screen is displayed. To print another picture, press \triangleleft \triangleright to select a picture, and press Δ \square \square .

4 Disconnect the USB cable.



Other print modes and print settings (CUSTOM PRINT)

- 1 Follow Steps 1 and 2 on P. 30 to display the screen for Step 3 above, and then press **OK** **FUNC**.
- 2 Select [CUSTOM PRINT], and press **OK** **FUNC**.
- 3 Follow the operation guide to adjust print settings.

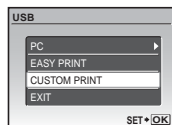

Selecting a print mode

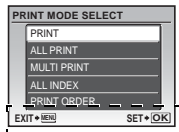

Operation guide

PRINT	Prints the selected picture.
ALL PRINT	Prints all the pictures stored in the internal memory or the card.
MULTI PRINT	Prints one picture in multiple layout format.
ALL INDEX	Prints an index of all the pictures stored in the internal memory or the card.
PRINT ORDER	Prints the pictures according to the print reservation data on the card. ☞ "Print settings (DPOF)" (P. 32)

Setting the print paper

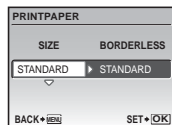

SIZE	Choose from the available paper sizes on your printer.
BORDERLESS	Select with or without borders. In [MULTI PRINT] mode, you cannot print with a border.
PICS/SHEET	Select the number of pictures to be laid out on a sheet of paper. Available in [MULTI PRINT] mode only.

- If the [PRINTPAPER] screen is not displayed, [SIZE], [BORDERLESS] and [PICS/SHEET] are set to the default.

Selecting the picture to print

Press **◀▶** to select the picture you want to print. You can also use the zoom button and select a picture from the index display.



PRINT	Prints one copy of the selected picture. When [SINGLE PRINT] or [MORE] has been selected, a single copy or more copies are printed.
SINGLE PRINT	Makes a print reservation for the displayed picture.
MORE	Sets the number of prints and data to be printed for the displayed picture.

Setting the number of prints and data to be printed

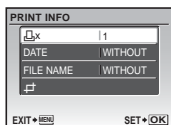

	Sets the number of prints. You can select up to 10 prints.
DATE (🕒)	If you select [WITH], pictures are printed with the date.
FILE NAME (📁)	If you select [WITH], pictures are printed with the file name.
	Use the arrow pad and zoom lever, adjust the location and size of the trimming frame, then press to print the cropped picture.

4 Select [PRINT], and press .

- Printing starts.
- When [OPTION SET] is selected in [ALL PRINT] mode, [PRINT INFO] screen is displayed.
- When printing is finished, the [PRINT MODE SELECT] screen is displayed.

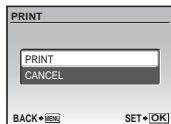

To cancel printing



Screen during data transfer

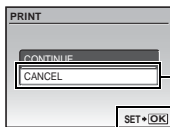

Select [CANCEL], and press .

5 In the [PRINT MODE SELECT] screen, press MENU.

- A message is displayed.

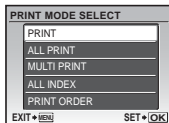

6 Disconnect the USB cable.

Print settings (DPOF)

Print reservation allows you to save printing data (the number of prints and the date and time information) with the pictures stored on the card.

With print reservations, you can print out pictures easily either at home using a personal DPOF-compatible printer or at a photo store that supports DPOF. DPOF is a standard format used to record automatic print information from digital cameras.

- Only the images stored on the card can be reserved to print. Insert a card with recorded pictures into the camera before making print reservations.
- DPOF reservations set by another device cannot be changed by this camera. Make changes using the original device. If a card contains DPOF reservations set by another device, entering reservations using this camera may overwrite the previous reservations.
- You can make DPOF print reservations for up to 999 images per card.
- Not all functions may be available on all printers, or at all photo stores.

Making a print reservation

- 1 Press **MENU** in the playback mode and select **[PRINT ORDER]**.
- 2 Select **[]** or **[ALL]**, and press **[OK/FUNC]**.



Makes a print reservation for the selected picture.



Makes print reservations for all the pictures stored on the card.

- When **[ALL]** is selected, go to step 5.

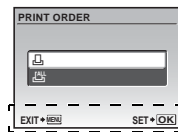

Operation guide

When **[]** is selected

- 3 Press **<>** to select the frames for print reservations, and then press **Δ**/**∇** to set the number of prints.

- You cannot make print reservations for pictures with .
- Repeat Step 3 to make print reservations for other pictures.



Cropping a picture

- Use zoom lever to display the trimming frame.
- Use the arrow pad and zoom lever to adjust the position and the size of area-selection box then press **[OK/FUNC]**.

- 4 When you finish making print reservations, press **[OK/FUNC]**.

- 5 Select the date and time setting, and press **[OK/FUNC]**.

NO The pictures are printed without the date and time.

DATE The selected pictures are printed with the shooting date.

TIME The selected pictures are printed with the shooting time.

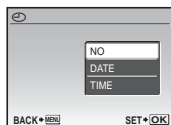

- 6 Select **[SET]**, and press **[OK/FUNC]**.

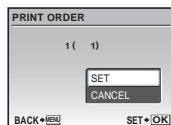

Resetting print reservation data

You can reset all the print reservation data or just for selected pictures.

- 1 Select top menu ▶ **[PRINT ORDER]**, and press **[OK/FUNC]**.







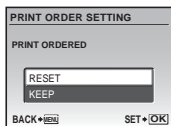

To reset the print reservation data for all the pictures

- 2 Select **[]** or **[ALL]**, and press **[OK/FUNC]**.

- 3 Select **[RESET]**, and press **[OK/FUNC]**.



To reset the print reservation data for a selected picture

- 2** Select [, and press .
- 3** Select [KEEP], and press .
- 4** Press  to select the picture with the print reservations you want to cancel, and press  to decrease the number of prints to 0.
 - Repeat Step 4 to cancel print reservations for other pictures.
- 5** When you are finished canceling print reservations, press .
- 6** Select the date and time setting, and press .
- The setting is applied to the remaining pictures with print reservations.
- 7** Select [SET], and press .

Using OLYMPUS Master

Using the USB cable provided with your camera, you can connect the camera and computer and download (transfer) the images to your computer using the OLYMPUS Master software, also provided with the camera.

Prepare the following items before starting.



OLYMPUS Master 2
CD-ROM



USB cable

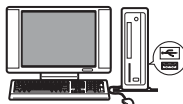

A computer that satisfies the operating
environment (P. 35) requirements

What is OLYMPUS Master?

OLYMPUS Master is a software application for managing your digital images on your computer.

Install the OLYMPUS Master software

Before installing the OLYMPUS Master software, please confirm that your computer is compatible with the following system requirements.

For newer operating systems, please refer to the Olympus web site as shown on the back cover of this manual.

Operating environment

	Windows	Macintosh
OS	Windows 2000 Professional/XP Home Edition/XP Professional/Vista	Mac OS X v10.3 or later
CPU	Pentium III 500 MHz or later	Power PC G3 500 MHz or later Intel Core Solo/Duo 1.5 GHz or later
RAM	256 MB or more	256 MB or more
Hard disk capacity	500 MB or more	500 MB or more
Monitor	1,024 × 768 pixels or more 65,536 colors or more (16.77 million colors or more recommended)	1,024 × 768 pixels or more 32,000 colors or more (16.77 million colors or more recommended)
Other	USB port or IEEE 1394 port Internet Explorer 6 or later QuickTime 7 or later recommended DirectX 9 or later recommended	USB port or IEEE 1394 port (FireWire) Safari 1.0 or later (1.3 or later recommended) QuickTime 6 or later

Note

- Use a computer with a pre-installed operating system. Operations are not guaranteed on home-built computers or computers with an updated operating system.
- Operations are not guaranteed when using an added USB or IEEE 1394 (FireWire) port.
- To install the software, you must log on as a user with administrators' privileges.
- If you are using Macintosh, be sure to remove the media (drag & drop onto the trash icon) before performing the following operations. Failure to do so could result in unstable computer operation and the need to reboot.
 - Disconnect the cable connecting the camera to the computer
 - Turn off the camera
 - Open the camera's battery/card compartment cover

For how to install the OLYMPUS Master software, refer to the installation guide included in the CD-ROM.

Connecting the camera to a computer

1 Make sure the camera is turned off.

- The monitor is off.
- The lens is retracted.



Monitor

2 Connect the multi-connector on the camera to the USB port on the computer using the provided USB cable.

- Refer to your computer's instruction manual to locate the position of the USB port.
- The camera turns on automatically.
- The monitor turns on and the selection screen for the USB connection is displayed.



Multi-connector

3 Select [PC], and press .

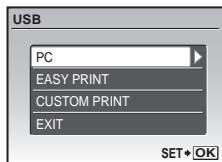

4 The camera is recognized by the computer.

• Windows

When you connect the camera to your computer for the first time, the computer attempts to recognize the camera. Click "OK" to exit the message that is displayed. The camera is recognized as a "Removable Disk".

• Macintosh

The iPhoto program is the default application for managing digital images. When you connect your digital camera for the first time, the iPhoto application starts automatically, so close this application and start OLYMPUS Master.

! Note

- The camera functions are disabled while the camera is connected to a computer.
- Connecting the camera to a computer via a USB hub may cause unstable operation. In this case, do not use a hub, but connect the camera directly to the computer.
- Images cannot be transferred to your computer with OLYMPUS Master if [PC] is selected in Step 3, ▷ is pressed and [MTP] is selected.

Start up the OLYMPUS Master software

Windows

1 Double-click the "OLYMPUS Master 2" icon  on the desktop.

Macintosh

1 Double-click the "OLYMPUS Master 2" icon  in the "OLYMPUS Master 2" folder.

- The browse window is displayed.
- When OLYMPUS Master is started up for the first time after installation, the OLYMPUS Master initial setting screen and user registration screen are displayed before the browse window.
Follow the on-screen instructions.

Displaying camera images on a computer

Downloading and saving images

1 Click "Transfer Images"  on the browse window, and then click "From Camera" .

- The window for selecting the pictures you want to transfer from the camera is displayed. All the images in the camera are displayed.

2 Select "New Album" and enter an album name.

3 Select the image files and click "Transfer Images".

- A window indicating that the download is complete is displayed.

4 Click "Browse images now".

- The downloaded images are displayed in the browse window.



To disconnect the camera

- 1 Make sure that the card access lamp has stopped blinking.

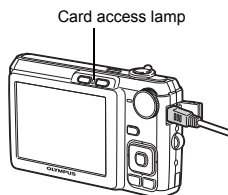

- 2 Make the following preparations for disconnecting the USB cable.

Windows

- ① Click the "Unplug or Eject Hardware" icon  in the system tray.
- ② Click the message that is displayed.
- ③ When a message is displayed saying that the hardware can be ejected safely, click "OK".

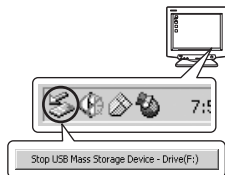

Macintosh

- ① The trash icon changes to the eject icon when the "Untitled" or "NO_NAME" icon on the desktop is dragged. Drag and drop it on the eject icon.



- 3 Disconnect the USB cable from the camera.

Note

- Windows: When you click "Unplug or Eject Hardware", a warning message may be displayed. Make sure that image data is not being downloaded from the camera and that all applications are closed. Click the "Unplug or Eject Hardware" icon again and disconnect the cable.

For detailed operations of OLYMPUS Master, refer to the quick start guide displayed upon startup or the help of the OLYMPUS Master.

To download and save images to a computer without using OLYMPUS Master

This camera is compatible with USB mass storage. You can connect the camera to your computer using the USB cable provided with the camera to download and save images without using OLYMPUS Master. The following environment is required to use the USB cable to connect the camera to your computer.

Windows: Windows 2000 Professional/XP Home Edition/XP Professional/Vista

Macintosh: Mac OS X v10.3 or later

Note

- If your computer is running Windows Vista, you can select [PC] in Step 3 on P. 36, press , and select [MTP] to use Windows Photo Gallery.
- Data transfer is not guaranteed in the following environments, even if your computer is equipped with a USB port.
 - Computers with a USB port added by means of an extension card, etc.
 - Computers without a factory-installed OS and home-built computers

Shooting tips and information

Tips before you start taking pictures

The camera does not turn on even when a battery is loaded

The battery is not charged

- Charge the battery with the charger.

The battery is temporarily unable to function because of the cold

- Battery performance declines in low temperatures, and the charge may not be sufficient to turn on the camera. Remove the battery and warm it by putting it in your pocket for a while.

The card cannot be used

Sometimes when the contact area of the card is dirty, the camera cannot recognize the card, and the [CARD SETUP] screen will be displayed. In this case, select [CLEAN CARD] and after pressing , take out the card, and wipe the contact area with a soft, dry cloth.

No picture is taken when the shutter button is pressed

The camera is in sleep mode

- To save battery power, the camera automatically goes into sleep mode and the monitor turns off if there is no operation for 3 minutes when the camera is turned on. No picture is taken even if the shutter button is fully pressed in this mode. Operate the zoom lever or other buttons to restore the camera from sleep mode before taking a picture. If the camera is left for another 12 minutes, it automatically turns off. Press **POWER** to turn the camera on.

The mode dial is in the position of GUIDE

- No pictures can be taken when the shooting guide is being displayed. Take pictures after selecting the settings by following the shooting guide, or turn the mode dial and set it to a shooting mode other than **GUIDE**.

The flash is charging

- Wait until the  (flash charge) mark stops blinking before taking the picture.

The date and time have not been set

The camera has been used in the same condition from the time of purchase

- No date and time have been set in the camera at the time of purchase. Set the date and time before using the camera.

 "Set the date and time" (P. 7),  "Setting the date and time" (P. 29)

The battery has been removed from the camera

- The date and time settings will be returned to the factory default settings if the camera is left without the battery for approximately 1 day. If the battery is in the camera for a short period of time, the date and time setting will be reset earlier than this. Before taking important pictures, check that the date and time settings are correct.

Shooting tips

Focusing on the subject

There are several ways to focus, depending on the subject.

When the subject is not in the center of the frame

- Place the subject in the center of the frame, lock the focus on the subject, and then recompose your picture.

 "Shutter button Shooting pictures/Recording movies" (P. 11)

The subject is moving quickly

- Focus the camera on a point roughly the same distance away as the subject you want to shoot (by pressing the shutter button halfway); and then recompose your picture and wait for the subject to enter the frame.

Subjects that are difficult to focus on

- Under certain types of conditions, it is difficult to focus using auto focus.

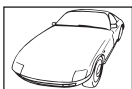

Subject with low contrast



Subject with an extremely bright area in the center of the frame

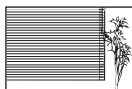

Subject without vertical lines



Subjects at different distances

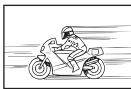

Fast-moving subject





The subject is not in the center of the frame

In these cases, focus (focus lock) on an object with high contrast at the same distance as the intended subject, recompose your shot and then take the picture. If the subject has no vertical lines, hold the camera vertically and focus the camera using the focus lock function by pressing the shutter button halfway, and then return the camera to the horizontal position while keeping the button pressed halfway and take the picture.

Taking pictures without blurring

Hold the camera correctly and press the shutter button gently to shoot the picture. In addition, blurring is reduced when taking pictures in the  mode.

 "  Shooting pictures using digital image stabilization" (P. 13)



The factors that can cause the picture to blur are as follows:

- When you zoom at a high magnification to shoot the picture
- When the shutter speed is set low to shoot a dark subject
- When the flash cannot be used or a low shutter speed set **SCENE** mode is selected.

Taking blur-free pictures without the flash

The flash fires automatically when insufficient light is available and may cause your image to be blurry.

When taking pictures in low lights without the flash, set the flash mode to  (flash off), then increase the ISO sensitivity.

 ">  button Flash shooting" (P. 16)

Increase the [ISO] setting

 "ISO Changing the ISO sensitivity" (P. 22)

Download from Www.Somanuals.com. All Manuals Search And Download.

The picture is too grainy

There are several factors that can cause the picture to appear grainy.

Using the digital zoom to take close-up pictures

- With the digital zoom, part of the image is cropped and enlarged. The greater the magnification, the grainier the picture appears.
-  "Zoom lever Zooming while shooting/Close-up playback" (P. 17)

Increasing the ISO sensitivity

- When you increase the [ISO] setting, "noise", which appears as spots of unwanted color or unevenness in the color, can be introduced and give the picture a grainy appearance. This camera is equipped with a function to allow shooting at high sensitivity while suppressing noise; however, increasing the ISO sensitivity can result in some noise, depending on the shooting conditions.
-  "ISO Changing the ISO sensitivity" (P. 22)



Taking pictures with the SCENE mode set to , , or

- When taking pictures of dark subjects using the above scene modes, the picture may appear grainy.
-  "SCENE Shooting pictures by selecting a scene mode according to the situation" (P. 13)







Taking pictures with the correct color

- The reason why there are sometimes differences between the actual colors and the colors recorded in a picture is related to the light source illuminating the subject. [WB] is the function that helps the camera determine the true colors. Normally, the [AUTO] setting provides the optimal white balance, but depending on the subject, results may be better if you manually adjust the [WB] setting.
 - When the subject is in the shade on a sunny day
 - When the subject is illuminated by both natural light and indoor lighting, such as when near a window
 - When there is no white in the center of the frame
-  "WB Adjusting the color of a picture" (P. 21)

Taking pictures of a white beach or snow scene

- Often, bright subjects (such as snow) turn out darker than their natural colors. Adjusting  toward [+] makes the subject closer to their real shades. Conversely, when you are shooting dark subjects, it can be effective to adjust toward [-]. Sometimes, using the flash may not produce the brightness (exposure) that was intended.
-  " button Changing picture brightness (Exposure compensation)/Printing pictures" (P. 15)

Taking pictures of a subject against backlight

- Set the flash to  (fill-in) to activate fill-in-flash. You can shoot a subject against backlight without the face of the subject appearing dark.  is effective not only for shooting against backlight, but also for shooting under fluorescent and other artificial lighting.
-  "D button Flash shooting" (P. 16)
- Setting  to [+] is effective when shooting against backlight.
-  " button Changing picture brightness (Exposure compensation)/Printing pictures" (P. 15)
- When [FACE DETECT] is set to [ON], faces in pictures appears bright, since adequate exposure for the detected face can be obtained even under backlight conditions.
-  "FACE DETECT Focusing on a face" (P. 23)

Increasing the number of pictures that can be taken

There are two ways to record the pictures you take with this camera.

Recording pictures to the internal memory

- Pictures are recorded to the internal memory, and when the number of storable still pictures reaches 0, you connect the camera to a computer to download the pictures; and then erase the pictures from the internal memory.

Using a card (xD-Picture Card) (optional)

- Pictures are recorded to the card when inserted in the camera. When the card is full, you download the pictures to a computer and then either erase the pictures from the card or use a new card.
- Pictures are not recorded to the internal memory when a card is inserted in the camera. Pictures in the internal memory can be copied to the card using the [BACKUP] function.

☞ "BACKUP Copying pictures in the internal memory to the card" (P. 27)
 "The card" (P. 48)

Number of storable still pictures and recording length of movies

Still pictures

IMAGE SIZE		COMPRES- SION	Number of storable still pictures			
			Internal memory		Using a 1GB card	
			With sound	Without sound	With sound	Without sound
8M	3264 × 2448	FINE	4	4	221	223
		NORM	7	8	429	438
5M	2560 × 1920	FINE	6	6	353	359
		NORM	12	12	673	695
3M	2048 × 1536	FINE	10	10	566	576
		NORM	20	21	1,102	1,142
2M	1600 × 1200	FINE	16	17	913	940
		NORM	32	34	1,728	1,881
1M	1280 × 960	FINE	25	26	1,390	1,453
		NORM	47	53	2,558	2,907
VGA	640 × 480	FINE	84	107	4,568	5,814
		NORM	148	197	7,995	10,660
16:9	1920 × 1080	FINE	15	16	841	876
		NORM	30	32	1,640	1,728

Movies

IMAGE SIZE		Continuous recording length			
		Internal memory		Using a 1 GB card	
		With sound	Without sound	With sound	Without sound
VGA	640 × 480	21 sec.	22 sec.	17 min. 48 sec.	18 min. 11 sec.
QVGA	320 × 240	58 sec.	1 min. 1 sec.	29 min.	29 min.

Using a new card

- If you use a non-Olympus card or a card used for another application, such as a computer, use the [FORMAT] function to format the card.
- ☞ "MEMORY FORMAT (FORMAT) Formatting the internal memory or card" (P. 27)

The card access lamp is blinking

- An image or movie is being recorded or downloaded (when connected to a computer).
- Do not do any of the following while the card access lamp is blinking. Doing so may prevent the image data from being saved and render the internal memory or card unusable.
 - Open the battery/card compartment cover
 - Remove the battery and card

Extending the useful life of the battery

- Performing any of the following operations when not actually taking pictures can deplete the battery power.
 - Repeatedly pressing the shutter button halfway
 - Repeatedly using the zoom
- To save battery power, set [POWER SAVE] to [ON], or turn off the camera whenever it is not in use.
- ☞ "POWER SAVE Setting the camera to the power save mode" (P. 29)

Functions that cannot be selected from menus/Functions that cannot be selected even by pressing the function buttons

- Some items may not be selectable from the menus when using the arrow pad. (The menu items displayed in gray cannot be selected.)
 - Items that cannot be set with the current shooting mode
 - Items that cannot be set because of an item that has already been set: [S/M] and [L], etc.
- Some functions cannot be used when there is no card in the camera. [PANORAMA], [PRINT ORDER], [FORMAT], [BACKUP]
- When the mode dial is set to **GUIDE**, functions cannot be changed.

To return the settings of functions to default settings

- To return the changed shooting settings to default settings while shooting, set [RESET] to [YES].
- ☞ "RESET Changing the shooting functions back to default settings" (P. 21)
- All shooting settings except for **P** mode, [IMAGE QUALITY] and the selected scene mode return to default settings when the camera is turned off.

Playback help and troubleshooting tips

The red-eye cannot be fixed

- Depending on the picture, the red-eye may not be fixed. Also, parts except the eye may be fixed.

Bright specks appear in the picture

- Light reflecting from dust and other particles in the air at night may appear as bright specks in pictures taken using the flash.

Playback tips

Playing back pictures in the internal memory

- When a card has been inserted in the camera, the pictures in the internal memory cannot be played back. Pull out the card before operating the camera.

Viewing picture information

- Play back a picture, and press **DISP./** . Press **DISP./** repeatedly to change the amount of information displayed.
- "DISP./** button Changing the information on display/Display the menu guide" (P. 14)

Quickly displaying a desired picture

- Turn the zoom lever to the W-side to display the pictures as thumbnails (index display).
- "Zoom lever Zooming while shooting/Close-up playback"** (P. 17)

Erasing sound recorded to still pictures

- Once sound is added to a picture, it is not possible to erase the sound. In this case, make a re-recording with silence.
- "** Adding sound to still pictures" (P. 26)

Viewing pictures on a computer

Viewing the entire picture on a computer screen

The size of the picture displayed on a computer screen changes depending on the computer settings. When the monitor setting is 1,024 × 768 and you are using Internet Explorer to view a picture with an image size of 2,048 × 1,536 at 100%; the entire picture cannot be viewed without scrolling. There are several ways you can view the entire picture on the computer screen.

View the picture using image browsing software















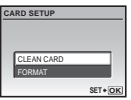

- Install the OLYMPUS Master 2 software from the provided CD-ROM.

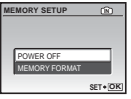
Change the monitor setting

- The icons on the computer desktop may be rearranged. For details of changing the settings on your computer, refer to the computer's instruction manual.

When you get an error message on the camera...

















Monitor indication	Possible cause	Corrective action
 CARD ERROR	There is a problem with the card.	This card cannot be used. Insert a new card.
 WRITE PROTECT	Writing to the card is prohibited.	The recorded image has been protected (read-only) on a computer. Download the image to a computer and cancel the read-only setting.
 MEMORY FULL	The internal memory has no available memory and cannot store any new data.	Insert a card or erase unwanted data. Before erasing, backup the data of important pictures using the card or download such pictures to a computer.

Monitor indication	Possible cause	Corrective action
 CARD FULL	The card has no available memory and cannot store any new data.	Replace the card or erase unwanted data. Before erasing, download important pictures to a computer.
 NO PICTURE	There are no pictures in the internal memory or on the card.	The internal memory or the card contains no pictures. Record pictures.
 PICTURE ERROR	There is a problem with the selected picture and it cannot be played back on this camera.	Use image processing software to view the picture on a computer. If that cannot be done, the image file is damaged.
 THE IMAGE CANNOT BE EDITED	Pictures taken by other cameras, or previously edited or corrected pictures cannot be edited or fixed.	Use image processing software to edit the pictures.
 CARD-COVER OPEN	The battery/card compartment cover is open.	Close the battery/card compartment cover.
 BATTERY EMPTY	The battery is empty.	Charge the battery.
 CARD SETUP	The card is not being recognized by the camera. Or, the card is not formatted.	<ul style="list-style-type: none"> Select [CLEAN CARD], and press . Remove the card and wipe the contact area with a soft, dry cloth. Select [FORMAT] ► [YES] and press . All data on the card is erased.
 MEMORY SETUP	There is an error in the internal memory.	Select [MEMORY FORMAT] ► [YES] and press  . All data in the internal memory is erased.
 NO CONNECTION	The camera is not connected to the computer or the printer correctly.	Disconnect the camera and connect it again correctly.
 NO PAPER	There is no paper in the printer.	Load some paper into the printer.
 NO INK	The printer has run out of ink.	Replace the ink cartridge in the printer.
 JAMMED	The paper is jammed.	Remove the jammed paper.
SETTINGS CHANGED	The printer's paper tray has been removed or the printer has been operated while changing settings on the camera.	Do not operate the printer while changing settings on the camera.
 PRINT ERROR	There is a problem with the printer and/or camera.	Turn off the camera and printer. Check the printer and remedy any problems before turning the power on again.
 CANNOT PRINT	Pictures recorded on other cameras may not be printed on this camera.	Use a computer to print.



Functions available in shooting modes and scenes

Some functions cannot be set in certain shooting modes. For more details, refer to the table below.

Functions available in shooting modes

Shooting mode \ Function	SCENE											Ref. Page	
	AUTO	P											
	✓	✓	✓	✓	✓	✓	✓	✓	✓	✓	✓	✓	P. 15
	✓	✓	✓	–	✓	–	✓	✓	–	–	–	– ^{*1}	P. 15
	✓	✓	✓	–	✓	–	✓	✓	–	–	–	–	P. 15
	✓	✓	✓	✓	✓	✓	✓	✓	✓	✓	✓	✓	P. 16
	✓	✓	✓	✓	– ^{*2}	✓	✓	– ^{*2}	✓	– ^{*2}	– ^{*2}	– ^{*2}	P. 16
Zoom	✓	✓	✓	✓	✓	✓	✓	✓	–	✓	✓	✓	P. 17
IMAGE QUALITY	✓	✓	✓	✓	✓	✓	✓	✓	✓	✓	✓	– ^{*3}	P. 20
WB	–	✓	✓	✓	✓	✓	✓	✓	✓	✓	✓	✓	P. 21
ISO	–	✓	–	–	–	–	–	–	–	–	–	–	P. 22
 (still picture)	–	✓	✓	✓	–	✓	✓	✓	✓	✓	✓	–	P. 22
 (movie)	–	–	–	–	✓	–	–	–	–	–	–	–	P. 22
PANORAMA	–	✓	✓	✓	–	✓	✓	✓	✓	✓	✓	–	P. 22
FACE DETECT	–	✓	✓	✓	–	✓	✓	✓	✓	✓	✓	–	P. 23

*1 Shooting mode is fixed at .

*2  is fixed at .

*3 [IMAGE QUALITY] is fixed at [VGA].

Camera care

Cleaning the camera

Exterior:

- Wipe gently with a soft cloth. If the camera is very dirty, soak the cloth in mild soapy water and wring well. Wipe the camera with the damp cloth and then dry it with a dry cloth. If you have used the camera at the beach, use a cloth soaked in clean water and wrung well.

Monitor:

- Wipe gently with a soft cloth.

Lens:

- Blow dust off the lens with a commercial blower, then wipe gently with a lens cleaner.

Battery/Charger:

- Wipe gently with a soft, dry cloth.



Note

- Do not use strong solvents such as benzene or alcohol, or chemically treated cloth.
- Mold may form on the lens surface if the lens is left dirty.

Storage

- When storing the camera for extended periods, remove the battery and card, and keep in a cool, dry place that is well ventilated.
- Periodically, insert the battery and test the camera functions.



Note

- Avoid leaving the camera in places where chemical products are handled since this may result in corrosion.

Battery and charger

- This camera uses one Olympus lithium ion battery (LI-42B/LI-40B). No other type of batteries can be used.
- Power consumption by the camera varies depending on which functions are used.
- During the conditions described below, power is consumed continuously and the battery becomes exhausted quickly.
 - The zoom is used repeatedly.
 - The shutter button is pressed halfway repeatedly in shooting mode, activating the auto focus.
 - A picture is displayed on the monitor for an extended period of time.
 - The camera is connected to a computer or printer.
- Using an exhausted battery may cause the camera to turn off without displaying the battery level warning.
- The rechargeable battery is not fully charged at the time of purchase. Charge the battery fully with the LI-40C charger before use.
- The provided rechargeable battery usually takes approximately 5 hours to charge.
- This camera uses a charger specified by Olympus. Do not use any other type of charger.

Using your charger abroad

- The charger can be used in most home electrical sources within the range of 100 V to 240 V AC (50/60Hz) around the world. However, depending on the country or area you are in, the AC wall outlet may be shaped differently and the charger may require a plug adapter to match the wall outlet. For details, ask at your local electrical shop or travel agent.
- Do not use travel voltage converters as they could damage your charger.

Useful use of the accessories

The card

Pictures can be recorded on the optional card.

The internal memory and card are the camera's media for recording pictures, similar to film in a film camera. Pictures recorded to the internal memory or card can be easily erased on the camera or processed using a computer.

Unlike portable storage media, the internal memory cannot be removed or exchanged.

The number of recordable pictures can be increased by using a card with a larger capacity.

- ① **Index area**
You can use this space to write the contents of the card.
- ② **Contact area**
The part where the data transferred from the camera enters the card.
Do not touch this area directly.

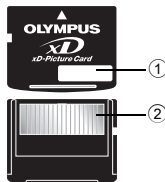

Compatible cards

xD-Picture Card (16MB – 2GB) (Type H/M, Standard)

Using the internal memory or card

You can confirm on the monitor whether the internal memory or card is being used during shooting and playback operations.

Shooting mode



Memory indicator

- : When using the internal memory
No icon: When using a card

Playback mode



! Note

- Do not open the battery/card compartment cover while the card access lamp is blinking, as the lamp is indicating that it is reading or writing data. Doing so may damage the data in the internal memory or the card and render the internal memory or card unusable.

SAFETY PRECAUTIONS



CAUTION

RISK OF ELECTRIC SHOCK
DO NOT OPEN



CAUTION: TO REDUCE THE RISK OF ELECTRICAL SHOCK, DO NOT REMOVE COVER (OR BACK). NO USER-SERVICEABLE PARTS INSIDE. REFER SERVICING TO QUALIFIED OLYMPUS SERVICE PERSONNEL.



An exclamation mark enclosed in a triangle alerts you to important operating and maintenance instructions in the documentation provided with the product.



DANGER

If the product is used without observing the information given under this symbol, serious injury or death may result.



WARNING

If the product is used without observing the information given under this symbol, injury or death may result.



CAUTION

If the product is used without observing the information given under this symbol, minor personal injury, damage to the equipment, or loss of valuable data may result.

WARNING!

TO AVOID THE RISK OF FIRE OR ELECTRICAL SHOCK, NEVER DISASSEMBLE, EXPOSE THIS PRODUCT TO WATER OR OPERATE IN A HIGH HUMIDITY ENVIRONMENT.

General Precautions

Read All Instructions — Before you use the product, read all operating instructions. Save all manuals and documentation for future reference.

Cleaning — Always unplug this product from the wall outlet before cleaning. Use only a damp cloth for cleaning. Never use any type of liquid or aerosol cleaner, or any type of organic solvent to clean this product.

Attachments — For your safety, and to avoid damaging the product, use only accessories recommended by Olympus.

Water and Moisture — For precautions on products with weatherproof designs, read the weatherproofing sections.

Location — To avoid damage to the product, mount the product securely on a stable tripod, stand, or bracket.

Power Source — Connect this product only to the power source described on the product label.

Foreign Objects — To avoid personal injury, never insert a metal object into the product.

Heat — Never use or store this product near any heat source such as a radiator, heat register, stove, or any type of equipment or appliance that generates heat, including stereo amplifiers.

Handling the Camera



WARNING

- **Do not use the camera near flammable or explosive gases.**
- **Do not use the flash and LED on people (infants, small children, etc.) at close range.**
 - You must be at least 1 m (3 ft.) away from the faces of your subjects. Firing the flash too close to the subject's eyes could cause a momentary loss of vision.
- **Keep young children and infants away from the camera.**
 - Always use and store the camera out of the reach of young children and infants to prevent the following dangerous situations which could cause serious injury:
 - Becoming entangled in the camera strap, causing strangulation.
 - Accidentally swallowing the battery, cards or other small parts.
 - Accidentally firing the flash into their own eyes or those of another child.
 - Accidentally being injured by the moving parts of the camera.
- **Do not look at the sun or strong lights with the camera.**
- **Do not use or store the camera in dusty or humid places.**
- **Do not cover the flash with a hand while firing.**



CAUTION

- **Stop using the camera immediately if you notice any unusual odors, noise, or smoke around it.**
 - Never remove the batteries with bare hands, which may cause a fire or burn your hands.
- **Never hold or operate the camera with wet hands.**
- **Do not leave the camera in places where it may be subject to extremely high temperatures.**
 - Doing so may cause parts to deteriorate and, in some circumstances, cause the camera to catch fire. Do not use the charger if it is covered (such as a blanket). This could cause overheating, resulting in fire.
- **Handle the camera with care to avoid getting a low-temperature burn.**
 - When the camera contains metal parts, overheating can result in a low-temperature burn. Pay attention to the following:
 - When used for a long period, the camera will get hot. If you hold on to the camera in this state, a low-temperature burn may be caused.
 - In places subject to extremely cold temperatures, the temperature of the camera's body may be lower than the environmental temperature. If possible, wear gloves when handling the camera in cold temperatures.
- **Be careful with the strap.**
 - Be careful with the strap when you carry the camera. It could easily catch on stray objects - and cause serious damage.

Battery Handling Precautions

Follow these important guidelines to prevent batteries from leaking, overheating, burning, exploding, or causing electrical shocks or burns.



DANGER

- The camera uses a lithium ion battery specified by Olympus. Charge the battery with the specified charger. Do not use any other chargers.
- Never heat or incinerate batteries.
- Take precautions when carrying or storing batteries to prevent them from coming into contact with any metal objects such as jewelry, pins, fasteners, etc.

- Never store batteries where they will be exposed to direct sunlight, or subjected to high temperatures in a hot vehicle, near a heat source, etc.
- To prevent causing battery leaks or damaging their terminals, carefully follow all instructions regarding the use of batteries. Never attempt to disassemble a battery or modify it in any way, by soldering, etc.
- If battery fluid gets into your eyes, flush your eyes immediately with clear, cold running water and seek medical attention immediately.
- Always store batteries out of the reach of small children. If a child accidentally swallows a battery, seek medical attention immediately.



WARNING

- Keep batteries dry at all times.
- To prevent batteries from leaking, overheating, or causing a fire or explosion, use only batteries recommended for use with this product.
- Insert the battery carefully as described in the operating instructions.
- If rechargeable batteries have not been recharged within the specified time, stop charging them and do not use them.
- Do not use a battery if it is cracked or broken.
- If a battery leaks, becomes discolored or deformed, or becomes abnormal in any other way during operation, stop using the camera.
- If a battery leaks fluid onto your clothing or skin, remove the clothing and flush the affected area with clean, running cold water immediately. If the fluid burns your skin, seek medical attention immediately.
- Never subject batteries to strong shocks or continuous vibration.



CAUTION

- Before loading, always inspect the battery carefully for leaks, discoloration, warping, or any other abnormality.
- The battery may become hot during prolonged use. To avoid minor burns, do not remove it immediately after using the camera.
- Always unload the battery from the camera before storing the camera for a long period.

Caution for Usage Environment

- To protect the high-precision technology contained in this product, never leave the camera in the places listed below, no matter if in use or storage:
 - Places where temperatures and/or humidity are high or go through extreme changes. Direct sunlight, beaches, locked cars, or near other heat sources (stove, radiator, etc.) or humidifiers.
 - In sandy or dusty environments.
 - Near flammable items or explosives.
 - In wet places, such as bathrooms or in the rain. When using products with weatherproof designs, read their manuals as well.
 - In places prone to strong vibrations.
- Never drop the camera or subject it to severe shocks or vibrations.
- When mounted on a tripod, adjust the position of the camera with the tripod head. Do not twist the camera.
- Do not touch electric contacts on cameras.
- Do not leave the camera pointed directly at the sun. This may cause lens or shutter curtain damage, color failure, ghosting on the CCD, or may possibly cause fires.
- Do not push or pull severely on the lens.
- Before storing the camera for a long period, remove the battery. Select a cool, dry location for storage to prevent condensation or mold from forming inside the camera. After storage, test the camera by turning it on and pressing the shutter release button to make sure that it is operating normally.
- Always observe the operating environment restrictions described in the camera's manual.

Battery Handling Precautions

- This camera uses a lithium ion battery specified by Olympus. Do not use any other type of battery. For safe and proper use, read the battery's instruction manual carefully before using it.
- If the battery's terminals get wet or greasy, camera contact failure may result. Wipe the battery well with a dry cloth before use.
- Always charge a battery when using it for the first time, or if it has not been used for a long period.
- When operating the camera with battery power at low temperatures, try to keep the camera and spare battery as warm as possible. A battery that has run down at low temperatures may be restored after it is warmed at room temperature.
- The number of pictures you can take may vary depending on the shooting conditions or battery.
- Before going on a long trip, and especially before traveling abroad, purchase extra batteries. A recommended battery may be difficult to obtain while traveling.
- Please recycle batteries to help save our planet's resources. When you throw away dead batteries, be sure to cover their terminals and always observe local laws and regulations.

LCD Monitor

- Do not push the monitor forcibly; otherwise the image may become vague, resulting in a playback mode failure or damage to the LCD monitor.
- A strip of light may appear on the top/bottom of the monitor, but this is not a malfunction.
- When a subject is viewed diagonally in the camera, the edges may appear zigzagged on the monitor. This is not a malfunction; it will be less noticeable in playback mode.
- In places subject to low temperatures, the LCD monitor may take a long time to turn on or its color may change temporarily. When using the camera in extremely cold places, it is a good idea to occasionally place it in a warm place. An LCD monitor exhibiting poor performance due to low temperatures will recover in normal temperatures.
- The LCD used for the monitor is made with high-precision technology. However, black spots or bright spots of light may appear constantly on the LCD monitor. Due to its characteristics or the angle at which you are viewing the monitor, the spot may not be uniform in color and brightness. This is not a malfunction.

Legal and Other Notices

- Olympus makes no representations or warranties regarding any damages, or benefit expected by using this unit lawfully, or any request from a third person, which are caused by the inappropriate use of this product.
- Olympus makes no representations or warranties regarding any damages or any benefit expected by using this unit lawfully which are caused by erasing picture data.

Disclaimer of Warranty

- Olympus makes no representations or warranties, either expressed or implied, by or concerning any content of these written materials or software, and in no event shall be liable for any implied warranty of merchantability or fitness for any particular purpose or for any consequential, incidental or indirect damages (including but not limited to damages for loss of business profits, business interruption and loss of business information) arising from the use or inability to use these written materials or software or equipment. Some countries do not allow the exclusion or limitation of liability for consequential or incidental damages, so the above limitations may not apply to you.
- Olympus reserves all rights to this manual.

Warning

Unauthorized photographing or use of copyrighted material may violate applicable copyright laws. Olympus assumes no responsibility for unauthorized photographing, use or other acts that infringe upon the rights of copyright owners.

Copyright Notice

All rights reserved. No part of these written materials or this software may be reproduced or used in any form or by any means, electronic or mechanical, including photocopying and recording or the use of any type of information storage and retrieval system, without the prior written permission of Olympus. No liability is assumed with respect to the use of the information contained in these written materials or software, or for damages resulting from the use of the information contained therein. Olympus reserves the right to alter the features and contents of this publication or software without obligation or advance notice.

For customers in Europe



"CE" mark indicates that this product complies with the European requirements for safety, health, environment and customer protection. "CE" mark cameras are intended for sales in Europe.



This symbol [crossed-out wheeled bin WEEE Annex IV] indicates separate collection of waste electrical and electronic equipment in the EU countries. Please do not throw the equipment into the domestic refuse. Please use the return and collection systems available in your country for the disposal of this product.

Use Only Dedicated Rechargeable Battery and Battery Charger

We strongly recommend that you use only the genuine Olympus dedicated rechargeable battery and battery charger with this camera.

Using a non-genuine rechargeable battery and/or battery charger may result in fire or personal injury due to leakage, heating, ignition or damage to the battery. Olympus does not assume any liability for accidents or damage that may result from the use of a battery and/or battery charger that are not genuine Olympus accessories.

Provisions of warranty

1. If this product proves to be defective, although it has been used properly (in accordance with the written Handling Care and Operating instructions supplied with it), during a period of two years from the date of purchase from an authorized Olympus distributor within the business area of Olympus Imaging Europa GmbH as stipulated on the web site: <http://www.olympus.com> this product will be repaired, or at Olympus's option replaced, free of charge. To claim under this warranty the customer must take the product and this Warranty Certificate before the end of the two year warranty period to the dealer where the product was purchased or any other Olympus service station within the business area of Olympus Imaging Europa GmbH as stipulated on the web site: <http://www.olympus.com>. During the one year period of the World Wide Warranty the customer may turn the product in at any Olympus service station. Please notice that not in all countries such Olympus service station exists.
2. The customer shall transport the product to the dealer or Olympus authorized service station at his own risk and shall be responsible for any costs incurred in transporting the product.
3. This warranty does not cover the following and the customer will be required to pay repair charge, even for defects occurring within the warranty period referred to above.
 - (a) Any defect that occurs due to mishandling (such as an operation performed that is not mentioned in the Handling Care or other sections of the instructions, etc.)
 - (b) Any defect that occurs due to repair, modification, cleaning, etc. performed by anyone other than Olympus or an Olympus authorized service station.
 - (c) Any defect or damage that occurs due to transport, a fall, shock, etc. after purchase of the product.
 - (d) Any defect or damage that occurs due to fire, earthquake, flood damage, thunderbolt, other natural disasters, environmental pollution and irregular voltage sources.
 - (e) Any defect that occurs due to careless or improper storage (such as keeping the product under conditions of high temperature and humidity, near insect repellents such as naphthalene or harmful drugs, etc.), improper maintenance, etc.
 - (f) Any defect that occurs due to exhausted batteries, etc.
 - (g) Any defect that occurs due to sand, mud, etc. entering the inside of the product casing.
 - (h) When this Warranty Certificate is not returned with the product.
 - (i) When any alterations whatsoever are made to the Warranty Certificate regarding the year, month and date of purchase, the customer's name, the dealer's name, and the serial number.
 - (j) When proof of purchase is not presented with this Warranty Certificate.
4. This Warranty applies to the product only; the Warranty does not apply to any other accessory equipment, such as the case, strap, lens cap and batteries.

5. Olympus's sole liability under this warranty shall be limited to repairing or replacing the product. Any liability for indirect or consequential loss or damage of any kind incurred or suffered by the customer due to a defect of the product, and in particular any loss or damage caused to any lenses, films, other equipment or accessories used with the product or for any loss resulting from a delay in repair or loss of data, is excluded. Compelling regulations by law remain unaffected by this.

Notes regarding warranty maintenance

1. This warranty will only be valid if the Warranty Certificate is duly completed by Olympus or an authorized dealer or other documents contain sufficient proof. Therefore, please make sure that your name, the name of the dealer, the serial number and the year, month and date of purchase are all completed or the original invoice or the sales receipt (indicating the dealer's name, the date of purchase and product type) is attached to this Warranty Certificate. Olympus reserves the right to refuse free-of-charge service if neither Warranty Certificate is completed nor the above document is attached or if the information contained in it is incomplete or illegible.
 2. Since this Warranty Certificate will not be re-issued, keep it in a safe place.
- * Please refer to the list on the web site: <http://www.olympus.com> for the authorized international Olympus service network.

Trademarks

- IBM is a registered trademark of International Business Machines Corporation.
- Microsoft and Windows are registered trademarks of Microsoft Corporation.
- Macintosh is a trademark of Apple Inc.
- xD-Picture Card™ is a trademark.
- All other company and product names are registered trademarks and/or trademarks of their respective owners.
- The standards for camera file systems referred to in this manual are the "Design Rule for Camera File System/DCF" standards stipulated by the Japan Electronics and Information Technology Industries Association (JEITA).

SPECIFICATIONS

● Camera

Product type	: Digital camera (for shooting and displaying)
Recording system	
Still pictures	: Digital recording, JPEG (in accordance with Design rule for Camera File system (DCF))
Applicable standards	: Exif 2.2, Digital Print Order Format (DPOF), PRINT Image Matching III, PictBridge
Sound with still pictures	: Wave format
Movies	: AVI Motion JPEG
Memory	: Internal memory xD-Picture Card (16 MB – 2 GB) (Type H/M, Standard)
Number of effective pixels	: 8,000,000 pixels
Image pickup device	: 1/2.35" CCD (primary color filter), 8,500,000 pixels (gross)
Lens	: Olympus lens 6.3 to 31.5 mm, f3.5 to 5.6 (equivalent to 36 to 180 mm on a 35 mm camera)
Photometric system	: Center-weighted metering
Shutter speed	: 4 to 1/2000 sec.
Shooting range	: 0.6 m (2.0 ft.) to ∞ (W), 1 m (3.3 ft.) to ∞ (T) (normal) 0.1 m (0.3 ft.) to ∞ (W), 0.6 m (2.0 ft.) to ∞ (T) (macro mode) 0.03 m (0.1 ft.) to ∞ (super macro mode)
Monitor	: 2.7" TFT color LCD display, 154,000 dots
Outer connector	: USB connector, A/V OUT jack (multi-connector)
Automatic calendar system	: 2000 up to 2099
Operating environment	
Temperature	: 0°C to 40°C (32°F to 104°F) (operation)/ -20°C to 60°C (-4°F to 140°F) (storage)
Humidity	: 30% to 90% (operation)/10% to 90% (storage)
Power supply	: One Olympus lithium ion battery (LI-42B/LI-40B)
Dimensions	: 97.7 mm (W) × 57.7 mm (H) × 23.3 mm (D) (3.8 × 2.3 × 0.9 in.) (excluding protrusions)
Weight	: 123 g (4.3 oz) without battery and card

● **Lithium ion battery (LI-42B)**

Product type	: Lithium ion rechargeable battery
Standard voltage	: DC 3.7 V
Standard capacity	: 740 mAh
Battery life	: Approx. 300 full charges (varies on usage)
Operating environment	
Temperature	: 0°C to 40°C (32°F to 104°F) (charging)/ -10°C to 60°C (14°F to 140°F) (operation)/ -20°C to 35°C (-4°F to 95°F) (storage)
Dimensions	: 31.5 × 39.5 × 6 mm (1.2 × 1.5 × 0.2 in.)
Weight	: Approx. 15 g (0.5 oz)

● **Battery charger (LI-40C)**

Power requirements	: AC 100 to 240 V (50 to 60 Hz) 3.2 VA (100 V) to 5.0 VA (240 V)
Output	: DC 4.2 V, 200 mA
Charging time	: Approx. 5 hours
Operating environment	
Temperature	: 0°C to 40°C (32°F to 104°F) (operation)/ -20°C to 60°C (-4°F to 140°F) (storage)
Dimensions	: 62 × 23 × 90 mm (2.4 × 0.9 × 3.5 in.)
Weight	: Approx. 65 g (2.3 oz)

Design and specifications subject to change without notice.

Names of Parts

Camera

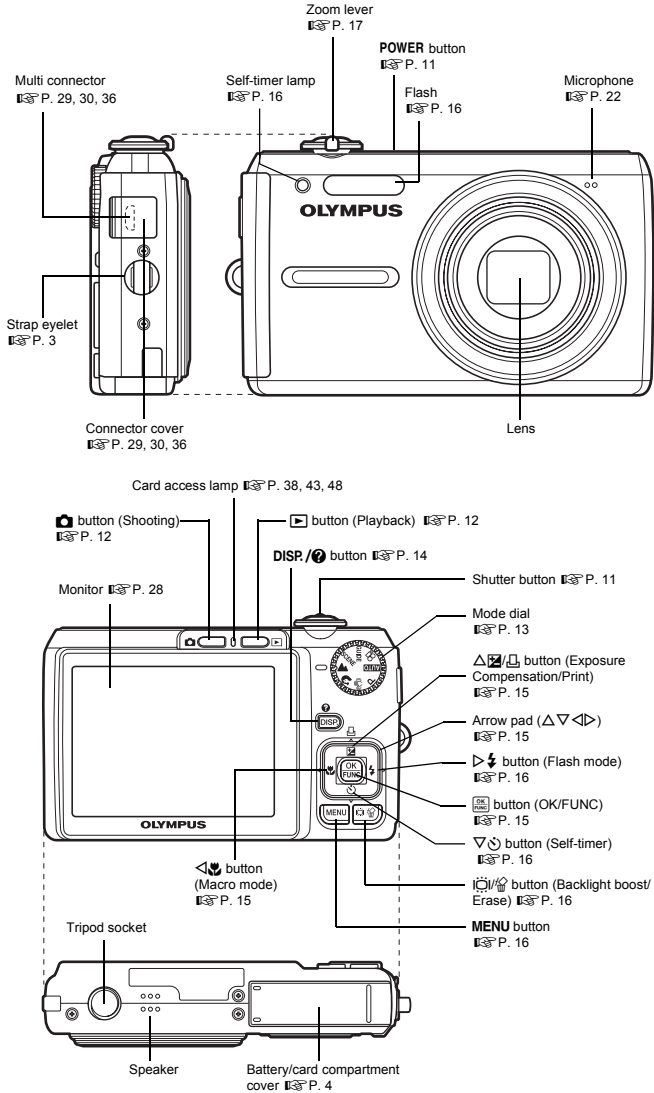

Monitor Symbols & Icons

● Shooting Mode

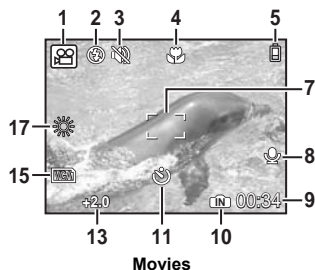
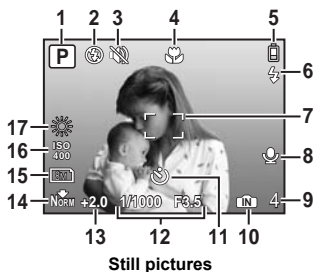

Item	Indications	Ref. Page
1 Shooting mode	AUTO, P, M, A, S, L, etc.	P. 13
2 Flash mode	Eye, lightning bolt, battery	P. 16
3 Silent mode	Silence icon	P. 23
4 Macro mode Super macro mode	Flower, S	P. 15
5 Battery check	Full battery icon, low battery icon = charge the battery	P. 45
6 Flash standby Camera movement warning/flash charge	Lightning bolt (Lit) Lightning bolt (Blinks)	P. 39
7 AF target mark	[]	P. 9
8 Sound record	Microphone icon	P. 22
9 Number of storable still pictures Remaining recording time	4 00:34	P. 11 P. 14
10 Current memory	IN (Recording pictures to the internal memory), No icon (Recording pictures to the card)	P. 48
11 Self-timer	Timer icon	P. 16
12 Shutter speed/Aperture value	1/1000 F3.5, etc.	P. 9
13 Exposure compensation	-2.0 - +2.0	P. 15
14 Compression	NORM (NORMAL), FINE (FINE)	P. 20
15 Image size	8M, 5M, 16:9, VGA, etc.	P. 20
16 ISO	ISO100, ISO400, etc.	P. 22
17 White balance	Sun, cloud, moon, etc.	P. 21

● Playback Mode

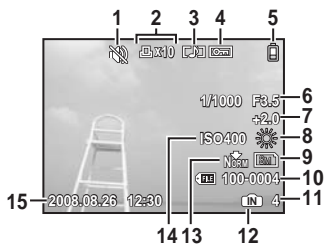



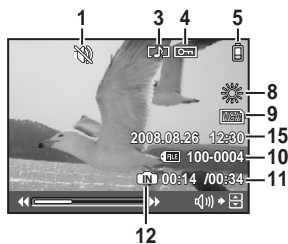





















Still pictures























Movies

	Item	Indications	Ref. Page
1	Silent mode		P. 23
2	Print reservation/Number of prints	× 10	P. 32
3	Sound record		P. 22
4	Protect		P. 25
5	Battery check	= full power, = charge the battery	P. 45
6	Shutter speed/Aperture value	1/1000 F3.5, etc.	P. 9
7	Exposure compensation	-2.0 – +2.0	P. 15
8	White balance	WB AUTO, , , , –	P. 21
9	Image size	, , , , etc.	P. 20
10	File number	100-0004	–
11	Number of frames Playing time/Total recording time	4 00:14/00:34	– P. 12
12	Current memory	(Playing back the picture in the internal memory), No icon (Playing back the picture in the card)	P. 48
13	Compression	(NORMAL), (FINE)	P. 20
14	ISO	ISO100, ISO400, etc.	P. 22
15	Date and time	2008.08.26 12:30	P. 29

Index

Names of Parts	58	Fluorescent lamp 	21
A		Focus	9, 11, 40
ALL ERASE	26	Focus lock	11
ALL INDEX	31	FORMAT	27
ALL PRINT	31	Function menu	15
All-frame reservation 	33	G	
Aperture value	9, 11	GUIDE (Shooting guide)	6, 13
AUCTION 	13	I	
AUTO (AUTO)	6	IMAGE QUALITY	20
AUTO (ISO)	22	IMAGE SIZE	20
AUTO (WB)	21	Index display 	17
Auto flash AUTO	16	INDOOR 	13
Auto focus	40	Information displays	14
AV cable	3, 29	Internal memory	27, 42, 44, 48
B		ISO	22
BACKUP	27	L	
Battery	4, 47	LIGHTING FIX	23
Battery charger	4, 47	Lithium ion battery	3, 4
Battery check	59	M	
BEEP	28	Macro mode 	15
BEHIND GLASS 	13	MEMORY FORMAT	27
C		Menu	18
CAMERA MENU	21	MENU COLOR	28
CANDLE 	13	Menu guide	14
Card	32, 42, 48	Monitor	11, 28, 59
Close-up playback 	17	Monitor brightness adjustment 	28
Cloudy day 	21	MULTI PRINT	31
COMPRESSION	20	MY FAVORITE	24
Continuous recording length	42	N	
Cropping pictures 	25, 32, 33	NIGHT+PORTRAIT 	13
CUISINE 	13	NTSC	29
CUSTOM PRINT	31	Number of storable still pictures	42
D		O	
Date and time 	7, 29, 39	OLYMPUS Master	35
Digital zoom	14, 17	Operation guide	18
Direct printing	30	Optical zoom	14, 17
DOCUMENTS 	13	P	
DPOF	32	PAL	29
E		PANORAMA	22
EASY PRINT	30	PC	36
EDIT	24	PERFECT FIX	23
ERASE	10, 26	PictBridge	30
Error messages	44	Picture rotation 	25
Exposure compensation 	41	PIXEL MAPPING	28
F		Playback mode 	10, 12, 14, 17, 60
FACE DETECT	23	Playback mode menu 	23
FILE NAME	32	Playback on a TV	29
File name	29	Playing time/Total recording time	12
Fill-in flash 	16	POWER SAVE	29
FIREWORKS 	13	Press completely	9, 11
Flash	16	Press halfway	9, 11
Flash charge	39	PRINT ORDER 	25, 31
Flash mode 	16		
Flash off 	16		

Print settings 	32
Printing pictures	30
P (Program auto)	6
Protect 	25
R	
Recording movies with or without sound 	22
Recording 	26
Recording sound with still pictures 	22
REDEYE FIX	23
Red-eye reduction flash 	16
RESET	21, 43
Resizing 	24
S	
SCENE (Scene)	6, 13, 21
SEL. IMAGE	26
Selecting a language 	27
SELF PORTRAIT 	13
Self-timer 	16
SETUP menu	27
Shooting mode	11, 12, 14, 17, 46, 59
Shooting movies 	11, 14
Shooting still pictures	11
SHUTTER SOUND	28
Shutter speed	9, 11
SILENT MODE 	23
Single-frame playback	17
Single-frame reservation 	33
Sleep mode	39
SLIDESHOW	23, 24
SOUND SETTINGS	28
SPORT 	13
Strap	3
Sunny day 	21
SUNSET 	13
Super macro mode 	15
T	
Top menu	18
Tungsten light 	21
U	
USB cable	3, 30, 35, 36, 38
V	
VIDEO OUT	29
 VOLUME	28
VOLUME	12
W	
Warning sound 	28
White balance WB	21
X	
xD-Picture Card	22, 42, 48
Z	
Zoom	17

OLYMPUS®

<http://www.olympus.com/>

OLYMPUS IMAGING CORP.

Shinjuku Monolith, 3-1 Nishi-Shinjuku 2-chome, Shinjuku-ku, Tokyo, Japan

OLYMPUS IMAGING AMERICA INC.

3500 Corporate Parkway, P.O. Box 610, Center Valley, PA 18034-0610, U.S.A. Tel. 484-896-5000

Technical Support (USA)

24/7 online automated help: <http://www.olympusamerica.com/support>

Phone customer support: Tel. 1-888-553-4448 (Toll-free)

Our phone customer support is available from 8 am to 10 pm

(Monday to Friday) ET

<http://olympusamerica.com/contactus>

Olympus software updates can be obtained at: <http://www.olympusamerica.com/digital>

OLYMPUS IMAGING EUROPA GMBH

Premises: Wendenstrasse 14-18, 20097 Hamburg, Germany

Tel: +49 40-23 77 3-0 / Fax: +49 40-23 07 61

Goods delivery: Bredowstrasse 20, 22113 Hamburg, Germany

Letters: Postfach 10 49 08, 20034 Hamburg, Germany

European Technical Customer Support:

Please visit our homepage <http://www.olympus-europa.com>

or call our TOLL FREE NUMBER* : **00800 - 67 10 83 00**

for Austria, Belgium, Denmark, Finland, France, Germany, Italy, Luxemburg, Netherlands, Norway, Portugal, Spain, Sweden, Switzerland, United Kingdom

* Please note some (mobile) phone services providers do not permit access or request an additional prefix to +800 numbers.

For all European Countries not listed and in case that you can't get connected

to the above mentioned number, please make use of the following

CHARGED NUMBERS: **+49 180 5 - 67 10 83** or **+49 40 - 237 73 4899**

Our Technical Customer Support is available from 9 am to 6 pm MET (Monday to Friday)

Free Manuals Download Website

<http://myh66.com>

<http://usermanuals.us>

<http://www.somanuals.com>

<http://www.4manuals.cc>

<http://www.manual-lib.com>

<http://www.404manual.com>

<http://www.luxmanual.com>

<http://aubethermostatmanual.com>

Golf course search by state

<http://golfingnear.com>

Email search by domain

<http://emailbydomain.com>

Auto manuals search

<http://auto.somanuals.com>

TV manuals search

<http://tv.somanuals.com>