

Bluetooth headset for phone calls VMX 200-II



Instruction manual

 **SENNHEISER**

Contents

- Important safety information** 2
- The VMX 200-II Bluetooth headset** 4
- Delivery includes** 5
- Product overview** 6
 - VMX 200-II headset 6
 - Charging accessories 6
 - Overview of pictograms 7
 - Overview of the LED indications 8
 - Overview of buttons 9
- Putting the VMX 200-II into operation** 10
 - Charging the headset battery 10
 - Connecting the headset to a **Bluetooth** device 11
- Using the VMX 200-II** 13
 - Individually adjusting the VMX 200-II and wearing it 13
 - Switching the VMX 200-II on/off 15
 - Retrieving information on the remaining talk time 16
 - Changing the speaker volume 16
 - Making calls using the headset 17
 - Managing multiple calls 19
 - Listening to music using the headset 20
- Cleaning and maintaining the VMX 200-II** 21
- If a problem occurs ...** 22
 - Restoring factory default settings (Reset) 22
 - If you are out of the **Bluetooth** transmission range 23
- Specifications** 24
- Manufacturer Declarations** 25



Important safety information

- ▶ Read this instruction manual carefully and completely before using the product.
- ▶ Always include this instruction manual when passing the product on to third parties.
- ▶ Do not use an obviously defective product.

Preventing damage to health and accidents

- ▶ Do not listen at high volume levels for long periods of time to prevent hearing damage.
- ▶ Always maintain a distance of at least 3.94" (10 cm) between the ear cups and the cardiac pacemaker or implanted defibrillator since the product generates permanent magnetic fields.
- ▶ Keep the product, accessories and packaging parts out of reach of children and pets to prevent accidents and choking hazards.
- ▶ Do not use the product in an environment that requires your special attention (e.g. in traffic).
- ▶ Do not wear the headset during charging since the rechargeable battery can get warm.

Preventing damage to the product and malfunctions

- ▶ Always keep the product dry and do not expose it to extreme temperatures (hairdryer, heater, extended exposure to sunlight, etc.) to avoid corrosion or deformation.
- ▶ Only use attachments/accessories supplied or recommended by Sennheiser.
- ▶ Only clean the product with a soft, dry cloth.
- ▶ Only use the product in environments where wireless **Bluetooth®** transmission is permitted.

Intended use/Liability

The VMX 200-II is an accessory for mobile phones or any **Bluetooth** compliant device with a "hands free profile" (HFP), a "headset profile" (HSP), an "audio video remote control profile" (AVRCP) and an "advanced audio distribution profile" (A2DP). It is intended for wireless communication via **Bluetooth** connection.

It is considered improper use when this product is used for any application not named in this instruction manual.

Sennheiser does not accept liability for damage arising from abuse or misuse of this product and its attachments/accessories.

Sennheiser is not liable for damages to USB devices that are not consistent with the USB specifications.

Sennheiser is not liable for damages resulting from the loss of connection due to flat or overaged rechargeable batteries or exceeding the **Bluetooth** transmission range.

Safety instructions for rechargeable batteries

In extreme cases, abuse or misuse of rechargeable batteries can lead to:



WARNING

- explosion,
- fire development,
- heat generation or
- smoke or gas development.

	<p>Dispose of products with built-in rechargeable batteries at special collection points or return them to your specialist dealer.</p>		<p>Switch rechargeable battery-powered products off after use.</p>
	<p>Only use rechargeable batteries recommended by Sennheiser and the appropriate chargers.</p>		<p>When not using rechargeable batteries for extended periods of time, charge them regularly (about every 3 months).</p>
	<p>Only charge rechargeable batteries at ambient temperatures between 10°C/50°F and 40°C/104°F.</p>		<p>Do not heat above 70°C/158°F, e.g. do not expose to sunlight or throw into a fire.</p>

The VMX 200-II Bluetooth headset

The stylish new VMX 200-II **Bluetooth** headset is the wireless solution for phone calls with superb sound quality. It features VoiceMax Dual Microphone technology that filters away background noise and enhances your voice, thus providing crystal clear speech.

Bluetooth



The VMX 200-II complies with the **Bluetooth** 3.0 standard and is compatible with all **Bluetooth** 1.1, 1.2, 2.0, 2.1 and 3.0 devices with a “hands free profile” (HFP), a “headset profile” (HSP), an “audio video remote control profile” (AVRCP) and an “advanced audio distribution profile” (A2DP). The VMX 200-II provides wireless freedom to give hands-free convenience with your mobile phone.

Additional features of the VMX 200-II Bluetooth headset

- VoiceMax Dual Microphone technology – two microphones work in synergy; one to emphasize your voice, the other to remove noise
- Echo-free conversations – digital echo cancellation eliminates all echoes while you are talking
- Easy call control – with just one hand, you can quickly take or end calls and adjust the volume to suit you best
- HD quality sound – crystal-clear, detailed and transparent sound reproduction due to large wideband speaker (11 mm) and extended frequency response
- Lightweight comfort – weighs only 10 grams
- Flexible wearing style – wear left or right, use with or without ear hook
- Long talk time – talk to business partners and friends for up to 10 hours, with up to 12 days of standby time
- Headset battery level indicator displayed on Apple iPhone® screen
- Adaptive volume level – automatic, adaptive volume adjustment for optimized speech intelligibility and sound quality

Delivery includes



VMX 200-II mono **Bluetooth** headset
with built-in rechargeable Lithium-Polymer battery



Ear hook



Ear adapter without loop



Ear adapters with loop (S, M, L)

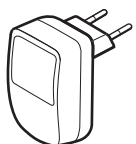

Power supply unit (EU/US version)
not supplied with the VMX 200-II USB version

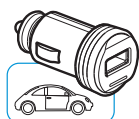

Car charger
only for VMX 200-II 3in1 version

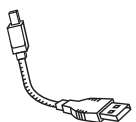

Charging cable



Quick Guide



Safety Guide



A list of accessories can be found on the VMX 200-II product page at www.sennheiser.com. For information on suppliers, contact your local Sennheiser partner: www.sennheiser.com > "Sales Partner".

Product overview

VMX 200-II headset

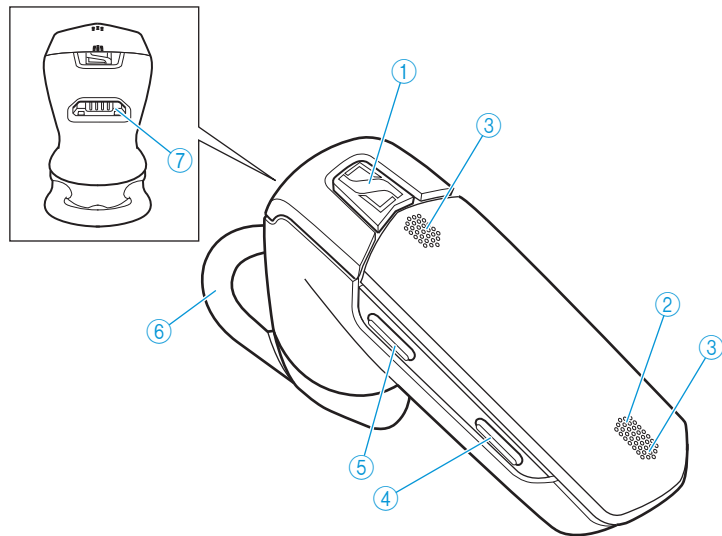

- ① Multi-function button
- ② LED
- ③ Microphone
- ④ Volume down button
- ⑤ Volume up button
- ⑥ Ear adapter with loop
- ⑦ USB socket

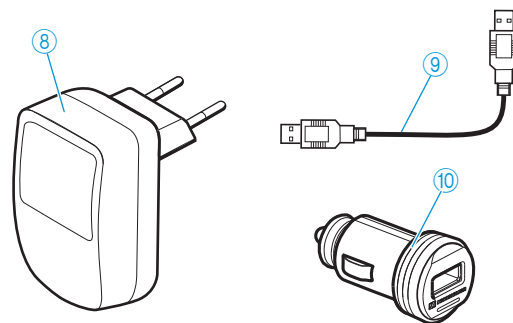

Charging accessories









- ⑧ Power supply unit (EU/US version) not supplied with the VMX 200-II USB version
- ⑨ Charging cable
- ⑩ Car charger only for VMX 200-II 3in1 version

Overview of pictograms



Meaning of the pictograms for pressing a button

Pictogram	Meaning
	Briefly press this button.
	Double-press this button.
	Keep this button pressed for 5 seconds.



Meaning of the pictograms for the beeps

Pictogram	Meaning
	Ascending sequence of beeps
	Descending sequence of beeps
	One beep
	Several beeps
	Two descending beeps
	Two ascending beeps

Meaning of the pictograms for the flashing of the LED

Pictogram	Meaning
	This pictogram symbolizes a flashing.
	This pictogram symbolizes an interruption.
	This pictogram symbolizes a time interval.

Examples of some of the pictograms that are used throughout this instruction manual:







Pictogram	Meaning
	The LED flashes rapidly.
	The LED flashes once every 3 seconds.
	The LED flashes 3 times per second.

The pictogram “i”

 Notes marked with the pictogram “i” provide important information on the use of the headset.

Overview of the LED indications

Meaning during operation



LED	Meaning
	Headset switches on
	Headset switches off
	Headset is in pairing mode
	Pairing was successful
	Pairing has failed or has been cancelled
	Connectable state, not connected

Once the headset is successfully connected, the LED goes off.

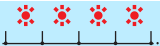
Meaning during calls

LED	Meaning
	Incoming call
	Incoming call + rechargeable battery is weak

Meaning during charging

LED	Meaning
	Charging in progress: battery level between 0% and 50%
	Charging in progress: battery level above 50%
	Battery is fully charged

Overview of buttons

Multi-function button

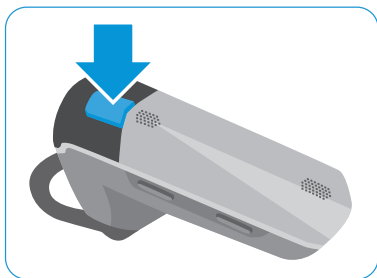

Press the button	Function	Page
	Accepts a call	17
	Ends a call	17
	Transfers a call from the mobile phone to the headset	17
	Accepts an incoming call and ends the active call (managing two calls)	19
	Ends the active call and makes the call on hold active (managing two calls)	19
	Stops redialing	18
	Pauses the track/resumes the track	20
	Rejects the incoming call and continues the active call (managing two calls)	19
	Establishes a conference call (managing two calls)	19
	Transfers a call from the headset to the mobile phone	17
	Rejects a call	17
	Voice dialing	18
	Stops voice dialing	18
	Rejects the incoming call and continues the active call (managing two calls)	19
	Redials the last number	18
	Accepts an incoming call and puts the active call on hold (managing two calls)	19
	Toggles between two calls (managing two calls)	19
	Switches the headset on	15
	Switches the headset off	15
	Changes to pairing mode	12

Volume buttons

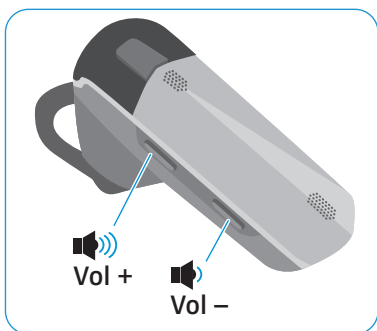

Button	Duration	Function	Page
		Increases/reduces the volume	16
		Mutes the headset's microphone	18
		Unmutes the headset's microphone	18
		Retrieves information on the remaining talk time	16
		Resets the headset to the factory default settings	22

Putting the VMX 200-II into operation

Charging the headset battery



WARNING

Danger of injury!

Wearing the headset when charging can cause burns and injuries.

▶ Do not wear the headset when charging.



A complete charging cycle takes about 1 hour and 20 minutes. Before using the headset for the first time, charge the rechargeable battery for a complete charging cycle without interruption.

A charging time of ...	corresponds to a talk time of ...
approx. 10 min	approx. 1 h 30 min
approx. 20 min	approx. 2 h 40 min
approx. 40 min	approx. 5 h 20 min
approx. 60 min	approx. 7 h 30 min
approx. 80 min	approx. 10 h

- 1 Take off the headset and switch it off (see page 15).
- 2 Connect the smaller plug of the charging cable to the USB socket of the VMX 200-II.
- 3 Connect the USB plug of the charging cable to the USB socket of the power supply unit or your computer.
- 4 The battery is being charged.
The LED lights up red until the charge state reaches 50%. Then the LED lights up blue until the charging cycle is complete. When the rechargeable battery is fully charged, the LED flashes 3 times blue and then goes off.

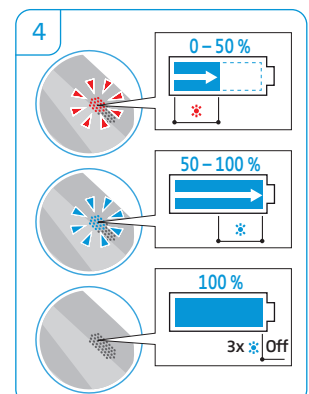
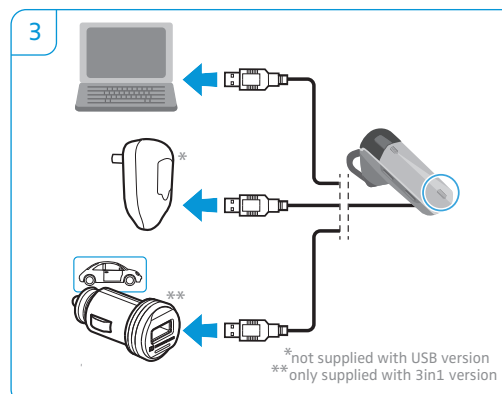
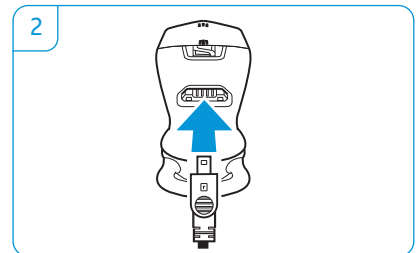
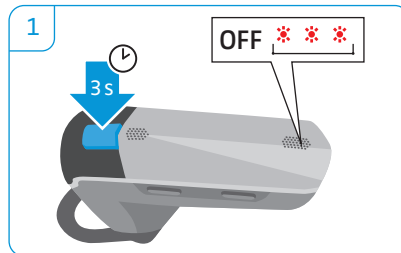

i When the battery level drops below 15 minutes of talk time, the LED flashes red and you hear a low battery warning every 5 minutes. The headset automatically switches off after the battery has dropped below the minimum level.

Charging the rechargeable battery using the USB smart charging cable

The shapeable USB charging cable allows you to charge the headset so that it, for example, does not even touch your desk. Its compact size also prevents cable tangles.

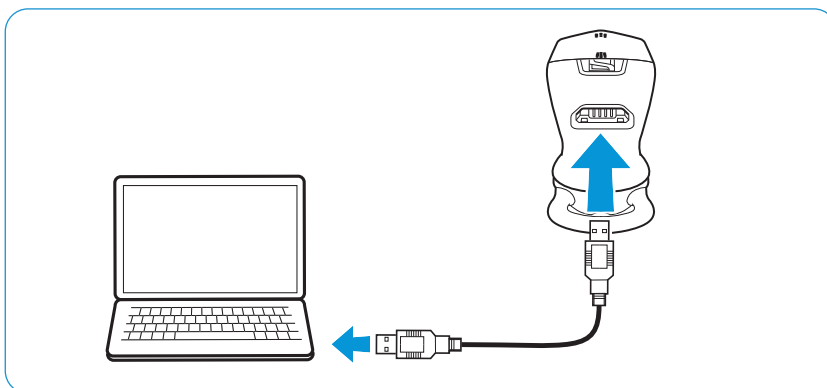

Connecting the headset to a Bluetooth device

CAUTION

Danger of malfunction!

The transmitted radio waves of mobile phones can impair the operation of sensitive and unprotected devices.

- ▶ Only make calls with the headset in locations where wireless **Bluetooth** transmission is permitted.

The headset complies with the **Bluetooth** 3.0 standard. In order that data can be transmitted wirelessly using **Bluetooth** technology, you have to pair your headset with **Bluetooth** devices that support the "hands free profile" (HFP), the "headset profile" (HSP), the "audio video remote control profile" (AVRCP) and the "advanced audio distribution profile" (A2DP).

The headset can save the connection profiles of up to eight **Bluetooth** devices with which it has been paired. After switch-on, the headset automatically tries to connect to the two last connected **Bluetooth** devices.

If you pair the headset with a ninth **Bluetooth** device, the saved connection profile of the first **Bluetooth** device will be overwritten. If you want to re-establish a connection with the first **Bluetooth** device, you have to pair the headset again.

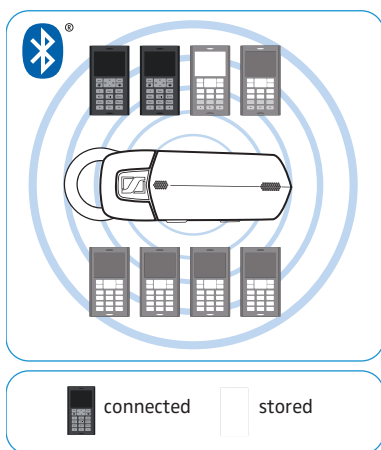

Pairing the VMX 200-II with a Bluetooth device

The following chapter describes, by way of example of a mobile phone, how to pair the VMX 200-II with a **Bluetooth** device. In case of deviation, proceed as described in the instruction manual of your mobile phone.

- 1 Switch the headset off (see page 15). Then keep the multi-function button pressed until the LED alternately flashes blue and red. The headset is in pairing mode.
- 2 Enable the **Bluetooth** visibility on your mobile phone.
- 3 On the mobile phone, start a search for Bluetooth devices. All available devices in the proximity of the mobile phone are displayed.
- 4 From the found Bluetooth devices, select "Sennheiser VMX 200-II" to establish a Bluetooth connection to the headset. If necessary, enter the default PIN code "0000".
- 5 Once the headset is paired with the mobile phone, the LED turns off.

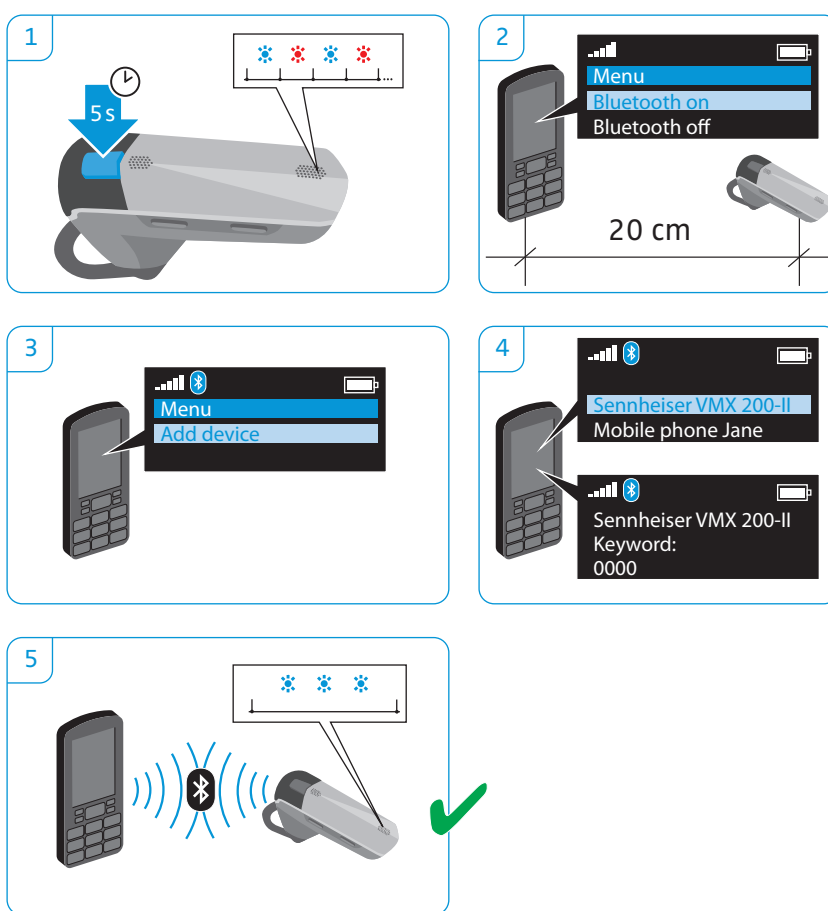

If pairing is not successful within 5 minutes, the headset automatically returns to connectable mode. Repeat the pairing procedure.

Using the VMX 200-II

Individually adjusting the VMX 200-II and wearing it

For an optimized and individual wearing comfort, the VMX 200-II can be worn on your left or right ear in two different ways, i.e. with or without the ear hook.

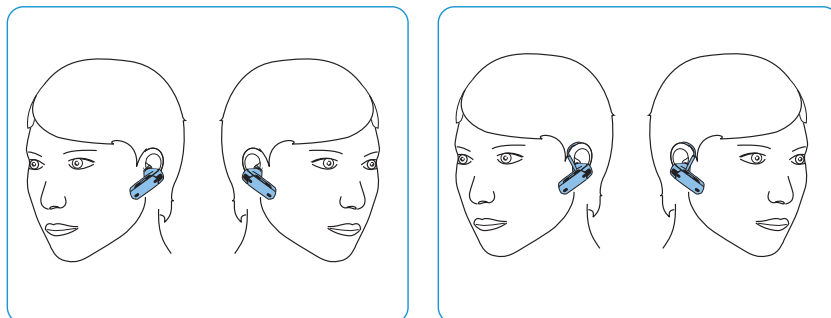

Wearing the VMX 200-II with ear adapter

The ear adapter with loop is supplied in 3 different sizes: S, M, L. Size M is pre-installed. Select the size that fits your ear.

- 1 If the pre-installed ear adapter with loop is not the right size, remove it from the headset.
- 2 Attach the selected ear adapter with loop to the headset.
- 3 Move the headset to your ear and insert the loop of the ear adapter.
- 4 Adjust the angle of the loop so that the headset fits comfortably and securely in your ear.

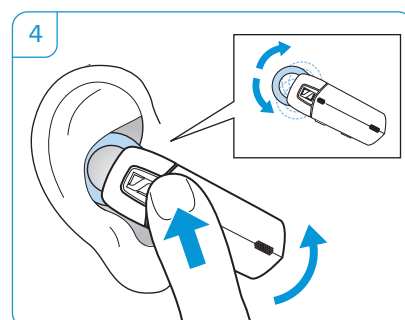
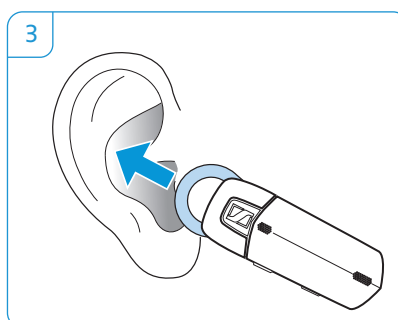
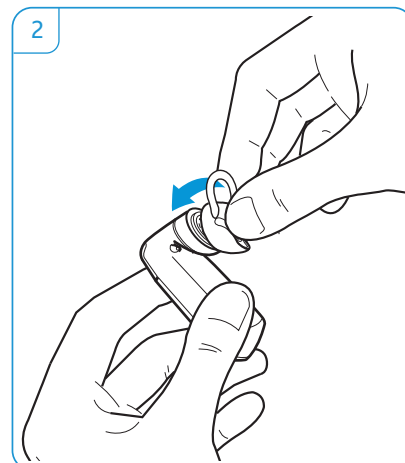
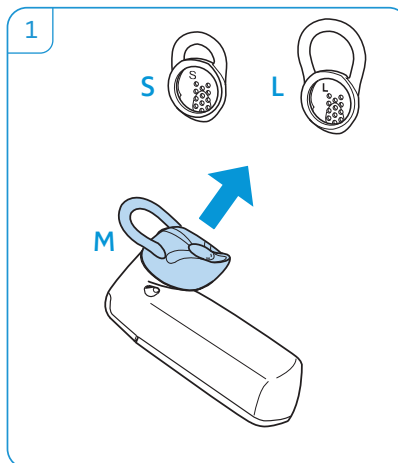

Wearing the VMX 200-II using the ear hook

If you prefer using the ear hook, always wear it in combination with the ear adapter without loop to ensure optimum wearing comfort.

- 1 Remove the pre-installed ear adapter with loop.
- 2 Attach the ear adapter without loop to the headset.
- 3 Attach the ear hook to the VMX 200-II. If you want to change the wearing ear of the headset, attach the ear hook the other way round.
- 4 Move the headset to your ear and guide the ear hook behind your ear.
- 5 Position the headset so that it fits comfortably.

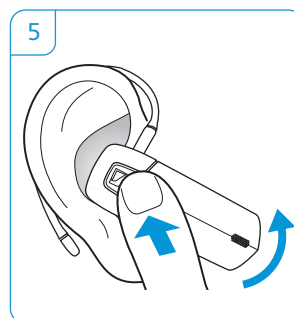
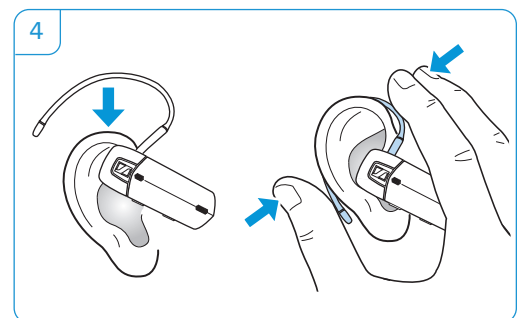
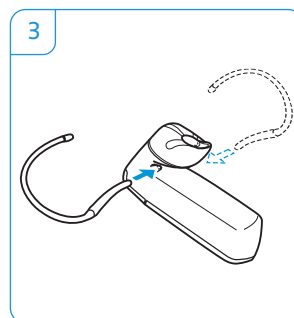
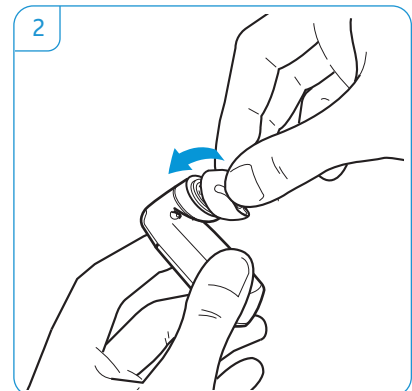
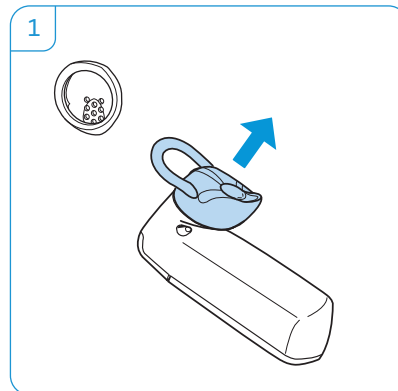

Switching the VMX 200-II on/off

Switching the headset on

- ▶ Press and hold the multi-function button until the LED flashes blue 3 times. The voice prompt "power on" is announced in the headset. When the headset is paired but not yet connected to the mobile phone, the LED flashes 3 times blue every 5 seconds. Once the headset and the mobile phone are connected, the LED goes off and the voice prompt "connected" is announced in the headset.

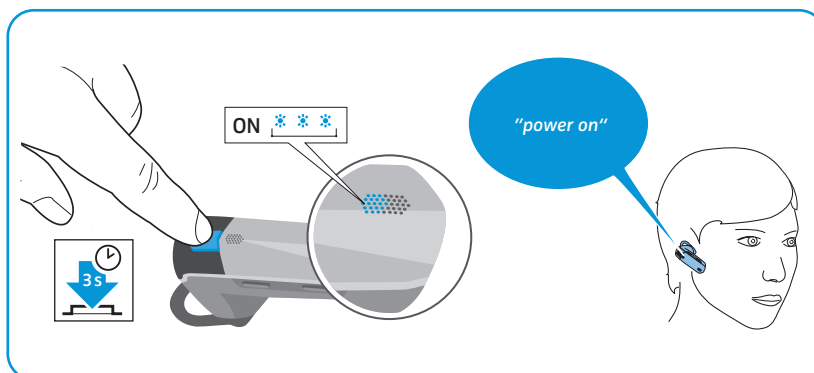

Switching the headset off

- ▶ Press the multi-function button for 3 seconds. The voice prompt "power off" is announced in the headset and the LED flashes red 3 times. The headset switches off. If the headset is switched off during an active call, the call will be transferred to the mobile phone.

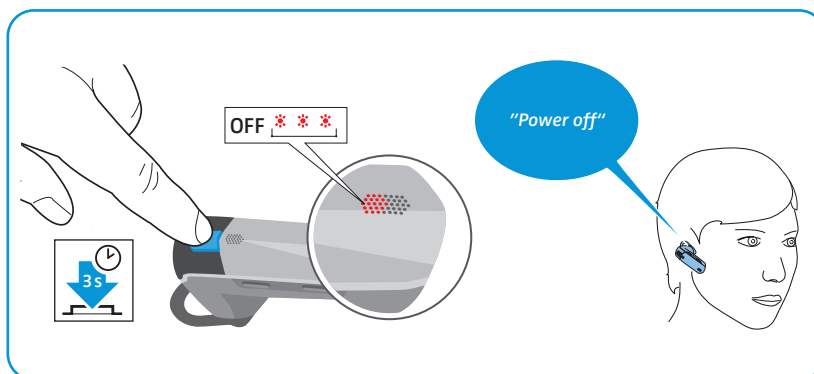

If the headset has not been used for more than 1 hour, it automatically switches off to conserve battery power.

- i** Connection profiles and volume settings are saved automatically when the headset is switched off.

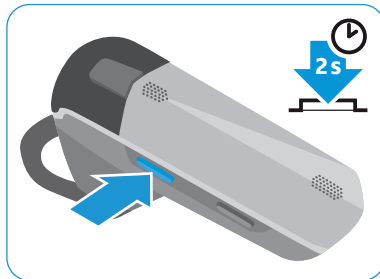

Retrieving information on the remaining talk time

You can retrieve information on the remaining talk time at any time except when you are on a call or listening to music:

- ▶ Press the Volume + button for 2 seconds.

Information announced	Meaning
"Between 5 and 10 hours talk time"	Remaining talk time
"Between 2 and 5 hours talk time"	
"Less than 2 hours talk time"	
"Recharge headset"	1st time: Remaining talk time is less than 15 minutes. 2nd time: Remaining talk time is less than 5 minutes. Charge the headset's battery (see page 10)

Battery level indicator displayed on Apple iPhone

When the headset is paired with an iPhone, the iPhone screen shows an additional battery level indicator for the headset.

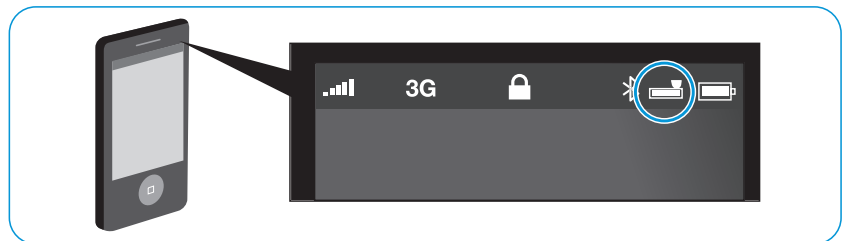

Changing the speaker volume

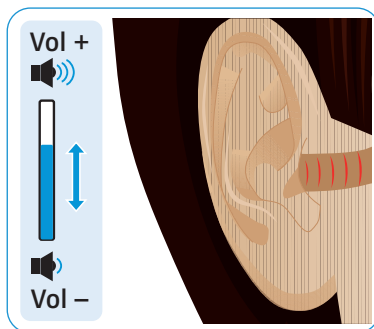

WARNING

Hearing damage due to high volumes!

Listening at high volume levels for long periods can lead to permanent hearing defects.

- ▶ Set the volume to a low level before putting on the headset.
- ▶ Do not continuously expose yourself to high volumes.

- ▶ Press the
 - volume up button to increase the volume.
 - volume down button to reduce the volume.

When the minimum or maximum volume is reached, you hear a beep in the headset.

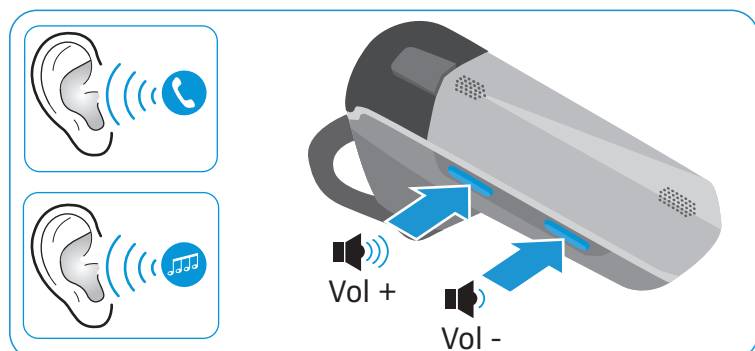

Making calls using the headset

Making a call

- ▶ Dial the desired number on your mobile phone. You hear a beep in the headset.
- ▶ If your mobile phone does not automatically transfer the call to the headset, simply press the multi-function button once to transfer the call from the mobile phone to the headset. Alternatively, press a button on your mobile phone (see the instruction manual of your mobile phone).



Accepting/rejecting/ending a call

When your VMX 200-II is connected to a mobile phone and you receive a call, you hear a ring tone in the headset and the LED flashes blue. If the headset battery is low, the LED flashes red instead of blue.

If you listen to music, the music is paused until you end the call.

When you receive a call and your headset is switched off, simply switch your headset on to accept the call.

- ▶ Press the multi-function button:

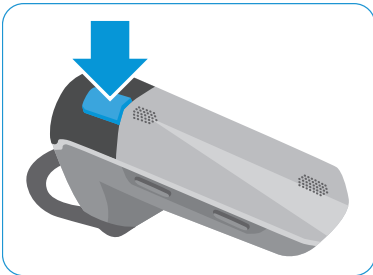

Duration	Function	Voice prompt/beeps
	Accepts a call	
	Rejects a call	"Rejecting call"
	Ends a call	"Call ended"

Transferring the call to/from the headset

Once a connection is established, you can transfer the call to/from the headset.

- ▶ Press the multi-function button:

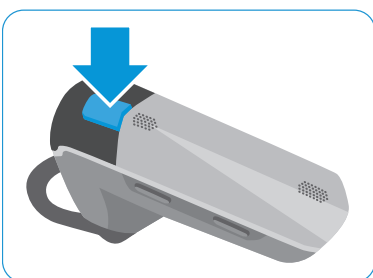



Duration	Function	Beep(s)
	Transfers a call from the headset to the mobile phone	
	Transfers a call from the mobile phone to the headset	

Redialing

The redialing function must be supported by your mobile phone or Bluetooth device (with HF profile respectively) and be activated.

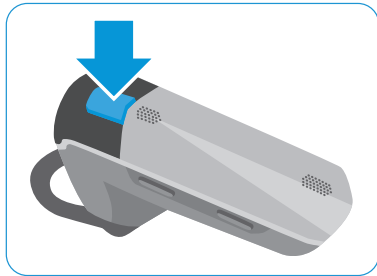
- ▶ Press the multi-function button:





Duration	Function	Voice prompt	
2x		Redials the last number	"Redialing"
		Stops redialing	"Call ended"

Voice dialing

The voice dialing function must be supported by your mobile phone (with HF profile) and be activated. Follow the instructions in the instruction manual of your mobile phone.

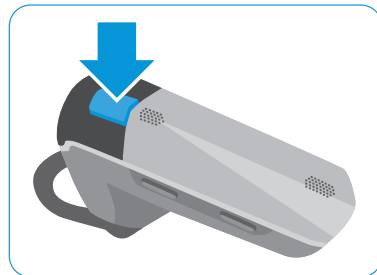
- ▶ Press the multi-function button for about 2 seconds until you hear 2 beeps. Release the multi-function button to start the voice dialing.





Duration	Function	Voice prompt	
2s		Starts/stops voice dialing	"Voice dial"

- ▶ Say the name of the person you want to call.
The mobile phone automatically dials the corresponding number.

Muting the headset's microphone

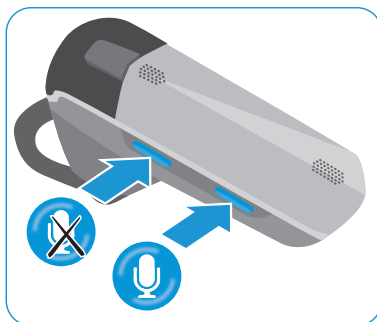
- ▶ Press the Volume up or down button:



Duration	Function	Voice prompt	
2s		Mutes the headset's microphone	"Mute on"
2s		Unmutes the headset's microphone	"Mute off"

-  While the microphone is muted, you hear a beep every 4 seconds.

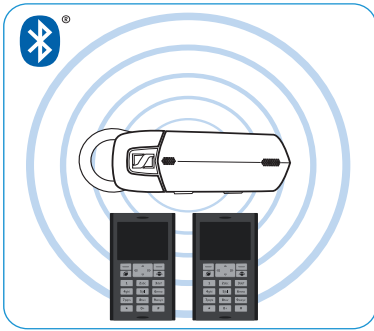

Managing multiple calls

You can use the VMX 200-II simultaneously with two connected **Bluetooth** devices (Multi Connection).

In order for this to function, at least two **Bluetooth** devices must already be paired with the headset. To do so, follow the instructions in the chapter "Connecting the headset to a Bluetooth device" (see page 11).

- ▶ Switch the headset on. The headset automatically tries to establish a **Bluetooth** connection to the two last connected **Bluetooth** devices.

Managing two calls

You can manage two calls:

- from **either two** different **Bluetooth** devices or
- from **one Bluetooth** device.
If you want to manage two calls from one **Bluetooth** device, disconnect the second **Bluetooth** device.

If you receive a call during an active call:

- ▶ Press the multi-function button:

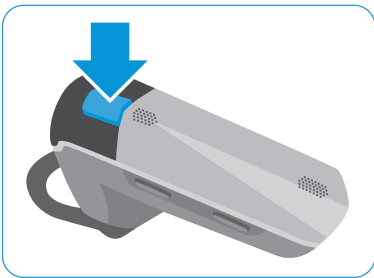

Duration	Active call	2nd incoming call	Function
			Accepts the incoming call and ends the active call Voice prompt: "Call ended"
			Accepts the incoming call and puts an active call on hold (toggling – phone dependent)
			Rejects the incoming call and continues the active call



If you put an active call on hold (toggling):

- ▶ Press the multi-function button again:

Duration	Active call	2nd call put on hold	Function
			Ends the active call and makes the call on hold active (phone dependent)
			Establishes a conference call (for 2 calls on one mobile phone only)

Listening to music using the headset

If your headset has a **Bluetooth** connection to an audio source (e.g. mobile phone, tablet or computer) and supports the A2DP/AVRCP standard, you can use the headset to listen to music and remote-control your audio source.

Once music is selected and started from the audio source, further changes can be activated directly from the headset as follows:

- ▶ Press the multi-function button or the Volume up or down button:

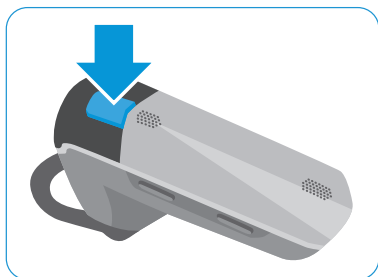

Duration	Function	
		Resumes the track (if paused)
		Pauses the track

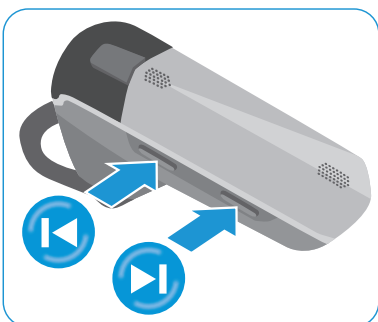

Duration	Function	
		Skips to the next track
		Skips to the previous track

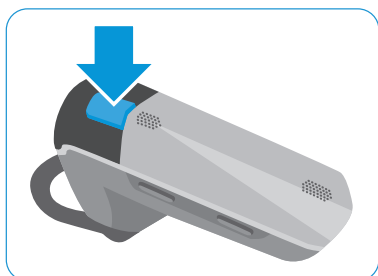

Duration	Music	Function	
			Pauses the track and activates voice dialing
			Pauses the track and starts redialing

Cleaning and maintaining the VMX 200-II

CAUTION

Liquids can damage the electronics of the product!

Liquids entering the housing of the device can cause a short circuit and damage the electronics.

- ▶ Keep all liquids far away from the product.
 - ▶ Do not use any cleansing agents or solvents.
-

Cleaning the headset

- ▶ Only use a dry cloth to clean the product.

Storing the headset

If you do not use the headset for extended periods of time:

- ▶ Charge the built-in rechargeable battery every 6 months for about 1 hour.
- ▶ Store the headset in a clean and dry environment.

If a problem occurs ...

Problem	Possible cause	Possible solution	Page
Headset cannot be switched on	The rechargeable battery is flat.	Recharge the rechargeable battery.	10
No audio signal	The headset is not paired with the mobile phone.	Check if the headset is paired. If necessary, pair the headset with the mobile phone again.	12
	The volume is adjusted too low.	Increase the volume.	16
	The headset is switched off.	Switch the headset on.	15
Headset cannot be paired	The pairing does not work.	Check if the your Bluetooth device supports the HF or HS profile.	–
	The mobile phone is switched off.	Switch the mobile phone on.	15
Headset does not react to any button press	The operation of the headset is faulty.	Reset the headset to the factory default settings.	22

If a problem occurs that is not listed in the above table or if the problem cannot be solved with the proposed solutions, please contact your local Sennheiser partner for assistance.

To find a Sennheiser partner in your country, search at www.sennheiser.com.

Restoring factory default settings (Reset)

You can restore the following settings to their factory default settings:

- list of paired Bluetooth devices (afterwards empty)
- 1 Set the headset to pairing mode (see page 12). The LED flashes alternately blue and red, indicating that the headset is in pairing mode.
 - 2 Simultaneously press and hold the volume up button and the volume down button for 3 seconds.

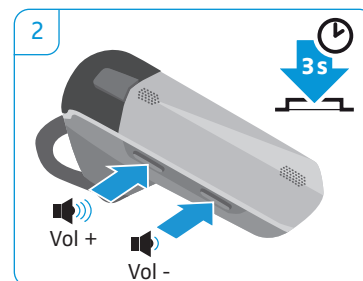
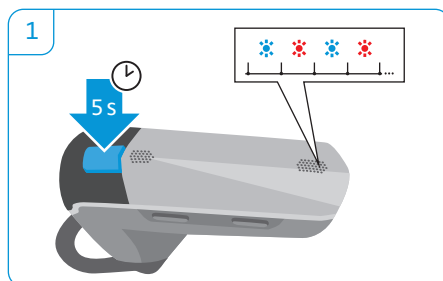

If you are out of the Bluetooth transmission range

Calling is only possible in the **Bluetooth** transmission range of the mobile phone. The transmission range largely depends on environmental conditions such as wall thickness, wall composition etc. With a free line of sight, the transmission range of most mobile phones and **Bluetooth** devices is up to 10 meters.

If the headset gets out of the the **Bluetooth** transmission range of the mobile phone, the sound quality deteriorates and the voice prompt "lost connection" is announced in the headset. This announcement is repeated at regular intervals for 5 minutes.

If you re-enter the **Bluetooth** transmission range within these 5 minutes, the connection is re-established and the voice prompt "connected" is announced in the headset.

If you spend more than 5 minutes outside the **Bluetooth** transmission range, the connection breaks down completely and you have to manually re-establish the connection.

To re-establish a connection to the mobile phone:

- ▶ Briefly press the multi-function button.
Once the connection is successfully re-established, the voice prompt "connected" is announced in the headset.

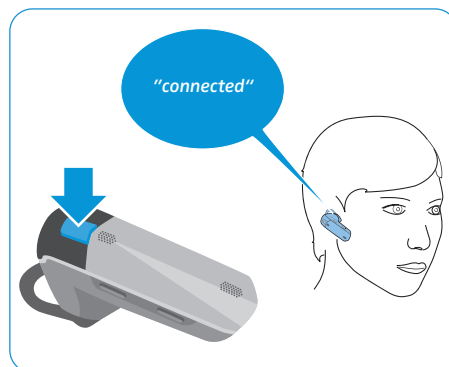

Specifications

VMX 200-II

Dimensions (W x H x D)	approx. 55 x 26 x 58 mm
Weight without ear hook	approx. 10 g
Standby time	up to 12 days
Talk time	up to 10 hours
Charging time	1 h 20 min
Rechargeable battery (built-in)	Lithium Polymer; 3.7 V; 120 mA
Speaker type	dynamic, neodymium magnet
Microphone type	dual omni-directional electret microphone
Audio	digital noise and echo suppression
Operating temperature range	+10°C (+50°F) to +40°C (+104°F)
Operating relative humidity	20 to 85%, non-condensing
Storage temperature range	-20°C (-4°F) to +60°C (140°F)
Storage relative humidity	10 to 95%, non-condensing
Car charger – model number*	CAWQ02-5.0-150C/SIL-C05050A



Bluetooth

Bluetooth	version 3.0
Range	up to 10 m/class 2
Transmission frequency	2402 MHz to 2480 MHz
Profiles	HSP (v1.2), HFP (v1.6), A2DP (v1.2), AVRCP (v1.0)
Output power	3.07 dbm/2.028 mW

VMX 200-II power supply unit*

Model number	US version: SSA-3P 050015US EU version: SSA-3P 050015EU
Nominal input voltage	100 – 240 V~
Nominal input current	max. 0.2 A
Mains frequency	50 – 60 Hz
Nominal output voltage	5 V ===
Nominal output current	max. 150 mA
Operating temperature range	+10°C (+50°F) to +40°C (+104°F)
Operating relative humidity	20 to 85%, non-condensing
Storage temperature range	-20°C (-4°F) to +60°C (140°F)
Storage relative humidity	10 to 95%, non-condensing
Weight	approx. 75 g

* Not supplied in VMX 200-II USB version.

Manufacturer Declarations

Warranty

Sennheiser electronic GmbH & Co. KG gives a warranty of 24 months on this product. For the current warranty conditions, please visit our website at www.sennheiser.com or contact your Sennheiser partner.

FOR AUSTRALIA ONLY

Sennheiser's goods come with guarantees that cannot be excluded under the Australian Consumer Law. You are entitled to a replacement or refund for a major failure and compensation for any other reasonably foreseeable loss or damage. You are also entitled to have the goods repaired or replaced if the goods fail to be of acceptable quality and the failure does not amount to a major failure.

This warranty is in addition to other rights or remedies under law. Nothing in this warranty excludes, limits or modifies any liability of Sennheiser which is imposed by law, or limits or modifies any remedy available to the consumer which is granted by law. To make a claim under this warranty, contact Syntec International Pty Ltd, Unit 3, 31 Gibbes Street Chatswood NSW 2067, AUSTRALIA Phone: (02) 9910 6700, email: service@syntec.com.au. All expenses of claiming the warranty will be borne by the person making the claim.

The Sennheiser International Warranty is provided by Syntec International Pty Ltd (ABN 94003433798), unit 3, 31 Gibbes Street Chatswood NSW 2067 Australia.

In compliance with the following requirements

- RoHS Directive (2002/95/EC)
- WEEE Directive (2002/96/EC)



Please dispose of this product by taking it to your local collection point or recycling center for such equipment. This will help to protect the environment in which we all live.

- Battery Directive (2006/66/EC)



The product built-in rechargeable batteries can be recycled. In order to protect the environment, please dispose of defective products with built-in rechargeable batteries as special waste or return them to your specialist dealer.

CE Conformity

- R&TTE Directive (1999/5/EC)
- EMC Directive (2004/108/EC)
- Low Voltage Directive (2006/95/EC)
- ErP Directive (2009/125/EC)

The CE Declaration of Conformity is available on our website at www.sennheiser.com. Before putting the device into operation, please observe the respective country specific regulations!

In compliance with:

USA	FCC ID: DMOCBMSDE
Canada	IC: 2099A-VMX200II
Europe	  
Australia/ New Zealand	
Singapore	Complies with IDA Standards DB100582
Russia	 ME10
Japan	  201-125641
Korea 해당 무선설비는 운용 중전파혼신 가능성이 있음. 해당 무선설비는 전파혼신 가능성이 있으므로 인명안전과 관련 된 서비스는 할 수 없음.	
Certification no.	 KCC-CRM-SE9-VMX200-II
Product name	Bluetooth headset
Model	VMX 200-II
Applicant	Sennheiser electronic GmbH & Co. KG
Manufacturer	Sennheiser electronic GmbH & Co. KG
Country of Origin	China
Bluetooth	 Bluetooth 

Statements regarding FCC and Industry Canada

This device complies with Part 15 of the FCC Rules and with Industry Canada standard(s) for license-exempt radio devices. Operation is subject to the following two conditions: (1) this device may not cause harmful interference, and (2) this device must accept any interference received, including interference that may cause undesired operation.

This equipment has been tested and found to comply with the limits for a Class B digital device, pursuant to Part 15 of the FCC Rules and RSS 210 of Industry Canada. These limits are designed to provide reasonable protection against harmful interference in a residential installation. This equipment generates, uses and can radiate radio frequency energy and, if not installed and used in accordance with the instructions, may cause harmful interference to radio communications. However, there is no guarantee that interference will not occur in a particular installation. If this equipment does cause harmful interference to radio or television reception, which can be determined by turning the equipment off and on, the user is encouraged to try to correct the interference by one or more of the following measures:

- Reorient or relocate the receiving antenna.
- Increase the separation between the equipment and receiver.
- Connect the equipment into an outlet on a circuit different from that to which the receiver is connected.
- Consult the dealer or an experienced radio/TV technician for help.

Changes or modifications made to this equipment not expressly approved by Sennheiser electronic Corp. may void the FCC authorization to operate this equipment.

RF Radiation Exposure Information

Since the radiated output of this device is far below the FCC/IC RF radio frequency exposure limits, it is not subjected to routine RF exposure evaluation as per Section 2.1093 of the FCC rules and RSS GEN rules sections 2.5.1 & 2.5.2.

Trademarks

The **Bluetooth**[®] word mark and logos are registered trademarks owned by Bluetooth SIG, Inc. and any use of such marks by Sennheiser electronic GmbH & Co. KG is under license.

iPod[®] and iPhone[®] are registered trademarks of Apple Inc, registered in the U.S. and other countries.

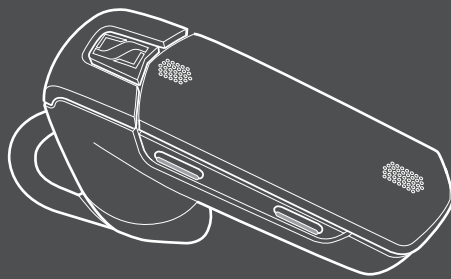

Sennheiser electronic GmbH & Co. KG

Am Labor 1, 30900 Wedemark, Germany
www.sennheiser.com

Publ. 10/12, A02

Free Manuals Download Website

<http://myh66.com>

<http://usermanuals.us>

<http://www.somanuals.com>

<http://www.4manuals.cc>

<http://www.manual-lib.com>

<http://www.404manual.com>

<http://www.luxmanual.com>

<http://aubethermostatmanual.com>

Golf course search by state

<http://golfingnear.com>

Email search by domain

<http://emailbydomain.com>

Auto manuals search

<http://auto.somanuals.com>

TV manuals search

<http://tv.somanuals.com>