

CC616

USER'S GUIDE

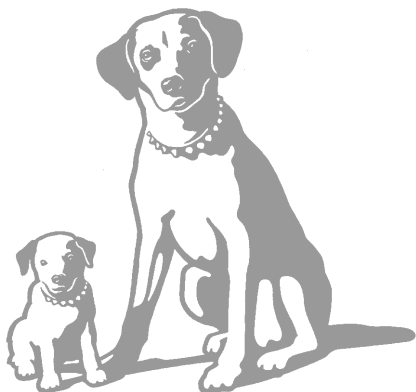

VHS

CAMCORDER

REC

Important Safety Information

Be sure to read all the safety information before you begin to use this product.

WARNING: To reduce the risk of fire or shock hazard, do not expose camcorder or AC adapter/charger to rain or moisture.

CAUTION

RISK OF ELECTRIC SHOCK
DO NOT OPEN



This symbol indicates “dangerous voltage” inside the product that presents a risk of electric shock or personal injury.

ATTENTION

RISQUE DE CHOC
ELECTRIQUE NE PAS OUVRIR



This symbol indicates important instructions accompanying the product.

Cautions

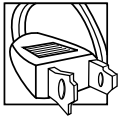

CAUTION: To prevent electric shock, match wide blade of plug to wide slot, fully insert.

ATTENTION: Pour éviter les chocs électriques, introduire la lame la plus large de la fiche dans la borne correspondante de la prise et pousser jusqu'au fond.

To reduce risk of injury, charge only rechargeable batteries recommended by the manufacturer for this camcorder. Other types of batteries may burst causing damage and personal injury.

FCC Regulations state that unauthorized changes or modifications to this equipment may void the user's authority to operate it.

Product Registration

Please fill out the product registration card and return it immediately. Returning this card allows us to contact you if needed.

Keep your sales receipt for proof of purchase to obtain warranty parts and service and attach it here. Record the serial and model numbers located on the bottom of the camcorder.

Model No: CC616

Serial No: _____

Purchase Date: _____

Purchased From: _____

Assistance

We want to make sure you enjoy your new camcorder. If you have any questions, call:

Camcorder Exchange Warranty.....800-283-6503 (pages 78-79)

Customer Service.....800-336-1900 (page 77)

Accessories.....800-338-0376 (pages 64-69)

Table of Contents

Safety Information	i	• Play Back Your Recording	8
Product Registration	i	• Turn off the Camcorder	8
Table of Contents	1-2	• Review Camcorder's Operating Controls	9-10
First-Time Operation		Powering Your Camcorder	
• Assistance	3	• Using Adapter/Charger	11
• Unpack Camcorder & Accessories	3	• Using Rechargeable Battery	12-14
• Attach the Adapter/Charger	4	• Using Optional Car Cord Adapter ...	15
• Insert a Tape	4	Remote Control	
• Open Lens Cover	5	• Buttons	16-17
• Adjust Handstrap	5	• Install Battery Cell	18
• Turn on Camcorder	5	• Remote Sensor	18
• Select a Recording Speed	6	Traveling Tips	19
• Set the <i>SCENE SELECT AE</i> Dial	7	Video Cassettes	20-21
• Adjust Viewfinder and Eyepiece Focus Control	7		
• Start and Stop Recording	8		

Table of Contents

Recording

- Make a Recording22-23
- Recording Tips24
- Viewfinder25
- Viewfinder Displays.....26-29
- Tally Light30
- Microphone.....30
- Flying Erase Head30
- Tape Positioning30
- Electronic Indexing30
- Quick Review31
- Auto Head Cleaner31
- Camera Edit31
- Time Counter With Memory Stop...32
- Tape Time-Remaining Display33
- Zooming34
- *SCENE SELECT AE* Dial35
- White Balance36
- *MODE* Button.....37
- Fading In and Out38
- 16X9 Mode39
- Focusing (Auto and Manual)40-41
- Exposure Control (Iris).....42
- Self-Timer (Remote Only)43
- Titler.....44-45
- Date and Time Display
 - Install the Clock Cell.....46
 - Set the Date and Time47
 - Select the Date, Time, or
Title to Record.....48-49

- Animation and Time-Lapse
Recording (Remote Only)50-51
- Audio Dubbing (Remote Only)52
- Edit Insert (Remote Only)53
- Built-in Color Enhancement
Light54-55
- Attaching the Shoulder Strap.....56

Playback

- Viewfinder Playback57
- Visual Searching.....57
- Stop-Action Pause57
- Tracking.....57
- Using the Cassette Adapter58-59
- Playback on TV (or VCR)
With *AUDIO/VIDEO IN* Jacks 60-61
- Playback on TV Without
Audio/Video Inputs62-63

Optional Accessories64-69

- Accessory Order Form67-69

Trouble Checks70-73

Care and Maintenance74-75

Specifications76

Customer Assistance and Service ...77

Limited Warranty78-79

Index (Alphabetical)80-81

First-Time Operation

This section describes only the basic steps necessary to set up your camcorder to record. Refer to the other sections for detailed operation and feature options.

Assistance

The toll-free numbers are available to help you with any problem you may encounter.

- Camcorder Exchange Warranty800-283-6503
- Customer Service800-336-1900
- Accessories800-338-0376

1. Unpack the camcorder and accessories.

- Save the packing materials and box in case you ever need to ship or store your camcorder.
- The items shown below are packed with your camcorder. If any are missing or appear damaged, contact your dealer immediately.

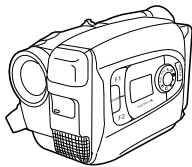

Model CC616

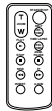

Remote Control
Part No. 221125



Rechargeable 6-Volt Battery
Part No. FB1260

**WARNING: NICKEL
CADMIUM BATTERY
MUST BE DISPOSED
OF PROPERLY.**

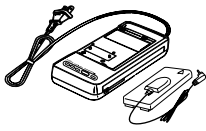

AC Adapter/Charger
Part No. 221339 or 217010

Caution:
Do not use this adapter/charger for any purpose other than charging the FB1260 or FB120 battery pack or supplying power to the camcorder.

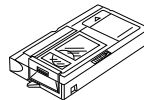

Cassette Adapter
Part No. 221338
or VCA115A



Cassette Adapter
Battery
(Size "AA" 1.5 Volt)



Shoulder Strap
Part No. ACS091

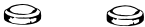

Clock and Remote Cells
3-Volt Micro Lithium Cells
– such as CR2025 – are available from most local drug stores and camera shops. Use of other cells present a risk of fire or explosion.

Cautions: Lithium cell batteries. Must be disposed of properly. Never handle punctured or leaking cells. May cause burns or personal injury. Keep out of the hands of children. Can cause death or injury if swallowed. If swallowed, consult a physician immediately for emergency treatment. The lithium cells used in these devices may explode resulting in a fire or chemical burn if mistreated. Do not recharge, disassemble, heat above 212°F (100°C), or incinerate.
Never use metallic tweezers to hold the cell, and never short circuit the + and – sides of the cell.

First-Time Operation

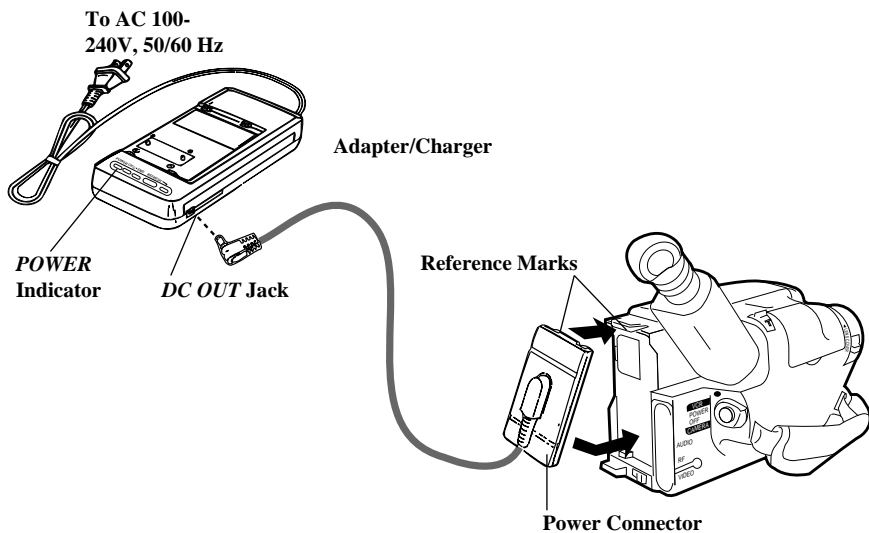

2. Attach the adapter/charger.

Since the battery must be charged before it can be used the first time, attach the adapter/charger to the camcorder.

- Connect the power connector's small plug into the *DC OUT* jack on the adapter/charger.
- Align the reference mark on the power connector with the mark on the camcorder. Hold the top of the power connector flush against the back of the camcorder, and press the bottom of the power connector down until it locks into place.

- Plug the adapter/charger's plug into an operating outlet. The adapter/charger's *POWER* indicator will light.

3. Insert a tape.

- Slide *EJECT*.
- Turn the tape wheel on the cassette to remove any slack from the tape.
- Insert the cassette with the tape wheel facing up and the tape window facing out.
- Press on the area labeled *PUSH* until the cassette door locks into place.

(continued on next page)

First-Time Operation

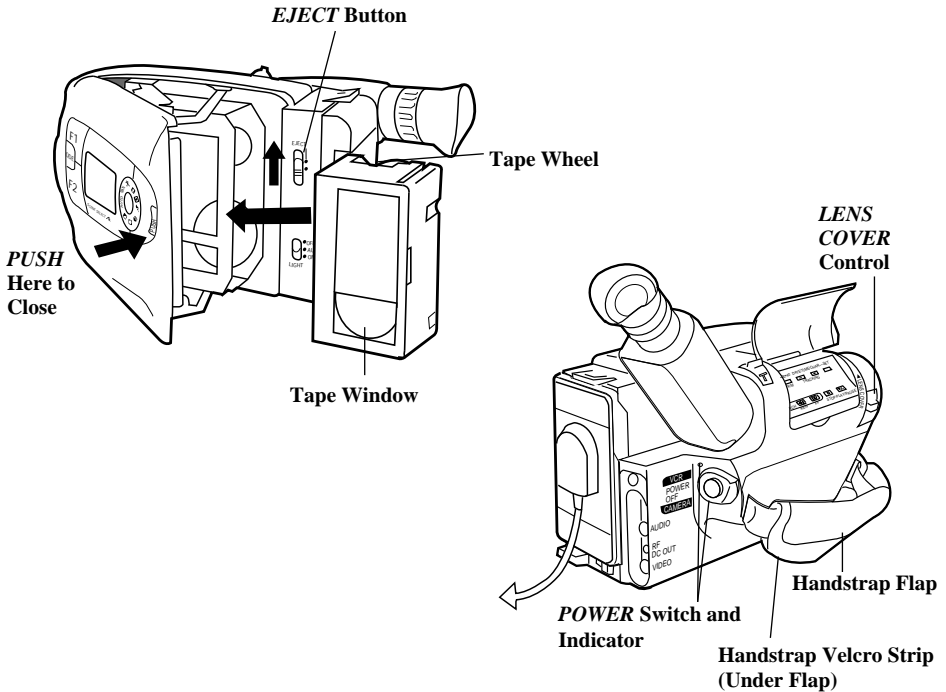

4. Slide **LENS COVER** control to open lens cover.

5. Adjust the handstrap to fit your hand.

- Lift the flap on the handstrap and separate the velcro strip.
- Insert your hand, adjust the strap to fit snugly, and refasten the strap.

6. Place **POWER (CAMERA/OFF/VCR)** switch in **CAMERA**.

- The power indicator will light and the camcorder will enter record pause. \equiv PAUSE \equiv appears in the viewfinder when the camcorder is in record pause.
- The position of this switch tells the camcorder whether you want to record (**CAMERA**), turn the power off (**OFF**), or play back tapes (**VCR**).
- The camcorder will automatically turn off if it remains in record pause for five minutes. Place **POWER** in **OFF** and then back in **CAMERA**.

First-Time Operation

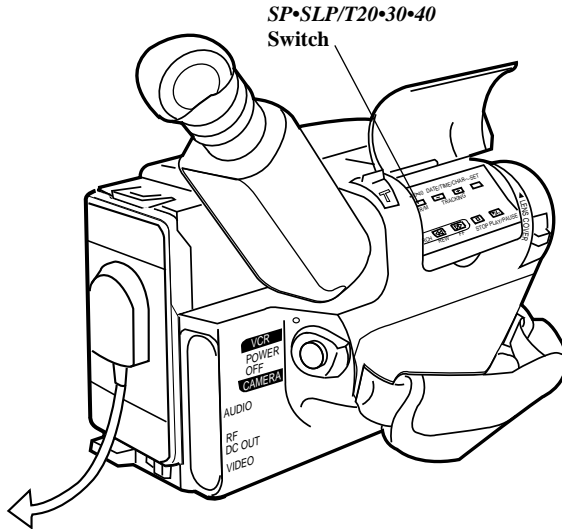

7. Select a recording speed and tape length using *SP•SLP/T20•30•40* switch.

Select SP or SLP recording speed.

- SP – Standard play provides the best picture, but the shortest recording time (20 minutes with a TC-20 tape).
- SLP – Extended play provides three times the recording time as SP (60 minutes with a TC-20 tape). SLP has slightly more picture noise in normal playback.

Set the length of the tape you are using so the camcorder can correctly calculate the recording time remaining on the tape.

Repeatedly press the *SP•SLP/T20•30•40* switch.

- Select *T20 SP* if you are using a tape with 20 minutes or less recording time and want to record in SP speed.

- Select *T20 SLP* if you are using a tape with 20 minutes or less recording time and want to record in SLP speed.
- Select *T30 SP* if you are using a tape with 30 minutes recording time and want to record in SP speed.
- Select *T30 SLP* if you are using a tape with 30 minutes recording time and want to record in SLP speed.
- Select *T40 SP* if you are using a tape with 40 minutes recording time and want to record in SP speed.
- Select *T40 SLP* if you are using a tape with 40 minutes recording time and want to record in SLP speed.

First-Time Operation

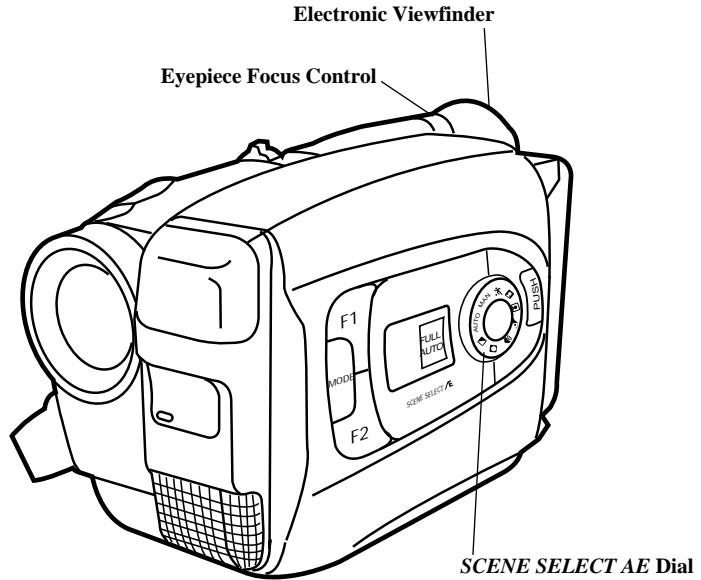

8. Set the *SCENE SELECT AE* dial to *AUTO*.

- This places the camcorder in the *AUTO* mode. *FULL AUTO* will appear in the side display panel.
- In the *AUTO* mode, the fade, 16X9, manual focus, exposure, display, and titler controls will not operate.

9. Adjust the viewfinder and eyepiece focus control.

- Rotate the viewfinder into a comfortable operating position.
- Turn the eyepiece focus control to adjust the focus of the viewfinder for your vision.

(continued on next page)

First-Time Operation

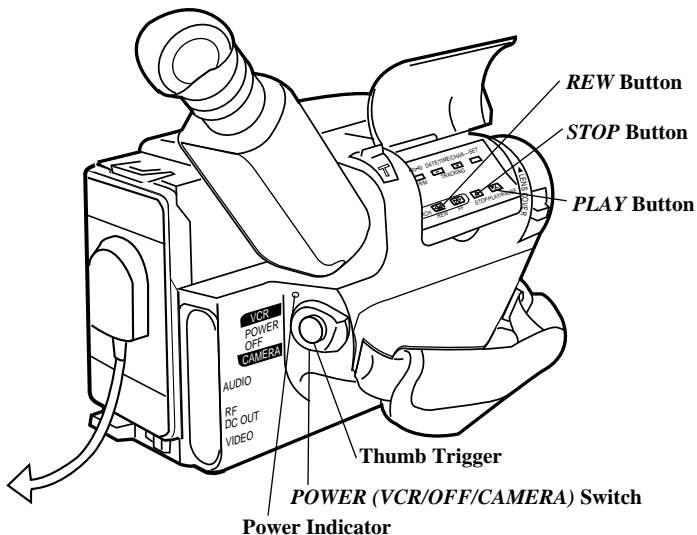

10. Start and stop recording.

- Press and release the thumb trigger to start recording. *REC 666* appears in the viewfinder, and the tally light will light when the camcorder is recording.
- Press and release the thumb trigger again to stop recording. The camcorder is now in the record-pause mode (≡ PAUSE ≡ appears in the viewfinder).

11. Play back what you have recorded.

- Place the *POWER* switch in *VCR*.
- Press *REW* to rewind the tape.
- Press *PLAY/PAUSE* to play back the tape in the viewfinder.
- Press *STOP* when you are finished playing back the tape.
- *Details on viewfinder playback are on page 57.*

12. Place the *POWER* switch in *OFF* to turn off the camcorder.

The power indicator will turn off.

First-Time Operation

13. Review camcorder's operating controls.

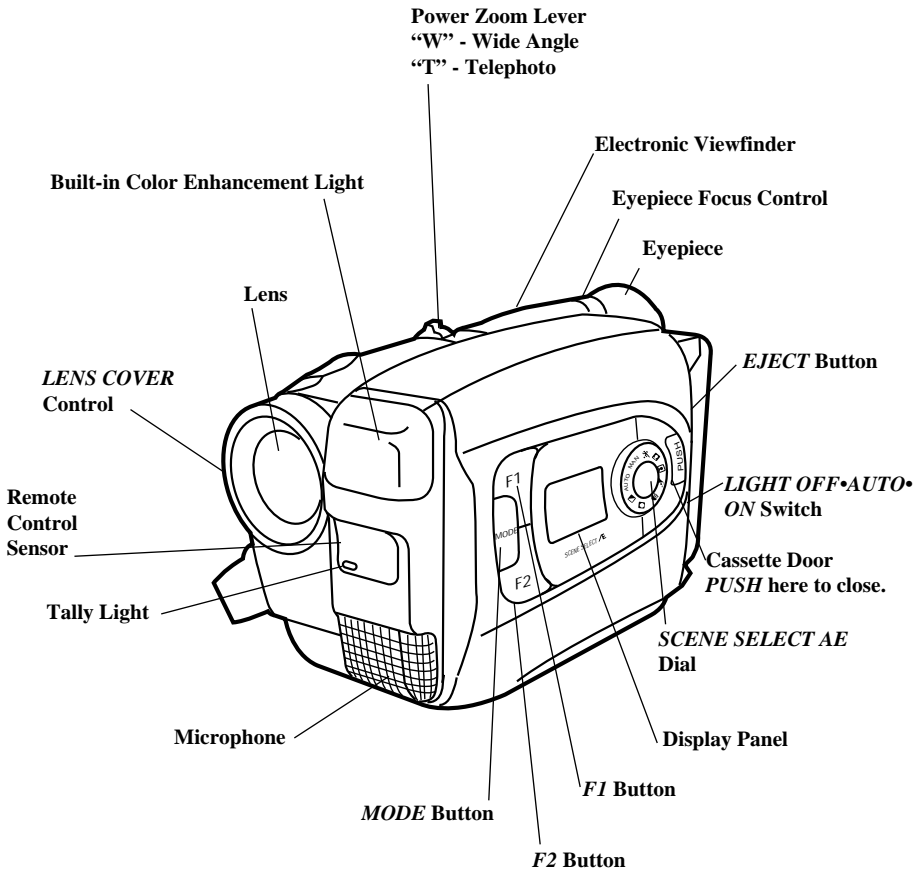

(continued on next page)

First-Time Operation

13. Review camcorder's operating controls.

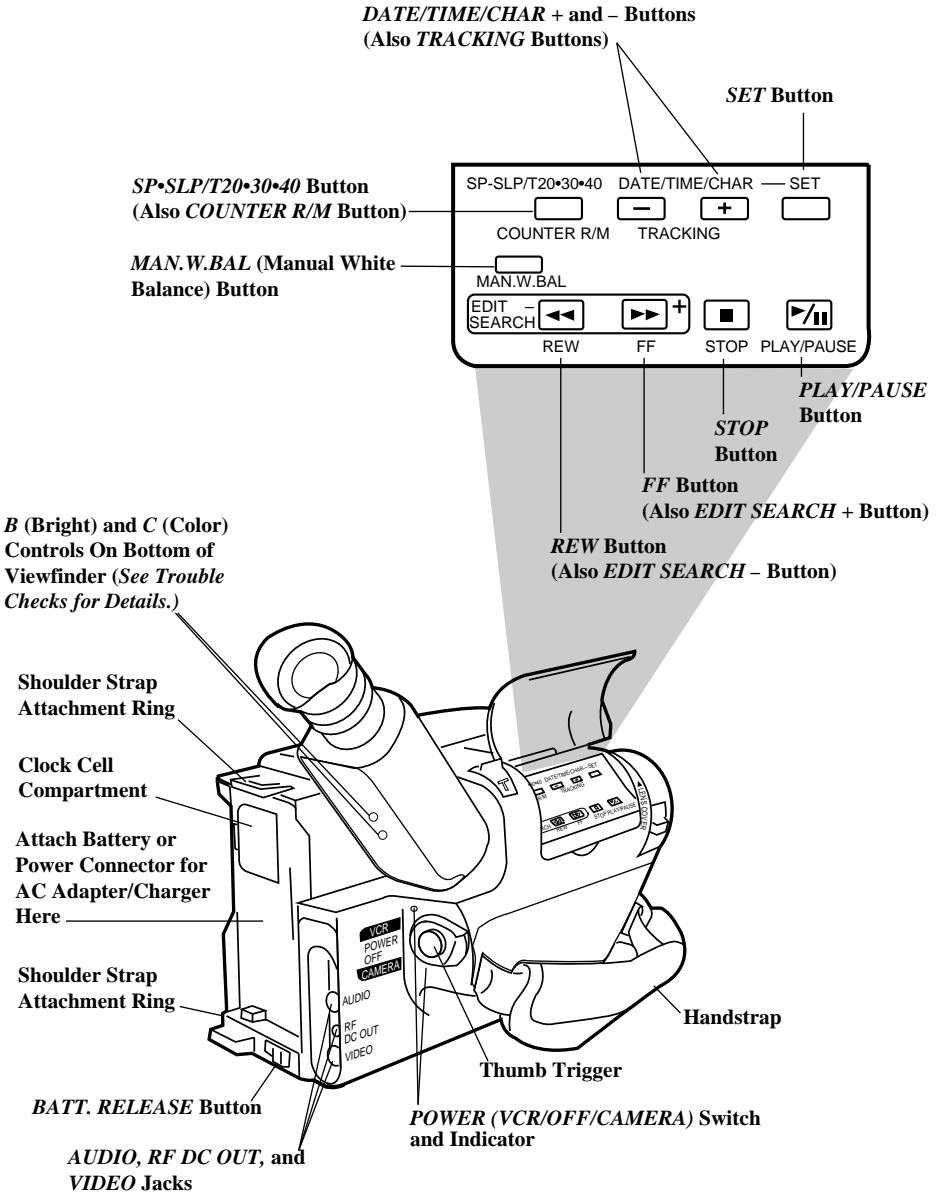

Powering Your Camcorder

Using the Adapter/Charger to Power Your Camcorder

The power connector attaches to the camcorder and lets you power your camcorder directly from standard household power. The adapter/charger operates on 100-240 volts, 50/60 Hz, so it can be used virtually anywhere in the world to power the camcorder or recharge the battery.

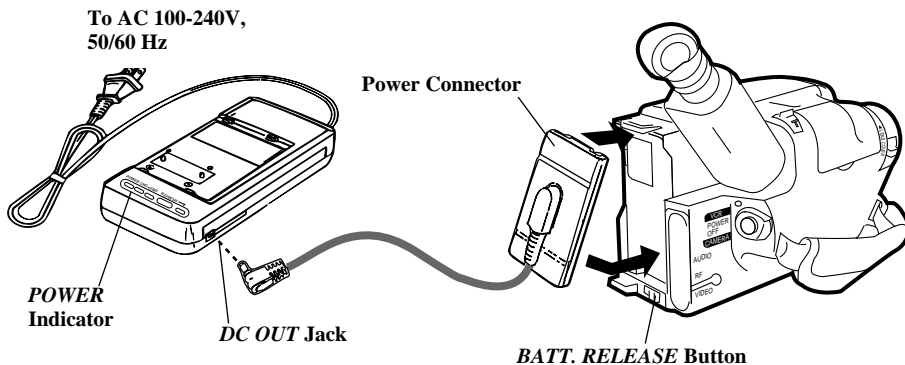

Attach Adapter/Charger

1. Plug power connector's plug into *DC OUT* jack on adapter/charger.
2. Align the reference mark on the power connector with the mark on the camcorder. Hold the top of the power connector flush against the back of the camcorder, and press the bottom of the power connector onto the camcorder until it locks into place.
3. Plug the adapter/charger's plug into the nearest AC outlet (100-240V, 50/60Hz).
4. If the adapter/charger is properly connected, its *POWER* indicator will light.

Caution: Do not use this adapter/charger for any other purpose other than charging the FB1260 or FB120 battery pack or supplying power to the camcorder.

Remove Adapter/Charger

1. Unplug the adapter/charger from the wall outlet.
2. Press and hold *BATT. RELEASE* on the camcorder while removing the power connector.

Using an Optional Plug Adapter

An optional plug adapter may be required in some countries.

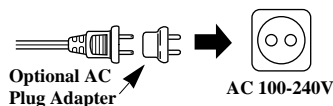

1. Plug the adapter/charger's plug into the AC plug adapter.
2. Plug the AC plug adapter into the AC outlet.

Powering Your Camcorder

Charging the Battery

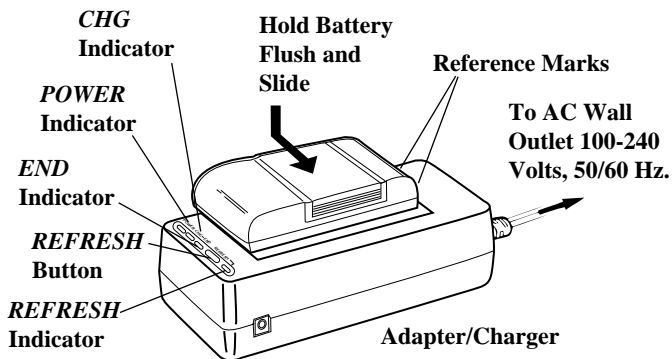

Caution

When a battery is attached to the adapter/charger, do not turn them upside down. The battery may fall off and be damaged or cause injury.

To Charge the Battery

If the power connector is attached to the **DC OUT** jack on the adapter/charger, remove its plug.

1. Align reference mark on battery with mark on adapter/charger.
2. Hold the battery flush against the adapter/charger and slide it in the direction of the arrow.
3. Plug adapter/charger into nearest AC outlet (100-240V, 50/60Hz).
4. If the battery is properly connected, the adapter/charger's **CHG** (charge) indicator will light.

Note: If you try to charge a battery that has not been charged for a long period of time, it may take a few minutes for the **CHG** indicator to light.

5. After the battery is charged, the **END** indicator will light.
6. Remove the charged battery by sliding it off the adapter/charger.
7. Attach the charged battery to the camcorder.

Use the **REFRESH** Button

The battery will provide increased operation time if you “refresh” it after five chargings. The refresh feature “refreshes” the battery by completely discharging it.

1. Attach battery to adapter/charger.
2. Press **REFRESH**. The **REFRESH** indicator will light and the battery will begin discharging.
3. When discharging is completed, the **REFRESH** indicator will turn off, and the **CHG** indicator will light. The battery will then charge.
4. After the battery is charged, the **END** indicator will light. Remove the battery from the adapter/charger.

Powering Your Camcorder

Using the Battery to Power Your Camcorder

The battery must be charged *as described on the previous page* before it can be used the first time. Initial charging will take approximately 70 minutes. When fully charged, the battery should supply about 60 minutes of operating time (depending on how much you use the light, zoom, and pause). Conserve battery power by turning the camcorder off during recording breaks.

Note: The small marker switch on top of the battery is for use as a personal reminder to help you remember to recharge the battery. It has no other function.

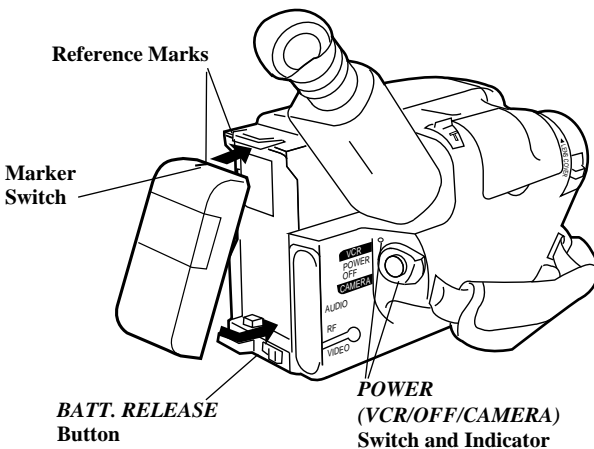

Battery Safety Precautions

Do not short the battery's terminals.

Do not attempt to disassemble or modify the battery. There are no user-serviceable parts inside.

Use the battery only with specified adapter/chargers and camcorders.

Throwing the battery into a fire or exposing to excessive heat – over 149°F (65°C) could be hazardous.

Attach the Charged Battery

If the power connector is attached to the camcorder, remove it before attaching the battery. Also, install the lithium clock cell before attaching the battery pack.

Details on page 46.

1. Align the reference mark on the battery with mark on back of camcorder.
2. Hold the top of the battery flush against the camcorder and press the bottom of

the battery down until it locks into place.

3. Place the **POWER** switch in **CAMERA**. The power indicator will light.

Remove the Battery

Press and hold **BATT. RELEASE** on the camcorder while removing the battery.

ATTENTION: NICKEL CADMIUM BATTERY MUST BE DISPOSED OF PROPERLY. THE PRODUCT THAT YOU HAVE PURCHASED USES A RECHARGEABLE BATTERY. AT THE END OF ITS USEFUL LIFE, UNDER VARIOUS STATE AND LOCAL LAWS, IT MAY BE ILLEGAL TO DISPOSE OF THIS BATTERY INTO THE MUNICIPAL WASTE STREAM. CHECK WITH YOUR LOCAL SOLID WASTE OFFICIALS FOR DETAILS IN YOUR AREA FOR RECYCLING OPTIONS OR PROPER DISPOSAL.



Ni - Cd

Powering Your Camcorder

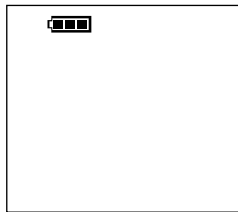

Battery Level Indicator

The battery level indicator appears in the viewfinder and shows you the amount of power in the rechargeable battery.



Battery Level Indicator
in Viewfinder

- When  appears, the battery is fully charged.

- As the power is used  and  appear.
- When the battery power is almost gone,  flashes in the viewfinder. The camcorder will turn off automatically after a few seconds. Place the *POWER* switch in *OFF* to turn off the camcorder before replacing the battery.

The battery level indicator will not be recorded on the tape when it appears in the viewfinder.

Battery Care and Storage

- Recharging takes approximately 70 minutes depending on the battery's condition.
- Refreshing takes approximately 210 minutes depending on the battery's condition.
- After repeated charging and use, operation time will gradually decrease. When operation time becomes too short to be useful, it is time to replace the battery.
- If the battery discharging must be stopped in the middle, remove the battery from the adapter/charger before unplugging it from the AC outlet.
- Let a hot battery cool down before attaching it to the adapter/charger.
- The battery will also provide better service if its power is completely drained before storing it for long periods of time (30 days or more).
- The battery should be charged in the temperature range of 50-95°F (10-35C) to prevent damage.
- Do not operate the battery at temperatures below 32°F (0C) or above 104°F (40C). The battery may be damaged if operated at temperatures above 122°F (50C). Operation time will decrease at extremely low temperatures.
- Store the battery at normal room temperature.

Powering Your Camcorder

Optional Car Cord Adapter

The optional DCC08 car cord *shown on page 64* allows you to power your camcorder from the cigarette lighter socket of a car, truck, or RV. It converts 12-volts to a 6-volt output.

Note: Consult the installation and operating instructions enclosed with the DCC08 for complete operating instructions.

Cautions: The DCC08 is designed to be used only with vehicles having negative ground electrical systems.

Use only car cord adapter DCC08 with this camcorder. Use of any other car cord adapter may damage the camcorder and void your warranty.

Using the DCC08 Car Cord Adapter

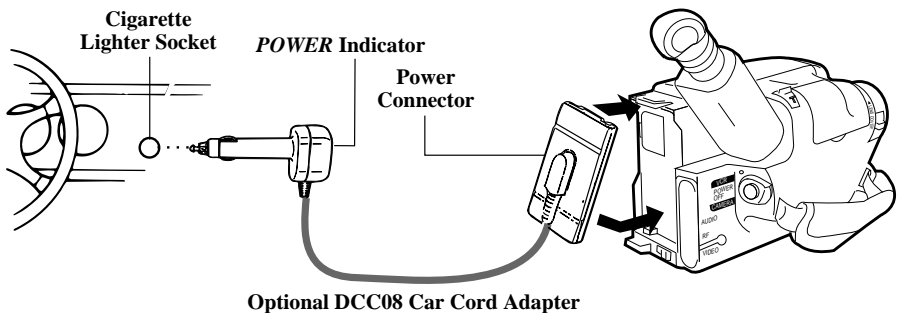

1. Place the *POWER* switch in *OFF* to turn off the camcorder. Power indicator turns off.
2. If the battery is attached to the camcorder, remove it.
3. Hold the power connector flush against the back of the camcorder and press the bottom of the power connector down until it locks into place as shown.
4. Take the vehicle's cigarette lighter out of the socket.
5. Insert the car cord's cigarette lighter plug into the vehicle's cigarette lighter socket. The *POWER* indicator on the car cord adapter will light.
6. Place the *POWER* switch in *CAMERA* to turn on the camcorder. The power indicator lights.

Caution: Make sure the camcorder's power is turned off before removing the car cord's plug from the cigarette lighter socket.

Remote Control

A brief description of the remote button's functions is given here. Many of the buttons perform the same functions as the corresponding controls on the camcorder.

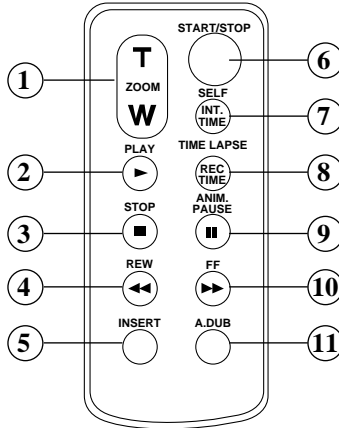

1 ZOOM (T and W) Buttons

Camcorder's *POWER* switch in *CAMERA*:

- Press *T* to move the lens in the telephoto (close-up) direction.
- Press *W* to move the lens in the wide-angle direction.

2 PLAY Button

Press *PLAY* when the camcorder's *POWER* switch is in *VCR* to begin playback.

3 STOP Button

When the camcorder's *POWER* switch is in *VCR*, press *STOP* to stop playback, rewind, or fast-forward operation.

4 REW (Rewind) Button

Camcorder's *POWER* switch in *CAMERA*:

- When the camcorder is in record pause, press and hold *REW* to visually search the tape in reverse. Release *REW* to return to record-pause.

Camcorder's *POWER* switch in *VCR*:

- When the camcorder is stopped, press *REW* to rewind the tape. Press *STOP* to stop rewinding tape.
- When a tape is playing, press and release *REW* to visually search the tape in reverse. Press *PLAY* to return to normal playback. For brief searching, press and hold *REW* for at least two seconds to visually search in reverse. Release *REW* to return to normal playback.

Remote Control

5 **INSERT Button**

Used for dubbing video. *See page 53.*

6 **START/STOP Button**

When the *POWER* switch is in *CAMERA*, press *START/STOP* to start and stop recording.

Note: If the camcorder is left in record pause for more than five minutes, power will turn off.

7 **SELF INT. (Interval)/ TIME Button**

When the *POWER* switch is in *CAMERA*, press to activate the self-timer or select an amount of interval time for interval recording.

8 **TIME LAPSE ANIM. (Animation) REC/TIME Button**

When the *POWER* switch is in *CAMERA*, press to set amount of recording time for interval and animation recording.

9 **PAUSE Button**

During playback, press *PAUSE* to produce a stop-action picture. Press *PLAY* to return to normal playback.

Caution: Pause is designed for momentary interruptions and should not be used for an extended period of time. If the camcorder remains in pause for more than five minutes, it will automatically enter the stop mode and then turn off.

10 **FF (Fast Forward) Button**

Camcorder's *POWER* switch in *CAMERA*:

- With camcorder in record pause, press and hold *FF* to visually search forward on the tape. Release *FF* to return to record pause.

Camcorder's *POWER* switch in *VCR*:

- When the camcorder is stopped, press *FF* to fast forward the tape. Press *STOP* to stop forwarding the tape.
- When a tape is playing, press and release *FF* to visually search forward on the tape. Press *PLAY* to return to normal playback. For brief searching, press and hold *FF* for at least two seconds to visually search forward. Release *FF* to return to normal playback.

11 **A. (Audio) DUB Button**

Used for dubbing audio. *See page 52.*

Remote Control

Install Lithium Cell

The remote's lithium cell is packed separately. Install it as follows:

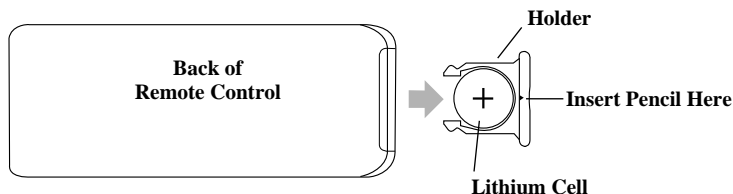

Caution: Lithium cell battery. Replace only with 3-volt lithium cell – such as CR2025. Use of other cell presents a risk of fire or explosion. Must be disposed of properly. Never handle punctured or leaking cell. May cause burns or personal injury.

Keep out of the hands of children. Can cause death or injury if swallowed. If swallowed, consult a physician immediately for emergency treatment.

The lithium cell used in this device may explode resulting in a fire or chemical burn if mistreated. Do not recharge, disassemble, heat above 212°F (100°C), or incinerate.

1. Turn remote over, insert a pencil or paper clip in small hole and remove battery holder.
2. Insert battery in battery holder so positive (+) terminal faces up.
3. Replace battery holder in remote until it clicks into place.

Notes: Never place anything heavy on top of the remote control or lay it upside-down. Replace battery when camcorder fails to respond to remote.

Remove battery from remote if it will not be used for a month or more. This will prevent possible damage from battery leakage. If leakage occurs, wipe up liquid inside compartment and replace battery.

Remote Sensor

The remote operates the camcorder by infrared light, so it is protected from electrical and sound interference. However, the remote must be aimed directly at the camcorder's remote sensor. There cannot be any obstructions between them.

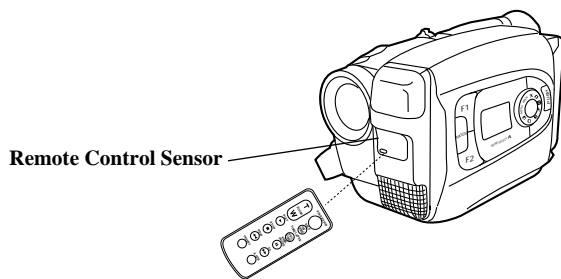

Note: The camcorder may not respond to the remote if its sensor is exposed to direct sunlight or strong artificial light.

Traveling Tips

- Write down your camcorder's serial number and keep it separate from the camcorder when traveling. If your camcorder is lost or stolen, you will be able to identify it.
- Use extra care to avoid damage to your camcorder and accessories when operating them at a beach or pool. Spray, sand, and dust should be avoided. If your lens has been exposed to the elements, clean it only with proper lens cleaning supplies.
- Make sure you have any plug adapters that you may need before taking your camcorder to other countries. Consult your dealer for advice.
- Carry your camcorder in a carrying case when traveling. *See page 64* for a case designed especially for this camcorder. An ordinary suitcase or carry bag does not offer the protection your camcorder needs. Treat your camcorder as carry-on luggage to protect it from rough handling.

Video Cassettes

We recommend that our cassettes be used with your camcorder. Use of poor quality tapes or tapes that have been damaged or mishandled can contaminate the video heads, resulting in a snowy picture or no picture at all during playback. Because there is no control over the type of tape purchased or rented by consumers, head cleaning is not covered under warranty. It is considered normal maintenance.

The automatic head-cleaning system minimizes the need for accessory cleaners or cleaning by a Servicenter. This system is activated whenever you insert or remove a cassette.

Erase Protection – Safety Tab

You can use your video cassettes over and over again. To erase a previous recording, just record over it.

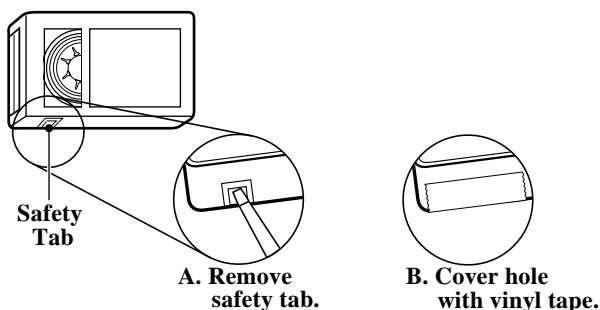

Recording and Playback Speeds and Times

The camcorder records and plays back in standard speed (SP) or extended play (SLP). Select the recording speed and tape length using the *SP•SLP/T20•30•40* switch. The selected speed and tape length will be displayed in the viewfinder. Listed below are the maximum SP and SLP recording times for popular VHS-C cassettes.

- SP – Standard play provides the best picture (less picture noise), but the shortest recording time (20 minutes with a TC-20 tape).
- SLP – Extended play provides three times the recording time as SP (60 minutes with a TC-20 tape). SLP has slightly more picture noise than SP in normal playback. This may not be noticeable.

Cassette	Recording Time	
	SP	SLP
TC-20	20 Min.	60 Min.
TC-30	30 Min.	90 Min.
TC-40*	40 Min.	120 Min.

* Will probably be available soon.

Video Cassettes

Inserting and Removing Cassettes

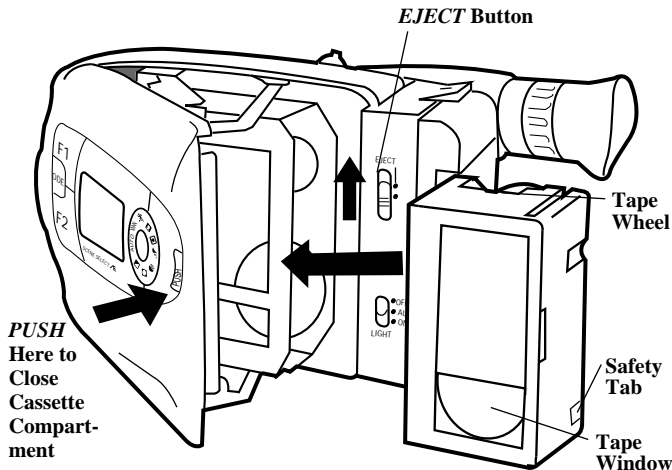

Caution:

Insert the cassette only one way with the tape wheel facing up and the tape window facing out. The cassette should slide easily into the compartment. Do not force the cassette.

Before inserting a cassette, turn the tape wheel on the side of the cassette in the direction shown to remove any slack in the tape.

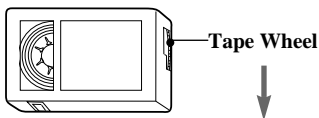

1. Attach a power supply. Then slide and release *EJECT* to open the cassette compartment.
2. Insert or remove the cassette.
3. Close the cassette compartment door by pressing on the area labeled *PUSH* until it locks into place.

Cassette Care and Storage

- When you are finished with a cassette, rewind it, remove it from the camcorder, and label it.
- Store cassettes vertically in their protective cases at normal room temperatures. Do not leave your camcorder or cassettes in a car or outdoors for an extended period. Excessive heat or cold may damage your cassettes.
- Keep the cassette away from strong magnetic fields such as electric motors and other devices.
- Keep dust from entering the cassette compartment. All dust is abrasive and will cause excessive wear on the tape and the camcorder's recording or playback heads.
- Do not use cassettes with damaged or spliced tape.
- Do not use a cassette if it has been damaged or exposed to moisture. The tape may jam and/or damage your camcorder.

Recording

Making a Recording

The steps below tell you how to make a recording and suggest using some of the recording features. Each feature is described in detail on the following pages.

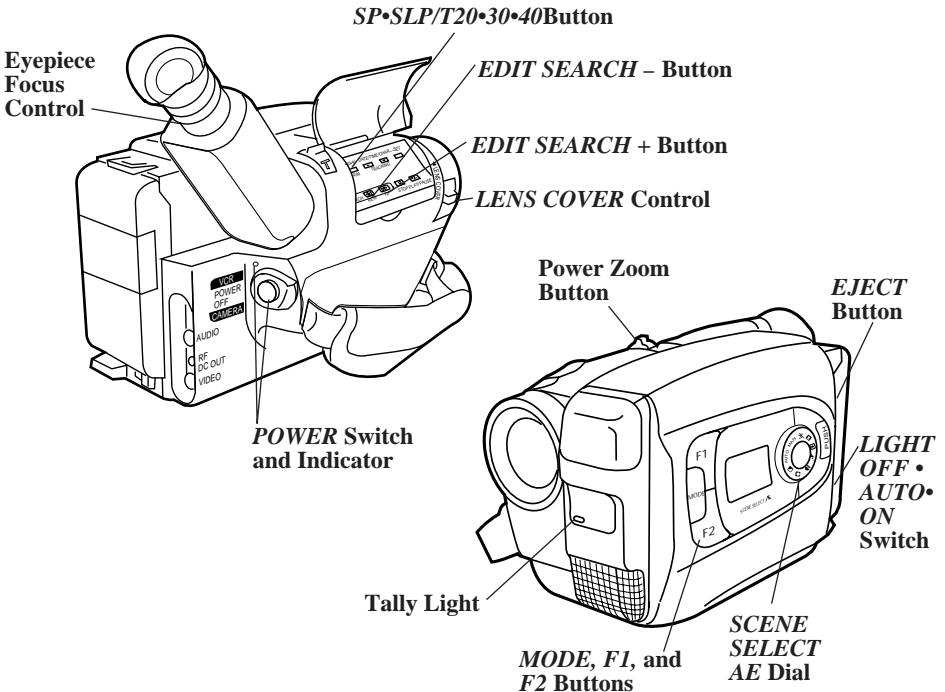

1. Attach a power supply.

Attach the adapter/charger, charged battery, or optional DC car cord.

2. Insert a tape.

- Slide *EJECT*.
- Turn the tape wheel on the cassette to remove any slack from the tape.
- Insert the cassette with the tape wheel facing up and the tape window facing out.

3. Slide the *LENS COVER* control to open the lens cover.

4. Place the *POWER (CAMERA/ OFF/VCR)* switch in *CAMERA*.

The power indicator will light and the camcorder will enter record pause.
≡ PAUSE ≡ appears in the viewfinder.

5. Adjust the viewfinder and eyepiece focus control for your vision.

6. Select a recording speed and tape length using the *SP•SLP/T20•30•40* switch.







- Select SP or SLP recording speed.
- Set the length of the tape you are using (*T20*, *T30*, or *T40*) so the camcorder can correctly calculate time remaining.

Recording

7. Place the **LIGHT OFF•AUTO•ON** switch in **AUTO**.

The light will turn on automatically when you need more light.

8. Set the **SCENE SELECT AE Dial**.

- Place the dial in **AUTO** to place the camcorder in the **AUTO** mode.
- Place the dial in () sports or () fast speed shutter to record fast moving action.
- Place the dial in () back light or () front light to compensate for unusual lighting situations.
- Place the dial in () spotlight to create the effect of the subject being in a spotlight.
- Place the dial in () portrait to create the effect of the subject being in a frame.
- Place the dial in () sepia to create the effect of an old movie.
- Place the dial in **MAN** and experiment with the **MODE** and **F1** and **F2** buttons.
 - Select **F1 FADE** to fade in and out of scenes.
 - Select **F2 16X9** to record using the 16X9 format.
 - Select **F1 FOCUS** to manually focus.
 - Select **F2 EXPOSURE** to adjust the iris (brightness).
 - Select **F1 TITLE** to select and record one of the preset titles.
 - Select **F2 DISPLAY** to display and record the date, time and date, or create and record your own title.

9. Start and stop recording.

- Press and release the thumb trigger to start recording. **REC 666** appears in the viewfinder and the tally light will light when the camcorder is recording.
- Press and release the thumb trigger again to stop recording. The camcorder is now in record pause. **≡ PAUSE ≡** appears in the viewfinder.
- The camcorder will automatically turn off if it remains in record pause for five minutes. Place the **POWER** switch in **OFF** and then back in **CAMERA**.

10. Use the zoom feature.



- Zoom in and out using the power zoom **T** and **W** lever.

11. Review what you have recorded.

- Press and release **EDIT SEARCH** – to review the last few seconds of the recording.
- Press and hold **EDIT SEARCH** – or + to visually see what you have recorded. Release the button to begin recording at that point.

Recording

Recording Tips

- In case of fire or theft, make a video recording of your home and contents to store in a safe place.
- Try to make sure indoor scenes are well-lit. Use the built-in light. This improves picture quality and color reproduction.
- Do not move the camcorder rapidly from side-to-side while recording. A steady, gradual “pan” avoids blurring and “jitter”.
- Use the viewfinder to make sure the camcorder is level while recording or your scenes will appear “tilted”.
- Do not bump or tap the camcorder’s microphone while recording because this sound will be recorded.
- Include close-ups when taping family outings or group functions.
- Fading in and out of scenes will make your videos appear more professional.
- When recording fast-moving action in outdoor light that you plan to view in stop-action or slow motion on a 3-5 head VCR, place the *SCENE SELECT AE* dial in sports () or shutter () to increase the shutter speed.
- Be aware of video and audio backgrounds. Background details barely noticed while you are taping may show up as visual “clutter” on your recording. Background noises (especially TV sets, radios, household appliances, traffic sounds, etc.) can detract from the sound you want to record.
- Avoid long “still” shots of landmarks and scenic attractions. Recordings are more interesting if they include people and details. “Local color” will give travel videos lasting appeal. Consider recording a familiar or landmark scene from an unfamiliar vantage point.

Recording

Viewfinder

The camcorder's viewfinder is a miniature monitor that displays the picture seen by the camcorder when recording.

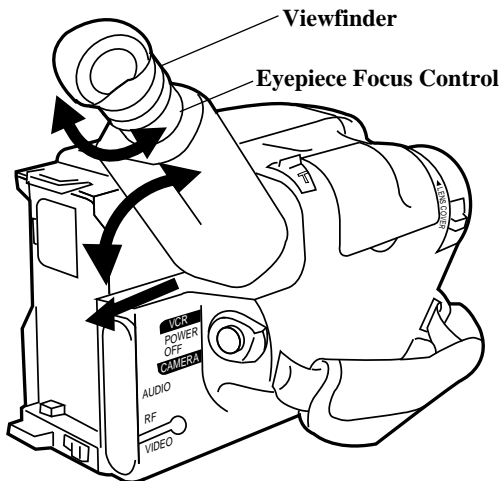

Cautions

Do not force the viewfinder to rotate completely around. This will damage the viewfinder and/or the camcorder.

When carrying the camcorder with the shoulder strap, put the viewfinder down. This helps prevent possible damage to the viewfinder from bumping against your body as you move.

Adjust Viewfinder for Convenient Viewing

For convenient viewing, you can slide the viewfinder out from the camcorder and rotate it up and down.

Eyepiece Focus Control

The eyepiece focus control lets you set the focus of the viewfinder for your personal vision. If you wear eyeglasses, you probably can operate the camcorder without them.

It is easiest to set the correct focus by focusing on one of the viewfinder's on-screen displays.

Look through the viewfinder and adjust the eyepiece focus control for your vision.

The eyepiece focus control does not affect the focus of the picture actually recorded by the camcorder.

Recording

Viewfinder Displays

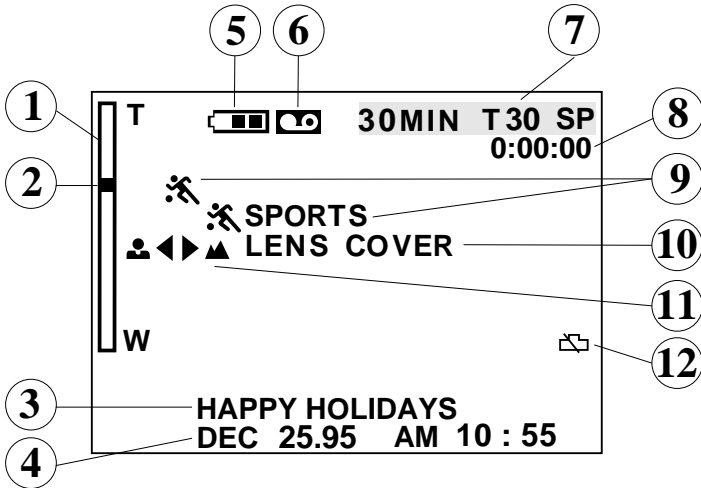

1 Zoom Level

This indicator tells you whether you are zoomed in or zoomed out.

Details are on page 34.

2 Exposure Indicator Bar

This indicator appears when you are adjusting brightness manually.

Details are on page 42.

3 Preset Title

- The preset title you select will appear in this area.
- This title will be recorded on your tape when it appears.
- *Details are on pages 44 and 48-49.*

4 Date, Date/Time, or Created Title



- The date, *AUTO DATE*, date and time, or title you created appears in this area of the viewfinder.
- These displays will be recorded on your tape when they appear.
- *Details are on pages 48-49.*

5 Battery Level Indicator

- This indicator shows how much power is left in the rechargeable battery.
- This indicator flashes when the battery is almost empty.
- *Details are on page 14.*

Recording

6 Cassette Warning

- The  indicator flashes when the *POWER* switch is set to *CAMERA* and the safety tab has been removed from the cassette.
- The  indicator also flashes when the *POWER* switch is set to *CAMERA* and there is no cassette in the camcorder.

7 Time Remaining, Tape Length and Tape Speed (SP or SLP)

Time Remaining: The approximate time remaining on the tape in the camcorder is automatically displayed. The correct tape length must be set.

- The time-remaining indicator will start flashing when the remaining tape time reaches two minutes.
- *Details are on page 33.*

Tape Length: The length of the tape in the camcorder (*T20*, *T30*, or *T40*) selected with the *SP•SLP/T20•30•40* switch appears here.

- *Details are on page 33.*

Recording Speed: The recording speed (*SP* or *SLP*) selected with the *SP•SLP/T20•30•40* switch appears here.

- *Details are on pages 20 and 33.*

8 Elapsed Time-Counter with Memory Stop

- The time counter appears during playback. It is not recorded on the tape.
- An “*M*” appears in front of the time counter when memory-stop is on.
- *Details are on page 32.*



9 Scene Select AE

- The indicator for the mode selected with the *SCENE SELECT AE* dial appears here.
- The indicator and mode both appear briefly when the mode is selected, and then only the indicator appears.
- *Details are on page 35.*

10 LENS COVER

When you turn on the camcorder, this indicator briefly flashes to remind you to open the lens cover.

11 Manual Focus

- **Manual Focus Indicators** () appear when focus is adjusted manually.
- **Manual Focus Lock Indicators** (56) appear when manual focus is locked.
- **Low-Contrast Indicators** () flash when the auto-focus system cannot focus properly.
- *Details are on pages 40-41.*

12 Lithium Cell ()

- This indicator appears when the clock cell has not been installed or it needs to be replaced.
- *Details are on page 46.*

Recording

Viewfinder Displays (continued)

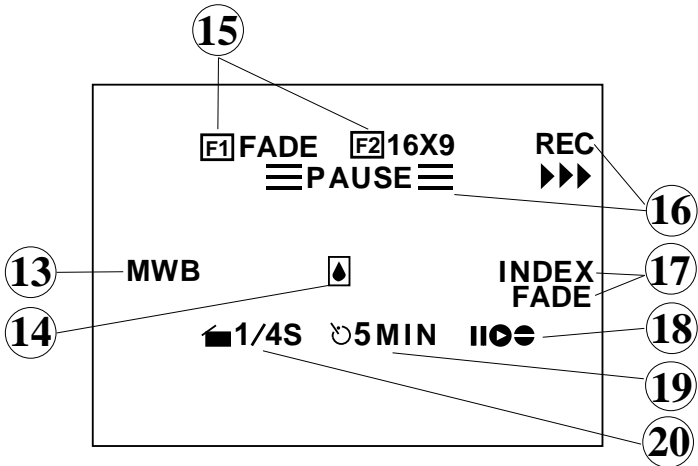

13 White Balance

- The indicator for the manual white balance selected with the *MAN.W.BAL* (manual white balance) button appears here.
- No indicator appears for automatic white balance.
- *Details are on page 36.*

14 Dew Warning ()

The dew indicator appears when excessive moisture (condensation) has entered the camcorder. The camcorder will not operate when this indicator appears. Place the camcorder in a warm, dry area until this indicator disappears. When the dew indicator disappears, the camcorder will operate.

Recording

15) **MODE Features (F1 and F2)**

- The *SCENE SELECT AE* dial may not be in *AUTO* to use these features.
- The *F1* and *F2* features selected with the *MODE* button appear here.
- *Details are on page 37.*

16) **Status Displays**

- The *REC 666* indicator appears here when the camcorder is recording.
- The \equiv PAUSE \equiv indicator appears when the camcorder is in record pause.
- *TAPE END* appears when the end of the tape is reached during recording or a cassette is inserted with its tape already at the end.

17) **INDEX and FADE**

- *INDEX* flashes when an index mark is being recorded. *Details are on page 30.*
- *FADE* appears when you press the *F1* button to select the fade feature and flashes when fade is activated. *Details are on page 38.*

18) **Edit Insert and Audio Dub**

- \ominus appears during audio dubbing. *Details are on page 52.*
- \oplus appears during edit insert. *Details are on page 53.*

- The pause indicator (\parallel) appears with \oplus or \ominus when the camcorder is paused during dubbing.

19) **Self-Timer and Interval Time**

- \odot 15S, \odot 30S, \odot 1MIN, or \odot 5MIN appears during self-timer recording. *Details are on page 43.*
- The length of time between recordings during time-lapse recording appears here. *Details are on pages 51.*

20) **Recording Time**

- The \blacktriangleleft indicator and length of time the camcorder will record during animation and time-lapse recording appears here.
- *Details are on pages 50-51.*

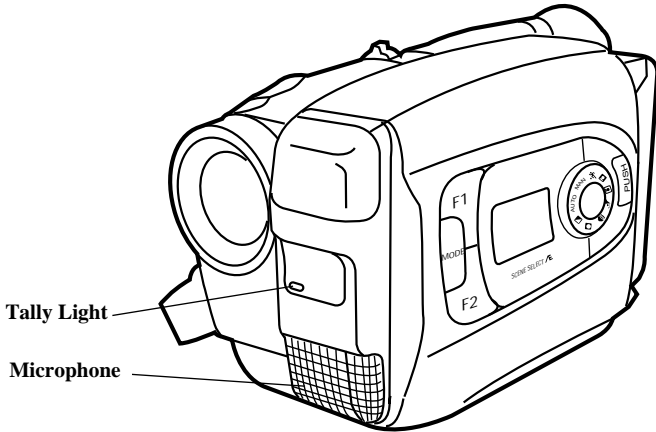

Tally Light

The tally light lights when the camcorder is recording.

Microphone

The microphone picks up the sound during a recording. It is more sensitive to sounds coming from the direction the lens is pointed.

Flying Erase Head

A separate erase head is mounted on the spinning headwheel (hence the term “flying”). This allows you to make clean edits without the “glitches” or “rainbow noise” that may occur at the beginning or the end of recordings.

Tape Positioning

Place *POWER* switch in *VCR* and press *STOP*.

- Press and quickly release *REW* or *FF* to rewind or fast-forward the tape. Press *STOP* to stop the tape.

Electronic Indexing

An index mark is automatically recorded at the beginning of a recording after the date advances and a cassette is inserted. When you play back the indexed tape in a VCR that has a compatible indexing feature called “VHS Index Search System”, the invisible marks can be located automatically. See VCR owner’s manual.

INDEX flashes in the viewfinder when an index mark is recorded.



Note: No other function can be performed during index recording.

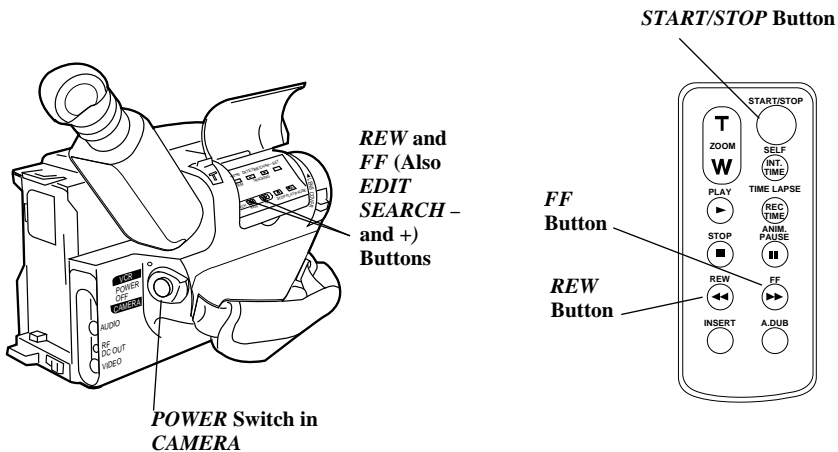

Quick Review Feature

Press and release *EDIT SEARCH -* (*REW* on remote) when the camcorder is in record pause to review the last few seconds of a recording. The *POWER* switch must be in *CAMERA*.

The camcorder will play back the last few seconds of the recording, return the tape to its previous position, and return to record pause.

Auto Head Cleaner

The camcorder has an automatic head-cleaning system. Whenever a cassette is inserted or removed, this system is activated.

The head-cleaning system minimizes the need for accessory cleaners or cleaning by a Servicenter.

Camera Edit Feature

The camera edit feature allows you to position the tape when the camcorder is in record pause. Place *POWER* switch in *CAMERA*.

- Press and hold *EDIT SEARCH -* (*REW* on remote) to visually search the recorded tape in reverse.
- Press and hold *EDIT SEARCH +* (*FF* on remote) to visually search forward on the recorded tape.

Release the button to return camcorder to record pause at that point on the tape. Press the thumb trigger (*START/ STOP* on remote) to start recording at this point.

Recording

Time Counter

The time-counter display shows the actual time elapsed when playing back a segment of a prerecorded tape. The memory-stop feature helps locate a certain point on the tape. When memory stop is on, the tape will stop automatically during rewind or fast forward when the time counter reaches *M 0:00:00*.

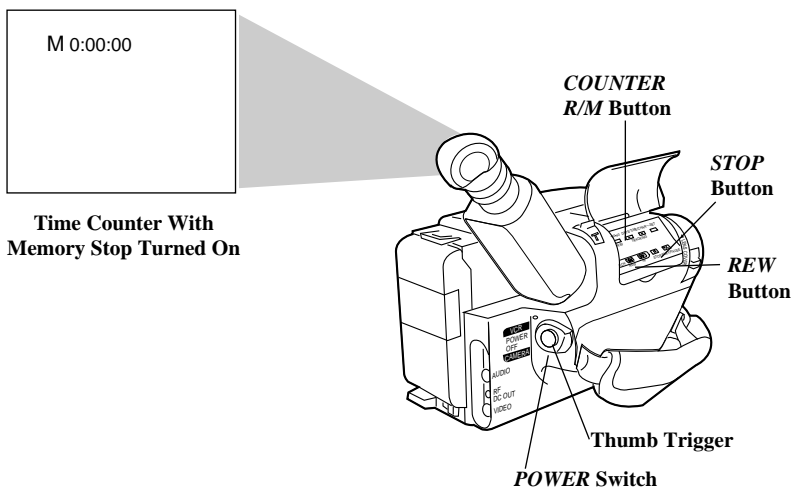

**Time Counter With
Memory Stop Turned On**

To Use the Memory-Stop Feature

1. Locate the place on the tape you want to return to, place the *POWER* switch in *VCR*, and press *COUNTER R/M* for more than two seconds to reset the counter to 0:00:00.
2. Press *COUNTER R/M* for less than one second to turn the time counter's memory-stop feature on or off. When memory stop is on, an *M* appears before the time counter in the viewfinder.
3. Continue to play the tape. When you want to return to the place you marked, press the *STOP* button.
4. Press *REW*. The tape will rewind to the time counter reading of *M 0:00:00*.

Recording

Tape Time-Remaining Display

The approximate time remaining on the tape in the camcorder is automatically displayed in the viewfinder. The *SP•SLP/T20•30•40* switch must be set for the correct recording speed and tape length before the camcorder can correctly calculate time remaining.

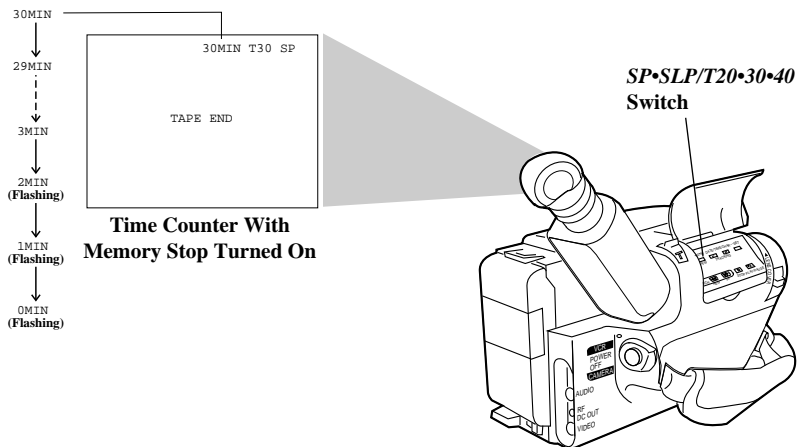

Set the Recording Speed and Tape Length

Before recording, repeatedly press the *SP•SLP/T20•30•40* switch to select the recording speed and length of tape you are using.

- Select *T20 SP* if you are using a tape with 20 minutes or less recording time and want to record in SP speed.
- Select *T20 SLP* if you are using a tape with 20 minutes or less recording time and want to record in SLP speed.
- Select *T30 SP* if you are using a tape with 30 minutes recording time and want to record in SP speed.

- Select *T30 SLP* if you are using a tape with 30 minutes recording time and want to record in SLP speed.
- Select *T40 SP* if you are using a tape with 40 minutes recording time and want to record in SP speed.
- Select *T40 SLP* if you are using a tape with 40 minutes recording time and want to record in SLP speed.

Notes: The time-remaining indicator will start flashing when the remaining tape time reaches two minutes.

TAPE END appears when the tape reaches its end during recording or a cassette is loaded whose tape is already at its end.

Recording

Zooming

The motorized zoom lens allows you to zoom in and out for close ups or wide-angle shots just by sliding the power zoom lever on the camcorder or pressing *ZOOM T* or *W* on the remote.

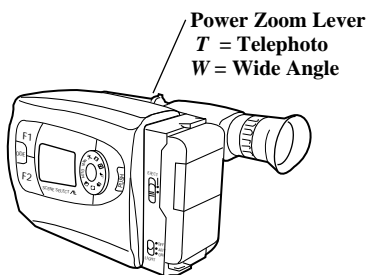

Power ZOOM Buttons
T = Telephoto
W = Wide Angle

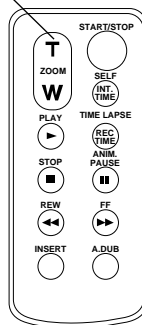

Power Zooming

- To move the lens in the telephoto (close-up) direction, slide the power zoom lever toward *T* (or press *ZOOM T* on the remote).
- To move the lens in the wide angle direction, slide the lever toward *W* (or press *ZOOM W* on remote).

Zoom speed varies according to how far you zoom in or out. The zoom level indicator appears in the viewfinder.

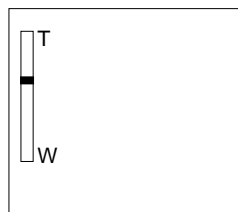

**Zoom Level Indicator
in Viewfinder**

Recording

Scene Select AE Dial

The *SCENE SELECT AE* dial lets you select one of several different effects. Turn the dial to select the effect you want. The indicator for the effect will appear in the viewfinder. Set the dial to *MAN* for normal recording.

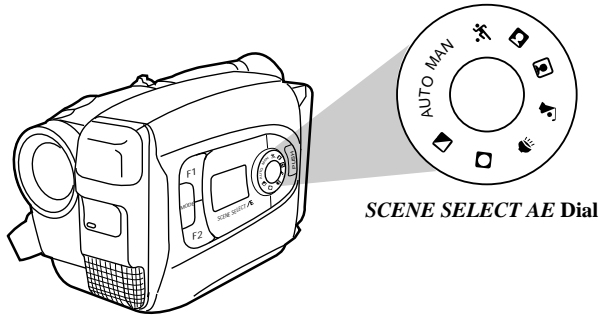

SCENE SELECT AE Dial

Mode	Indicator	Uses
<i>AUTO</i>		Places camcorder in full auto mode. <i>16X9</i> , <i>FADE</i> , <i>FOCUS</i> , <i>EXPOSURE</i> , <i>DISPLAY</i> , <i>TITLE</i> , and <i>MAN.W.BAL</i> will not operate in this mode.
<i>MAN</i>		Use this mode for normal recording.
Sports 		Use when playing back recording on a VCR featuring special effects, such as pause or slow motion. Uses high shutter speeds to clearly capture fast-moving action with less blurring.
Back-Light 		Use when the subject is in front of a window or with the sun to his back. Compensates for subject appearing too dark because of backlighting.
Front-Light 		Use when there is a strong front light on the subject such as spotlights. Compensates for subject appearing too light because of strong front lighting.
High Speed Shutter Speed 		Sets shutter speed to 1/2000. Use to record fast-moving action with less blurring. Can capture faster action than sports mode. Use outdoors and in well-lit situations when playing back recording on VCR featuring special effects, such as pause or slow motion.
Spotlight 		Use to give the effect of the subject being in a spotlight. Outer edges fade to black.
Portrait 		Gives the effect of the subject being framed. Outer edges are white while center subject remains clear.
Sepia 		Picture recorded in sepia (brownish red) that offer the vintage look of old movies. Use it with the <i>16X9</i> mode to create an authentic movie theater look. See page 39.

Recording

White Balance

Making colors look natural is what white balance is all about. This is achieved by adjusting the way the camcorder “sees” and records the light source in the scene you wish to record. Your camcorder is equipped with automatic white balance. However, under certain conditions, such as recording an object with various shades of the same color or when recording a predominant red or brown object outdoors, you may want to adjust white balance manually.

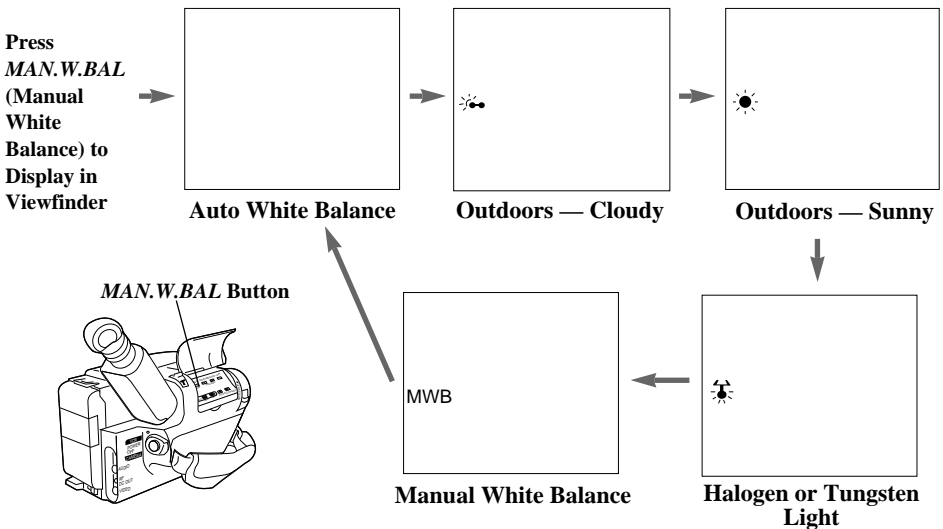

To Adjust White Balance

1. Place the **POWER** switch in **CAMERA**, and make sure the **SCENE SELECT AE** dial is not set to **AUTO**.
2. Press **MAN.W.BAL** (manual white balance) until one of the manual white balance indicators appears in the viewfinder.
 - Select ☁ when recording outdoors on a cloudy day.
 - Select ☀ when recording outdoors on a sunny day.
 - Select ⚡ when recording using halogen or tungsten lighting.
 - Select **MWB** when shooting subjects with different color temperatures and adjust the white balance as follows:

Note: It may help to connect your camcorder to a color TV monitor when making white balance adjustments.

- A. Point camcorder at a white, flat object such as a piece of paper. Adjust the focus manually.
 - B. Press and hold **MAN.W.BAL** for at least three seconds. The **MWB** indicator flashes while adjusting and stops when finished.
3. To have camcorder automatically control white balance, repeatedly press **MAN.W.BAL** until no white balance indicator appears in viewfinder (or place **SCENE SELECT AE** dial in **AUTO**).

Recording

MODE Button

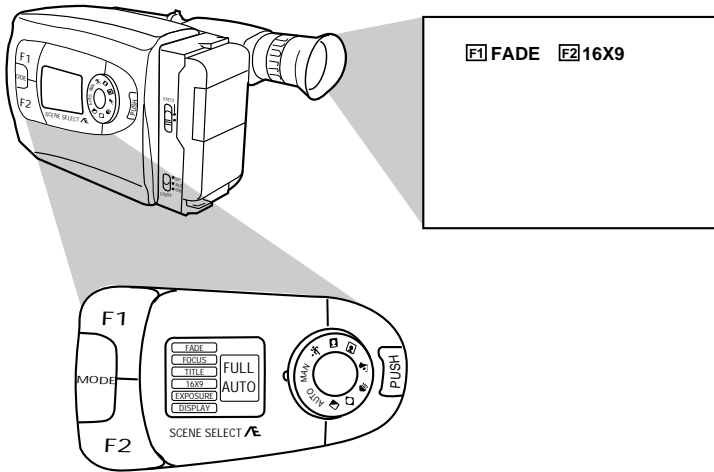

When the *SCENE SELECT AE* dial is in any position except *AUTO*, you can select any one of six functions using the *MODE*, *F1*, and *F2* buttons. Repeatedly press *MODE* to select a function. The functions selected appear in the display panel beside the *F1* and *F2* buttons and in the viewfinder:

Repeatedly Press <i>MODE</i>	Functions Selected	
	<i>F1</i> — <i>FADE</i>	<i>F2</i> — <i>16X9</i>
<i>F1</i> — <i>FOCUS</i>	<i>F2</i> — <i>EXPOSURE</i>	
<i>F1</i> — <i>TITLE</i>	<i>F2</i> — <i>DISPLAY</i>	

When the function you want to use appears, press *F1* or *F2* to select it. Each of the functions is described in detail on the following pages.

Note: *FULL AUTO* appears in the side display panel when the *SCENE SELECT AE* dial is set to *AUTO*.

Recording

Fading In and Out

You can add a professional touch to your recordings when you fade in and out of scenes. The picture will gradually appear or disappear. The speed of the fade is automatically controlled by the camcorder.

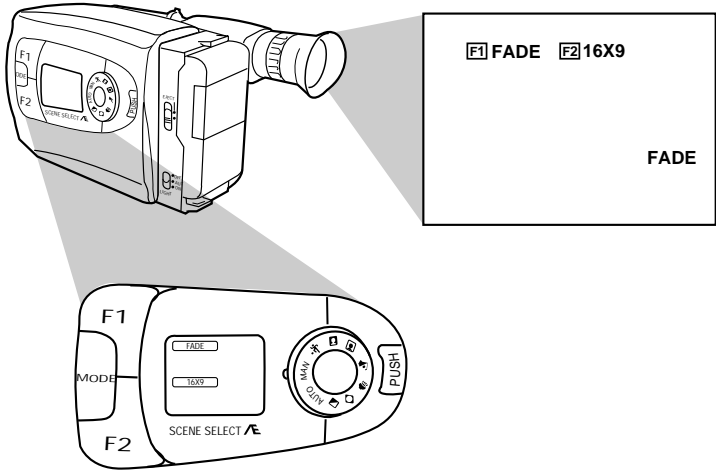

Fade In

1. Place the *POWER* switch to *CAMERA*. The power indicator will light. The camcorder will enter record pause. Center the subject or scene that you want to record in the viewfinder.
2. Make sure *SCENE SELECT AE* dial is not set to *AUTO*.
3. Press *MODE* until *FADE* appears beside the *F1* button in the display panel. **F1** *FADE* appears in the viewfinder.
4. Press *F1* to activate *FADE*. *FADE* appears in the lower right-hand corner of the viewfinder.
5. Press the thumb trigger to start recording. The screen turns blank and the camcorder will automatically fade into the scene you have selected.

Fade Out

1. Make sure *SCENE SELECT AE* dial is not set to *AUTO*.
2. Press *MODE* until *FADE* appears beside the *F1* button in the display panel. **F1** *FADE* appears in the viewfinder.
3. Press *F1* to activate *FADE*. *FADE* appears in the lower right-hand corner of the viewfinder.
4. Press the thumb trigger to stop recording. The camcorder will automatically fade out of the scene and enter record pause.

Note: When the *SCENE SELECT AE* dial is set to *AUTO*, *FADE* will not operate.

Recording

16X9 Mode

The camcorder has a 16X9 recording mode that lets you make recordings compatible with the 16X9 format. When 16X9 is activated, the camcorder records black bars at the top and bottom of the picture to produce the wide-screen effect. This is also known as “letter box” recording.

To Record Using the 16X9 Mode

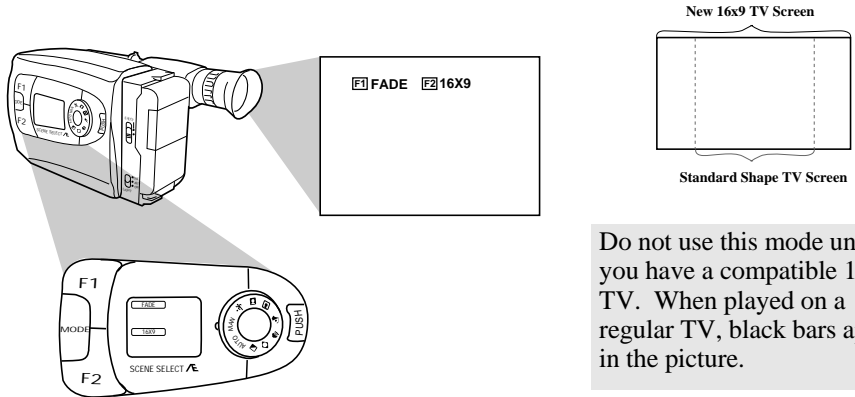

1. Place the *POWER* switch to *CAMERA*. The power indicator will light and the camcorder will enter record pause.
2. Make sure *SCENE SELECT AE* dial is not set to *AUTO*.
3. Press *MODE* until *16X9* appears beside the *F2* button in the display panel. **F2** *16X9* appears in the viewfinder.
4. Press *F2* to activate the *16X9* mode. Black bars appear at the top and bottom of the picture in the viewfinder.
5. Press the *F2* button again to turn off the *16X9* mode.

Note: When the *SCENE SELECT AE* dial is set to *AUTO*, the *16X9* mode will not operate.

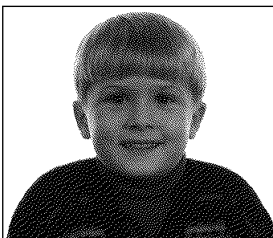

Normal Mode

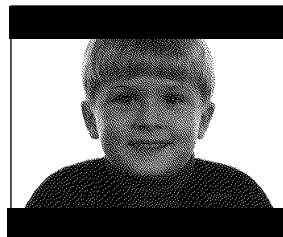

16X9 Mode

Recording

Focusing the Camcorder

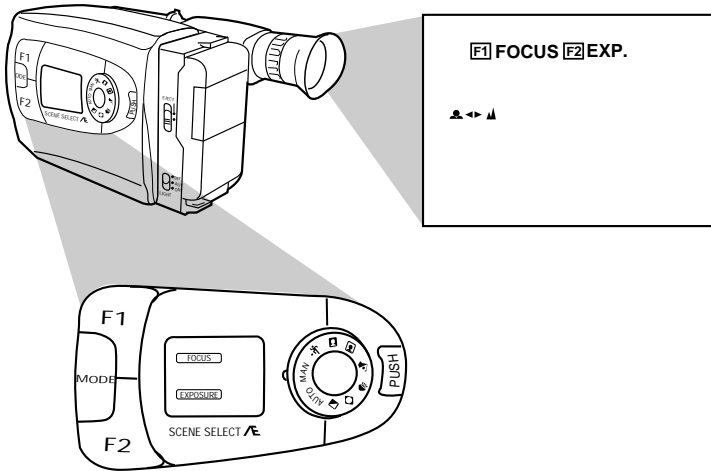

Auto Focus

During auto focus the camcorder will focus automatically on the object located in the center area of the viewfinder.

- Place the *SCENE SELECT AE* dial in *AUTO* to turn on the auto focus feature. *FULL AUTO* appears in the display panel.

Note: The low-contrast indicator (◦◦↔◦◦) in the viewfinder indicates the auto-focus system may not operate correctly due to low illumination, low or no contrast, repeated patterns, or two subjects at different distances overlapping.

Caution: During recording pauses, light entering the camcorder will operate the auto-focus feature and consume battery power.

Focus Lock Feature

The focus lock feature is useful when objects pass between your subject and the camcorder or your main subject is not located in the center of the viewfinder.





1. Center the main object in the viewfinder.
2. Make sure the *SCENE SELECT AE* dial is not set to *AUTO*.
3. Press *MODE* until *FOCUS* appears beside the *F1* button in the display panel.
4. Press *F1* to activate focus lock. **[F1] FOCUS** and the focus lock indicators (◀▶) appear in the viewfinder.
5. Press the *F1* button again to turn on auto focus (or place *SCENE SELECT AE* dial in *AUTO*).



Manual Focus

Under certain conditions, such as those listed, you may need to focus manually.

1. Make sure the *SCENE SELECT AE* dial is not set to *AUTO*.
2. Slide the power zoom lever toward *T* to zoom in on your subject. To maintain proper focus throughout the zoom range, you must zoom in on the subject before adjusting the focus.
3. Press *MODE* until *FOCUS* appears beside the *FI* button in the display panel. **[F1]** *FOCUS* appears in the viewfinder.
4. Press and hold *FI* while sliding the power zoom lever toward *T* or *W* to display a clear picture in the center of the viewfinder focus.

For slow focusing, slide the power zoom lever a small amount. For fast focusing, slide the lever all the way up or down.

The   indicators appear in the viewfinder. The 5 or 6 indicator will flash. When the focus cannot be adjusted any farther, the  indicator will flash. When the focus cannot be adjusted any closer, the  indicator will flash.

5. Release the power zoom button to lock in the manual focus. The  indicators appear in the viewfinder.
6. To turn off manual focus, press *FI* or place the *SCENE SELECT AE* dial to *AUTO*. The  indicators disappear from the viewfinder.

Conditions Requiring Manual Focus

- When recording a subject through a window.
- When recording a subject having a close foreground and a background that is far away.
- When recording two subjects at different distances that overlap in the same scene.
- When the subject is not in the center of the viewfinder.
- When recording in low-light situations.
- When recording a scene with fast motions, like a tennis swing.

Recording

Exposure Control (Iris)

The camcorder automatically adjusts the iris to provide the best picture. Under certain conditions, you may want to brighten or darken the image manually.

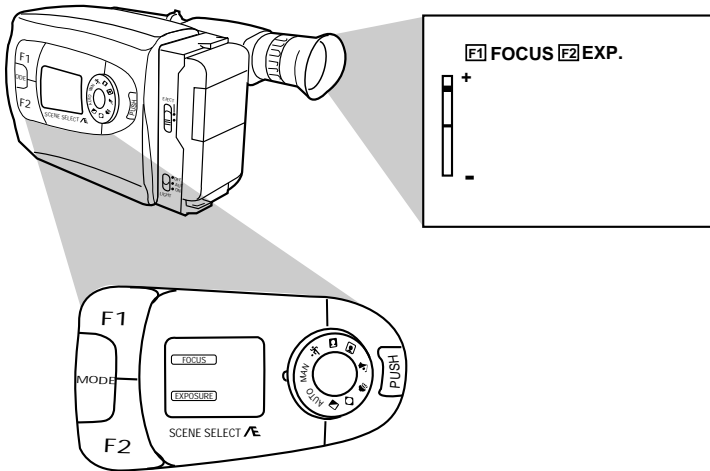

To Manually Control Brightness

1. Make sure the *SCENE SELECT AE* dial is not set to *AUTO*.
2. Press *MODE* until *EXPOSURE* appears beside the *F2* button in the display panel. **F2 EXP.** appears in the viewfinder.
3. Press and hold *F2* while sliding the power zoom lever toward *T* to brighten the image or toward *W* to darken the image.
The exposure indicator bar appears in the viewfinder.
4. To return to auto iris mode, press *F2* (or place the *SCENE SELECT AE* dial in *AUTO*).

Recording

Self Timer – Remote Only

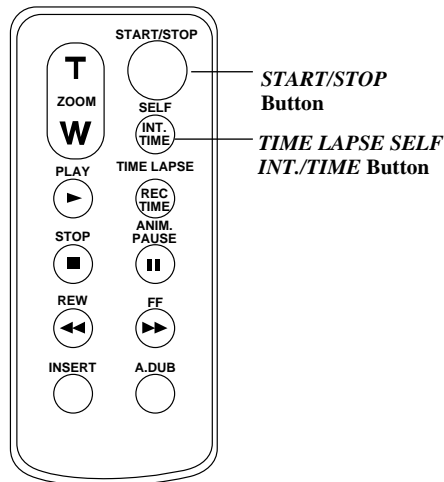

The self-timer feature delays recording to let the operator join the picture.

To Use the Self Timer

1. Place *POWER* switch in *CAMERA*.
2. Press *TIME LAPSE SELF INT./TIME* on the remote to select 15 seconds, 30 seconds, 1 minute, or 5 minutes.
⌚ 15S, ⌚ 30S, ⌚ 1MIN, or
⌚ 5MIN appears in the viewfinder.



3. Press *START/STOP* on the remote (thumb trigger on camcorder).
Recording will be delayed the amount of time you selected. The tally light flashes with the flash speed increasing five seconds before recording begins.
REC appears in viewfinder and tally light lights when recording begins.

To Turn Self Timer Off

Press *TIME LAPSE SELF INT./TIME* to remove the self-timer display from the viewfinder.

If the tally light is flashing, press *START/STOP* and then press *TIME LAPSE SELF INT./TIME*.

Recording

Titler

You can superimpose one of the eight preset titles stored in memory over the scene being recorded. You can also create your own title (up to 18 characters), store it, and record it alone or with one of the preset titles.

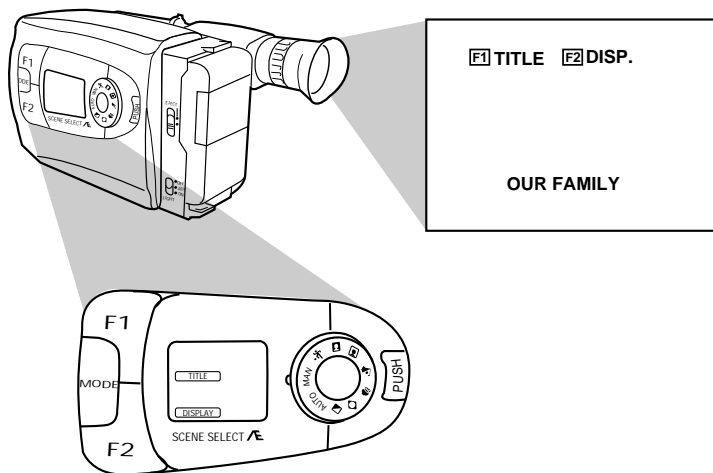

Recording a Title Stored in Memory

1. Place *POWER* switch in *CAMERA*. Power indicator will light.
2. Make sure the *SCENE SELECT AE* dial is not set to *AUTO*.
3. Press *MODE* until *TITLE* appears beside the *F1* button in the display panel. **[F1] TITLE** appears in the viewfinder.
4. Repeatedly press *F1* to display the title you want to record. The stored titles appear in the following order.

Title Off – No Title
HAPPY BIRTHDAY
HAPPY HOLIDAYS
CONGRATULATIONS
OUR FAMILY
SOMEONE SPECIAL

VACATION
SUPER STAR
FIRST

Title you Created
Title Off – No Title

- Note:** You can record the title you created along with one of the titles stored in memory making it possible to record a pair of identical titles.
5. Press the thumb trigger to start recording. The title will be superimposed over the scene you are recording.
 6. When you are finished recording the title(s), press *F1* to remove it from the viewfinder.

(continued on next page)

Recording

Creating Your Own Title

After you create a title you can store it and record it alone or with one of the preset titles as described on pages 48-49.

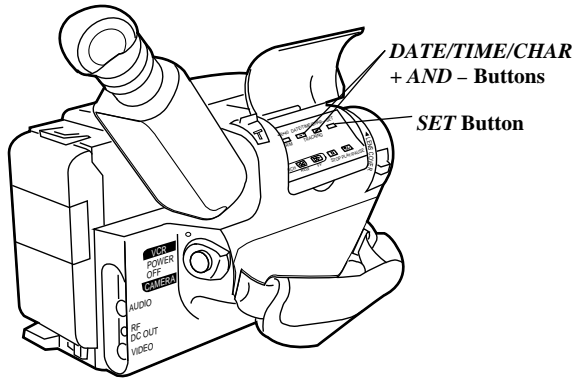

1. Place *POWER* switch in *CAMERA*. Power indicator will light.
2. Make sure the *SCENE SELECT AE* dial is not set to *AUTO*.
3. Press *MODE* until *DISPLAY* appears beside the *F2* button in the display panel. **F2** *DISP.* appears in the viewfinder.
4. Repeatedly press *F2* to display *SET CHAR* (or a title you have previously stored) in the viewfinder.
5. Press *SET*. The *CHARACTER SET MODE* menu appears with a flashing cursor.
6. Repeatedly press *DATE/TIME/CHAR* + or – until the first character for your title is flashing.
Notes: To leave a blank space, select the blank space in front of “A.” Press and hold the button to rapidly advance the flashing cursor.
7. Press *SET* to select the character.
8. Repeat steps 6 and 7 until you have selected up to 18 characters for a title.

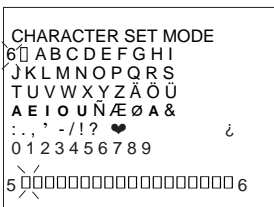
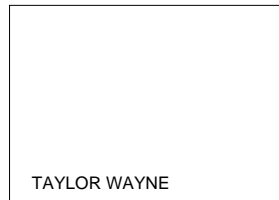

9. Repeatedly press *SET* to store the title and remove the *CHARACTER SET MODE* menu from the viewfinder.
Notes: Only one title can be stored. To create a new title, store it over the old one. To erase a character or title, select the blank space in front of the “A” for each character you want to erase. The clock battery must be installed to store a title in memory.

Recording

Install the Clock Lithium Cell

The clock cell indicator  will appear in the viewfinder when the cell has not been installed or needs to be replaced. The cell should last approximately one year.

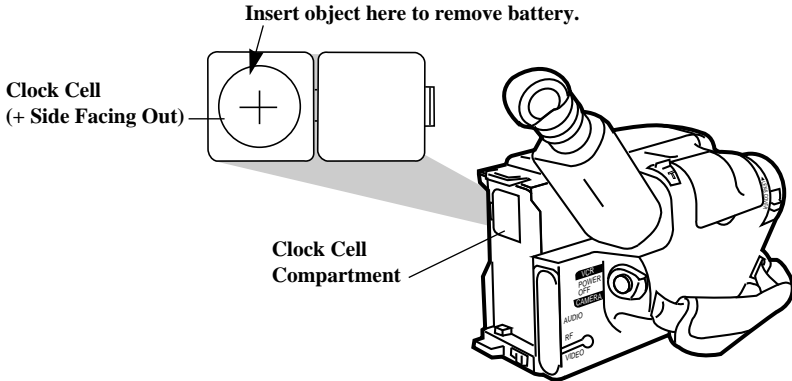

1. Make sure camcorder is turned off, and remove any power supply attached to the camcorder.
2. Press release tab of clock cell compartment cover and open the compartment.
3. Insert the clock cell with the “+” terminal facing out.
4. Close the compartment cover. It will click into place.

To remove battery

To remove battery, insert a pointed non-metallic object between battery and compartment and lift.

Cautions: Lithium cell battery. Replace only with 3-volt lithium cell – such as CR2025. Use of other cell presents a risk of fire or explosion. Must be disposed of properly. Never handle punctured or leaking cell. May cause burns or personal injury.

Keep out of the hands of children. Can cause death or injury if swallowed. If swallowed, consult a physician immediately for emergency treatment.

The lithium cell used in this device may explode resulting in a fire or chemical burn if mistreated. Do not recharge, disassemble, heat above 212°F (100°C), or incinerate.

Never use metallic tweezers to hold the cell, and never short circuit the + and – sides of the cell.

Recording

Set the Date and Time

After the date and time have been set, they can be displayed and recorded on your tapes. The clock cell must be installed.

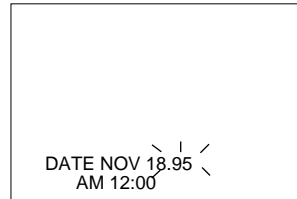
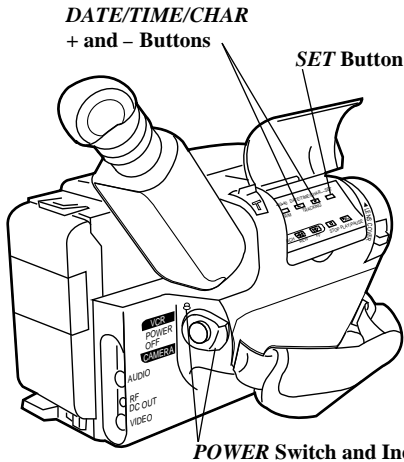

Viewfinder Display

1. Make sure the clock cell is installed.
2. Attach a power supply.
3. Place the *POWER* switch in *CAMERA*. The power indicator will light.
4. Press the *SET* button. The date and time display appear with a flashing cursor on the month. The flashing cursor lets you know which part of the display you are setting.
5. Repeatedly press *DATE/TIME/CHAR* + or - until the correct month appears.
Note: Press and hold the button to rapidly advance the digits.
6. Press *SET* to move flashing cursor to the next part of the display.
Note: Press and hold the button to rapidly advance the flashing cursor.
7. Repeat steps 5 and 6 until you have entered the correct month, day, year, hour (including *AM* or *PM*), and minutes.
8. Press *SET* to remove the flashing cursor and start the clock.
Note: The clock begins when the minute digits stop flashing. The clock does not keep time while any digits are flashing.

To Correct the Displays

Press *SET* to display the time and date and select the item you want to change. Use *DATE/TIME/CHAR* + or - to enter the correct digit(s).

Repeatedly press *SET* to remove the flashing cursor and start the clock.

Recording

Select the Date, Time, or Title You Want to Record on Your Tape

The clock cell must be installed, and the date and time set before they can be selected and recorded. When the *SCENE SELECT AE* dial is in *AUTO*, the auto date mode is automatically selected.

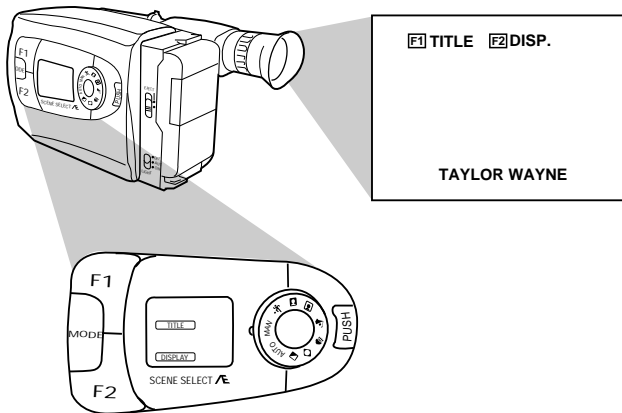

1. Attach a power supply and place *POWER* switch in *CAMERA*. The power indicator will light.
2. Make sure the *SCENE SELECT AE* dial is not set to *AUTO*.
3. Press *MODE* until *DISPLAY* appears beside the *F2* button in the display panel. **[F2] DISP.** appears in the viewfinder.
 - **Date/Time Display:** The date and time will be displayed and recorded.
 - **TV On-Screen Display:** The viewfinder displays will appear on the screen of a TV connected to the camcorder during record pause. In this mode the date will be displayed and recorded.
Note: This mode is not available during recording.
4. Repeatedly press *F2* to select the date, time, or title you want to record.
 - **Date Display:** The date will be displayed and recorded.
 - **Auto Date:** The date will be automatically recorded for approximately five seconds.
 - **Date Off:** No date or time will be displayed or recorded.
 - **Title Display:** The title you created will be displayed and recorded.
Note: If no title has been created, *SET CHAR* appears and a title can be created. *Details are on page 45.*

Recording

Date and Time Displays

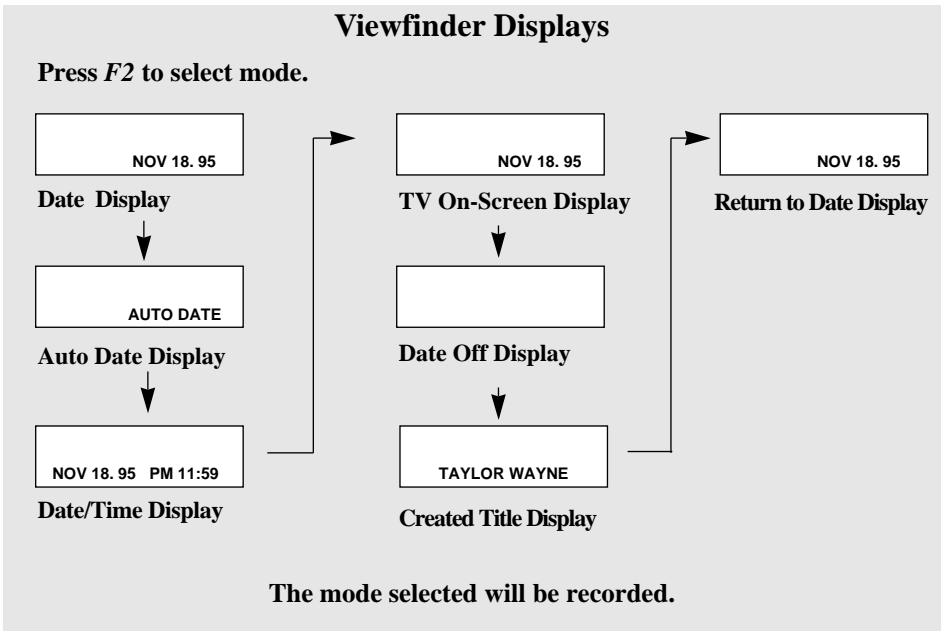

To Record the Date, Time, or Title Display on Your Tape

1. Place the camcorder in record pause.
2. Place *SCENE SELECT AE* in *MAN*.
Note: Whenever the *SCENE SELECT AE* dial is in *AUTO*, *AUTO DATE* is automatically selected.
3. Press *MODE* until *DISPLAY* appears beside the *F2* button in the display panel.
4. Repeatedly press *F2* to display the date, time or title you have previously stored in the viewfinder.
If you select *AUTO DATE*, it will automatically appear, be recorded for five seconds, and then disappear whenever:
 - The date has been set or changed.
 - This display mode has just been selected.
 - The tape has been changed or the tape compartment opened.
5. Press *F2* to remove the display from the viewfinder when you are finished recording it.
6. To record the display again, place the camcorder in record pause and press *F2*.

Recording

Animation and Time-Lapse Recording — Remote Only

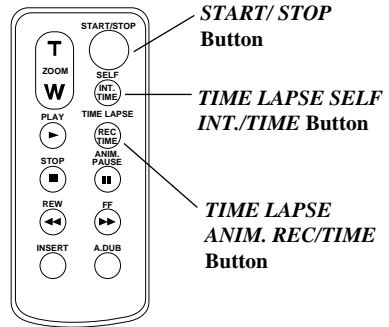
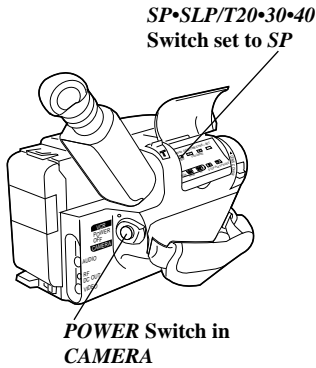

Animation Recording

Animation recording produces an illusion of movement for an otherwise stationary scene or object by shooting a series of pictures of slightly different poses (such as cartooning).

To Record Using Animation

1. Use the *SP•SLP/T20•30•40* switch to set the tape speed to *SP*.
2. Place camcorder in record pause. (*POWER* switch must be in *CAMERA*.)
3. Press *TIME LAPSE ANIM. REC/TIME* on remote to select the amount of recording time (1/4, 1/2 or 1 second).

The recording time selected will appear in the viewfinder.

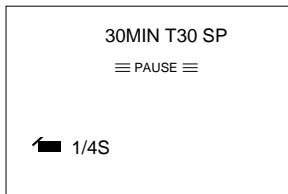

5. Press the thumb trigger (*START/STOP* on remote). Recording stops automatically after the selected amount of recording time.

You may want to take two to five shots of the subject in the same position.

6. When you are finished, press *TIME LAPSE ANIM. REC/TIME* on remote until  disappears from the viewfinder or place the *POWER* switch in *VCR*.

Notes: If you start animation recording at the very beginning of a tape, record for about five seconds so the tape runs smoothly. Using the fade feature is a good way to begin.

The fade feature will not operate during animation recording.

Use a tripod to keep the camcorder steady.

4. Focus the camcorder on the subject you want to record.

Recording

Time-Lapse Recording

Time-lapse recording makes automatic recordings at preset time intervals. The recording will show subtle changes (such as shifts in cloud formations or plant growth) when it remains focused on an object.

To Record Using Time Lapse

1. Use the *SP•SLP/T20•30•40* switch to set the tape speed to *SP*.
2. Place the *POWER* switch in *CAMERA* to put the camcorder in record pause.
3. Press *TIME LAPSE ANIM. REC/TIME* on remote to select the amount of recording time (1/4, 1/2 or 1 second).

The recording time selected appears in the viewfinder.

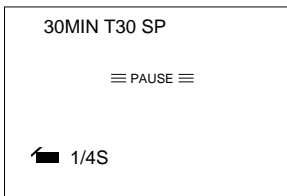

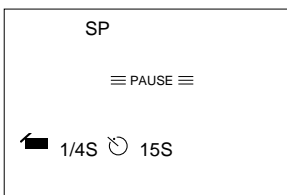

4. Press *TIME LAPSE SELF INT./TIME* on remote to select the interval time (15 seconds, 30 seconds, 1 minute or 5 minutes).

The interval time selected appears in the viewfinder.



5. Focus the camcorder on the subject you want to record.
6. Press the thumb trigger (*START/STOP* on the remote). The camcorder will start and stop recording the selected amount of time.

The tally light flashes with the flash speed increasing five seconds before recording begins.

7. When you are finished, press each *TIME LAPSE* button during record pause until  and  disappear from the viewfinder.

If the camcorder is recording, first press the thumb trigger (*START/STOP* on the remote) to stop recording.

Recording

Audio Dubbing (Remote Only)

Audio dubbing lets you record new sound (audio) in place of previously recorded audio.

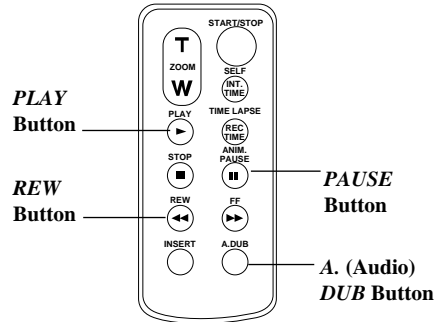
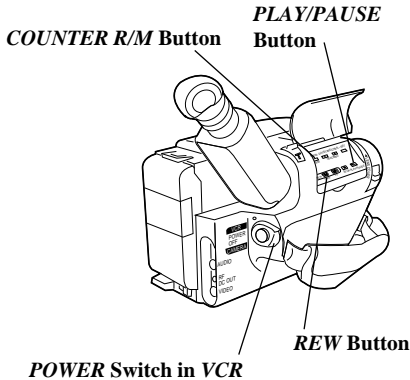

To Audio Dub

1. Place the tape with safety tab intact into the camcorder.
2. Place *POWER* switch in *VCR*.
3. Locate the place you want the audio dubbing to stop and press *PLAY/PAUSE* (*PAUSE* on remote).
4. Press *COUNTER R/M* for more than two seconds on the camcorder to set the time counter back to 0:00:00.
5. Press *COUNTER R/M* again for less than one second to turn on memory stop (*M*).
6. Press *REW*, locate the place you want audio dubbing to begin, and press *PLAY/PAUSE* (*PAUSE* on remote) exactly at the beginning of the scene.
7. Press *A.DUB* and *PAUSE* on the remote together to place the

camcorder in audio dub standby. **||** and **⦿** appear in the viewfinder.

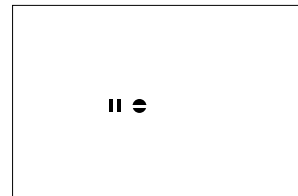

Display in Viewfinder

8. Press *PLAY* on the remote to start audio dubbing. **⦿** appears in the viewfinder. The new audio will be recorded in place of the old audio.

When the counter reading of *M* 0:00:00 is reached, audio dubbing stops and the camcorder enters playback.

Recording

Edit Insert (Remote Only)

Edit insert lets you record new video in place of previously recorded video without replacing the audio.

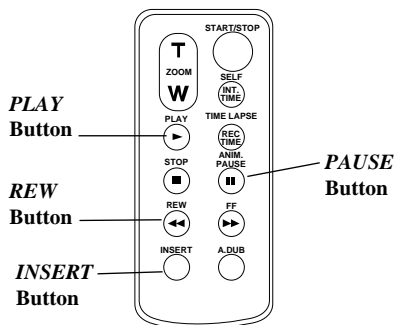
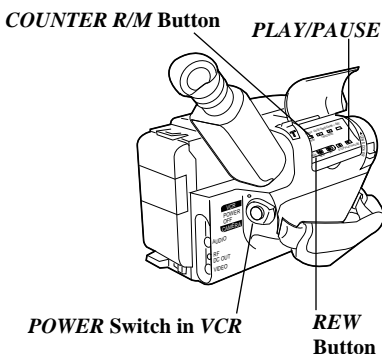

To Edit Insert

1. Place the tape with safety tab intact into the camcorder.
2. Place *POWER* switch in *VCR*.
3. Locate the place you want the edit insert to stop and press *PLAY/PAUSE* (*PAUSE* on remote).
4. Press *COUNTER R/M* for more than two seconds on the camcorder to set the time counter back to 0:00:00.
5. Press *COUNTER R/M* again for less than one second to turn on memory stop (*M*).
6. Press *REW*, locate the place you want edit insert to begin, and press *PLAY/PAUSE* (*PAUSE* on remote) exactly at the beginning of the scene.
7. Press *INSERT* and *PAUSE* on the remote together to place the camcorder in edit insert standby.

|| and ◻ appear in the viewfinder.

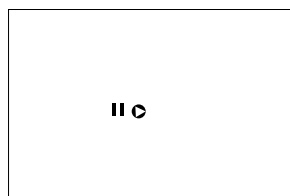

Display in Viewfinder

- Note:** To dub new audio at the same time, press *A.DUB* and *PAUSE* together. Press *INSERT* and *PAUSE* together to return to the edit-insert mode.
8. Press *START/STOP* on remote (thumb trigger on camcorder) to start edit insert. ◻ appears in the viewfinder. New video is recorded over the previous video. When the counter reading of M 0:00:00 is reached, edit insert stops and the camcorder enters playback.

Note: The camcorder may stop slightly before or after the edit out point and there may be slight distortion at this point.

Recording

Built-In Color Enhancement Light

The built-in color enhancement light will automatically add more light when needed. The *POWER* switch must be in *CAMERA* to operate the video light.

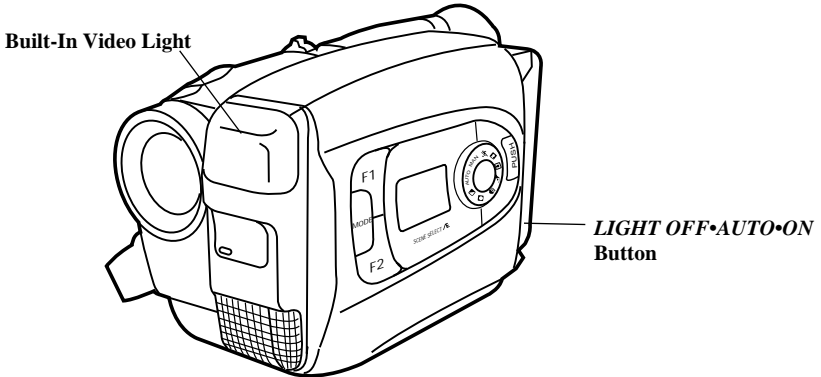

To Use the Light

Set the *LIGHT OFF•AUTO•ON* switch.

- Set to *ON* to turn the light on.
Note: We recommend you set white balance to the indoor mode () when using the light.
- Set to *AUTO* to have the light come on automatically when the camcorder senses there is insufficient light for the best recording.

Notes: If the lighting condition is unstable the light may turn on and off. Set the light to *ON* or *OFF*.

The light may stay on during high speed shutter recording.

- Set to *OFF* to turn the light off. Turn the light off when you are not recording to save battery power.

Note: When the light is turned on, the camcorder may turn off if the battery's power is low even though the battery level indicator is not flashing.

Cautions:

Do not operate the video light closer than one foot to people or other objects.

The video light becomes very hot. Do not touch it during operating or right after using it. Serious injury may result.

Do not place the camcorder in a carrying case right after using the light. Never operate the video light close to flammable or explosive material.

Recording

Replacing the Bulb

We recommend you consult your dealer when replacing the bulb. If you replace the bulb, use only halogen bulb, part #217092, and carefully follow these instructions.

Caution: The video light and bulb need to cool for approximately 30 minutes after the camcorder has been used before the light bulb is replaced.

To Replace the Bulb

1. Insert a pointed object into the lock hole.

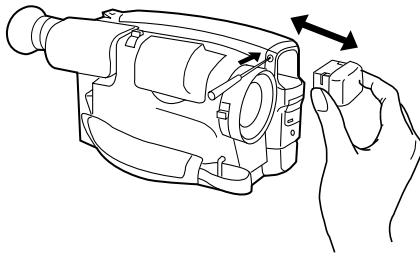

2. Pull out the video light unit.
3. Turn the bulb unit counterclockwise and pull it straight out to remove it.

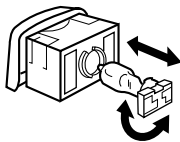

4. Use a soft cloth to hold the new bulb while you insert it. **Do not touch the bulb with your fingers.**

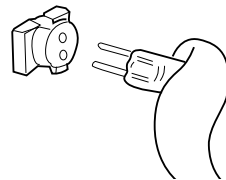

5. Replace the bulb unit.
6. Replace the video light unit.

Caution: If the bulb is accidentally touched by a finger, wipe it with a soft cloth. A dirty bulb may cause smoke and have a reduced service life.

Recording

Attaching the Shoulder Strap

The camcorder's shoulder strap is designed to let you carry the camcorder from your shoulder and – when you are ready to shoot – bring the camcorder to shooting position in one quick movement.

To Attach the Shoulder Strap

1. If the strap keeper is over a double section of the strap, slide the strap keeper off the end of the strap. Replace the keeper on the strap between the buckle and the end of the strap as shown.

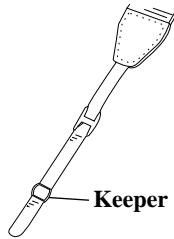

2. Loop the end of the strap over the top of the shoulder strap attachment ring.

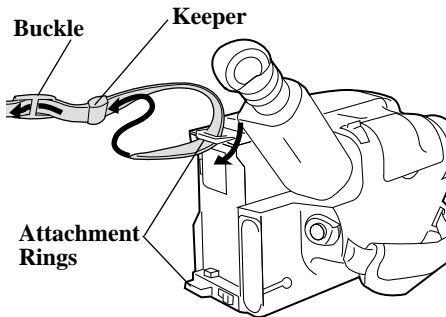

3. Thread the end of the strap back through the keeper and buckle. Make sure the strap is not twisted.

4. Attach the other end of the strap to the other shoulder strap attachment ring.

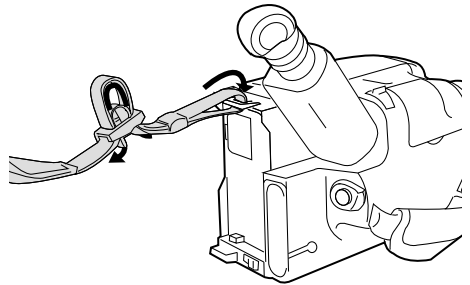

5. Adjust the shoulder strap to the desired length.
6. Slide both keepers up snugly against the shoulder strap attachment rings to prevent the strap from slipping.

Cautions: When carrying the camcorder with the shoulder strap, you may find it convenient to rotate the viewfinder down and slide it to the front. This helps prevent possible damage to the viewfinder from bumping against your body as you move.
Make sure the shoulder strap is firmly attached before using it to carry the camcorder.

Playback

Viewfinder Playback and Playback Features

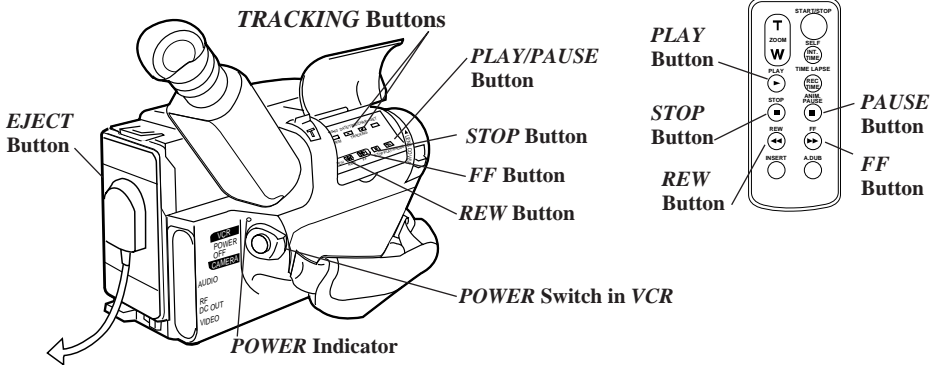

Viewfinder Playback

Viewfinder playback is the simplest way to watch tapes using the camcorder.

To Play Back a Tape

1. Place **POWER** switch in **VCR**. The power indicator will light.
2. Slide **EJECT** and insert the cassette you want to play back. Close the cassette compartment.
3. Press **PLAY/PAUSE** to begin playback. If necessary, adjust tracking. During playback, use the playback features.
4. Press **STOP** when you are finished.

Visual Searching

- During playback, press and release **FF** or **REW** if you want to search the tape visually in forward or reverse.
- Press **PLAY/PAUSE** on the camcorder (or **PLAY** on the remote) to return to normal playback.
- For brief searching, press and hold **FF** or **REW** for more than two seconds.
- Release the button to return to normal playback.

Stop-Action Pause

- During playback, press **PLAY/PAUSE** on the camcorder (or **PAUSE** on the remote) to “stop the action” and view one frame of the tape.

Caution: Pause is designed for momentary interruptions and should not be used for an extended period of time. If the camcorder remains in pause for more than five minutes, it will automatically enter the stop mode and then turn off to prevent excessive tape wear.

- Press **PLAY/PAUSE** on the camcorder (or **PLAY** on the remote) to return to normal playback.

Tracking

During playback, streaks may appear in the playback picture. Press either **TRACKING** button to move the streaks up or down and out of the picture.

- During stop-action playback, pressing one **TRACKING** button may reduce picture “jitter” (picture bouncing up and down). Some “jitter” is normal.

Simultaneously press both **TRACKING** buttons to return tracking to its preset center.

Note: The **TRACKING** buttons may have no effect on tapes recorded on other camcorders or VCRs.

Playback

Using the Cassette Adapter

The camcorder uses a smaller size cassette, but records in standard VHS format. The cassette adapter allows you to play your VHS-C cassettes in a VCR just like other standard VHS cassettes.

Insert the VHS-C cassette into the cassette adapter. Insert the cassette adapter into the VHS VCR like a normal VHS cassette.

Install Cassette Adapter's Battery

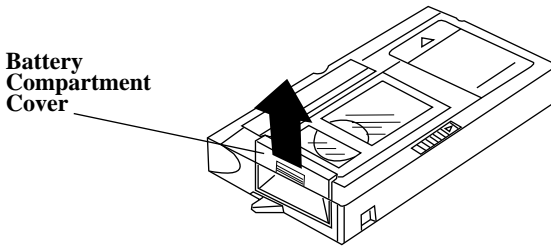

1. Remove battery compartment cover.
2. Install supplied "AA" battery so positive (+) and negative (-) ends align properly with (+) and (-) terminals in battery compartment.
3. Replace battery compartment cover.

Notes: Replace the battery when the load time becomes much longer than normal.

Remove the battery from the cassette adapter if it will not be used for a month or more. This will prevent possible damage from battery leakage. If leakage occurs, wipe up the liquid inside the compartment and replace the battery with a new one.

Insert Cassette into Cassette Adapter

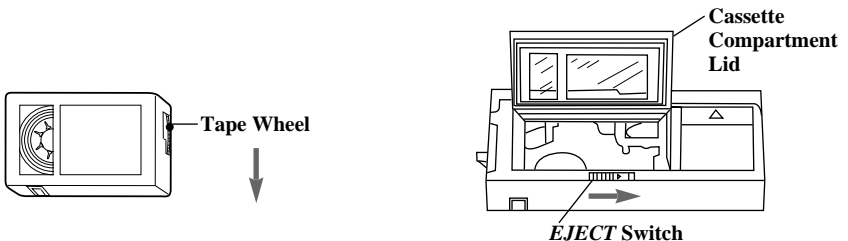

1. Before inserting the cassette into the adapter, remove any slack in the tape by turning the tape wheel on the side of the cassette.
2. Slide *EJECT* to the right to open the cassette compartment lid.

3. Insert the cassette with the tape window on the left and facing up.

Allow the cassette to drop into the adapter. **Do not force the cassette.**

(continued on next page)

Playback

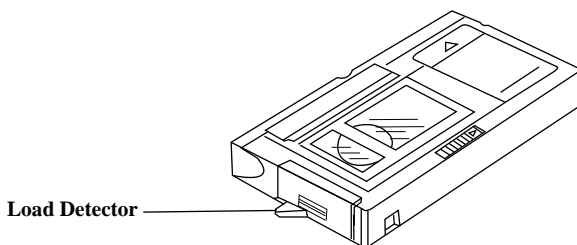

4. Gently close the cassette compartment lid until it locks into place. Make sure the cassette reel area under the adapter is free to turn while the cassette is loading.

Note: You should hear a whirring sound while the tape loads. The adapter's load detector will automatically retract into the adapter.

Caution: If the load detector is still extending from the side of the cassette adapter after you have attempted to load the cassette, loading is not complete. Try to load the cassette again. Attempting to insert the cassette adapter into a VCR with the load detector extending may cause damage to the adapter and/or VCR.

Remove Cassette from Cassette Adapter

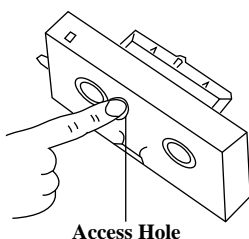

1. Slide the adapter's *EJECT* switch to the right. The load detector will extend from the side and the whirring sound indicates the tape is being released before the adapter's cassette compartment lid opens.
2. Use the access hole on the bottom of the adapter to push the cassette up and remove it from the adapter.
3. Gently close the adapter's cassette compartment lid.

Playback

Playback on TV (or VCR) with AUDIO/VIDEO IN Jacks

To connect your camcorder to a TV monitor (or VCR) with *AUDIO/VIDEO IN* jacks, you will need an optional audio/video cable such as AH075G shown on page 64.

If your TV is already connected to a VCR, you can attach the camcorder to the VCR and watch what the camcorder is recording or playing on the TV.

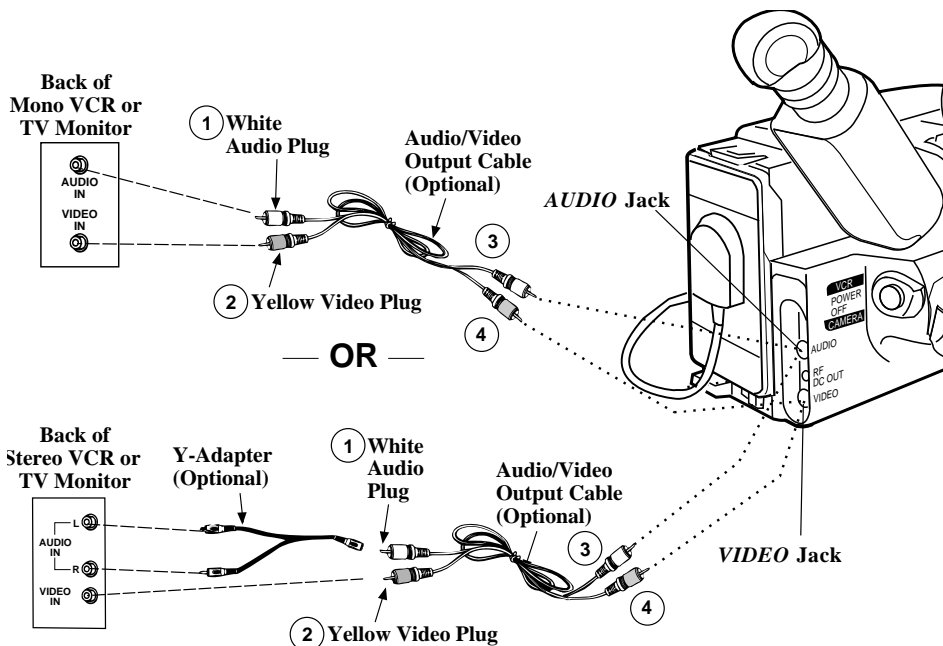

Installation

- 1 Attach the white plug on one end of the audio/video cable to the *AUDIO IN* jack on the TV (or VCR).
Notes: If your cable does not have white and yellow plugs, just be sure to attach the same color to the audio jacks.
If your TV (or VCR) has stereo *AUDIO IN* jacks, attach the plug to the one labeled *MONO*. If one is not labeled *MONO*, you may need a Y-adaptor, such as AH25, shown on page 66 to hear both channels.
- 2 Attach the yellow plug to the *VIDEO IN* jack on the TV (or VCR).
- 3 Attach the white plug on the other end of the audio/video cable to the *AUDIO* jack (located under the small cover) on the back of the camcorder.
- 4 Attach the yellow plug to the yellow *VIDEO* jack on the camcorder.

Playback

Playback Operation and How to Copy Tapes on the VCR

1. A. Camcorder connected directly to TV: Turn on the TV and tune it to the video input channel.
B. Camcorder connected to VCR that is already connected to TV: Turn on VCR and place it in the “line” or “camera mode”. (If your VCR does not have a “line” or “camera mode”, consult the VCR owner’s manual.) Operate the TV as you normally do to see the signal coming from the VCR.
2. Place the *POWER* switch in VCR to turn on the camcorder. The power indicator will light.
3. Press *PLAY/PAUSE*.
 - If noise bars appear on the screen, press *TRACKING* – or +.
4. To copy what the camcorder is playing, place a blank cassette in the VCR, and press the VCR’s *RECORD* button.
Note: Make sure the memory-stop feature is turned off (press *COUNTER R/M*) or the camcorder will enter play pause when the counter reaches *M 0:00:00*.
5. Press *STOP* when you are finished.

Caution: The unauthorized recording of copyrighted material may infringe the rights of others.

Viewing What the Camcorder is Seeing (or Recording)

1. A. Camcorder connected directly to TV: Turn on the TV, and tune it to the video input channel.
B. Camcorder connected to VCR that is already connected to TV: Turn on VCR and place it in the “line” or “camera mode”. (If your VCR does not have a “line” or “camera mode”, consult the VCR owner’s manual.) Operate the TV as you normally do to see the signal coming from the VCR.
2. Place the *POWER* switch in *CAMERA*.
Note: When the camcorder is used as a camera, turn the TV’s volume down to prevent a high-pitched squeal caused by feedback.
3. Press the thumb trigger to begin recording. You can watch what the camcorder is seeing (or recording) on the TV screen.

Notes: The remote control will operate the camcorder.

During record pause, you can use the display feature to see the camcorder’s displays on the TV screen. *Details are on pages 48-49.*

Playback

Playback on a TV Without Audio/Video Inputs

To connect your camcorder to a TV without audio/video inputs, you will need an optional 1CVA147C RF output adapter and an optional coaxial RF cable, such as AH065G or AH066G shown on page 66. If your TV has *AUDIO* and *VIDEO IN* jacks (or is connected to a VCR), refer to pages 60-61.

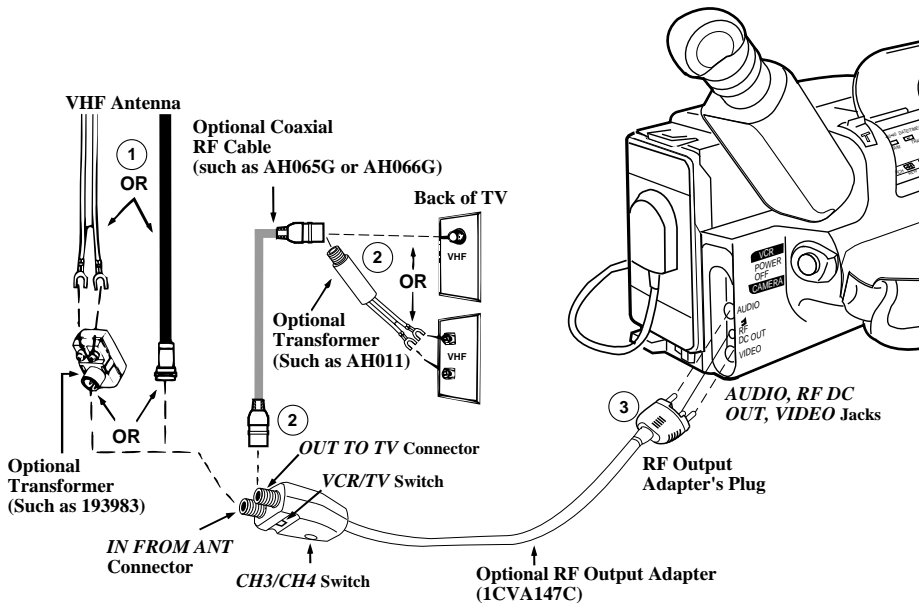

Installation

- 1 Disconnect the VHF antenna from your TV. Connect the antenna to the *IN FROM ANT* connector on the RF output adapter if you are going to leave the adapter connected to the TV.
- 2 Attach one end of the optional coaxial RF cable to the *OUT TO TV* connector on the adapter, and attach the other end to the VHF input on your TV as shown.

Note: If your VHF antenna is the flat twin-lead type attached by two screws, you will also need an optional 300/75 ohm transformer, such as 193983 shown on page 66.

Note: If your TV has 300 ohm screw terminals, you will need a 75/300 ohm transformer, such as AH011, shown on page 66.

- 3 Attach the RF output adapter's plug to the *AUDIO, RF DC OUT, and VIDEO* jacks located under the small cover on the back of the camcorder.

Playback

Playback Operation

1. Set the *CH3/CH4* switch on the RF output adapter to channel 3 or 4.
2. Turn on the TV, and tune it to the same channel you selected with the RF output adapter's *CH3/CH4* switch.
3. Place adapter's *VCR/TV* switch in *VCR*.
4. Place *POWER* in *VCR*. Power indicator will light.
5. Press *PLAY/PAUSE* on the camcorder.
 - During playback, use the playback features *described on page 57*.
 - If noise bars appear on the screen, adjust tracking *as described on page 57*.
6. Press *STOP* on the camcorder when you are finished.

Viewing What the Camcorder Is Recording

1. Turn on the TV and tune it to channel 3 or 4. When the camcorder is used as a camera, turn the TV's volume down to prevent a high-pitched squeal caused by feedback.
2. Set the *CH3/CH4* switch on the RF output adapter to the same channel you selected on the TV.
3. Place adapter's *VCR/TV* switch in *VCR*.
4. Place *POWER* in *CAMERA*. Power indicator will light.
5. Press the thumb trigger to begin recording. You can watch what the camcorder is seeing (or recording) on the TV screen.

Notes: The remote will also operate the camcorder.

During record pause, you can use the display feature to see the camcorder's displays on the TV screen. *Details are on pages 48-49.*

Normal TV Viewing

For normal TV viewing, you may leave the RF output adapter hooked up to the TV. Disconnect the adapter's plug from

the camcorder and place the adapter's *VCR/TV* switch in *TV*.

Note to Cable TV Installer

This reminder is provided to call your attention to Article 820-40 of the National Electrical Code (Section 54 of Canadian Electrical Code, Part I), that provides guidelines for proper grounding and, in particular, specifies that the cable ground shall be connected to the grounding system of the building as close to the point of cable entry as practical.

Optional Accessories

We invite you to take a look at some great ideas for sparking creativity and adding to the fun of using your compact VHS camcorder. The following pages have a selection of accessories to help make your memorable moments look and sound even better.

These accessories are designed to make the process of recording and watching your videos more enjoyable.

To order accessories, contact your local Dealer.

If a dealer is not nearby, all accessories are available through toll-free ordering or by using the order form *on page 67*.

AC025A Soft Carrying Case

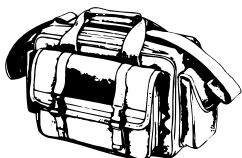

Custom compact soft case designed especially to provide protection and utility for your compact VHS camcorder and most accessories. Rugged fabric lined with soft non-abrasive material and generous padding. Has three outside pockets with storage for lens filters, adapters, batteries, and tapes.

DCC08 Car Cord Adapter

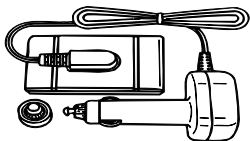

Do not use any other car cord with this camcorder.

This car cord adapter enables you to operate your camcorder from your car, truck, or RV by plugging the car cord directly into the vehicle's cigarette lighter socket. The DCC08 is designed specifically to convert power from a 12-volt battery to a 6-volt output.

VCC1000 Video Color Control Center

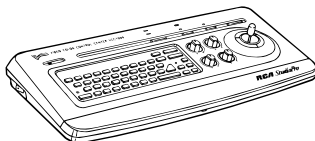

The VCC1000 is two accessories in one. The color control center allows you to adjust the color intensity, tint, white balance, and sharpness of tapes being dubbed. This is especially helpful when the original tape was produced in poor lighting conditions or poor color settings.

The second feature, the character generator, lets you create titles that can be recorded on your tapes. This lets you add a professional and/or personal touch to your home videos.

AH075G Audio/Video Cable

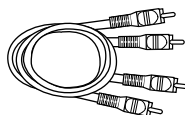

This six foot audio/video dubbing cable can be used for copying tapes from the camcorder to another VCR or camcorder.

Optional Accessories

FB1260 and FB120 Rechargeable Batteries

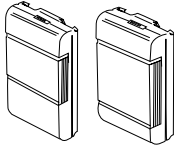

These rechargeable nickel-cadmium batteries are designed specifically for long life. The FB1260 powers your camcorder approximately 60 minutes and the FB120 approximately 130 minutes (with video light off – depending on how much you use zoom and pause). Both can be recharged with the AC adapter/charger that came with your camcorder.

CPS91 AC Battery Charger

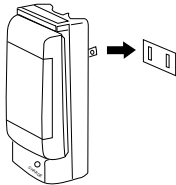

The CPS91 battery charger plugs directly into an AC outlet and charges the FB1260 and FB120 camcorder batteries. Because the CPS91 operates on 100-240 Volts, 50/60 Hz, it can be used virtually anywhere in the world. A plug adapter may be required in some countries. Charging takes approximately seven hours for the FB1260 (1-hour battery) and 13 hours for the FB120 (2-hour battery).

All specifications and descriptions of accessories are subject to change without notice.

Using the Optional AC088 Tripod

Mounting the camcorder on a tripod, such as AC088, will keep the camcorder steady and produce excellent video results.

This tripod's fluid-effect head provides smooth camera pan and tilt. The quick-release mount makes it easy to attach or remove the camcorder. The grooved, tubular 3-section leg design folds down to 26" when not in use. Rubber feet allow for sure footing.

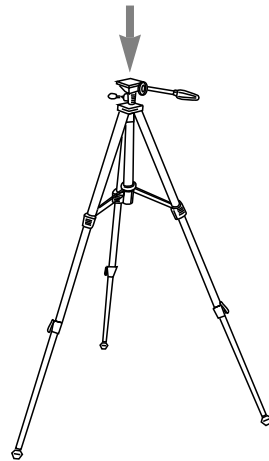
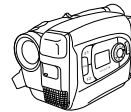

Cautions: Before using a tripod, make sure it is stable enough to hold the camcorder without falling over. Do not transport the camcorder attached to the tripod.

When attaching your camcorder to a tripod, be careful not to force the tripod screw into the camcorder's tripod mounting hole.

The tripod screw should not protrude into the camcorder more than approximately three-eighth (3/8) inch. Forcing the screw could damage the mounting hole on the bottom of the camcorder.

Optional Accessories

1CVA147C RF Output Adapter

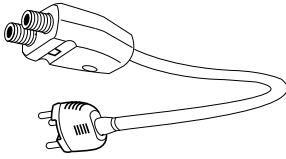

This RF output adapter is used with a coaxial RF cable, such as AH065G or AH066G, to connect your camcorder to a standard TV (one without audio/video inputs) for playback. If your antenna cable is the flat twin-lead type attached by two screws, you will also need a 300-75 ohm transformer such as 193983. If your TV has 300 ohm VHS screw terminals, you will need an optional 75-300 ohm transformer such as AH011.

Coaxial RF Cables

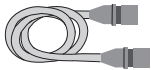

AH065G (6-ft)
AH066G (10-ft)

These RF cables are used with the RF output adapter to connect your camcorder to a standard TV (one without audio/video input jacks) for playback. If your antenna cable is the flat twin-lead type attached by two screws, you will also need a 300-75 ohm transformer such as 193983. If your TV has 300 ohm VHS screw terminals, you will need an optional 75-300 ohm transformer such as AH011.

193983 Cable Transformer



This 300-to-75 ohm transformer is used to connect a standard (300 ohm) antenna twin-lead to a standard round 75-ohm connector.

AH011 Cable Transformer



This 75-to-300 ohm transformer is used to connect a standard 75-ohm antenna cable (such as AH065G or AH066G) to the 300-ohm screw terminals on a TV.

AH25 Y-Adapter



This Y-adapter allows you to connect your camcorder's mono audio cable to a stereo TV or VCR.

All specifications and descriptions of accessories are subject to change without notice.

Accessory Order Form

Order Form for Camcorder Model CC616				
Description	Part No.	Price	Qty.	Total
Soft Camcorder Case	AC025A	\$ 59.95		
Super Lightweight Tripod	AC088	\$ 39.95		
Shoulder Strap	ACS091	\$ 13.95		
75-300 Cable Transformer	AH011	\$ 1.90		
Y-Adapter	AH25	\$ 1.95		
Coaxial RF Cable	AH065G	\$ 6.99		
Coaxial RF Cable	AH066G	\$ 8.99		
Audio/Video Cable	AH075G	\$ 10.99		
AC Battery Charger	CPS91	\$ 59.95		
Car Cord Adapter	DCC08	\$ 74.95		
Rechargeable Battery (2 Hr.)	FB120	\$ 59.95		
Rechargeable Battery (1 Hr.)	FB1260	\$ 49.95		
RF Output Adapter	1CVA147C	\$ 52.30		
300-75 Cable Transformer	193983	\$ 6.95		
Replacement Bulb for built-in Light	217092	\$ 12.95		
Remote Control	221125	\$ 39.95		
Cassette Adapter	221338	\$ 49.95		
	or VCA115A	\$ 49.95		
AC Adapter/Charger	221339	\$159.95		
	or 217010	\$159.95		

Prices are subject to change without notice.

Total Merchandise (\$10 Minimum Order).....\$ _____

Sales Tax\$ _____

We are required by law to collect the appropriate sales tax for each individual state, county, and locality to which the merchandise is being sent.

Shipping, Handling, and Insurance\$ **5.00**

Total Amount Enclosed\$ _____

Use VISA or MasterCard preferably. Money order or check must be in U.S. currency only. No COD or cash.

Detach Here



Please complete other side also

Accessory Order Form

Charge your order on your VISA
or MasterCard by
filling in below

USE YOUR CREDIT CARD

IMPORTANT: Copy complete account number
from your VISA card



My card expires:

IMPORTANT: Copy complete account number
from your MasterCard



Copy Number My card expires:
above your name on MasterCard

AUTHORIZED SIGNATURE

Prices are subject to change without notice.

Print or type your name and address clearly. This will be your mailing label.



A complete and correct order will save you days of waiting.

Name: _____

Street: _____

_____ Apt: _____

City: _____

State: _____ Zip: _____

Please make sure that both sides of this form have been filled out completely.

- Allow 8 weeks for delivery.
- All accessories are subject to availability.
- Where applicable, we will ship a superseding model.

Detach Here 

Accessory Order Form

To order accessories, contact your local Dealer.

If a dealer is not nearby, you can also follow the directions below to order by telephone or direct-by-mail.

United States and Canada Orders

To place your order by phone, have your Visa or MasterCard ready and call the toll-free number listed below between 8AM and 8PM Eastern Standard Time. **Use this number only to place an order for accessory items listed on this order form.**

1 – 800 – 338 – 0376

Most times your order will be shipped UPS within 72 hours of receipt. If ever it is not possible to ship within 30 days, we will notify you with an update on your order and an option to cancel.

To place your order by mail, detach and mail the completed order form with credit card information, money order, or check in U.S. currency (made payable to Thomson Consumer Electronics, Inc.) to the following address:

Video Accessories
PO Box 8419
Ronks, PA 17573

For more information on these accessories (or current prices), write to the following address:

Video Accessories Customer Service
Thomson Consumer Electronics, Inc.
Distributor & Special Products
2000 Clements Bridge Rd
Deptford, NJ 08096-2088

International Orders

This offer is valid only in the United States and Canada. For international orders, please send your request for a price quotation (not an order) to:

International Customer Service
Thomson Consumer Electronics, Inc.
Distributor & Special Products
2000 Clements Bridge Rd
Deptford, NJ USA 08096-2088

Trouble Checks

Troubles sometimes are caused by simple “faults” that you can easily correct without the help of a service technician by first checking a few basic remedies.

Before you call or take your camcorder to an Authorized RCA Camcorder Servicenter, look below for the type of trouble you are experiencing. Then perform the simple checks and adjustments listed for that trouble.

If service should be necessary, the warranty information lists what your warranty covers and explains how to get service.





Trouble	Checks and Adjustments
No power	<ul style="list-style-type: none"> • Place the <i>POWER</i> switch in <i>CAMERA</i> or <i>VCR</i> to turn on the camcorder. The power indicator will light. • If using battery, it may need to be recharged. • If using AC adapter/charger, make sure it is plugged into a working outlet.
Won't record or playback	<ul style="list-style-type: none"> • If using AC adapter/charger, make sure it is plugged into a working outlet. • If the dew indicator (☐) flashes in the viewfinder, there is moisture in the camcorder. Wait until the dew indicator no longer appears before operating the camcorder. • Make sure <i>POWER</i> switch is in correct position for desired operation. • There may not be a cassette in the camcorder. • Try ejecting and reinserting the cassette. • The cassette tape may be broken, try another cassette. • You may have reached the end of the cassette, try rewinding it.
Won't playback	<ul style="list-style-type: none"> • <i>POWER</i> switch must be in <i>VCR</i> position.
Won't record	<ul style="list-style-type: none"> • Safety tab has been removed. (<i>See page 20.</i>) • <i>POWER</i> switch must be in <i>CAMERA</i>.
No picture	<ul style="list-style-type: none"> • Open lens cover.
Camcorder turns itself off	<ul style="list-style-type: none"> • Place <i>POWER</i> switch to <i>OFF</i> and then <i>CAMERA</i> or <i>VCR</i> to turn back on. If camcorder is left in record pause or play pause for several minutes, it will turn itself off to prevent tape wear.

Trouble Checks

Trouble	Checks and Adjustments
Camcorder does not respond to remote control	<ul style="list-style-type: none"> • Aim remote at camcorder's remote control sensor. • Remote's lithium cell battery may be installed incorrectly. <i>See page 18.</i> • Remote control's lithium cell battery may need replacing. • Remote control sensor on camcorder exposed to direct sunlight or strong artificial light.
Tape stops during rewind or fast forward	<ul style="list-style-type: none"> • Time-counter memory may be on. Whenever an "M" appears with the time-counter display, the camcorder will stop rewinding (or fast forwarding) when counter reads <i>M 0:00:00</i>. Press <i>REW</i> or <i>FF</i> again to continue rewinding or fast forwarding, or press <i>COUNTER R/M</i> to turn off the memory-stop feature.
Camcorder remains in pause mode	<ul style="list-style-type: none"> • Press <i>PLAY/PAUSE</i> to return to normal playback.
Sound is too low or distorted	<ul style="list-style-type: none"> • Subject was too far from camcorder.
Dew Indicator flashing in viewfinder	<ul style="list-style-type: none"> • If the dew indicator () flashes in the viewfinder, there is moisture in the camcorder. Wait until this indicator no longer appears before operating the camcorder.
Poor auto-focus operation	<ul style="list-style-type: none"> • Subject is dark or behind glass. Auto-focus may not work under these conditions. Place <i>SCENE SELECT AE</i> dial in <i>MAN</i> and focus manually. <i>See pages 40-41.</i> • Subject is not in center of viewfinder or two subjects are at different distances. Place <i>SCENE SELECT AE</i> dial in <i>MAN</i> and focus manually. <i>See pages 40-41.</i> • Auto focus is automatically turned off when some effects are selected with the <i>SCENE SELECT AE</i> dial. Place <i>SCENE SELECT AE</i> dial in <i>AUTO</i>. <i>See page 41.</i>

(continued on next page)

Trouble Checks

Trouble	Checks and Adjustments
Viewfinder displays are out of focus	<ul style="list-style-type: none"> • Lens is smudged, and image appears unfocused. • Eyepiece focus control is misadjusted. • The small controls on the bottom of the viewfinder control the brightness and color of the viewfinder. These controls have been set at the factory and should require no adjustment. If the brightness or color of the viewfinder ever does require adjustment, carefully use a plastic screwdriver. Make the adjustments with caution to prevent damaging the miniature controls.
Picture is too dark or subject too dark	<ul style="list-style-type: none"> • For best results, only use higher shutter speeds outdoors. Rotate <i>SCENE SELECT AE</i> dial to sports () or Shutter(). See page 35. • Subject in front of a strong backlight. Rotate <i>SCENE SELECT AE</i> dial to select back-lit (). See page 35. • Turn on the built-in color enhancement light. • Add more light using the exposure control. See page 42.
Picture recorded with special effect	<ul style="list-style-type: none"> • <i>SCENE SELECT AE</i> dial may be turned to special effect mode. Turn the <i>SCENE SELECT AE</i> dial to <i>AUTO</i>. See page 35.
Picture recorded in brown tone	<ul style="list-style-type: none"> • <i>SEPIA</i> () selected with <i>SCENE SELECT AE</i> dial. Turn the <i>SCENE SELECT AE</i> dial to <i>AUTO</i>. See page 35.
Picture recorded with black bars at top and bottom	<ul style="list-style-type: none"> • Camcorder is set to the 16X9 mode. Turn off 16X9. See page 39.
Colors do not look natural on recording	<ul style="list-style-type: none"> • Try adjusting white balance. See page 36.
Title recorded on tape	<ul style="list-style-type: none"> • Title is recorded whenever it appears in viewfinder. Remove the title from viewfinder. See pages 48 and 49.
Power zoom lever does not operate zoom	<ul style="list-style-type: none"> • Check <i>MODE</i> selected. Zoom lever operates other features when some modes are selected. See page 37.

Trouble Checks

Trouble	Checks and Adjustments
Date and/or time were recorded on tape	<ul style="list-style-type: none">• Displays will be recorded on tape whenever they appear in the viewfinder. Remove them from viewfinder when recording. <i>See pages 48-49.</i>• When <i>AUTO DATE</i> is selected (<i>SCENE SELECT AE</i> dial in <i>AUTO</i>), display will automatically be recorded when you begin recording or change the cassette. <i>See pages 48-49.</i>
Date and/or time are incorrect	<ul style="list-style-type: none">• Clock lithium cell battery may need replacing. <i>See page 46.</i>• Date or time may need to be set. <i>See page 47.</i>
Vertical white lines appear when shooting bright object	<ul style="list-style-type: none">• This may occur when background extremely contrasts with the subject.
Error number (<i>E01, E02, etc.</i>) appears in viewfinder	<ul style="list-style-type: none">• Try disconnecting power source. Wait ten seconds and then connect power source again. If error number does not disappear from viewfinder, consult your Authorized RCA Camcorder Servicenter.

Care and Maintenance

Cleaning the Camcorder

To clean the camcorder's exterior, remove any power source connected to the camcorder and gently wipe it with a clean soft cloth.

Caution: Use of strong cleaning products, such as those containing alcohol or benzine, may damage the camcorder.

Cleaning the Camcorder's Lens

To clean the camcorder's lens, blow it with a blower brush, and then gently wipe the lens with cleaning tissue and commercially prepared cleaning solution designed for use on camera lens. Improper cleaning may scratch the lens.

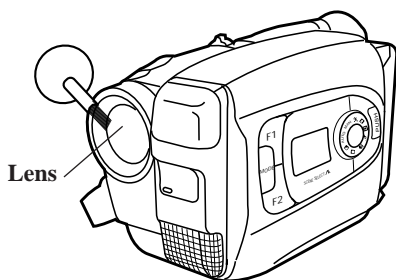

Caution: Do not touch the lens with your fingers. The oil from your skin can damage the lens.

Cleaning the Camcorder's Viewfinder

The viewfinder eyepiece can be removed for cleaning.

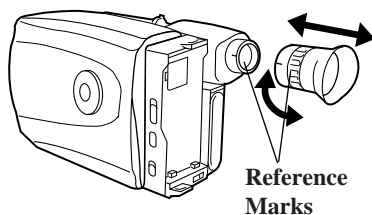

1. Turn the eyepiece counterclockwise and pull it out.
2. Remove dust using a blower brush.
3. Reattach the eyepiece by aligning the reference marks, and then turn the eyepiece clockwise.

Care and Maintenance

Proper Care and Storage

- Keep dust and grit from entering the camcorder's cassette door. Dust and grit are abrasive and will cause excessive wear to both the camcorder's recording/playback heads and cassettes.
- Always close the lens cover when the camcorder is not in use.
- Before handling your camcorder, make sure your hands and face are free from any chemical products such as suntan lotion, as it may damage the finish.
- The camcorder can be damaged by improper storage or handling. Do not subject the camcorder to swinging, shaking, or dropping.
- Do not store the camcorder in temperatures below -22°F (-30C) or above 149°F (65C).
- When the camcorder is not in use, always remove the cassette and AC adapter/charger or battery.
- Retain the original carton for future storage or shipping purposes.

Things to Avoid

- Do not attempt to disassemble your camcorder. There are no user-serviceable parts inside.
- Avoid operating your camcorder immediately after moving it from a cold location to a warm location. Give the camcorder 1-1/2 to 2 hours to reach a stable temperature before inserting a cassette. When the camcorder is moved from cold to warm, condensation may cause the tape to stick to the headwheel and damage the headwheel or tape.
- Do not aim your camcorder at the sun or other bright objects.
- Do not leave your camcorder in direct sunlight for extended periods of time. The resulting heat buildup could permanently damage the camcorder's internal parts.
- Do not operate the camcorder in extremely humid environments.
- Do not operate the camcorder near the ocean as salt water or salt water spray may damage the internal parts of the camcorder.
- Do not operate the camcorder for extended periods in temperatures below 40°F (4C) or above 95°F (35C).
- Do not expose the camcorder or adapter/charger to rain or moisture. If either component becomes wet, turn off the power and take the unit to an Authorized RCA Camcorder Servicer.
- Do not use an adapter/charger or batteries other than the ones specified for the camcorder. Use of the wrong accessories may cause damage to the camcorder.

Specifications

General

Power requirement: 6VDC
Power consumption: 5.9 watts (normal)
Weight: 1.8 lbs. (780g)
Dimensions – Including Viewfinder
4-3/8"(W) x 4-1/2"(H) x 8-1/2" (D)
110 (W) x 112 (H) x 213 (D) mm

Video Recorder Section

Format: VHS-C
Record/Playback System:
Four video record/playback heads
One flying erase head
Video Signal: EIA Standard NTSC
color

Camera Section

Image Sensor: 1/4" CCD Imager
Tripod Mount: One 1/4" x 20 threaded
hole
Lens: f1/1.6
12:1 (4.2-50.4 mm)
Diameter: 43 mm

AC Adapter/Charger

Power requirement: 100-240 V, 50/60 Hz.
Power consumption: 23 watts
Weight: Approx. 320 grams
Dimensions:
150 (W) x 42 (H) x 68 (D) mm

Information to User

This equipment has been tested and found to comply with the limits for a Class B digital device and RF lighting device pursuant to Part 15 and Part 18 of the FCC Rules. These limits are designed to provide reasonable protection against harmful interference in a residential installation. This equipment generates, uses, and can radiate radio frequency energy and, if not installed and used in accordance with the instructions, may cause harmful interference to radio communications. However, there is no guarantee that interference will not occur in a particular installation. If this equipment does cause harmful interference to radio or television reception, which can be determined by turning the equipment off and on, the user is encouraged to try to correct the interference by one or more of the following measures:

- Reorient or relocate the receiving antenna.

- Increase the separation between the equipment and receiver.
- Connect the equipment into an outlet on a circuit different from that to which the receiver is connected.
- Consult the dealer or an experienced radio/TV technician for help.

Alterations or modifications carried out without appropriate authorization may invalidate the user's FCC right to operate the equipment.

This digital apparatus does not exceed the Class B limits for radio noise emissions from digital apparatus as set out in the interference-causing equipment standard entitled "Digital Apparatus", ICES-003 of the Department of Communications.

Cet appareil numérique respecte les limites de bruits radioélectriques applicables aux appareils numériques de Classe B prescrites dans la norme sur le matériel brouilleur: "Appareils Numériques", NMB-003 édictée par le ministre des Communications.

Customer Assistance and Service

You can reach Thomson at the following number:

800-283-6503
(Toll free inside U.S.A.)

Our toll-free Camcorder number operates from 8 a.m. to 5 p.m., CST Monday – Friday for U.S. customers only

Thomson provides a toll-free telephone number to help you with any problems you may encounter with your camcorder. Many can be diagnosed over the phone, and if necessary, a replacement unit can be shipped to you. Please have your camcorder model/serial number and date of purchase ready when you call. If your unit is out of warranty, we will quote the cost of an exchange unit to you.

Returning equipment to Thomson for repair or exchange

If we are unable to resolve your problem over the phone, we will gladly service your unit or exchange it for a new or refurbished camcorder. Refer to the limited warranty on the reverse side to learn about your specific rights and responsibilities.

Always consult Thomson and get a Return Authorization number before returning anything! Obtain a Return Authorization (RA) number from the telephone representative before returning your equipment to avoid delays, accounting errors, or even loss of your unit.

Important information to customers who ship defective equipment to Thomson Consumer Electronics

The Thomson representative who authorized the return of your equipment will give you an RA number over the phone. They will also provide you with instructions on where and how to return your camcorder. Write the number in large, clear characters on the outside of the box. To avoid confusion and misunderstandings, shipments without an RA number clearly visible on the outside of the box will be returned to you at your expense.

Include a brief note describing the problem and any conversations about the problem you have had with Thomson personnel. Include your name, address

and model/serial number of your camcorder. These numbers are located on the bottom of your unit. If your camcorder is within the warranty period, please provide a copy of the bill of sale to verify purchase date. Use the original box and packing material to protect the equipment from damage in shipment.

For your protection, insure all shipments for full replacement value and use a reliable shipper. Thomson assumes no responsibility for warranty shipments from the customer to the factory if not shipped in the manner prescribed by Thomson.

Limited Warranty

What your warranty covers:

- Any defect in materials or workmanship.

For how long after your purchase:

- 90 days for labor charges.
- One year for parts.

What we will do:

During the initial 90 days

- Exchange your camcorder with a new or, at our option, a refurbished unit or at your option, repair your camcorder at no cost to you.

After the 90 days and within one year

- Exchange your camcorder with a new or, at our option, a refurbished unit or at your option, repair your camcorder. Parts will be provided at no charge, but you will be responsible for the cost of labor required for the repair.

How you get service:

- Call 1-800-283-6503 and have your unit's date of purchase and model/serial number ready. The model/serial number information is on the bottom of your camcorder.
- A representative will troubleshoot your problem over the phone. If the representative determines that you should receive a replacement unit, you will be provided with a Return Authorization (RA) number and the location of a nearby exchange point if one exists. No returns will be accepted without the RA number.

To receive a replacement camcorder before you return yours:

If you are located near an exchange point:

1. We will send a replacement unit to the exchange point next business day delivery.
2. The exchange location will notify you of its arrival.
3. Take your unit, including all accessories, and your bill of sale

which validates date of purchase to the exchange location and you will be provided the new or refurbished unit.

4. If the repairs were covered by your warranty, you will not be billed.

If you are not located near an exchange point:

1. Provide your Discover, MasterCard or Visa account number and expiration date to our phone representative. This is for security purposes. If we receive your unit including all accessories within 14 days from the date you were provided a Return Authorization number, only items not covered by warranty will be charged to your account. **IF YOUR UNIT INCLUDING ALL ACCESSORIES IS NOT RECEIVED WITHIN 14 DAYS, THE SUGGESTED RETAIL VALUE OF THE CAMCORDER AND/OR ACCESSORIES WILL BE CHARGED TO YOUR CREDIT CARD.** This amount will be credited if the unit is subsequently received.
2. We will send you a replacement unit next business day delivery.
3. You will receive an invoice packed with the replacement product, but will not be charged for the unit portion of the invoice amount if we receive your unit including all accessories within 14 days from the date you were provided the RA number. Any labor and parts charges not covered by our warranty will be included and charged against your account.
4. Ship the unit back to us along with all accessories included with your camcorder using the replacement unit's carton. Shipping instructions will be included in the carton along with your RA number, which will allow you to easily ship the unit back to us. **Make sure you insure your**

Limited Warranty

shipment in case of damage or loss.

Include with the shipment:

- A copy of your dated bill of sale to verify your unit's warranty eligibility.
- A brief note describing your camcorder problem.
- Your name, address and phone number.

Return transportation, storage, and handling costs and insurance are your sole responsibility. We accept no liability in case of damage or loss.

To receive a replacement unit after we have received your unit:

1. Write the RA number on the outside of the carton used to return the unit.

Make sure you insure your shipment in case of damage or loss.

2. Carefully pack the unit along with all accessories included with your camcorder, using the original box and packing material if possible.
3. Include with the shipment:
 - A copy of your dated bill of sale to verify your unit's warranty eligibility.
 - A brief note describing your camcorder problem.
 - Your name, address and phone number.

Return transportation, storage, and handling costs, and insurance are your responsibility. We accept no liability in case of damage or loss.

4. Include a cashier's check or money order for payment if there are any out of warranty labor or parts charges which were indicated by the representative, and you elected not to use your credit card.
5. Upon receipt of your product, a new or refurbished unit will be shipped to you next day delivery.

To have your Camcorder repaired by an Authorized RCA Camcorder

Servicenter:

- Check with your dealer or call 1-800-336-1900 for the Authorized RCA Camcorder Servicenter nearest you.
- Take your unit to the Authorized RCA Camcorder Servicenter of your choice.
- Show the Authorized RCA Camcorder Servicenter representative your sales receipt or other, evidence of purchase.
- Pick up your camcorder when repairs are complete.

What your warranty does not cover:

- Adjustment of customer controls.
- Damage from misuse or neglect.
- A unit that has been modified or incorporated into other products or is used for institutional or other commercial purposes.
- Battery for clock and other features.
- Cleaning of video/audio heads.
- Camcorders purchased or serviced outside the U.S.A.
- Return transportation, storage and handling costs of your unit, including insurance for loss or damage.
- Acts of God, such as but not limited to lightning damage.

Product Registration:

- Please complete and mail the *Product Registration Card* packed with your camcorder. It will make it easier to contact you should it ever be necessary. The return of the card is not required for warranty coverage.

How State Law relates to warranty:

- This warranty gives you specific legal rights and you may have other rights that vary from state to state.

If you purchased your Camcorder outside the United States:

- Contact your dealer for warranty information.

Index

- 16x9 Indicators 28-29,39
- 16x9 Mode 39
- A. (Audio) *DUB* Button 16-17,52-53
- Accessories, Included 3
- Accessories, Optional 64-69
- Accessory, Order Form 67-69
- Adapter/Charger, Using 3,11
- Animation Indicators 28-29,50
- Animation Recording 50
- Assistance 1,3,77,Back Cover
- Audio Dub Indicators 28-29,52
- Audio Dubbing 52-53
- AUDIO/RF DC/VIDEO OUT*
 - Jacks 60,62
- Audio/Video Cable (Optional) 3,60,64
- AUTO* Mode 7,35
- Auto Focus 40
- Auto Head Cleaner 31
- B* (Bright) Control 10,72
- Back-Light Mode 35
- BATT. RELEASE* Button 10,11,13
- Battery, Care and Storage 14
- Battery, Clock 26-27,46
- Battery, Installing in Clock 46
- Battery, Installing in Remote 18
- Battery Level Indicator 14,26
- Battery Marker Switch 13
- Battery Safety Precautions 13
- Battery, Using Rechargeable 12-14
- Bulb, Replacing for Light 55
- C* (Color) Control 10,72
- Camcorder Lens, Cleaning 74
- Camcorder, Cleaning 74
- Camcorder, Powering 11-15
- Camcorder, Turning On 8
- Camcorder, Unpacking 3
- Camera Edit Feature 31
- Car Cord Adapter, Optional 15,64
- Care and Maintenance 74-75
- Care and Storage of Battery 14
- Cassette Adapter 58-59
- Cassette Door 4,9
- Cassette Warning Indicator 26-27
- Cassettes, Care and Storage 21
- Cassettes, Inserting and Removing 4,21
- Cautions Inside Front Cover
- Charging the Battery 12
- Checking Problems 70-73
- Cleaning Camcorder 74
- Clock Battery Indicator 26-27,46
- Clock Battery, Installing 46
- Clock Cell Compartment 10,46
- Color Enhancement Light 9,54-55
- Contents 1-2
- Controls 9-10
- Copying Tapes 60-61
- COUNTER R/M* Button 10,32,52-53
- Customer Assistance 1,3,77,Back Cover
- Date and Time Displays 26,46-49
- DATE/TIME/CHAR +* and *-* Buttons 10,45,47
- DATE/TIME/CHAR SET* Button 10,45,47
- Design Specifications 76
- Dew Warning 28
- Display Panel 9,37-42
- Displays, Camcorder Displays
 - on TV 48-49,61,63
- Displays, Viewfinder 26-29
- EDIT SEARCH +* and *-* Buttons 10,22-23,31
- Edit Insert 53
- Edit Insert Indicator 28-29,53
- EJECT* Button 4,9,21,22,57
- Electronic Indexing 30
- Erase Protection 20
- Exposure Bar Indicator 26,42
- Exposure Control 42
- Eyepiece Focus Control 7,9,22,25
- F1* and *F2* Buttons 9,22-23,37-42,44,48-49
- FADE* Indicators 28-29,38
- Fading 38
- FF* (Fast Forward) Button 10,16-17,30,57
- First-Time Operation 3-10
- Flying Erase Head 30
- Focus Displays 26-27,40-41
- Focus Lock Feature 40
- Focusing 40-41
- Front-Light Mode 35
- Handstrap 5,10
- High-Speed Shutter Mode 35
- Included Accessories 3
- INDEX* Display 28-29,30
- Indexing, Electronic 30
- INSERT* Button 16-17,53
- Inserting and Removing Cassettes 21
- LENS COVER* Control 5,9,22,26-27
- Lens 9
- Lens, Cleaning 74
- LIGHT OFF•AUTO•ON*
 - Switch 9,22-23,54-55
- Light, Built In 54-55
- Limited Warranty 78-79
- Maintenance and Care 74-75
- MAN* (Manual) Mode 35
- MAN.W.BAL* (Manual White Balance)
 - Button 10,36
- Manual Focus 41
- Memory Stop Feature 32,52-53
- Microphone 9,30
- MODE* Button 9,22-23,28-29,37-42,44,48-49
- MWB* Indicator 36
- Operation, First-Time 3-10

Index

- Optional Accessories 64-69
- Order Form, Accessory 67-69
- PAUSE** Button 16-17,52-53
 - ≡ PAUSE ≡ Indicator 5,8,22-23
- Pause, Stop-Action 57
- PLAY** Button 16,52-53,57
- PLAY/PAUSE** Button .. 8,10,52-53,57,61,63
- Playback 57-63
- Playback Features 57
- Playback on a TV With
 - AUDIO/VIDEO IN** Jacks 60-61
- Playback on a TV
 - Without Audio/Video Inputs 62-63
- Playback, First 8
- Playback Speeds 20
- Playback, Viewfinder 57
- Plug Adapter 11
- Portrait Mode 35
- POWER CAMERA/OFF/VCR**
 - Switch 5,8,10,11,13-17,22-23,31
..... 38-39,43,44,50-53,57,61,63
- Power Connector 11
- Powering the Camcorder 11-15
- Problem Solving 70-73
- Product Registration Inside Front Cover
- Proper Care and Storage 75
- Quick Review Feature 31
- REC 6 6 6** Indicator 8,22
- Recording Speeds 6,20,33
- Recording Tips 24
- Recording, First 8
- Recording, Making a 22-23
- Refreshing the Battery 12
- Registration Card Inside Front Cover
- Remote Control 16-18
- Remote Control Sensor 9,18
- REW** (Rewind) Button .. 8,10,16,30,52-53,57
- RF Output Adapter, Optional 62-63,66
- Safety Tab 20
- SCENE SELECT AE**
 - Dial 7,9,22-23,26-27,35-42,44,48
- Searching, Visual 57
- SELF INT.**(Interval)/**TIME**
 - Button 16-17,28-29,43,50-51
- Self-Timer 43
- Self-Timer Indicators 28-29,43
- Sensor, Remote 18
- Sepia Mode 35
- Shoulder Strap, Attaching 56
- Shoulder Strap Attachment Rings 10,56
- Solving Problems 70-73
- Specifications 76
- Speeds, Recording and Playback 6,20,33
- Sports Mode 35
- Spotlight Mode 35
- SP•SLP/T20•30•40**
 - Switch 6,10,20,22,33,50-51
- START/STOP** Button 16-17,43,50-51
- Status Displays 28-29
- STOP** Button 8,10,16,30,57
- Stop-Action Pause 57
- Table of Contents 1-2
- Tally Light 9,22-23,30
- TAPE END** Display 28-29
- Tape Copying 60-61
- Tape Length Display 26-27,33
- Tape Positioning 30
- Tape Time Remaining Display 26-27,33
- Things to Avoid 75
- Thumb Trigger 8,10
- Tilt, Viewfinder 25
- TIME LAPSE ANIM. REC/TIME**
 - Button 16-17,28-29,50-51
- TIME LAPSE SELF INT./TIME**
 - Button 16-17,28-29,43,50-51
- Time Counter 32
- Time Counter Display 26-27,32
- Time-Lapse Indicators 28-29,50-51
- Time-Lapse Recording 50-51
- Tips, Recording 24
- Title, Creating New 45
- Title Displays 26,44-45,48-49
- Titler 44-45
- Titles, Preset 44
- Titles, Recording 44,48-49
- TRACKING** Buttons 10,57,61,63
- Tracking 57
- Traveling Tips 19
- Tripod, Using 65
- Trouble Checks 70-73
- Turning On the Camcorder 8
- Unpacking the Camcorder 3
- User Information 76
- Using Cassette Adapter 58-59
- Video Cassettes 20-21
- Viewfinder 7,9,25,26-29,57,74
- Viewfinder Displays 26-29
- Viewfinder Playback 57
- Viewfinder, Cleaning 74
- Visual Searching 57
- Warranty, Limited 78-79
- White Balance 36
- White Balance Display 28,36
- ZOOM** Buttons, Remote 16,34
- Zoom Lever 9,22-23,26,34
- Zooming 34

Need Assistance? We want to help!

U.S. Consumers:

Camcorder Exchange Warranty	800-283-6503
Customer Service	800-336-1900
Accessories	800-338-0376

Canadian Consumers:

English	800-522-0338
French	800-522-0445

If your camcorder needs service, please contact your dealer or the nearest Servicenter from the yellow pages. Please do not send any products to the Indianapolis address listed in this manual or on the carton. This will only add delays in service for your product.

 **THOMSON CONSUMER ELECTRONICS**
10330 N Meridian Street
Indianapolis, IN 46290

©1995 Thomson Consumer Electronics, Inc.

Trademark(s)[®] Registered

Marca(s) Registrada(s)

Printed in Japan

Download from www.Somanuals.com. All Manuals Search And Download.
Part Number 95-CC616-1

Free Manuals Download Website

<http://myh66.com>

<http://usermanuals.us>

<http://www.somanuals.com>

<http://www.4manuals.cc>

<http://www.manual-lib.com>

<http://www.404manual.com>

<http://www.luxmanual.com>

<http://aubethermostatmanual.com>

Golf course search by state

<http://golfingnear.com>

Email search by domain

<http://emailbydomain.com>

Auto manuals search

<http://auto.somanuals.com>

TV manuals search

<http://tv.somanuals.com>