

Digital Video Camcorder

Mini DV Digital
Video
Cassette

VP-D301(i)/D303(i)/D303D(i)/D305(i)/D307(i)

- AF** Auto Focus
- CCD** Charge Coupled Device
- LCD** Liquid Crystal Display

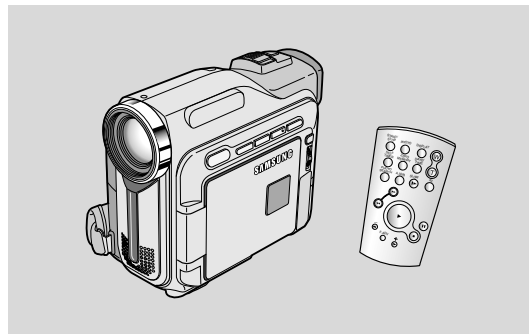

Owner's Instruction Book

Before operating the unit, please read this instruction book thoroughly, and retain it for future reference.



 This product meets the intent of
Directive 89/336 CEE, 73/23 CEE, 93/68 CEE.

Contents

| | |
|--|-----------|
| Notes and Safety Instructions | 6 |
| Getting to Know Your Camcorder | 11 |
| Features | 11 |
| Accessories Supplied with camcorder | 12 |
| Front & Left View | 13 |
| Left side View | 14 |
| Right & Top View | 15 |
| Rear & Bottom View | 16 |
| Remote control | 17 |
| OSD (On Screen Display in CAMERA and PLAYER modes) | 18 |
| OSD (On Screen Display in M.REC and M.PLAY modes) (VP-D303(i)/D303D(i)/D305(i)/D307(i) only) | 19 |
| Turning the OSD on/off (On Screen Display) | 19 |
| Preparation | 20 |
| How to use the Remote Control | 20 |
| Battery Installation for the Remote Control | 20 |
| Self Record using the Remote Control | 20 |
| Lithium Battery Installation | 21 |
| Adjusting the Hand Strap | 22 |
| Hand strap | 22 |
| Shoulder Strap | 22 |
| Attaching the Lens Cover | 22 |
| Connecting a Power Source | 23 |
| To use the AC Power adapter and DC Cable | 23 |
| To select the CAMCORDER mode (VP-D303(i)/D303D(i)/D305(i)/D307(i) only) | 23 |
| Using the Lithium Ion Battery Pack | 24 |
| Charging the Lithium Ion Battery Pack | 24 |
| Table of continuous recording time based on model and battery type | 25 |
| Battery level display | 26 |
| Inserting and Ejecting a Cassette | 27 |
| BASIC Recording | 28 |
| Making your First Recording | 28 |
| Selecting the OSD LANGUAGE | 29 |
| Record Search (REC SEARCH) | 30 |
| Hints for Stable Image Recording | 31 |
| Recording with the LCD monitor | 31 |
| Recording with the Viewfinder | 31 |
| Adjusting the LCD | 32 |
| Using the VIEWFINDER | 33 |
| Adjusting the Focus | 33 |
| Playing back a tape you have recorded on the LCD | 34 |
| Adjusting the LCD during PLAY | 35 |

Contents

| | |
|--|-----------|
| Controlling Sound from the Speaker | 35 |
| Advanced Recording | 36 |
| Use of various Functions | 36 |
| Setting menu items | 36 |
| Set the camcorder to CAMERA or PLAYER mode and M.REC or M.PLAY mode (VP-D303(i)/D303D(i)/D305(i)/D307(i) only) | 37 |
| Availability of functions in each mode | 38 |
| CLOCK SET | 39 |
| WL_REMOTE | 40 |
| BEEP SOUND (VP-D301i/D303i/D303Di/D305i/D307i only) | 41 |
| SHUTTER SOUND (VP-D303i/D303Di/D305i/D307i only) | 42 |
| DEMONSTRATION | 43 |
| PROGRAM AE | 44 |
| Setting the PROGRAM AE | 45 |
| WHT. BALANCE (WHITE BALANCE) | 46 |
| Zooming In and Out with DIGITAL ZOOM | 47 |
| Zooming In and Out | 47 |
| Tele MACRO | 47 |
| Digital Zoom | 48 |
| DIS (Digital Image Stabilizer) | 49 |
| DSE (Digital Special Effects) SELECT | 50 |
| Selecting an effect | 51 |
| REC MODE | 52 |
| AUDIO MODE | 53 |
| WIND CUT | 54 |
| DATE/TIME | 55 |
| TV DISPLAY | 56 |
| Using Quick Menu | 57 |
| Setting the Quick menu | 58 |
| SHUTTER SPEED & EXPOSURE | 59 |
| SLOW SHUTTER(Low Shutter Speed) | 60 |
| EASY Mode (for Beginners) | 61 |
| AF/MF (Auto Focus/Manual Focus) | 62 |
| Auto Focusing | 62 |
| Manual Focusing | 62 |
| BLC (Back Light Compensation) | 63 |
| Fade In and Out | 64 |
| To Start Recording | 64 |
| To Stop Recording (use FADE IN / FADE OUT) | 64 |
| Audio dubbing | 65 |
| Dubbing sound | 65 |
| Dubbed Audio Playback | 66 |
| PHOTO Image Recording | 67 |
| Searching for a PHOTO picture | 67 |

Contents

| | |
|---|-----------|
| NIGHT CAPTURE (0 lux recording) | 68 |
| POWER NIGHT CAPTURE..... | 69 |
| Various Recording Techniques | 70 |
| Playback | 71 |
| Tape Playback | 71 |
| Playback on the LCD | 71 |
| Playback on a TV monitor | 71 |
| Connecting to a TV which has Audio/Video input jacks | 71 |
| Connecting to a TV which has no Audio and Video input jacks | 72 |
| Playback | 72 |
| Various Functions while in PLAYER mode | 73 |
| Playback pause | 73 |
| Picture search (Forward/Reverse) | 73 |
| Slow playback (Forward/Reverse) | 73 |
| Frame advance (To play back frame by frame) | 74 |
| X2 playback (Forward/Reverse) | 74 |
| Reverse playback | 74 |
| ZERO MEMORY | 75 |
| PB DSE (Playback Digital Special Effects) | 76 |
| PB ZOOM | 77 |
| Recording in PLAYER mode (VP-D301i/D303i/D303Di/D305i/D307i only) | 78 |
| IEEE 1394 Data Transfer | 79 |
| Transferring IEEE1394 (i.LINK)-DV standard data connections | 79 |
| Connecting to a DV device | 79 |
| Connecting to a PC | 79 |
| System requirements | 80 |
| Recording with a DV connection cable (VP-D301i/D303i/D303Di/D305i/D307i only) | 80 |
| USB interface | 81 |
| Transferring a Digital Image through a USB Connection | 81 |
| System Requirements | 81 |
| Installing DVC Media 5.1 Program | 82 |
| Using the "PC camera" function | 82 |
| Using the "removable Disk" function | 83 |
| Using the "USB streaming" function | 83 |
| Connecting to a PC | 83 |
| Digital Still Camera mode (VP-D303(i)/D303D(i)/D305(i)(i)/D307(i) only)..... | 84 |
| MEMORY STICK (Optional Accessory) | 84 |
| Memory Stick Functions | 84 |
| Inserting and ejecting the Memory Card | 85 |
| Structure of folders and files on the Memory Card | 86 |
| Image Format | 86 |

Contents

| | |
|---|------------|
| Selecting the CAMCORDER mode | 86 |
| MEMORY FILE NUMBER | 87 |
| Selecting the image quality | 88 |
| Select the image quality | 88 |
| Number of images on the Memory Card | 88 |
| Recording Still images to a Memory Card in M.REC Mode | 89 |
| Recording images to a Memory Card | 89 |
| Recording an image from a cassette as a still image | 90 |
| Viewing Still images | 91 |
| To view a Single image | 91 |
| To view a slide show | 91 |
| To view the Multi Display | 92 |
| Copying still images from a cassette to Memory Card | 93 |
| Marking images for printing | 94 |
| Protection from accidental erasure | 95 |
| Deleting Still images | 96 |
| Formatting the Memory Card | 97 |
| Attention | 97 |
| MPEG RECORDING | 98 |
| Selecting the moving picture sizes | 99 |
| MPEG Playback | 100 |
| Maintenance | 101 |
| After finishing a recording | 101 |
| Cleaning and Maintaining the Camcorder | 102 |
| Cleaning the Video Heads | 102 |
| Using Your Camcorder Abroad | 103 |
| Power sources | 103 |
| Colour system | 103 |
| Troubleshooting | 104 |
| Troubleshooting | 104 |
| Self Diagnosis Display | 104 |
| Moisture Condensation | 104 |
| Self Diagnosis Display in M.REC, M.PLAY mode (VP-D303(i)/D303D(i)/D305(i)/D307(i) only) | 105 |
| Specifications | 107 |
| INDEX | 108 |
| Power Sources (United Kingdom Only) | 109 |

Notes and Safety Instructions

Notes regarding the rotation of the LCD screen

Please rotate the LCD screen carefully as illustrated.

Over rotation may cause damage to the inside of the hinge that connects the LCD screen to the Camcorder.

1. LCD screen closed.
2. Standard recording using the LCD screen.
 - Open the LCD screen with your finger.
3. Recording when looking at the LCD screen from the top.
4. Recording when looking at the LCD screen from the front.
5. Recording with the LCD screen closed.

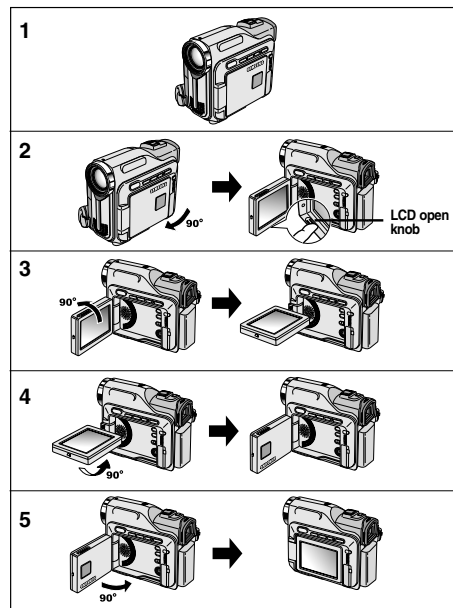

Notes and Safety Instructions

Notices regarding COPYRIGHT (VP-D301i/D303i/D303Di/D305i/D307i only)

Television programs, video tapes, DVD titles, films, and other program materials may be copyrighted. Unauthorized copying of copyrighted material may be against the law.

Notes regarding moisture condensation

1. A sudden rise in atmospheric temperature may cause condensation to form inside the camcorder.

for example:

- When you move the camcorder from a cold location to a warm location (e.g. from outside to inside during winter.)
 - When you move the camcorder from a cool location to a hot location (e.g. from inside to outside during the summer.)
2. If the  (DEW) protection feature is activated, leave the camcorder for at least two hours in a dry, warm room with the cassette compartment opened and the battery pack removed.

Notes regarding CAMCORDER

1. Do not leave the camcorder exposed to high temperature (above 60°C or 140°F).
For example, in a parked car in the sun or exposed to direct sunlight.
2. Do not let the camcorder get wet.
Keep the camcorder away from rain, sea water, and any other form of moisture. If the camcorder gets wet, it may get damaged.
Sometimes a malfunction due to exposure to liquids cannot be repaired.

Notes and Safety Instructions

Notes regarding the battery pack

- Make sure that the battery pack is fully charged before starting to record.
- To preserve battery power, keep your camcorder turned off when you are not operating it.
- If your camcorder is in CAMERA mode, and it is left in STBY mode without being operated for more than 5 minutes with a tape installed, it will automatically turn itself off to protect against unnecessary battery discharge.
- Make sure that the battery pack is fitted firmly into place.
Dropping the battery pack may damage it.
- A brand new battery pack is not charged.
Before using the battery pack, you need to charge it completely.
- It is a good idea to use the viewfinder rather than the LCD when making a long recording, because the LCD uses up more battery power.

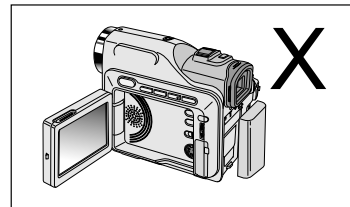

* When the battery reaches the end of its life, please contact your local dealer.
The batteries have to be dealt with as chemical waste.

Notes regarding the Video Head Cleaning

- To ensure normal recording and a clear picture, clean the video heads regularly. If a square block-shape distorts playback, or only a blue screen is displayed, the video heads may be dirty. If this happens, clean the video heads with a dry type cleaning cassette.
- Do not use a wet-type cleaning cassette. It may damage the video heads.

Notes and Safety Instructions

Note regarding the LENS

- Do not film with the camera lens pointing directly at the sun. Direct sunlight can damage the CCD (Charge Coupled Device).

Notes regarding electronic viewfinder

1. Do not position the camcorder such that the viewfinder is pointing towards the sun. Direct sunlight can damage the inside of the viewfinder. Be careful when placing the camcorder under sunlight or near a window exposed to sunlight.

Notes regarding 'Record' or 'Playback' using the LCD

1. The LCD display has been manufactured using high precision technology. However, there may be tiny dots (red, blue or green in colour) that appear on the LCD display. These dots are normal and do not affect the recorded picture in any way.
2. When you use the LCD display under direct sunlight or outdoors, it may be difficult to see the picture clearly. If this occurs, we recommend using the viewfinder.
3. Direct sunlight can damage the LCD monitor.

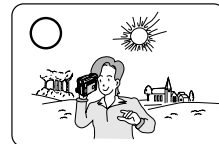

Notes regarding the hand strap

- To ensure a steady picture during filming, check that the hand strap is properly adjusted.
- Do not force your hand into the hand strap as you could damage it.

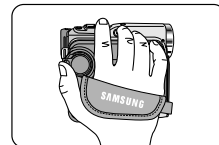

ENGLISH

Notes and Safety Instructions

Precautions regarding the Lithium battery

1. The lithium battery maintains the clock function and user settings; even if the battery pack or AC adapter is removed.
2. The lithium battery for the camcorder lasts about 6 months under normal operation from time of installation.
3. When the lithium battery becomes weak or dead, the date/time indicator will display “---” when you set the DATE/TIME to ON.
When this occurs, replace the lithium battery with a new one (type CR2025).
4. There is a danger of explosion if battery is incorrectly replaced.
Replace only with the same or equivalent type.

Warning: Keep the LITHIUM BATTERY out of reach of children. Should a battery be swallowed, consult a doctor immediately.

SERVICING

Do not attempt to service this CAMCORDER yourself.
Opening or removing covers may expose you to dangerous voltage or other hazards.
Refer all servicing to qualified service personnel.

REPLACEMENT PARTS

When replacement parts are required, be sure the service technician has used replacement parts specified by the manufacturer and having the same characteristics as the original part.
Unauthorized substitutions may result in fire, electric shock or other hazards.

Getting to Know Your Camcorder

Features

- **MULTI OSD LANGUAGE**

You can select the desired OSD Language among English, French, German, Spanish, Italian, Polish and Dutch.

- **Digital data transfer function with IEEE1394**

By incorporating the IEEE 1394 (i.LINK™ : i.LINK is a serial data transfer protocol and interconnectivity system, used to transmit DV data) high speed data transport port, both moving and still images can be transferred to a PC, making it possible to produce or edit various images.

- **USB interface for digital image data transfer**

You can transfer images to a PC using the USB interface without an add-on card.

- **PHOTO**

The PHOTO function lets you capture an object as a still along with sound, while in Camera mode.

- **900x Digital zoom**

Allows you to magnify an image up to 900 times its original size.

- **Colour TFT LCD**

A high-resolution colour TFT LCD gives you clean, sharp images as well as the ability to review your recordings immediately.

- **Digital Image Stabilizer (DIS)**

The DIS compensates for any handshake, reducing unstable images particularly at high magnification.

- **Various digital effects**

The DSE (Digital Special Effects) allows you to give your films a special look by adding various special effects.

- **Back Light Compensation (BLC)**

The BLC function compensates for the bright background behind a subject you're recording.

- **Program AE**

The Program AE enables you to alter the shutter speed and aperture to suit the type of scene/action to be filmed.

- **NIGHT CAPTURE**

The NIGHT CAPTURE function enables you to record a subject in the dark place.

- **Digital Still Camera function (VP-D303(i)/D303D(i)/D305(i)/D307(i) only)**

- Using Memory Card, you can easily record and playback standard still images.

- You can transfer standard still images on the Memory Card to your PC using the USB interface.

- **MPEG Recording (VP-D303(i)/D303D(i)/D305(i)/D307(i) only)**

MPEG recording makes it possible to record video onto a Memory Card.

- **MULTI MEMORY CARD SLOT (VP-D305(i)/D307(i) only)**

Multi Memory Card Slot is able to use the Memory Card, the MMC and the SD.

Getting to Know Your Camcorder

Accessories Supplied with camcorder













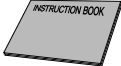

Make sure that the following basic accessories are supplied with your digital video camera.

Basic Accessories

1. Lithium Ion Battery pack
2. AC Power Adapter (AA-E8 TYPE)
3. AC Cord
4. AUDIO/VIDEO Cable
5. Instruction Book
6. Lithium battery for Remote Control or Clock. (TYPE: CR2025)
7. Remote Control
8. USB cable
9. Software CD
10. Lens Cover
11. Shoulder strap

Optional Accessories

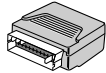
12. S-VIDEO Cable
13. Scart adapter
14. Memory Stick

| | | |
|--|---|--|
| 1. Lithium Ion Battery pack  | 2. AC Power Adapter (AA-E8 TYPE)  | 3. AC cord  |
| 4. AUDIO/VIDEO Cable  | 5. Instruction Book  | 6. Lithium battery (CR2025)  |
| 7. Remote Control  | 8. USB cable  | 9. Software CD  |
| 10. Lens Cover  | 11. Shoulder strap  | |
| 12. S-VIDEO Cable  | 13. Scart adapter  | 14. Memory Stick  |

Getting to Know Your Camcorder

Front & Left View

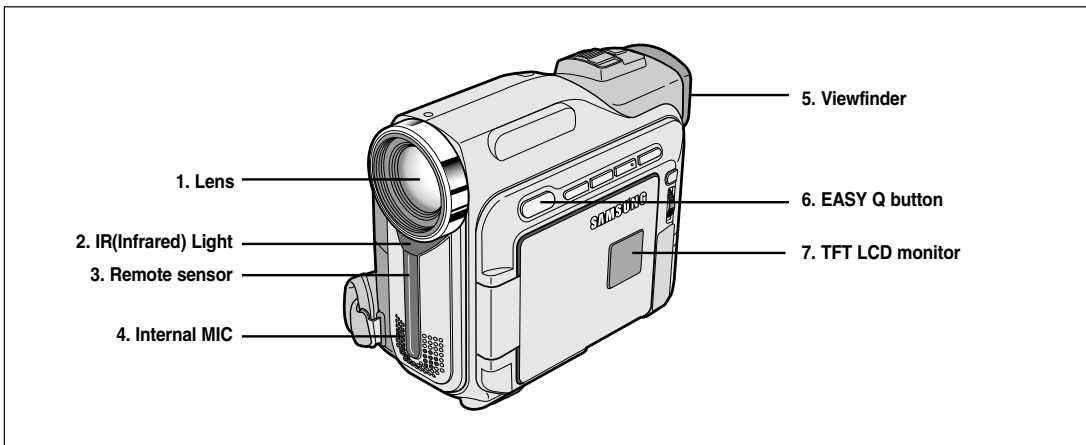

1. Lens

2. IR(Infrared) Light

3. Remote sensor

4. Internal MIC

**5. Viewfinder
(see page 33)**

**6. EASY Q button
(see page 61)**

7. TFT LCD monitor

Getting to Know Your Camcorder

Left Side View

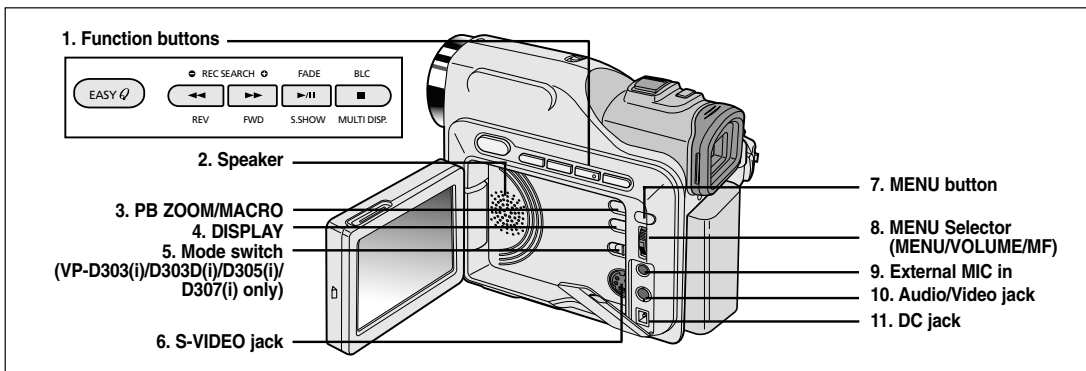

1. Function buttons

| PLAYER | CAMERA | M.PLAY <small>(VP-D303(i)/D303D(i)/ D305(i)/D307(i) only)</small> |
|--------------------|--------------|--|
| - | EASY | - |
| ◀◀ : (REW) | REC SEARCH - | REV |
| ▶▶ : (FF) | REC SEARCH + | FWD |
| ▶ : (PLAY/STILL) | FADE | S.SHOW |
| ■ : (STOP) | BLC | MULTI DISP. |

2. Speaker
3. PB ZOOM/MACRO
4. DISPLAY
5. Mode switch (MEMORY CARD/TAPE)
(VP-D303(i)/D303D(i)/D305(i)/D307(i) only)
6. S-VIDEO jack
7. MENU button
8. MENU Selector (MENU/VOLUME/MF)
9. External MIC in
10. Audio/Video jack
11. DC jack

Getting to Know Your Camcorder

Right & Top View

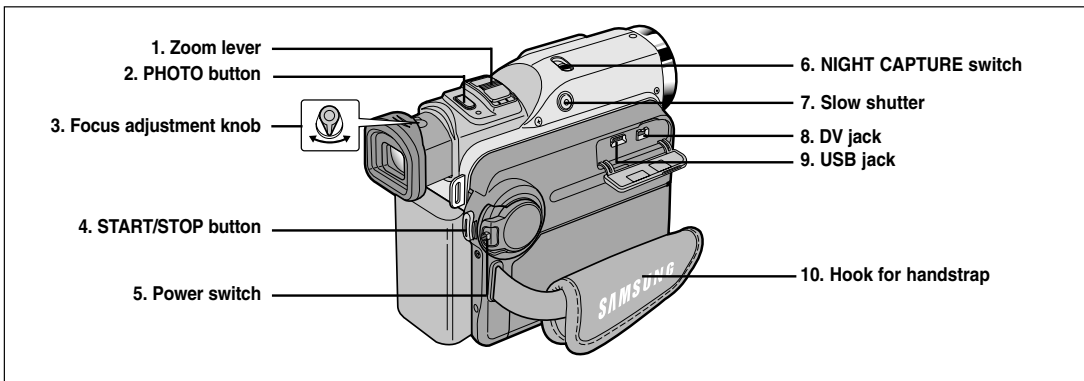

1. Zoom lever
2. PHOTO button
(see page 67)
3. Focus adjustment knob
4. START/STOP button
5. Power switch (CAMERA or PLAYER)
6. NIGHT CAPTURE switch
7. Slow shutter
8. DV jack
9. USB jack
10. Hook for handstrap

Getting to Know Your Camcorder

Rear & Bottom View

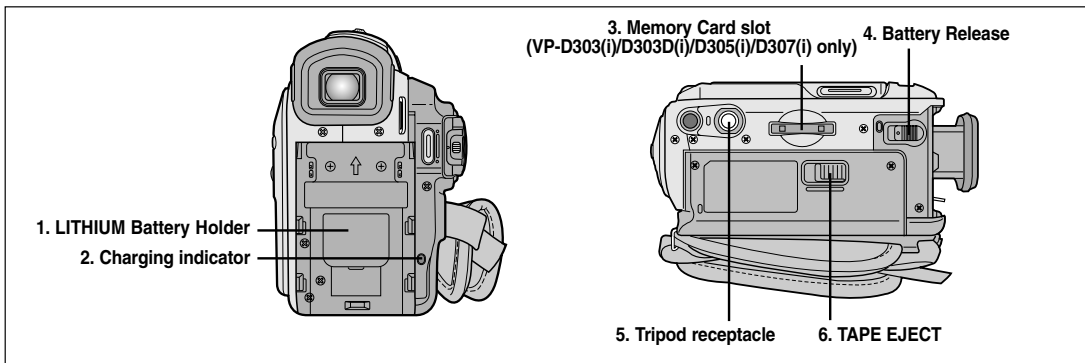

1. LITHIUM Battery Holder
2. Charging indicator
3. Memory Card slot
(VP-D303(i)/D303D(i)/D305(i)/D307(i) only)
4. Battery Release
5. Tripod receptacle
6. TAPE EJECT

Memory Card slot

VP-D303(i)/D303D(i)



VP-D305(i)/D307(i)



(Usable MEMORY CARDS)

Getting to Know Your Camcorder

Remote control

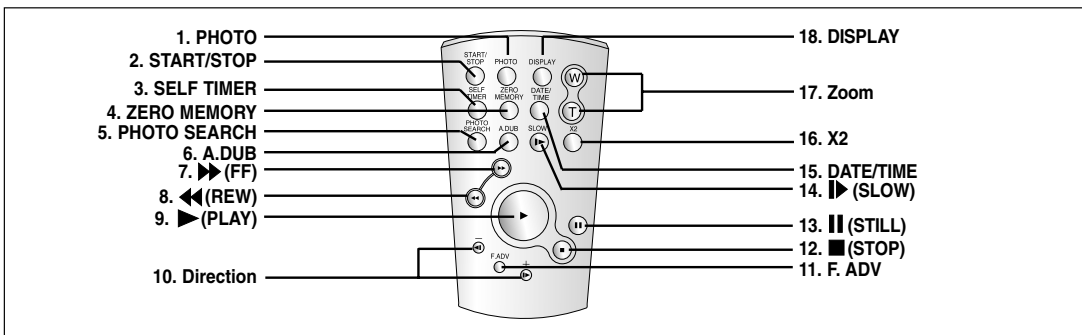

- | | |
|------------------------------|---|
| 1. PHOTO | 10. Direction (◀◀ , ►►) (see page 73) |
| 2. START/STOP | 11. F. ADV (see page 74) |
| 3. SELF TIMER (see page 20) | 12. ■ (STOP) |
| 4. ZERO MEMORY (see page 75) | 13. (STILL) |
| 5. PHOTO Search | 14. ►► (SLOW) |
| 6. A.DUB (see page 65) | 15. DATE/TIME |
| 7. ►► (FF) | 16. X2 (see page 74) |
| 8. ◀◀ (REW) | 17. Zoom |
| 9. ► (PLAY) | 18. Display |

Getting to Know Your Camcorder

OSD (On Screen Display in CAMERA and PLAYER modes)

1. Battery level (see page 26)
2. Easy mode (see pages 61)
3. DSE (Digital Special Effects) mode (see page 50)
4. Program AE (see page 44)
5. White Balance mode (see page 46)
6. BLC (Back Light Compensation) (see page 63)
7. Manual focus (see page 62)
8. Shutter speed and EXPOSURE (see page 59)
9. Zoom position (see page 47)
10. NIGHT CAPTURE (see page 68)
11. DATE/TIME (see page 55)
12. USB
13. WL. REMOTE (see page 40)
14. WIND CUT (see page 54)
15. Audio recording mode (see page 53)
16. Zero memory indicator (see page 75)
17. Remaining Tape (measured in minutes)
18. Tape Counter
19. Operating mode
20. Record speed mode
21. PHOTO mode
22. Self recording and waiting timer (see page 20)
23. DIS (see page 49)
24. Volume control (see page 35)
25. Audio playback channel
26. DV IN(DV data transfer mode) (VP-D301i/D303i/D303Di/D305i/D307i only) (see page 80)
27. DEW (see page 7)
28. Message Line
29. PB DSE (see page 76)
30. PB ZOOM/ENTER (see page 77)
31. POWER NIGHT CAPTURE (see page 69)
32. Tele MACRO (see page 47)

OSD in CAMERA mode

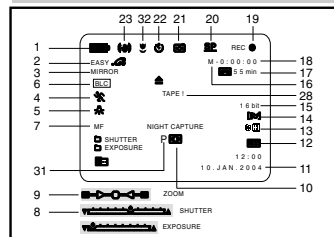

OSD in PLAYER mode

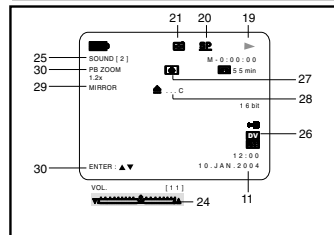

Getting to Know Your Camcorder

OSD (On Screen Display in M.REC/M.PLAY modes) (VP-D303(i)/D303D(i)/D305(i)/D307(i) only)

- A. Folder number-file number (see page 86)
- B. Image counter
 - Current still image/Total number of recordable still images.
- C. CARD (MEMORY CARD) indicator
- D. Image recording and loading indicator
- E. Quality
- F. ERASE PROTECTION indicator (see page 95)
- G. Print Mark (see page 94)
- H. SLIDE SHOW
- I. MPEG4 SCREEN SIZE

Turning the OSD on/off (On Screen Display)

• Turning OSD on/off

Press the DISPLAY button on the left side panel.

- Each press of the button toggles the OSD function on and off.
- When you turn the OSD off,

In CAMERA mode: The STBY, REC, EASY.Q modes are always displayed on the OSD, even when the OSD is turned OFF and the key input is displayed for 3 seconds then turned off.

In PLAYER mode: When you press any Function button, the function is displayed on the OSD for 3 seconds before it turns off.

• Turning the DATE/TIME on/off

- The DATE/TIME is not affected when the OSD function is switched ON or OFF.
- To turn the DATE/TIME on or off, access the menu and change the DATE/TIME mode. (see page 55)
- You may also use the Quick Menu to turn the DATE/TIME ON or OFF. (see page 57) (only in CAMERA/M.REC mode)

OSD in M.REC mode

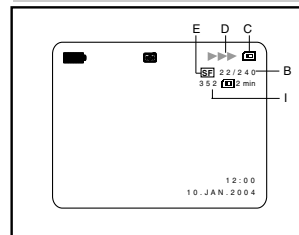

OSD in M.PLAY mode

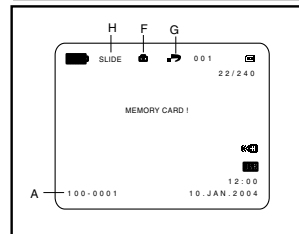

Preparation

How to use the Remote Control

Battery Installation for the Remote Control

- ❖ You need to insert or replace the lithium battery when :
 - You purchase the camcorder.
 - The remote control doesn't work.
- ❖ Ensure that you insert the lithium cell correctly, following the + and - markings.
- ❖ Be careful not to reverse the polarity of the battery.

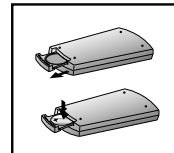

Self Record using the Remote Control

When you use the Self Timer function on the remote control, the recording begins automatically in 10 seconds.

1. Set the camcorder to CAMERA mode.
2. Press the SELF TIMER button until the appropriate indicator is displayed in the LCD.
3. Press the START/STOP button to start the timer.
 - Self Timer starts counting down from 10 with a beep sound.
 - In the last one second of the countdown, the beep sound gets faster, then recording starts automatically.
 - If you want to cancel the Self Timer function before recording, press the SELF TIMER button.
4. Press START/STOP again when you wish to stop recording.

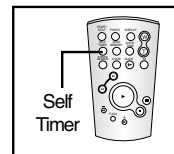

Preparation

Lithium Battery Installation

- ❖ The lithium battery maintains the clock function and preset contents of the memory; even if the battery pack or AC power adapter is removed.
- ❖ The lithium battery for the camcorder lasts about 6 months under normal operation from the time of installation.
- ❖ When the lithium battery becomes weak or dead, the date/time indicator will display “---” when you set the DATE/TIME to ON.
When this occurs, replace with the lithium battery of CR2025 type.

1. Open the lithium battery cover from the camcorder.
2. Position the Lithium cell in the holder, with the positive (⊕) terminal face outward.
3. Close the lithium battery cover.

Note

The lithium battery must be inserted in the correct direction.

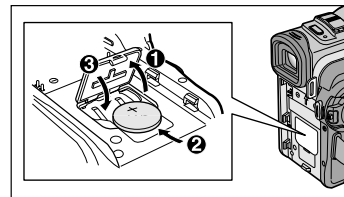

Warning: Keep the LITHIUM BATTERY out of the reach of the children.
Should any battery be swallowed, consult a doctor immediately.

Preparation

Adjusting the Hand Strap

It is very important to ensure that the Hand strap has been correctly adjusted before you begin your recording.

The hand strap enables you to :

- Hold the camcorder in a stable, comfortable position.
- Press the Zoom and START/STOP button without having to change the position of your hand.

Hand strap

- a. Pull open the Hand Strap cover and release the Hand Strap.
- b. Adjust its length and stick it back onto the Hand Strap cover.
- c. Close the Hand Strap cover again.

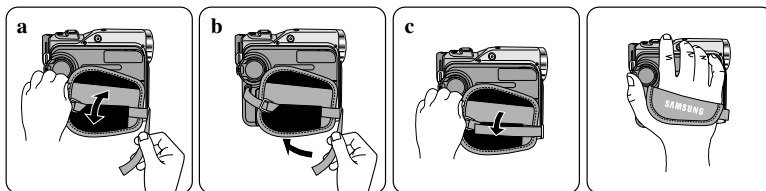

Shoulder Strap

The Shoulder Strap enables you to carry your camcorder around in complete safety.

1. Insert the end of strap into the Shoulder Strap hook on the camcorder.
Insert the other end of strap into ring inside hand strap.
2. Thread each end into the buckle, adjust the length of the strap and then pull it tight in the buckle.

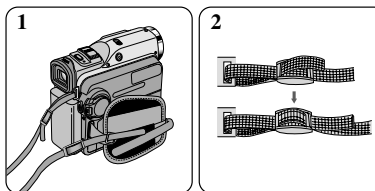

Attaching the Lens Cover

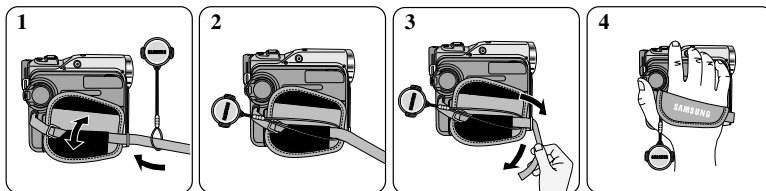

Preparation

Connecting a Power Source

There are two types of power source that can be connected to your camcorder.

- The AC Power Adapter and AC cord : used for indoor recording.
- The Battery Pack : used for outdoor recording.

To use the AC Power adapter and DC Cable

1. Connect the AC Power adapter to the AC cord.
2. Connect the AC cord to a wall socket.

Notes

- You must use the AC Power adapter of AA-E8 TYPE.
 - The plug and wall socket type may differ according to your resident country.
3. Connect the DC cable to the DC jack socket of the camcorder.
 4. Set the camcorder to each mode by holding down the tab on the power switch and turning it to the CAMERA or PLAYER mode.

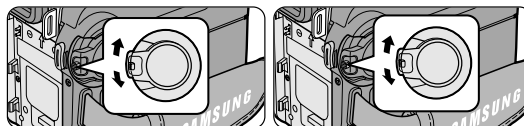
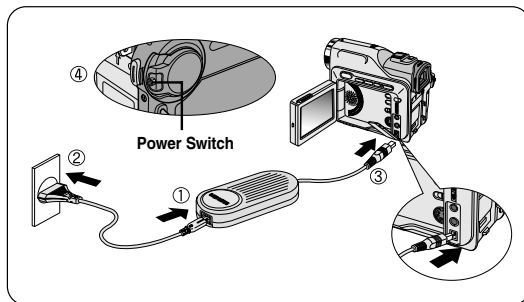

To select the CAMCORDER mode (VP-D303(i)/D303D(i)/D305(i)/D307(i) only)

- ❖ If you want to use this unit as a camcorder, set the mode switch to TAPE position.
- ❖ If you want to use this unit as a DSC (Digital Still Camera), set the mode switch to Memory Card position.

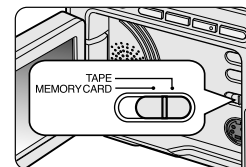

Preparation

Using the Lithium Ion Battery Pack

- ❖ The amount of continuous recording time available depends on.
 - The type and capacity of the battery pack you are using.
 - How often the Zoom function is used.
- It is recommended that you have several batteries available.

Charging the Lithium Ion Battery Pack

1. Attach the battery pack to the camcorder.
2. Connect the AC Power adapter to an AC cord and connect the AC cord to a wall socket.
3. Connect the DC cable to the DC jack socket on the camcorder.
4. Turn the Camera power switch to off, and the charging indicator will start to flash, showing that the battery is charging.

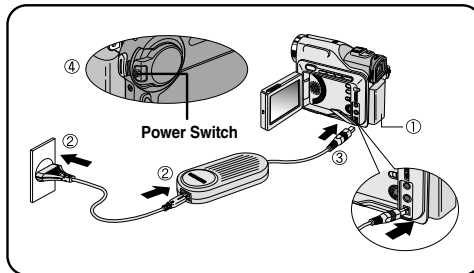

| Blinking time | Charging rate |
|--------------------------------------|---|
| Once per second | Less than 50% |
| Twice per second | 50% ~ 75% |
| Three times per second | 75% ~ 90% |
| Blinking stops and stays on | 90 ~ 100% |
| On for a second and off for a second | Error - Reset the battery pack and the DC cable |

5. When the battery is fully charged, disconnect the battery pack and the AC Power adapter from the camcorder.
 - Even with the power switched off, the battery pack will still discharge if it is left connected to the camcorder.

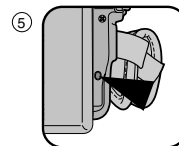

Notes

- The battery pack may be charged a little at the time of purchase.
- To prevent reduction in the life and capacity of the battery pack, always remove it from the camcorder after it is fully charged.

Preparation

Using the Lithium Ion Battery Pack

Table of continuous recording time based on model and battery type.

- ❖ If you close the LCD screen, it switches off and the viewfinder switches on automatically.
- ❖ The continuous recording times given in the table above are approximations.
Actual recording time depends on usage.

| Battery \ Time | Charging time | Continuous recording time | |
|----------------|----------------------|---------------------------|----------------------|
| | | LCD ON | VIEWFINDER ON |
| SB-LS110 | Approx. 2hr | Approx. 1hr 30min | Approx. 2hr |
| SB-LS220 | Approx. 3hr 30min | Approx. 3hr 10min | Approx. 4hr 10min |

Notes

- The battery pack should be recharged in an environment of between 32°F (0°C) and 104°F (40°C).
- The battery pack should never be charged in a room temperature that is below 32°F (0°C).
- The life and capacity of the battery pack will be reduced if it is used in temperatures below 32°F (0°C) or left in temperatures above 104°F (40°C) for a long period, even when it is fully recharged.
- Do not put the battery pack near any heat source (fire or flames, for example).
- Do not disassemble, process, pressure, or heat the Battery Pack.
- Do not allow the + and - terminals of the battery pack to be short-circuited.
It may cause leakage, heat generation, induce fire and overheating.

Preparation

Battery level display

- **The battery level display indicates the amount of power remaining in the battery pack.**

- Fully charged
- 20~40% used
- 40~80% used
- 80~95% used
- Completely used (flickers)
(The camcorder will turn off soon, change the battery as soon as possible)

- ❖ Please refer to the table on page 25 for approximate continuous recording time.
- ❖ The recording time is affected by environmental temperature and conditions. The recording time becomes very short in a cold environment. The continuous recording time in the operating instructions are measured using a fully charged battery pack at 77°F(25°C). As the environmental temperature and conditions may differ when you actually use the camcorder, the remaining battery time may not be the same as the approximate continuous recording times given in these instructions.

Tips for Battery Identification

A charge mark is provided on the battery pack to help you remember whether it has been charged or not.

Two colours are provided (red and grey)-you may choose which one indicates charged and which indicates discharged.

Note

- The charge mark setting does not affect the battery's charge status.

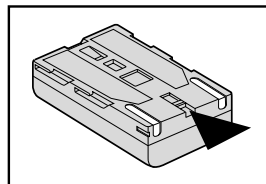
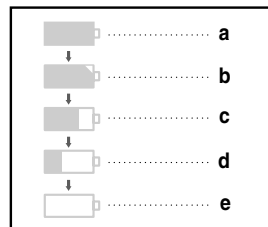

Preparation

Inserting and Ejecting a Cassette

- ❖ When inserting a tape or closing a cassette holder, do not apply excessive force. This may cause a malfunction.
 - ❖ Do not use any tape other than Mini DV cassettes.
1. Connect a power source and slide the TAPE EJECT switch and open the cassette door.
 - The cassette holding mechanism rises automatically.
 2. Insert a tape into the cassette holder with the tape window facing outward and the protection tab bottom.
 3. Press the area marked PUSH on the cassette holding mechanism until it clicks into place.
 - The cassette is loaded automatically.
 4. Close the cassette door.
 - Close the door completely until you hear a “click”.

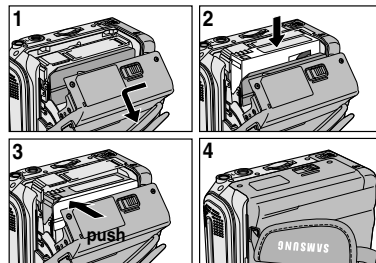

Note

When you have recorded something that you wish to keep, you can protect it so that it will not be accidentally erased.

a. Protecting a tape :

Push the safety tab on the cassette so that the hole is uncovered.

b. Removing the tape protection :

If you no longer wish to keep the recording on the cassette, push the write-protect tab back so that it covers the hole.

• How to store a tape

- a. Avoid places with magnets or magnetic interference.
- b. Avoid humidity and dust prone places.
- c. Keep the tape in an upright position and avoid storing it in direct sunlight.
- d. Avoid dropping or knocking your tapes.

a. SAVE



b. REC



Basic Recording

Making your First Recording

1. Connect a Power source to the camcorder. (see page 23)
(A battery pack or a AC power adapter)
 - Insert a cassette. (see page 27)
2. Remove the LENS CAP.
3. Set the power switch to the CAMERA position.
 - Open the LCD monitor.
 - Set the mode switch to the TAPE position.
(VP-D303(i)/D303D(i)/D305(i)/D307(i) only)
Make sure that STBY is displayed.
 - If the protection tab of the cassette is open, STOP and PROTECTION! will be displayed.
 - Make sure the image you want to record appears in the LCD monitor or viewfinder.
 - Make sure the battery level indicates that there is enough remaining power for your expected recording time.
4. To start recording, press the START/STOP button.
 - REC is displayed in the LCD.
 - To stop recording, press the START/STOP button again.
 - STBY is displayed in the LCD.

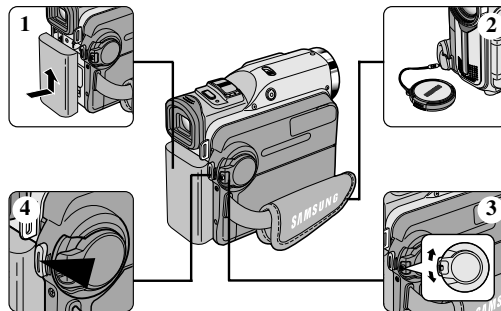

Basic Recording

Selecting the OSD LANGUAGE

- ❖ Select the appropriate OSD Language among English, French, German, Spanish, Italian, Polish and Dutch.
- ❖ The Language Function works in CAMERA, PLAYER, M.REC, M.PLAY modes.

1. Press the MENU button.
 - The menu list will appear.
2. Move the MENU SELECTOR to highlight INITIAL and push the MENU SELECTOR.
3. Select LANGUAGE from the sub-menu and push the MENU SELECTOR.
4. Using the MENU SELECTOR, select the LANGUAGE and push the MENU SELECTOR.
 - Push the MENU SELECTOR button to confirm the OSD LANGUAGE.
5. To exit, press the MENU button.
 - The OSD changes to the selected language.

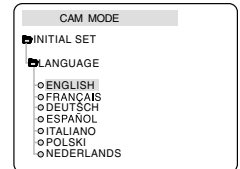
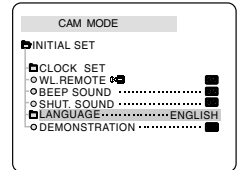
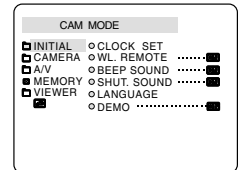

Note

- “LANGUAGE” is always indicated in ENGLISH.

Basic Recording

When a cassette is loaded and the camcorder is left in the STBY mode for more than 5 minutes without being used, it will switch off automatically.

To use it again, push the START/STOP button or set the Power switch to OFF and then back to CAMERA. This Auto Power OFF feature is designed to save battery power.

Record Search (REC SEARCH)

- ❖ You can view a recording using the REC SEARCH +, - function in STBY mode. REC SEARCH - enables you to play the recording backwards and REC SEARCH + enables you to play it forwards, for as long as you keep each button pressed down.
- ❖ If you press the REC SEARCH - button in STBY mode, your camcorder will play in reverse for 3 seconds and return to the original position automatically.

Note

Mosaic shaped distortion may appear on the screen while in Record Search mode.

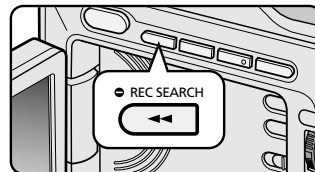

Basic Recording

Hints for Stable Image Recording

- While recording, it is very important to hold the camcorder correctly.
- Fix the LENS cap firmly by clipping it to the hand strap. (see page 22)

Recording with the LCD monitor

1. Hold the camcorder firmly using the hand strap.
2. Place your right elbow against your side.
3. Place your left hand under or beside the LCD to support and adjust it.
Do not touch the built-in microphone.
4. Choose a comfortable, stable position for the shots that you are taking.
You can lean against a wall or on a table for greater stability.
Do not forget to breathe gently.
5. Use the LCD frame as a guide to determine the horizontal plane.
6. Whenever possible, use a tripod.

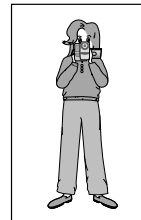

Recording with the Viewfinder

1. Hold the camcorder firmly using the hand strap.
2. Place your right elbow against your side.
3. Place your left hand under the camcorder to support it.
Be sure not to touch the built-in microphone.
4. Choose a comfortable, stable position for the shots that you are taking.
You can lean against a wall or on a table for greater stability.
5. Place your eye firmly against the viewfinder eyecup.
6. Use the viewfinder frame as a guide to determine the horizontal plane.
7. Whenever possible, use a tripod.



Basic Recording

Adjusting the LCD

- ❖ Your camcorder is equipped with a 2.5 inch colour Liquid Crystal Display(LCD) screen, which enables you to view what you are recording or playing back directly.
- ❖ Depending on the conditions under which you are using the camcorder (indoors or outdoors for example), you can adjust ;
 - BRIGHT SELECT
 - BRIGHT ADJUST
 - COLOUR ADJUST

1. Set the POWER switch to CAMERA position.
 - In the PLAYER mode, you may only setup the LCD while the tape is playing.
2. Open the LCD screen, and the LCD switches on.
3. Press the MENU button.
4. Move the MENU SELECTOR so that VIEWER is highlighted and then push the MENU SELECTOR.
5. Move the MENU SELECTOR so that LCD ADJUST is highlighted.
6. Push the MENU SELECTOR to enter the sub-menu.
7. Move the MENU SELECTOR so that it highlights the menu item you want to adjust (BRIGHT SELECT, BRIGHT ADJUST, COLOUR ADJUST).

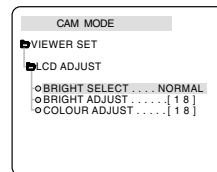
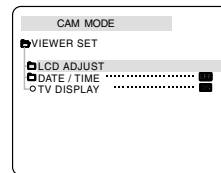
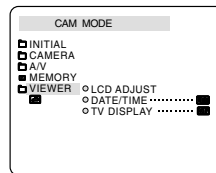
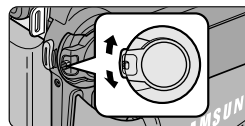

Basic Recording

8. Push the MENU SELECTOR again.
 - You may select NORMAL or SUPER in the BRIGHT SELECT feature and push the MENU SELECTOR to save the setting.
 - Use the MENU SELECTOR to adjust the value of BRIGHT ADJUST and COLOR ADJUST.
 - You can set values for BRIGHT ADJUST between 00 ~ 35 and COLOUR ADJUST between 00 ~ 35.
9. Press the MENU button to finish the setting.

Using the VIEWFINDER

- ❖ In the PLAYER mode, the VIEWFINDER will work when the LCD is closed.
- ❖ In the CAMERA mode, the VIEWFINDER will work when the LCD is closed or rotated counterclockwise 180°.

Adjusting the Focus

Use the focus adjustment knob of the VIEWFINDER to focus the picture.
(refer to figure)

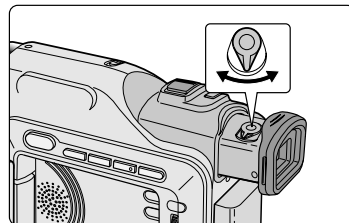

Basic Recording

Playing back a tape you have recorded on the LCD

- ❖ You can monitor the playback picture on the LCD monitor.
 - ❖ Make sure that the battery pack is in place.
1. Hold down the power switch tab and turn it to the PLAYER position.
 2. Insert the tape you wish to view. (see page 27)
 3. Open the LCD screen.
Adjust the angle of the LCD screen and set the brightness or colour if necessary.
 4. Press the ◀◀ (REW) button to rewind the tape to the starting point.
 - To stop rewinding, press the ■ (STOP) button.
 - The camcorder stops automatically after rewinding is complete.
 5. Press the ▶▶ (PLAY/STILL) button to start playback.
 - You can view the picture you recorded on the LCD.
 - To stop the PLAY operation, press the ■ (STOP) button.

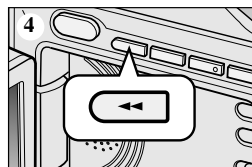
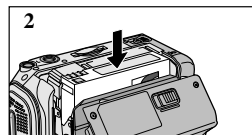
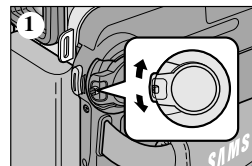

Notes

- You can also view the picture on a TV screen, after connecting the camcorder to a TV or VCR. (see page 71)
- Various functions are available in playback mode. (see page 73)

Basic Recording

Adjusting the LCD during PLAY

- ❖ You can adjust the LCD during playback.
- ❖ The adjustment method is the same procedure as used in CAMERA mode. (see page 32)

Controlling Sound from the Speaker

The Speaker works in PLAYER mode only.

- When you use the LCD screen for playback, you can hear recorded sound from the built-in Speaker.
 - Follow the instructions below to decrease or mute speaker volume in the PLAYER mode.
 - Take the following steps to lower the volume or mute the sound while playing a tape on the camcorder.
1. Set the power switch to PLAYER mode.
 2. Press ►/|| (PLAY/STILL) to play the tape.
 3. When you hear sounds once the tape is in play, use the MENU SELECTOR to adjust the volume.
 - A volume level display will appear on the LCD.
 - Levels may be adjusted from anywhere between 00 to 19 and you will not hear any sound when the volume is set on 00.
 - If you close the LCD while playing, you will not hear sound from the speaker.

Notes

- When the cable is connected to the AV jack, you cannot hear sound from the speaker and cannot adjust the volume.
- If a cable is connected to the AV jack, you can hear sound from the speaker when AV IN/OUT MODE on MENU is set to AV IN. (VP-D301i/D303i/D303Di/D305i/D307i only)
- You can hear sound from speaker by removing the connected cable from the AV jack.

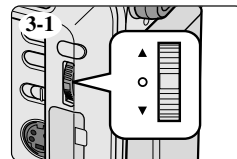
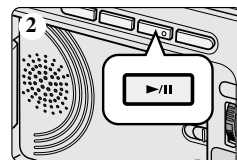

<-3-2>

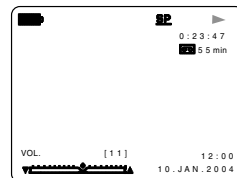

Advanced Recording

Use of various Functions

● Setting menu items

| MENU | SUB MENU | FUNCTIONS | Available mode | | | | Page |
|---------|-------------------|--|----------------|--------|------------|-------------|------|
| | | | CAMERA | PLAYER | M. REC (☆) | M. PLAY (☆) | |
| INITIAL | CLOCK SET | Setting the time | ✓ | ✓ | ✓ | ✓ | 39 |
| | WL. REMOTE | Using the Remote Control | ✓ | ✓ | ✓ | ✓ | 40 |
| | BEEP SOUND (■) | Play Various Sound Effects | ✓ | ✓ | ✓ | ✓ | 41 |
| | SHUTTER SOUND (●) | Sound Effect for the photo button | | ✓ | ✓ | | 42 |
| | LANGUAGE | Selecting the OSD language | ✓ | ✓ | ✓ | ✓ | 29 |
| | DEMO | Demonstration | ✓ | | | | 43 |
| CAMERA | PROGRAM AE | Selecting the PROGRAM AE Function | ✓ | | | | 44 |
| | WHT. BALANCE | Setting White Balance | ✓ | | ✓ | | 46 |
| | D. ZOOM | Selecting Digital Zoom | ✓ | | | | 48 |
| | DIS | Selecting the Digital Image Stabilizing | ✓ | | | | 49 |
| | DSE SELECT | Setting the Digital special effect | ✓ | | | | 50 |
| AV | REC MODE | Selecting the recording speed | ✓ | ✓ | | | 52 |
| | PHOTO SEARCH | Searching pictures recorded in TAPE | | ✓ | | | 67 |
| | PHOTO COPY | Copying pictures from TAPE onto the Memory Card | | ✓ | | | 93 |
| | AUDIO MODE | Selecting Sound Quality for recording | ✓ | ✓ | | | 53 |
| | AUDIO SELECT | Selecting the Audio playback channel | | ✓ | | | 66 |
| | WIND CUT | Minimizing wind noise | ✓ | ✓ | | | 54 |
| | PB DSE | Selecting Digital Special Effect during the playback | | ✓ | | | 76 |
| | AV IN/OUT (■) | Selecting Analog AV in or out | | ✓ | | | 78 |

(■) : This Function works on model VP-D301i/D303i/D303Di/D305i/D307i only.

(☆) : This Function works on model VP-D303(i)/D303D(i)/D305(i)/D307(i) only.

(●) : This Function works on model VP-D306i/D303S/D305i/D307i only.

Advanced Recording

| MENU | SUB MENU | FUNCTIONS | Available mode | | | | Page |
|------------|----------------|--|----------------|--------|------------|-------------|------|
| | | | CAMERA | PLAYER | M. REC (☆) | M. PLAY (☆) | |
| MEMORY (☆) | M. PLAY SELECT | Selecting Storage Media (MPEG4, PHOTO) to playback | | | | ✓ | 100 |
| | PHOTO QUALITY | Selecting Image Quality | | ✓ | ✓ | | 88 |
| | MPEG4 SIZE | Selecting Image Resolution | | | ✓ | | 99 |
| | PRINT MARK | Print images recorded on a Memory Card | | | | ✓ | 94 |
| | PROTECT | Preventing Accidental Erasure | | | | ✓ | 95 |
| | FILE NO. | File Naming Options | | ✓ | ✓ | ✓ | 87 |
| | DELETE | Deleting Files | | | | ✓ | 96 |
| | FORMAT | Formatting the Memory Card | | | | ✓ | 97 |
| VIEWER | LCD ADJUST | Setting the Brightness and colour Tones of the LCD | ✓ | ✓ | ✓ | ✓ | 32 |
| | DATE/TIME | Setting the Date and Time | ✓ | ✓ | ✓ | ✓ | 55 |
| | TV DISPLAY | Selecting OSD on/off of TV | ✓ | ✓ | ✓ | ✓ | 56 |

(☆) : This Function works on model VP-D303(i)/D303D(i)/D305(i)/D307(i) only.

● Set the camcorder to CAMERA or PLAYER mode and M.REC or M.PLAY mode (VP-D303(i)/D303D(i)/D305(i)/D307(i) only)

1. Press the MENU button.

The MENU OSD is displayed. The cursor (**HIGHLIGHT**) indicates the feature you are currently adjusting.

2. Use the MENU SELECTOR and push the MENU SELECTOR on the left side panel to select and activate the item.

3. You can exit the menu mode by pressing the MENU button.

Advanced Recording

● **Availability of functions in each mode**

| Requested Operating Mode | Digital functions | | | | Digital special effects | NIGHT CAPTURE |
|--------------------------------|-------------------|--------|-----------------|-----------------|-------------------------------|------------------|
| | DIS | D.ZOOM | PHOTO (TAPE) | SLOW SHUTTER | | |
| DIS | ○ | ○ | ○ | △ | ○ | ○ |
| D.ZOOM | ○ | ○ | ○ | * △ | ○ | ○ |
| PHOTO | × | × | ○ | × | × | ○ |
| SLOW SHUTTER | △ | × | ○ | ○ | ○ | ○ |
| Digital Special Effects | ○ | ○ | ○ | ○ | ○ | △ |
| NIGHT CAPTURE | ○ | ○ | ○ | ○ | × | ○ |

○ : The requested mode will work in this operating mode.

×

△ : The operating mode will be released and the requested mode will work.

* : The operating mode will be released and the requested mode will work.

(Operating mode data will be backed up)

Notes

- When a menu item on the LCD is marked with an X, that item cannot be activated.
- When you select an item that cannot be changed, an error message will be displayed.

Advanced Recording

● CLOCK SET

- ❖ CLOCK setup works in CAMERA, PLAYER, M.REC and M.PLAY modes.
- ❖ The DATE/TIME is automatically recorded onto a tape.
Before recording, please set the DATE/TIME.

1. Press the MENU button.
 - The menu list will appear.
2. Move the MENU SELECTOR to highlight INITIAL and push the MENU SELECTOR.
3. Use the MENU SELECTOR to select CLOCK SET from the submenu.
4. Push the MENU SELECTOR to enter SETTING mode.
 - A blinking item indicates the item to be changed. The year will blink first.
5. Using the MENU SELECTOR, change the year setting.
6. Push the MENU SELECTOR.
 - The month will blink.
7. Using the MENU SELECTOR, change the month setting.
8. Push the MENU SELECTOR.
 - The day will blink.
9. You can set the day, hour and minute following the same procedure for setting the year and month.
10. Push the MENU SELECTOR after setting the minutes.
 - The word COMPLETE! will appear, and a few seconds later, the menu screen will automatically return to the sub menu.
11. To exit, press the MENU button.

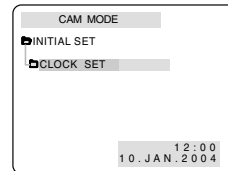
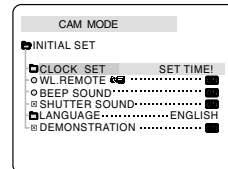
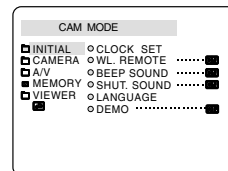

Advanced Recording

● WL. REMOTE

- ❖ The WL.REMOTE function works in CAMERA, PLAYER, M.REC, M.PLAY modes.
(M.REC, M.PLAY : VP-D303(i)/D303D(i)/D305(i)/D307(i) only)
- ❖ The WL.REMOTE option allows you to enable or disable the remote control for use with the camcorder.

1. Press the MENU button.
 - The menu list will appear.
2. Move the MENU SELECTOR to highlight INITIAL and push the MENU SELECTOR.
3. Use the MENU SELECTOR to select WL.REMOTE from the submenu.
4. Push the MENU SELECTOR to enable or disable the remote control.
The setting switches between ON/OFF each time you push the MENU SELECTOR.
5. To exit, press the MENU button.
 - If you set the remote to OFF in the menu and try to use it, the remote icon will the remote control icon will blink for 3 seconds and disappear on the LCD.

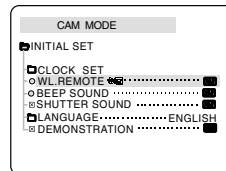
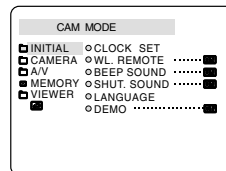

Advanced Recording

● BEEP SOUND (VP-D301i/D303i/D303Di/D305i/D307i only)

- ✦ The BEEP SOUND function works in CAMERA, PLAYER, M.REC, M.PLAY modes.
- ✦ Use the MENU to setup the BEEP SOUND function.
 - Select whether or not you want to hear a beep sound whenever you change a setup value.

1. Press the MENU button.
 - The menu list will appear.
2. Move the MENU SELECTOR to highlight INITIAL and push the MENU SELECTOR.
3. Use the MENU SELECTOR to select BEEP SOUND from the submenu.
4. Push the MENU SELECTOR to enable or disable the BEEP SOUND.

The setting switches between ON/OFF each time you push the MENU SELECTOR.

 - You will hear a Beep Sound when you select the ON setup.
 - When you press the START/STOP button to start recording, the BEEP SOUND is automatically set to OFF so you can't hear it any longer.
5. To exit, press the MENU button.

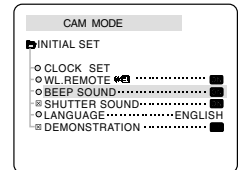
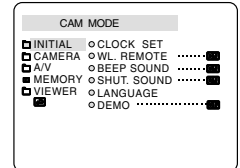

Advanced Recording

● SHUTTER SOUND (VP-D303i/D303Di/D305i/D307i only)

- ❖ You can hear SHUTTER SOUND only when the PHOTO function is working.
- ❖ Determines whether or not you wish to hear a SHUTTER SOUND when using the DSC feature.

1. Set the mode switch to Memory Card.
2. Set the power switch to CAMERA mode .
3. Press the MENU button.
 - The menu list will appear.
4. Move the MENU SELECTOR to highlight INITIAL and push the MENU SELECTOR.
5. Use the MENU SELECTOR to select SHUTTER SOUND from the submenu.
6. Push MENU SELECTOR to switch between ON and OFF.
7. To exit, press the MENU button.

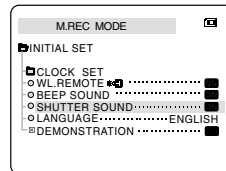
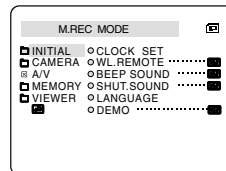

Advanced Recording

● DEMONSTRATION

- ❖ Demonstration automatically shows you the major functions that are included with your camcorder so that you may use them more easily.
- ❖ The DEMONSTRATION function may only be used in the CAMERA mode without a tape inserted in the camcorder.
- ❖ The demonstration operates repeatedly until the DEMONSTRATION mode switched OFF.

1. Set the camcorder to CAMERA mode.
2. Press the MENU button.
 - The menu list will appear.
3. Move the MENU SELECTOR to highlight INITIAL and push the MENU SELECTOR.
4. Select DEMONSTRATION from the submenu and push the MENU SELECTOR.
5. To activate the DEMONSTRATION, set DEMONSTRATION ON.
 - Press the menu button to quit the menu.
 - The demonstration will begin.
6. To end the DEMONSTRATION, set the DEMONSTRATION to OFF.

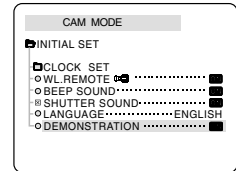
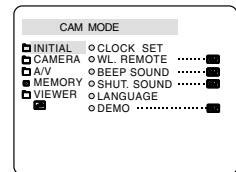

Notes

- The DEMONSTRATION function only works without a TAPE installed.
- The DEMONSTRATION mode is automatically activated when the camcorder is left idle for more than 10 minutes after switching to the CAMERA mode (no tape is inserted in the camcorder).
- If you press other buttons (FADE, BLC, PHOTO, EASY) during the DEMONSTRATION mode, the DEMONSTRATION stops temporarily and resumes 10 minutes later if you do not operate any other functions.
- While setting the NIGHT CAPTURE to ON, the DEMONSTRATION function does not work.

Advanced Recording

● PROGRAM AE

- ❖ The PROGRAM AE function works in CAMERA mode only.
- ❖ The PROGRAM AE mode allows you to adjust shutter speeds and apertures to suit different recording conditions.
- ❖ They give you creative control over the depth of field.

■ AUTO mode

- Auto balance between the subject and the background.
- To be used in normal conditions.
- The shutter speed automatically varies from 1/50 to 1/250 per second, depending on the scene.

■ SPORTS mode (🏆)

- For recording people or objects moving quickly.

■ PORTRAIT mode (👤)

- For focusing on the background of the subject, when the background is out of focus.
- The PORTRAIT mode is most effective when used outdoors.
- The shutter speed automatically varies from 1/50 to 1/1000 per second.

■ SPOTLIGHT mode (🎯)

- For recording correctly when there is only light on the subject and not the rest of the picture.

■ SAND/SNOW mode (🌨)

- For recording when people or objects are darker than the background because of reflected light from sand or snow.

■ High S. SPEED(High Shutter Speed) mode (🏏)

- For recording fast-moving subjects such as players in golf or tennis games.

Advanced Recording

Setting the PROGRAM AE

1. Press the MENU button.
 - The menu list will appear.
2. Move the MENU SELECTOR to highlight CAMERA and push the MENU SELECTOR.
3. Select PROGRAM AE from the submenu.
4. Push the MENU SELECTOR to enter the submenu.
5. Using the MENU SELECTOR, select the PROGRAM AE mode.
 - Push the MENU SELECTOR to confirm the program AE mode.
6. To exit, press the MENU button.

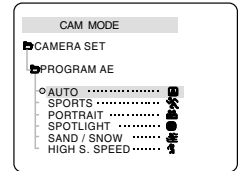
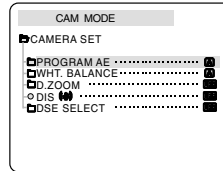
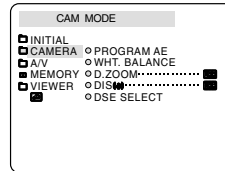

Notes

- While setting the NIGHT CAPTURE to ON, the PROGRAM AE function does not work.
- The PROGRAM AE function will not operate in EASY mode.

Advanced Recording

● WHT. BALANCE (WHITE BALANCE)

- ❖ The WHITE BALANCE function works in CAMERA or M.REC mode only.
- ❖ The WHITE BALANCE is a recording function that preserves the unique image colour of the object in any recording condition.
- ❖ You may select the appropriate WHITE BALANCE mode to obtain good quality image colour.
 - AUTO (☑) : This mode is generally used to control the WHITE BALANCE automatically.
 - HOLD (☛) : This fixes the current WHITE BALANCE value.
 - INDOOR (☛) : This controls the WHITE BALANCE according to the indoor ambience.
 - Under halogen or studio/video lighting
 - Subject is of one dominant colour
 - Close ups
 - OUTDOOR (☛) : This controls the WHITE BALANCE according to the outdoor ambience.
 - In daylight, especially for close up and where the subject is of one dominant colour.

1. Set the camcorder to CAMERA mode.
2. Press the MENU button.
 - The menu list will appear.
3. Move the MENU SELECTOR to highlight CAMERA and push the MENU SELECTOR.
4. Select WHT.BALANCE from the submenu.
5. Push the MENU SELECTOR to enter the sub-menu.
6. Using the MENU SELECTOR, select the WHITE BALANCE mode.
 - Push the MENU SELECTOR to confirm the WHITE BALANCE mode.
7. To exit, press the MENU button.

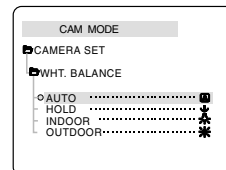
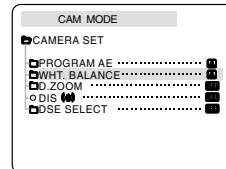
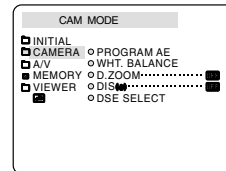

Notes

- When NIGHT CAPTURE is set to ON, the WHT.BALANCE function does not work.
- The WHT.BALANCE function will not operate in EASY mode.
- Turn the digital zoom off (if necessary) to set a more accurate white balance.
- Reset the white balance if lighting conditions change.
- During normal outdoor recording, setting to AUTO may provide better results.

Advanced Recording

Zooming In and Out

- ❖ Zooming is a recording technique that lets you change the size of the subject in a scene. For more professional looking recordings, do not use the zoom function too often.
 - ❖ You can zoom using variable zoom speeds.
 - ❖ Use these features for different shots. Please note that over-use of the zoom feature can lead to unprofessional looking results and a reduction of battery usage time.
1. Move the zoom lever slightly for a gradual zoom, move it further for a high-speed zoom. Your zooming is monitored on the OSD.
 2. T(Telephoto) side: Subject appears closer.
 3. W(Wide angle) side: Subject appears farther away.
 - You can record a subject that is about 10mm (about 0.5 inch) away from the lens surface in the WIDE position.

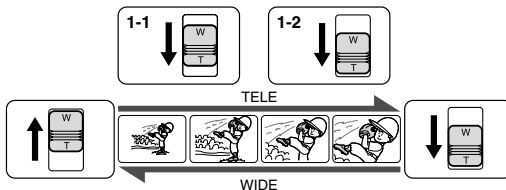

Tele MACRO

- ❖ Tele Macro Function works in both CAMERA and M.REC mode.
 - ❖ Effective focal distance in MACRO mode is 50 Cm (19.7 inches) ~ 100 Cm (39.4 inches).
1. Press the MACRO button.
 - MACRO Icon (📷) will be displayed.
 2. If you want to cancel the Tele Macro function, press the MACRO button again.

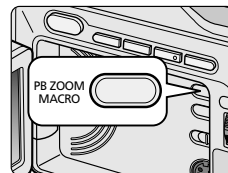

Notes

- When recording in MACRO Mode, the FOCUS speed may be slow.
- When you operate the ZOOM function in the TELE MACRO mode, then the recording subject may be out of focus.
- Use a tripod to prevent hand shake in the TELE MACRO mode.
- Avoid shadows when recording in the TELE MACRO mode.
- As the distance to the subject decreases, focusing area narrows.
- When you can not get proper focus, use the Zoom Lever.

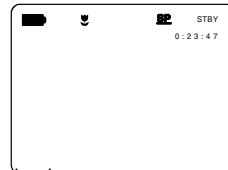

Advanced Recording

Zooming In and Out with DIGITAL ZOOM

- ❖ Digital Zoom works in CAMERA mode only.

Digital Zoom

- ❖ Zooming more than 20x is achieved digitally.
- ❖ The picture quality may deteriorate depending on how much you zoom in on the subject.
- ❖ We recommend that you use the DIS feature with DIGITAL ZOOM for picture stability. (see page 49)

1. Set the camcorder to CAMERA mode.
2. Press the MENU button.
 - The menu list will appear.
3. Move the MENU SELECTOR to CAMERA and push the MENU SELECTOR.
4. Select D.ZOOM from the submenu.
5. Push the MENU SELECTOR to setup the 100x, 200x, 400x, 900x digital zoom function or to turn the feature OFF.
6. To exit, press the MENU button.

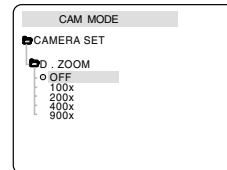
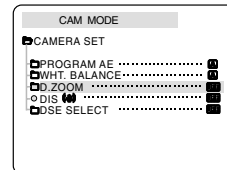
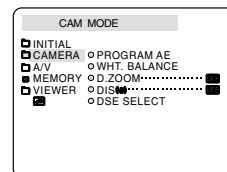

Advanced Recording

● DIS (Digital Image Stabilizer)

- ❖ The DIS function works in CAMERA mode only.
- ❖ DIS (Digital Image Stabilizer) is a function that compensates for any shaking or hand movement while holding the camcorder (within reasonable limits).
- ❖ It provides more stable pictures when:
 - Recording with the zoom
 - Recording a small object close-up
 - Recording and walking at the same time
 - Recording through the window of a vehicle

1. Set the camcorder to CAMERA mode.
2. Press the MENU button.
 - The menu list will appear.
3. Move the MENU SELECTOR highlight to CAMERA and push the MENU SELECTOR.
 - The sub menu list will appear.
4. Move the MENU SELECTOR to activate the DIS function, push the MENU SELECTOR.
 - The DIS menu is changed to ON.
 - If you do not want to use the DIS function, set the DIS menu to OFF.
5. To exit, press the MENU button.

Notes

- It is recommended that you deactivate the DIS function when using a tripod.
- If you use the DIS function, the picture quality may deteriorate.

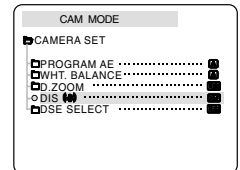
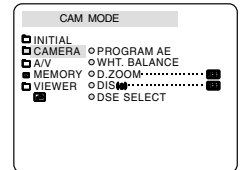

Advanced Recording

● DSE(Digital Special Effects) SELECT

- ❖ The DSE function works in CAMERA mode only.
- ❖ The digital effects enable you to give a creative look to your recording by adding various special effects.
- ❖ Select the appropriate digital effect for the type of picture that you wish to record and the effect you wish to create.
- ❖ There are 9 DSE modes.

- a. ART mode
This mode gives the images a coarse effect.
- b. MOSAIC mode
This mode gives the images a mosaic effect.
- c. SEPIA mode
This mode gives the images a reddish-brown pigment.
- d. NEGA mode
This mode reverses the colours, of the images, creating a negative image.
- e. MIRROR mode
This mode cuts the picture in half, using a mirror effect.
- f. BLK & WHT mode
This mode changes the images to black and white.
- g. EMBOSS mode
This mode creates a 3D effect (embossing).
- h. CINEMA mode
This mode covers the upper/lower portions of the screen to give a cinematic effect.
- i. MAKE - UP mode
This mode allows the images to be selected in red, green, blue or yellow.

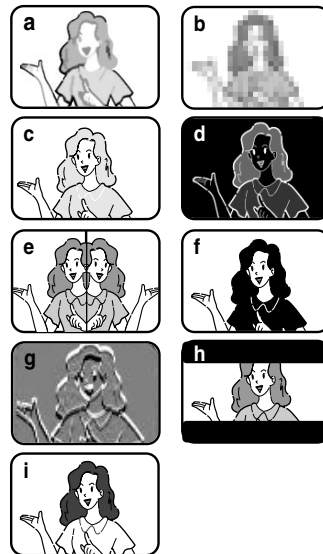

Advanced Recording

Selecting an effect

1. Set the camcorder to CAMERA mode.
2. Press the MENU button.
 - The menu list will appear.
3. Move the MENU SELECTOR to highlight CAMERA and push the MENU SELECTOR.
4. Select DSE SELECT from the submenu.
5. Push the MENU SELECTOR to enter the submenu.
6. Using MENU SELECTOR, select the DSE mode.
 - Push the MENU SELECTOR to confirm the DSE mode.
7. To exit, press the MENU button.

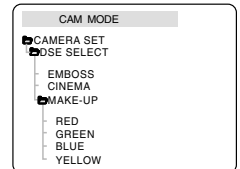
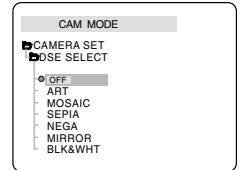
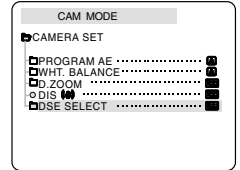
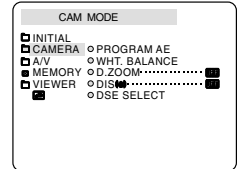

Notes

- While setting the NIGHT CAPTURE to ON, the DSE function does not work.
- The DSE function will not operate in EASY mode.

Advanced Recording

● REC MODE

- ❖ The REC MODE function works in both CAMERA and PLAYER (VP-D301i/D303i/D303Di/D305i/D307i only) modes.
- ❖ This camcorder records and plays back in SP (standard play) mode and in LP (long play) mode.
 - SP (standard play): This mode permits 60 minutes of recording time with a DVM60 tape.
 - LP (long play): This mode permits 90 minutes of recording time with a DVM60 tape.

1. Set the camcorder to CAMERA or PLAYER (VP-D301i/D303i/D303Di/D305i/D307i only) mode.
2. Press the MENU button.
 - The menu list will appear.
3. Move the MENU SELECTOR to highlight A/V and push the MENU SELECTOR.
4. Select REC MODE from the submenu and push the MENU SELECTOR.
 - The REC MODE toggles between SP and LP with each press.
5. To exit, press the MENU button.

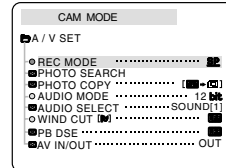
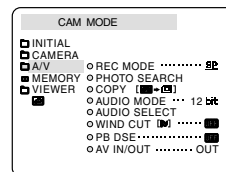

Notes

- We recommend that you use this camcorder to play back any tapes recorded on this camcorder.
Playing back a tape recorded in other equipments may produce mosaic shaped distortion.
- When you record a tape in SP and LP modes, or LP mode only, the playback picture may be distorted or the time code may not be written properly between scenes.
- Record using SP mode for best picture and sound quality.

Advanced Recording

● AUDIO MODE

- ❖ The AUDIO MODE function works in CAMERA and PLAYER (VP-D301i/D303i/D303Di/D305i/D307i only) modes.
- ❖ This camcorder records sound in two ways. (12bit, 16bit)
 - 12bit : You can record two 12bit stereo sound tracks.
The original stereo sound can be recorded onto the MAIN (SOUND1) track.
Additional stereo sound can be dubbed onto the SUB (SOUND2) track.
 - 16bit : You can record one high quality stereo sound using the 16bit recording mode.
Audio dubbing is not possible when using this mode.

1. Set the camcorder to CAMERA mode.
2. Press the MENU button.
 - The menu list will appear.
3. Move the MENU SELECTOR to highlight A/V and push the MENU SELECTOR.
4. Select the AUDIO MODE from the menu and push the MENU SELECTOR.
 - The AUDIO MODE toggles between 12bit-16bit with each push.
5. To exit, press the MENU button.

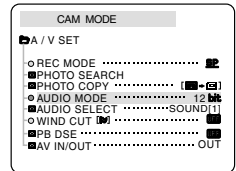
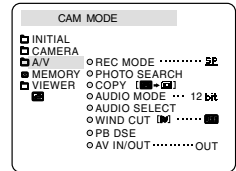

Advanced Recording

● WIND CUT

- ❖ The WIND CUT function works in CAMERA and PLAYER (Audio dubbing) modes.
- ❖ The WIND CUT function minimizes wind noise or other noise while recording.
 - When the wind cut is on, some low sounds are eliminated along with the sound of the wind.

1. Set the camcorder to CAMERA mode.
2. Press the MENU button.
 - The menu list will appear.
3. Move the MENU SELECTOR to highlight A/V and push the MENU SELECTOR.
4. Select WIND CUT from submenu.
5. This feature toggles ON/OFF each time you push the MENU SELECTOR.
 - **[W]** is shown in the display when you turn the WIND CUT on.
6. To exit, press the MENU button.

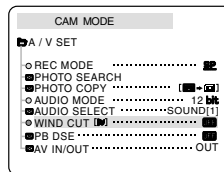
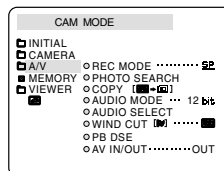

Notes

- Make sure WIND CUT is set to off when you want the microphone to be as sensitive as possible.
- Use the WIND CUT when recording in windy places such as the beach or near buildings.

Advanced Recording

● DATE/TIME

- ❖ The DATE/TIME function works in CAMERA, PLAYER, M.REC and M.PLAY modes.
- ❖ The date and time are automatically recorded on a special data area of the tape.

1. Press the MENU button.
 - The menu list will appear.
2. Move the MENU SELECTOR to highlight VIEWER and push the MENU SELECTOR.
3. Move the MENU SELECTOR to highlight DATE/TIME.
4. Push the MENU SELECTOR to select the sub-menu.
5. Using the MENU SELECTOR, select the DATE/TIME mode.
 - You can choose to display - OFF, DATE, TIME, DATE/TIME
 - OFF
 - DATE only
 - TIME only
 - DATE & TIME
 - To return to the previous menu, highlight the DATE/TIME in the middle of OSD and push the MENU SELECTOR.
6. To exit, press the MENU button.

Notes

- The DATE/TIME is not affected by the OSD ON/OFF (DISPLAY) button.
- The DATE/TIME will read "- -" in the following conditions.
 - During playback of a blank section of a tape.
 - If the tape was recorded before setting the DATE/TIME in the Camera's memory.
 - When the lithium battery becomes weak or dead.
- Before you use the DATE/TIME function, you must set the Clock.
See CLOCK SET on page 39.

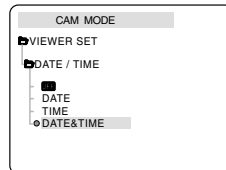
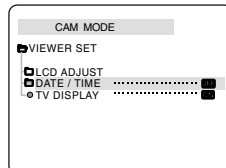
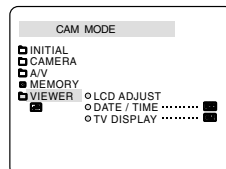

Advanced Recording

● TV DISPLAY

- ❖ The TV DISPLAY function works in CAMERA, PLAYER, M.REC and M.PLAY modes.
- ❖ You can select the output path of the OSD (On Screen Display).
 - OFF: The OSD appears in the LCD screen and Viewfinder only.
 - ON: The OSD appears in the LCD screen, Viewfinder and TV.
 - Use the DISPLAY button located at the left side of the camcorder to turn the OSD ON/OFF displayed on the LCD/Viewfinder/TV.

1. Set the camcorder to CAMERA, PLAYER, M.REC and M.PLAY mode.
2. Press the MENU button.
 - The menu list will appear.
3. Move the MENU SELECTOR to highlight VIEWER and push the MENU SELECTOR.
4. Select TV DISPLAY and push the MENU SELECTOR.
 - The DISPLAY mode switches between ON/OFF with each push.
5. To exit, press the MENU button.

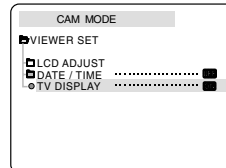
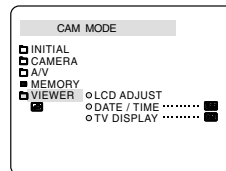

Advanced Recording

Using Quick Menu(Navigation Menu)

- ❖ Quick menu is available only in CAMERA and M.REC mode.
- ❖ Quick menu is used to adjust camera functions by using the MENU SELECTOR.
This feature is useful for when you want to make simple adjustments without having to access the menus and submenus.

■ DATE/TIME (see page 55)

- Each time you select DATE/TIME and push the MENU SELECTOR, it will be displayed in the order of DATE - TIME - DATE/TIME - OFF.

■ WL.REMOTE(📺)

- Each time you select WL.REMOTE and push the MENU SELECTOR, the WL.REMOTE is switched to either enabled (📺) or disabled (OFF).

■ DIS(🚫)

- Each time you select DIS and push the MENU SELECTOR, the DIS icon is displayed or set to OFF.

■ DSE(Digital Special Effect) (see page 50)

- Each time you select DSE and push the MENU SELECTOR, the DSE preset values are applied or set to OFF.
DSE values will not switch between On and Off if they have not been preset in the menu.

■ PROGRAM AE (see page 44)

- Each time you select PROGRAM AE and push the MENU SELECTOR, you can choose between the preset PROGRAM AE values and AUTO. You can't choose between Auto and the PROGRAM AE values if the values have not been preset in the regular menu.

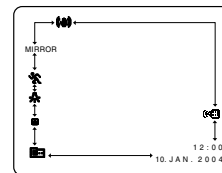

ENGLISH

Advanced Recording

■ WHT. BALANCE (see page 46)

- Each time you select WHT. BALANCE and push the MENU SELECTOR, you can choose between preset WHT.BALANCE values and AUTO. As in PROGRAM AE, you can't choose between Auto and WHT.BALANCE values if they have not been preset.

■ FOCUS (Auto Focus/Manual Focus) (see page 62)

- Each time you select FOCUS and push the MENU SELECTOR, the FOCUS is switched to either Manual Focus (MF) or Auto Focus (**A**).

■ SHUTTER SPEED & EXPOSURE

- You can set values for SHUTTER SPEED and EXPOSURE by selecting (**1/250**) icon and pushing the MENU SELECTOR. For more information, see the next page.

Setting the Quick menu

1. Set the camcorder to CAMERA mode.
2. Move the MENU SELECTOR to select a function you want and then push the MENU SELECTOR to change the values.

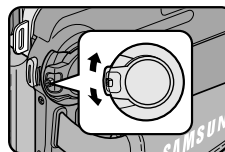

Notes

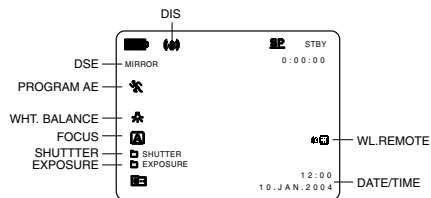

- Quick menu function will not operate in EASY mode.
- If you are using the M.FOCUS(MF) function, you cannot use the Quick menu. If you want to use the Quick menu function, release the M.FOCUS(MF) mode.



Advanced Recording

SHUTTER SPEED & EXPOSURE

- ❖ You can set SHUTTER SPEED only in CAMERA mode.
- ❖ The EXPOSURE function works in both CAMERA and M.REC modes.
- ❖ SHUTTER SPEED and EXPOSURE values can only be set in the Quick Menu.
- ❖ SHUTTER SPEED and EXPOSURE are automatically switched and/or deactivated.

1. Set the power switch to CAMERA mode.
2. Move the MENU SELECTOR until you see the  icon, and then push the MENU SELECTOR.
 - You see a screen on which you can select SHUTTER SPEED and EXPOSURE.
 - Move the MENU SELECTOR to select the item you want and then push the MENU SELECTOR.
 - SHUTTER SPEED can be set to 1/50, 1/120, 1/250, 1/500, 1/1000, 1/2000, 1/4000 or 1/10000.
 - EXPOSURE can be set between 00 and 29.
3. To exit from the setting screen, select the icon  and push the MENU SELECTOR.

Recommended Shutter speeds when recording

- ❖ Outdoor sports such as golf or tennis : 1/2000 or 1/4000.
- ❖ Moving cars or trains or other rapidly moving vehicles such as roller coasters : 1/1000, 1/500 or 1/250
- ❖ Indoor sports such as basketball : 1/120

Notes

- If you want to use the selected shutter speed and exposure value, you should begin the recording with the shutter speed and the exposure adjustment screens displayed on the LCD.
- If you manually change the shutter speed and the exposure value when Auto-exposure option is selected, manual changes are applied first.
- The image may not seem as smooth when a high shutter speed is set.
- The camcorder returns to the auto shutter setting and auto exposure setting when you set the NIGHT CAPTURE to ON, or change to the EASY, SLOW SHUTTER modes.
- When recording with a SHUTTER SPEED of 1/1000 or higher, make sure the sun is not shining into the lens.

Advanced Recording

SLOW SHUTTER (Low Shutter Speed)

- ❖ The SLOW SHUTTER function works in CAMERA mode only.
 - ❖ The shutter speed can be controlled, allowing you to record slow moving objects.
1. Set the power switch to CAMERA mode.
 2. Press the SLOW SHUTTER button.
 3. Each time you press the SLOW SHUTTER button, SHUTTER SPEED is changed to 1/25, 1/13, 1/6, off.
 4. To exit, press the SLOW SHUTTER button.

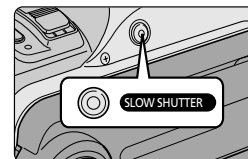

Notes

- When using "SLOW SHUTTER" the image takes on a slow motion like effect.
- The SLOW SHUTTER function will not operate in EASY mode.

Advanced Recording

EASY Mode (for Beginners)

- ❖ The EASY mode allows a beginner to easily make good recordings.
 - The EASY mode only operates in CAMERA mode.
1. Set the power switch to CAMERA mode.
 2. By pressing the EASY button, all functions on the camera will be set to off and the recording settings will be set to the following basic modes:
 - Battery level, recording mode, counter, DATE/TIME, and DIS (🔋) will be displayed.
 - The word "EASY.Q" will appear on the LCD at the same time.
However, the DATE/TIME will only be seen if it has been previously set. (see page 55)
 3. Press START/STOP to start recording.
 - Recording will begin using the basic automatic settings.
 4. Press the EASY button again in the STBY mode and then turns the EASY mode off.
 - The EASY function will not turn off while you are recording.
 - The camera will return to the settings that were set prior to activating EASY mode.



Notes

- In EASY mode, certain functions are not available, such as MENU, BLC, AF/MF.
 - If you want to use these functions, you must first switch the EASY mode off.
- The EASY mode settings are deleted when the battery pack is uninstalled from the camcorder and therefore, they must be reset when a battery pack has been replaced.

Advanced Recording

AF/MF (Auto Focus/Manual Focus)

- ❖ The AF/MF function works in CAMERA, M.REC mode only.
- ❖ In most situations, it is better to use the automatic focus feature, as it enables you to concentrate on the creative side of your recording.
- ❖ Manual focusing may be necessary under certain conditions that make automatic focusing difficult and/or unreliable.

Auto Focusing

- ❖ If you are inexperienced in the use of camcorders, we recommend that you make use of Auto Focus.

Manual Focusing

- ❖ In the following situations, you may obtain better results by adjusting the focus manually.
 - a. A picture containing several objects, some close to the camcorder, others further away.
 - b. A person enveloped in fog or surrounded by snow.
 - c. Very shiny or glossy surfaces like a car.
 - d. People or objects moving constantly or quickly like an athlete or a crowd.
1. Set the power switch to CAMERA mode.
 2. Move the MENU SELECTOR up or down until the FOCUS is highlighted and then push the MENU SELECTOR.
 - M. FOCUS(MF) will display.
 3. Move the MENU SELECTOR up or down until the object is in focus.
 - Zoom out a little if focusing is difficult.
 4. To return to AF (Auto Focus: **A**), push the MENU SELECTOR again.

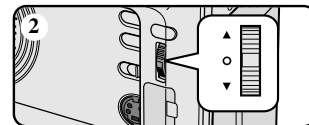
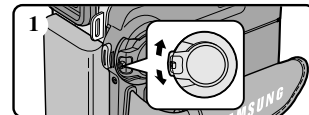
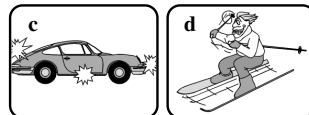
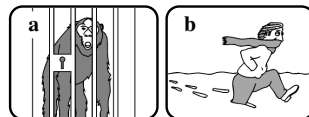

Advanced Recording

BLC (Back Light Compensation)

- ❖ BLC works in CAMERA/M.REC mode.
- ❖ Back lighting exists when the subject is darker than the background:
 - The subject is in front of a window.
 - The person to be recorded is wearing white or shiny clothes and is placed against a bright background; the person's face is too dark to distinguish his/her features.
 - The subject is outdoors and the background is overcast.
 - The light sources are too bright.
 - The subject is against a snowy background.

1. Set the power switch to CAMERA mode.
2. Press the BLC button.
 - Normal - BLC - Normal
 - BLC enhances the subject.

Notes

- When NIGHT CAPTURE to set to ON, the BLC function does not work.
- The BLC function will not operate in EASY mode.

* BLC off

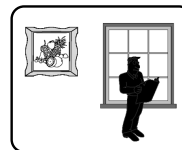

* BLC on

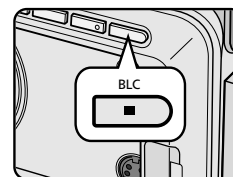
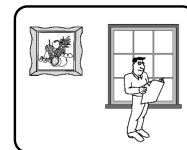

Advanced Recording

Fade In and Out

- ❖ The FADE function works in CAMERA mode only.
- ❖ You can give your recording a professional look by using special effects such as fade in at the beginning of a sequence or fade out at the end of a sequence.

To Start Recording

1. Before recording, hold down the FADE button.
The picture and sound gradually disappear (fade out).
2. Press the START/STOP button and at the same time release the FADE button. Recording starts and the picture and sound gradually appear (fade in).

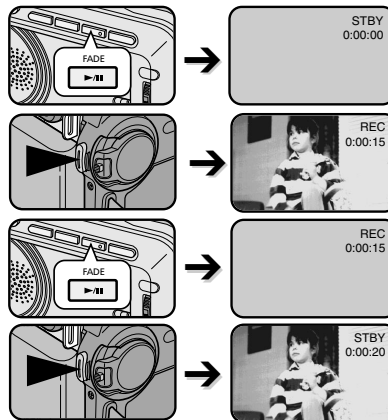

To Stop Recording (use FADE IN / FADE OUT)

3. When you wish to stop recording, hold down the FADE button.
The picture and sound gradually disappear (fade out).
4. When the picture has disappeared, press the START/STOP button to stop recording.

a. FADE OUT

(Approx. 4 seconds)

b. FADE IN

(Approx. 4 seconds)

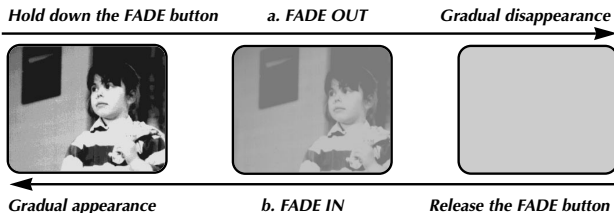

Advanced Recording

Audio dubbing

- ❖ The AUDIO DUBBING function only works in PLAYER Mode.
- ❖ You can add sound to the original sound on a pre-recorded tape, recorded in SP mode with 12bit sound.
- ❖ Use the internal and external microphones or other audio equipment.
- ❖ The original sound will not be erased.

Dubbing sound

1. Set the camcorder to PLAYER mode.
 - If you want to use an external microphone, connect the microphone to the external MIC input jack on the camcorder.
 - When you wish to dub using the External A/V input, connect the AUDIO/VIDEO cable to the camcorder by inserting the AUDIO/VIDEO cable into the AV Jack at the right side of the camcorder. (VP-D301i/D303i/D303Di/D305i/D307i only)
 - Press the MENU button, move the MENU SELECTOR to highlight A/V and push the MENU SELECTOR.
 - Move the MENU SELECTOR to highlight AV IN/OUT and push the MENU SELECTOR to select AV IN.
2. Press the ►/|| (PLAY/STILL) button and find the timeframe of the scene to be dubbed.
3. Press the ►/|| (PLAY/STILL) button to pause the scene.
4. Press the A.DUB button on the Remote Control.
 - A.DUB will be displayed on the LCD.
 - The camcorder is in a ready-to-dub state for dubbing.
5. Press the ►/|| (PLAY/STILL) button to start dubbing.
 - Press the ■ (STOP) button to stop the dubbing.

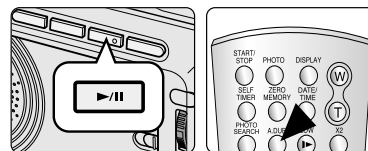
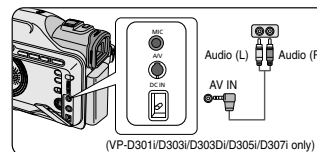
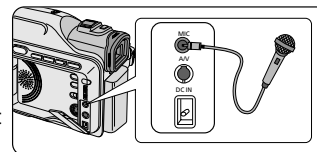

Notes

- You can not use the audio dubbing function while playing a write protected video tape.
- When you wish to dub using the External A/V input, you must connect the AUDIO/VIDEO cable to the audio system from which you wish to record. (VP-D301i/D303i/D303Di/D305i/D307i only)
- You cannot dub sound on a pre-recorded tape in LP mode or 16 bit mode.

Advanced Recording

Dubbed audio Playback

1. Insert the dubbed tape and press MENU button.
2. Move the MENU SELECTOR to highlight A/V.
3. Push the MENU SELECTOR to enter the sub-menu.
4. Use the MENU SELECTOR to select AUDIO SELECT from the submenu.
5. Push the MENU SELECTOR to enter the sub-menu.
6. Using the MENU SELECTOR, select the AUDIO playback channel.
 - Push the MENU SELECTOR to confirm the audio playback channel.
 - SOUND1 : play the original sound.
 - SOUND2 : play the dubbed sound.
 - MIX(1+2) : play back SOUND1 and 2 equally mixed.
7. To exit, press the MENU button.
8. Press the ►/|| (PLAY/STILL) button to playback the dubbed tape.

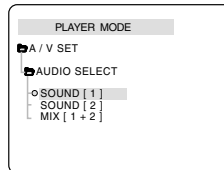
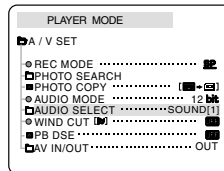

Note

When you playback added sound (SOUND2 or MIX mode), you may experience loss of sound quality.

Advanced Recording

PHOTO Image Recording

1. Set the power switch to CAMERA mode.
2. Press the PHOTO button.
 - The still picture is recorded for about 6~7 seconds.
3. After the PHOTO has been recorded, the camcorder returns to STBY mode.

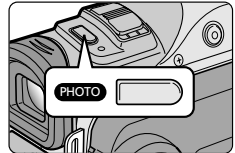

Searching for a PHOTO picture

- ♣ The PHOTO SEARCH works in PLAYER mode only.
1. Press the MENU button.
 - The MENU list will appear.
 2. Move the MENU SELECTOR to highlight A/V.
 3. Push the MENU SELECTOR to enter the submenu.
 4. Select PHOTO SEARCH from the submenu and push the MENU SELECTOR.
 - You can also press the PHOTO SEARCH button on the remote control.
 5. Search the PHOTO using the ►► (FF) and ◀◀ (REW) buttons.
 - The PHOTO search process appears on the LCD while you are searching.
 - After completing the search, the camcorder displays the still image.
 6. To exit, press the ■ (STOP) button.

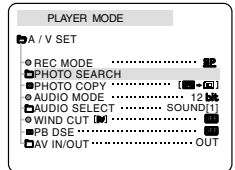
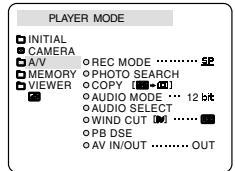

Advanced Recording

NIGHT CAPTURE (0 lux recording)

- ❖ The NIGHT CAPTURE function works in CAMERA/M.REC mode.
 - ❖ The NIGHT CAPTURE function enables you to record a subject in darkness.
1. Set the camcorder to CAMERA mode.
 2. Slide the NIGHT CAPTURE switch to ON.
 -  (NIGHT CAPTURE indicator) appears on the LCD monitor.
 - The infrared(invisible rays) light is turned on automatically.
 3. To cancel the NIGHT CAPTURE function, slide the NIGHT CAPTURE switch to OFF.

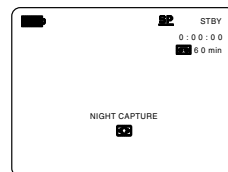
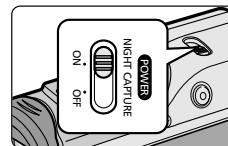

Notes

- The maximum recording distance using the infrared light is about 3 m (about 10 feet).
- If you use the NIGHT CAPTURE function in normal recording situations (ex. outdoors by day), the recorded picture may be tinted green.
- In the NIGHT CAPTURE mode, certain functions are not available, such as White Balance, Program AE, DSE, BLC.
- If focusing is difficult with the auto focus mode when using the NIGHT CAPTURE function, focus manually.
- Do not cover the Infrared Light with the hand.

Advanced Recording

POWER NIGHT CAPTURE

- ❖ The POWER NIGHT CAPTURE function works in CAMERA mode.
- ❖ The POWER NIGHT CAPTURE function can record a subject more brightly in darkness than the NIGHT CAPTURE function.
- ❖ A POWER NIGHT CAPTURE is displayed for three seconds by LCD if you press a SLOW SHUTTER button in state that a NIGHT CAPTURE switch is turned on.
- ❖ When you work in POWER NIGHT CAPTURE mode, POWER NIGHT CAPTURE icon appears on the LCD continuously.

1. Set the camcorder to CAMERA mode.
2. Turn on the NIGHT CAPTURE switch, and then press the SLOW SHUTTER button.
3. Press the SLOW SHUTTER button to set shutter speed.
The SLOW SHUTTER function enables you to record a subject more brightly.
4. When using POWER NIGHT CAPTURE the image takes on a slow motion like effect.
5. To cancel the POWER NIGHT CAPTURE function, press the SLOW SHUTTER button to set to "off" and then turn off the NIGHT CAPTURE switch.

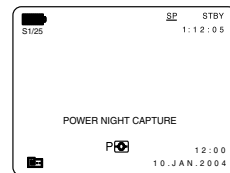

Notes

- The maximum recording distance using the infrared light is about 3 m (about 10 feet).
- If you use the POWER NIGHT CAPTURE function in normal recording situations (ex. outdoors by day), the recorded picture may contain unnatural colours.
- In the POWER NIGHT CAPTURE mode, certain functions are not available, such as White Balance, Program AE, DSE, BLC.
- When the subject is too bright, press the SLOW SHUTTER button (1/25 → 1/6) to obtain better quality recordings.

Advanced Recording

Various Recording Techniques

❖ In some situations different recording techniques may be required for more dramatic results.

Note

Please rotate the LCD screen carefully as excessive rotation may cause damage to the inside of the hinge that connects the LCD screen to the Camcorder.

1. General recording.



2. Downward recording.

Making a recording with a top view of the LCD screen.

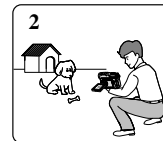

3. Upward recording.

Making a recording viewing the LCD screen from below.

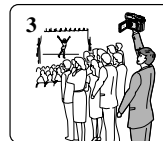

4. Self recording.

Making a recording viewing the LCD screen from the front.



5. Recording with the Viewfinder.

- In circumstances where it is difficult to use the LCD monitor, the viewfinder can be used as a convenient alternative.



Playback

Tape Playback

- ❖ The playback function works in PLAYER mode only.

Playback on the LCD

- ❖ It is practical to view a tape using the LCD when in a car or outdoors.

Playback on a TV monitor

- ❖ To play back a tape, the television must have a compatible colour system.
- ❖ We recommend that you use the AC Power Adapter as the power source for the camcorder.

Connecting to a TV which has Audio/Video input jacks

1. Connect the camcorder and TV with the AUDIO/VIDEO cable.
 - The yellow plug : Video
 - The white plug : Audio(L)-mono
 - The red plug : Audio(R) - STEREO only
 - If you connect to a monaural TV or VCR, connect the yellow plug (Video) to the video input of the TV or VCR and the white plug (Audio L) to the audio input of the TV or VCR.
- ❖ You may use the SCART adapter (optional).
2. Set the power switch on the camcorder to PLAYER mode.
3. Turn on the TV and set the TV/VIDEO selector on the TV to VIDEO.
 - Refer to the TV or VCR user's manual.
4. Play the tape.

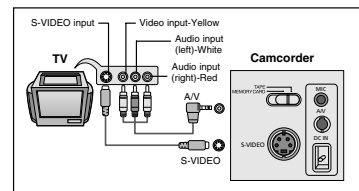

Notes

- You may use an S-VIDEO (optional) cable to obtain better quality pictures if you have a S-VIDEO connector on your TV.
- Even if you use an S-VIDEO (optional) cable, you need to connect an audio cable.
- If you connect the cable to the AV Jack, you will not hear sound from the Camcorder's speakers.

Playback

Connecting to a TV which has no Audio and Video input jacks

❖ You can connect your camcorder to a TV through a VCR.

1. Connect the camcorder and VCR with the AUDIO/VIDEO cable.
 - The yellow plug : Video
 - The white plug : Audio(L) - Mono
 - The red plug : Audio(R)
2. Connect a TV to the VCR.
3. Set the power switch on the camcorder to PLAYER mode.
4. Turn on both the TV and VCR.
 - Set the input selector on the VCR to LINE.
 - Select the channel reserved for your VCR on the TV set.
5. Play the tape.

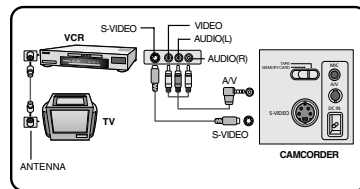

Playback

❖ You can play the recorded tape in PLAYER mode.

1. Connect a power source and set the power switch to PLAYER mode.
2. Insert the tape you wish to play back.
3. Using the ►► (FF) and ◀◀ (REW) buttons, find the first position you wish to play back.
4. Press the ►/|| (PLAY/STILL) button.
 - The images you recorded will appear on the TV after a few seconds.
 - If a tape reaches its end while being played back, the tape will rewind automatically.

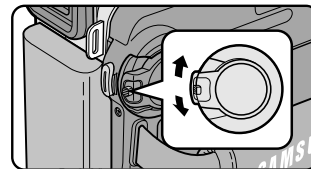

Note

- The playback mode (SP/LP) is selected automatically.

Playback

Various Functions while in **PLAYER** mode

- ❖ The PLAY/STILL, STOP, FF, REW buttons are located on the camcorder and the Remote Control.
- ❖ The F.ADV(Frame advance), X2, SLOW buttons are located on the Remote Control only.
- ❖ To prevent tape and head-drum wear, your camcorder will automatically stop if it is left in STILL or SLOW modes for more than 5 minutes.

Playback pause

- ❖ Press the ►/|| (PLAY/STILL) button during Playback.
- ❖ To resume playback, press the ►/|| (PLAY/STILL) button.

Picture search (Forward/Reverse)

- ❖ Press the ►► (FF) or ◀◀ (REW) buttons during Playback or Still mode.
To resume normal playback, press the ►/|| (PLAY/STILL) button.
- ❖ Keep pressing ►► (FF) or ◀◀ (REW) buttons during Playback or Still mode.
To resume normal playback, release the button.

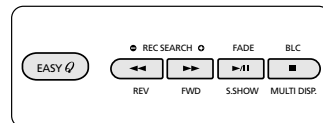

Slow playback (Forward/Reverse)

- ❖ Forward Slow Playback
 - Press the SLOW button on the remote control during Playback.
 - To resume normal playback, press the ►/|| (PLAY/STILL) button.
- ❖ Reverse Slow Playback
 - Press the ◀◀ (-) button during Forward Slow Play back.
 - To resume forward slow playback, press the ►► (+) button.
 - To resume normal playback, press the ►/|| (PLAY/STILL) button.

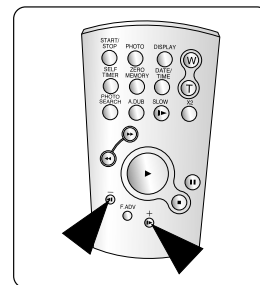

ENGLISH

Playback

Frame advance (To play back frame by frame)

- Press the F.ADV button on the Remote Control while in Still mode. The F.ADV function works in still mode only.
- To resume normal playback, press the ►/|| (PLAY/STILL) button.
 - ❖ Forward frame advance
 - Press the F.ADV button on the remote control in Still mode.
 - ❖ Reverse frame advance
 - Press ◀|| (-) the button on the remote control to change the direction in F.ADV mode.
 - Press the F.ADV button on the remote control.

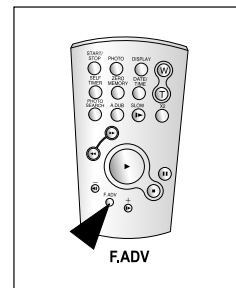

X2 Playback (Forward/Reverse)

- ❖ Forward X2 Playback
 - Press the X2 button on the Remote Control during Playback.
 - To resume normal playback, press the ►/|| (PLAY/STILL) button.
- ❖ Reverse X2 Playback
 - Press ◀|| (-) the button during during Forward X2 Playback
 - To resume normal playback, press the ►/|| (PLAY/STILL) button.

Reverse playback

- ❖ To playback in reverse at normal speed, press the ◀|| (-) button during normal forward playback.
- ❖ Press the ►/|| (PLAY/STILL) or ►/|| (+) button to return to normal forward playback.

Notes

- Mosaic shaped distortion may appear on the screen while in some of the various playback modes.
 - Mosaic shaped distortion or noise may be experienced when you play back tapes recorded in LP which contain various playback functions.
- Sound will only be heard during normal SP or LP playback.

Playback

ZERO MEMORY

- ❖ The ZERO MEMORY function works in both CAMERA and PLAYER modes.
 - ❖ You can mark a point on a tape that you want to return to following playback.
1. Press the ZERO MEMORY button on the remote control before the recording or during playback at the point you wish to return.
 - The time code is changed to a tape counter that is set to zero memory with the **M** 0:00:00(Zero memory indicator)
 - If you want to cancel the zero memory function, press the ZERO MEMORY button again.
 2. Finding the zero position.
 - When you have finished playback, fast forward or rewind the tape.
 - The tape stops automatically when it reaches the zero position.
 - When you have finished recording, press the power switch on the PLAYER and press the **◀** (REW) button.
 - The tape stops automatically when it reaches the zero position.
 3. The tape counter with the **M** (Zero memory indicator) disappears from the display and the tape counter is changed to the time code.

Notes

- In the following situations, ZERO MEMORY mode may be canceled automatically:
 - At the end of the section marked with the ZERO MEMORY function.
 - When the tape is ejected.
 - When you remove the battery pack or power supply.
- The zero memory may not function correctly where there is a break between recordings on the tape.

Playback

PB DSE (Playback Digital Special Effects)

- ❖ The PB DSE function works in PLAYER mode.
- ❖ The PB DSE function enables you to apply Digital Special Effects (DSE) to tape playback or still images.

1. Set the camcorder to the PLAYER mode and then play back a tape.
2. Press the MENU button and move the MENU SELECTOR to highlight AV.
3. Push the MENU SELECTOR to enter the sub-menu.
4. Select PB DSE from the sub-menu and push the MENU SELECTOR.
5. Push the MENU SELECTOR to enter the sub-menu.
6. Select PB DSE item (off, mirror, mosaic) from the sub-menu and push the MENU SELECTOR.
7. To exit, press the MENU button.
8. To cancel the PB DSE function, set the PB DSE to off or press the STOP button.

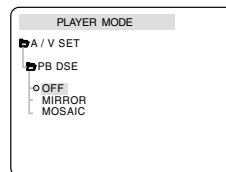
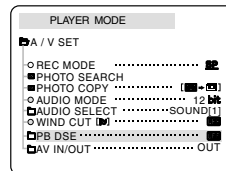
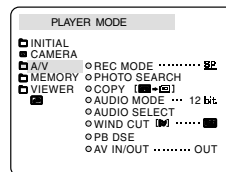

Notes

- You cannot apply the PB DSE function to the pictures which are being input from an external source.
- Once you modify an image using the PB DSE function, it cannot be imported to your PC from the camcorder's DV jack.

Playback

PB ZOOM

- ❖ The PB ZOOM function works in PLAYER mode.
 - ❖ The PB ZOOM function enables you to magnify playback or still image.
1. Press the PB ZOOM button in playback mode or in playback still mode.
 2. The image is magnified starting from the center of image and arrows appear which allow you to move the image in four directions.
 3. You can zoom in from 1.2x to 8.0x by moving the zoom lever.
 4. You can move the image in the arrow directions using the MENU SELECTOR.
 5. You can change the arrow direction(vertical, horizontal) by pushing the MENU SELECTOR.
 6. To cancel the PB ZOOM function, press the PB ZOOM or STOP button.

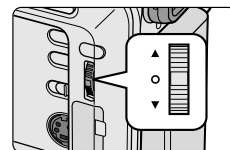
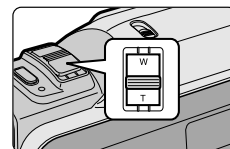
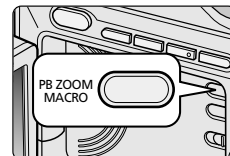

Notes

- You cannot apply the PB ZOOM function to pictures which are being input from an external video source.
- The PB ZOOM image cannot be imported to your PC from the camcorder's DV jack.

Recording in PLAYER mode (VP-D301i/D303i/D303Di/D305i/D307i only)

Recording in PLAYER mode

- ❖ You can use this camcorder as a recorder.
- ❖ You can record a tape from VCR or TV.

1. Connect the camcorder and VCR or TV with the AUDIO/VIDEO cable.
2. Set the power switch of the camcorder to PLAYER mode.
3. Turn on the VCR or TV.
4. Insert the blank tape with protection tab closed into the camcorder.
 - If you want to record from a connected VCR, insert a recorded VHS tape into the VCR.
5. Press the MENU button, move the MENU SELECTOR to highlight A/V and push the MENU SELECTOR.
6. Move the MENU SELECTOR to highlight AV IN/OUT and push the MENU SELECTOR to select AV IN.
 - "AV IN" and picture appear on the LCD monitor.
 - OUT: Release the INPUT mode.
7. Press the START/STOP button to set the camcorder to REC PAUSE mode.
 - "PAUSE" on the LCD monitor.
8. Select the TV program or playback the VHS tape.
9. Press START/STOP button to start recording.
 - If you want to pause recording for a while, press the START/STOP button again.
10. To stop recording, press the ■ (STOP) button.

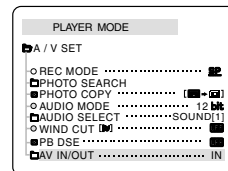
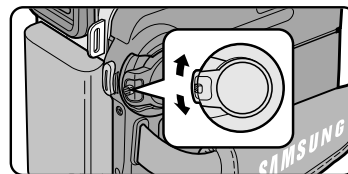
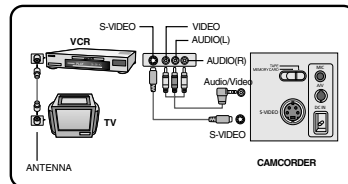

Notes

- When you record the images being played back on analog VCR, if they are not being played back in normal speed, (for example, more than double speed or slow playback), only gray image appears on the camcorder.
- If you want to see the camcorder picture with a TV set AV IN/OUT menu to OUT.

IEEE 1394 Data Transfer

Transferring IEEE1394 (i.LINK)-DV standard data connections

Connecting to a DV device

- ❖ Connecting with other DV standard products.
 - A standard DV connection is quite simple.
If a product has a DV port, you can transfer data by connecting to the DV port using the correct cable.
!!! Please be careful since there are two types of DV ports, (4pin, 6pin). This camcorder has a 4pin terminal.
- ❖ With a digital connection, video and audio signals are transmitted in digital format, allowing high quality images to be transferred.

Connecting to a PC

- ❖ If you want to transmit data to a PC, you must install a IEEE 1394 add-on card onto the PC. (not supplied)
- ❖ The frame rate recorded for video capturing is dependent on the capacity of the PC.

Notes

- When you transmit data from the camcorder to another DV device, some functions may not work.
If this occurs, please reconnect the DV cable or turn the power OFF and ON again.
- When you transmit data from the camcorder to PC, PC function button is not available in M.PLAY mode.
- Do not use the camcorder and IEEE1394 together as this will cause IEEE1394 to shut off.

IEEE 1394 Data Transfer

● System requirements

- CPU : faster Intel® Pentium III™ 450Mhz compatible.
- Operating system : Windows® 98SE, ME, XP, Mac OS (9.1~10.2)
- Main memory : more than 64 MB RAM
- IEEE1394 add-on card or built in IEEE1394 card

Recording with a DV connection cable (VP-D301i/D303i/D303Di/D305i/D307i only)

1. Set the power switch to PLAYER mode.
2. Connect the DV cable (not supplied) from the DV IN/OUT port of the camcorder to the DV IN/OUT port of the other DV device.
 - Make sure that DV IN appears on the screen.
3. Press the START/STOP button to begin REC PAUSE mode.
 - PAUSE is displayed on the OSD.
4. Start playback on the other DV device while you monitor the picture.
5. Press the START/STOP button to start recording.
 - If you want to pause recording momentarily, press the START/STOP button again.
6. To stop recording, press the ■ (STOP) button.

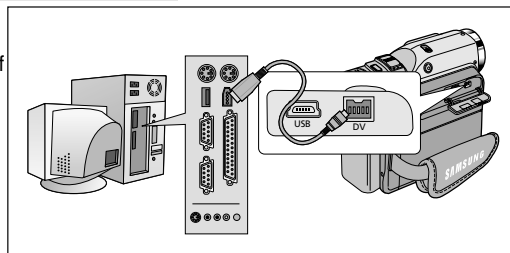

Notes

- When using this camcorder as a recorder, the pictures that appear on a monitor may seem uneven, however recorded pictures will not be affected.
- Operations are not guaranteed for all the recommended computer environments mentioned above.

USB interface

● Transferring a Digital Image through a USB Connection

- ❖ You can easily transfer a still image from a Memory Card to a PC without additional add-on cards via a USB connection.
- ❖ You can transfer an image to a PC via a USB connection.
- ❖ If you transfer data to a PC, you need to install the software (Driver, DVC Media 5.1, Windows Media Player 9.0, DirectX 9.0a) supplied with the camcorder.

System Requirements

- CPU : Intel® Pentium III™ 450 processor compatible or better
- Operating system : Windows® 98SE/ME/2000/XP
- RAM : 128 MB or more
- CD-ROM: 4x CD-ROM drive
- VIDEO : 65,000-colour or better video display card
- Available USB port (V1.1)
- Hard Disc : 4GB (8GB recommended)



Notes

- Intel® Pentium III™ is a trademark of the Intel Corporation.
- Windows® is a registered trademark of the Microsoft® Corporation.
- All other brands and names are property of their respective owners.
- Operations are not guaranteed for all of the recommended computer environments mentioned above.

USB interface

Installing DVC Media 5.1 Program

- ❖ DVC Media 5.1 User's Manual is included on the accompanying CD(D:\help) in adobe's Portable Document Format(PDF)
The user's manual can be viewed using Acrobat Reader software, which is also included on the CD.
(The Acrobat Reader is a freeware product of AdobeSystems,Inc.)
- ❖ Do not connect the camcorder to PC before installing the program.
- ❖ If another camera or scanner is connected, please disconnect it in advance.
- ❖ This explanation is based on Windows®98SE OS.

Program installation

1. Insert the software CD into CD-ROM drive.
- Installation selection screen appears on the monitor.
2. If the installation selection screen does not appear after inserting the CD click "Run" on the Windows "Start" menu and execute SETUP.EXE file to begin installation.
- When CD-ROM drive is set to "D:drive", type "D:/setup.exe" and press Enter.
3. Click the icons listed below to install the selected software.
(The program automatically check and install the driver which the PC is needed)
 - DVC Driver: USB removable Disk Driver (Windows® 98SE only)
 - USB PC CAMERA Driver
 - USB Streaming Driver
 - DVC Media 5.1
 - DirectX 9.0a
 - Windows Media Player 9.0
 - Editing Software



Using the "PC camera" function

- ❖ You can use this camcorder as a PC CAMERA.
 - ❖ When you connect to a Web site that can provide video chatting functions, you can use your camcorder for such functions.
 - ❖ When you use the voice input at video chatting (or net-meeting) function, connect the external microphone to the soundcard of PC.
 - ❖ Using the camcorder with PC installed Net-meeting program, you can conduct video conference.
 - ❖ The screen size of PC CAMERA is 160 × 120 Pixel.
 - ❖ If PC is connected with the USB to the camcorder, the buttons which except the POWER SWITCH, MODE SWITCH, ZOOM SWITCH and NIGHT-CAPTURE SWITCH are not operated.
1. Set the mode switch to Tape, set the power switch to CAMERA.
 2. Connect one end of the USB cable to the USB jack on the camcorder and the other end to the USB connector on your computer.

USB interface

Using the “removable Disk” function

- ❖ You can easily transfer data from a Memory Card to a PC without additional add-on cards via a USB connection.
1. Set the mode switch to memory, set the power switch to CAMERA or PLAYER.
 2. Connect one end of the USB cable to the USB jack on the camcorder and the other end to the USB connector on your computer.

Using the “USB streaming” function

- ❖ USB streaming data type is MPEG4.
 - ❖ To use the USB STREAMING, the DVC Media 5.1, DirectX 9.0a and Windows Media Player 9.0(included in the CD) programs must be installed in the PC.
 - ❖ You can view CAMCORDER video on your PC using USB streaming.
You can also store it as moving picture in the “asf” file format, or as a still image in the “jpg” file format on a PC.
1. Set the mode switch to TAPE, set the power switch to CAMERA or PLAYER.
 2. Connect one end of the USB cable to the USB jack on the camcorder and the other end to the USB connector on your computer.
 3. Execute the DVC Media 5.1 program.
If you want the detailed description of USB streaming, refer to the DVC Media 5.1 User’s Manual.

Connecting to a PC

1. Connect a USB cable to the USB port on the PC.
2. Connect the other end of the USB cable into the proper terminal on the camcorder. (USB jack)
 - If a PC is connected to the camcorder with a USB cable only, the Power Switch, Zoom Switch, mode switch and NIGHT CAPTURE operate.

Disconnecting the USB cable

- ❖ After completing the data transmission, you must disconnect the cable in the following way:
1. Select the removable disc icon and click the right mouse button to select [Eject].
 2. Select [Confirm] and disconnect the USB cable when the Windows Splash screen appears.

Notes

- If you disconnect the USB cable from the PC or the camcorder while transferring, the data transmission will stop and the data may be damaged.
- If you connect the USB cable to a PC via a USB HUB or simultaneously connect the USB cable along with other USB devices, the camcorder may not work properly.
 - If this occurs, remove all USB devices from the PC and reconnect the camcorder.

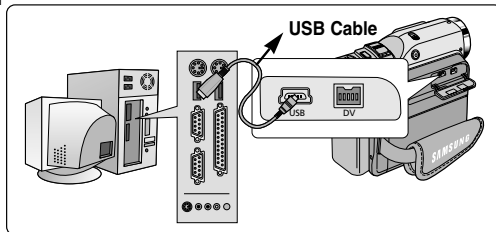

Digital Still Camera mode (VP-D303(i)/D303D(i)/D305(i)/D307(i) only)

MEMORY STICK (Optional Accessory)

- ❖ The Memory Stick stores and manages still images recorded by the camera.

Memory Stick Functions

- ❖ Recording still images and MPEG4 movie
- ❖ Viewing still images and MPEG4 movie
 - Single
 - Slide show (still images only)
- ❖ Multi display
- ❖ Protecting images against accidental erasure
- ❖ Deleting images recorded on a Memory Stick
- ❖ Print marking still images
- ❖ Formatting a Memory Stick

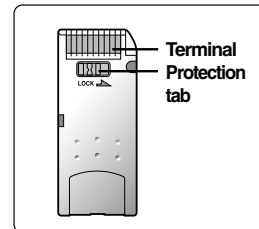

Notes

- You can use most of the camera's functions when recording to the Memory Stick.
- "▶▶▶" appears on the screen while recording to the Memory Stick.
- While recording or loading an image, do not eject or insert the Memory Stick.
 - Inserting or ejecting a Memory Stick while recording or loading an image can cause data damage.
- If you want to save all images on the Memory Stick, set the write protection tab on the Memory Stick to LOCK.



MEMORY STICK™



- "Memory Stick" and  are trademarks of Sony Corporation.
- All other product names mentioned herein may be the trademarks or registered trademarks of their respective companies. Furthermore, "TM" and "REG" are not mentioned in each case in this manual.
- "Memory Stick PRO" can not be used with the VP-D303(i)/D303D(i) MODEL.

Digital Still Camera mode (VP-D303(i)/D303D(i)/D305(i)/D307(i) only)

Inserting and ejecting the Memory Card

● Inserting the Memory Card

1. Turn the Power switch to OFF.
2. Insert the Memory Card in the direction of the arrow into the Memory Card slot located on the bottom of the camcorder.

● Ejecting the Memory Card

1. Turn the Power switch to OFF.
 2. Push the Memory Card, then it comes out of the camcorder automatically.
 3. Pull out the Memory Card.
- ♣ Do not attempt to pull the Memory Card out without first pushing it in.

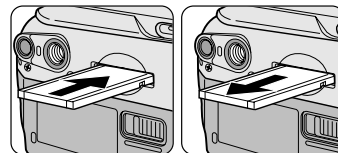

VP-D303(i)/VP-D303D(i)



Memory Stick

VP-D305(i)/VP-D307(i)

Memory Stick
Memory Stick PRO

SD/MMC

(Usable MEMORY CARDS)

Notes

- Memory Stick Duo type or RS-MMC (VP-D305(i)/D307(i) model only) should be inserted by using the ADAPTOR (not supplied).
 - If you set the camcorder to M.PLAY mode, the last recorded still image appears.
 - If there are no recorded images on the Memory Card, "NO STORED PHOTO!" or "NO STORED MPEG4!" and  will display on the screen.
 - Do not turn the power off while recording, loading, erasing or formatting.
 - Please turn the power off before you insert or eject the Memory Card. You could lose data on the Memory Card.
- Do not allow metal substances to come in contact with the terminals of the Memory Card.
 - Do not bend, drop or apply strong shock to Memory Card.
 - After pulling the Memory Card out from the camcorder, please keep the Memory Card in a soft case to prevent static shock.
 - The stored contents may be changed or lost as a result of misuse, static electricity, electric noise or repair. Save important images separately.
 - Samsung is not responsible for data loss due to misuse.

Digital Still Camera mode (VP-D303(i)/D303D(i)/D305(i)/D307(i) only)

Structure of folders and files on the Memory Card

- ❖ The still images that you recorded are saved in JPEG file format on the Memory Card.
- ❖ The moving images that you recorded are saved in MPEG4 file format on the Memory Card.
- ❖ Each file has a file number and all files are assigned to a folder.
 - A file number from DCAM0001 to DCAM9999 is sequentially assigned to each recorded image.
 - Each folder is numbered from 100SSDVC to 999SSDVC and recorded on the Memory Card.

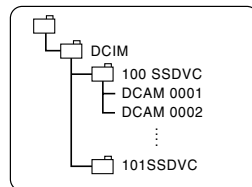
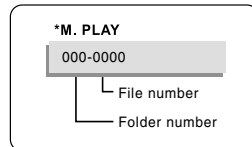

Image Format

- ❖ Still image
 - Images are compressed in JPEG (Joint Photographic Experts Group) format.
 - The number of pixels are 640 × 480 in each mode.
 - Amount of still image must be under 1.4MB.
- ❖ Moving Image
 - Images are compressed in MPEG (Moving Picture Experts Group) format.
 - The number of pixels are 352 × 288, 176 × 144 in each mode.



Selecting the CAMCORDER mode

- ❖ You can use this camcorder as a Digital Still Camera (DSC).
- ❖ You have to set the mode switch to Memory Card position to use this camcorder as Digital Still Camera.
 - M.REC mode (Memory RECORD mode)
 1. Set the mode switch to Memory Card.
 2. Set the power switch to CAMERA.
 - M.PLAY mode (Memory PLAYBACK mode)
 1. Set the mode switch to Memory Card.
 2. Set the power switch to PLAYER.

Digital Still Camera mode (VP-D303(i)/D303D(i)/D305(i)/D307(i) only)

MEMORY FILE NUMBER

- ❖ File numbers will be given to images in order of recording when still images are stored in the Memory Card.
- ❖ MEMORY FILE NUMBERS may be set as follows:
 - SERIES: When there are existing files, the new image will be named as the next number in the sequence.
 - RESET
 - When there are no files stored in the Memory Card: The file numbering starts from 0001
 - When there are files stored in the Memory Card: File numbering will continue after the last file's number

1. Set the mode switch to Memory Card and the power Switch to the CAMERA mode.
2. Press the MENU button.
 - The menu list will appear.
3. Move the MENU SELECTOR to highlight MEMORY and push the MENU SELECTOR.
4. Move the MENU SELECTOR to activate the FILE NO. and push the MENU SELECTOR.
5. To exit, press the MENU button.

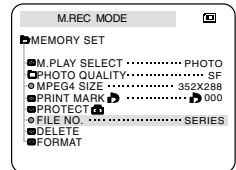
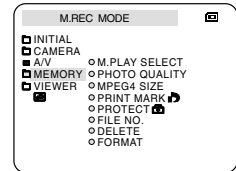

Notes

- When using a Memory Card that contains image files from another device, the file numbering will begin after the largest number that is memorized whether in the camera or the the Memory Card.
- File numbering starts from 0001 again when 9999 files have been saved.

Digital Still Camera mode (VP-D303(i)/D303D(i)/D305(i)/D307(i) only)

Selecting the image quality

❖ You can select the quality of a still image to be recorded.

Select the image quality

1. Set the mode switch to Memory Card.
2. Set the power switch to the CAMERA mode.
3. Press the MENU button.
 - The menu list will appear.
4. Move the MENU SELECTOR to highlight MEMORY.
5. Push the MENU SELECTOR to enter the sub-menu.
6. Move the MENU SELECTOR to highlight PHOTO QUALITY in the submenu.
7. Push the MENU SELECTOR.
8. Using the MENU SELECTOR, select the image quality.
 - Push the MENU SELECTOR to confirm the image quality.
 - If you exit the sub-menu without pushing the MENU SELECTOR, the quality mode is not changed.
9. To exit, press the MENU button.

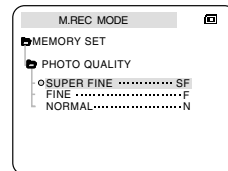
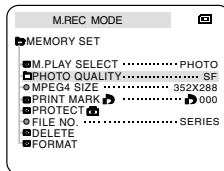
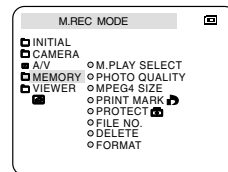
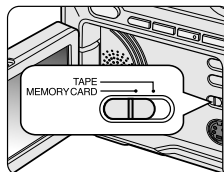

● Number of images on the Memory Card

| QUALITY | 8MB | 16MB |
|------------|------------|------------|
| SUPER FINE | Approx.45 | Approx.90 |
| FINE | Approx.85 | Approx.170 |
| NORMAL | Approx.155 | Approx.310 |

- The actual number that you can record varies depending on the image size.

Digital Still Camera mode (VP-D303(i)/D303D(i)/D305(i)/D307(i) only)

Recording Still images to a Memory Card in M.REC Mode.

- ❖ Audio cannot be recorded with still images onto the Memory Card.

Recording images to a Memory Card

1. Set the mode switch to Memory Card.
2. Set the power switch to CAMERA.
3. Press the PHOTO button.
 - The still image is recorded to the Memory Card.
 - While the camcorder is recording the still image, “▶▶▶” appears on the screen.

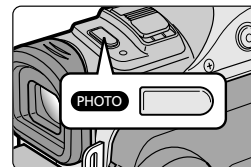
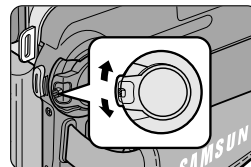
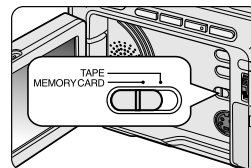

Digital Still Camera mode (VP-D303(i)/D303D(i)/D305(i)/D307(i) only)

Recording an image from a cassette as a still image.

- ❖ You can record a still image from a cassette onto a Memory Card.
- ❖ If you want to recorded multiple still images from a cassette to a Memory Card, use the COPY function.

1. Set the mode switch to TAPE.
2. Set the power switch to PLAYER mode.
3. Play back the cassette.
4. Press the PHOTO button.
 - The still image is recorded to the Memory Card.
 - While the camcorder is recording the still image, “▶▶▶” appears on the screen.

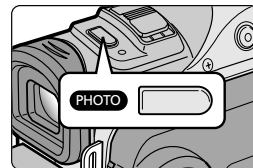
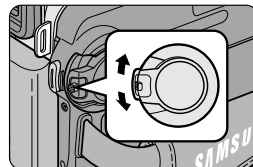
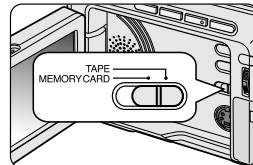

Digital Still Camera mode (VP-D303(i)/D303D(i)/D305(i)/D307(i) only)

Viewing Still images

- ❖ You can playback and view still images recorded on the Memory Card.
- ❖ There are 3 ways to view recorded images.
 - Single : To view an image frame by frame.
 - Slide show : To view all images automatically and in consecutive order.
 - Multi display : To view 6 images at once.

To view a Single image

1. Set the mode switch to Memory Card.
2. Set the power switch to PLAYER mode.
 - The last recorded image appears.
 - If there are no recorded images on the Memory Card, NO STORED PHOTO!
or NO STORED MPEG4! and  will display on the screen.
3. Using the ►► (FWD) and ◀◀ (REV) buttons, search for the desired still image.
 - To view the next image : press the ►► (FWD) button.
 - To view the previous image : press the ◀◀ (REV) button.
 - Pressing ►► (FWD) when you are on the last image will take you to the first image and pressing ◀◀ (REV) when you are on the first image will take you to the last image.
 - Keep pressing ►► (FWD) or ◀◀ (REV) to search for an image quickly.

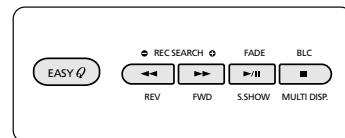

To view a slide show

1. Set the mode switch to Memory Card.
2. Set the power switch to PLAYER mode.
 - The last recorded image appears
3. Press the ►/|| (S.SHOW) button.
 - All images will be played back consecutively for 3~4 seconds each.
4. To stop the slide show, press the ►/|| (S.SHOW) button again.

ENGLISH

Digital Still Camera mode (VP-D303(i)/D303D(i)/D305(i)/D307(i) only)

To view the Multi Display

1. Set the mode switch to Memory Card.
2. Set the power switch to PLAYER mode.
 - The last recorded image appears.
3. To view six stored images on single screen, press the MULTI DISP. button.
 - A selection mark (▶) appears under the image.
 - Move the MENU SELECTOR to select a image.
4. To return to single playback mode, press the MULTI DISP. button again.

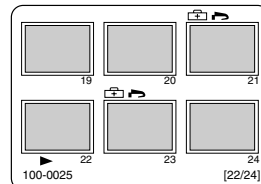

Notes

- To display the previous six images, press the ◀◀(REV).
- To display the next six images, press the ▶▶(FWD).

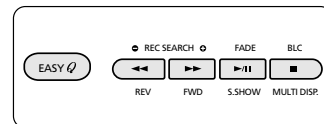

Digital Still Camera mode (VP-D303(i)/D303D(i)/D305(i)/D307(i) only)

Copying still images from a cassette to Memory Card

- ❖ You can copy still images recorded with PHOTO function on a cassette onto a Memory Card.
- ❖ Rewind the TAPE to the point which you wants.

1. Set the power switch to the PLAYER mode.
2. Press the MENU button.
3. Move the MENU SELECTOR to highlight A/V and push the MENU SELECTOR.
 - The submenu will appear.
4. Move the MENU SELECTOR to highlight PHOTO COPY and push the MENU SELECTOR.
 - All still images that recorded on a cassette will be copied to a Memory Card.
5. The camcorder automatically performs the photo search to find still images and copying starts.
6. Press ■ (STOP) button to stop copying.
 - Copying stops when the cassette is finished or Memory Card is full.

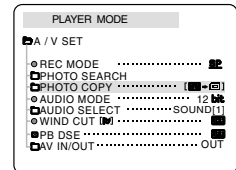
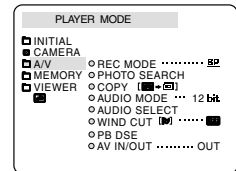

Digital Still Camera mode (VP-D303(i)/D303D(i)/D305(i)/D307(i) only)

Marking images for printing

- ❖ This camcorder supports the DPOF (Digital Print Order Format) print format.
- ❖ You can automatically print images recorded on a Memory Card with a printer supporting DPOF.
- ❖ There are 2 ways to make a PRINT MARK.
 - THIS FILE : You can set a print mark on the photo image displayed on the LCD.
 - ALL FILES : To print 1 copy each of all of the stored images.

1. Set the mode switch to Memory Card.
2. Set the power switch to PLAYER.
 - The last recorded image appears.
3. Using the ►► (FWD) and ◀◀ (REV) buttons, search for the still image that you want to mark.
4. Press the MENU button.
5. Move the MENU SELECTOR to highlight MEMORY and push the MENU SELECTOR.
 - The MEMORY SET submenu will appear.
6. Move the MENU SELECTOR to highlight PRINT MARK, push the MENU SELECTOR.
7. Use the MENU SELECTOR to select either THIS FILE or ALL FILES and push the MENU SELECTOR.
8. Use the MENU SELECTOR to select the quantity and push the MENU SELECTOR.

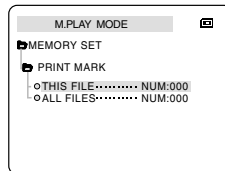
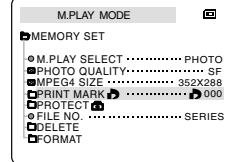
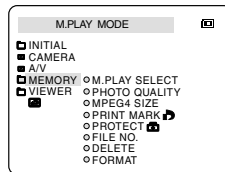

Notes

- When you setup the PRINT MARK option to ALL FILES, 999 files from the first are set to 1 or 0.
- The ALL FILES option may require extended operation time depending on the number of stored images.

Digital Still Camera mode (VP-D303(i)/D303D(i)/D305(i)/D307(i) only)

Protection from accidental erasure

- ❖ You can protect important images from accidental erasure.
 - If you execute FORMAT, all images including protected images will be erased.
1. Set the mode switch to Memory Card.
 2. Set the power switch to PLAYER.
 - The last recorded image appears.
 - If there are no recorded images on the Memory Card, NO STORED PHOTO! or NO STORED MPEG4! and  will display on the screen.
 3. Using the ►► (FWD) and ◀◀ (REV) buttons, search for the still image that you want to protect.
 4. Press the MENU button.
 5. Move the MENU SELECTOR to highlight MEMORY and push the MENU SELECTOR.
 - The submenu of MEMORY SET will appear.
 6. Move the MENU SELECTOR to highlight PROTECT and push the MENU SELECTOR.
 7. Push the MENU SELECTOR to set PROTECT to ON or OFF.
 - THIS FILE ON: protects the currently selected file from erasure.
 8. To exit the menu, press the MENU button.

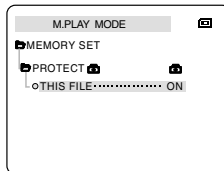
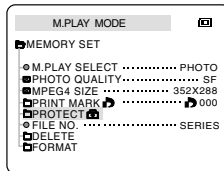
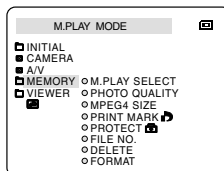

Digital Still Camera mode (VP-D303(i)/D303D(i)/D305(i)/D307(i) only)

Deleting Still images

- ❖ You can erase the still images recorded on the Memory Card.
- ❖ If you want to delete protected images, you must first deactivate the image protection.
- ❖ An image which has been deleted cannot be recovered.

1. Set the mode switch to Memory Card.
2. Set the power switch to PLAYER.
3. Using the ►► (FWD) and ◀◀ (REV) buttons, search for the still image that you want to delete.
4. Press the MENU button.
5. Move the MENU SELECTOR to highlight MEMORY and push the MENU SELECTOR.
 - The MEMORY SET submenu will appear.
6. Move the MENU SELECTOR to highlight DELETE and push the MENU SELECTOR.
 - Using the MENU SELECTOR, select either THIS FILE or ALL FILES and push the MENU SELECTOR.
 - THIS FILE : deletes only the file currently selected.
 - ALL FILES : deletes all files stored in the Memory Card.
7. A box will appear to verify whether you wish to delete the image(s).
 - Using the MENU SELECTOR, select the item.
 - EXECUTE : deletes the selected image(s).
 - CANCEL : does not delete the selected image(s) and returns to the previous menu.

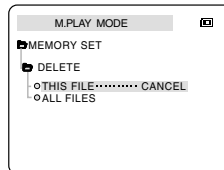
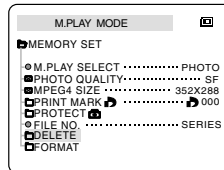
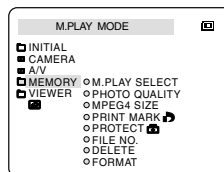

Note

- If you try to delete a protected image, "PROTECT!" appears on the screen.

Digital Still Camera mode (VP-D303(i)/D303D(i)/D305(i)/D307(i) only)

Formatting the Memory Card

- ❖ You can use the MEMORY FORMAT functions to completely delete all images and options on the Memory Card, including protected images.
- ❖ The format function restores the Memory Card to its initial state.
- ❖ The Memory Card supplied with this camcorder has been formatted already.

Attention

- ❖ If you execute the MEMORY FORMAT function, all images will be erased completely and erased images cannot be recovered.

1. Set the mode switch to Memory Card.
2. Set the power switch to PLAYER mode.
3. Press the MENU button.
4. Move the MENU SELECTOR to highlight MEMORY and push the MENU SELECTOR.
 - The sub menu will appear.
5. Select FORMAT from the list and push the MENU SELECTOR.
6. "ALL FILES ARE DELETED! FORMAT REALLY?" appears on the screen.
7. Using the MENU SELECTOR, select the item.
 - NO : To return to previous menu
 - YES : To start formatting.
8. Push the MENU SELECTOR.

If you selected the "YES", "COMPLETE!" is appeared on the screen when the Memory Card formatting is finished.
9. To exit the menu, push the MENU button.

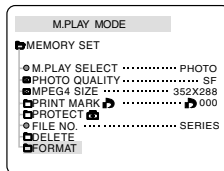
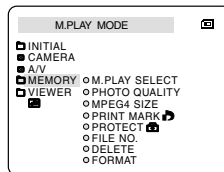

Note

- If you want to format the Memory Stick on your PC, use only the "MS Formatter" supplied with the software CD.
 - The MS formatter is exclusive program of the Memory Stick.

ENGLISH

Digital Still Camera mode (VP-D303(i)/D303D(i)/D305(i)/D307(i) only)

MPEG RECORDING

❖ You can record the moving picture images with audio on the Memory Card.

Saving the pictures captured by a camera as a moving picture file onto Memory Card

1. Check whether Memory Card is inserted into the camcorder. If it is not in the camcorder, insert it onto the slot.
2. Set the mode switch to Memory Card position.
3. Set the power switch to CAMERA mode.
4. Press the START/STOP button, the images are recorded onto the Memory Card in MPEG4.
 - You can record 10 ~ 20 seconds continuously in once by the recording object.
 - You can record a camera still image onto the Memory Card by pressing the Photo button instead of the START/STOP button.
5. Press the START/STOP button to stop the recording.

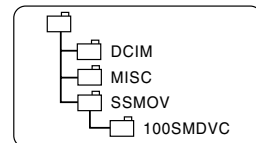
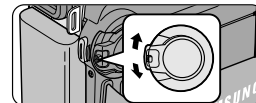

Notes

- Before using the MPEG REC function, check whether the Memory Card is inserted into the camcorder.
- Moving pictures can be made in two sizes, 176 x 144 or 352 x 288 (Pixel).
- Moving images that you recorded are saved in *.asf file format on the Memory Card.
- The files that you recorded are saved in a following folder.
- The moving picture images on a Memory Card are smaller size and lower definition than one on Tape.
- The sound is recorded in type of mono.
- The following functions are not allowed in M.REC Mode.
 - DIS (Digital Image Stabilizer), Digital Zoom, Fade, Program AE, Digital Special Effect, Slow Shutter
- While you record in Memory Card, don't insert or eject the tape as it may record noise.
- While you record in Memory Card, don't eject it or it might break the data on the Memory Card or Memory Card itself.

Digital Still Camera mode (VP-D303(i)/D303D(i)/D305(i)/D307(i) only)

Selecting the moving picture sizes

1. Set the mode switch to Memory Card position.
2. Set the power switch to CAMERA mode.
3. Press the MENU button.
4. Move the MENU SELECTOR to highlight MEMORY.
5. Push the MENU SELECTOR to enter the submenu.
6. Move the MENU SELECTOR to highlight MPEG4 SIZE.
7. Push the MENU SELECTOR.
 - The MPEG4 SIZE toggles between 352X288/176X144 with each push.

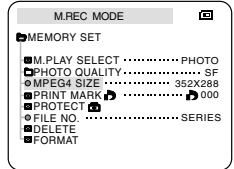
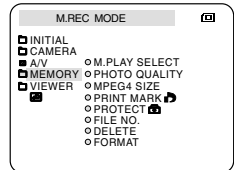

Digital Still Camera mode (VP-D303(i)/D303D(i)/D305(i)/D307(i) only)

MPEG Playback

- ❖ The MPEG Playback function works in M. PLAY mode only.
- ❖ You can play the moving picture images on the Memory Card.
- ❖ During the MPEG4 playback, you can hear sound at the PC speaker only. (You cannot hear it from the speaker onto a camcorder and TV.)

1. Set the mode switch to Memory Card position.
2. Set the power switch to PLAYER mode.
3. Press the MENU button and move the MENU SELECTOR to highlight MEMORY.
4. Push the MENU SELECTOR to enter sub-menu.
5. Use the MENU SELECTOR to select MPEG4 from the sub-menu. (M. PLAY SELECT)
6. To exit the menu, push the MENU button.
7. Using the ►► (FWD) and ◀◀ (REV) buttons, search for the moving picture that you want to playback.
8. Press the PLAY/STILL button.
 - The moving pictures recorded onto the Memory Card are played back.

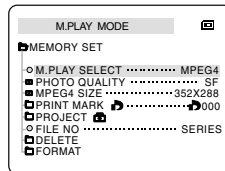
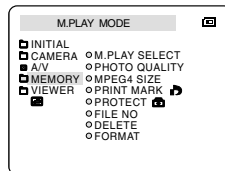

Notes

- There could be any broken or mosaic pictures while playing the MPEG4 moving picture images, but it is not malfunction.
- Sharp G.726 Audio Codec is automatically installed through Internet when you play the MPEG4 file.
- If sharp G.726 Audio Codec is not properly installed on your PC, it could not play Audio in the MPEG4 file.
- The moving picture images that you recorded in the Memory Card might not be allowed to play by the camcorder of another brands.
- The MPEG4 file recorded by another camcorder might not be allowed to play by this camcorder.
 - You need Microsoft Windows Media Player Version 9 or higher version and Sharp G.726 Audio Codec in order to play MPEG4 file on the Memory Card on your PC. (Microsoft Windows Media Player Version 9 (Eng) is included in the CD that is supplied.)
 - You can download the Microsoft Windows Media Player applied each languages on Microsoft Website, "<http://www.microsoft.com/windows/windowsmedia/download/default.asp>".

Maintenance

After finishing a recording

- ❖ At the end of a recording you must remove the power source.
 - ❖ When recording with a Lithium Ion Battery Pack, leaving the pack on the camcorder can reduce the life span of the battery. Hence, it should be removed from the camcorder.
1. Slide the TAPE EJECT switch in the direction of the arrow.
 - Opening the cassette door ejects the tape automatically.
 - Please wait while the tape is completely ejected.
 2. After removing the tape, close the door and store the camcorder in a dust free environment.
 - Dust and other foreign materials can cause square-shaped noise or jerky images.
 3. Set the power switch to the OFF mode.
 4. Disconnect the power source or remove the Lithium Ion Battery Pack.
 - Press the BATTERY RELEASE button and slide the battery pack in the direction of the arrow.

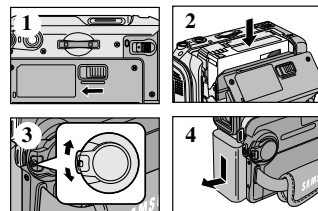

Maintenance

Cleaning and Maintaining the Camcorder

Cleaning the Video Heads

To ensure normal recording and clear pictures, clean the video heads when the playback pictures display square block-shaped noise or distortion, or a blue screen appears.

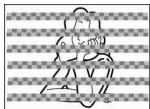

(blue screen)

1. Set the power switch to PLAYER mode.
2. Insert the cleaning tape.
3. Press the ►/|| (PLAY/STILL) button.
4. Press the ■ (STOP) button after 10 seconds.

Notes

- Check the quality of the picture using a videocassette.
If the picture quality has not improved, repeat the operation.
If the problem continues, contact your local authorized service center.
- Clean the video heads with a dry type cassette cleaner.

Maintenance

Using Your Camcorder Abroad

- ❖ Each country or region has its own electric and colour systems.
- ❖ Before using your camcorder abroad, check the following items.

Power sources

- You can use your camcorder in any country or area with the supplied AC Power Adapter within 100V to 240V, 50/60 Hz.
- Use a commercially available AC plug Adapter, if necessary, depending on the design of the local wall outlet.

Colour system

- You can view your recording in the viewfinder.
However, to view it on a television or copy it to a videocassette recorder, the television or VCR must be PAL-compatible and have the appropriate audio/video jacks.
Otherwise, you may need to use a transcoder.

● PAL-compatible Countries/Regions

Australia, Austria, Belgium, Bulgaria, China, CIS, Czech Republic, Denmark, Egypt, Finland, France, Germany, Greece, Great Britain, Holland, Hong Kong, Hungary, India, Iran, Iraq, Kuwait, Libya, Malaysia, Mauritius, Norway, Romania, Saudi Arabia, Singapore, Slovak Republic, Spain, Sweden, Switzerland, Syria, Thailand, Tunisia, etc.

● NTSC-compatible Countries/Regions

Bahamas, Canada, Central America, Japan, Korea, Mexico, Philippines, Taiwan, United States of America, etc.

Note



You can make recordings with your camcorder and view pictures on the LCD from anywhere in the world.

Troubleshooting

Troubleshooting

- ❖ Before contacting a Samsung authorized service centre, perform the following simple checks. They may save you the time and expense of an unnecessary call.

Self Diagnosis Display

| Display | Blinking | Informs that... | Action |
|---|----------|--|---|
|  | slow | the battery pack is almost discharged. | Change to a charged one. |
| TAPE END! | slow | When the remaining time on the tape is about 2 minutes | Prepare a new one. |
| TAPE END! | no | the tape reached its end. | Change to a new one. |
| TAPE! | slow | there is no tape in camcorder. | Insert a tape. |
| PROTECTION | slow | the tape is protected from recording. | If you want to record, release the protection. |
| ▲...D L C R | slow | the camcorder has some mechanical fault. | <ol style="list-style-type: none"> 1. Eject the tape. 2. Set to OFF. 3. Detach the battery. 4. Reattach the battery. * If unresolved contact your local service representative. |
|  | slow | moisture condensation has formed in the camcorder. | see below. |

Moisture Condensation

- ❖ If the camcorder is brought directly from a cold place to a warm place, moisture may condense inside the camcorder, on the surface of the tape, or on the lens. In this condition, the tape may stick to the head drum and be damaged or the unit may not operate correctly.
To prevent possible damage under these circumstances, the camcorder is fitted with a moisture sensor.
- ❖ If there is moisture inside the camcorder,  (DEW) is displayed. If this happens, none of the functions except cassette ejection will work.
Open the cassette compartment and remove the battery.
Leave the camcorder for at least two hours in a dry warm room.

Troubleshooting

Self Diagnosis Display in M.REC/M.PLAY mode (VP-D303(i)/D303D(i)/D305(i)/D307(i) only)

| Display | Blinking | Informs that... | Action |
|--|----------|--|--|
| MEMORY CARD! | slow | There is no Memory Card in the camcorder. | Insert a Memory Card. |
| MEMORY FULL! | slow | There is not enough memory to record. | Change to a new Memory Card. Erase recorded image. |
| NO STORED PHOTO! or NO STORED MPEG4! | slow | There are no images recorded on the Memory Card. | Record new images. |
| WRITE PROTECT! | slow | The Memory Card is record protected. | Release the write protect tab on the Memory Card. |
| PROTECT! | slow | When you try to delete to protected image. | Cancel the protect of image. |
| READ ERROR! | slow | The camera can not playback. | Format a Memory Card or insert Memory Card recorded on this camcorder. |
| WRITE ERROR! | slow | The camera can not record. | Format a Memory Card or change to a new Memory Card. |
| NOT FORMATTED! | slow | The Memory Card needs to format. | Format a Memory Card. (see page 97) |
| NOW DELETE... | slow | When progressing FILE DELETE. | Wait until Delete has been finished. |
| NOW FORMAT... | slow | When progressing MEMORY FORMAT. | Wait until formatting has been finished. |
| NOW COPY... | slow | When progressing FILE COPY. | Wait until copying has been finished. Or press the stop button. |

Troubleshooting

❖ If these instructions do not solve your problem, contact your nearest Samsung authorized service centre.

| Symptom | Explanation/Solution |
|--|--|
| You cannot switch the camcorder on. | Check the battery pack or the AC Power Adapter. |
| START/STOP button does not operate while recording. | Check the POWER switch is set to CAMERA. You have reached the end of the cassette. Check the record protection tab on the cassette. |
| The camcorder goes off automatically. | You have left the camcorder set to STBY for more than 5 minutes without using it. The battery pack is fully exhausted. |
| The battery pack is quickly exhausted. | The atmospheric temperature is too low. The battery pack has not been charged fully. The battery pack is completely dead, and cannot be recharged, Use another battery pack. |
| When you see a blue screen during playback. | The video heads may be dirty. Clean the head with a cleaning tape. |
| A vertical strip appears on the screen when recording a dark background. | The contrast between the subject and the background is too great for the camcorder to operate normally. Make the background bright to reduce the contrast or use the BLC function while you are recording brighter. |
| The image in the viewfinder is blurred. | The Viewfinder lens has not been adjusted. Adjust the viewfinder control lever until the indicators displayed on the viewfinder come into sharp focus. |
| Auto focus does not work. | Check the M.FOCUS menu. Auto focus does not work in the Manual Focus mode. |
| Play, FF or REW button does not work. | Check the POWER switch. Set the power switch to PLAYER. You have reached the beginning or end of the cassette. |
| When you see a broken block image during the RECORD SEARCH. | This is normal operation and it is not a failure or defect. |

Specifications

Model name: VP-D301(i)/D303(i)/D303D(i)/D305(i)/D307(i)

| System | |
|------------------------|---|
| Video signal | PAL |
| Video recording system | 2 rotary heads, Helical scanning system |
| Audio recording system | Rotary heads, PCM system |
| Usable cassette | Digital video tape (6.35mm width): Mini DV cassette |
| Tape speed | SP: approx. 18.83mm/s LP: approx. 12.57mm/s |
| Tape recording time | SP: 60 minutes (when using DVM 60), LP: 90 minutes (when using DVM 60) |
| FF/REW time | Approx. 150 sec. (using DVM60 tape) |
| Image device | CCD (Charge Coupled Device) |
| Lens | F1.6 20x (optical), 900x(Digital) Electronic zoom lens |
| Filter diameter | Ø30 |
| LCD monitor/Viewfinder | |
| Size/dot number | 2.5inchs 123k, (VP-D307(i) : 200k) |
| LCD monitor Method | TFT LCD |
| Viewfinder | 0.24" Colour LCD |
| Connectors | |
| Video output | 1Vp-p (75Ω terminated) |
| S-video output | Y: 1Vp-p, 75Ω, C: 0. 286Vp-p, 75Ω |
| Audio output | -7.5dBs (600Ω terminated) |
| DV input/output | VP-D301i/D303i/D303Di/D305i/D307i: 4pin special in/out connector, VP-D301/D303/D303D/D305/D307: out only |
| USB output | Mini-B type connector |
| External mic | Ø3.5 stereo |
| General | |
| Power source | DC 8.4V, Lithium Ion Battery Pack 7.4V |
| Power source type | Lithium Ion Battery Pack, Power supply (100V~240V) 50/60Hz |
| Power consumption | 4.8W(LCD), 3.8W(Viewfinder) |
| (Recording) | (VP-D307(i): 5.0W(LCD), 4.0W(Viewfinder)) |
| Operating temperature | 0°-40°C (32°F~104°F) |
| Storage temperature | -20°C ~ 60°C (-4°F ~ 140°F) |
| External dimension | H 3.86inches(98mm), L 4.4inches(112mm), W 2.16inches(55mm) |
| Weight | 402g (Except for Lithium Ion Battery Pack and tape) |
| Built-in MIC | Omni-directional stereo condenser microphone |
| Remote control | Indoors: greater than 49ft(15m) (straight line), Outdoors: about 16.4ft(5m) (straight line) |

- These technical specifications and design may be changed without notice.

INDEX

- A -

| | |
|---------------------|----|
| Accessories | 12 |
| AF/MF | 62 |
| Audio dubbing | 65 |
| AUDIO MODE | 53 |
| AV IN/OUT | 78 |

- B -

| | |
|--------------------|----|
| Battery Pack | 24 |
| BEEP SOUND | 41 |
| BLC | 63 |

- C -

| | |
|------------------|-----|
| Cassette | 27 |
| Cleaning | 102 |
| CLOCK SET | 39 |
| Connecting | 72 |

- D -

| | |
|---------------------|--------|
| DATE/TIME | 55 |
| DC Cable | 23 |
| Deleting | 96 |
| DEMONSTRATION | 43 |
| DIS | 49 |
| DSE | 50 |
| DV | 79, 80 |

- E -

| | |
|-----------------|----|
| EASY Mode | 61 |
| EXPOSURE | 59 |

- F -

| | |
|-------------------------|----|
| Fade | 64 |
| Formatting | 97 |
| Frame advance | 74 |
| Functions buttons | 14 |

- H -

| | |
|------------------|----|
| Hand Strap | 22 |
|------------------|----|

- I -

| | |
|----------------|----|
| IEEE1394 | 79 |
|----------------|----|

- L -

| | |
|-----------|--------|
| LCD | 31, 32 |
|-----------|--------|

- M -

| | |
|----------------------|----|
| Memory Card | 85 |
| Memory Stick | 84 |
| MPEG RECORDING | 98 |
| MPEG SIZE | 99 |

- O -

| | |
|-----------|--------|
| OSD | 18, 19 |
|-----------|--------|

- P -

| | |
|---------------------|----|
| PB DSE | 76 |
| PHOTO copy | 93 |
| PHOTO quality | 88 |
| PHOTO SEARCH | 67 |
| PROGRAM AE | 44 |
| Protection | 95 |

- Q -

| | |
|------------------|----|
| Quick Menu | 57 |
|------------------|----|

- R -

| | |
|----------------------|--------|
| REC MODE | 52 |
| REC Search | 30 |
| Remote control | 17, 20 |

- S -

| | |
|---------------------|----|
| SHUTTER SPEED | 58 |
| Sound | 35 |
| Speaker | 35 |
| Still images | 91 |

- T -

| | |
|------------------|----|
| Tele MACRO | 47 |
| TV DISPLAY | 56 |

- U -

| | |
|-----------|----|
| USB | 81 |
|-----------|----|

- V -

| | |
|------------------|--------|
| Viewfinder | 32, 33 |
|------------------|--------|

- W -

| | |
|-------------------|----|
| WHT BALANCE | 46 |
| WIND CUT | 54 |
| WL. REMOTE | 30 |

- Z -

| | |
|-------------------|--------|
| ZERO MEMORY | 75 |
| Zoom | 47, 48 |

Power Sources (United Kingdom Only)

The mains lead on the power adapter is supplied with a moulded plug incorporating a fuse.

The value of the fuse is indicated on the pin face of the plug and, if it requires replacing, a fuse approved to BS1362 of the same rating must be used.

Never use the plug with the fuse cover omitted if the cover is detachable.

If a replacement fuse cover is required, it must be of the same colour as the pin face of the plug.

Replacement covers are available from your dealer.

If the fitted plug is not suitable for the power points in your house or the cable is not long enough to reach a power point, you should obtain a suitable safety approved extension lead or consult your dealer for assistance.

However, if there is no alternative to cutting off the plug, remove the fuse and then safely dispose of the plug.

Do NOT connect the plug to a mains socket as there is a risk of shock hazard from the bared flexible cord.

IMPORTANT

The wires in the mains lead are coloured in accordance with the following code:

BLUE = NEUTRAL BROWN = LIVE

As these colours may not correspond to the coloured markings identifying the terminals in your plug, proceed as follows:

The wire coloured BLUE must be connected to the terminal marked with the letter N or coloured BLUE or BLACK.

The wire coloured BROWN must be connected to the terminal marked with the letter L or coloured BROWN or RED.

WARNING

Do not connect either wire to the earth terminal marked with the letter E or the earth symbol, \perp , or coloured GREEN or GREEN and YELLOW.

NOTE

This page is applicable to Great Britain only.



UNITED KINGDOM

This Samsung product is warranted for the period of twelve (12) months from the original date of purchase, against defective materials and workmanship. In the event that warranty service is required, you should return the product to the retailer from whom it was purchased.

However, Samsung Authorised Dealers and Authorised Service Centres in other EC Countries will comply with the warranty on the terms issued to purchasers in the country concerned. In case of difficulty, details of our Authorised Service Centres are available from:

**Samsung Electronics (U.K.) Ltd.,
Euro Service Centre, Stafford Park 12,
TELFORD, Shropshire TF3 3BJ,
Tel: 0870) 242 0303, Fax: 01952) 297617**

■ WARRANTY CONDITIONS

1. The warranty is only valid if, when warranty service is required, the warranty card is fully and properly completed and is presented with the original invoice or sales slip or confirmation, and the serial number on the product has not been defaced.
2. Samsung's obligations are limited to the repair or, at its discretion, replacement of the product or the defective part.
3. Warranty repairs must be carried out by Authorised Samsung Dealers or Authorised Service Centres. No reimbursement will be made for repairs carried out by non Samsung Dealers and, any such repair work and damage to the products caused by such repair work will not be covered by this warranty.



REPUBLIC OF IRELAND

4. This product is not considered to be defective in materials nor workmanship by reason that it requires adaptation in order to conform to national or local technical or safety standards in force in any Country other than the one for which the product was originally designed and manufactured. This warranty will not cover, and no reimbursement will be made for such adaptation nor any damage which may result.
5. This warranty covers none of the following:
 - a) Periodic check ups, maintenance and repair or replacement of parts due to normal wear and tear.
 - b) Cost relating to transport, removal or installation of the product.
 - c) Misuse, including the failure to use this product for its normal purposes or incorrect installation.
 - d) Damage caused by Lightning, Water, Fire, Acts of God, War, Public Disturbances, incorrect mains voltage, improper ventilation or any other cause beyond the control of Samsung.
6. This warranty is valid for any person who legally acquired possession of the product during the warranty period.
7. The consumers statutory rights in any applicable national legislation whether against the retailer arising from the purchase contract or otherwise are not affected by this warranty. Unless there is national legislation to the contrary, the rights under this warranty are the consumers sole rights and Samsung, its subsidiaries and distributors shall not be liable for indirect or consequential loss or any damage to records, compact discs, videos or audio taper or any other related equipment or material.

SAMSUNG ELECTRONICS (U.K.) LTD.



ΕΛΛΑΣ (GREECE)

Αγαπητέ πελάτη,

Σας ευχαριστούμε για την εμπιστοσύνη που δείξατε στην **SAMSUNG** με την αγορά αυτής της συσκευής.

Το προϊόν αυτό της **SAMSUNG** είναι εγγυημένο για περίοδο δώδεκα (12) μηνών από την ημερομηνία αγοράς του για ανταλλακτικά και εργατικά. Στην περίπτωση που θα χρειαστεί επισκευή, το προϊόν αυτό της **SAMSUNG** θα πρέπει να σταλεί ή να μεταφερθεί στο εξουσιοδοτημένο **service**, με έξοδα του αγοραστή.

Εξουσιοδοτημένοι αντιπρόσωποι και εξουσιοδοτημένα κέντρα **service** σε άλλες Ευρωπαϊκές χώρες, θα αποδεχθούν τους όρους της εγγύησης.

Πληροφορίες για τα εξουσιοδοτημένα κέντρα **service** στην Ελλάδα, μπορείτε να πάρετε από την

FOURLIS TRADE A.E.B.E.

Λ. Κρουσιερίου 112

145 68 Κρουσιέρι, Αττικής

Τηλ. 210.629.3100

■ Όροι της εγγύησης

1. Η εγγύηση ισχύει εάν και μόνο εάν το προϊόν χρειάζεται **service** και η κάρτα εγγύησης έχει πλήρως συμπληρωθεί και σφραγισθεί από το κατάστημα αγοράς. Επίσης πρέπει να προσκομισθεί και το τιμολόγιο ή η απόδειξη λιανικής πώλησης, πάνω στην οποία ο σειριακός αριθμός του προϊόντος πρέπει να είναι ευκρινής.
2. Η υποχρέωση της **SAMSUNG** αφορά μόνο την επισκευή του προϊόντος

3. Η επισκευή του προϊόντος πρέπει να ανατίθεται μόνο σε εξουσιοδοτημένα κέντρα **service** ή εξουσιοδοτημένους αντιπροσώπους της **SAMSUNG**. Καμία αποζημίωση δεν θα γίνει αποδεκτή για επισκευή που έχει γίνει από μη εξουσιοδοτημένο από την **SAMSUNG** συνεργείο.

4. Το προϊόν αυτό δεν θα θεωρηθεί ελαττωματικό στα υλικά ή στην εργασία επισκευής εάν θα πρέπει να προσαρμοστεί, μετατραπεί ή ρυθμιστεί ώστε να συμμορφωθεί με τις τοπικές τεχνικές προδιαγραφές ή προδιαγραφές που ισχύουν σε χώρα άλλη από αυτή για την οποία προοριζόταν ή κατασκευάστηκε.

Η εγγύηση αυτή δεν καλύπτει αποζημιώσεις για:

- * Κεφαλές βίντεο και κασетоφώνων
- * Κεφαλές βιντεοκάμερας
- * Γεννήτριες ακτινών **laser** στα **CD, DVD**
- * Τηλεχειριστήρια
- * Λυχνίες φούριων μικροκυμάτων
- * Προσαρμογές, αλλαγές ή ρυθμίσεις, ανεξάρτητα αν είναι επιτυχής ή ανεπιτυχής, ούτε οποιαδήποτε ζημία προέρχεται εξ αυτού...

5. Η εγγύηση αυτή δεν καλύπτει καμία από τις παρακάτω περιπτώσεις:
- * Περιοδικούς ελέγχους, συντήρηση και επισκευή ή αντικατάσταση μερών που οφείλονται σε φυσιολογική φθορά
 - * Τα έξοδα και τους κινδύνους μεταφοράς που σχετίζονται με την εγγύηση αυτού του προϊόντος
 - * Ζημία σε αυτό το προϊόν που προέρχεται από:
 - A. Κατάχρηση ή και κακή χρήση, συμπεριλαμβανομένης αλλά και μη περιορισμένης σε:
Μη χρήση αυτού του προϊόντος για τους σκοπούς που φυσιολογικά προορίζεται ή σύμφωνα με τις οδηγίες χρήσεως για την σωστή χρήση και συντήρηση αυτού του προϊόντος
Την εγκατάσταση και χρήση του προϊόντος με τρόπους που αντίκεινται στις τεχνικές προδιαγραφές ασφαλείας που ισχύουν κατά την χρήση του προϊόντος
 - B. Επισκευή που έγινε από μη εξουσιοδοτημένα συνεργεία **service**
 - Γ. Ατυχήματα, θεομηνίες ή οποιαδήποτε αιτία πέρα του ελέγχου της **SAMSUNG**, συμπεριλαμβανομένων αλλά μη περιορισμένων των κεραυνών, του νερού, της φωτιάς, των δημοσίων αναταραχών, του κακού αερισμού κλπ.
 - Δ. Η εγγύηση αυτή δεν επηρεάζει τα δικαιώματα του καταναλωτή που προβλέπονται από την εφαρμοστέα εθνική νομοθεσία που ισχύει, ούτε τα δικαιώματα των καταναλωτών εναντίον των λιανοπωλητών που απορρέουν από την σύμβαση πώλησης.

- Ε. Σε περίπτωση που δεν υπάρχει εθνική νομοθεσία αυτή η εγγύηση θα είναι η μοναδική και αποκλειστική κάλυψη του καταναλωτή για κάθε ζημία.

FOURLIS TRADE A.E.B.E.

ENGLISH

THIS CAMCORDER IS MANUFACTURED BY:



***Samsung Electronics' Internet Home Page**

United Kingdom <http://www.samsungelectronics.co.uk>

AD68-00752F

Free Manuals Download Website

<http://myh66.com>

<http://usermanuals.us>

<http://www.somanuals.com>

<http://www.4manuals.cc>

<http://www.manual-lib.com>

<http://www.404manual.com>

<http://www.luxmanual.com>

<http://aubethermostatmanual.com>

Golf course search by state

<http://golfingnear.com>

Email search by domain

<http://emailbydomain.com>

Auto manuals search

<http://auto.somanuals.com>

TV manuals search

<http://tv.somanuals.com>