

MODEL
FO-DC500/FO-DC600

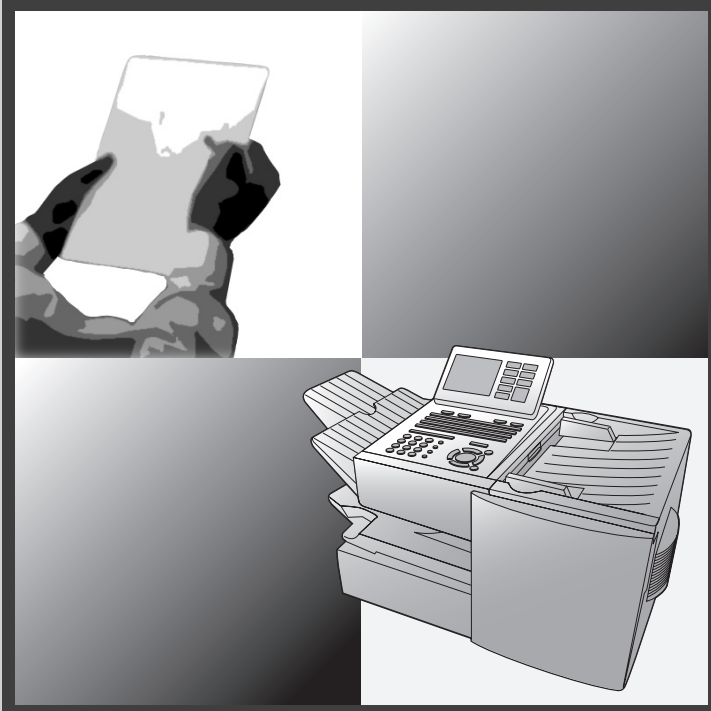

DOCUMENT COMMUNICATION SYSTEM
OPERATION MANUAL

1. Installation
2. Sending and Receiving Documents
3. Network Scanner Option
4. Network Printer Option
5. Making Copies
6. Special Functions
7. Optional Settings
8. Printing Lists and Reports
9. Maintenance
10. Troubleshooting

SHARP[®]

U.S.A.

WARNING - FCC Regulations state that any unauthorized changes or modifications to this equipment not expressly approved by the manufacturer could void the user's authority to operate this equipment.

Note: This equipment has been tested and found to comply with the limits for a Class A digital device, pursuant to part 15 of the FCC Rules. These limits are designed to provide reasonable protection against harmful interference when the equipment is operated in a commercial environment. This equipment generates, uses, and can radiate radio frequency energy and, if not installed and used in accordance with the instruction manual, may cause harmful interference to radio communications. Operation of this equipment in a residential area is likely to cause harmful interference in which case the user will be required to correct the interference at his own expense.

ABOUT THE TELEPHONE CONSUMER PROTECTION ACT OF 1991

"The Telephone Consumer Protection Act of 1991 makes it unlawful for any person to use a computer or other electronic device to send any message via a telephone facsimile machine unless such message clearly contains in a margin at the top or bottom of each transmitted page or on the first page of the transmission the following information:

- (1) The date and time of transmission.
- (2) Identification of either the business, business entity or individual sending the message.
- (3) Telephone number of either the sending machine, business, business entity or individual.

In order to program this information into your facsimile machine, please refer to the appropriate instructions in the operation manual."



As an ENERGY STAR® partner, SHARP has determined that this product meets the ENERGY STAR® guidelines for energy efficiency.

Canada

This product meets the applicable Industry Canada technical specifications

The Ringer Equivalence Number is an indication of the maximum number of devices allowed to be connected to a telephone interface. The termination on an interface may consist of any combination of devices subject only to the requirement that the sum of the RENs of all the devices does not exceed five.

Introduction

Welcome, and thank you for choosing a SHARP FO-DC500/600 Document Communication System. The features and specifications of the system are shown below.

Automatic dialing	Conventional Auto Dialing: Rapid Key Dialing: 59 numbers Speed Dialing FO-DC500: 100 numbers FO-DC600: 200 numbers Personal Auto Dial Books FO-DC500: 20 books FO-DC600: 40 books (59 Rapid Keys, 16 Speed Dial numbers per book)
Memory size*	FO-DC500: 8 MB (approx. 500 pages) FO-DC600: 16 MB (approx. 1,000 pages) Optional memory: FO-8MK (8 MB; approx. 500 pages)
Modem speed	33,600 bps (max.) with automatic fallback to lower speeds.
Transmission time*	Approx. 2 seconds
Toner cartridge yield** (continuous printing, 4% page coverage, letter paper)	Initial starter cartridge (included with machine): Approx. 3000 pages Replacement cartridge (FO-50ND): Approx. 6000 pages
Drum cartridge yield** (continuous printing, 4% page coverage, letter paper)	Initial starter cartridge (included with machine): 20,000 pages (ave.) Replacement cartridge (FO-47DR): 20,000 pages (ave.)
Resolution	Standard: 203 x 98 lines/inch (8 x 3.85 lines/mm) Fine/Halftone: 203 x 196 lines/inch (8 x 7.7 lines/mm) Super fine: 203 x 391 lines/inch (8 x 15.4 lines/mm) Ultra fine: 406 x 391 lines/inch (16 x 15.4 lines/mm)
Halftone (grayscale)	64 levels

*Based on Sharp Standard Chart at standard resolution, excluding time for protocol signals (i.e., ITU-T phase C time only).

**The yields may vary depending on coverage and operating conditions.

Automatic document feeder	Letter paper (20 lb): Max. 50 pages Legal paper: Max. 20 pages (Note: 11" x 17" paper must be loaded one page at a time.)
Paper capacity	FO-DC500: 250 sheets (20 lb) FO-DC600: 750 sheets (20 lb) (500-sheet cassette available as option)
Compression scheme	MMR, MR, MH, Sharp (H2), JBIG
Applicable telephone line	Public switched telephone network
Compatibility	ITU-T (CCITT) G3 mode, Super G3 mode
Printing resolution	Horizontal: 406 lines/inch (16 lines/mm) Vertical: 391 lines/inch (15.4 lines/mm)
Input document size	Automatic feeding: Width: 5.8 to 10.1" (148 to 257 mm) Length: 5.0 to 14.3" (128 to 364 mm) Manual feeding: Width: 5.8 to 11.0" (148 to 279 mm) Length: 5.0 to 38.0" (128 to 966 mm) (maximum length 19" (483 mm) when ultra fine resolution is used.)
Effective Scanning width	10" (257 mm) max.
Effective Printing width	8.0" (203 mm) max.
Printing speed	16 ppm
Reception modes	Auto/Manual
Instascan speed	1.3 sec/page (letter paper; scan time only, excludes document feeding time)
Full Dual Access	Yes
Copy function	Single/Multi/Sort (99 copies/page)
Power requirements	120 V AC, 60 Hz
Operating temperature	50 - 86°F (10 - 30°C)
Humidity	20 to 85% RH

Power consumption	FO-DC500	FO-DC600
	Standby: 9 W	9 W
	Standby (all options installed): 16 W	16W
	Maximum: 760 W	800 W
Dimensions	FO-DC500	FO-DC600
	Width: 21.5" (546 mm)	21.5" (546 mm)
	Depth: 16.2" (412 mm)	16.2" (412 mm)
	Height: 13.6" (346 mm)	17.0" (431 mm)
	(Not including paper tray or attachments)	
Weight	Approx. 31.3 lbs. (14.2 kg)	48.5 lbs. (22.0 kg)
	(Not including supplies, paper tray or attachments)	

As a part of our policy of continuous improvement, SHARP reserves the right to make design and specification changes for product improvement without prior notice. The performance specification figures indicated are nominal values of production units. There may be some deviations from these values in individual units.

Important safety information

Be sure to save these instructions!

When using this equipment, basic safety precautions should always be followed to reduce the risk of fire, electric shock and injury to persons, including the following:

- **CAUTION:** To reduce the risk of fire, use only No. 26 AWG or larger telecommunication line cord.
- Do not disassemble this machine or attempt any procedures not described in this manual. Refer all servicing to qualified service personnel.
- This machine must only be connected to a 120 V, 60 Hz, grounded (3-prong) outlet. Connecting it to any other kind of outlet will damage the machine and invalidate the warranty.
- Do not install or use the machine near water, or when you are wet. For example, do not use the machine near a bath tub, wash bowl, kitchen sink or laundry tub, in a wet basement, or near a swimming pool. Take care not to spill any liquids on the machine.
- Use only the power cord provided with the machine. Do not use an AC extension cord.

- Unplug the machine from the telephone jack and then the power outlet and consult a qualified service representative if any of the following situations occur:
 - Liquid has been spilled into the machine or the machine has been exposed to rain or water.
 - The machine produces odors, smoke, or unusual noises.
 - The power cord is frayed or damaged.
 - The machine has been dropped or the housing damaged.
- Do not allow anything to rest on the power cord, and do not install the machine where people may walk on the power cord.
- Never insert objects of any kind into slots or openings on the machine. This could create a risk of fire or electric shock. If an object falls into the machine that you cannot safely remove, unplug the machine and consult a qualified service representative.
- Do not place this machine on an unstable cart, stand or table. The machine could be seriously damaged if it falls.
- Avoid using a telephone (other than a cordless type) during an electrical storm. There may be a remote risk of electric shock from lightning.
- Do not use a telephone to report a gas leak in the vicinity of the leak.
- The power outlet must be installed near the equipment and must be easily accessible.

Important:

- This machine is not designed for use on a line which has call waiting, call forwarding, or certain other special services offered by your telephone company. If you attempt to use the machine in conjunction with any of these services, you may experience errors during transmission and reception of facsimile messages.
- This machine is not compatible with digital telephone systems.

Table of Contents

Introduction	1
Important safety information	3
Table of Contents	5
A Look at the Operation Panel	8
1. Installation	14
Unpacking Checklist	14
Connections	15
Installing the Print Cartridges	18
Loading Printing Paper	22
Entering Your Name and Fax Number	25
Setting the Date and Time	27
Volume Adjustment	30
2. Sending and Receiving Documents	32
Transmittable Documents	32
Loading the Document	34
Adjusting the Resolution and Contrast	35
Sending a Fax by Normal Dialing	37
Programming Auto-Dial Numbers	39
Sending a Fax by Automatic Dialing	45
Creating and Using Personal Books	54
Cover Sheet	60
Batch Page Numbering (Page Counter)	62
Receiving Faxes	63
Substitute Reception to Memory	65
Dual-line Option (FO-DC600 only)	66
Verification Stamp Option	70
PC Fax Function (Requires the FO-LN1 Option)	71

3. Network Scanner Option	73
<hr/>	
Introduction	73
Setting the IP Address	75
Printing out the Network Settings	78
Mail Server and DNS Server Settings.	79
Storing Network Scanning Destinations	81
Scan to E-mail Setup	84
Scan to E-mail Using the E-mail Key	87
Sending an Image Using a Rapid Key or Speed Dial Number	89
Installing the Network Scanner Software	96
Inbound Routing	103
4. Network Printer Option	109
<hr/>	
Installing the Printer Driver	110
Setting Up Status and Alert Messages	126
Printing from a Computer	128
Opening the Printer Driver	130
Printer Driver Settings.	131
5. Making Copies	136
<hr/>	
6. Special Functions	139
<hr/>	
Broadcasting	139
Confidential Operations	145
Polling	150
Timer Operations	158
Batch Transmission	164
Entering and Using Programs.	166
Duplex Scanning for Two-sided Documents.	176
Print Hold	177
Department Control.	180
Blocking Reception of Unwanted Faxes	183
Telephone Billing	185
Distinctive Ring	187
7. Optional Settings	189
<hr/>	

8. Printing Lists and Reports	200
<hr/>	
9. Maintenance	205
<hr/>	
Cleaning the Scanning Glass and Rollers	205
The Housing	205
Replacing the Verification Stamp	206
10. Troubleshooting	207
<hr/>	
Problems and Solutions	207
Messages and Signals	214
Clearing Paper Jams	217
FCC Regulatory Information	220
QUICK REFERENCE GUIDE	224
<hr/>	
GUÍA DE REFERENCIA RÁPIDA	225
<hr/>	
GUIDE DE RÉFÉRENCE RAPIDE	226
<hr/>	
Index	227
<hr/>	

A Look at the Operation Panel

Upper panel

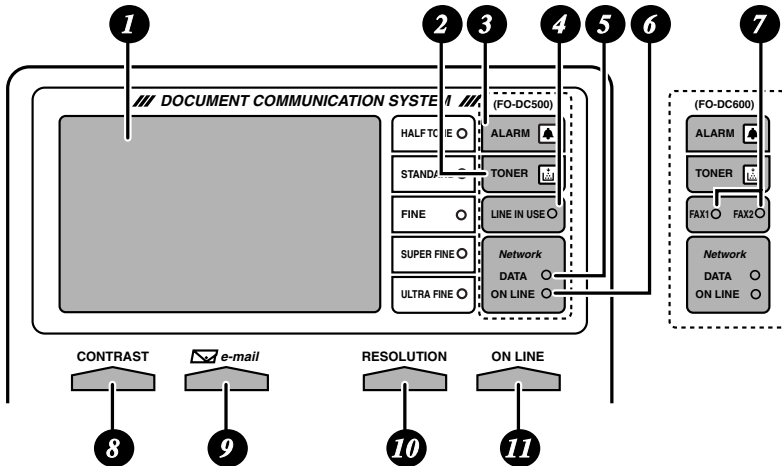

- 1 Display**

This displays messages and prompts to help you operate the machine. The backlight turns on whenever a key is touched, and then automatically turns off after a preset time if no further operations are performed. The display can be tilted to the desired angle for easy viewing.
- 2 TONER indicator**

This blinks when the toner cartridge nears empty, and lights steadily when the toner cartridge needs replacement.
- 3 ALARM indicator**

This blinks when one of the paper sources is empty, or the drum cartridge is near or at the end of its life. This lights steadily when all paper sources are empty, the print compartment cover is open, or a paper jam has occurred. A message will appear in the display to indicate the problem.
- 4 LINE IN USE light (FO-DC500 only)**

This lights when the machine is using the telephone line.
- 5 DATA light**

This blinks when the machine is receiving a print job over the network (only when the network printer option is installed).

- 6 ON LINE light (printer option only)**
When this light is on, the machine can receive data (print jobs) over the network. The light is turned on or off with the ON LINE key. (Only available when the network printer option is installed).
- 7 FAX1 / FAX 2 lights (FO-DC600 only)**
When the dual line option is installed, FAX 1 lights when Line 1 is being used and FAX 2 lights when Line 2 is being used.
When the dual line option is not installed, only FAX 1 lights when the telephone line is being used (the FAX 2 light does not operate).
- 8 CONTRAST key**
Press this key to adjust the contrast before sending or copying a document.
- 9 E-mail key**
Press this key to send a scanned document to an e-mail recipient. (Only available when the network scanner option is installed).
- 10 RESOLUTION key**
Press this key to adjust the resolution before sending or copying a document. An indicator will light next to the selected setting (HALFTONE, STANDARD, FINE, SUPER FINE or ULTRA FINE).
- 11 ON LINE key (printer option only)**
Press this key to select whether the machine is online or off-line (the ON LINE light is on when the machine is online). The machine must be online to receive print jobs over the network. (Only available when the network printer option is installed).

Middle panel (Rapid Key pad)

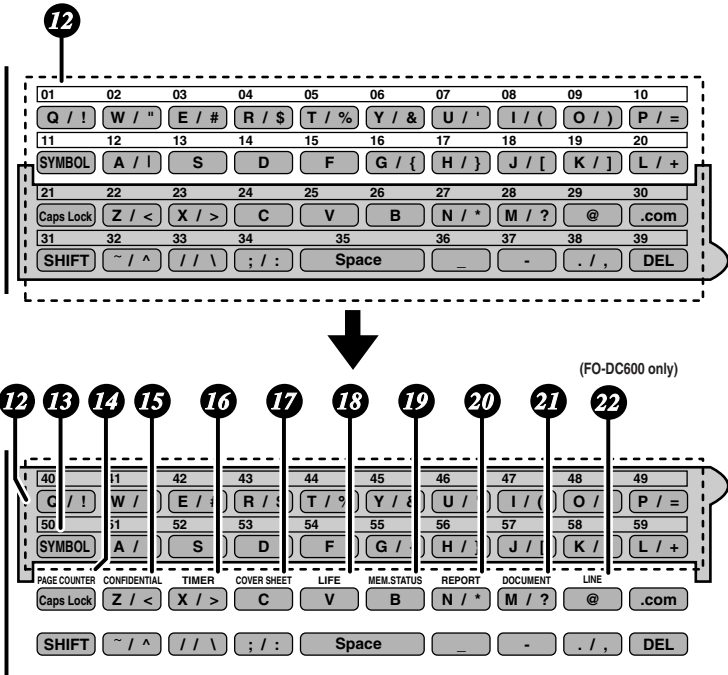

12 Rapid Dial Keys

Press one of these keys to dial a fax number automatically, or specify an e-mail recipient if the network scanner option is installed. Note that you must attach the Rapid Key labels. When navigating through the display menu, a Rapid Key can also be pressed in place of the numeric keys to enter a two-digit number (for example, you can press Rapid Key 01 to enter the number "01").

13 SYMBOL key

When entering a name, press this key to enter the symbol on a letter key (the character to the right of the slash). Press the key again to turn off symbol entry mode.

14 PAGE COUNTER key

Press this key to include a slash and the total number of pages after each page number on the pages of a transmitted document.

15 CONFIDENTIAL key

Press this key to send or print out a confidential document.

16

TIMER key

Press this key to set up a fax operation to be performed automatically at a later time.



17

COVER SHEET key

Press this key to include a cover sheet when sending a fax.

18

LIFE key

Press this key, followed by , to check the total number of pages printed by the machine. (Press  to return to the date and time display.)

19

MEM. STATUS key

Press this key to check the status of fax transmission jobs, copy jobs, and fax receptions. This key can also be used to cancel a job.

20

REPORT key

Press this key before sending a fax (or a Scan to E-mail/FTP/Desktop transmission when the network scanner option is installed) to have a transaction report printed out after the transmission is finished.

21

DOCUMENT key

Press this key to transmit a document directly from the feeder without reading it into memory.

22

LINE key (FO-DC600 only)

When the dual line option has been installed, press this key before dialing to select the line.

Lower panel

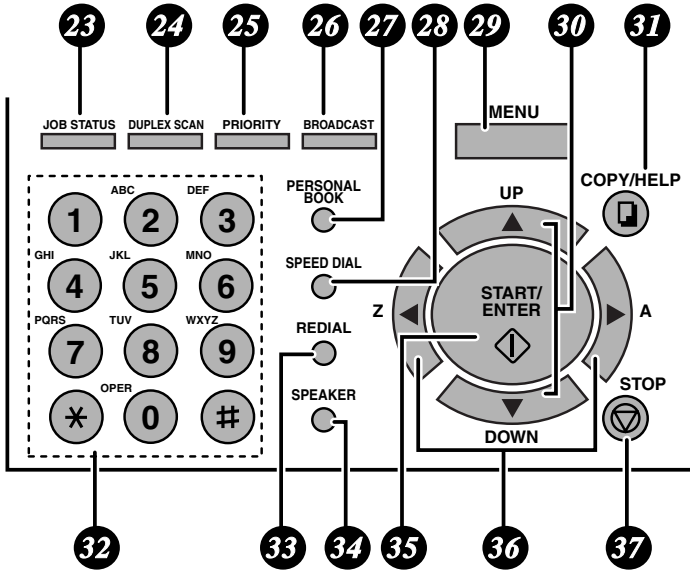

23

JOB STATUS key

Press this key to display the FAX STATUS screen, which shows information on the fax job that is currently in progress. If the dual line option is installed, the fax status will appear separately for each line. If the network printer option is installed, the NETWORK PRINT STATUS screen showing information on current printer activity will appear following the FAX STATUS screen (note that "IDLE" will appear if a print job has been executed but is not yet being printed). To move through each of the screens and return to the date and time display, press  one or more times as needed.

24

DUPLEX SCAN key

Press this key to transmit, copy, or scan a two-sided document.

25

PRIORITY key

Press this key when you need to transmit a document ahead of other documents waiting in memory for transmission.

26

BROADCAST key

Press this key to send a document to a group of fax machines, or to a group of e-mail recipients if the network scanner option is installed.

27**PERSONAL BOOK**

Press this key to use or store an auto-dial number in a personal book. If the book has a passcode, enter the passcode; otherwise, select the book with

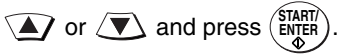
**28****SPEED DIAL key**

Press this key to dial a Speed Dial number.

29**MENU key**

Press this key to select special functions and settings.

30**UP and DOWN arrow keys**

Volume setting: Press these keys to change the speaker volume when the **SPEAKER** key has been pressed, or the ringer volume at any other time.

MENU key settings: Press these keys after pressing the **MENU** key to scroll through the **MENU** key settings.

31**COPY/HELP key**

When a document is in the feeder, press this key to make a copy of a document. At any other time, press this key to print out the Help List, a quick reference guide to the operation of the machine.

32**Dial keypad (numeric keys)**

Use these keys to dial and program fax numbers.

33**REDIAL key**

Press this key to automatically redial the last number dialed.

34**SPEAKER key**

Press this key when faxing a document by Normal Dialing to listen to the line and verify the response of the receiving fax machine.

35**START/ENTER key**

Press this key to begin fax transmission when using Speed Dialing, Direct Keypad Dialing, or Normal Dialing. This key is also used to select settings in the **MENU** key menu and complete entries when storing names and numbers.

36**Left and right arrow keys**

Press these keys to search for an auto-dial number when sending a document.

37**STOP key**

Press this key to cancel an operation before it is completed.

1. Installation

Unpacking Checklist

Before setting up, make sure you have all of the following items. If any are missing, contact your dealer.

Power cord



Telephone line cord



Toner cartridge

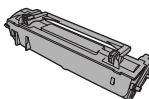

Drum cartridge

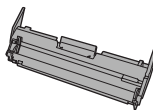

ADF exit tray

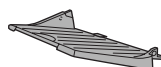

Received document tray



Rapid Key labels



Paper size labels

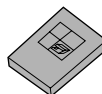

Operation manual

Points to keep in mind when setting up

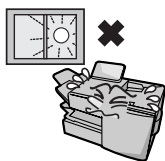

Do not place the machine in direct sunlight.

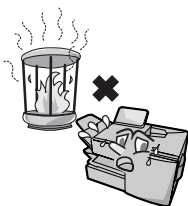

Do not place the machine near heaters or air conditioners.



Keep dust away from the machine.

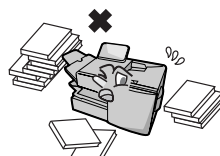

Keep the area around the machine clear.

About condensation

If the machine is moved from a cold to a warm place, it is possible that condensation may form on the scanning glass, preventing proper scanning of documents for transmission. To remove the condensation, turn on the power and wait approximately two hours before using the machine.

Connections

Connecting the power cord

Connect the female end of the power cord to the machine as shown. Insert the male end into a 120 V, 60 Hz, grounded (3-prong) AC outlet.

Important!

The machine requires its own dedicated power outlet. The power outlet must not be shared with any other devices. In particular, do not use an extension cord to connect multiple devices to the outlet.

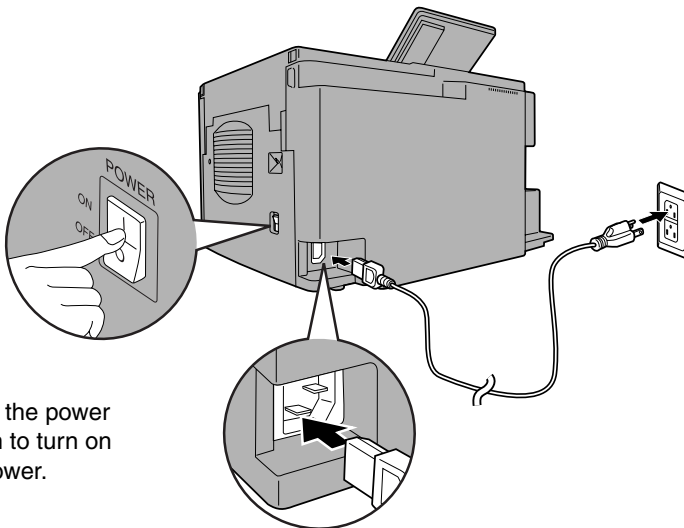

Press the power switch to turn on the power.

Note: If your area experiences a high incidence of lightning or power surges, we recommend that you install surge protectors for the power and telephone lines. Surge protectors can be purchased at most telephone specialty stores.

Connecting the telephone line cord

Insert one end of the line cord into the jack on the back of the machine marked **TEL. LINE**. Insert the other end into a standard (RJ11C) single-line wall telephone jack.

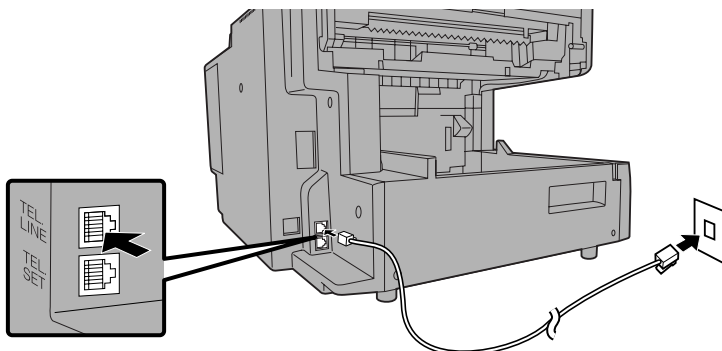

Note: The machine is set for touch-tone dialing. If you are on a pulse dial (rotary) line, you must set the machine for pulse dialing by changing Option Setting 22. See page 195.

Connecting a telephone (optional)

If desired, you can connect a telephone to the **TEL. SET** jack on the back of the machine.

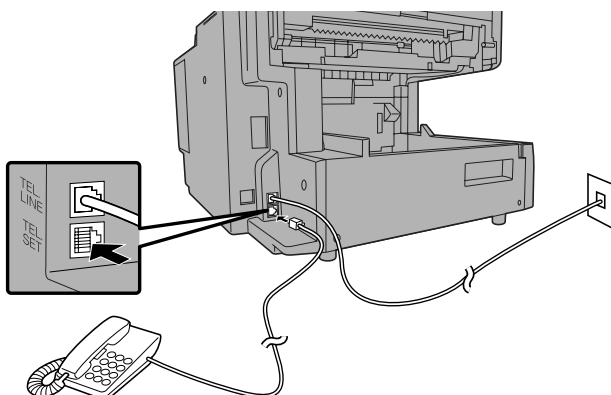

Attaching the ADF exit tray

Insert the protrusion on the right side of the machine into the hole in the right side of the ADF exit tray ❶, then bend the tray slightly and insert so that the protrusion on the left side of the machine goes into the hole on the left side of the ADF exit tray ❷. Pull out the tray extension ❸.

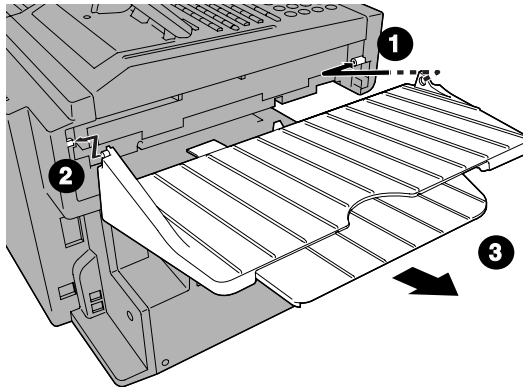

Attaching the received document tray

Slide the received document tray into the machine as shown. When it stops, lift the end slightly and push in so that the tray locks into place.

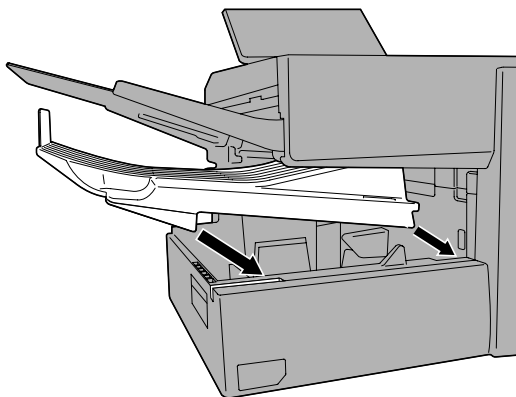

Important!

The received document tray must be attached for the machine to operate properly.

Installing the Print Cartridges

Follow the steps below to install or replace the toner and drum cartridges.

- ◆ The initial starter toner cartridge included with the machine can print approximately 3000 letter-size pages (4% coverage of each page; continuous printing).
- ◆ The replacement toner cartridge (FO-50ND) can print approximately 6000 letter-size pages.
- ◆ The drum cartridge (FO-47DR) can print approximately 20,000 letter-size pages.

1 Press the cover release to open the print compartment cover.

• **Caution!**

The fusing unit inside the print compartment becomes very hot during operation. Be careful not to touch the inside of the compartment.



2 If you are replacing the toner cartridge, remove the old cartridge and dispose of it according to local regulations.

Go directly to Step 5 if you are only replacing the toner cartridge and not the drum cartridge.

- If you are replacing the drum cartridge but not the toner cartridge, remove the toner cartridge and place it on a sheet of paper.

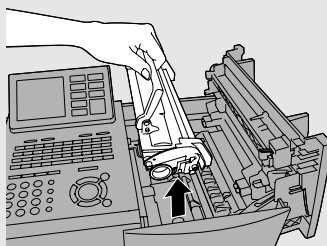

To make the cartridge more compact for disposal, press the buttons on the ends of the handle and fold the handle down.

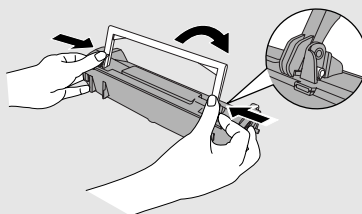

- 3** If you are replacing the drum cartridge, remove the old cartridge and dispose of it according to local regulations.

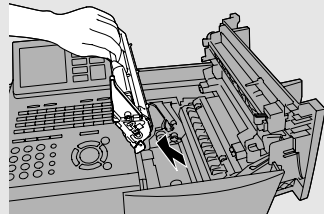

- 4** Remove the new drum cartridge from its packaging. Insert the drum cartridge into the print compartment.

- **Caution!** Excessive exposure to light will damage the drum cartridge. Install the cartridge promptly after removing it from its packaging.
- Make sure the drum cartridge is inserted in as far as it will go.

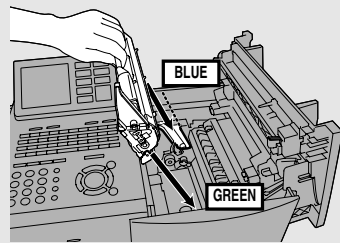

- 5** If you are installing a new toner cartridge, remove the new toner cartridge from its packaging. Remove the tape from the cartridge and then open the cartridge handle so that it stands straight up.

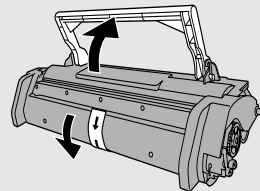

- 6** Shake as indicated by the arrows to distribute the toner evenly within the cartridge.

- If the toner is still lumpy after shaking, the gears in the cartridge may make a noticeable sound when the print compartment cover is closed after installing the cartridge. This is normal and does not indicate a problem.

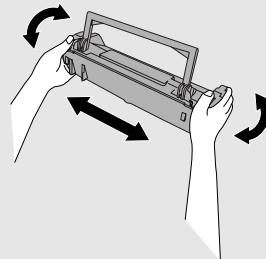



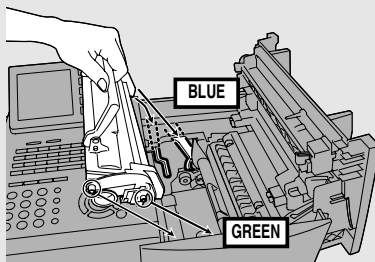

7 Hold the toner cartridge by the handle and insert it into the print compartment.



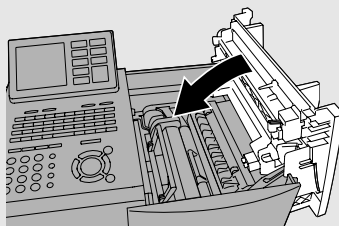

- Make sure the toner cartridge clicks into place.
- The handle can be left standing up.



8 Close the print compartment cover.



9 Reset the drum counter by pressing **LIFE**  (flip up the Rapid Key overlay),  or  until **DRUM COUNTER CLEAR** is selected in the display, and then  twice.

- **Note:** The toner counter automatically resets each time you replace the toner cartridge. There is normally no need to reset the toner counter manually. Should you find it necessary to manually reset the toner counter, press **LIFE**  (flip up the Rapid Key overlay),  or  until **TONER COUNTER CLEAR** is selected, and then  twice.

Note: The print compartment cover may become noticeably warm if a large number of pages are successively printed. This is normal and does not indicate a problem in the machine.

When to replace the toner cartridge

When the toner cartridge nears empty (about 100 pages can still be printed), the toner cartridge indicator on the operation panel will blink. When the toner cartridge is empty, the toner cartridge indicator will light steadily and REPLACE TONER will appear in the display. Printing will no longer be possible. Use the following replacement toner cartridge:

Sharp FO-50ND toner cartridge

Hint:

When the toner cartridge nears empty, try taking it out of the machine and shaking it. This may increase the number of pages that can be printed before the toner runs out.

When to replace the drum cartridge

When the drum cartridge nears the end of its life, the ALARM indicator on the operation panel will blink and DRUM LIFE REACHED will appear in the display (this message first appears approximately 1000 pages before the drum needs replacement). Use the following replacement drum cartridge:

Sharp FO-47DR drum cartridge

Loading Printing Paper

You can load up to 250 sheets of letter or legal paper (max. 20 lbs.) in the paper tray.

FO-DC500: A paper cassette is available as an option. Up to 500 sheets of letter or legal paper can be loaded in the paper cassette. To have the cassette installed, consult your dealer.

FO-DC600: One paper cassette is included as a standard feature. An additional paper cassette is available as an option. Up to 500 sheets of letter or legal paper can be loaded in each paper cassette. To have an additional cassette installed, consult your dealer.

Important: Do not use the back side of paper that has already been printed on.

Note: If you need to add paper to the tray or cassette while paper still remains, remove the remaining paper and combine it into a single stack with the new paper.

Loading paper in the paper tray

1 Remove the received document tray.

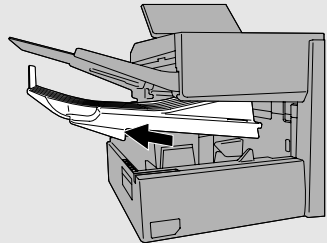

2 Insert a stack of paper into the tray, print side up.

- **Important!** The stack of paper must not be higher than the red line on the paper tray.

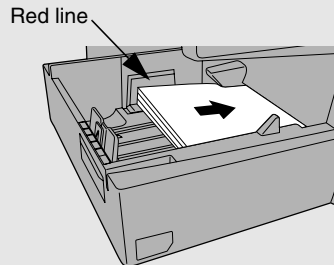

- 3** Squeeze the paper guide and move it to match the length of the paper you are loading.

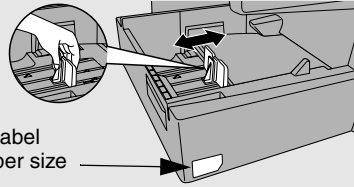

Attach a letter or legal label here to indicate the paper size

- 4** Replace the received document tray.

- The received document tray must be attached for the machine to operate properly.

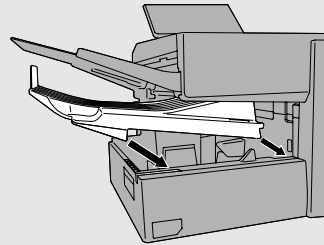

Loading paper in the paper cassette (if installed)

Note: To use A4 paper in the paper cassette, you must have a service technician adjust the cassette.

- 1** Grasp the hand-hold on the cassette and pull the cassette out until it stops.

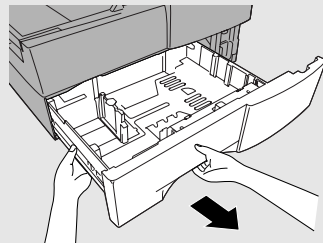

- 2** Push the pressure plate down until it locks into position.

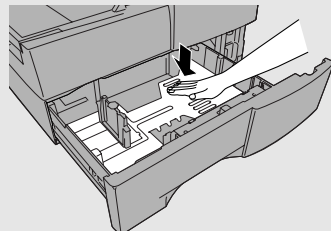

- 3** Squeeze the paper guide and pull up to move it to the appropriate holes for the length of the paper. Push the guide down into the holes.

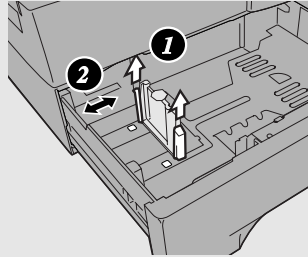

- 4** Place a stack of paper in the cassette, print side up.

- Make sure the stack of paper is not higher than the two tabs on the paper guide and the two metal tabs. If it is, remove some of the paper.
- If you find it difficult to load the paper, remove the cassette from the machine. (Pull the cassette out as far as it will go, grasp the left side of the cassette with your left hand, and then lift it up and out with both hands.)

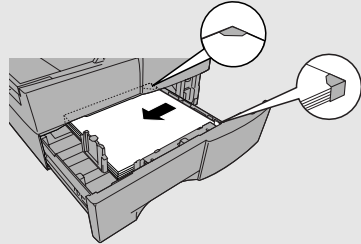

- 5** Push the cassette back into the machine, making sure it clicks into place.

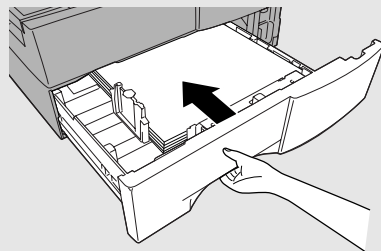



Entering Your Name and Fax Number

Before you can begin using the machine, you must program your name and fax number. Once you program this information, it will appear automatically at the top of each fax page you send.

Important!



FCC regulations require that your name, telephone/fax number, and the date and time appear on each fax message you send. Enter your name and fax number here and set the date and time as explained in the following section to have the machine include this information automatically at the top of your fax messages.

Note: If you have installed the dual-line option, use the procedure on page 66 to enter your name and the number of each line.

- 1** Press **MENU** and then  or  until **ENTRY MODE** is selected in the display.

Display:

```
MENU MODE
 1:RECEIVE MODE
 2:LISTING MODE
▶ 3:ENTRY MODE
```



- 2** Press  and then  or  until **OWN PASSCODE SET** is selected.

```
ENTRY MODE
 01:DESTINATION SETTING
 02:PASSCODE SETTING
▶ 03:OWN PASSCODE SET
```

- 3** Press .

```
OWN PASSCODE SET
SENDER'S NUMBER
```

- 4** Enter your fax number (max. of 20 digits) by pressing the numeric keys.







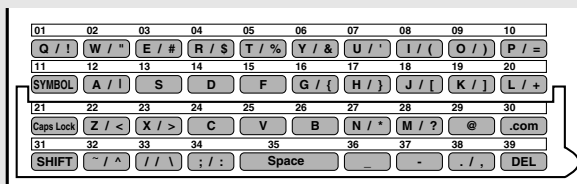

- To insert a space between digits, press .
- To clear a mistake, press .

5 Press .

6 Flip the Rapid Key overlay down (if it is up), and enter your name by pressing the appropriate letter keys as shown below. (Max. of 24 characters.)

Example: SHARP =      





- To enter a space, press .
- To change case, press .
- To clear a mistake, press .
- To enter a number as part of a name, press the appropriate numeric key. To enter the symbol on a letter key (the character to the right of the slash), press  ("SYM" will appear in the display) and then the letter key (press  again to turn off symbol entry mode).
- To move the cursor, press  or . To switch between letter insertion and letter replacement mode when the cursor is in the middle of a sequence of letters, press .

7 Press .

8 Press  twice to return to the date and time display.



Setting the Date and Time

The date and time appear in the display, in reports, and at the top of each page you transmit. Set the date and time by pressing the keys on the operation panel as shown below.

- 1** Press **MENU** and then  or  until **ENTRY MODE** is selected in the display.

Display:

```
MENU MODE
 1:RECEIVE MODE
 2:LISTING MODE
▶ 3:ENTRY MODE
```

- 2** Press  and then  or  until **DATE&TIME SET** is selected.

```
ENTRY MODE
 01:DESTINATION SETTING
 02:PASSCODE SETTING
 03:OWN PASSCODE SET
▶ 04:DATE&TIME SET
```

- 3** Press .

The currently set date and time appear

```
DATE&TIME SET MODE
01-10-2004
TIME 11:35 AM
```

- 4** Enter a two-digit number for the month (“01” for January, “02” for February, “12” for December, etc.).

Example: March **0** **3**

- To correct a mistake, press  to move the cursor back to the mistake and then enter the correct number.



- 5** Enter a two-digit number for the day (“01” to “31”).

Example: The 5th **0** **5**

6 Enter the year (four digits).

Example: 2004    

7 Enter a two-digit number for the hour (“01” to “12”) and a two-digit number for the minute (“00” to “59”).

Example: 9:25    



8 Press  to select A.M. or  to select P.M.

9 Press  to start the clock.

10 Press  twice to return to the date and time display.



Daylight Saving Time

If desired, you can set the clock to move forward and backward automatically at the beginning and end of Daylight Saving Time.

- 1** Press **MENU** and then  or  until **ENTRY MODE** is selected in the display.

Display:

MENU MODE
 1:RECEIVE MODE
 2:DESTINATION SETTING
 ► 3:ENTRY MODE

- 2** Press  and then  or  until **DAY LIGHT SAVING** is selected.

02: PASSCODE SETTING
 03:OWN PASSCODE SET
 04:DATE&TIME SET
 ► 05: DAY LIGHT SAVING



- 3** Press .

DAY LIGHT SAVING
 1=YES
 2=NO

- 4** Press **1** to turn on the Daylight Saving Time function, or **2** to turn it off.



- 5** Press  twice to return to the date and time display.

Volume Adjustment

You can adjust the volume of the speaker and ringer using  and .

Speaker

1 Press .

2 Press  or  to select the desired volume level.

Display:

ONHOOK DIAL MODE
SPEAKER VOLUME
HIGH





ONHOOK DIAL MODE
SPEAKER VOLUME
MIDDLE



ONHOOK DIAL MODE
SPEAKER VOLUME
LOW

3 Press  to turn off the speaker.

Ringer

- 1** Press the  or  to select the desired volume level. (Make sure **SPEAKER**  has not been pressed.)

- The ringer will ring once at the selected level, and then the date and time will reappear in the display.

Display:

RINGER VOLUME
HIGH



RINGER VOLUME
MIDDLE



RINGER VOLUME
LOW



RINGER VOLUME
OFF
IF OK, PRESS ENTER KEY

- 2** If you selected “RINGER VOLUME OFF” to turn off the ringer, press  to confirm your selection.

2. Sending and Receiving Documents

Transmittable Documents

Size and weight

The size and weight of documents that you can load in the document feeder depend on whether you load one page at a time or several pages at once.

Loading one page at a time:

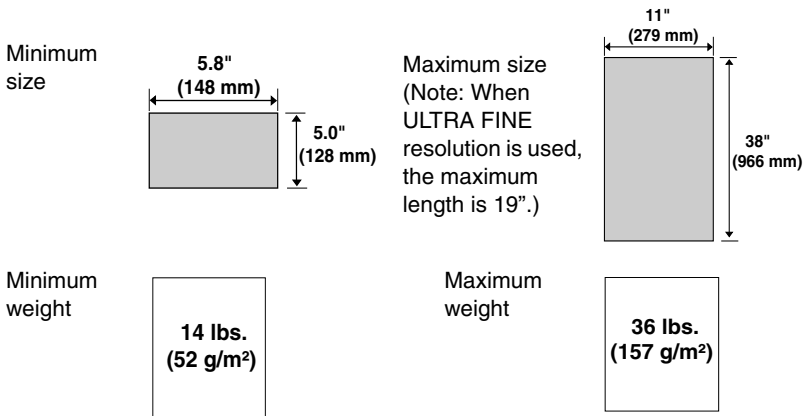

Loading multiple pages at once (letter-size: max. 50 pages, legal-size: max. 20 pages):

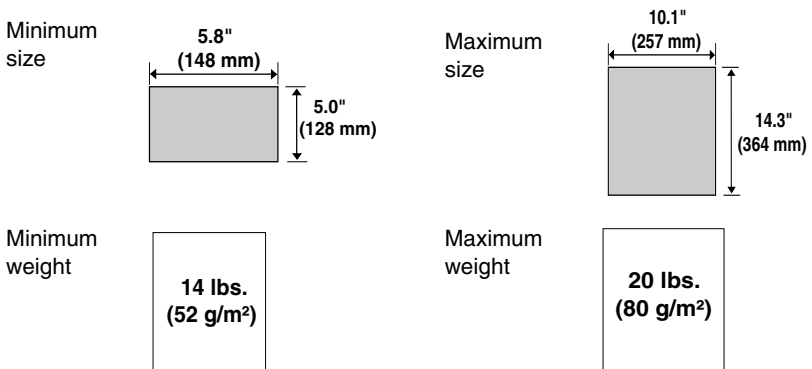

Note: 11" x 17" paper must be loaded one page at a time.

Maximum scanning area

The area of the document that the machine can scan is slightly smaller than the actual document size. Any letters or graphics outside this area will not be scanned.

Maximum scanning width: 10 inches (256 mm)

Maximum scanning length: The length of the document minus 0.16 inches (4 mm) from the top and bottom of the document.

Other restrictions

- ◆ The scanner cannot recognize yellow, greenish yellow, or light blue ink.
- ◆ Ink, glue, and correcting fluid on documents must be dry before they pass through the document feeder.
- ◆ All clips, staples, and pins must be removed from documents before loading in the feeder. If these are not removed, they may damage the machine.
- ◆ Documents which are patched, taped, torn, smaller than the minimum size, carbon backed, easily smudged, or have a slick, coated surface should be photocopied, and the copy loaded in the feeder.

Loading the Document

Up to 50 letter-sized pages (20 legal-sized pages) can be placed in the feeder at one time. The pages will automatically feed into the machine starting from the bottom page.

- ◆ If you need to send or copy more than 50 pages, place the additional pages gently and carefully in the feeder just before the last page is scanned. Do not try to force them in, as this may cause double-feeding or jamming.
- ◆ If your document consists of several large or thick pages which must be loaded one at a time, insert each page into the feeder as the previous page is being scanned. Insert gently to prevent double-feeding.
- ◆ If there are folds on the document, smooth out the folds before loading the document. Unsmoothed folds may prevent correct scanning.
- ◆ When scanning a very long document, gently hold the sides of the document while it feeds into the scanner to prevent skewing.

1 Adjust the document guides to the width of your document.



2 Place the document face down and push it gently into the document feeder. The top edge of the document should enter the machine first.

- SEND READY will appear in the display.

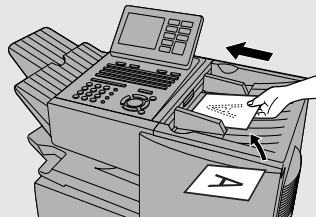

Note: When inserting a large number of pages in the feeder, slant the front end of the stack so that the bottom pages enter first.

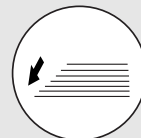

- 3** Adjust the resolution and/or contrast settings (if desired) and then dial the receiving machine as explained in the following sections.

Adjusting the Resolution and Contrast

If desired, you can adjust the resolution and contrast before sending a document.

Resolution

The machine has four resolution settings:

STANDARD	Use STANDARD for ordinary documents. This setting gives you the fastest and most economical transmission.
FINE	Use FINE for documents containing small letters or fine drawings.
SUPER FINE	Use SUPER FINE for documents containing very small letters or very fine drawings.
ULTRA FINE	Use ULTRA FINE for the highest level of document reproduction.
HALF TONE	Use HALF TONE for photographs and illustrations. The original will be reproduced in 64 shades of gray.

The default resolution setting is STANDARD. If you don't adjust the resolution before sending a document, the machine will automatically use STANDARD resolution.

- ◆ In order to transmit in FINE, SUPER FINE, or ULTRA FINE resolution, the receiving machine must also have that resolution. If it doesn't, the next best available setting will be used.
- ◆ The resolution settings are only effective for transmitting and copying a document. They are not effective for receiving a document.

Adjusting the Resolution and Contrast

To adjust the resolution setting, press  one or more times until the indicator light next to the desired setting comes on.

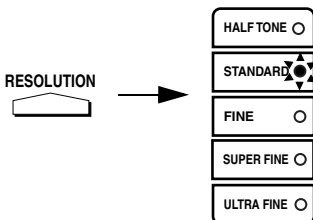

Contrast

The machine has three contrast settings. The default setting is AUTO.

AUTO Use AUTO for normal documents.

DARK Use DARK for faint documents.

LIGHT Use LIGHT for documents with a dark background.

To adjust the contrast, press  until the desired setting appears in the display.

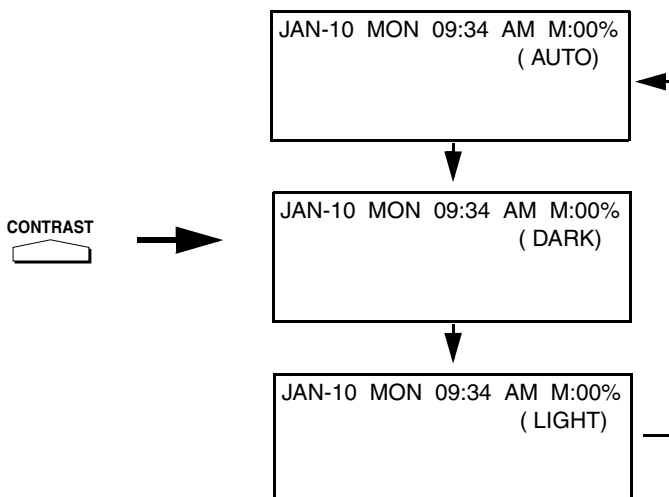



Sending a Fax by Normal Dialing

With Normal Dialing, you press  and then dial by pressing the numeric keys.

- ◆ Normal Dialing allows you to listen to the line through the speaker to make sure the other fax machine is responding. (Note that the speaker is not a speakerphone; it cannot be used for talking.)
- ◆ If you have connected an extension telephone to the machine, you can also pick up the extension phone and dial using the extension phone (do not press  on the machine). If a person answers, you will be able to speak to them through the phone before sending a fax.

Note: If you press  to dial, you will not be able to speak using an extension phone connected to the machine in the event that a person answers.

1 Load the document(s). (Note: If desired, you can load the document after dialing in Step 3, below.)

- SEND READY will appear in the display.
- Press  and/or  to set the resolution and contrast if needed.

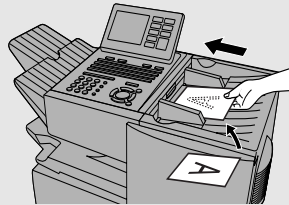

2 Press or pick up an extension phone connected to the machine. Listen for the dial tone.

3 If you pressed , dial the number of the receiving machine by pressing the numeric keys on the machine.

If you are using an extension phone, dial using the keypad on the extension phone.



Sending a Fax by Normal Dialing

- If Option Setting 26 (TEL. BILLING CODE, page 196) has been set to ON and BILLING CODE DIAL has been set to AFTER, press  after dialing.

4 Wait for the connection. When you hear a fax tone, press on the machine.

- If a person answers and you are using an extension phone, ask them to press their Start key. When you hear the fax tone, press  on your machine.

Using the REDIAL key

You can press  to redial the last number dialed. To send a document, press  when you hear the fax tone after the connection is established.

Note that the speaker is automatically activated when you press .

Programming Auto-Dial Numbers

You can dial a fax number by simply pressing a Rapid Key, or by pressing



and entering an abbreviated Speed Dial number.



To use a Rapid Key or Speed Dial number, you must first program the full fax number in the Rapid Key or Speed Dial number. It is usually convenient to program your most frequently dialed numbers in Rapid Keys.

- ◆ Up to 59 Rapid Keys can be programmed for shared use.
- ◆ Up to 100 Speed Dial numbers can be programmed for shared use on the FO-DC500. Up to 200 Speed Dial numbers can be programmed for shared use on the FO-DC600.

You can also create personal books for auto-dial numbers. Up to 59 Rapid Keys and 16 Speed Dial numbers can be stored in each personal book. For information on creating and using personal books, see page 54.

Programming Auto Dial numbers through a PC (Network Scanner option required)

The following procedure explains how to store fax numbers using the operation panel of the machine. If the network scanner option is installed, you can also conveniently store fax numbers in Rapid Keys and Speed Dial numbers by accessing the Web page in the machine from your computer. See page 82 for more information. To store an e-mail address in a Rapid Key or Speed Dial number using the operation panel, see page 89.

- 1** Press **MENU** and then  or  until **ENTRY MODE** is selected in the display.

Display:

```
MENU MODE
 1:RECEIVE MODE
 2:LISTING MODE
▶ 3:ENTRY MODE
```

- 2** Press . Make sure that **DESTINATION SETTING** is selected.

```
ENTRY MODE
▶ 01:DESTINATION SETTING
 02:PASSCODE SETTING
 03:OWN PASSCODE SET
```

3 Press . Make sure that SET is selected.



DESTINATION SETTING

- ▶ 1=SET
- 2=CLEAR

4 Press 



DESTINATION SET
PRESS RAPID OR SPEED

5 To program a Rapid Key number, press the Rapid Key that you wish to use. (To select Rapid Keys 40 through 59, flip up the Rapid Key overlay.)

To program a Speed Dial number, press  and then enter the number that you wish to use (“1” to “100” on the FO-DC500, or “1” to “200” on the FO-DC600). (If you enter less than three digits, press  to complete the entry.)

6 If the network scanner option is installed, SELECT DESTINATION TYPE will appear in the display. Make sure that “FAX” is selected (press  or  if needed), and then press . (To program an e-mail address in an auto-dial number, see page 89.)

7 Enter the fax number by pressing the numeric keys (maximum of 60 digits including pauses).







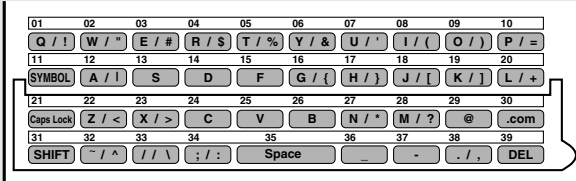

- To clear a mistake, press .
- If a pause is required between any of the digits to access a special service or an outside line, press  (two seconds per pause). The pause will appear as a hyphen. Several pauses can be entered in a row.

8 Press 

9 Enter the name of the party by pressing the letter entry keys (max. of 20 characters). (Make sure the Rapid Key overlay is flipped down.)



Example: SHARP =      







- To enter a space, press  .
- To change case, press  .
- To clear a mistake, press  .
- To enter a number as part of a name, press the appropriate numeric key. To enter the symbol on a letter key (the character to the right of the slash), press  (“SYM” will appear in the display) and then the letter key (press  again to turn off symbol entry mode).
- To move the cursor, press  or  . To switch between letter insertion and letter replacement mode when the cursor is in the middle of a sequence of letters, press  .

10 Press  .

DESTINATION SET
CHAIN DIAL
1=YES
▶ 2=NO

11 Press  or  to select “YES” if the number programmed is an area code or access code to be used for Chain Dialing (see *Chain Dialing* at the end of this procedure). Select “NO” if the number is a regular fax number. After making the selection, press  .

12 If the dual-line option is installed (and Chain Dial was set to NO in the above step), **SELECT THE LINE** will appear. Select **LINE-1** if you want the auto-dial number to use only Line 1. Select **LINE-2** if you want the auto-dial number to only use Line 2. Select **AUTO** if you want the auto-dial number to use the first available line. Press  or  to make the selection, and then press .

13 Return to Step 5 to program another number, or press  repeatedly to return to the date and time display.

- If you programmed a Rapid Key number, you can write the name of the party on the label above the Rapid Key.

Chain Dialing for area and access codes

You can also program an area code or access code in a Rapid Key or Speed Dial number using the above programming procedure. In Step 10, select “YES” to set the number as a Chain Dialing number.

After you dial an area code or access code using a Rapid Key or Speed Dial number set for Chain Dialing, the machine will wait for you to dial the remainder of the number (you can dial the remainder of the number by pressing a Rapid Key, by pressing the Speed Dial key and entering a Speed Dial number, or by pressing numeric keys). Note that the remainder of the number should **not be set** as a Chain Dial number if programmed in a Rapid Key or Speed Dial number.



- ◆ The maximum number of digits that can be dialed at one time by Chain Dialing is 60.

Editing auto-dial numbers

To make changes in a number previously stored, repeat the programming procedure. Select the Rapid Key or Speed Dial number for which you want to make changes in Step 5, and then change the number(s) and/or name(s) when they appear in the display (Steps 7 and 9).

Clearing auto-dial numbers

Note: You cannot clear a number if it is used in a program or timer operation, or if it is included in a Group Key. First clear the number from the operation or group, then perform the following clearing procedure. To check where the number is used, print out the Program/Group List or the Timer List as explained on page 200.

- 1** Press **MENU** and then  or  until **ENTRY MODE** is selected in the display.

Display:

```
MENU MODE
 1:RECEIVE MODE
 2:LISTING MODE
▶ 3:ENTRY MODE
```

- 2** Press . Make sure that **DESTINATION SETTING** is selected.

```
ENTRY MODE
▶ 01:DESTINATION SETTING
 02:PASSCODE SETTING
 03:OWN PASSCODE SET
```



- 3** Press . Press  to select **CLEAR**.

```
DESTINATION SETTING
 1=SET
▶ 2=CLEAR
```

- 4** Press .

```
DESTINATION CLEAR
PRESS RAPID OR SPEED
```

5 To clear a Rapid Key, press the Rapid Key.

To clear a Speed Dial number, press  and then enter the number with the numeric keys. (If you enter less than three digits, press  to complete the entry.)

6 Press .

7 Return to Step 5 to clear another number, or press  repeatedly to return to the date and time display.

Sending a Fax by Automatic Dialing

Dual Access

The machine features full dual access, which means that you can load a document and dial by automatic dialing even when the machine is occupied with another job. After you dial, your document will be immediately scanned into memory and then transmitted once all previously stored jobs have been completed.

If more than one document has been scanned into memory for transmission, the documents (jobs) will be transmitted in the order in which they were scanned. If you have an urgent transmission and do not want to wait until previously stored jobs are completed, you can press **PRIORITY** after loading your document. Your document will be transmitted immediately after the current job is finished.

If you don't want the document to be transmitted from memory, you can press **DOCUMENT** **M/?** after loading the document. Your machine will call the receiving fax machine immediately after the current job is finished (ahead of any previously stored jobs in memory), and the document will be scanned as soon as the connection is established.

- ◆ The FO-DC500 can hold approximately 500 pages of average content in memory. The FO-DC600 can hold approximately 1,000 pages. Less pages can be held if any were scanned using fine, super fine, ultra fine, or halftone resolution.
- ◆ The amount of memory currently occupied appears as a percentage ("M:00%") in the display.

Rapid Key Dialing

If the number you want to dial has been programmed in a Rapid Key, you can dial it by pressing the Rapid Key.

1 Load the document(s).

SEND READY will appear in the display.

- Press **RESOLUTION** and/or **CONTRAST** to set the resolution and contrast if needed.
- To send the document ahead of other documents waiting for transmission, press **PRIORITY**.
- To send the document directly from the feeder (not through memory), press **DOCUMENT** (M/?). (Flip up the Rapid Key overlay if it is down.)

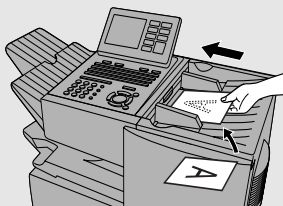

2 Press the appropriate Rapid Key.





- The name of the receiving party will appear in the display. (If the destination is not correct, press **STOP**.)
- The document will be automatically transmitted once the connection is established.

Speed Dialing

If the number you want to dial has been programmed in a Speed Dial number, you can dial it by pressing  and then entering the Speed Dial number.

1 Load the document(s).

SEND READY will appear in the display.

- Press  and/or  to set the resolution and contrast if needed.
- To send the document ahead of other documents waiting for transmission, press .
- To send the document directly from the feeder (not through memory), press . (Flip up the Rapid Key overlay if it is down.)

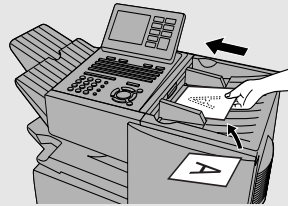

2 Press and then enter the Speed Dial number by pressing the numeric keys.

- If you enter less than 3 digits for the Speed Dial number, press  to complete the entry.

3 Check the display. If the destination shown is correct, press . (If not, press and then repeat Step 2.)

Direct Keypad Dialing

You can also enter a full number with the number keys and then press



to begin dialing.

- 1 Load the document(s).** (Note: If desired, you can load the document after dialing in Step 2, below.)

SEND READY will appear in the display.

- Press **RESOLUTION** and/or **CONTRAST** to set the resolution and contrast if needed.
- To send the document ahead of other documents waiting for transmission, press **PRIORITY**.
- To send the document directly from the feeder (not through memory), press **DOCUMENT M/?**. (Flip up the Rapid Key overlay if it is down.)

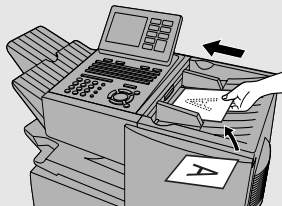

- 2 Enter the number of the receiving machine by pressing the numeric keys.**

- If a pause is required between any of the digits to access a special service or an outside line, press **REDIAL** (two seconds per pause). The pause will appear as a hyphen. Several pauses can be entered in a row.

- 3 Check the display. If the number of the receiving machine shown is correct, press**  **.**

- If it is not correct, press **STOP** to backspace and clear one digit at a time, and then re-enter the correct digit(s).

Searching for an auto-dial number



If you don't remember the Rapid Key or Speed Dial number in which you have programmed a particular fax number, you can search for the number by following the steps below. Once you have found the number, you can dial it

and transmit the loaded document by simply pressing .

- ◆ You can also use this procedure to search for Group Keys and Program Keys (the name you programmed for the Group or Program key will appear). This can be done at any point in a transmission or polling procedure where you need to press a Group Key or a Program Key.

1 Load the document(s).

SEND READY will appear in the display.

- Press  and/or  to set the resolution and contrast if needed.

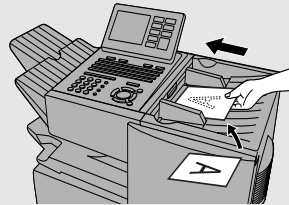

- ### 2 Press A to search from the beginning of the alphabet, or Z to search from the end.

Display:



```
SEARCH [ ]
▶ AAAAAAA
AAAAA AAA
BBBBBBBB
```

The names of your stored destinations appear

- ### 3 Enter the first character of the stored name by pressing the appropriate letter entry key.

- If you don't remember the first letter, go to Step 4 (you will scroll through the list from the beginning).

- ### 4 Press or to scroll through the names. Stop when the desired name appears in the display.

- If no numbers have been stored under the entered letter, NOT FOUND will appear.
- If multiple fax numbers (or e-mail addresses) have been stored under a name, press A to display the fax numbers and then press  or  to select the desired fax number (or e-mail address).

5 Press . **The document will be automatically transmitted once the connection is established.**

Chain Dialing

An auto-dial number set for Chain Dialing can be combined with another auto-dial number or digits entered manually with the numeric keys to dial one phone number up to 60 digits long. The following are some examples of how this can be done:

- ◆ Press appropriate Rapid Keys in the proper order. For example, press Rapid Key 01 (set for Chain Dialing), then Rapid Key 02 (not set for Chain Dialing).
- ◆ Press a Rapid Key (set for Chain Dialing) and then manually enter a number by pressing appropriate numeric keys. Press  after the final numeric key to begin transmission.

If the memory becomes full...

If the memory becomes full while a document is being scanned, MEMORY FULL will appear in the display. If Option Setting 23 (Quick On-line) is set to ON, scanning will automatically resume when memory becomes free again as pages are transmitted. (Note: Quick On-Line is initially set to ON at the factory. To change the setting, see page 195.)

If Quick On-Line is set to OFF the transmission will be canceled and MEMORY FULL ERROR will appear in the display. Press  to clear the message. Try the transmission again later when memory is free.

Checking the status of the current job

The display normally shows the date and time and prompts related to operations you are performing. To check and see what number the machine is currently calling or transmitting to, or what number the machine is currently receiving a document from (if this information is available), press **JOB STATUS** . Information on the current fax job (FAX STATUS) will appear in the display. If the dual line option is installed, the fax status will appear separately for each line. To switch back to the date and time display, press **JOB STATUS** one or more times as needed. (If the network printer option is installed, the NETWORK PRINT STATUS screen showing current printer activity will also appear.)

To cancel a fax transmission or reception

To cancel a fax transmission or reception that is currently in progress, press **JOB STATUS** so that the status of the transmission or reception appears in the FAX-STATUS display, and then press **STOP** .

Checking and canceling stored transmission jobs

To display information on fax jobs that are waiting in memory for transmission, follow the steps below. You can also use this procedure to cancel a fax job.

- 1** Press **MEM.STATUS** **B** (flip up the Rapid Key overlay) and then **▲** or **▼** until **MEMORY TX STATUS** is selected in the display.

Display:

```
MEMORY STATUS REPORT
1: COPY STATUS
▶ 2: MEMORY TX STATUS
3: MEMORY RX STATUS
4: MESSAGE CLEAR
```

- 2** Press **START/ENTER** **⬇** .

- The fax jobs appear.
- To print out the list of the jobs,

press **REPORT** **N/*** .



Number of stored transmission jobs





3-digit memory number assigned to job

Name or number of destination





Status of job

```
TX STATUS (004)
▶ 001: M#132 10:34 AM
XXXXX Co.: RECALL (01)
002: M#135 10:38 AM
YYYYYY Co.: WAITING
```

3 Press  or  to scroll through the list of jobs.



To cancel a job, press  or  to select the job, press , and then press .

4 When you have finished checking the list, press  twice to return to the date and time display.

Note: To directly print out a list of the jobs waiting in memory for transmission, press ,  or  to select REPORT PRINT, and then .

Canceling a memory transmission by number

If you know the memory number assigned to a memory transmission, you can cancel it with the following procedure. (If you don't know the memory number, use the preceding procedure.)

1 Press  (flip up the Rapid Key overlay) and then  or  until MESSAGE CLEAR is selected in the display.

Display:

```
MEMORY STATUS REPORT
1: COPY STATUS
2: MEMORY TX STATUS
3: MEMORY RX STATUS
▶ 4: MESSAGE CLEAR
```

2 Press .

3 Enter the 3-digit memory number of the job you wish to cancel.

4 Press .

Automatic redialing

If you use automatic dialing (including Direct Keypad Dialing) and the line is busy, the machine will automatically redial the number. The machine is set at the factory to make 2 redialing attempts at intervals of 5 minutes.

To cancel automatic redialing, cancel the job as explained in *Checking and canceling stored transmission jobs* on page 51.

If desired, you can change the number of redial attempts with Option Setting 6, and the interval at which redialing takes place with Option Setting 7 (see page 191).

- ◆ Under certain conditions (for example if a person answers the call on a telephone), automatic redialing may stop before the set number of redialing attempts are made.

Memory Retransmission

If a line error occurs during any type of memory transmission, your fax will automatically redial the number and attempt to complete the transmission. Retransmission will begin from the page which was being transmitted when the error occurred.

The machine has been set at the factory to make 10 attempts at retransmission, with each attempt made immediately after the previous attempt. If desired, you can change the number of attempts by changing Option Setting 17, and have the fax wait a selected number of minutes between each attempt by changing Option Setting 18 (see page 194).

- ◆ The numbering of pages retransmitted will begin from "1" again.
- ◆ If an error or power failure occurs during transmission of a cover sheet, retransmission will not take place.
- ◆ To cancel retransmission, cancel the job as explained in *Checking and canceling stored transmission jobs* on page 51.



Creating and Using Personal Books

Personal books can be created that allow individuals to program Rapid Key and Speed Dial numbers for their own personal use. Up to 20 books can be created in the FO-DC500, or 40 books in the FO-DC600.

- ◆ Up to 59 Rapid Key numbers and 16 Speed Dial numbers can be programmed in each personal book.
- ◆ You can program a 4-digit passcode for a personal book. When this is done, the passcode must be entered to use or edit the book.



Creating a personal book

To create a new personal book, follow the steps below:

- 1** Press **MENU** and then  or  until **ENTRY MODE** is selected in the display.

Display:

```
MENU MODE
 1:RECEIVE MODE
 2:LISTING MODE
▶ 3:ENTRY MODE
```

- 2** Press  and then  or  until **BOOK ENTRY MODE** is selected in the display.

```
ENTRY MODE
06:ID # MODE
07:SYSTEM # MODE
08:STORE JUNK FAX #
09:DEPT. PASSCODE
▶ 10:BOOK ENTRY MODE
```

- 3** Press . Make sure that **SET** is selected.

```
PERSONAL BOOK SETTING
▶ 1=SET
 2=CLEAR
```

- 4** Press .

```
PERSONAL BOOK SET
BOOK #=
```



5 Enter a 2-digit number from 01 to 20 (FO-DC500) or 01 to 40 (FO-DC600).

- This number will identify the personal book.

6 Enter a name for the personal book by pressing the letter entry keys. (Make sure the Rapid Key overlay is down.)

Example: SHARP =      

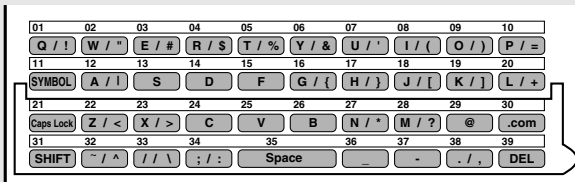
- For more information on entering letters, see Step 5 on page 26.





7 Press .

8 Enter a four-digit passcode for the personal directory book (this can be any four-digit number you like). If you do not wish to use a passcode,

press  to skip this step.

PERSONAL BOOK SET
 USING NAME AS FAX HEADER
 ► 1=YES
 2=NO

9 Press  or  to select YES if you wish to use the book name in the header of faxes sent using the book. Select NO to use the sender's name entered on page 25.

10 Press .

11 If the network scanner option is not installed, this completes the procedure. Press  repeatedly to return to the date and time display.

If the network scanner option is installed, press the letter keys to enter the sender's name that will appear when you send a document to an e-mail recipient from the book.

- This sender's name and the e-mail address entered below will be used in place of the default name and address entered in the procedure on page 84. These are used whenever a sender's name and e-mail address are not entered manually when sending a document to an e-mail recipient.
- Make sure the Rapid Key overlay is down. For more information on entering letters, see Step 5 on page 26.

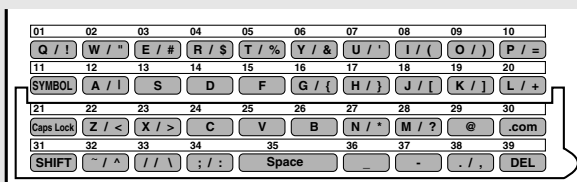

12 Press .

13 Press the letter keys to enter your e-mail address (sender's e-mail address).

14 Press .

15 Press  repeatedly to return to the date and time display.

Using a personal book

To program or use a Rapid Key or Speed Dial number in a personal book, you must first open the book. Follow these steps:





1 Press  .

Display:

SELECT PERSONAL BOOK
BY ► KEY OR PASSCODE

2 Enter the 4-digit passcode of your book.

The display briefly shows the following and then reverts to the date and time:

If the book doesn't have a passcode, press  once, enter the first letter of the name of the book if desired, press  or  until the book is selected in the display, and then press  .

** PERSONAL BOOK **
SUSAN

The name of your book appears here

3 When your book is open, all of the Rapid Keys on the operation panel automatically convert to keys for use in your book. Speed Dial numbers 1 through 16 are also available for use in your book.

You can perform the following operations in a book:

- ◆ Program any Rapid Key, or a Speed Dial number from 1 to 16, as explained on page 39.
- ◆ Use a Rapid Key to fax a document as explained on page 46.
- ◆ Use a Speed Dial number to fax a document as explained on page 47.
- ◆ Program a Group Key in your book using Rapid Key and Speed Dial numbers from your book (see page 142).
- ◆ Broadcast a fax to multiple destinations using Rapid Keys, Speed Dial numbers, or a Group Key in your book (see page 139).
- ◆ Set up a Program Key in your book (see page 166). (Note: Only Rapid Keys and Speed Dial numbers from your book can be used. A memory polling program cannot be entered.)

- ◆ Poll one or more fax machines using Rapid Keys and Speed Dial numbers from your book (see page 150).
- ◆ Set up a timer operation using a Rapid Key or Speed Dial number from your book (see page 158).
- ◆ Print out the Destination List, Program/Group List, or Timer List (see page 200). When printed from your book, these lists will show the corresponding information in your book.
- ◆ Press  to redial the last number dialed from your book.
- ◆ If the network scanner option is installed, you can program any Rapid Key or a Speed Dial number from 1 to 16 for Scan to E-mail as explained on page 89, and use the Rapid Key or Speed Dial number to send a document to an e-mail recipient as explained on pages 89 and 91.

Closing a book

A book will automatically close when the operation performed from the book is completed. If you need to close a book before performing an operation, press



. The display will show:

CANCEL BOOK? ▶ 1=YES 2=NO

Make sure that YES is selected and then press .

- ◆ If an operation is not performed within minute after opening a book, the book will automatically close.

Canceling an operation performed from a book



To cancel an operation that was set up from a book, you must first open the book (as explained on page 57) and then cancel the operation.

For example, if you need to cancel a fax transmission that was performed from a book, open your book and then cancel the operation as explained on page 51 or 52. Note that the job status of the fax can be checked without opening your book.

To clear a Rapid Key or Speed Dial number in a book, open the book and then clear the key or number.



Clearing a book

Note: Before you can clear a personal book, you must clear all Rapid Keys, Speed Dial numbers, Group Keys, and Program Keys that are in the book. If a transmission or timer operation is pending that uses a number in a book, the book cannot be cleared until the operation is completed or canceled.



- 1** Press **MENU** and then  or  until **ENTRY MODE** is selected in the display.

Display:

```
MENU MODE
 1:RECEIVE MODE
 2:LISTING MODE
▶ 3:ENTRY MODE
```

- 2** Press  and then  or  until **BOOK ENTRY MODE** is selected in the display.

```
ENTRY MODE
 06:ID # MODE
 07:SYSTEM # MODE
 08:STORE JUNK FAX #
 09:DEPT. PASSCODE
▶ 10:BOOK ENTRY MODE
```

- 3** Press  and then  or  to select **CLEAR**.

```
PERSONAL BOOK SETTING
 1=SET
▶ 2=CLEAR
```

- 4** Press .

- 5** Enter the 2-digit number of the book you wish to clear.

- 6** If the book has a passcode, enter the passcode.

- 7** Press .

- 8** Press  repeatedly to return to the date and time display.

Cover Sheet

You can have the machine generate a cover sheet and send it as the last page of your fax transmission. The cover sheet includes the date and time, the receiver's name and number if a Rapid Key or Speed Dial number is used, the sender's name and number, and the total number of pages.

- ◆ Your name and number must be programmed in order for them to appear on the cover sheet (see page 25).
- ◆ To have the recipient's name appear, you must dial using a Rapid Key or Speed Dial number with the name programmed.

<u>AUTOMATIC COVER SHEET</u>	
DATE:	AUG-08-2004 THU 11:48 AM
TO:	N. T. BANK
FAX #:	4525558885
FROM:	John Doe Corp.
FAX #:	2015551254
<u>02 PAGES WERE SENT</u> (INCLUDING THIS COVER PAGE)	

(Example)

1 Load the document(s).

- SEND READY will appear in the display.
- Press **RESOLUTION** and/or **CONTRAST** to set the resolution and contrast if needed.

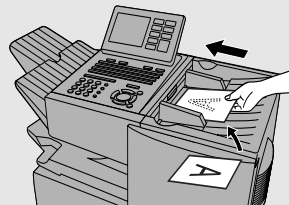

2 Press . (Flip up the Rapid Key overlay if it is down.)

- The display will briefly show COVER SHEET MODE ENTERED and then revert to SEND READY.
- To cancel the cover sheet selection, press  .

3 Dial the receiving party and transmit the fax.

If desired, you can set your fax to automatically send a cover sheet with every transmission (you do not have to press  each time). This is accomplished by setting Option Setting 10 (Auto Cover Sheet) to YES as explained on page 192.

Batch Page Numbering (Page Counter)

You can change the page numbering of the transmitted document from simple numbering ("P.01", "P.02", etc.) to batch numbering, which means that a slash and the total number of pages being sent are added after each page number (for example, "P. 01/05", "P.02/05", etc.). This allows the recipient to check for missing pages.

1 Load the document(s).

- SEND READY will appear in the display.
- Press **RESOLUTION** and/or **CONTRAST** to set the resolution and contrast if needed.

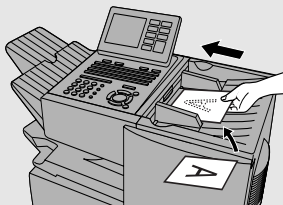

2 Press **PAGE COUNTER** (Flip up the Rapid Key overlay if it is down.)

Display:

PAGE COUNTER
OF PAGE(S) =

3 Enter the total number of pages ("01" to "99") by pressing the numeric keys.

Example: 5 pages (0) (5)

- If you are sending a cover sheet, do not include it in the total number of pages (the number will be adjusted automatically).

4 Dial the receiving machine and transmit the document.

- ◆ If you need to cancel a batch number entry, remove the document from the feeder or press **STOP**.
- ◆ If the number of pages actually transmitted does not coincide with the batch number entered, the alarm will sound and PAGE COUNT ERROR will appear in the display. PAGE E. will also appear in the NOTE column of the Transaction Report if printed.

Receiving Faxes

The machine has two modes for receiving faxes:

AUTO mode:

Select this mode when you only want to receive faxes on the line connected to the machine. The machine will answer all calls automatically and receive incoming faxes.

MANUAL mode:

Select this mode when you have an extension phone connected to the same line as the machine and you want to receive both faxes and voice calls. **All calls, including faxes, must be answered by picking up the extension phone.**

Setting the reception mode

The reception mode is initially set to AUTO. To change the reception mode, follow the steps below.

- ◆ If you have the dual-line option, use the procedure on page 69 to select the reception mode. Note that the reception mode can only be selected for Line 1 (Line 2 is fixed at AUTO).

- 1** Press **MENU** . Make sure that **RECEIVE MODE** is selected in the display.

Display:

```
MENU MODE
▶ 1:RECEIVE MODE
  2:DESTINATION SETTING
  3:ENTRY MODE
```

- 2** Press  .

```
RECEIVE MODE
▶ 1 = AUTO RECEPTION
  2 = MANUAL RECEPTION
```

- 3** Press  or  to select **AUTO RECEPTION** or **MANUAL RECEPTION**.

- 4** Press  .

Using AUTO Reception Mode

In AUTO reception mode, the machine automatically answers all calls on one ring and receives incoming faxes.

- ◆ You can change the number of rings on which the machine answers calls by changing Option Setting 2 (see page 190).
- ◆ If you pick up an extension phone before the machine answers, you can talk to the other party and/or receive a fax as explained in the following section, *Using MANUAL Reception Mode*.

Using MANUAL Reception Mode

-
- 1** When the machine rings, answer the call on an extension phone connected to the same line.

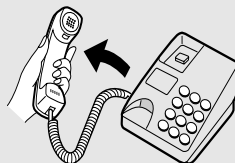

-
- 2** If you hear a fax tone, press  on the machine.

- If the other party first speaks with you, press  after speaking. (Press your **START** key before the sender presses their Start key.)
- If there is a document in the feeder, remove the document before pressing



(otherwise the document will be transmitted).

-
- 3** When **RECEIVING** appears in the display, hang up.

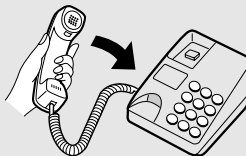

Substitute Reception to Memory

In situations where printing is not possible, such as when the machine runs out of paper or toner, or a paper jam occurs, incoming faxes will be received to memory. Confidential faxes (see page 146) are also received to memory.

When you have received a fax to memory, FAX RCVD IN MEMORY will appear in the display, along with NO PAPER, REPLACE TONER, or PAPER JAM. When you add paper, replace the toner cartridge, or clear the jam, the stored faxes will automatically print out.

You can display information on faxes received to memory by following these steps:

- 1** Press  (flip up the Rapid Key overlay) and then  or  until **MEMORY RX STATUS** is selected in the display.

Display:

```
MEMORY STATUS REPORT
1: COPY STATUS
2: MEMORY TX STATUS
▶ 3: MEMORY RX STATUS
4: MESSAGE CLEAR
```

- 2** Press .

Number of received faxes



- The received faxes appear.
- To print out the list of faxes, press



```
RX STATUS (004)
▶ 001: CONF. RX      10:34 AM
                    3456849123
002: CONF. RX      10:38 AM
                    5249762384
```

"CONF." indicates that the fax is confidential

Number of sender

- 3** Press  or  to scroll through the list of jobs.

- 4** When you have finished checking the list, press  twice to return to the date and time display.

Dual-line Option (FO-DC600 only)

The dual line option (FO-60DL) allows your machine to be connected to a second telephone line. If you wish to use this option, consult your dealer to have the dual line kit installed. The dual-line option is only available on the FO-DC600.

Note: The FO-60DL dual line option and the FO-NP1 network printer option cannot both be installed on the same machine.

After your dealer installs the dual line kit, connect your second phone line to the **LINE 2** jack.

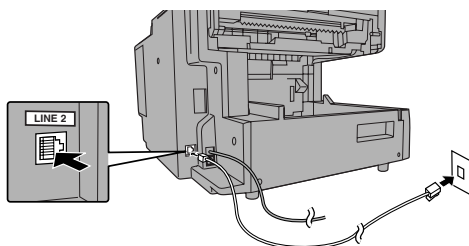

Caution: Do not insert the line into the port on the LAN board (if installed). This will damage the LAN board.



- ◆ Manual fax transmission (Normal Dialing using the **SPEAKER** key or an extension phone connected to the machine) and manual fax reception are only possible on Line 1. An extension phone connected to the machine uses Line 1.
- ◆ The machine will only ring when a call is received on Line 1. When a call is received on Line 2, the FAX 2 indicator will blink.



Entering your name and fax numbers

If you have the dual-line option, use the following procedure to enter your name (only one name can be entered) and the fax number of each line. This information will appear at the top of each fax page you send.

- 1** Press **MENU** and then  or  until **ENTRY MODE** is selected in the display.

Display:

MENU MODE
1:RECEIVE MODE
2:LISTING MODE
▶ 3:ENTRY MODE

- 2** Press  and then  or  until **OWN PASSCODE SET** is selected.

ENTRY MODE

01:DESTINATION SETTING
 02:PASSCODE SETTING
 ▶ 03:OWN PASSCODE SET





- 3** Press .

OWN PASSCODE SET
 SENDER'S NAME

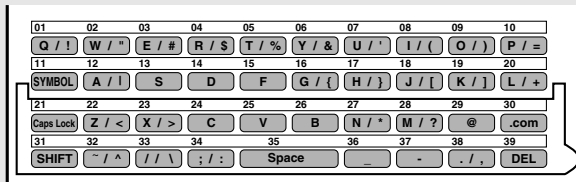
- 4** Flip the Rapid Key overlay down (if it is up), and enter your name by pressing the appropriate letter keys as shown below. (Max. of 24 characters.)

Example: SHARP =      





- To enter a space, press .
- To change case, press .
- To clear a mistake, press .
- To enter a number as part of a name, press the appropriate numeric key. To enter the symbol on a letter key (the character to the right of the slash), press  ("SYM" will appear in the display) and then the letter key (press  again to turn off symbol entry mode).

- 5** Press .

OWN PASSCODE SET
 LINE 1: SENDER'S NUMBER

6 Enter the fax number (maximum of 20 digits) of Line 1.

- To insert a space between digits, press .
- To clear a mistake, press .

7 Press .

OWN PASSCODE SET
LINE 2: SENDER'S NUMBER

8 Enter the fax number (maximum of 20 digits) of Line 2.

9 Press .

10 Press  until you return to the date and time display.



Selecting the line

If you wish to use a particular line to fax a document, press  one or more times before dialing until the desired line appears in the display. The selections will appear in the following order in the display:

LINE-1 SELECTED
LINE-2 SELECTED
LINE AUTO SELECTED.



If you select LINE AUTO SELECTED or do not make a selection with , the first available line will be used.

- ◆ If you wish to restrict either of the lines to transmission only or reception only, see the following section.
- ◆ When you program an auto-dial number (Rapid Key or Speed Dial number), you can specify that the number use a particular line.

Note: The  key cannot be used to select a line if either of the lines has been set to reception only as explained in the following section. A line selection made with  will override a line selection programmed into a Rapid Key or Speed Dial number.

Restricting a line to transmission or reception / selecting the reception mode for Line 1

You can restrict either line to transmission only or reception only. You can also use this procedure to select the reception mode (AUTO or MANUAL) for Line 1 (the reception mode for Line 2 is fixed at AUTO).

- 1** Press  and then  so that **LINE SETTING MODE** is selected in the display.



Display:

```
MENU MODE
▶ 1:LINE SETTING MODE
  2:LISTING MODE
  3:ENTRY MODE
```

- 2** Press .

- Line 1 is initially selected. If you wish to adjust the setting for Line 2, press  to select LINE 2.

```
LINE SETTING MODE
▶ 1:LINE 1
  2:LINE 2
```

3 Press  and then  or  until the desired setting is selected.

- **Note:** “TX” stands for “transmission” and “RX” stands for “reception”. “AUTO” and “MANU” indicate AUTO and MANUAL reception modes.

Settings for Line 1:

LINE 1 SETTING
▶ 1=TX AND RX (AUTO)
2=TX AND RX (MANU)
3=RX (AUTO) ONLY
4=RX (MANU) ONLY

Settings for Line 2:

LINE 2 SETTING
▶ 1=TX AND RX (AUTO)
2=TX ONLY
3=RX ONLY

4 Press .

5 Go back to Step 3 to select a setting for the other line, or press  to exit.

Verification Stamp Option

When transmitting a document, you can have the machine stamp each document page as it is scanned. After scanning, you can check to see if all documents have been stamped to verify that no double feeds occurred. (A double feed occurs when two pages are fed through the scanner at once, which means that one of the pages is not scanned.)

To use this function, have your dealer install the Verification Stamp option, and then set Option Setting 29 to ON as explained on page page 197.

PC Fax Function (Requires the FO-LN1 Option)

The PC-Fax function allows you to fax documents directly from your computer. This saves you the trouble of printing a document and then faxing it from the machine.

Important: The PC-Fax function can only be used to send faxes. It cannot be used to receive faxes to your computer.

To use the PC Fax function,

- ◆ The FO-LN1 network interface kit must be installed in the machine. (This kit is also used for the network scanner option and printer option explained in the following chapters.)
- ◆ The PC-Fax driver must be installed in your computer. The PC-Fax driver is installed from the CD-ROM in the FO-LN1 network interface kit.

The Status Monitor can also be installed to monitor the status of faxes sent from your computer using the PC-Fax driver. The Status Monitor notifies you when transmission is completed and alerts you if an error occurs.

System requirements

To use the PC-Fax driver, you must have one of the following versions of Windows:

Windows 98/ME/NT 4.0/2000/XP

Installing the PC-Fax driver in your computer

To install the PC-Fax driver in your computer, see the installation guide in the CD-ROM in the FO-LN1 network interface kit. The installation guide ("Installation Guide.pdf") is located in the PC-FAX folder of the CD-ROM.

Using the PC-Fax function

To fax a document from your computer, open the document in the application used to create it and select **Print** from the **File** menu. In the Print window, select "SHARP FO-DC Series FAX" for the printer and then click **OK**.

A window will appear to let you enter the destination fax number (or select it from the address book) and select any other fax settings. When finished, click **OK**. The document will be sent to the machine, which will then dial the fax number and fax the document to the recipient.

For detailed information on using the PC-Fax function, open the Help file for the PC-Fax driver.

3. Network Scanner Option

Introduction

The FO-NS2 Network Scanner Expansion Kit allows you to scan a document and directly transmit the image to an e-mail address (Scan to E-mail), FTP server (Scan to FTP), or computer desktop on your network (Scan to Desktop). To use this option, the machine must be connected to a network.

Depending on the file format selected for the image, the recipient can view it with Adobe Acrobat Reader®, any Tiff-compatible viewer such as Imaging®, or in the case of Scan to Desktop, SharpDesk.

Scan a document and transmit the image file to...

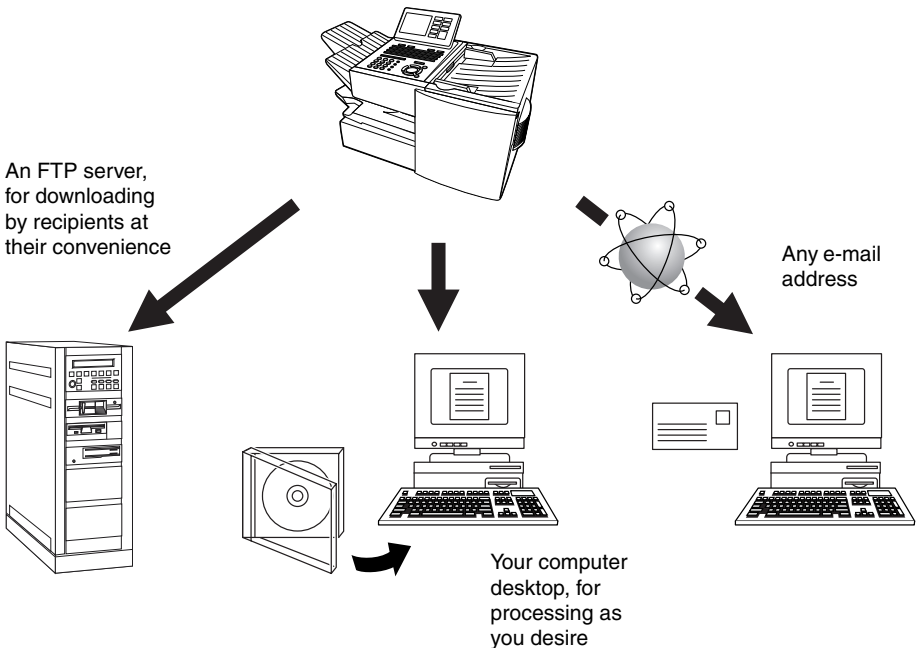



Scan destinations can be stored in Rapid Keys on the machine, for easy one-touch scanning and transmission.

Setting the IP Address

Once your dealer has installed the network scanner option and the machine is connected to the network, the network administrator or administrator of the machine should use the following procedure to set the IP address of the machine.

Note: Although "DHCP" is available as a setting for the IP address (this means that the machine automatically obtains an address from a DHCP server), it is recommended that a permanent IP address be assigned to the machine. If DHCP must be used, it is recommended that the DHCP lease time for the IP address be set to unlimited. To check the IP address currently assigned to the machine when DHCP is used, print out the network setting list as explained on page 78.

- 1** Press **MENU** and then  or  until **NETWORK SETTING** is selected in the display.

Display:

```
MENU MODE
5:PROGRAM/GROUP MODE
6:SERIAL POLLING MODE
7:MEMORY POLL MODE
▶ 8:NETWORK SETTING
```

- 2** Press .
- Make sure that **NETWORK CONFIG SET** is selected.



```
NETWORK SETTING
▶ 1:NETWORK CONFIG SET
2:SCAN TO E-MAIL SET-UP
3:NETWORK SETTING LIST
```

- 3** Press .
- Make sure that **IP ADDRESS SETTING** is selected.

```
NETWORK CONFIG SET
▶ 1:IP ADDRESS SETTING
2:INITIALIZE THE NIC
```

- 4** Press .

```
IP ADDRESS SETTING
ENABLE DHCP
▶ 1:YES
2:NO
```

5 If the machine will receive an IP address automatically from a DHCP server, make sure that “YES” is selected (this will enable DHCP). If the machine will be assigned a permanent IP address, press  or  to select “NO”.

6 Press .

- If you enabled DHCP by selecting “YES” in the previous step, this completes the setting. Wait while the machine writes the setting to the NIC board (“DO NOT POWER DOWN” will appear in the display). When the display changes to “OK”, turn off the power of the machine and then turn it back on to make the new setting take effect. (Before turning off the power, make sure the machine is not in the middle of a job: 1) check whether the machine is printing, and 2) press  and check the display to see if the machine is sending or receiving a fax.)

7 If you are entering a permanent IP

address, press .

IP ADDRESS
[][][][][]

8 Enter the IP address of your machine (to move the cursor to the right,

press ). When finished, press .





- To correct a mistake, press  to move the cursor back to the mistake, and then enter the correct number.

9 Enter the IP subnet mask. When finished, press .

10 Enter the IP gateway. When finished, press .

- 11** Wait while the machine writes the setting to the NIC board (“DO NOT POWER DOWN” will appear in the display). When the display changes to “OK”, turn off the power of the machine and then turn it back on to make the new settings take effect. (Before turning off the power, make sure the machine is not in the middle of a job: 1) check whether the machine is printing, and 2) press  and check the display to see if the machine is sending or receiving a fax.)



Initializing the network interface board

Normally the network interface board (NIC) does not need to be initialized (returned to the factory default settings). In the event that you do need to initialize the board, follow the Steps 1 to 3 of the previous procedure to access “NETWORK CONFIG SET”, press  to select “INITIALIZE THE NIC”, and then press . Press  to select “YES” and then press . Wait while the machine writes the setting to the NIC board (“DO NOT POWER DOWN” will appear in the display). When the display changes to “OK”, turn off the power of the machine and then turn it back on to make the new setting take effect. (Before turning off the power, make sure the machine is not in the middle of a job: 1) check whether the machine is printing, and 2) press  and check the display to see if the machine is sending or receiving a fax.)

Printing out the Network Settings



You can print lists showing the current network settings and network interface board settings.

- ◆ To check the IP address of the machine, select PRINT NETWORK SETTINGS in Step 3 below.

- 1** Press **MENU** and then  or  until **NETWORK SETTING** is selected in the display.

Display:



```
MENU MODE
 5:PROGRAM/GROUP MODE
 6:SERIAL POLLING MODE
 7:MEMORY POLL MODE
▶ 8:NETWORK SETTING
```

- 2** Press  and then .
- Make sure that **NETWORK SETTING LIST** is selected.

```
NETWORK SETTING
 1:NETWORK CONFIG SET
 2:SCAN TO E-MAIL SET-UP
▶ 3:NETWORK SETTING LIST
```

- 3** Press .

```
NETWORK SETTING LIST
▶ 1:PRINT NETWORK SETTINGS
 2:PRINT NIC INFORMATION
```

- 4** Press  or  to select the list that you wish to print, and then press . (Note: “NIC” is an acronym for “network interface board”.)

Mail Server and DNS Server Settings

Settings for your E-mail server and DNS server must be configured in order to use the network scanner function. To configure the settings, access the machine's Web page from a computer that is connected to the same network as the machine. The Web page can be displayed with your Web browser (Internet Explorer 4.0 or later, or Netscape Navigator 4.0 or later).

Accessing the Web page in the machine

To access the Web page in the machine, type in the IP address of the machine in your browser in the format **http://XXX.XXX.X.X**, where the X's are the IP address (the number of digits between periods will vary depending on the address). If you need to check the IP address of the machine, print out the network settings as explained on page 78.

Mail server and DNS server

To configure your mail server and DNS server settings, click **E-mail & DNS Setup** in the menu at the left of the Web page. Enter the IP address or host name of your e-mail server in **E-mail Server**, the e-mail address of your network administrator in **System Administrator Address**, the IP address of your DNS server in **DNS Server**, and your domain name in **Domain Name**. Select your time zone from the list in **Time Zone**. Note that the IP address of your DNS server must be entered if you enter a host name instead of an IP address in **E-mail Server**. This is also true if host names will be used for Scan to FTP or Scan to Desktop destinations.

- ◆ If "DHCP" was selected for the IP address of the machine, the IP address of the DNS server appears automatically and cannot be changed.

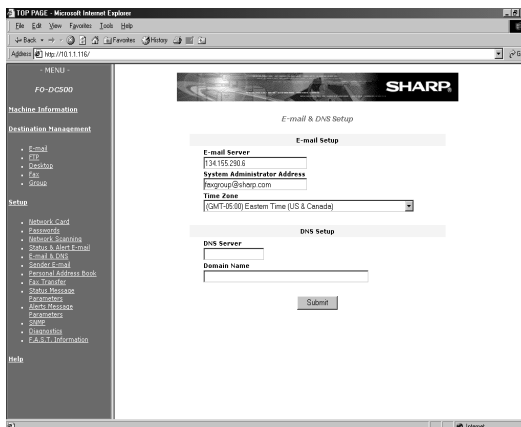

Setting Passwords

Passwords can be set to restrict Web page access and protect settings. An administrator password and a user password can be set. When the Web page is accessed with the administrator password, all settings can be configured. When the Web page is accessed with the user password, destinations in the Scanner Destination Management menu can be stored, deleted, and edited; however, settings in the Setup menu cannot be configured.

To enable password protection, click **Passwords** in the Web page menu and select the **“Enable Password Protection of this Web Site”** checkbox. The passwords for “User” and “admin” are both initially set to “Sharp”. If you wish to change a password, enter “Sharp” in **Old Admin Password**, and then enter the new password under **User Password** or **Admin Password**. A password must consist of alphanumeric characters and be no more than 10 characters long. Passwords are case sensitive.

When you are finished, click **Submit** to store the new settings and then turn the machine power off and then back on. The next time you attempt to access the Web page, you will be prompted for the password. For the **User name**, enter “user” if you are accessing the page as a user, or “admin” if you are accessing the page as an administrator.

For more information on setting passwords, click **Help** at the bottom of the Web page menu.

Network Scanning and Sender E-mail settings

The network scanning settings allow you to select the method for assigning a file name to a scanned image and enter a subject for Scan to E-mail (the subject can also be entered from the operation panel of the machine as explained in Scan to E-mail Setup on page 84).

Click **Network Scanning** in the menu and then configure the settings as needed. When finished, be sure to click **Submit** to store the new settings.

To enter the sender name and sender e-mail address that appear on e-mail that you send, click **Sender E-mail**. The sender information can be entered separately for each personal book and for the COMMON book.

For detailed information on all the settings in the Web page, click **Help**.

Storing Network Scanning Destinations

Network scanning destinations can be stored in Rapid Keys and Speed Dial numbers. The Rapid Keys and Speed Dial numbers can be in a personal book or in the COMMON book.

- ◆ Scan to E-mail can be performed by manually entering the destination e-mail address at the time of transmission, or by using a Rapid Key or Speed Dial number. A Scan to E-mail destination can be stored in a Rapid Key or Speed Dial number using the Web page, or using the operation panel on the machine (to use the operation panel, see page 93).
- ◆ To use Scan to FTP, the destination must be previously stored in a Rapid Key or Speed Dial number. A Scan to FTP destination can only be stored in a Rapid Key or Speed Dial number using the Web page.
- ◆ To use Scan to Desktop, the Network Scanner Tool and SharpDesk programs must be installed in the destination computer. During installation and setup the Network Scanner Tool automatically stores the computer as a Scan to Desktop destination, and for this reason, the Web page should not be used to store Scan to Desktop destinations. However, the Web page can be used to change the selected file format for a Scan to Desktop destination, copy a Scan to Desktop destination into a different address book, or delete a Scan to Desktop destination if the Network Scanner Tool has been uninstalled from the computer.
- ◆ Fax destinations can also be stored in Rapid Keys and Speed Dial numbers using the Web page.

Storing destinations in the Web page

To store a destination, click the desired destination type (**E-mail, FTP, Fax or Group**) under **Destination Management** in the Web page menu. In the Destination Management page, enter the destination name and select a personal address book or the **COMMON** book. To select a Rapid Key or Speed Dial number, select the **Location Assigned Manually** checkbox and select a Rapid Key or Speed Dial number from the list. Enter the information required for the destination type, and click **Submit**.

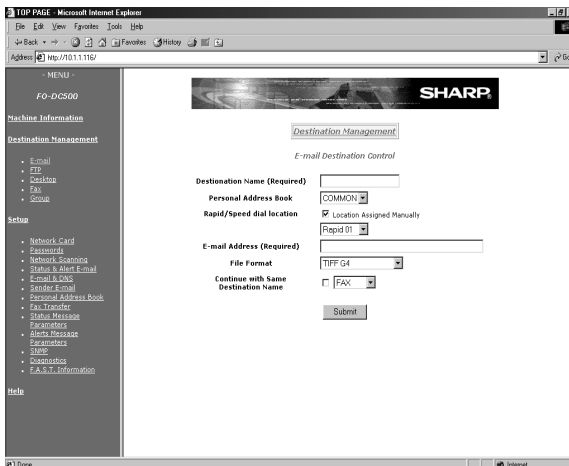

To edit or delete a destination, click **Destination Management** in the Web page menu, select the destination you wish to edit or delete, and click **Edit** or **Delete** at the bottom of the page. For detailed information on setting up, editing, and deleting destinations, click **Help** at the bottom of the Web page menu.

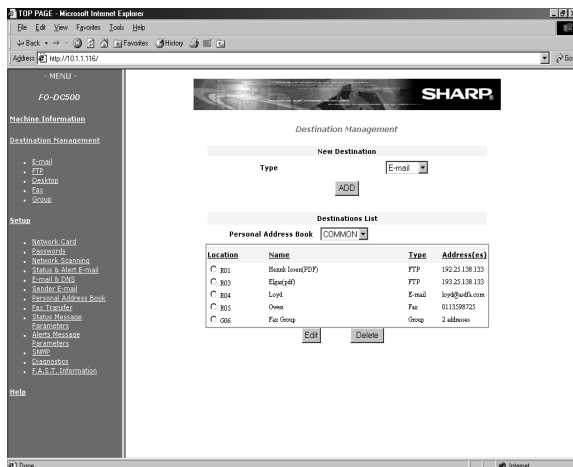

Scan to FTP (Hyperlink)

When using Scan to FTP to send an image to an FTP server, you can also have notifications automatically sent by e-mail to selected recipients informing them that the image has been posted on the server. The e-mail will contain a hyperlink to the image file on the server, allowing the recipients to open the file by simply clicking on the hyperlink (unless the FTP server requires a password).

To use this feature, select the “Enable Hyperlink to FTP server to be e-mailed” checkbox when storing the Scan to FTP destination, and then select the recipients for the e-mail from the **E-mail Destination** list.

Creating personal books in the Web page

To create a new personal book in the Web page, click **Personal Address Book** in the Web page menu, and then click **Add** in the Personal Address Book Setup page. Enter the required information and click **Submit**.

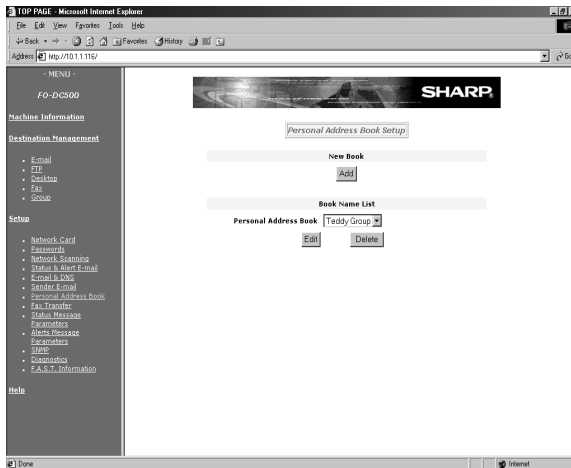

Information on using Scan to Desktop

Unlike the case where a scanner is directly connected to your computer, scanning using Scan to Desktop cannot be directly initiated from a scanning application in your computer. Instead, scanning is begun by pressing the Rapid Key or Speed Dial number on the machine that contains your computer as a Scan to Desktop destination. To use Scan to Desktop, the Network Scanner Tool must be running in your computer (it starts and runs automatically in the background when you power up your computer).

Your computer is automatically stored as a Scan to Desktop destination in a Rapid Key or Speed Dial number when you install the Network Scanner Tool. After you install and set up the Network Scanner Tool, access the Web page in the machine from your browser on your computer, and click **Destination Management** in the menu to see which Rapid Key or Speed Dial number your computer is stored in. This will be the Rapid Key or Speed Dial number you will use to scan documents to your computer.







Scan to E-mail Setup

To use the Scan to E-mail function, the subject and sender information (name and e-mail address) that appear when an image is sent to an e-mail recipient must be entered, and the file format for the scanned image must be selected. (Note: The file format set in this procedure does not apply to Scan to E-mail using a Rapid Key or Speed Dial number.)

- ◆ The preset subject is “Scanned image from FO-DCXXX” (where “XXX” is “500” or “600”), and the preset file format is “TIFF/G4”.
- ◆ You can enter a different sender name and select a different file format at the time of transmission. The subject can only be changed using the following procedure.



Important: To use Scan to E-mail, sender information must be set using the following procedure, or using the Web page as explained on page 80, even if a sender is manually entered at the time of transmission.

Note: In the event that your e-mail server is unable to deliver a Scan to E-mail transmission to a specified e-mail address, your server will send notification to the sender’s e-mail address that you enter in the following procedure or at the time of transmission.

<p>1 Press MENU and then  or  until NETWORK SETTING is selected in the display.</p>	<p>Display:</p> <div style="border: 1px solid black; padding: 5px;"> <p>MENU MODE 5:PROGRAM/GROUP MODE 6:SERIAL POLLING MODE 7:MEMORY POLL MODE ▶ 8:NETWORK SETTING</p> </div>
<p>2 Press  and then  or  until SCAN TO E-MAIL SET-UP is selected.</p>	<div style="border: 1px solid black; padding: 5px;"> <p>NETWORK SETTING 1:NETWORK CONFIG SET ▶ 2:SCAN TO E-MAIL SET-UP 3:NETWORK SETTING LIST</p> </div>
<p>3 Press .</p>	<div style="border: 1px solid black; padding: 5px;"> <p>SCAN TO E-MAIL SET-UP ▶ 1:E-MAIL SUBJECT 2:E-MAIL SENDER 3:FILE FORMAT</p> </div>
<p>4 Press .</p>	

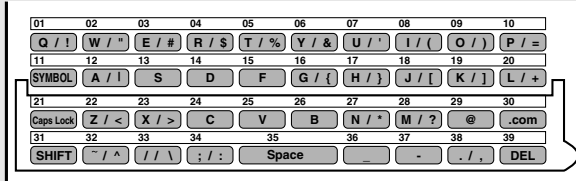
5 Enter the e-mail subject by pressing the letter entry keys (max. of 60 characters). (Make sure the Rapid Key overlay is flipped down.)



- To enter a space, press **Space** .
- To change case, press **Caps Lock** .
- To clear a mistake, press **DEL** .
- To enter a number, press the appropriate numeric key. To enter the symbol on a letter key (the character to the right of the slash), press **SYMBOL** (“SYM” will appear in the display) and then the letter key (press **SYMBOL** again to turn off symbol entry mode).
- To move the cursor, press  or  . To switch between letter insertion and letter replacement mode when the cursor is in the middle of a sequence of letters, press **MENU** .

6 Press .

- Make sure that E-MAIL SENDER is selected.

SCAN TO E-MAIL SET-UP

- 1: E-MAIL SUBJECT
- ▶ 2: E-MAIL SENDER
- 3: FILE FORMAT

7 Press .

8 Press the letter keys to enter the sender's name (see Step 5)

9 Press .

10 Press the letter keys to enter your e-mail address (see Step 5).



11 Press .

- Make sure that FILE FORMAT is selected.

SCAN TO E-MAIL SET-UP
1:E-MAIL SUBJECT
2:E-MAIL SENDER
▶ 3:FILE FORMAT

12 Press .

FILE FORMAT SETTING
▶ 1:TIFF-G4
2:TIFF-G3
3:TIFF-NO COMPRESSION
4:PDF-G4
5:PDF-G3

13 Press  or  to select the desired combination of file format (TIFF or PDF) and compression method (G3, G4, or NO COMPRESSION).

- TIFF is a bitmap format that can be compressed without loss of data. TIFF images can be viewed by many viewer programs. PDF is a widely used format that requires Adobe Acrobat Reader® to view.
- G4 provides the greatest amount of compression and works well with most black and white files. If the recipient cannot open a G4-compressed file or experiences other difficulties, try G3 or “NO COMPRESSION”.

14 Press  and then press  repeatedly to return to the date and time display.

Scan to E-mail Using the E-mail Key

Use the **e-mail** key when you wish to manually enter the e-mail address of a recipient for Scan to E-mail. The scanned image will be sent as an e-mail attachment. A message can also be included as explained in Steps 5 and 6.

Important:

To use Scan to E-mail, the setup procedures outlined on page 73 must be completed. This includes setting a default sender as explained in the procedure beginning on page 84 of this manual.

- ◆ If you need to change the e-mail subject, use the procedure on page 84.

1 Load the document(s).

- SEND READY will appear in the display.
- Press **RESOLUTION** and/or **CONTRAST** to set the resolution and contrast if needed. The default resolution is FINE. Note that STANDARD and SUPER FINE are primarily for faxing and are not recommended for scanning.

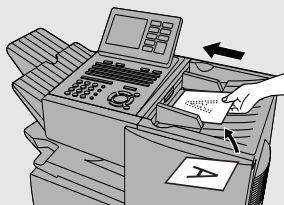

2 Press e-mail.

Display:

SCAN TO E-MAIL

TO: [

3 Enter the e-mail address of the recipient by pressing the letter entry keys (for details, see Step 5 on page 85; max. of 60 characters). (Make sure the Rapid Key overlay is flipped down.)

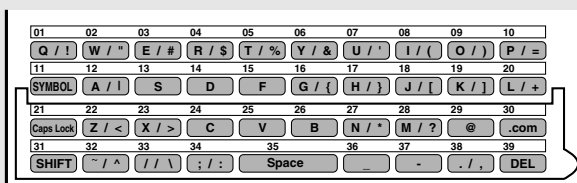

4 Press .

5 If you wish to enter a message, your name, or your return e-mail address, or select the file format for the document, press .

(If you wish to use the default settings you entered on page 84 and do not need to enter a message, go directly to Step 8.)

► 1:START SCANNING
2:FROM
XXX
3:FILE FORMAT
XXX
4:MESSAGE
NO MESSAGE



Your preset sender and file format appear in "XXX".

6 Press  to select the option you want to change, and then press





. Change the selected option as follows:

- FROM

Enter your name, press , enter your e-mail address, and press .



- FILE FORMAT

Press  to select the desired combination of file format (TIFF or PDF) and compression (G3, G4 or NO COMPRESSION), and then press .

- MESSAGE

Use the letter entry keys to enter a message (see Step 5 on page 85; maximum of 256 characters). A line break can be entered by pressing

. When finished, press .

7 When you have finished changing the options, press  or  to select **START SCANNING**.

► 1:START SCANNING
2:FROM
XXX
3:FILE FORMAT
XXX
4:MESSAGE
NO MESSAGE

- 8** Press . The document is scanned and transmitted.

Sending an Image Using a Rapid Key or Speed Dial Number



Sending an image using a Rapid Key

Use this procedure to scan a document and send the image to an E-mail, FTP, or Desktop destination that has been stored in a Rapid Key.

Important: To use this procedure, the setup procedures outlined on page 73 must be completed. In the case of Scan to E-mail, this includes setting a default sender as explained in the procedure beginning on page 84 of this manual.

- ◆ If you are sending the image to an e-mail destination and need to change the subject, use the procedure on page 84.

1 Load the document(s).

- SEND READY will appear in the display.
- Press  and/or  to set the resolution and contrast if needed. The default resolution is FINE. Note that STANDARD and SUPER FINE are primarily for faxing and are not recommended for scanning.

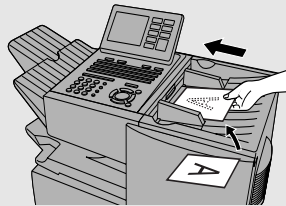

2 Press the appropriate Rapid Key.

- The name of the recipient will appear in the display. (If the destination is not correct, press .)
- If the destination is an FTP or Desktop destination, or if the destination is an e-mail destination and you don't need to enter a message or change any of the e-mail options, this completes the procedure.

3 If the destination is an e-mail destination and you wish to enter a message, or change the sender name or e-mail address, or select the file format for the document, press  **WITHIN 5 SECONDS** after pressing the Rapid Key in Step 2. (After 5 seconds, the document will be scanned and transmitted using the settings that were stored in the Rapid Key.)



► 1:START SCANNING
2:FROM
XXX
3:FILE FORMAT
XXX
4:MESSAGE
NO MESSAGE

4 Press  to select the option you want to change, and then press





. Change the selected option as follows:

- FROM



Enter your name, press , enter your e-mail address, and press .



- FILE FORMAT

Press  to select the desired combination of file format (TIFF or PDF) and compression (G3, G4 or NO COMPRESSION), and then press .

- MESSAGE

Use the letter entry keys to enter a message (maximum of 256 characters).

A line break can be entered by pressing . When finished, press .

5 When you have finished changing the options, press  or  to select **START SCANNING**.

► 1:START SCANNING
2:FROM
XXX
3:FILE FORMAT
XXX
4:MESSAGE
NO MESSAGE

6 Press  to begin scanning and transmission.

Sending an image using a Speed Dial number

Use this procedure to scan a document and send the image to an E-mail, FTP, or Desktop destination that has been stored in a Speed Dial number.

Important: To use this procedure, the setup procedures outlined on page 73 must be completed. In the case of Scan to E-mail, this includes setting a default sender as explained in the procedure beginning on page 84 of this manual.

- ◆ If you are sending the image to an e-mail destination and need to change the subject, use the procedure on page 84.

1 Load the document(s).

- SEND READY will appear in the display.
- Press **RESOLUTION** and/or **CONTRAST** to set the resolution and contrast if needed. The default resolution is FINE. Note that STANDARD and SUPER FINE are primarily for faxing and are not recommended for scanning.

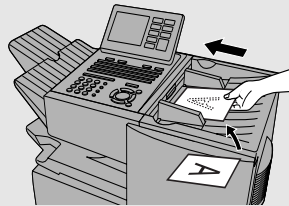

2 Press **SPEED DIAL and then enter the Speed Dial number by pressing the numeric keys.**

- If you enter less than 3 digits for the Speed Dial number, press **START/ENTER** to complete the entry.
- Check the display to make sure the destination shown is correct (if not, press **STOP** and repeat Step 2).

3 If the destination is an e-mail destination and you wish to enter a message, your name, or your return e-mail address, or select the file format for the document, press . (If the destination is an FTP or Desktop destination, or if you wish to use the e-mail settings that were stored in the Speed Dial number and do not need to enter a message, go directly to Step 6.)



▶ 1:START SCANNING
2:FROM
XXX
3:FILE FORMAT
XXX
4:MESSAGE
NO MESSAGE

4 Press  to select the option you want to change, and then press





. Change the selected option as follows:

• FROM

Enter your name, press , enter your e-mail address, and press .



• FILE FORMAT

Press  to select the desired combination of file format (TIFF or PDF) and compression (G3, G4 or NO COMPRESSION), and then press .

• MESSAGE

Use the letter entry keys to enter a message (maximum of 256 characters).

A line break can be entered by pressing . When finished, press .

5 When you have finished changing the options, press  or  to select START SCANNING.



▶ 1:START SCANNING
2:FROM
XXX
3:FILE FORMAT
XXX
4:MESSAGE
NO MESSAGE

6 Press  to begin scanning and transmission.

Storing an e-mail address in a Rapid Key or Speed Dial number

This section explains how to store e-mail addresses in Rapid Key and Speed Dial numbers using the operation panel of the machine. This will allow you to send documents to e-mail recipients without having to manually enter the e-mail address each time.

- ◆ This procedure cannot be used to store an FTP or Desktop destination (these can only be stored as explained on page 81).

- 1** Press **MENU** and then  or  until **ENTRY MODE** is selected in the display.

Display:

MENU MODE
 1:RECEIVE MODE
 2:LISTING MODE
 ▶ 3:ENTRY MODE

- 2** Press . Make sure that **DESTINATION SETTING** is selected.

ENTRY MODE
 ▶ 01:DESTINATION SETTING
 02:PASSCODE SETTING
 03:OWN PASSCODE SET

- 3** Press . Make sure that **SET** is selected.



DESTINATION SETTING
 ▶ 1=SET
 2=CLEAR

- 4** Press .

DESTINATION SET
 PRESS RAPID OR SPEED

- 5** To program a Rapid Key number, press the Rapid Key that you wish to use. (To select Rapid Keys 40 through 59, flip up the Rapid Key overlay.)

DESTINATION SET
SELECT DESTINATION TYPE
▶ 1=FAX
2=E-MAIL

To program a Speed Dial number, press  and then enter the number that you wish to use ("1" to "100" on the FO-DC500, or "1" to "200" on the FO-DC600). (If you enter less than three digits, press  to complete the entry.)

- 6** Press  to select E-MAIL.

DESTINATION SET
SELECT DESTINATION TYPE
1=FAX
▶ 2=E-MAIL

- 7** Press .

- 8** Enter the e-mail address of the recipient by pressing the letter entry keys (for details, see Step 5 on page 85; max. of 60 characters). (Make sure the Rapid Key overlay is flipped down.)

- To clear a mistake, press  .

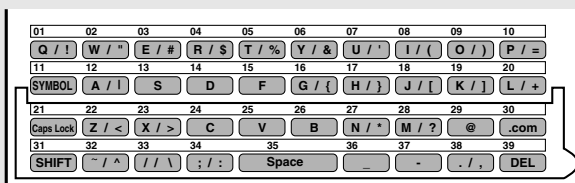



- 9** Press .

10 Enter the name of the party by pressing the letter entry keys (max. of 20 characters). (Make sure the Rapid Key overlay is flipped down.)

11 Press .

DESTINATION SET SELECT FILE FORMAT ▶ 1:TIFF-G4 2:TIFF-G3 3:TIFF-NO COMPRESSION 4:PDF-G4 5:PDF-G3
--

12 Press  or  to select the file format (TIFF or PDF) and compression method (G3, G4, or NO COMPRESSION) for the document that will be sent as an e-mail attachment. (Note: You can override this setting during the transmission procedure.)

13 Press .



14 Return to Step 5 to program another number, or press  repeatedly to return to the date and time display.

- If you programmed a Rapid Key number, you can write the name of the destination on the label above the Rapid Key.

Editing a Rapid Key or Speed Dial number

To make changes in a Rapid Key or Speed Dial number, repeat the programming procedure. Select the Rapid Key or Speed Dial number for which you want to make changes in Step 5, and then change the programmed information as needed in the following steps.

Clearing a Rapid Key or Speed Dial number

To clear a Rapid Key or Speed Dial number, select CLEAR in Step 3 of the programming procedure, press , select the Rapid Key or Speed Dial number as explained in Step 5, and then press .

Installing the Network Scanner Software

To use the Scan to Desktop function, the following two software programs must be installed in your computer (the destination computer for Scan to Desktop). The programs are installed from the CD-ROM that comes with the network scanner expansion kit.

- ◆ Sharpdesk (Desktop Document Management Software)
- ◆ Network Scanner Tool

Note: Sharpdesk can be installed and used in 5 computers. If you need to install Sharpdesk in more than 5 computers, please contact your Sharp dealer.

Software Programs

For detailed information on each of the software programs, please refer to the user's guides on the CD-ROM.

Sharpdesk (Desktop Document Management Software)

Sharpdesk lets you manage a variety of electronic information such as scanned image data from the network scanner or documents created using word processing or spreadsheet application software. Some of the important features of Sharpdesk are:

- ◆ Sharpdesk works with your scanner to let you read paper documents into your computer using a full-featured set of scanning controls and options.
- ◆ Sharpdesk makes editing of your images and documents quick and easy.
- ◆ A text image scanned into Sharpdesk can be converted into editable text for use with your favorite word processor. Sharpdesk uses an advanced Optical Character Recognition (OCR) engine that even preserves your document layouts.

Note: For the best results, set the resolution to ULTRA FINE when scanning a document for OCR conversion.

Network Scanner Tool

This is a utility that helps you use Scan to Desktop. It configures the necessary settings in the network scanner and client computer to receive data. In addition, Network Scanner Tool will automatically start Sharpdesk when image data is received. The scanned image received by your computer can be:

- ◆ Saved in a folder.
- ◆ Passed to an application set in the Network Scanner Tool.
- ◆ Sent as e-mail.
- ◆ Saved in Sharpdesk.



User's Guides for Software Programs

The Manual folder in the CD-ROM contains user's guides (in PDF format) for each of the software programs.

- ◆ Sharpdesk User's Guide
- ◆ Network Scanner Tool User's Guide

Acrobat Reader Version 4.05 or later is needed to view the user's guides. If not already installed in your computer, you can install Acrobat Reader from the CD-ROM. (Note: If Acrobat Reader 3.0 is already installed in your computer, uninstall it before installing the new version from the CD-ROM.)

Installing Acrobat Reader

-
- 1** Quit any software applications and/or resident programs that are running on your computer.
-
- 2** Insert the CD-ROM into your CD-ROM drive.
 - If the Sharpdesk installation window appears, click **Cancel** to close the window.
-
- 3** Double-click **My Computer** (.
-
- 4** Click the CD-ROM icon () and select **Open** from the **File** menu.
-
- 5** Double-click the **Acrobat** folder, and then double-click "ar405eng.exe" (.
-
- 6** Follow the instructions on the screen.

Installing the software programs

Note the following when installing the software programs from the CD-ROM:

- ◆ Be sure to check the system requirements for installation of each of the software programs in the user's guides and on the information screen during installation.
- ◆ The user's guides give detailed instructions for installing and setting up the programs. Be sure to read the user's guides before installing the programs.
- ◆ If you perform a standard installation of Sharpdesk (select **Typical** in the installation type selection screen), Network Scanner Tool will also be installed. You can also select **Custom** installation and install only Network Scanner Tool.
- ◆ If your computer does not currently have Internet Explorer version 5.01 or later installed, Sharpdesk will install a minimal version of Internet Explorer 5.01 on your computer.

1 Quit any software applications and/or resident programs that are running on your computer.

2 Insert the CD-ROM into your CD-ROM drive.

- If the Sharpdesk installation screen appears, go to Step 6.
- If the screen does not appear, continue with Step 3.

3 Double-click "My Computer" (.

4 Double-click the CD-ROM icon (.

5 Double-click the **Sharpdesk** folder, and then double-click **SETUP** (.

6 Follow the instructions on the screen.

- In the license number entry line in the user information screen, enter the license number that appears on the cover of this manual.

- If you select **Typical** in the installation type screen, Network Scanner Tool will also be installed. If you only wish to install Network Scanner Tool, select **Custom** in the installation type screen and then check only Network Scanner Tool.
- Sharpdesk Imaging is installed together with Sharpdesk. If Imaging for Windows was previously installed, Sharpdesk Imaging will overwrite Imaging for Windows.
- The Sharpdesk installation package contains Sharpdesk Imaging, which is a version of Eastman Software's "Imaging for Windows Professional Edition" that has been customized for the Sharp Corporation. If Eastman Software's "Imaging for Windows Professional Edition" has already been installed on your computer, Sharpdesk Imaging will not be installed.
- "Imaging for Windows Professional Edition" and Sharpdesk Imaging use common registry entries, and installing "Imaging for Windows Professional Edition" after Sharpdesk has been installed may cause abnormal operation. In this case, uninstall Sharpdesk and Sharpdesk Imaging, and then install "Imaging for Windows Professional Edition". After that, reinstall Sharpdesk.

Setting up Network Scanner Tool

When installation of the software is completed, the Sharp Network Scanner Tool Setup Wizard will appear. The setup wizard is used to select how you wish your computer to handle images that it receives. You can select multiple methods for handling images (called "Process Definitions"), and each method is automatically assigned to a separate Rapid Key or Speed Dial number on the machine. Follow these steps to set up the Network Scanner Tool.

- ◆ The FO-DC500/600 is referred to as "Copier" in the windows of the setup wizard.

- 1 When the Sharp Network Scanner Tool Setup Wizard appears, click **OK** after confirming that the FO-DC500/600 is connected to the network. Follow the on-screen instructions to complete the setup.

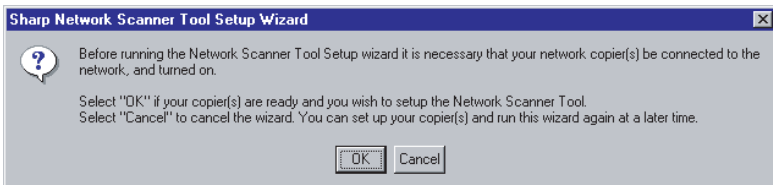

- 2** Enter any name you wish for the Process Definition Prefix and any letter for **Initial**, and click **Next**. The prefix is used in the name that is assigned to the Process Definitions you will select in step 3, and in the name of the Rapid Key or Speed Dial number that is assigned to each selected process.
- The name of your computer initially appears in the Prefix box. If you wish to change the prefix, enter a name in 6 characters.
 - Enter any letter for the **Initial** (the initial is not used on the FO-DC500/600, however, an entry is necessary).

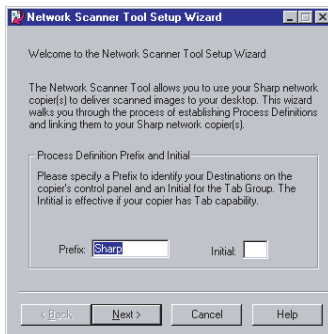

- 3** Select the Process Definitions that you wish to use and click **Next**. Each process that you select will be assigned a Rapid Key or Speed Dial number on the machine.

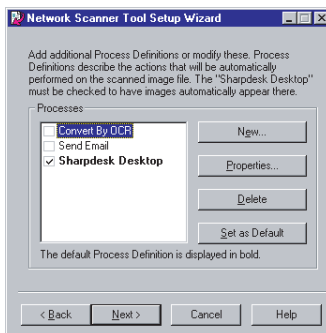

- Network Scanner Tool is shipped with 3 pre-defined sets of instructions called Process Definitions if you install both Sharpdesk and Network Scanner Tool. The “Process Definition Prefix” that was set in Step 2 appears in the name of each process (“Sharp” is used for the prefix in the examples below).

- Convert By OCR (Rapid Key or Speed Dial name: Sharp-OCR)
Converts a scanned file to an editable document.
 - Send Email (Rapid Key or Speed Dial name: Sharp-Email)
Launches your default e-mail application so the file can be e-mailed.
 - Sharpdesk Desktop (Rapid Key or Speed Dial name: Sharp-Desk),
Launches the Sharpdesk application (this is the default application).
- Network Scanner Tool is shipped with 2 pre-defined Process Definitions if you install only Network Scanner Tool.
 - Send Email (Rapid Key or Speed Dial name: Sharp-Email),
 - My Documents (Rapid Key or Speed Dial name: Sharp-MyDocs)
Stores the file in the "My Documents" folder in your computer (this is the default).

- 4** Select the machine (or machines) that you wish to use as a network scanner. The name that initially appears is the machine name set during the installation of the network scanning function. If a name was not set, "FO-DC500(600)" (or a higher number if there are multiple FO-DC500/600 machines on the network) will appear.
- Click the **Properties** button and then the **Advanced** button, and select whether your computer uses an IP address or a host name on the network (ask your network administrator if you do not know).
- When finished, click **Next**.

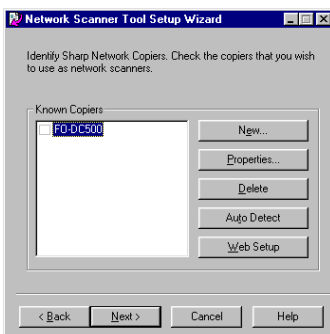

- The FO-DC500/600 is automatically detected on the network.
- The settings in Steps 3 and 4 can be changed later by clicking the Windows **Start** button, pointing to **Programs, Sharpdesk** and then selecting **Network Scanner Tool Configuration**. For more details, see online Help or the Network Scanner Tool User's Guide in the CD-ROM.

- 5 When the completion message appears, click **Finish**.

Uninstalling a program

You can uninstall the software with “Add/Remove Programs” in the Windows Control Panel, or with the Sharpdesk Uninstaller.

- ◆ When Sharpdesk is uninstalled, Network Scanner Tool is also uninstalled. Note that if Network Scanner Tool is uninstalled, you will no longer be able to directly receive image data from the machine.
- ◆ The Sharpdesk desktop folder is not removed when you uninstall Sharpdesk.
- ◆ If you uninstall Sharpdesk Imaging, you will not be able to open image files unless you re-install the Windows accessory Imaging for Windows.
- ◆ If you uninstall the programs, use the Web page in the machine to clear the Rapid Key or Speed Dial number that contained your computer as a Scan to Desktop destination.

Uninstalling the software programs with the Sharpdesk Uninstaller

Click **Start** and then point to **Programs (All Programs** in Windows XP), **Sharpdesk**, and then **Uninstall**. Follow the instructions on the screen.

If an additional FO-DC500/600 machine is installed on the network

If an additional FO-DC500/600 machine is installed on your network after you have installed Sharpdesk and the Network Scanner Tool, it is not necessary to reinstall the software. Simply follow the steps below to automatically detect the new machine.

-
- 1 Click the **Start** button, point to **Programs, Sharpdesk**, and then **Network Scanner Tool Configuration**.
 - 2 Click the **Copiers** tab in the window that appears.
 - 3 Click the **Auto Detect** button. The names of the FO-DC500/600 machines on your network will be displayed. Select the name of the new machine.

Inbound Routing



When the network scanner option is installed, you can have incoming faxes from specified senders (or all senders) automatically converted to e-mail and sent to designated e-mail recipients.

- ◆ This function provides a convenient means of forwarding received faxes to someone who is out of the office.
- ◆ The function can also be used to send copies of all received faxes to an administrator for centralized document storage.

Entering sets of sender's numbers and forwarding e-mail addresses



To use the Inbound Routing function, you must store one or more sets of sender's fax numbers and forwarding e-mail addresses. Each set correlates a particular sender's number (or numbers) with a particular forwarding e-mail address (or addresses). Up to 41 sets can be stored. To be used, a stored set must be activated.

- ◆ When a fax is received from one of the sender's fax numbers in an activated set, the fax is converted to e-mail and sent to each of the forwarding e-mail addresses in that set. When multiple sets are stored, the machine checks each activated set and forwards the fax as appropriate.
- ◆ You can also configure one set to have *all* received faxes forwarded to the e-mail addresses in the set. For example, to have all received faxes forwarded by e-mail to an administrator for centralized storage, select "TRANSFER ALL" in Step 7 of the following procedure and store the e-mail address of the administrator as the forwarding address. Note that only one set can be configured to have all received faxes forwarded.
- ◆ To store a set that uses e-mail addresses in a personal book as forwarding addresses, open the book before storing the set.

- 1** Press **MENU** and then  or  until **ENTRY MODE** is selected in the display.

Display:

```
MENU MODE
 1:RECEIVE MODE
 2:LISTING MODE
▶ 3:ENTRY MODE
```

2 Press  and then  to select **FAX TRANSFER SETTING.**

ENTRY MODE
 07:SYSTEM # MODE
 08:STORE JUNK FAX #
 09:DEPT. PASSCODE
 10:BOOK ENTRY MODE
 ▶ 11:FAX TRANSFER SETTING

3 Press . Make sure that SET is selected.

FAX TRANSFER SETTING
 ▶ 1=SET
 2=CLEAR
 3=ON/OFF

4 Press .

FAX TRANSFER SET
 SETTING #=

5 Enter a 2-digit number from 01 to 41. This number is used to identify the set that you are storing.



6 Enter a name for the set by pressing the letter entry keys (see Step 6 on page 26). (Maximum of 20 characters.)
 If you don't want to enter a name, go directly to Step 7.

7 Press .

- If "TRANSFER ALL" has already been selected for a set, or if you are storing the set from a personal book, you must enter one or more sender's numbers (the display at right does not appear). Go to step 10.

FAX TRANSFER SET # 01
 ▶ 1=INPUT TSI#
 2=TRANSFER ALL

The set number appears here



8 Press  or  to select INPUT TSI# if you wish to only forward faxes from specific sender's numbers. Select TRANSFER ALL if you wish to forward all received faxes.

9 Press .

- If you selected TRANSFER ALL in Step 8, go to step 12.





10 Enter a sender's fax number (max. 20 digits) by pressing the numeric keys and then press . Repeat until all you have entered all desired sender's numbers.



Example: If the sender's number is 201-555-1212, enter 2105551212. **Do not** enter 12105551212 (do not enter "1" for a long distance number).

- A combined total of up to 410 sender's numbers can be entered for all sets. A sender's number that is already entered in another set cannot be entered.
- If you need to delete a sender's number, press  or  to select the number and then press .

11 Press .

12 Enter the forwarding e-mail addresses using any of the following methods:

- Press a Rapid Key.
- Press  and enter a Speed Dial number. (If you enter less than 3 digits for the number, press  to complete the entry.)
- Press , enter an e-mail address, and then press . (Maximum of 20 full e-mail addresses.)

Note: If you need to delete an e-mail address, press  or  to select the address and then press .

Note: Scan to FTP and Scan to Desktop destinations cannot be selected.

13 Press .

FAX TRANSFER SET # 01
▶ 1=ACTIVATE NOW
2=ACTIVATE LATER



14 To activate the set immediately, make sure that **ACTIVATE NOW** is selected in the display and press .

If you do not want to activate the set, press  or  to select **ACTIVATE LATER** and press .

15 Press  repeatedly to return to the date and time display.



Deleting a set

- ◆ To delete a set that was created in a personal book, open the book before performing the steps below.
- ◆ To delete a set, you will need to know its number. To check the number, print the Fax Transfer List as explained on page 200.



1 Press **MENU**  and then  or  until **ENTRY MODE** is selected in the display.

Display:

MENU MODE
 1:RECEIVE MODE
 2:LISTING MODE
 ► 3:ENTRY MODE

2 Press  and then  to select **FAX TRANSFER SETTING**.

ENTRY MODE
 07:SYSTEM # MODE
 08:STORE JUNK FAX #
 09:DEPT. PASSCODE
 10:BOOK ENTRY MODE
 ► 11:FAX TRANSFER SETTING

3 Press  and then  or  to select **CLEAR**.

FAX TRANSFER SETTING
 1=SET
 ► 2=CLEAR
 3=ON/OFF

4 Press .

FAX TRANSFER CLEAR
 SETTING #=



5 Enter the 2-digit number of the set that you wish to delete.

6 Press .

7 Press  repeatedly to return to the date and time display.



Activating or deactivating a set

Even if a set is stored, forwarding will not take place unless the set is activated. Follow these steps to activate or deactivate a set.



1 Press **MENU** and then  or  until **ENTRY MODE** is selected in the display.

Display:

```
MENU MODE
 1:RECEIVE MODE
 2:LISTING MODE
▶ 3:ENTRY MODE
```

2 Press  and then  to select **FAX TRANSFER SETTING**.



```
ENTRY MODE
 07:SYSTEM # MODE
 08:STORE JUNK FAX #
 09:DEPT. PASSCODE
 10:BOOK ENTRY MODE
▶ 11:FAX TRANSFER SETTING
```

3 Press  and then  or  to select **ON/OFF**.

```
FAX TRANSFER SETTING
 1=SET
 2=CLEAR
▶ 3=ON/OFF
```

4 Press .

```
FAX TRANSFER ON/OFF
▶ 01=SETTING #01 [ON]
 02=SETTING #02 [OFF]
```

- 5** Press  or  to select the set that you wish to activate or deactivate and press .

FAX TRANSFER SET # 01
▶ 1=ACTIVATE NOW
2=ACTIVATE LATER

The selected set number appears here

- 6** To activate the selected set, make sure that **ACTIVATE NOW** is selected in the display and press .
- To deactivate the selected set, press  or  to select **ACTIVATE LATER** and press .

- 7** Press  repeatedly to return to the date and time display.

Printing forwarded faxes

The machine is initially set to print all faxes that are forwarded. If desired, you can change this setting to have the machine print only faxes that are not successfully forwarded. See Option Setting 37 on page 198.

File format

The file format when a fax is converted to e-mail is PDF or TIFF as selected in SCAN TO E-MAIL SET-UP (see page 84). The compression method is fixed at G4.

4. Network Printer Option

The FO-NP1 Printer Expansion Kit allows the FO-DC500/600 Document Communication System to be used as a network printer.

The features of the printer include:

- ◆ Print speeds of up to 16 pages per minute.
- ◆ Printing multiple sets of documents.
- ◆ Printing multiple document pages on a single sheet (N-up printing).

The following steps are necessary to use the network printer option. The steps must be completed in the order shown.

1. Your dealer must install the FO-LN1 network interface kit and the FO-NP1 network scanner kit. The machine must be connected to the network.
2. The IP address of the machine must be set as explained in the following section.
3. The printer driver must be installed in all computers on the network that will be using the printer. The printer driver is installed from the CD-ROM that is included in the network printer kit. The procedures for installing the printer driver and configuring print settings are explained in this chapter.

Setting the IP address of the machine

To allow computers to communicate with the printer over the network, the printer must be assigned an IP address. This procedure should be performed by the network administrator or administrator of the machine, and is explained in *Setting the IP Address* on page 75.

Note: Although “DHCP” is available as a setting for the IP address (this means that the machine automatically obtains an address from a DHCP server), it is recommended that a permanent IP address be assigned to the machine. If DHCP must be used, it is recommended that the DHCP lease time for the IP address be set to unlimited.

- ◆ Note that the printer cannot be directly connected to a computer using a parallel cable. The printer must be connected to the network through the FO-LN1 network interface kit.
- ◆ If you plan on moving the printer, contact your Sharp dealer.

Installing the Printer Driver

The SHARP **PCL XL** printer driver printer driver is provided in the CD-ROM in the FO-NP1 printer kit. This driver must be installed in every computer that uses the printer.

Important: The printer driver cannot be installed unless the FO-NP1 Printer Expansion Kit and FO-LN1 LAN interface have been installed in the machine and the machine is ready for use as a network printer.

- ◆ Before installing the printer driver, be sure to read the “Readme” file on the CD-ROM (Option\English\Readme.txt) for the latest information.

System Requirements

You will need the following hardware and software in order to install the printer driver.

Computer	<ul style="list-style-type: none">• IBM PC/AT or compatible computer equipped with an Ethernet interface
Operating System	<ul style="list-style-type: none">• Windows 98 Second Edition, Windows Me, Windows NT 4.0 Workstation/Server (Service Pack 3 or later), Windows 2000 Professional/Server, XP Home/Professional.
CPU	<ul style="list-style-type: none">• Windows 98 / Windows NT 4.0 / Windows Me / Windows 2000: Pentium, 200 MHz or higher• Windows XP: Pentium, 300 MHz or higher
RAM	<ul style="list-style-type: none">• Windows 98 / Windows NT 4.0 / Windows Me / Windows 2000: 64 MB or higher• Windows XP: 128 MB or higher

Printing out the IP address of the printer

In some cases it is necessary to enter the IP address of the machine when installing the printer driver. To check the IP address, follow the procedure in *Printing out the Network Settings* on page 78.

Network types

There are two types of networks, a peer to peer network where you print directly to the printer without going through a server, and a client-server network where you print through a server. Follow the appropriate instructions below for your operating system and your network type to install the printer driver.

Client-server network: Installing the printer driver in the server

To use the printer on a client-server network, the printer driver must first be installed in the server (this must be done before installing the printer driver in client computers). Follow the appropriate procedure for your server's operating system.

Windows 2000 Server

- 1** Click the Windows **Start** button, point to **Settings**, and then click on **Printers**.
- 2** Double-click **Add Printer** in the Printers window to run the Add Printer Wizard and then click **Next**.
- 3** Select **Local Printer**. Make sure that “**Automatically detect and install my Plug and Play printer**” is *not selected* and click **Next**.

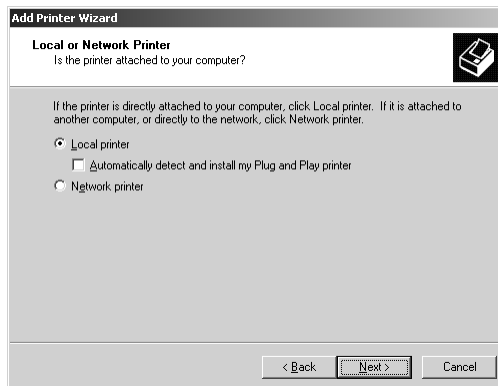

-
- 4** Select **“Create a new port”** and select **“Standard TCP/IP Port”** from the list. Click **Next**.

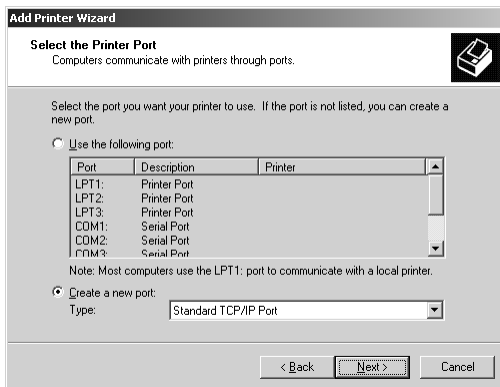

-
- 5** The **“Add Standard TCP/IP Printer Port Wizard”** will appear. Click **Next**.

-
- 6** Enter the IP address of the printer (the port name is filled in automatically).

- If you need to check the IP address, follow the procedure in *Printing out the Network Settings* on page 78.

Make sure that the printer has been turned on and has been configured for network printing, and then click the **Next** button.

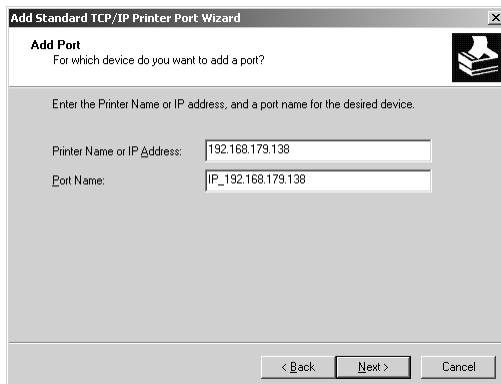

7 Select **Custom** and then click the **Settings** button.



8 The "Configure Standard TCP/IP Port Monitor" window will appear. Select **LPR** for the protocol, and enter any name for the queue name. Click **OK**.

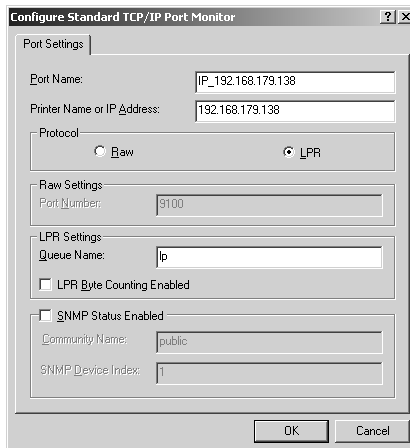

9 Click the **Next** button.

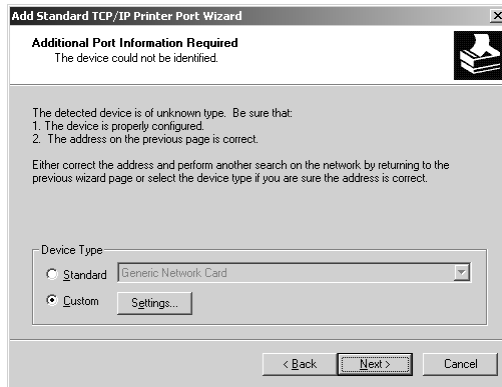

10 Check your settings and then click the **Finish** button.

11 The Add Printer Wizard will display a list of printer models and manufacturers. Click the **Have Disk** button.

12 Insert the PRINTER UTILITIES CD-ROM into your CD-ROM drive. If the "Readme First" window appears, click **Cancel** to close the window.

13 Enter the path Q:\Option\English\2kxp_pclxl (substitute the letter of your CD-ROM drive for "Q") and click the **OK** button.

14 The printer driver name will appear in the Add Printer Wizard. Click **Next**.

- 15** Follow the instructions on your screen. When the “Printer Sharing” window appears, select **Share as**. If you would like to change the name, enter a new name (this must be 8 characters or less to allow sharing with Windows 98/Me computers). Click **Next**.

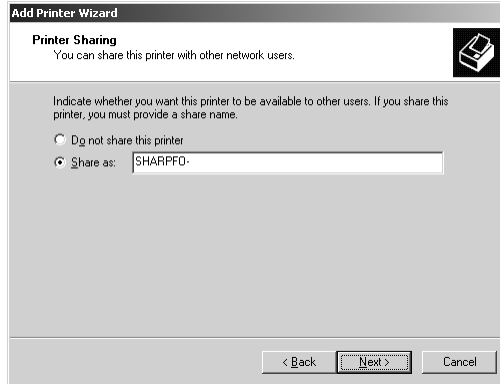

- 16** Enter a location and comment if desired, click **Next**, and then follow the instructions on your screen to finish installing the printer driver.

- If the following window appears at any time, click **Yes** to continue the installation.

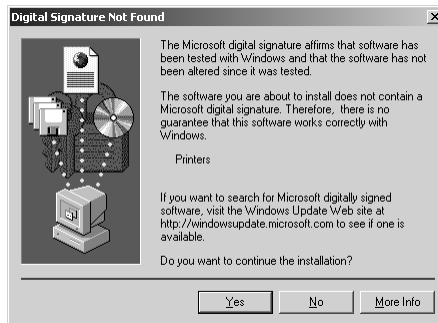

Windows NT Server

- 1** The first step is to install Microsoft TCP/IP Printing. Click the Windows **Start** button, point to **Settings**, and then click on **Control Panel**.

- 2** In the Control Panel window, double-click **Network** to open the Network window. Click the **Services** tab. If “Microsoft TCP/IP Printing” already appears in the list, close the Network window and go to Step 6. If “Microsoft TCP/IP Printing” does not appear, click the **Add** button.

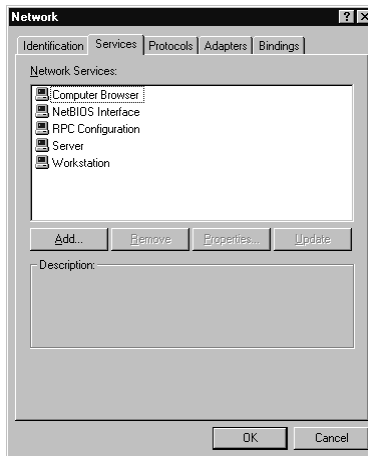

- 3** The “Select Network Service” window shows a list of services. Select “Microsoft TCP/IP Printing”, and click the **OK** button.

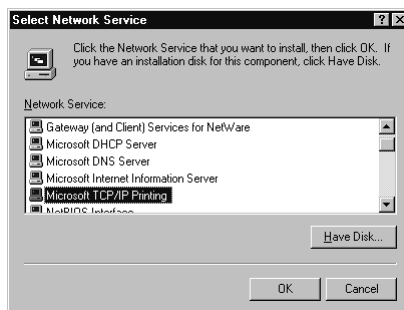

- 4 Insert your Windows NT Server 4.0 CD-ROM into your CD-ROM drive. Make sure the correct path is entered and click the **Continue** button.
- 5 Follow the instructions on your screen to install the component. When finished, restart Windows.
- 6 The next step is to install the printer driver using the Add Printer Wizard. Click the **Start** button, point to **Settings**, and then click on **Printers**.
- 7 Double-click **Add Printer** in the Printers window to run the Add Printer Wizard. Select **My Computer** and then click **Next**.
- 8 A list of the ports will appear. Click the **Add Port** button.
- 9 The Printer Ports window will show a list of the available ports. Select **LPR Port** and click the **New Port** button.

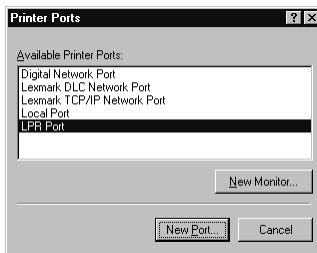

- 10 The “Add LPR compatible printer” window will appear. Enter the IP address of the printer and any queue name you wish, and click the **OK** button.
 - If you need to check the IP address, follow the procedure in *Printing out the Network Settings* on page 78.

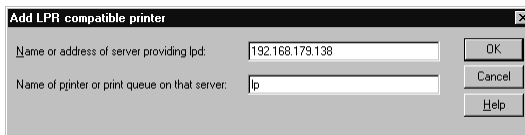

11 Click the **Close** button in the Printer Ports window.

12 Make sure the new port is selected in the list of ports and then click the **Next** button.



13 The Add Printer Wizard will display a list of printer models and manufacturers. Click the **Have Disk** button.

14 Insert the PRINTER UTILITIES CD-ROM into your CD-ROM drive. If the "Readme First" window appears, click **Cancel** to close the window.

15 Enter the path Q:\Option\English\Nt_pclxl (substitute the letter of your CD-ROM drive for "Q") and click the **OK** button.

16 The printer driver name will appear in the Add Printer Wizard. Click **Next**.

- 17** Follow the instructions on your screen. When the following window appears, select **Share**. If you would like to change the Share name, enter a new name (this must be 8 characters or less to allow sharing with Windows 98/Me computers). Click **Next**.

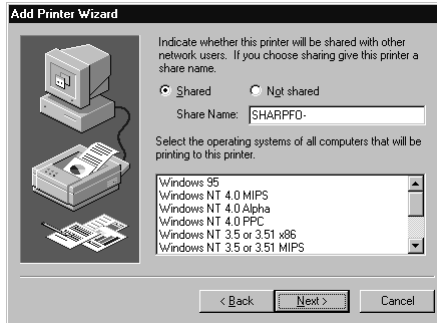

- 18** Follow the instructions on your screen to finish installing the printer driver.

Client-Server Network: Installing the Printer Driver in a Client Computer

There are two ways to install the printer driver in a client computer on a client-server network: using the Integrated Installer in the PRINTER UTILITIES CD-ROM, or using **Add Printer** in the Printers folder in Windows.

- ◆ If you are installing the printer driver in a Windows 2000/XP client when the server is NT Server, see page 122.

Important: The printer driver must be installed in the server before it can be installed in a client computer.

Using the Integrated Installer

The Integrated Installer is included in the PRINTER UTILITIES CD-ROM that came with the network printer kit. The following procedure can be used in all operating systems.

- 1** Insert the PRINTER UTILITIES CD-ROM into your CD-ROM drive.

If the "Readme First" window appears, go directly to Step 4.

-
- 2** Click the Windows **Start** button and then click **Run**.

 - 3** Type `Q:\Setup.exe` (substitute the letter of your CD-ROM drive for “Q”) and then click the **OK** button.

 - 4** The “Readme First” window will appear. Read the text and then click **Next**.

 - 5** Select **User Tools** and click **Next**.

 - 6** Select “PCL XL Printer Driver” and click **Next**.

 - 7** The name of the printer driver to be installed from the CD-ROM will appear. Click **Start**.

 - 8** When the Type of Model window appears, select your model and tray/cassette configuration.

 - 9** Follow the instructions on the screen. When the following window appears, click **Browse** and select “SHARPF0-DC500(600)” (or the name that was entered for the printer when the printer driver was installed in the server).

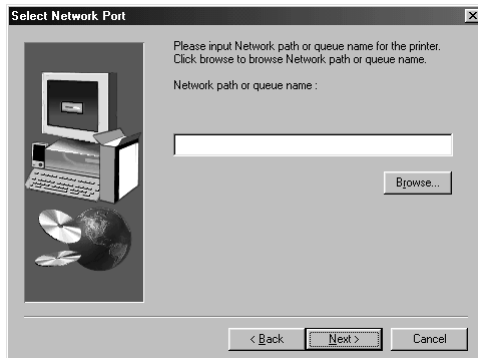

-
- 10** Follow the instructions on the screen to complete the installation.

Using Add Printer

The following procedure is used in all supported operating systems.

- 1** Open the Printers folder in Windows (click the **Start** button, point to **Settings**, and select **Printers**; the exact steps may vary depending on your operating system).
- 2** Double-click **Add Printer** in the Printers window to run the Add Printer Wizard and then click **Next**.
- 3** Select **Network Printer** and click **Next**.
- 4** Click **Browse** and select "SHARPF0-DC500(600)" (or the name that was entered for the printer when the printer driver was installed in the server).
- 5** Follow the instructions on your screen.
 - If the "Readme First" window appears when you insert the PRINTER UTILITIES CD-ROM into your CD-ROM drive, click **Cancel** to close the window.
 - When you are asked to specify the path of the driver, refer to the following table:

Printer Driver Path

Substitute the letter of your CD-ROM drive for "Q" in the path

Operating system	Path
Windows 98/Windows Me	Q:\Option\English\98Me_pclxl
Windows NT 4.0	Q:\Option\English\Nt_pclxl
Windows 2000/XP	Q:\Option\English\2kxp_pclxl

- 6** If at any time the "Digital Signature Not Found" window or other hardware installation warning appears, click **OK** or **Continue Anyway** to continue the installation.

- 7 Follow the instructions on your screen to finish installing the printer driver.

Installation in a Windows 2000/XP client when the server is NT Server

To install the printer driver in a Windows 2000/XP client when the server is NT server, follow the *Using Add Printer* procedure on the previous page. In Step 3, select **Local Printer**, click **Next**, and then go to Step 5. When the port selection window appears, select LPT1 (this is just a temporary selection). Continue following the on-screen instructions to complete the installation.

Next, repeat the procedure once again, only this time select **Network Printer** in Step 3 (follow all steps of the procedure as indicated). When the installation is completed, open the Printers window. Two Sharp printer icons will appear, one for a local printer and one for a network printer. Delete the icon for a local printer.

Peer to Peer Network: Installing the Printer Driver

Follow the appropriate procedure for your operating system to install the printer driver in a computer on a peer to peer network.

Windows 2000/XP

Follow Steps 1 through 14 of the procedure for installing the printer driver in Windows 2000 Server. In Step 15, select **“Do not share this printer”**, click **Next**, and then follow the instructions on your screen to finish installing the printer driver.

During the procedure you will need to enter the IP address of the printer. To check the IP address, see “Printing out the IP address of the printer” on page “Printing out the IP address of the printer” on page 110.

Windows NT

Follow Steps 1 through 15 of the procedure for installing the printer driver in Windows NT Server. In Step 16, select **Not shared**, click **Next**, and then follow the instructions on your screen to finish installing the printer driver.

During the procedure you will need to enter the IP address of the printer. If you need to check the IP address, follow the procedure in *Printing out the Network Settings* on page 78 .

Windows 98/Me

Before installing the printer driver in Windows 98/Me, you must first install the IP Peer-to-Peer Redirector. The IP Peer-to-Peer Redirector is installed from the CD-ROM in the FO-LN1 network interface kit. Follow these steps to install the IP Peer-to-Peer Redirector and then the printer driver.

- 1** Insert the FO-LN1 network interface CD-ROM into your CD drive.

- 2** Click the **Start** button and select **Run**.

- 3** Type in `Q:\IP-P2P\SETUP.EXE` (substitute the letter of your CD-ROM drive for "Q"), and click **OK**.

- 4** Follow the instructions in the Setup program.
 - If the Setup program detects a previous installation of the IP Peer-to-Peer Redirector, the program asks whether to delete the old driver and continue the installation procedure. Click **Yes** or **No**.

- 5** When the Peer-to-Peer Setup screen appears, click **Find Printers**.

- 6** Select the name of the printer to install. Then click **Select** and **Permanent**.

- 7** Click **OK**.
 - After the redirector is installed, the printer selected in Step 6 will appear as a port in Printer Properties.

- 8** Next, install the printer driver. Click the **Start** button, point to **Settings**, and then click on **Printers**.

- 9** Double-click **Add Printer** in the Printers window to run the Add Printer Wizard and then click **Next**.

-
- 10** Select **Local Printer** and click **Next**.
-
- 11** The Add Printer Wizard will display a list of printer models and manufacturers. Click the **Have Disk** button.
-
- 12** Insert the PRINTER UTILITIES CD-ROM into your CD-ROM drive. If the "Readme First" window appears, click **Cancel** to close the window.
-
- 13** Enter the path `Q:\Option\English\98Me_pclxl` (substitute the letter of your CD-ROM drive for "Q") and click the **OK** button.
-
- 14** The printer driver name will appear in the Add Printer Wizard. Click **Next**.
-
- 15** The Add Printer Wizard will show a list of available ports. Select the port you added when you installed the IP Peer-to-Peer Redirector and click **Next**.
-
- 16** Follow the instructions on your screen to finish installing the printer driver.

Printer Status Monitor and Printer Administration Utility

The Printer Status Monitor allows you to monitor the status of print jobs that you send to the printer. The Printer Administration Utility provide tools for the administrator to monitor and configure the printer. Follow the steps below to install either of these components.

For information on using the Printer Status Monitor or Printer Administration Utility, see the Help files for each.

-
- 1** Insert the PRINTER UTILITIES CD-ROM into your CD-ROM drive.
- If the "Readme First" window appears, go directly to Step 4.
-
- 2** Click the **Start** button and then click **Run**.

-
- 3** Type `Q:\Setup.exe` (substitute the letter of your CD-ROM drive for “Q”) and then click the **OK** button.

 - 4** The “Readme First” window will appear. Read the text and then click **Next**.

 - 5** To install the Printer Status Monitor, select **User Tools**. To install the Printer Administration Utility, select **Administrator Tools**. When finished, click **Next**.

 - 6** Select **Printer Status Monitor** or **Printer Administration Utility** as appropriate and click **Next**.

 - 7** The name of the component to be installed from the CD-ROM will appear. Click **Start**.

 - 8** Follow the instructions on your screen to complete the installation.

Printing a Test Page from Your Computer

You can print a test page to make sure that the printer and your computer are communicating correctly.

-
- 1** From the Windows desktop, click on the **Start** button.

 - 2** Point to **Settings** and then click on **Printers**.

 - 3** Right click on the Sharp printer icon and then click on **Properties**.

 - 4** Click on **Print Test Page**.

 - 5** Follow the instructions on the screen to print the test page.

Setting Up Status and Alert Messages

You can set up the machine to automatically send status and alert messages by e-mail to specified recipients.

- ◆ Status messages are sent on a regular basis (you can select the schedule), and let you know the number of pages that have been printed for copying and for network printing (the print count includes received faxes and lists printed from the operation panel of the machine).
- ◆ Alert messages alert you to problems in the machine that affect printing, such as paper jams, out of paper, and out of toner. You can select the conditions that cause an alert message to be sent.

Accessing the Web page in the machine

To set up status and alert messaging, access the machine's Web page from a computer that is connected to the same network as the machine. The Web page can be displayed with your Web browser (Internet Explorer 4.0 or later, or Netscape Navigator 4.0 or later).

To access the Web page in the machine, type in the IP address of the machine in your browser in the format **http://XXX.XXX.X.X**, where the X's are the IP address (the number of digits between periods will vary depending on the address). If you need to check the IP address of the machine, print out the network settings as explained on page 110.

Mail server and DNS server

To have the status and alert messages sent by e-mail, your mail server and DNS server settings must be configured. Click **E-mail & DNS Setup** in the menu at the left of the Web page and enter the information in the appropriate boxes.

Note that your DNS server must be entered if you enter a host name instead of an IP address in **E-mail Server** under E-mail Setup.

Setting up status and alert messaging

To set up status and alert messaging, first click **Status & Alert E-mail** in the menu at the left of the Web page. Enter a name for the machine, and a machine code (if desired) and location. For more information on the settings, click **Help** at the bottom of the Web page menu.

Next, click **Status Message Parameters** in the Web page menu. Enter the e-mail addresses to which status messages are to be sent, and select the schedule (1 or 2) for sending status messages. Schedules 1 and 2 can be set up at the bottom of the page.

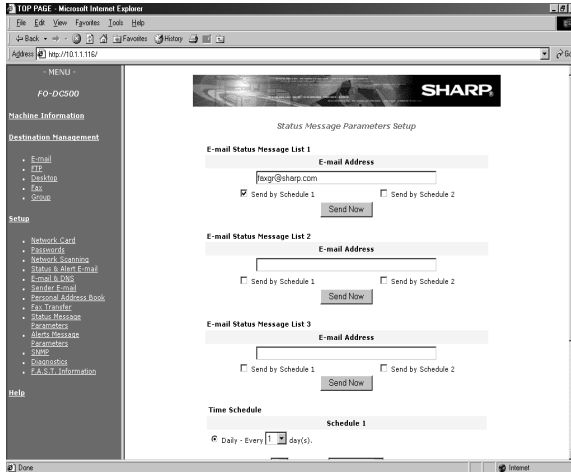

To set up alert messaging, click **Alert Message Parameters** in the Web menu. Enter the e-mail addresses to which alert messages are to be sent, and select the conditions that will cause an alert message to be sent.

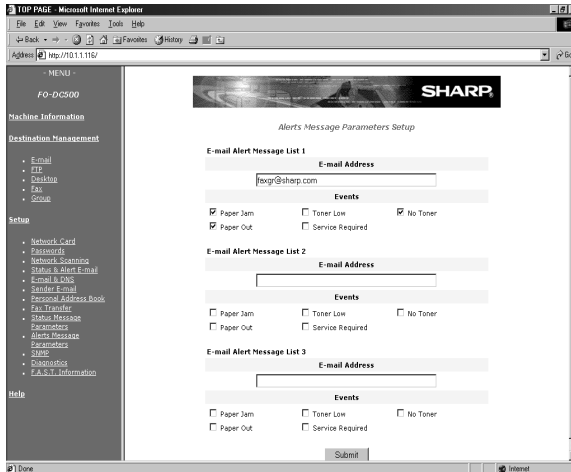

Setting Passwords

Passwords can be set to restrict Web page access and protect settings. For more information, see page 80.

Printing from a Computer

Before printing, make sure that the ON LINE indicator on the machine is lit. If the ON LINE indicator is not lit, press  to switch the machine to the on-line state.

-
- 1** When you are ready to print a document from an application on your computer, select **Print** from the File menu. The Print dialog box appears.

 - 2** If you need to adjust any of the print settings, select **Properties**, **Setup**, or **Printer** from the Print dialog box (the name of the button varies depending on the application).

 - 3** The Properties appear. Adjust the settings as desired, and then click **OK**. (The settings are explained in the following pages and in on-screen Help.)

 - 4** Select the print range and adjust any other settings as desired in the Print dialog box.

 - 5** When you are ready to begin printing, click **Print** or **OK** in the Print dialog box.





Note: When you adjust the print settings as explained above in Step 2, your changes will only remain in effect while you are using the application. If you wish to make permanent changes, open the Printers folder in Windows, right-click on the Sharp printer icon, and select **Properties** (Windows NT: **Document Defaults**, Windows 2000/XP: **Printing Preferences**) from the sidebar menu.

Canceling a print job

Follow the steps below to cancel a print job.



- ◆ If there is a problem with a print job that is sent to the machine (for example, the machine does not have the paper size specified for the job) the **ALARM** light on the machine will come on. When this happens, you can either cancel the job, or continue the job in spite of the problem.

Canceling a print job

- 1 Press  twice to display the **NETWORK PRINT STATUS** screen.
- 2 Press  once to switch the machine off-line.
- 3 Press .
- 4 Press  to select **YES**.

Continuing a print job when the **ALARM** light is on

Note: If the **ALARM** light has come on because the machine does not have the size of paper specified for the job and you continue the job anyway, the job will be printed on a different size of paper.

- 1 Press  twice to display the **NETWORK PRINT STATUS** screen.
- 2 Press .
- 3 Press  to select **YES**.

Opening the Printer Driver

Opening the printer driver from an application

When you adjust the printer driver settings from an application, your changes will only remain in effect while you are using the application.

- 1** Within the application, select **Print** from the **File** menu.

- 2** Click the **Properties**, **Setup**, or **Printer** button in the Print dialog box (the name of the button varies depending on the application).

- 3** The properties of the SHARP FO-DC Series printer driver will appear.

- 4** Select the desired settings on each tab.

- 5** Click the **OK** button to store the settings and close the properties.

Opening the printer driver from the Start menu

When you adjust the printer driver settings from the Start menu, your changes will remain in effect for all subsequent jobs.

- 1** Open the Printers folder (click the **Start** button, point to **Settings**, and select **Printers**; the exact steps may vary depending on your operating system).

- 2** Right-click the Sharp printer driver icon and select **Properties** (Windows NT: **Document Defaults**, Windows 2000/XP: **Printing Preferences**) from the sidebar menu.

- 3** The properties of the SHARP FO-DC Series printer driver will appear.

- 4** Select the desired settings on each tab.

- 5** Click the **OK** button to store the settings and close the properties.

Printer Driver Settings

The print settings that can be selected in the Paper, Page Layout, Quality, and Options tabs of the printer driver are described below.

Paper tab

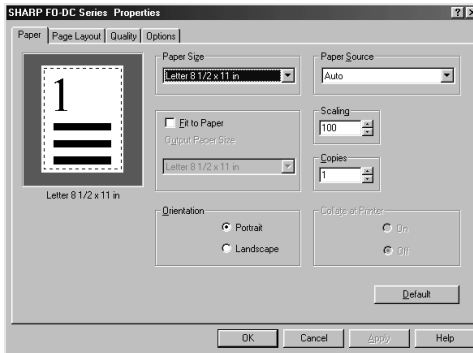

Paper Size

Select the paper size to be used for printing.

If the paper size set in the application is different from this setting, the paper size in the application normally takes precedence.

Fit to Paper

Check **Fit to Paper** to adjust the size of the image sent from the application to the paper size specified in **Output Paper Size**.

Limitations:

When one of following is selected, the "Fit to Paper" function can not be selected.

Scaling: Any setting except 100%

N-Up: Any setting except Off

All Raster: On

Note: When **Fit to Paper** is selected, the paper size specified in the application is not used (the size specified in the **Fit to Paper** setting is used instead).

Orientation

Select **Portrait** or **Landscape** for the orientation.

Paper Source

Select the paper source to be used. When **Auto Select** is selected, the source which contains the same size of paper as the paper size setting is automatically selected. If a specific source is selected, paper is drawn from that source regardless of the paper size setting.

Limitation:

The Paper Source selections that appear are determined by the **Input Option** setting in the Options tab. When the Input Option setting is **Tray only**, **Cassette 1** and **Cassette 2** are not available. When the **Input Option** setting is **Tray + Cassette**, **Cassette 2** is not available.

Scaling

Scaling allows you resize an image on the paper.

Limitation:

When one of following is selected, **Scaling** can not be selected.

N-Up: Any setting except Off

Fit to Paper: On

All Raster: On

Copies

Use this box to specify the number of copies (from 1 to 99).

Collate at Printer

Select **On** if you want copies of each page to be printed in collated sets (1,2,3, · 1,2,3, · 1,2,3, · ...).

Select **Off** if you want copies of each page to be printed together (1,1,1, · 2,2,2, · 3,3,3, · ...).

Note: **On** can only be selected when a number greater than "1" is selected for the **Copies** setting.

Page Layout tab

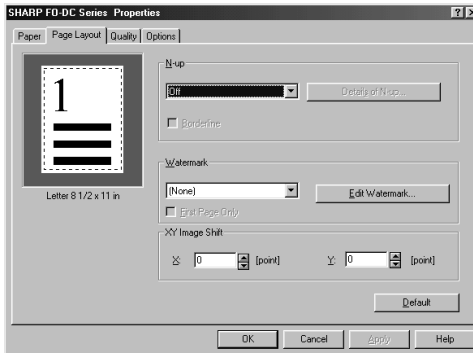

N-up

N-up allows multiple document pages (where **N** is the number of pages) to be printed on a single sheet of paper by reducing each page. Selections are **Off**, **2-up**, **4-up**, **9-up** and **16-up**.

Limitation:

When any of the following settings are selected, the N-up function cannot be used.

- Fit to Paper: On
- Scaling: Any setting except 100%
- All Raster: On

Borderline

When the borderline feature is selected with **N-up**, borderlines are printed around each document page on the sheet of N-up output.

Limitation:

The borderline feature cannot be selected when **N-up** is set to **Off**.

Details of N-up

Click the **Details of N-up** button to open the “Details of N-up” window. This allows you to select the layout order for N-up printing.

Limitation:

Details of N-up cannot be selected when **N-up** is set to **Off**.

Watermark

To have a watermark printed on each page of your output, select the desired watermark from the list (“CONFIDENTIAL”, “DRAFT”, “DO NOT COPY” or “COPY”). When **None** is selected, the Watermark is not printed. You can also add a new Watermark to the list.

First Page Only

Select this checkbox to print the Watermark on the first page only.

Edit Watermark

Click the **Edit Watermark** button to open the “Edit Watermark” window. This window lets you modify, add, or delete a Watermark.

XY Image Shift

This setting lets you shift the position of the image on the paper. Use the up and down arrows to select amount of the shift in the X and Y directions (from -10 to 10).

Quality tab

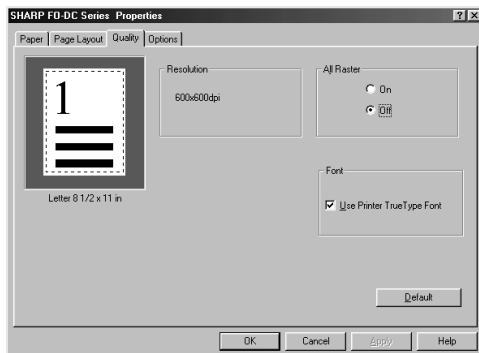

Resolution

The resolution is fixed at 600 dpi.

All Raster

Select **On** to print images using Raster Graphics (the image will consist of a group of dots similar to bitmap data or an image captured with a scanner) .

Limitation:

When any of the following settings are selected, the All Raster function cannot be selected.

Scaling: Any setting except 100%

Fit to Paper: On

N-up: Any setting except Off

Use Printer True Type Font

Set this checkbox to use the True Type fonts that are resident in the printer. When this checkbox is not selected, printing will take place using fonts downloaded from the computer.

Limitation:

When the **All Raster** setting is selected, this function cannot be used.

Options tab

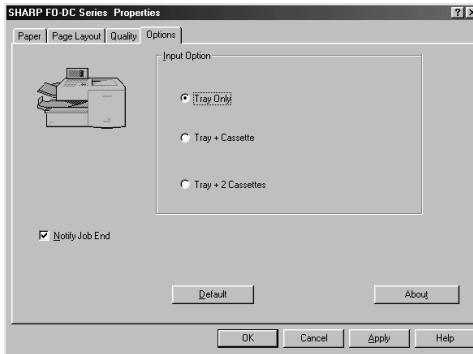

Input Option

Use this setting to specify the paper sources that are installed in the machine. The sources that you specify here will be available for selection in the Paper Source setting in the Paper tab. For example, if **Tray + Cassette** is selected, the selections in the Paper Source list will be **Tray, Cassette 1**, and **Auto**.

Notify Job End

Select this checkbox if you wish to be notified through the Printer Status Monitor when your print jobs are completed.

Limitations:

Notify Job End only functions when the Printer Status Monitor is open.

About

Click this button to check the version of the printer driver and copyright information.

5. Making Copies

Your machine can also be used to make copies. Single and multiple copies (up to 99 per original) can be made, enabling the machine to double as an office copier.

- ◆ You can perform all steps of a copy job even when the machine is busy printing other copy jobs, or when it is printing a received fax after the line has been disconnected. Your copy job will be automatically stored in memory and then printed when all previous printing jobs are completed.
- ◆ The default resolution for copying is FINE. If desired, you can change the default resolution to SUPER FINE or ULTRA FINE by changing Option Setting 30 (see page 197).

1 Load the document.

- SEND READY will appear in the display.
- Press **RESOLUTION** and/or **CONTRAST** to set the resolution and contrast if needed.

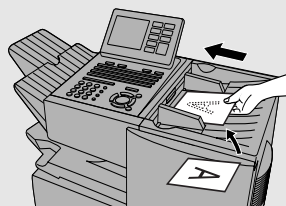

2 Press **COPY/HELP**.

- If you are only making a single copy of the original (or of each original), press



. Copying will begin.



Display:

COPY MODE	
ENTER #(01-99)	01

3 Enter the desired number of copies per original with the numeric keys.

- If the desired number of copies is from 1 to 9, enter "0" first.

MULTI/SORT COPY MODE	
▶ 1 = MULTI	
2 = SORT	

- 4** Select **MULTI** if you do not want the copies sorted, or **SORT** if you want the copies sorted (press  or ).

Example of three copies each of three originals

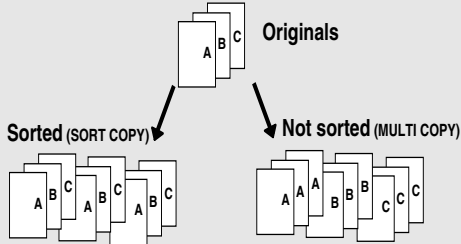

- 5** Press  to begin copying.

Checking and canceling copy jobs in memory

You can display the status of copy jobs in memory by following the steps below. You can also cancel a copy job with this procedure.

- 1** Press  (flip up the Rapid Key overlay). Make sure that **COPY STATUS** is selected in the display.

Display:

```
MEMORY STATUS REPORT
▶ 1: COPY STATUS
  2: MEMORY TX STATUS
  3: MEMORY RX STATUS
  4: MESSAGE CLEAR
```

- 2** Press .

- The copy jobs appear.
- To print out the list of jobs, press







Number of stored copy jobs

3-digit memory number assigned to job

```
COPY STATUS (004)
▶ 001:M#133    10:36 AM
  COPY       : COPYING
  002:M#136    10:39 AM
  SORT COPY  : COPYING
```

Type of job (sort or not)

3 Press  or  to scroll through the list of jobs.

To cancel a job, press  or  to select the job, press , and then press .

4 When you have finished checking the list, press  twice to return to the date and time display.

6. Special Functions

Broadcasting

The Broadcasting function allows you to send the same fax to as many as 179 destinations on the FO-DC500, or 279 destinations on the FO-DC600, in a single operation. First load the document, then enter the numbers of the receiving machines. The document will be automatically transmitted to each destination.

- ◆ If the network scanner option is installed, you can also select e-mail recipients as destinations of a broadcast transmission (this is called "I SEND MODE"). An e-mail address can be entered directly or specified using a Rapid Key or Speed Dial number.



1 Load the document (s).

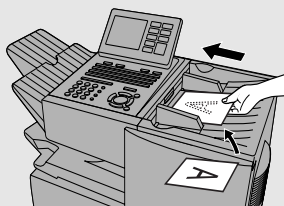

- SEND READY will appear in the display.





2 Press **BROADCAST** .

3 Select the destinations using any of the following methods:



- Press a Rapid Key.
- Press **SPEED DIAL**  and enter a Speed Dial number. (If you enter less than 3 digits for the number, press **START/ENTER**  to complete the entry.)
- Press a Group Key. (See *Storing numbers in Group Keys* on page 142.)
- Enter a full fax number with the numeric keys (max. 60 digits) and then press **START/ENTER** . (Note: A maximum of 20 full fax numbers can be entered. Less can be entered if a large number of programs, timer operations, and/or group keys have been stored.)

- Press  , enter an e-mail address, and then press  . (Only if the network scanner option is installed; maximum of 20 full addresses.)

Note: If you need to delete a destination, press  or  to select the destination and then press  .





Note: Scan to FTP and Scan to Desktop destinations cannot be selected.

4 Press  .

5 If desired, press  and/or  to set the resolution and contrast.

6 If you are sending the document to only fax destinations, press  twice. Transmission will begin.

If e-mail recipients are included in the destinations, press  once and go to the following step.

7 If you are sending the document to e-mail destinations, the display at right will appear to let you adjust the e-mail settings. To adjust a setting, press  or  to select the setting and then press  (see Step 6 on page 88 for information on adjusting the settings). Note that if you don't select a file format, the format selected in SCAN TO E-MAIL SETUP (page 84 and following) is used. When you are ready to send the document, select "START SCANNING" and press  .

Display when e-mail recipients have been selected:

```

▶ 1:START SCANNING
  2:FROM
    XXX
  3:FILE FORMAT
    XXX
  4:MESSAGE
    NO MESSAGE
    
```

Note: If fax destinations have also been selected, the selections for the file format are "TIFF-G4" and "PDF-G4" (G3 cannot be used).

When broadcasting to fax destinations, a Transaction Report is automatically printed out after broadcasting is completed. Check the "Note" column of the report to see if any of the fax destinations are marked "Busy" or have a communication error code. If so, send the document to those destinations again.

Broadcasting using a Group Key

If the destinations to which you want to broadcast have all been programmed into one Group Key (see *Storing destinations in Group Keys* which follows), you can perform the broadcasting operation using the following simplified procedure.

- ◆ When using a Group Key to broadcast to e-mail destinations, the file format selected in SCAN TO E-MAIL SETUP (page 84 and following) is used if a file format is not selected in Step 2 below. If the Group Key also contains fax destinations, only "TIFF-G4" and "PDF-G4" can be used for the format.

1 Load the document(s).

- SEND READY will appear in the display.
- Press **RESOLUTION** and/or **CONTRAST** to set the resolution and contrast if needed.

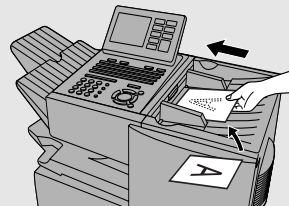

2 Press the appropriate Group Key. If the key contains only fax destinations, transmission will begin.



If the key contains e-mail addresses, you can set e-mail options as explained in Step 7 of the Broadcasting procedure. Press **W** WITHIN 5 SECONDS after pressing the Group Key.



Storing destinations in Group Keys



Group Keys allow you to dial a group of fax numbers by simply pressing the appropriate Group Key once. To store a group of numbers in a Group Key, follow the steps below.

- ◆ Any Rapid Key that is not already programmed as a Rapid Key or a Program Key can be used as a Group Key.
- ◆ Up to 158 numbers can be stored in one Group Key on the FO-DC500, or 258 numbers on the FO-DC600.
- ◆ If the network scanner option is installed, e-mail addresses can also be stored in a Group Key.
- ◆ To store a fax number or e-mail address in a Group Key, it must be previously stored in a Rapid Key or Speed Dial number. Fax numbers and e-mail addresses cannot be directly entered.

- 1** Press **MENU** and then  or  until **PROGRAM/GROUP MODE** is selected in the display.

Display:

MENU MODE
 2:LISTING MODE
 3:ENTRY MODE
 4:OPTIONAL SETTING
 ► 5:PROGRAM/GROUP MODE

- 2** Press  and then  or  to select **GROUP ENTRY MODE**.

PROGRAM/GROUP MODE
 1:PROGRAM ENTRY MODE
 ► 2:GROUP ENTRY MODE

- 3** Press .

GROUP ENTRY MODE
 ► 1=SET
 2=CLEAR

9 Press  .

10 Return to Step 5 to program another Group Key, or press  repeatedly until you return to the date and time display.

Editing a group

If necessary, you can add numbers to or delete numbers from a group by repeating the programming procedure for the Group Key. Select SET in Step 3 and select the Group Key in Step 5. Add or delete numbers as explained in Step 8.

Confidential Operations

The Confidential function can be used to transmit and receive confidential documents.

Confidential transmission

When you send a document using the Confidential function, the receiving machine holds it in memory instead of immediately printing it out. When the receiving party enters the correct passcode, the document is printed out.

- ◆ Confidential transmission is only possible when the receiving machine is a Sharp model with confidential reception capability.
- ◆ To use this function, your name and fax number (OWN PASSCODE) must be entered in your machine as explained on page 25.
- ◆ Some machines have multiple mailboxes for receiving confidential faxes. If you are sending to a machine with multiple confidential mailboxes, contact the receiving party in advance for the appropriate mailbox number.

1 Load the document (s).

- SEND READY will appear in the display.
- Press **RESOLUTION** and/or **CONTRAST** to set the resolution and contrast if needed.

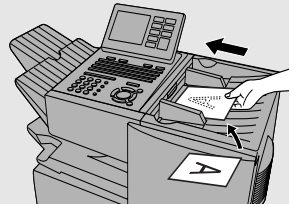

2 Press **CONFIDENTIAL** (flip up the Rapid Key overlay if it is down).

Display:

```

CONFIDENTIAL FUNCTION
▶ 1:CONFIDENTIAL TX
  2:CONFIDENTIAL DATA PRINT
  3:CONFIDENTIAL CODE SET
  4:CONFIDENTIAL CODE CLEAR
  
```





3 Make sure that **CONFIDENTIAL TX** is selected and then press **START/ENTER**.

4 If the receiving machine has multiple confidential mailboxes, enter the appropriate mailbox number with the numeric keys (this step is required for machines with multiple mailboxes).

If the receiving machine doesn't have multiple mailboxes, go directly to Step 5.

5 Press  .

6 Dial the receiving machine using one of the following methods:

- Press a Rapid Key.
- Press  and enter a Speed Dial number (if you enter less than 3 digits, press  to complete the entry). Check the name that appears, and then press .
- Enter a full fax number with the numeric keys, and press .

Transmission will take place when the connection is established.

Confidential reception



When another machine sends you a document by confidential transmission, your machine holds it in memory instead of immediately printing it out. The document cannot be printed out until you enter the correct passcode.

Your fax has 10 "mailboxes" in which confidential documents can be received. Each mailbox has its own passcode, allowing up to 10 different people or groups to each receive their own confidential documents. The mailboxes are identified by 2-digit numbers.

Programming the confidential passcode

To receive a confidential document, you must first program a 2-digit mailbox number and a 4-digit passcode.

Note: Be sure to inform the transmitting party of your 2-digit mailbox number in advance. The transmitting party will need this number to send you confidential faxes.

- 1 Press  (flip up the Rapid Key overlay if it is down) and then  or  until **CONFIDENTIAL CODE SET** is selected in the display.

Display:

CONFIDENTIAL FUNCTION

1:CONFIDENTIAL TX

2:CONFIDENTIAL DATA PRINT

▶ 3:CONFIDENTIAL CODE SET

4:CONFIDENTIAL CODE CLEAR

- 2 Press .

- 3 Enter a 2-digit number (from "00" to "99") by pressing the numeric keys. This number identifies the mailbox.

- 4 Enter a 4-digit passcode for the mailbox with the numeric keys.

- 5 Press .

- 6 Enter a name for the mailbox (max. of 20 characters) by pressing the letter entry keys (make sure the Rapid Key overlay is down).

Example: SHARP =      

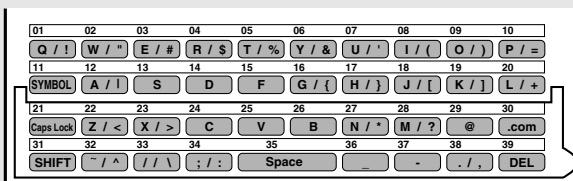

- For more information on entering letters, see Step 6 on page 26.



7 Press .

Note: After entering the passcode, the machine will print it out for your records. If you forget the passcode and have kept no record, contact your Sharp dealer.

Clearing a passcode

1 Press  (flip up the Rapid Key overlay if it is down) and then  or  until **CONFIDENTIAL CODE CLEAR** is selected in the display.

Display:

CONFIDENTIAL FUNCTION
1:CONFIDENTIAL TX
2:CONFIDENTIAL DATA PRINT
3:CONFIDENTIAL CODE SET
▶ 4:CONFIDENTIAL CODE CLEAR

2 Press .



3 Enter the 2-digit number that identifies the mailbox you want to clear.

4 Enter the 4-digit passcode of the mailbox with the numeric keys.

5 Press .

Printing out received documents

When you have received a confidential document, RCVD CONF. FAX will appear in the display. Print out the Confidential Reception List as explained on page 200 to see which mailbox has received the document, and then follow the steps below to print out the document.

- 1** Press  (flip up the Rapid Key overlay if it is down) and then  or  until **CONFIDENTIAL DATA PRINT** is selected in the display.

Display:

```
CONFIDENTIAL FUNCTION
1:CONFIDENTIAL TX
▶ 2:CONFIDENTIAL DATA PRINT
3:CONFIDENTIAL CODE SET
4:CONFIDENTIAL CODE CLEAR
```

- 2** Press .

- 3** Enter your mailbox number.

- 4** Enter your confidential passcode.

- 5** Press .

- Printing will begin. After printing, the document will be erased from memory.



Polling

Polling allows you to call another fax machine and have it send a document to your machine without operator assistance. In other words, the receiving fax machine, not the transmitting fax machine, initiates the transmission. You can use your machine to both poll and be polled by others.

Polling others

To poll another fax machine, follow the steps below.

- ◆ If desired, you can dial more than one fax number to receive documents consecutively from a group of fax machines (this is called "Serial Polling"; a maximum of 179 fax machines can be polled in one operation on the FO-DC500, or 279 fax machines on the FO-DC600).



- 1** Press **MENU** and then  or  until **SERIAL POLLING MODE** is selected in the display.

Display:



```
MENU MODE
3:ENTRY MODE
4:OPTIONAL SETTING
5:PROGRAM/GROUP MODE
▶ 6:SERIAL POLLING MODE
```

- 2** Press .

- 3** Dial the number(s) of the fax machine(s) you want to poll using any of the following methods:

- Press a Rapid Key.
- Press  and enter a Speed Dial number. (If you enter less than 3 digits for the number, press  to complete the entry.)
- Press a Group Key. (See *Storing destinations in Group Keys* on page 142.)

- Enter a full fax number with the numeric keys (max. 60 digits) and then press . (Note: A maximum of 20 full fax numbers can be entered. Less can be entered if a large number of programs, timer operations, and/or group keys have been stored.)

Note: If you need to delete a destination, press  or  to select the destination and then press .

4 Press . Reception will begin.

Serial Polling using a Group Key

If the fax machines you want to poll have all been programmed into one Group Key, you can poll them by simply pressing that Group Key. (The procedure for programming Group Keys is explained on page 142.)

- ◆ Make sure no documents are in the feeder before you press the Group Key.

Being polled (Memory polling)



To let another fax machine poll your machine, you must first store the document(s) in memory using the following procedure. Transmission will take place when the other fax machine calls your machine and activates polling. You can choose whether to allow polling only once, or an unlimited number of times. In the latter case, your machine can be used as an electronic "bulletin board".

- ◆ Multiple documents can be stored for memory polling. To add a document to others already stored, simply repeating the storing procedure (note that if Department Control is activated, documents cannot be added by a department other than that which stored the first document). When polling is initiated, the polling machine will receive all documents stored.
- ◆ If you allow polling only once, the document(s) will be automatically cleared from memory after polling. If you allow polling an unlimited number of times, the document will remain in memory until you clear it as explained in the following section, *Clearing a document*.

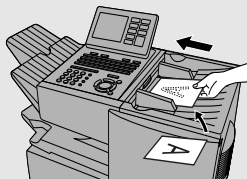
1 Load the document.



2 Make sure the reception mode is set to AUTO (see page 63).

3 Press **MENU** and then  or  until **MEMORY POLL MODE** is selected in the display.

Display:

MENU MODE
 4:OPTIONAL SETTING
 5:PROGRAM/GROUP MODE
 6:SERIAL POLLING MODE
 ▶ 7:MEMORY POLL MODE

4 Press .

MEMORY POLLED MODE
 ▶ 1=SET
 2=CLEAR

5 Make sure that “SET” is selected in the display and then press .

Display when no other memory polling documents are stored:

MEMORY POLLED SET
 ▶ 1=1 TIME
 2=REPEAT

Display when another document is already stored:

MEMORY POLLED SET
 ▶ 1=APPEND
 2=CANCEL

6 If no other memory polling documents have been stored, select “1 TIME” to allow polling only once, or “REPEAT” to allow polling an

unlimited number of times, and then press .

If another document has already been stored, make sure that **APPEND** is selected and then press .



7 Press  and/or  to adjust the resolution and contrast if desired, and then press .

8 Press .

- The document will be scanned into memory, and your fax will go on polling standby.



Clearing a document

To clear a memory poll document (or documents) from memory, follow the steps below:

1 Press  and then  or  until **MEMORY POLL MODE** is selected in the display.

Display:

```
MENU MODE
4:OPTIONAL SETTING
5:PROGRAM/GROUP MODE
6:SERIAL POLLING MODE
▶ 7:MEMORY POLL MODE
```

2 Press  and then  or  to select **"CLEAR"**.

```
MEMORY POLLED MODE
1=SET
▶ 2=CLEAR
```

3 Press  twice to clear the documents.

Polling Security

Polling Security allows you to prevent unauthorized polling of your machine. When this function is activated, polling will only take place when one of the following conditions is met:

- ◆ The fax number of the polling fax machine has been stored in your machine's list of permitted fax numbers (called "passcode numbers"). The polling fax machine must also have its fax number programmed in itself, as explained in *Entering Your Name and Fax Number* in Chapter 1.
- ◆ A System number has been programmed in the polling fax machine which matches your machine's System number or one of your machine's ID numbers.
- ◆ An ID number has been programmed in the polling fax machine which matches your machine's System number.

System and ID numbers are 4-digit numbers which provide you with an alternate means of giving and receiving polling permission when you don't want to use fax numbers. The steps for programming these numbers are described in the following pages.



Note: System and ID numbers can only be used if the other fax machine is also a Sharp machine.

Turning Polling Security on and off

Polling Security is turned on or off with Option Setting 8 as explained on page 191.



Storing and clearing fax numbers for polling permission

You can store up to 10 fax numbers in your machine's list of permitted numbers.

- 1** Press **MENU** and then  or  until **ENTRY MODE** is selected in the display.

Display:

```
MENU MODE
 1:RECEIVE MODE
 2:LISTING MODE
▶ 3:ENTRY MODE
```

- 2** Press  and then  or  until **PASSCODE SETTING** is selected.

```
ENTRY MODE
 01:DESTINATION SETTING
▶ 02:PASSCODE SETTING
 03:OWN PASSCODE SET
```

- 3** Press . Make sure that "SET" is selected. (To clear a number, select "CLEAR".)

```
PASSCODE SETTING
▶ 1=SET
 2=CLEAR
```

- 4** Press .

- 5** **Storing:** Enter a 2-digit number (from 01 to 10). This number identifies the fax number you will enter in the next step.

Clearing: Enter the 2-digit number which identifies the fax number you want to clear, and go to Step 7.



- 6** Enter the fax number (max. 20 digits) by pressing the numeric keys.

- 7** Press .

- 8** Return to Step 3 to enter (or clear) another number, or press  repeatedly to return to the date and time display.



Programming and clearing a System number

One 4-digit System number can be programmed in your machine for giving and receiving polling permission. Polling will take place if your System number matches the other fax machine's System number or one of its ID numbers.



- 1** Press  and then  or  until **ENTRY MODE** is selected in the display.

Display:

```
MENU MODE
 1:RECEIVE MODE
 2:LISTING MODE
▶ 3:ENTRY MODE
```

- 2** Press  and then  or  until **SYSTEM # MODE** is selected.

```
05:DAY LIGHT SAVING
06:ID # MODE
▶ 07:SYSTEM # MODE
```

- 3** Press . Make sure that “SET” is selected.
(To clear the number, select “CLEAR”, press , and go to Step 6.)

```
SYSTEM # MODE
▶ 1=SET
 2=CLEAR
```

- 4** Press .



- 5** Enter the number (4 digits) with the numeric keys.

- 6** Press .

- 7** Press  repeatedly to return to the date and time display.



Storing and clearing ID numbers for polling permission

Up to five 4-digit ID numbers can be programmed in your machine for giving and receiving polling permission. Polling will take place if one of your ID numbers matches the other fax machine's System number.

- 1** Press **MENU** and then  or  until **ENTRY MODE** is selected in the display.

Display:

```
MENU MODE
 1:RECEIVE MODE
 2:LISTING MODE
▶ 3:ENTRY MODE
```

- 2** Press  and then  or  until **ID # MODE** is selected.

```
04:DATE&TIME SET
05:DAY LIGHT SAVING
▶ 06:ID # MODE
```

- 3** Press . Make sure that "SET" is selected. (To clear a number, select "CLEAR".)

```
ID # MODE
▶ 1=SET
 2=CLEAR
```

- 4** Press .

- 5** **Storing:** Enter a number from 1 to 5. This number identifies the ID number you will enter in the next step.

Clearing: Enter the number which identifies the ID number you want to clear, and go to Step 7.

- 6** Enter the ID number (4 digits) by pressing the numeric keys.

- 7** Press .

- 8** Return to Step 3 to enter (or clear) another number, or press  repeatedly to return to the date and time display.

Timer Operations

The Timer function allows you to store a fax job to be performed automatically at a specified time. Up to 59 timer jobs can be stored at any one time, and the time of each can be specified up to a week in advance.

You can use this function to take advantage of lower off-peak rates without having to be there when the operation is performed.

- ◆ The timer function cannot be used for e-mail transmissions.
- ◆ The **DOCUMENT** key cannot be used for a timer transmission.

Initial procedure

To store a timer job, first perform the following procedure. After you have completed this procedure, go to the procedure for the specific job you want to store (see the following pages).



- 1** Press  . (Flip up the Rapid Key overlay if it is down.)

Display:

TIMER MODE
▶ 1=SET
2=CLEAR

- 2** Make sure that “SET” is selected and then press .



TIMER SET
▶ 1:SEND MODE
2:BROADCAST MODE
3:CONFIDENTIAL TX MODE
4:POLLING MODE
5:SERIAL POLLING MODE

- 3** Press  or  to select the desired operation and then press .

Note: “CONFIDENTIAL TX MODE” stands for “confidential transmission mode”.

- 4** Enter a two-digit number for the hour (“01” to “12”) and a two-digit number for the minute (“00” to “59”).

5 Press  to select A.M. or  to select P.M.



6 Press  or  to select the day on which you want the operation to take place (if you want the operation to take place within the next 24 hours, select “WITHIN A DAY”.)

7 Press  and go to the specific procedure for your operation (see the following pages).

Transmission (SEND MODE)

(Continued from *Initial procedure*.)

8 Dial the receiving machine using one of the following methods:

- Press a Rapid Key.
- Press  and enter a Speed Dial number (if you enter less than 3 digits, press  to complete the entry).
- Enter a full fax number with the numeric keys.

9 Press  .

10 Press  and/or  to adjust the resolution and contrast if desired, and then press  .



11 Load the document and then press  .



- The document will be scanned into memory.

Broadcasting

(Continued from *Initial procedure.*)

8 Select the destinations using any of the following methods:

- Press a Rapid Key.
- Press  and enter a Speed Dial number. (If you enter less than 3 digits for the number, press  to complete the entry.)
- Enter a full fax number with the numeric keys and then press .
- Press a Group Key.

Note: If you need to delete a destination, press  or  to select the destination and then press .

9 Press .

10 Press and/or to adjust the resolution and contrast if desired, and then press .

11 Load the document and then press .

- The document will be scanned into memory.



Confidential transmission

(Continued from *Initial procedure.*)

8 Enter the mailbox number (2 digits). (Go directly to Step 9 if the receiving machine does not have mailboxes.)

9 Press .

10 Dial the receiving machine using one of the following methods:

- Press a Rapid Key.
- Press  and enter a Speed Dial number (if you enter less than 3 digits, press  to complete the entry).
- Enter a full fax number with the numeric keys.

11 Press .

12 Press  and/or  to adjust the resolution and contrast if desired, and then press .



13 Load the document and then press .

- The document will be scanned into memory.

Polling

(Continued from *Initial procedure.*)

8 Dial the machine to be polled using one of the following methods:



- Press a Rapid Key.
- Press  and enter a Speed Dial number (if you enter less than 3 digits, press  to complete the entry).
- Enter a full fax number with the numeric keys.



9 Press .

Serial Polling

(Continued from *Initial procedure.*)

8 Dial the machines to be polled using one or more of the following methods:

- Press one or more Rapid Keys.
- Enter one or more Speed Dial numbers, pressing  before each number. (If you enter less than 3 digits for a Speed Dial number, press  to complete the entry.)
- Enter one or more full fax numbers with the numeric keys, pressing  after each full number.
- Press one or more Group Keys.



Note: If you need to delete a destination, press  or  to select the destination and then press  .

9 Press  .

Canceling a timer operation

If you need to cancel a timer operation before it is performed, follow the steps below.

- ◆ You will need to know the number assigned to the operation in order to cancel it. If you don't remember the number (it appears in the display when you set the operation), print out the Timer List. (See page 200.)

1 Press  (flip up the Rapid Key overlay if it is down) and then  or  to select "CLEAR".

Display:

```
TIMER MODE
1=SET
▶ 2=CLEAR
```

2 Press  .

3 Enter the 2-digit number assigned to the operation.

4 Press  .

5 Press  repeatedly until you return to the date and time display.

Batch Transmission

Batch transmission allows you to store multiple fax jobs in memory for automatic transmission to one destination at a set time. If you often send faxes to a particular destination, this function helps reduce telephone costs by allowing you to conveniently send multiple faxes on one connection.

Note: If the telephone billing function is turned on, the batch transmission function cannot be used.

Programming a Batch Key

To perform a batch transmission, you must first program the number of the receiving machine and the time of transmission into a Batch Key. Any Rapid Key which has not already been programmed can be used as a Batch Key.

If you specify a day-of-the-week in your program, the transmission will be performed every week on that day. If you do not specify a day-of-the-week, the transmission will be performed every day.

To program a Batch Key, follow the procedure for entering programs explained in *Entering and Using Programs* on page 166. In Step 10 of the initial procedure, select "Batch transmission".

Clearing a Batch Key

To clear a Batch Key, follow the procedure on page 173.

Storing documents for transmission

Follow the steps below to store a document under a Batch Key for transmission. When you store the document, it is given a message number to distinguish it from other jobs stored in the same batch.

- ◆ If no jobs have been stored under a Batch Key when the time for transmission arrives, transmission will not take place.

1 Load the document (s).

- SEND READY will appear in the display.

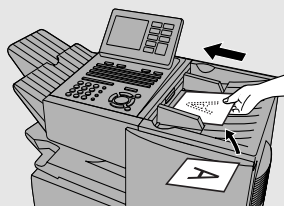

2 Press the appropriate Batch Key.

- After scanning, the message number assigned to your document will appear in the display.

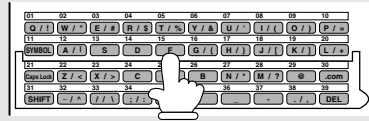

3 Press .

- The document will be transmitted at the designated time along with any other jobs stored under the same key. After transmission, all jobs in the batch will be cleared from memory.

Canceling a document stored for batch transmission

If necessary, you can cancel a document stored for a batch transmission before transmission takes place. To do so, you will need to know the message number assigned to the document.

- ◆ If you don't remember the message number, print out the Batch Transmission List (see page 200).

1 Press the Batch Key in which the document you want to clear has been stored.

- Make sure no documents are in the feeder.

2 Enter the 3-digit message number assigned to the document.

3 Press .



Entering and Using Programs

If you frequently perform the same operation involving the same party, you can program all the steps of the operation into one Program Key. This allows you to perform the operation by simply pressing that key.

- ◆ Any Rapid Key which is not already programmed as a Rapid Key or a Group Key can be used as a Program Key. You can include a timer setting in the program to have the operation performed automatically at a selected time.
- ◆ If the network scanner option is installed, an e-mail, FTP, or Desktop destination can be selected. (This is not possible if a timer setting is included.)
- ◆ To clear a mistake in the procedures that follow, press  .

Initial procedure

To program a Program Key, first perform the following procedure. After you have completed this procedure, go to the procedure for the specific operation you want to program (see the following pages).

- 1** Press **MENU** and then  or  until **PROGRAM/GROUP MODE** is selected in the display.

MENU MODE
 2:LISTING MODE
 3:ENTRY MODE
 4:OPTIONAL SETTING
 ▶ 5:PROGRAM/GROUP MODE

- 2** Press .

PROGRAM/GROUP MODE
 ▶ 1:PROGRAM ENTRY MODE
 2:GROUP ENTRY MODE

- 3** Make sure that **PROGRAM ENTRY MODE** is selected and press .

PROGRAM ENTRY MODE
 ▶ 1=SET
 2=CLEAR

- 4** Make sure that “SET” is selected and then press .

PROGRAM SET
 PRESS PROGRAM KEY

- 5** Select a Program Key by pressing any Rapid Key that has not yet been programmed.

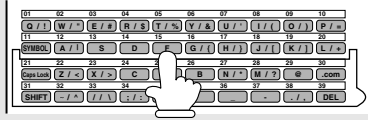



- 6** Enter a name for the program by pressing the letter entry keys (see Step 6 on page 26). (Maximum of 20 characters.)
If you don't want to enter a name, go directly to Step 7.



- 7** Press .

- 8** If you want to include a timer setting, enter a two-digit number for the hour ("01" to "12") and a two-digit number for the minute ("00" to "59"). (If not, go directly to Step 11.)

- 9** Press  to select A.M. or  to select P.M.

- 10** Press  or  to select the day on which you want the operation to take place (if you want the operation to take place within the next 24 hours, select "WITHIN A DAY".)

- 11** Press .

- 12** Press  or  to select one of the following operations and then press .

Transmission ("SEND MODE")

Broadcast ("I SEND MODE" if the network scanner option is installed and a timer setting is not included)

Confidential transmission

Polling

Serial Polling

Batch transmission (only possible if a timer setting was made)





Memory Polling (only possible if a timer setting was not made; not possible if the program is within a personal book)

13 Go to the specific procedure for your operation (see the following pages).

Transmission (SEND MODE)

(Continued from *Initial procedure*.)

14 Dial the receiving machine using one of the following methods:

- Press a Rapid Key.
- Press  and enter a Speed Dial number (if you enter less than 3 digits, press  to complete the entry).
- Enter a full fax number with the numeric keys.
- Press , enter an e-mail address, and then press . (Only if the network scanner option is installed.)

15 Press .

16 Press  and/or  to adjust the resolution and contrast if desired, and then press .

17 If you want the document to be sent through memory, press .

If you want the document to be sent directly from the feeder, press . (This is not possible if you included a timer setting or are sending the document to an e-mail, FTP, or Desktop destination.)

18 Press  repeatedly until you return to the date and time display.



Confidential transmission

(Continued from *Initial procedure.*)

14 Enter the mailbox number (2 digits). (Go directly to Step 15 if the receiving machine does not have mailboxes.)

15 Press  .

16 Dial the receiving machine using one of the following methods:

- Press a Rapid Key.
- Press  and enter a Speed Dial number (if you enter less than 3 digits, press  to complete the entry).
- Enter a full fax number with the numeric keys.

17 Press  .

18 Press  and/or  to adjust the resolution and contrast if desired, and then press  .

19 If you want the document to be sent through memory, press  .

If you want the document to be sent directly from the feeder, press



 . (This is not possible if you included a timer setting.)

20 Press  repeatedly until you return to the date and time display.

Polling

(Continued from *Initial procedure.*)

14 Dial the machine to be polled using one of the following methods:

- Press a Rapid Key.
- Press  and enter a Speed Dial number (if you enter less than 3 digits, press  to complete the entry).
- Enter a full fax number with the numeric keys.



15 Press .



16 Press repeatedly until you return to the date and time display.

Serial Polling

(Continued from *Initial procedure.*)

14 Dial the machines to be polled using one or more of the following methods:

- Press one or more Rapid Keys.
- Enter one or more Speed Dial numbers, pressing  before each number. (If you enter less than 3 digits for a Speed Dial number, press  to complete the entry.)
- Enter one or more full fax numbers with the numeric keys, pressing  after each full number.
- Press one or more Group Keys.

Note: If you need to delete a destination, press  or  to select the destination and then press .





15 Press .



16 Press  repeatedly until you return to the date and time display.

Broadcasting

(Continued from *Initial procedure*.)

14 Select the destinations using any of the following methods:

- Press a Rapid Key.
- Press  and enter a Speed Dial number. (If you enter less than 3 digits for the number, press  to complete the entry.)
- Enter a full fax number with the numeric keys and then press .
- Press a Group Key.
- Press , enter an e-mail address, and then press . (Only if the network scanner option is installed.)

Note: If you need to delete a number, press  or  until the destination appears in the display and then press .

15 Press .

16 Press  and/or  to adjust the resolution and contrast if desired, and then press .



17 Press .

18 Press  repeatedly until you return to the date and time display.

Batch transmission

(Continued from *Initial procedure.*)

14 Dial the receiving machine using one of the following methods:

- Press a Rapid Key.
 - Press  and enter a Speed Dial number (if you enter less than 3 digits, press  to complete the entry).
 - Enter a full fax number with the numeric keys.
-

15 Press .

16 Press  and/or  to adjust the resolution and contrast if desired, and then press .

17 Press .

18 Press  repeatedly to return to the date and time display.

Being Polled (Memory polling)

(Continued from *Initial procedure.*)

14 Press **1** to allow polling only once, or **2** to allow polling an unlimited number of times.

15 Press .



16 Press  and/or  to adjust the resolution and contrast if desired, and then press .

17 Press .

18 Press  repeatedly until you return to the date and time display.

Clearing a Program Key

To clear a Program Key, follow these steps:



1 Press  and then  or  until **PROGRAM/GROUP MODE** is selected in the display.

Display:

```
MENU MODE
 2:LISTING MODE
 3:ENTRY MODE
 4:OPTIONAL SETTING
 ▶ 5:PROGRAM/GROUP MODE
```

2 Press . Make sure that **PROGRAM ENTRY MODE** is selected.

```
PROGRAM/GROUP MODE
 ▶ 1:PROGRAM ENTRY MODE
 2:GROUP ENTRY MODE
```

3 Press  and then  or  to select CLEAR.

PROGRAM ENTRY MODE

- 1=SET
- ▶ 2=CLEAR

4 Press .

PROGRAM CLEAR
PRESS PROGRAM KEY

5 Press the Program Key that you want to clear.

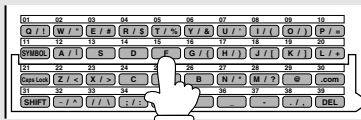

6 Press .

7 Press  repeatedly until you return to the date and time display.

Using a Program Key

Follow the steps below to perform a programmed operation.

- 1 If this is a transmission operation or memory polling operation, load the document.

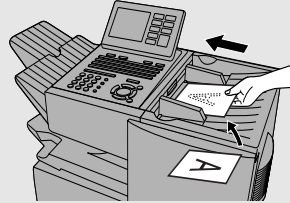

- 2 Press the appropriate Program Key.

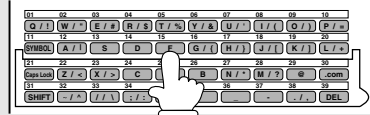

Canceling a programmed timer operation

If a Program Key has been pressed for a timer operation and you need to cancel the operation before it is performed, follow the steps below.

Note: This procedure will not work for a document stored for a batch transmission. To cancel a batch transmission operation, see *Canceling a document stored for batch transmission* on page 165.

- 1 Press the Program Key.

- 2 Press  .

Duplex Scanning for Two-sided Documents

To transmit or copy documents which have printing or graphics on both sides of the page or pages, use Duplex Scanning. With this function, you simply feed the document (all pages) through the machine once, turn the stack of pages over, and feed it through again.

- ◆ The machine will automatically sort the pages into the correct order (front of 1st page, back of 1st page, front of 2nd page, back of 2nd page, etc.).
- ◆ Duplex Scanning can be used for copying (single copies and sorted multiple copies only) and any type of transmission from memory.
- ◆ Note that any blank sides must be included when scanning the pages (if the number of pages is not equal each time the machine scans the stack, an error will result). The blank sides will not, however, be printed out.

1 Load the document (s).

- Make sure the page(s) are front face down, with the first page on the bottom.
- SEND READY will appear in the display.

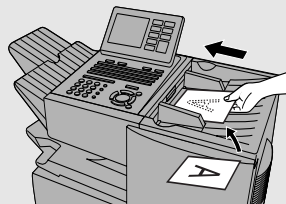

2 Press **DUPLEX SCAN** and then **START/ENTER** .

3 Perform all steps of the desired copy or memory transmission.

4 When all pages of the document have been scanned, turn the stack over (do not change the page order) and load it again.

5 Press **START/ENTER** .

Print Hold

The Print Hold function is used to hold all received faxes in memory instead of immediately printing them out. To print the faxes, the programmed Print Hold code must be entered.

To use the Print Hold function, program a Print Hold code and then turn on the Print Hold function as explained in the following sections.

Programming the Print Hold code

Follow the steps below to program a Print Hold code.

1 Press **MENU** and then .

- Make sure that PRINT HOLD is selected in the display.

Display:

```
MENU MODE
 6:SERIAL POLLING MODE
 7:MEMORY POLL MODE
 8:NETWORK SETTING
▶ 9: PRINT HOLD
```

2 Press  and then  or  until **PRINT HOLD CODE SET** is selected.

```
PRINT HOLD
 1:PRINT HOLD DATA PRINT
▶ 2:PRINT HOLD CODE SET
 3:PRINT HOLD CODE CLEAR
```

3 Press .

4 Press the numeric keys to enter the desired **Print Hold code (4 digits)**.

5 Press .

- The machine will print out the Print Hold code for your records.
- In the event that you forget the code and have kept no record, contact your Sharp dealer.

Turning on the Print Hold function

To turn on the Print Hold function, set Option Setting 38 to YES (see pages 189 and 199).

Note: A Print Hold code must be programmed before Option Setting 38 can be set to YES.

Printing received faxes

When a fax has been received to memory because the Print Hold function is turned on, RCVD PRINT HOLD FAX will appear in the display. Follow the steps below to print the fax (or faxes).

1 Press **MENU** and then .

- Make sure that PRINT HOLD is selected in the display.

Display:

```
MENU MODE
 6:SERIAL POLLING MODE
 7:MEMORY POLL MODE
 8:NETWORK SETTING
▶ 9: PRINT HOLD
```

2 Press .

- Make sure that PRINT HOLD DATA PRINT is selected in the display.

```
PRINT HOLD
▶ 1:PRINT HOLD DATA PRINT
 2:PRINT HOLD CODE SET
 3:PRINT HOLD CODE CLEAR
```

3 Press .

4 Press the numeric keys to enter the Print Hold code.

5 Press .

- The received fax will print out.

Clearing the Print Hold code

Follow the steps below if you need to clear the Print Hold code.

Note: To clear the Print Hold code, Option Setting 38 must first be set to NO.

1 Press **MENU** and then .

- Make sure that PRINT HOLD is selected in the display.

Display:

```
MENU MODE
 6:SERIAL POLLING MODE
 7:MEMORY POLL MODE
 8:NETWORK SETTING
▶ 9: PRINT HOLD
```

2 Press  and then .

- Make sure that PRINT HOLD CODE CLEAR is selected in the display.

```
PRINT HOLD
 1:PRINT HOLD DATA PRINT
 2:PRINT HOLD CODE SET
▶ 3:PRINT HOLD CODE CLEAR
```

3 Press .

4 Press the numeric keys to enter the Print Hold code.

5 Press .

Department Control



Department Control is used to restrict use of the machine to authorized users. When it is activated, a department code must be entered before an operation can be performed.

- ◆ Department Control can only be activated by your Sharp dealer. If you wish to use this function, contact your dealer.
- ◆ Department Control allows you to track the number of pages transmitted as well as the transmission time for each authorized department or person. See *Department Usage List* on page 203.

Programming Department Codes



Up to 99 different Department Codes can be programmed to allow access to the machine. Transmitted pages and transmission time will be kept track of separately for each code. After you enter a code, inform the appropriate group or individual.

- ◆ A name must be assigned to each code. Only the name, not the code, will appear on the Department Usage List.
- ◆ Be sure to keep a record of each code and name. If you misplace the record, contact your dealer.

- 1** Press  and then  or  until **ENTRY MODE** is selected in the display.

Display:

```
MENU MODE
 1:RECEIVE MODE
 2:LISTING MODE
▶ 3:ENTRY MODE
```

- 2** Press  and then  or  until **DEPT. PASSCODE** is selected.

```
ENTRY MODE
 06:ID # MODE
 07:SYSTEM # MODE
 08:STORE JUNK FAX #
▶ 09:DEPT. PASSCODE
 10:BOOK ENTRY MODE
```

3 Press .

DEPARTMENT CODE MODE

- ▶ 1=SET
- 2=CLEAR

4 Make sure that “SET” is selected and then press .

(To clear a Department Code, select CLEAR and then press .

5 **Programming:** Enter a 2-digit number from “01” to “99” with the numeric keys. This number identifies the Department Code that you will enter in the next step.

Clearing: Enter the 2-digit number that identifies the Department Code you want to clear.

Note: It is not possible to clear the Department Code that you are currently using to access the machine. It is also not possible clear a Department Code if only one code is programmed.

6 **Programming:** Enter a Department Code (4 digits or the number of digits set by Option Setting 27 as explained on page 196).

Clearing: Enter the Department Code that you wish to clear, and go to Step 9.

7 Press .

8 Press the letter entry keys to enter a name for the Department Code.

9 Press .

10 Return to Step 5 to program (or clear) another Department Code, or press  repeatedly to return to the date and time display.

Accessing the machine

When Department Control is activated, you must enter your Department Code before using the machine.

- ◆ If you do not begin the operation within one minute after entering the code, the machine will return to controlled access mode.



Note: You do not need to enter a Department Code to receive faxes manually (by picking up an extension phone connected to the same line and pressing  on the machine).

Blocking Reception of Unwanted Faxes

The Anti Junk Fax function allows you to block reception of faxes from parties that you specify. This saves paper by not printing out unwanted "junk" faxes.



To use this function, first turn it on by setting Option Setting 20 (Anti-Junk Fax) to ON as explained on page 195, and then enter the fax numbers from which you do not want to receive faxes as explained below.

- ◆ Up to 50 numbers can be entered in the Anti Junk Number List.
- ◆ To clear a number from the Anti Junk Number List, you need to know the 2-digit number that identifies it. If you have forgotten this number, print out the Anti Junk Number List as explained on page 200.

- 1** Press **MENU** and then  or  until **ENTRY MODE** is selected in the display.

Display:

```
MENU MODE
 1:RECEIVE MODE
 2:LISTING MODE
▶ 3:ENTRY MODE
```

- 2** Press  and then  or  until **STORE JUNK FAX #** is selected.

```
ENTRY MODE
06:ID # MODE
07:SYSTEM # MODE
▶ 08:STORE JUNK FAX #
09:DEPT. PASSCODE
10:BOOK ENTRY MODE
```

- 3** Press .

```
JUNK FAX # MODE
▶ 1=SET
 2=CLEAR
```

- 4** Make sure that "SET" is selected and then press .

(To clear a number from the list, select CLEAR and then press .

5 **Entering:** Enter a 2-digit number from “01” to “50” with the numeric keys. This number identifies the fax number that you will enter in the next step.

Clearing: Enter the 2-digit number that identifies the fax number you want to clear, and go to Step 7.

6 Enter the fax number.

7 Press .

8 Return to Step 5 to enter (or clear) another fax number, or press  repeatedly to return to the date and time display.

Telephone Billing

If you are on a PBX, you can have the machine send a code to the PBX that identifies the sender for billing purposes each time a fax is sent. Telephone billing is possible in two ways: using Department Control and by direct billing code entry.

Using Department Control

If you are using the Department Control function, you can use Department Codes for telephone billing. In this case, the machine will automatically send the Department Code that a department member enters to access the machine to the PBX. The PBX can then use the Department Code to bill the call to that department.

To use Department Control for telephone billing, program a Department Code for each group that will use the machine (see *Department Control* on page 180), and then have your dealer activate Department Control. After this, set Option Setting 26 (Telephone Billing Code) to ON as explained on page 196.

Direct billing code entry

If you don't want to use Department Control for telephone billing, you can have users enter an assigned billing code (any number up 9 digits long) each time they use the machine. The machine will automatically send this code to the PBX for billing purposes. To use this function, have your dealer activate the function and then set Option Setting 26 (Telephone Billing Code) to ON as explained on page 196.

Note: The billing code should be assigned by your PBX administrator. Billing codes are not programmed into the machine.



Users should enter their billing code as follows when performing an operation on the machine. The code need only be entered when calling outside of the PBX.

1 Load the document (s).

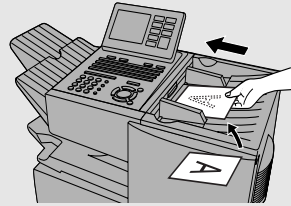
- If you are using Normal Dialing, press **SPEAKER**  or pick up an extension phone connected to the same line.
- SEND READY will appear in the display.



2 Enter your number to access an outside line (max. of 3 digits).

3 Flip down the Rapid Key overlay and press , enter the billing code (max. of 9 digits), and then press  again.

- Note: The code will appear as asterisks in the display and will not appear in the Activity List or Transaction Report.

4 Press  and/or  to adjust the resolution and contrast if desired.

5 Dial the other party by the desired method and transmit the document.

Distinctive Ring

Important:



- ◆ To use distinctive ring, you must subscribe to a distinctive ring service from your local phone company.
- ◆ Your machine may not be compatible with some distinctive ring services.

Note for dual line option: Distinctive ring can only be used on Line 1.

Distinctive ring is a service offered by some local telephone companies whereby they assign an additional second number to your regular single line. The second number rings differently from your normal number.

If you subscribe to a distinctive ring service, you can set the machine to automatically answer when your second number is called. This allows you to use the second number as an exclusive fax number.

To have your fax automatically answer when your second number is called, follow the steps below:



- 1** Press **MENU** and then  or  until **OPTIONAL SETTING** is selected in the display.

Display:

```
MENU MODE
 1:RECEIVE MODE
 2:LISTING MODE
 3:ENTRY MODE
▶ 4: OPTIONAL SETTING
```

- 2** Press , **2** and **8**.

```
DISTINCTIVE RING
 1= RING PATTERN 1
 2= RING PATTERN 2
 3= RING PATTERN 3
 4= STANDARD RING
▶ 5= OFF SETTING
```

- 3** Press  or  to select the desired setting.
(See the bottom of the following page for the settings in Canada.)

Distinctive Ring

RING PATTERN 1	Two short rings
RING PATTERN 2	One short, one long, and one short ring
RING PATTERN 3	Two short rings and one long ring
STANDARD RING	Your standard (normal) ring pattern
OFF SETTING	Turn distinctive ring off

4 Press .

5 Press  repeatedly to return to the date and time display.

Selections in Canada



In Step 3 of the above procedure, the selections available in Canada are as follows:

RING PATTERN 1	Two short rings
RING PATTERN 2	One short, one long, and one short ring
RING PATTERN 3	Two short rings and one long ring
RING PATTERN 4	Three very short rings
RING PATTERN 5	Two very short rings
STANDARD RING	Your standard (normal) ring pattern
OFF SETTING	Turn distinctive ring off

7. Optional Settings

The optional settings allow you to customize the machine to better suit your needs.

An initial setting has been made for each optional setting at the factory. To change a setting, follow the steps below to display the optional setting, and then select a new setting as explained in the pages that follow.

- 1** Press **MENU** and then  or  until **OPTIONAL SETTING** is selected in the display.



Display:

MENU MODE
1:RECEIVE MODE
2:LISTING MODE
3:ENTRY MODE
▶ 4: OPTIONAL SETTING



- 2** Press .

OPTIONAL SETTING MODE
▶ 01:DEFAULT FAX RESOLUTION
02:# OF RINGS AUTO RX
03:# OF RINGS MANUAL RX
04: AUTO LISTING

- 3** Press the numeric keys to enter the 2-digit number ("01" to "38") of the optional setting that you wish to change. (Note: You can also press the Rapid Key that has the same number as the optional setting.)

Example: Optional Setting 01  

OR



Press  or  to scroll through the optional settings. When the desired optional setting appears, press .

- 4** Enter a selection for the optional setting as explained in the following pages.

- 5** After entering a selection, the subsequent option setting will appear in the display. To return to the date and time display, press  twice.

Optional Settings



Setting 01: DEFAULT FAX RESOLUTION

This option sets the default resolution (the resolution used if a setting is not selected with ) for transmitting documents. Press  or  to select STANDARD, FINE, SUPER FINE, or ULTRA FINE, and then press





- ◆ Initial setting: STANDARD

Setting 02: NUMBER OF RINGS AUTO RECEPTION

This sets the number of rings the machine waits before answering an incoming call in AUTO receive mode. Enter a number from  to  (if  is entered, the machine will answer without ringing).



- ◆ Initial setting: 1

Setting 03: NUMBER OF RINGS MANUAL RECEPTION

You can also have the machine automatically answer a call after a certain number of rings in MANUAL reception mode. To turn on this function, enter the desired number of rings (any number from  to ). To turn off the function, enter .

- ◆ Initial setting: 0 (off)

Setting 04: AUTO LISTING

Select YES to have the machine automatically print an Activity Report once every 30 send/receive operations. (The report can still be printed on demand at any time.) Select NO to turn the function off. Press  or  to make the selection and then press .

- ◆ Initial setting: NO

Setting 05: TRANSACTION REPORT PRINT SELECTION

This sets the condition for printing out a Transaction Report. Press  or







to select one of the following conditions, and then press .

ERROR/TIMER/ MEMORY:	A report will be printed after an error, timer operation, or memory operation
SEND ONLY	A report will be printed only after a transmission
ALWAYS PRINTS	A report will be printed after each transmission, reception, or error
NEVER PRINTS	A report will never be printed.
ERROR ONLY	A report will be printed only after an error occurs





◆ Initial setting: ERROR ONLY

Setting 06: RECALL TIMES

This sets the maximum number of times your fax will automatically redial if the line is busy. Enter any number from   to  .



◆ Initial setting: 02

Setting 07: RECALL INTERVAL

This sets the amount of time your fax will wait between automatic redials when the line is busy. Enter   for 1 minute,   for 2 minutes, etc., up to a maximum of 15 minutes.

◆ Initial setting: 05

Setting 08: SECURITY SELECTION



Select ON to turn polling security on, or OFF to turn it off. Press  or 

to make the selection and then press .

◆ Initial setting: ON

Setting 09: ERROR CORRECTION MODE (ECM)

Select YES to have any distortions in a transmission due to noise on the telephone line corrected before print-out at the receiving end. This is only effective when the other machine has ECM as well. Select NO to turn the



function off. Press  or  to make the selection and then press .

Note: If the transmission or reception is taking place in Super G3 mode, ECM will operate regardless of the ECM setting.

◆ Initial setting: YES



Setting 10: AUTO COVER SHEET

Select YES to have the fax automatically generate a cover sheet and send it as the last page of each transmission. Select NO to turn the function off.

Press  or  to make the selection and then press .



◆ Initial setting: NO

Setting 11: FAX SCANNING WIDTH

This setting selects the maximum scanning width. Press  or  to select 10 inches or 8.3 inches, and then press .

◆ Initial setting: 10 inches

Setting 12: COPY SCANNING



This setting is used to reduce copies slightly before printing to ensure that data on the edges are not cut off. Press  or  to select AUTO for

automatic reduction, or 100% for no reduction, and then press .

◆ Initial setting: 100%



Setting 13: COPY CUT-OFF

This setting determines how the machine will copy documents that are longer than the printing paper. Select CONTINUE to have the remainder of the document printed on a second page, or CUT-OFF to cut off (not print) the

remainder. Press  or  to make the selection, and then press .



◆ Initial setting: CUT-OFF

Setting 14: RECEIVE REDUCE

This setting is used to reduce received documents slightly before printing to ensure that data on the edges are not cut off. Select AUTO for automatic reduction or 100% for no reduction. Press  or  to make the selection and then press .

◆ Initial setting: AUTO



Setting 15: IMAGE MEMORY PRINT

Select YES to include a copy of the first page of the transmitted document on the Transaction Report. Select NO to turn the function off. This setting is only effective when transmitting from memory. Press  or  to make the selection and then press .

◆ Initial setting: YES

Setting 16: CASSETTE SELECTION

Note: This setting will only appear if the machine has two paper cassettes, or if the machine has one paper cassette and Option Setting 31 (Separate Mode) is turned off.

Press  or  to select one of the following settings and then press



AUTO SELECTION:The machine automatically selects the printing paper source (tray or cassette) according to the size of each page received or copied. (If a document consists of multiple pages of different sizes, each page will be printed on the paper that best matches its size.)

AUTO SELECTION 2: The machine automatically selects the printing paper source (tray or cassette) according to the size of the first page of the document received or copied. (If the document consists of multiple pages of different sizes, all pages will be printed on the same size of paper based on the size of the first page.)

MANUAL SELECTION: Use this to set a fixed order of priority for the paper sources. After selecting this setting, the 1ST PRIORITY setting will appear. Select the source from which you want paper to be always drawn (regardless of the size of the received document), and then press . The 2ND

PRIORITY setting will now appear. Use this setting to select the source from which you want paper to be drawn in the event that the "1ST PRIORITY" source runs out of paper. If you wish to have the incoming fax received to memory in this case, select "NONE". When you have completed the selection,







press .

FO-DC600: If the machine has two paper cassettes and Option Setting 31 (Separate Mode) is turned off, and if you did not select "NONE" for the "2ND PRIORITY" setting, the "3RD PRIORITY" setting will appear. Use this to select the source from which you want paper to be drawn in the event that both the "1ST PRIORITY" and the "2ND PRIORITY" sources run out of paper, or select "NONE" to have the fax received to memory. When you have

completed the selection, press .







◆ Initial setting: AUTO SELECTION

Setting 17: RETRANSMISSION TIMES

This sets the number of times the fax will reattempt a memory transmission which has been interrupted by a line error or power failure. Enter any 2-digit number from   to  , or enter   to turn off the function.



◆ Initial setting: 10

Setting 18: RETRANSMISSION INTERVAL

You can select the number of minutes the fax waits between each memory retransmission attempt. Enter   for 1 minute,   for 2 minutes, etc., up to a maximum of 15 minutes. If you do not want the fax to wait between attempts, enter  .



◆ Initial setting: 02

Setting 19: POWER SAVE MODE

To conserve power, you can have the laser printer heater in the machine turn off when not in use. When this is done, the heater will turn on automatically when you receive a document (there will be a slight delay before printing while the heater warms up) and turn off when printing is completed. Select ON to turn on the function or OFF to turn off the function. Press  or  to make the selection and then press .



◆ Initial setting: ON

Setting 20: ANTI-JUNK FAX

Select ON to block reception from fax numbers entered in the Anti Junk Fax List. Select OFF to allow reception from all numbers. Press  or  to make the selection and then press .



◆ Initial setting: OFF

Setting 21: ALARM VOLUME

This sets the volume of the beep sound that alerts you to error conditions and informs you that operations have been completed. Press  or  to select a volume level (HIGH, LOW or OFF) and then press .



◆ Initial setting: LOW

Setting 22: DIAL MODE

This sets the dial mode. Select TONE if you are on a touch-tone line, or PULSE if you are on a pulse dial (rotary) line. Press  or  to make the selection and then press .

◆ Initial setting: TONE



Setting 23: QUICK ON-LINE

When you transmit a multi-page document, this setting determines whether the machine will dial the receiving party and begin transmitting while scanning is still in progress, or wait until all pages have been scanned before dialing. Select ON to have the machine dial and begin transmission while scanning is still in progress, or OFF to have the machine wait until all pages have been scanned. Press  or  to make the selection and then press .

◆ Initial setting: ON



Setting 24: MULTI TTI

If you are using Department Control, you can select ON to have the department name (the name associated with the department code entered by an operator to access the fax) appear at the top of each transmitted document. This will appear in place of the name entered in *Entering Your Name and Fax Number* in Chapter 1. Select OFF to turn Multi TTI off (the

sender's name entered in Chapter 1 will appear). Press  or  to make the selection and then press .



◆ Initial setting: OFF

Setting 25: BEEP LENGTH

This sets the duration of the beep that signals the end of transmission, reception, and copying. Press  or  to select a duration (3 SECONDS, 1 SECOND, or NO BEEP) and then press .

◆ Initial setting: 3 SECONDS

Setting 26: TELEPHONE BILLING CODE



This setting allows you to use Department Codes or direct billing codes for telephone billing on a PBX. (Your dealer must first activate Department Control or direct billing code entry.) Select ON to turn telephone billing on, or OFF to turn it off. Press  or  to make the selection and then press





◆ Initial setting: OFF

If you selected ON, the BILLING CODE DIAL selection will subsequently appear. Select BEFORE if your PBX must receive the billing code before dialing a telephone number, or AFTER if it must receive the billing code after dialling a telephone number, and then press . (Refer to your PBX manual or consult your PBX administrator for this information.)

Note: If you select AFTER for the BILLING CODE DIAL selection, you must press



 after dialing if you use .

Setting 27: DEPARTMENT CODE DIGITS

Use this setting if you are using Telephone Billing and need to change the number of digits of Department Codes to accord with your PBX's telephone billing system. Enter any number from  to .

◆ Initial setting: 4



Setting 28: DISTINCTIVE RING

This sets the ring pattern to which your fax will answer if you subscribe to a distinctive ring service. Press  or  to select a ring pattern and then press . See page 187 for more details.

◆ Initial setting: OFF

Setting 29: VERIFICATION STAMP



Select ON if you want the machine to stamp each original document page as it is scanned. After scanning, you can check to see if all pages have been stamped to verify that no double feeds occurred. Select OFF to turn the

function off. Press  or  to make the selection and then press .

Note: To use this function, your dealer must install the Verification Stamp option.

◆ Initial setting: OFF

Setting 30: DEFAULT COPY RESOLUTION



Use this setting to select the default copying resolution (the resolution used for copying if a setting is not made with ). Press  or  to select

STANDARD, FINE, SUPER FINE, or ULTRA FINE, and then press .

◆ Initial setting: FINE

Setting 31: SEPARATE MODE

If desired, you can have the machine draw a sheet of paper from one of the paper sources after each fax reception (and after each print job if the network printer option is installed). By loading colored (or large) paper in that source, each colored sheet drawn will act as a separator that makes it easy to distinguish where one multi-page document ends and another begins. A Transaction Report printed after a fax reception will also be printed from that

paper source to act as a separator sheet. To turn on this function, press  or  to select YES, select the paper source for the separator paper, and

then press . After turning on the function, be sure to load appropriate

paper in the selected paper source. To turn off Separate mode, press  or



 to select NO and then press . (Note that the function will turn off automatically if the selected paper source runs out of paper.)

Note for FO-DC500: This setting is only available if your dealer has installed the paper cassette option.

◆ Initial setting: NO

Note: If you turn off the Separate Mode setting, Option Setting 16 will subsequently appear in the display to allow you make an appropriate setting for cassette selection. If you don't make a selection, AUTO SELECTION will be automatically selected.

Setting 32: BACKLIGHT SETTING



Use this setting to set the amount of time until the display backlight turns off after the operation panel is used (after a key is pressed). Press  or  to select the amount of time (3 MINUTES, 10 MINUTES, or 15 MINUTES), or select ALWAYS OFF if you never want the backlight to be on. When finished, press .

◆ Initial setting: 3 MINUTES

Note: Settings 33 through 36 are not used.

Setting 37: FAX TRANSFER



This setting only appears if the network scanner option is installed. Select ALWAYS PRINT if you wish to have the machine print all faxes that are forwarded by the Inbound Routing function. Select PRINT ERROR ONLY to have the machine only print faxes that are not successfully forwarded. Press





 or  to make the selection and then press .

◆ Initial setting: ALWAYS PRINT

Setting 38: PRINT HOLD

Use this setting to turn on or turn off the Print Hold function (see page 177).

To turn on the Print Hold function, press  or  to select YES and then press . (Note: A Print Hold code must be programmed before YES can be selected.)



To turn off the Print Hold function, press  or  to select NO, press , enter the 4-digit Print Hold code, and press . (Note: NO cannot be selected if a received fax is being held in memory by the Print Hold function. First print the fax and then turn off Print Hold.)

◆ Initial setting: NO

8. Printing Lists and Reports

You can print lists showing settings and information entered in the machine. You can also print out reports on recent activity and individual operations after they are completed. The lists and reports are described on the following pages.

To print a list, follow the steps below.

- 1** Press **MENU** and then  or  until **LISTING MODE** is selected in the display.

Display:

```
MENU MODE
 1:RECEIVE MODE
▶ 2:LISTING MODE
 3:ENTRY MODE
```

- 2** Press 

- 3** Press the numeric keys to enter the 2-digit number (“01” to “12”) of the list that you want to print. (Note: You can also press the Rapid Key that has the same number as the list.)

Example: Activity Report  

OR

Press  or  to scroll through the lists. When the desired list is selected, press .

Activity Report (List 01)

This report shows information on your most recently performed send and receive operations (a combined maximum of 30 operations can appear). The report is divided into two parts: the SEND REPORT, which shows information on transmissions (including Scan to E-mail transmissions if the network scanner option is installed), and the RECEIVE REPORT, which shows information on receptions.

- ◆ If Option Setting 4 (Auto Listing) is set to YES, a report will be automatically printed out whenever information on 30 operations has accumulated. (A report can still be printed on demand at any time.)

```

*****
X                                     P.01 X
X                                     X
X          SEND REPORT                 X
X                                     MAY-25-2004 TUE 05:16 PM X
X                                     X
X      FOR: John Doe Corp.             201 555 1234 X
X-----X-----X-----X-----X-----X-----X-----X-----X-----X
X # DATE START RECEIVER TX TIME PAGES TYPE NOTE M# DP X
X-----X-----X-----X-----X-----X-----X-----X-----X-----X
X 01 MAY-21 08:23 PM AL          **' **' 0 FAX TX P.FAIL 001 X
X-----X-----X-----X-----X-----X-----X-----X-----X-----X
X                                     TOTAL: 0' 0 X
X                                     GRAND TOTAL TIME: OS PAGES: 0 X
X-----X-----X-----X-----X-----X-----X-----X-----X-----X
*****

```

- ◆ All information is erased after a report is printed out. If automatic print-out is turned off and the report is not printed manually for 30 operations, the information on the oldest operation will be overwritten each time a new operation is performed.

Explanation of headings

SENDER/RECEIVER The name or fax number of the other machine involved in the transaction.

START The time at which transmission/reception started.

TX/RX TIME Total time taken for transmission/reception.

PAGES Number of pages transmitted/received.

TYPE **CONF. TX** - A confidential operation was performed.
(T) - A timer operation was performed.
(D) - The document was sent directly from the feeder, not from memory.

NOTE One of the following notes will appear under **NOTE** in the report to indicate whether the transaction was successful, and if not, the reason for the failure. (Note: With the exception of the error codes CE-00 to CE-05 explained on the following page, the success or failure of a Scan to E-mail transmission is not indicated. If your e-mail server is unable to deliver a Scan to E-mail transmission to an e-mail address, notification will be sent to your specified sender's e-mail address.)

OK - Transmission/reception was successful.

P.FAIL - A power failure prevented the transaction.

JAM - The printing paper or document jammed, preventing the transaction.

BUSY - The fax was not sent because the line was busy.

COM.E-0 to COM.E-31 - A telephone line error prevented the transaction. See *Line Error in Problems and Solutions* in Chapter 9.

CE-01 to CE-05 - An error occurred when the machine attempted to establish a connection with your e-mail server (see page 216 for explanations of the errors).

CANCEL - The transaction was cancelled because the **STOP** key was pressed, no document was in the feeder, or the other machine requested transmission using a function which your machine does not have.

CANCEL 3 - (Used for confidential transmission only)
A confidential transmission was cancelled because the receiving machine does not have a confidential function, a confidential passcode is not programmed in the receiving machine, its memory is full, or it is not a Sharp model.

CANCEL 4 - (Used for confidential transmission only)
A confidential transmission was cancelled because an incorrect mailbox number was entered for a machine with confidential mailboxes, or the other machine's memory is full.

Timer List (List 02)

This list shows the timer operations that are currently set.

Destination List (List 03)

This list shows the fax numbers that have been programmed for automatic dialing.

Passcode List (List 04)

This list shows your settings for polling security, your name and fax number as programmed in the machine, and a sample of the header printed at the top of every page you fax (HEADER PRINT).

Optional Setting List (List 05)

This list shows the current status of the option settings.

Program and Group List (List 06)

The top part of this list shows the programs that have been entered. The bottom part shows the fax numbers that have been programmed into Group Keys.

Batch Transmission List (List 07)

The Batch Transmission List shows the documents that are currently stored for batch transmission.

Department Usage List (List 08)

This list shows total transmission time and pages transmitted (including polling time and pages polled) for each department during the period indicated on the list. The information is only available if Department Control has been activated.

- ◆ Each time you print out the report, the data is cleared and a new period begins.

Confidential Reception List (List 09)

This list shows which mailboxes have received confidential documents and the total number of pages received. Print this list out whenever RCVD CONF. FAX appears in the display.

Anti Junk Number List (List 10)

This list shows the fax numbers from which reception is not allowed.

Personal Book List (List 11)

This list shows the personal books that have been created.

Fax Transfer List (List 12)

This list shows the sets of sender's numbers and forwarding e-mail addresses that have been stored for the Inbound Routing function. (This list is only available when the network scanner option is installed.)

Transaction Report

This report is printed out automatically after a fax operation is completed to allow you to check the result. The machine is set at the factory to print out the report only when an error occurs. If desired, you can change the setting to have it printed out under a variety of other conditions. The report can also be printed out after a Scan to E-mail/FTP/Desktop transmission. See Option Setting 5 (Print Selection) in Chapter 7.

- ◆ If you wish to have the Transaction Report printed after a particular fax transmission (or a Scan to E-mail/FTP/Desktop transmission) , press



(flip up the Rapid Key overlay if it is down) before performing the steps of the transmission. (To cancel printing of the Transaction Report,

press  .)

- ◆ The same headings appear in the Transaction Report as in the Activity Report. See *Activity Report* in this chapter for an explanation of the headings.
- ◆ The first page of the document will also appear below the report if the document was sent from memory (this does not occur when the transmission is a Scan to E-mail/FTP/Desktop transmission). If confidentiality is required, you can prevent printing of the first page of the document by setting Option Setting 15 (Image Memory Print) to NO.

9. Maintenance

Cleaning the Scanning Glass and Rollers

Clean the reading glass and rollers frequently to ensure the quality of your transmitted images and copies.

1 Open the operation panel.

- Squeeze the release marked **PANEL RELEASE** and pull up.



2 Wipe the scanning glass, white backplate, and rollers with a soft cloth.

- Make sure that all dirt and stains (such as correcting fluid) are removed, as dirt will cause vertical lines on transmitted images and copies. (If necessary, wipe with denatured alcohol.)

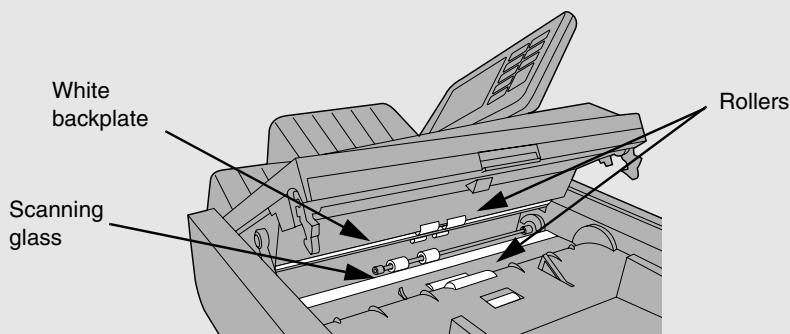

The Housing

Wipe the external parts and surface of the machine with a dry cloth.

Caution!

Do not use benzene or thinner. These solvents may damage or discolor the machine.

Replacing the Verification Stamp

If you are using the Verification Stamp function, you will need to replace the ink cartridge in the stamp unit when it runs out of ink (when the stamped mark on original documents becomes faint). A new ink cartridge can be obtained from your dealer.

- 1** Remove the ADF exit tray.

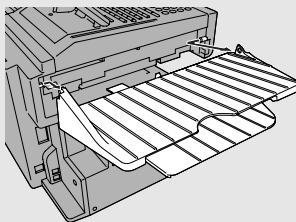

- 2** Press down on the protruding tab of the green ink cartridge and pull the cartridge out with your fingers.

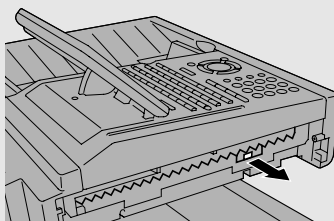

- 3** Insert the new ink cartridge into the machine (make sure that the tab is facing out).

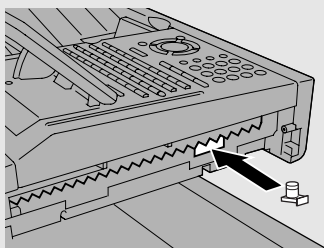

- 4** Replace the ADF exit tray.

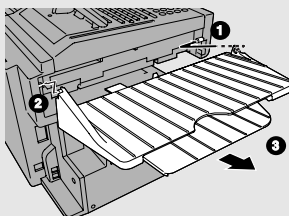

10. Troubleshooting

Problems and Solutions

Line error

Problem	Solution
LINE ERROR appears in the display, and/or a transaction report is printed out with COM. E- and a number from 0 to 31 in the NOTE column.	<p>Try the transaction again. If the error persists, check the following:</p> <ul style="list-style-type: none">• Check the hookup. The cord from the TEL. LINE jack to the wall jack should be no longer than six feet.• Make sure there are no modem devices sharing the same telephone line.• Check with the other party to make sure their fax machine is functioning properly.• Have your telephone line checked for line noise.• Try connecting the machine to a different telephone line.• If the problem still occurs, your machine may need service.

Dialing and transmission problems

Problem	Solution
Dialing is not possible.	<ul style="list-style-type: none"> • Make sure the power cord is properly plugged into a power outlet. • Make sure that the telephone line is properly connected to both the TEL. LINE jack and the wall jack. • Make sure that the machine is set to the correct dialing mode for your telephone line. See Option Setting 22 in Chapter 7.
The power is on, but no transmission takes place.	<ul style="list-style-type: none"> • Make sure that the receiving machine has paper. • Make sure that the telephone line cord is plugged into the TEL. LINE jack, and not the TEL. SET jack. • If the receiving machine is in manual mode with no attendant, reception will not be possible. • If the receiving machine is not a Sharp model, make sure it is G3 compatible. • Check the display for error messages. • Press the SPEAKER key and check for a dial tone.
Nothing is printed at the receiving end.	<ul style="list-style-type: none"> • Make sure that the document for transmission is placed face down in the feeder.
A distorted image is received at the other end.	<ul style="list-style-type: none"> • If ECM mode (Option Setting 9) is turned off, noise on the telephone line may cause distortion. Try sending the document again. • Make a copy of the document on your machine. If the copy is also distorted, your machine may need service.

Reception and copying problems

Problem	Solution
The machine doesn't receive documents automatically.	<ul style="list-style-type: none"> • Make sure that the reception mode is set to AUTO. If you subscribe to a distinctive ring service, make sure that the Distinctive Ring function is set to the correct ring pattern. If you do not subscribe to a distinctive ring service, make sure that Distinctive Ring is set to OFF SETTING. (See Distinctive Ring in Chapter 6.)
The received document is faint.	<ul style="list-style-type: none"> • Ask the other party to send higher contrast documents. If the contrast is still too low, your machine may need service. Make a copy or print a report to check your machine's printing ability. • The toner cartridge may need replacement.
The printed image appears dirty and/or the paper jams frequently.	<ul style="list-style-type: none"> • Have a service technician clean the print compartment.
The power is on, but no reception takes place.	<ul style="list-style-type: none"> • Make sure that the wall jack is connected to the TEL. LINE jack, and not the TEL. SET jack.
Received images are distorted.	<ul style="list-style-type: none"> • If ECM mode (Option Setting 9) is turned off, noise on the telephone line may cause distortion. Have the other party try sending the document again. • If the other machine has ECM mode, make sure this feature is turned on in both machines (see Option Setting 9). • Make a copy or print a report on your machine. If the copy or report is also distorted, your machine may need service. • The drum cartridge may be damaged. Try a new drum cartridge. • The fusing unit and transfer roller may need to be replaced during the life of the machine if print quality begins to deteriorate. This must be done by a service technician.

<p>The quality of copies is poor and/or black lines appear.</p>	<ul style="list-style-type: none"> Any dirt or material on the scanning glass will cause lines to appear on copies and transmitted faxes. Clean the scanning glass as explained in Chapter 9.
<p>Dots appear at regular intervals on received documents and copies.</p>	<ul style="list-style-type: none"> The drum cartridge may be damaged. Replace the drum cartridge.
<p>The printing paper comes out blank when you try to receive a document.</p>	<ul style="list-style-type: none"> Make sure that the document is loaded properly in the feeder of the transmitting machine. Make a copy or print a report to confirm the printing ability of your machine.

General problems

<p>Problem</p>	<p>Solution</p>
<p>Nothing appears in the display.</p>	<ul style="list-style-type: none"> Make sure the power cord is properly plugged into a power outlet and the power switch is turned on. Connect another electrical appliance to the outlet to see if it has power.
<p>The machine does not respond when you press any of its keys.</p>	<ul style="list-style-type: none"> If a beep sound is not made when you press the keys, turn off the power switch and then turn it on again several seconds later.
<p>Automatic document feeding does not work for transmission or copying.</p>	<ul style="list-style-type: none"> Check the size and weight of the document (see <i>Transmittable Documents</i> in Chapter 2).
<p>No reception occurs when polling is attempted.</p>	<ul style="list-style-type: none"> Make sure you have not run out of paper. Make sure the transmitting machine is in automatic reception mode. If the transmitting machine has polling security, make sure that your fax number has been entered both in your machine and in the transmitting machine.

Network interface board problems

Problem	Solution
The amber light illuminates steadily.	<ul style="list-style-type: none"> • The network connection has been lost. This typically occurs because the server has been shut down.
The amber light blinks.	<ul style="list-style-type: none"> • Turn the machine power off, wait briefly, and then turn it back on. If the problem persists, print out the "NIC INFORMATION" as explained on page 78. If there is a problem in the NIC information, reset the network interface board as explained on page 77. If the problem persists after resetting the board, contact your dealer for service.
Cannot connect to the network for either printing or scanning.	<ul style="list-style-type: none"> • The network interface board (NIC) has failed or is not properly connected, or there is a problem with the network cable. Make sure the NIC is operating properly and is connected to the network cable. Make sure that the cable is Category 5 cable, and that it is connected in a straight connection (no cross connections). If the problem persists, contact your administrator or dealer.

Network printer problems

Problem	Solution
The printer function does not operate.	<ul style="list-style-type: none"> • Is the machine plugged in? Plug the machine into a grounded outlet. • Is the power switch on? Turn the power switch on.
The machine is on but data is not received. (The DATA light does not light or blink.)	<ul style="list-style-type: none"> • Is the ON LINE light on? Press the ON LINE key to turn on the ON LINE light. • Is the printer driver installed? Install the printer driver. • Make sure that the machine is selected as the printer in the software application and that the machine is registered on the network.

<p>The machine is on and data is received, but the data is not printed. (The DATA indicator blinks.)</p>	<ul style="list-style-type: none"> • Check to see if an error message appears in the display of the machine. • Is the specified size of paper loaded in the machine? Load paper or select another paper size.
<p>The machine cannot be selected from your computer.</p>	<ul style="list-style-type: none"> • Is the printer driver installed correctly? Install the printer driver correctly.
<p>Incorrect printing orientation</p>	<ul style="list-style-type: none"> • Is the orientation setting in the printer driver correct? Correct the orientation setting in the Paper tab of the printer driver.
<p>The printed image is clipped or off the edge of the paper.</p>	<ul style="list-style-type: none"> • Was a different paper size used? Select the same paper size as the document in the Paper tab of the printer driver, and make sure that correct size of paper is loaded in the selected source. • Make sure the orientation setting in the Paper tab of the printer driver is the same as the orientation of the original document.
<p>Printing stops in the middle of a print job.</p>	<ul style="list-style-type: none"> • Check the display of the machine to see if a message appears. Correct the problem indicated by the message.
<p>The paper specified in the software application is not used.</p>	<ul style="list-style-type: none"> • Make sure that the desired paper is set in the paper tray or cassette of the machine and select "Auto" for the paper source in the printer driver.

Network scanner problems

Problem	Solution
The recipient can not open the image data.	<ul style="list-style-type: none"> • Does the recipient have a software program (viewer) that is compatible with the format of the file sent? Try sending the image using a different file format (TIFF or PDF) and/or compression method (uncompressed, G3 or G4).
Data sent does not reach the recipient.	<ul style="list-style-type: none"> • Is the image being sent to the correct address? When using a Rapid Key or Speed Dial number, is the correct address (e-mail address or FTP address) stored in the Rapid Key or Speed Dial number? Check the stored address and correct if necessary. • If Scan to E-mail is not successful, check to see if an unsuccessful delivery message was sent to your specified sender's e-mail address. This may provide details on the problem. • To use Scan to Desktop, the Network Scanner Tool must be installed.
Scan to E-mail is not successful.	<ul style="list-style-type: none"> • The image might have exceeded the file size limit set by your administrator for e-mail. Reduce the file size (decrease the number of scanned pages, use a lower resolution setting, or use a higher compression level such as G4). Contact your administrator to see if there is a file size limit for e-mail.
A long time is required to send an image.	<ul style="list-style-type: none"> • A large file size can greatly increase the amount of time required for transmission. Reduce the file size (decrease the number of scanned pages, use a lower resolution setting, or use a higher compression level such as G4).

Messages and Signals

Display messages

CHECK CASSETTE	This indicates that the cassette is not installed properly.
CONF. REFUSED	A confidential transmission has been denied because you entered an incorrect mailbox number for a machine with mailboxes.
CONF. RX ERROR	Confidential reception was cancelled because the mailbox number specified by the transmitting machine is not programmed in your machine.
CHECK COVER OR DRUM	The print compartment cover is open or the drum cartridge has not been installed. Close the cover or install the drum cartridge.
DRUM LIFE REACHED	The drum cartridge must be replaced soon (this message appears when approximately 1000 pages can still be printed).
E-MAIL TRANSFER	This appears when the Inbound Routing function is set to forward all received faxes to e-mail addresses and Option Setting 36 is set to only print forwarded faxes when an error occurs, so that normally no received faxes are printed.
FAX RCVD IN MEMORY	A fax has been received in memory because the toner cartridge needs replacement, you have run out of printing paper, or the paper is jammed. The fax will automatically print out when the problem is fixed.
LINE ERROR	Transmission or reception was not successful. Press STOP to clear the message and then try again. If the error persists, see <i>Line Error in Problems and Solutions</i> in this chapter.
MEMORY FULL ERROR	An internal memory error occurred. You may need to resend one or more pages of the document being transmitted when the error occurred.

MEMORY FULL ERROR PRESS STOP KEY	The memory is full (this message appears when Option Setting 23, Quick On-line, is set to NO). Press the STOP key to clear the message and cancel the transmission.
MENU MODE	The MENU key has been pressed.
NO CONF. FUNCTION	Confidential transmission was cancelled because the receiving machine does not have a confidential function, a confidential passcode is not programmed in it, its memory is full, or it is not a Sharp model.
NO PAPER	This indicates that you are out of paper. If the machine has multiple paper sources, the message will be followed by the paper source (or sources) that is out of paper in parentheses. If no paper source is indicated, all paper sources are out of paper.
ONHOOK DIAL MODE	The SPEAKER key has been pressed and the machine is waiting for you to dial.
OUTPUT TRAY OFF	The received document tray is not attached. Attach it as explained in <i>Connections</i> in Chapter 1 (the tray must be attached for the machine to operate properly.)
PAPER JAM	The printing paper is jammed. See the following section, <i>Clearing Paper Jams</i> .
RCVD CONF. FAX	A confidential fax has been received in memory. Print the fax as explained in <i>Confidential Operations</i> in Chapter 6.
REMOVE ORIGINAL(S)	The original document is jammed. See the following section, <i>Clearing Paper Jams</i> .
SIZE ERROR	This message will be followed by one of the paper sources in parentheses, and informs you that the paper loaded in that source is not all the same size.
REPLACE TONER	The toner cartridge must be replaced.

<p>WAITING<MEMORY FULL></p>	<p>The memory has become full and scanning has stopped during scanning of a multi-page document. Scanning will automatically resume when sufficient memory becomes free (for example, after several pages are transmitted).</p>
-----------------------------------	---

Network scanner communication errors

If a communication error occurs during transmission of a scanned image, the following error message will appear with an error code.

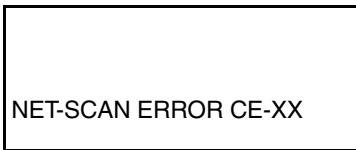

Error Code	Description of the Error
CE-01	The network interface board is not installed or is out of order.
CE-02	Cannot find the specified mail server or FTP server.
CE-03	The server was down during scanning of the original.
CE-04	An invalid account name or password for the FTP server was entered.
CE-05	An invalid directory in the FTP server was entered.
CE-00	An error other than the above occurred.

Audible signals

Continuous tone	3 seconds	Indicates the end of transmission, reception, or copying.
Intermittent tone (3 beeps)	5 seconds (1 second on, 1 second off)	Indicates incomplete transmission, reception, or copying.
Rapid intermittent tone	35 seconds (0.7 seconds on, 0.3 seconds off)	Indicates that an extension phone connected to the fax is off hook.

Clearing Paper Jams

Clearing a jammed document

If the original document doesn't feed properly during transmission or copying, or REMOVE ORIGINAL(S) appears in the display, first try pressing . If the document doesn't feed out, open the operation panel and remove it.

Important:

Do not try to remove a document without opening the operation panel. This may damage the feeder mechanism.

1 Open the operation panel.

- Squeeze the release marked **PANEL RELEASE** and pull up.



2 Remove the document.

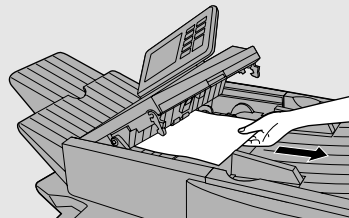

3 Close the operation panel, making sure it clicks into place.



Clearing jammed printing paper

If the printing paper jams, PAPER JAM will appear in the display. Follow the steps below to clear the jam.

1 Press the green release and open the print compartment cover.

- **Caution!**

The fusing unit inside the print compartment becomes very hot during operation. Be careful not to touch the inside of the compartment.



2 Remove the toner cartridge and place it on a sheet of paper.

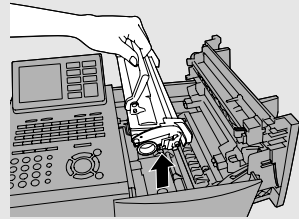

3 Remove the drum cartridge.

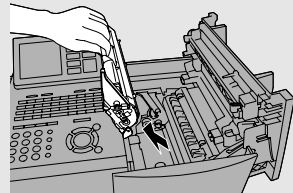

4 Remove the jammed paper.

- Make sure no torn pieces of paper remain in the print compartment and rollers.

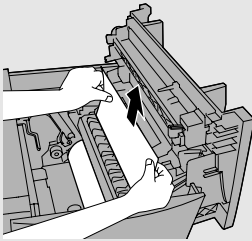

OR

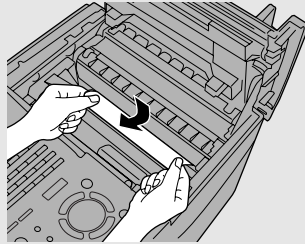

5 Replace the drum cartridge.

- Make sure the drum cartridge is inserted in as far as it will go.

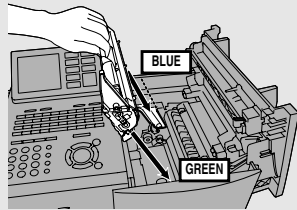

6 Replace the toner cartridge and then close the print compartment cover.

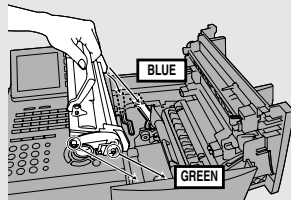

7 If you have a paper cassette and the display still indicates that paper is jammed, pull out the cassette and remove the jammed paper.

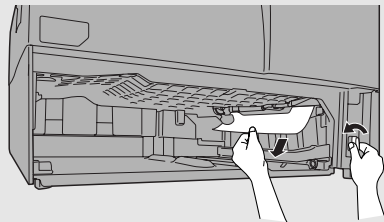

8 Replace the paper cassette.

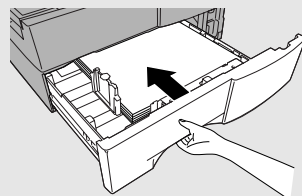

10. Trouble-shooting

FCC Regulatory Information

This equipment complies with Part 68 of the FCC rules and the requirements adopted by the ACTA. On the rear of this equipment is a label that contains, among other information, a product identifier in the format US:AAAEQ##TXXXX. If requested, this number must be provided to the telephone company.

A plug and jack used to connect this equipment to the premises wiring and telephone network must comply with the applicable FCC Part 68 rules and requirements adopted by the ACTA. A compliant telephone cord and modular plug is provided with this product. It is designed to be connected to a compatible modular jack that is also compliant. See installation instructions for details. This equipment connects to the telephone network through a standard USOC RJ-11C network interface jack.

The REN is used to determine the number of devices that may be connected to a telephone line. Excessive RENs on a telephone line may result in the devices not ringing in response to an incoming call. In most but not all areas, the sum of RENs should not exceed five (5.0). To be certain of the number of devices that may be connected to a line, as determined by the total RENs, contact the local telephone company. For products approved after July 23, 2001, the REN for this product is part of the product identifier that has the format US:AAAEQ##TXXXX. The digits represented by ## are the REN without a decimal point (e.g., 03 is a REN of 0.3). For earlier products, the REN is separately shown on the label.

If this equipment causes harm to the telephone network, the telephone company will notify you in advance that temporary discontinuance of service may be required. But if advance notice isn't practical, the telephone company will notify the customer as soon as possible. Also, you will be advised of your right to file a complaint with the FCC if you believe it is necessary.

The telephone company may make changes in its facilities, equipment, operations or procedures that could affect the operation of the equipment. If this happens the telephone company will provide advance notice in order for you to make necessary modifications to maintain uninterrupted service.

If trouble is experienced with this equipment, or for repair or warranty information, please contact your authorized Sharp dealer. If the equipment is causing harm to the telephone network, the telephone company may request that you disconnect the equipment until the problem is resolved.

This equipment may not be used on coin service provided by the telephone company. Connection to party line service is subject to state tariffs. Contact the state public utility commission, public service commission or corporation commission for information.

If your home has specially wired alarm equipment connected to the telephone line, ensure that the installation of this equipment does not disable your alarm equipment. If you have questions about what will disable alarm equipment, consult your telephone company or a qualified installer.

When programming and/or making test calls to emergency numbers:

- ◆ Remain on the line and briefly explain to the dispatcher the reason for the call.
- ◆ Perform such activities in the off-peak hours, such as early morning or late evening.

S H A R P

Date Revised : Oct. 7, 2002

Date Issued : May. 28, 1998

MATERIAL SAFETY DATA SHEET (1/3)

MSDS No. B-1020

Section 1. Product and Company Identification

Product Name: Toner Cartridge of FO-50ND / DUNT-455BSCZZ

Supplier Identification: Sharp Corporation
22-22 Nagaike-cho, Abeno-ku, Osaka, Japan

Local suppliers are listed below. Please contact the nearest supplier for additional information.

(Country)	(Name and Telephone Number)
U.S.A.	Sharp Electronics Corporation Telephone number for information: 1-800-237-4277 Emergency telephone number : 1-800-255-3924
Canada	Sharp Electronics of Canada Ltd. Telephone number for information: 905-890-2100 Emergency telephone number : 1-800-255-3924

Section 2. Ingredients

Ingredients	Cas No.	Proportion	OSHA Z-Tables	ACGIH TLV	IARC	DFG-MAK(GER)	Other Limits
Polyester resin	Trade Secret	>90%	—	—	—	—	—
	(Trade secret No. 361615 -5042-P in New Jersey)						
Carbon black	1333-86-4	1 - 5%	3.5 mg/m ³	3.5 mg/m ³	2B	III 3B	TWA(Austl) : 3 mg/m ³
Polyolefin wax	9003-07-0	1 - 5%	—	—	—	—	—
Organic pigment	Trade Secret	1 - 5%	—	—	—	—	—
	(Trade secret No. 361615 -5025-P in New Jersey)						

Section 3. Hazardous Identification

Most Important Hazards and Effects of the Products

For Human Health: This toner is not classified as a human carcinogen. No symptoms expected with intended use.

For the Environment: No data are available on the adverse effects of this product on the environment.

For others: None

Specific hazards: Dust explosion (like most finely divided organic powders)

Section 4. First-Aid Measures

Symptoms of Overexposure: No symptoms expected with intended use.

Routes of Entry: Eye contact, inhalation, ingestion

Information

Inhalation: If symptoms are experienced, remove source of contamination or move victim to fresh air and obtain medical advice.

Skin Contact: Flush with gently flowing water (preferably lukewarm) and soap for 15 minutes or until particle is removed. If irritation does occur, obtain medical advice.

Eye Contact: Do not allow victim to rub eye(s). Flush with gently flowing water (preferably lukewarm) for 15 minutes or until particle is removed. Have victim look right and left, and, then up and down. If irritation does occur, obtain medical attention. DO NOT attempt to manually remove anything stuck to the eye(s).

Ingestion: If irritation or discomfort occurs, obtain medical attention immediately.

Note to Physician: None

Section 5. Fire-Fighting Measures

Suitable Extinguishing Media: CO₂, water spray, foam and dry chemical

Extinguishing Media to Avoid: Full water jet

Special Firefighting Procedures: None

Fire and Explosion Hazards: If dispersed in air, toner, like most finely divided organic powders, may form an explosive mixture.

Protection of Firefighters: Use self-contained breathing apparatus (SCBA).

Section 6. Accidental Release Measures

Personal Precautions: None

Environmental Precautions: None

Methods for Cleaning Up: Wipe off with paper or cloth. DO NOT use vacuum cleaner when a large amount is released. It, like most finely divided organic powders, may create a dust explosion.

Section 7. Handling and Storage

Handling

Technical Measures: None

Precautions: None

Safe Handling Advice: Try not to disperse the particles.

Storage

Technical Measures: None

Storage Conditions: Keep container closed. Store in a cool and dry place. Keep out of reach of children.

Incompatible Products: None

S H A R P

Date Revised :Oct. 7, 2002

Date Issued :May. 28, 1998

MATERIAL SAFETY DATA SHEET (2/3)

MSDS No. B-1020

Section 8. Exposure Control/Personal Protection

Engineering Measures

Ventilation: None required with intended use.

Control Parameters(As total dust)

OSHA-PEL(USA): 15mg/m³ ACGIH-TLV(USA): 10mg/m³ DFG-MAK(GER): 6mg/m³ Worksafe-TWA(Austl.): 10mg/m³

Personal Protective Equipment

None required when used as intended in Sharp equipment. For use other than normal customer-operating procedures (such as in bulk toner processing facilities), goggles and respirators may be required.

Hygiene Measures: Wash hands after handling.

Section 9. Physical and Chemical Properties

Appearance

Physical State: Solid	Form: Powder	Color: Black	Explosion Properties:	No data available
Odor:	Faint odor		Density(g/cm ³):	1.2 (bulk density: 0.5)
Particle Size(μm):	5 - 15		Solubility in water:	Negligible
Boiling Point:	Not applicable		Oxidizing Properties:	No data available
Melting Point(°C):	No data available		Ignition Temperature(°C):	450 *
Softening Point(°C):	120 - 130 *		Vapor Pressure:	Not applicable
Flash Point:	Not applicable			
pH:	Not applicable			
Partition Coefficient, n-Octanol/Water:	Not applicable			

Section 10. Stability and Reactivity

Stability: Stable [X] Unstable []

Hazardous Reactions: Dust explosion, like most finely divided organic powders.

Conditions to avoid: Electric discharge, throwing into fire.

Materials to Avoid: Oxidizing materials.

Hazardous Decomposition Products: CO, CO₂

Section 11. Toxicological Information

Health Effects from Exposure: No symptoms expected with intended use.

Toxicological Data

Acute Toxicity:

Inhalation, LC50(mg/l): >0.74 (Rats,4hour exposure) * (This was the highest attainable concentration.)

Ingestion(oral), LD50(mg/kg): >5000 (Rats) *

Dermal, LD50(mg/kg): >2000 (Rats) *

Eye irritation: Non irritant (Rabbits) *

Skin irritation: Non irritant (Rabbits) *

Skin sensitizer: No data available

Mutagenicity: Negative * (AMES test)

(* = Based on data for other Products with similar ingredients)

Local Effects: see Chronic Toxicity or Long term Toxicity

Chronic Toxicity or Long Term Toxicity: Prolonged inhalation of excessive dust may cause lung damage.

It is attributed to "lung overloading", a generic response to excessive amounts of any dust retained in the lungs for a prolonged interval. Use of this product, as intended, does not result in inhalation of excessive dust.

In a study in rats by chronic inhalation exposure to a typical toner, a mild to moderate degree of lung fibrosis was observed in 92% of rats in the high concentration(16mg/m³) exposure group, and a minimal to mild degree of fibrosis was noted in 22% of the animals in the middle(4mg/m³) exposure group. But no pulmonary change was reported in the lowest(1mg/m³) exposure group, the most relevant level to potential human exposures.

Carcinogenicity

IARC Monographs: Not listed

NTP(USA): Not listed

OSHA Regulated(USA): Not listed

In 1996 the IARC reevaluated carbon black as a Group 2B carcinogen (possible human carcinogen). This valuation is given to Carbon Black for which there is inadequate human evidence, but sufficient animal evidence. The latter is based upon the development of lung tumors in rats receiving chronic inhalation exposures to free carbon black at levels that induce particle overload of the lung.

Studies performed in animal models other than rats have not demonstrated an association between carbon black and lung tumors. Moreover, a two-year cancer bioassay using a typical toner preparation containing carbon black demonstrated no association between toner exposure and tumor development in rats.

S H A R P

Date Revised :Oct. 7, 2002

Date Issued :May. 28, 1998

MATERIAL SAFETY DATA SHEET (3/3)

MSDS No. B-1020

Section 12. Ecological Information

No data are available on the adverse effects of this material on the environment.

Section 13. Disposal Consideration

Appropriate Methods of Disposal

Preparation (community provisions): Waste may be disposed or incinerated under conditions which meet all federal, state and local environmental regulations.

Contaminated Packaging: Waste may be disposed or incinerated under conditions which meet all federal, state and local environmental regulations.

Precautions: Do not throw the toner cartridge or toner into a n open flame. The hot toner may scatter and cause burns or other damage.

Section 14. Transport Information

Special Precautions: None

Information on Code and Classifications According to International Regulations

UN Classification: None

Section 15. Regulatory Information

US Information

Information on the label: Not required

TSCA (Toxic Substances Control Act):

All chemical substances in this product comply with all applicable rules or order under TSCA.

SARA (Superfund Amendments and Reauthorization Act) Title III

302 Extreme Hazardous Substance: None

311/312 Hazard Categories: None

313 Reportable Ingredients: None

California Proposition 65:

This product contains no chemical substances subject to California Proposition 65.

EU Information

Information on the label (88/379/EEC) and 67/548/EEC) :

Symbol & Indication : Not required

R-phrase : Not required

S-phrase : Not required

76/769/EEC:

All chemical substances in this product comply with all applicable rules or order under 76/769/EEC.

Section 16. Other Information

NFPA Hazard Rating: The National Fire Protection Agency (USA): Health: 1 Flammability: 1 Reactivity: 0

HMIS Rating: The National Paint and Coating Association (USA): Health: 1 Flammability: 1 Reactivity: 0

Recommended Uses: Toner for Electrophotographic Equipment

Restrictions: This information relates only to the specific material designated as supplied by the manufacturer. This information is supplied to us by the manufacturer and Sharp offers no warranties as to its accuracy and accepts no responsibilities for any typographical errors which may appear on these sheets. It is the responsibility of the user to determine the suitability of this product for each particular use.

Literature References:

ANSI Z400.1-1993

ISO 11014-1

Commission Directive 91/155/EEC

The Material Safety Data sheet: A Practical Guide to First Aid: Canadian Centre for Occupational Health and Safety's publication HMIS IMPLEMENTATION MANUAL: National Paint & Coatings association

IARC (1996): IARC monographs on the Evaluation of the Carcinogenic Risk of Chemicals to Humans, Vol.

65, Printing Process and Printing Inks, Carbon Black and Some Nitro Compounds, Lyon, pp.149-261

H.Muhle, B.Bellmann, O.Creutzenberg, C.Dasenbrock, H.Ernst, R.Kilpper, J.C.MacKenzie, P.Morrow,

J.Mohr, S.Takenaka, and R.Mermelestein (1991) Pulmonary Response to Toner upon Chronic Inhalation

Exposure in Rats. Fundamental and Applied Toxicology 17, pp.280-299.

Revision Record:

Oct. / 7 / 2002

Addition : Contact information

July / 22 / 2002

Change : Section 15 EU information : "88 / 379 / EEC" → "1999 / 45 / EC"

Addition : Product Name FO-50ND

QUICK REFERENCE GUIDE

SENDING FAXES

Place the document (up to 50 letter-size pages) face down in the document feeder.



(Note: For Normal Dialing and Direct Keypad Dialing, you can also load the document after dialing the number.)

Press **RESOLUTION** or **CONTRAST** if needed.

Normal Dialing

1. Lift extension phone or press **SPEAKER**.
2. Dial the fax number (if using an extension phone, dial on the extension phone keypad).
3. Wait for the reception tone (if a person answers, ask them to press their Start key).
4. Press **START/ENTER**.

Rapid Key Dialing

Press the desired Rapid Key.

Speed Dialing

1. Press **SPEED DIAL** and enter the desired Speed Dial number (press **START/ENTER** if you entered less than 3 digits).
2. Press **START/ENTER**.

Direct Keypad Dialing

1. Dial the fax number.
2. Press **START/ENTER**.

STORING AUTO DIAL FAX NUMBERS

1. Press **MENU** and then **▲** or **▼** until **ENTRY MODE** is selected in the display.
2. Press **START/ENTER**. Make sure that **DESTINATION SETTING** is selected.
3. Press **START/ENTER**. Make sure that **SET** is selected. (To clear a number, select **CLEAR**.)
4. Press **START/ENTER**.
5. To store a Rapid Key number, press the desired Rapid Key.
To store a Speed Dial number, press **SPEED DIAL** and enter a number from 1 to 100 (FO-DC500) or 200 (FO-DC600) (press **START/ENTER** if you entered less than 3 digits). (If clearing a number, select it as explained above and then press **START/ENTER** and **STOP**.)
6. If the network scanner option is installed, **SELECT DESTINATION TYPE** will appear. Make sure that **FAX** is selected and press **START/ENTER**.
7. Enter the full fax number and press **START/ENTER**.
8. Enter a name by pressing the letter keys and press **START/ENTER**.
9. Select **YES** if this is a Chain Dial number or **NO** if not, and press **START/ENTER**.
10. If the dual-line option is installed, select **LINE-1**, **LINE-2**, or **AUTO** and press **START/ENTER**.
11. Press **STOP** repeatedly to exit.

ENVÍO POR FAX

Coloque el documento (hasta 50 páginas tamaño carta) boca abajo en el alimentador de documentos.



(Nota: si utiliza una Marcación normal o una Marcación directa desde el teclado, también puede cargar el documento después de marcar el número).

Pulse **RESOLUTION** o **CONTRAST** en caso necesario.

Marcación normal

1. Descuelgue el teléfono supletorio o pulse **SPEAKER**.
2. Marque el número de fax (si utiliza un teléfono supletorio, márkelo en el teclado numérico del teléfono supletorio).
3. Espere hasta escuchar el tono de recepción (si contestara una persona, pídale que puse la tecla Inicio de su equipo).
4. Pulse **START/ENTER**.

Marcación por tecla rápida

Pulse la Tecla rápida deseada.

Marcación abreviada

1. Pulse **SPEED DIAL** e introduzca el número de Marcación abreviada deseado (pulse **START/ENTER** si introdujo menos de 3 dígitos).
2. Pulse **START/ENTER**.

Marcación directa desde el teclado

1. Marque el número de fax.
2. Pulse **START/ENTER**.

MEMORIZACIÓN DE NÚMEROS DE FAX DE MARCACIÓN AUTOMÁTICA

1. Pulse **MENU** y después **▲** o **▼** hasta que aparezca ENTRY MODE en el display.
2. Pulse **START/ENTER**. Asegúrese que DESTINATION SETTING esté seleccionado.
3. Pulse **START/ENTER**. Asegúrese que SET esté seleccionado. (Para borrar un número, seleccione CLEAR).
4. Pulse **START/ENTER**.
5. Para memorizar un número de Tecla rápida, pulse la Tecla rápida deseada. Para memorizar un número de Marcación abreviada, pulse **SPEED DIAL** e introduzca un número del 1 al 100 (FO-DC500) o al 200 (FO-DC600) (pulse **START/ENTER** si ha introducido menos de 3 dígitos).
(Si desea borrar un número, selecciónelo como se ha explicado anteriormente y pulse **START/ENTER** y **STOP**).
6. Si ha instalado la opción de escáner de red, aparecerá SELECT DESTINATION TYPE. Asegúrese de que selecciona FAX y pulse **START/ENTER**.
7. Introduzca el número completo de fax y pulse **START/ENTER**.
8. Introduzca un nombre pulsando las teclas correspondientes a las letras y pulse **START/ENTER**.
9. Seleccione YES si se trata de un número de Marcación en cadena o NO si no lo es y pulse **START/ENTER**.
10. Si está instalada la opción de doble línea, seleccione LINE-1, LINE-2 o AUTO y pulse **START/ENTER**.
11. Pulse **STOP** varias veces para salir.

Envois de documents

Placez votre document (jusqu'à 50 pages de format papier à lettre) face imprimée vers le bas dans le chargeur de documents.



(Remarque : Pour la composition normale et la composition directe au clavier, vous pouvez également charger le document après avoir procédé à la composition du numéro.)

Pressez les touches **RESOLUTION** ou **CONTRAST** si nécessaire.

Numérotation Normale

1. Décrochez le combiné du téléphone supplémentaire ou pressez la touche **SPEAKER**.
2. Composez le numéro du télécopieur (si vous utilisez un téléphone supplémentaire, composez le numéro sur son clavier).
3. Attendez la tonalité de réception (si une personne répond, demandez-lui de pressez la touche).
4. Pressez la touche **START/ENTER**.

Numérotation par Touche Rapide

Pressez la touche rapide souhaitée.

Composition Accélérée

1. Pressez la touche **SPEED DIAL** et entrez le numéro de composition accélérée (pressez **START/ENTER** si vous avez entré un numéro à 3 chiffres).
2. Pressez la touche **START/ENTER**.

Numérotation directe au clavier

1. Composez le numéro de télécopieur.
2. Pressez la touche **START/ENTER**.

ENREGISTREMENT DE NUMÉROS DE TÉLÉCOPIEURS À COMPOSITION AUTOMATIQUE

1. Pressez la touche **MENU** et ensuite **START/ENTER** ou **START/ENTER** jusqu'à ce que **ENTRY MODE** soit sélectionné à l'écran.
2. Pressez la touche **START/ENTER**. Assurez-vous que **DESTINATION SETTING** est sélectionné.
3. Pressez la touche **START/ENTER**. Assurez-vous que **SET** est sélectionné. (Pour effacer un numéro, sélectionnez **CLEAR**.)
4. Pressez la touche **START/ENTER**.
5. Pour enregistrer un numéro à composition par touche rapide, pressez la touche rapide souhaitée. Pour enregistrer un numéro à composition accélérée, pressez la touche **SPEED DIAL** et entrez un numéro compris entre 1 et 100 (FO-DC500) ou 200 (FO-DC600) (pressez la touche **START/ENTER** si vous entrez moins de 3 chiffres).
(Si vous désirez effacer un numéro, sélectionnez-le selon la méthode décrite ci-avant et pressez les touches **START/ENTER** et **STOP**.)
6. Si l'option scanner réseau est installée, **SELECT DESTINATION TYPE** apparaîtra à l'écran. Assurez-vous que **FAX** est sélectionné et pressez la touche **START/ENTER**.
7. Entrez le numéro de télécopieur complet et pressez **START/ENTER**.
8. Entrez un nom à l'aide des touches comportant des lettres et pressez la touche **START/ENTER**.
9. Sélectionnez **YES** s'il s'agit d'un numéro à composition enchaînée ou **NO** si ce n'est pas le cas et pressez la touche **START/ENTER**.
10. Si l'option double ligne est installée, sélectionnez **LINE-1**, **LINE-2** ou **AUTO** et pressez sur la touche **START/ENTER**.
11. Pressez la touche **STOP** de manière répétée pour quitter le menu.

Index

A

Activity Report, 200
 Auto Listing, 190
Alarm volume, 195
Anti Junk Fax, 183, 195
Anti Junk Number List, 203
Audible signals, 216
Auto Cover Sheet, 192
Auto reception mode, 63, 64
Auto-dial numbers, programming, 39

B

Backlight setting, 198
Batch page numbering, 62
Batch transmission, 164-165
Batch Transmission List, 203
Beep length, 196
Broadcasting, 139-141

C

Canceling a fax, 51, 52
Cassette Selection, 193
Chain Dialing, 42, 50
Confidential operations, 145-149
Confidential Reception List, 203
Contrast, 36
Copies, making, 136
Copy Cut-off, 192
Copy Scanning, 192
Cover Sheet, 60
 Auto Cover Sheet, 192

D

Date, setting, 27
Daylight Saving Time, 29
Default copy resolution, 197
Department Code Digits, 196
Department Control, 180-182
Department Usage List, 203
Destination List, 202
Dial mode, 195

Dialing

 Chain, 42, 50
 Direct Keypad, 48
 Normal, 37
 Rapid Key, 46
 Speed, 47
Direct Keypad Dialing, 48
Distinctive ring, 187
DNS server settings, 79
Document feeder, 34
Document guides, 34
Document restrictions, 33
Document sizes, 32
Document, maximum scanning area, 33
Drum cartridge
 Installing and replacing, 18-21
Duplex Scanning, 176

E

Error Correction Mode (ECM), 192

F

Fax status, 51
Fax Transfer, 198
Fax Transfer List, 204
Fine Resolution Priority, 190

G

Group Keys, 142-144

H

Halftone setting, 35
Housing, cleaning, 205

I

Image Memory Print, 193
Inbound Routing, 103
IP address
 Checking, 78
 Setting, 75

Index

J

Jams, clearing, 217-219

L

Letters, entering, 26, 67

Line error, 207

Loading the document, 34

M

Mail server settings, 79

Manual reception mode, 63, 64

Memory

Checking documents in, 51, 65

Sending faxes from, 45

Substitute reception to, 65

Memory retransmission, 53

Multi TTI, 195

N

Network interface board

Initializing, 77

LEDs, 207

Network scanner software, 96, 103

Network settings, printing, 78

Normal Dialing, 37

Number of rings in AUTO reception, 190

Number of rings in manual reception, 190

O

Optional Setting List, 203

P

Page numbering, batch, 62

Paper jams, clearing, 217-219

Paper, loading, 22

Passcode List, 202

Pauses in automatic dialing, 40

PC Fax function, 71

Personal Book List, 203

Personal books, 54-59

Polling, 150-157

Security Selection, 191

Power Save mode, 194

Print Hold, 177, 199

Print job, canceling, 12, 129

Printer driver settings, 131-135

Printer driver, installing, 110-124

Program and Group List, 203

Programs, 166-175

Q

Quick On-line, 195

R

Rapid Key Dialing, 46

Recall Interval, 191

Recall Times, 191

Receive Reduce, 193

Reception mode

Auto, 63, 64

Manual, 63, 64

Setting, 63

Redialing, 38, 53

Resolution, 35

Retransmission interval, 194

Retransmission times, 194

Ringer volume, 31

S

Scan to Desktop

Storing destinations, 82

Using a Rapid Key, 89

Using a Speed Dial number, 91

Scan to E-mail

Setup, 84

Storing destinations, 82, 93

Using a Rapid Key, 89

Using a Speed Dial number, 91

Using the e-mail key, 87

Scan to FTP

Storing destinations, 82

Using a Rapid Key, 89

Using a Speed Dial number, 91

Scanning destinations, storing, 81

Scanning glass, cleaning, 205
Search Dial, 49
Separate Mode, 197
Speaker volume, 30
Speed Dialing, 47

T

TEL. LINE jack, 16
TEL. SET jack, 16
Telephone billing, 185
Telephone Billing Code, 196
Telephone line cord, 16
Telephone, connecting, 16
Time, setting, 27
Timer, 158

Timer List, 202
Toner cartridge
 Installing and replacing, 18-21
Toner cartridge indicator, 21
Transaction Report, 204
 Print Selection, 191

V

Verification Stamp, 70, 197
 Replacing, 206

W

Web page in machine, accessing, 79



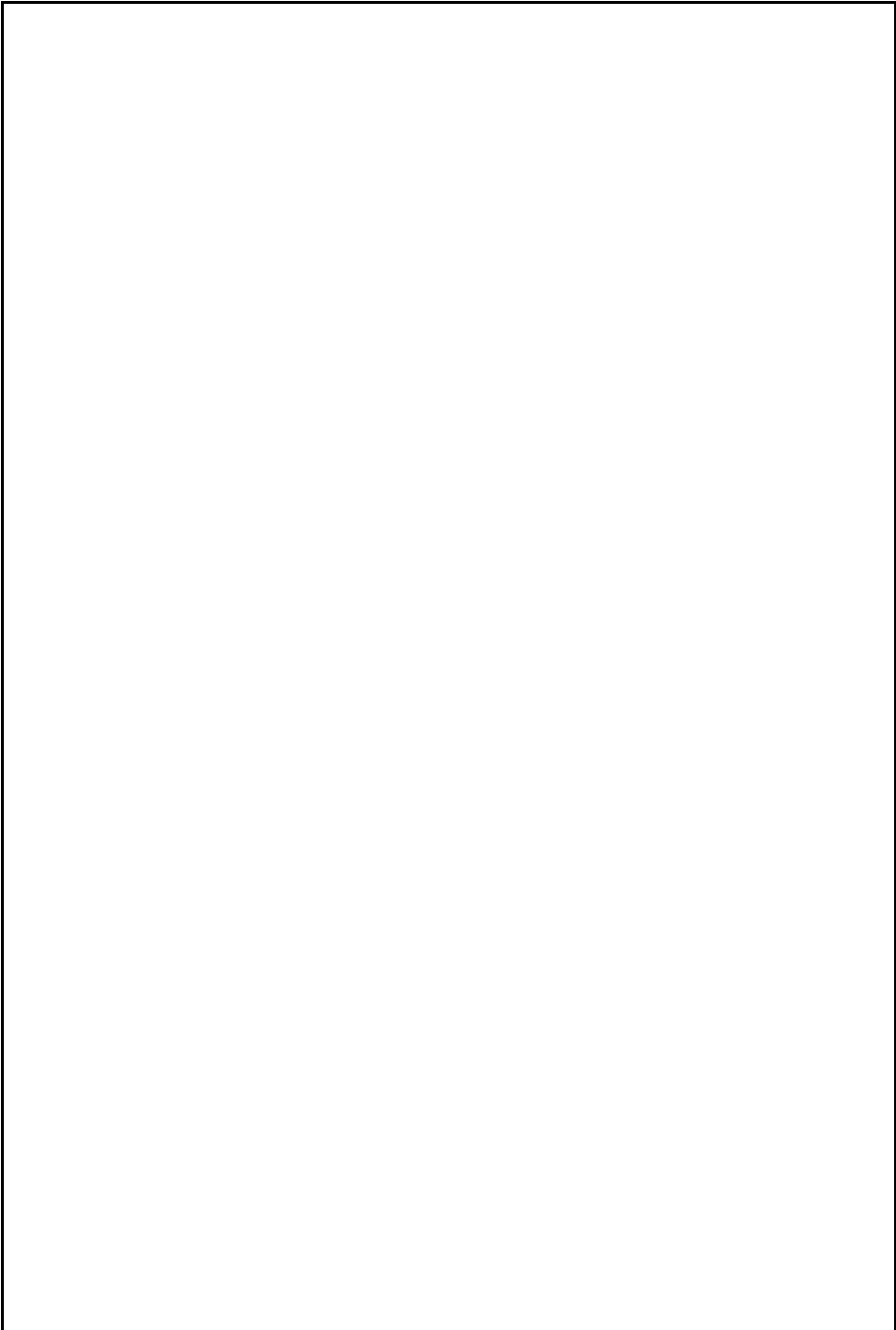



NOTICE

BE SURE TO ASK YOUR AUTHORIZED SHARP DEALER ABOUT THE WARRANTY THAT YOUR SELLING DEALER EXTENDS TO YOU. In order to assure you, the end-user, of warranty protection, Sharp extends a limited warranty to each of its authorized dealers and, in turn, requires each of its authorized dealers to extend its own warranty to you on terms that are no less favorable than those given to the dealer by Sharp. You should be aware, however, that Sharp does not itself extend any warranties, either express or implied, directly to you, the end-user, and no one is authorized to make any representations or warranties on behalf of Sharp. Specifically, SHARP DOES NOT EXTEND TO YOU, THE END-USER, ANY EXPRESS WARRANTY OR ANY IMPLIED WARRANTY OF MERCHANTABILITY, FITNESS FOR USE OR FITNESS FOR ANY PARTICULAR PURPOSE IN CONNECTION WITH THE HARDWARE, SOFTWARE OR FIRMWARE EMBODIED IN, OR USED IN CONJUNCTION WITH THIS PRODUCT. Sharp is not responsible for any damages or loss, either direct, incidental or consequential, which you, the end-user, may experience as a result of your purchase or use of the hardware, software or firmware embodied in or used in conjunction with this Product. Your sole remedy, in the event that you encounter any difficulties with the Product, is against the authorized dealer from which you purchased the Product. In the event that this authorized dealer does not honor its warranty commitments, please contact the Vice President, Sharp Electronics Corporation, Sharp Plaza, Mahwah, NJ 07430-1163 or Sharp Electronics of Canada Ltd., 335 Britannia Road East, Mississauga, Ontario L4Z 1W9, so that Sharp can try to help assure complete satisfaction of all the warranty rights to which you are entitled from the authorized dealer.

SHARP®

SHARP ELECTRONICS CORPORATION

Sharp Plaza, Mahwah, New Jersey 07430-1163

1-800-BE-SHARP

<http://www.sharppusa.com>

SHARP ELECTRONICS OF CANADA LTD.

335 Britannia Road East, Mississauga, Ontario L4Z 1W9

<http://www.sharp.ca>

SHARP CORPORATION

FOR YOUR RECORDS

Please record the model number and serial number below, for easy reference, in case of loss or theft. These numbers are located on the rear side of the unit. Space is also provided for other relevant information.

Model Number FO-DC500/FO-DC600

Serial Number _____

Date of Purchase _____

Place of Purchase _____

Released on February 04

Free Manuals Download Website

<http://myh66.com>

<http://usermanuals.us>

<http://www.somanuals.com>

<http://www.4manuals.cc>

<http://www.manual-lib.com>

<http://www.404manual.com>

<http://www.luxmanual.com>

<http://aubethermostatmanual.com>

Golf course search by state

<http://golfingnear.com>

Email search by domain

<http://emailbydomain.com>

Auto manuals search

<http://auto.somanuals.com>

TV manuals search

<http://tv.somanuals.com>