

SHARP®
Carousel®

DOUBLE GRILL Convection Microwave Oven

OPERATION MANUAL
AND
COOKBOOK



R-820JS
R-820BC

FOR CUSTOMER ASSISTANCE

To aid in reporting this microwave oven in case of loss or theft, please record below the model number and serial number located on the unit. We also suggest you record all the information listed and retain for future reference.

Please provide the following information when you write or call: model number, serial number, date of purchase, your complete mailing address (including zip code), your daytime telephone number (including area code) and description of the problem.

MODEL NUMBER _____	SERIAL NUMBER _____
DATE OF PURCHASE _____	
DEALER _____	TELEPHONE _____
SERVICER _____	TELEPHONE _____

TO PHONE:

DIAL 1-800- BE-SHARP (237-4277) for :

SERVICE (for your nearest Sharp Authorized Servicer)

PARTS (for your authorized parts distributor)

ADDITIONAL CUSTOMER INFORMATION

DIAL 1-800-642-2122 for :

ACCESSORIES and SHARP CAROUSEL COOKBOOK

TO WRITE:

Sharp Electronics Corporation

Customer Assistance Center

1300 Naperville Drive

Romeoville, IL 60446-1091

TO ACCESS INTERNET: www.sharppusa.com

PRECAUTIONS TO AVOID POSSIBLE EXPOSURE TO EXCESSIVE MICROWAVE ENERGY

- (a) Do not attempt to operate this oven with the door open since open-door operation can result in harmful exposure to microwave energy. It is important not to defeat or tamper with the safety interlocks.
- (b) Do not place any object between the oven front face and the door or allow soil or cleaner residue to accumulate on sealing surfaces.
- (c) Do not operate the oven if it is damaged. It is particularly important that the oven door close properly and that there is no damage to the: (1) door (bent), (2) hinges and latches (broken or loosened), (3) door seals and sealing surfaces.
- (d) The oven should not be adjusted or repaired by anyone except properly qualified service personnel.

CONTENTS

For Customer	
Assistance	Inside cover
Precautions to Avoid Possible	
Exposure to Excessive	
Microwave Energy	Inside cover
Limited Warranty	1
Product Information Card	1
Important Safety Instructions	2
Installation Instructions	3
Grounding Instructions	3
Information You Need to Know	4-6
About Your Oven	4
About Food	4
About Utensils and Coverings	5
About Children and the Microwave	6
About Microwave Cooking	6
About Safety	6
Part Names	7-8
Before Operating	9
To Set the Clock	9
Stop/Clear	9
Manual Operation	9-13
Microwave Cooking	9
Convection Cooking	10-11
Grill Cooking	12
Roast Cooking	12
Helpful Hints	13
Special Features	14-19
Popcorn	14
Reheat	14-15
AutoDefrost	16
AutoCook	17-18
AutoBake	17-18
AutoPizza	17-18
AutoGrill	17,19
AutoRoast	17,19
Other Convenient Features	20-22
Custom Help	20
1. Child Lock	
2. Audible Signal Elimination	
3. Auto Start	
4. Language Selection	
5. Weight / Temperature Selection	
Help	20
Minute Plus	20
Manual Defrost	21
Touch On	21
Multiple Sequence Cooking	21
More or Less Time Adjustment	21
Kitchen Timer	22
Demonstration Mode	22
Cleaning and Care	22
Service Call Check	23
Specifications	23
Cooking Guide	24-39
Introduction	24
Foods and Best Cooking Methods ..	25 - 26
Roasting	27
Roasting Chart	27
Main Dish Recipes	28-30
Grilling	31
Grilling Chart	31
Grilling Recipes	32-33
Baking	34
Baking Chart	34
Baking Recipes	35-39
Cookbook Order Form	38-39
Guia Auto-Touch	41-42
Auto-Touch Guide	Inside Back Cover, Back Cover

LIMITED WARRANTY

SHARP ELECTRONICS CORPORATION warrants to the first consumer purchaser that this Sharp brand product (the "Product"), when shipped in its original container, will be free from defective workmanship and materials, and agrees that it will, at its option, either repair the defect or replace the defective Product or part thereof with a new or remanufactured equivalent at no charge to the purchaser for parts or labor for the period(s) set forth below.

This warranty does not apply to any appearance items of the Product nor to the additional excluded item(s) set forth below nor to any Product the exterior of which has been damaged or defaced, which has been subjected to improper voltage or other misuse, abnormal service or handling, or which has been altered or modified in design or construction.

In order to enforce the rights under this limited warranty, the purchaser should follow the steps set forth below and provide proof of purchase to the servicer.

The limited warranty described herein is in addition to whatever implied warranties may be granted to purchasers by law. ALL IMPLIED WARRANTIES INCLUDING THE WARRANTIES OF MERCHANTABILITY AND FITNESS FOR USE ARE LIMITED TO THE PERIOD(S) FROM THE DATE OF PURCHASE SET FORTH BELOW. Some states do not allow limitations on how long an implied warranty lasts, so the above limitation may not apply to you.

Neither the sales personnel of the seller nor any other person is authorized to make any warranties other than those described herein, or to extend the duration of any warranties beyond the time period described herein on behalf of Sharp.

The warranties described herein shall be the sole and exclusive warranties granted by Sharp and shall be the sole and exclusive remedy available to the purchaser. Correction of defects, in the manner and for the period of time described herein, shall constitute complete fulfillment of all liabilities and responsibilities of Sharp to the purchaser with respect to the Product, and shall constitute full satisfaction of all claims, whether based on contract, negligence, strict liability or otherwise. In no event shall Sharp be liable, or in any way responsible, for any damages or defects in the Product which were caused by repairs or attempted repairs performed by anyone other than an authorized servicer. Nor shall Sharp be liable or in any way responsible for any incidental or consequential economic or property damage. Some states do not allow the exclusion of incidental or consequential damages, so the above exclusion may not apply to you.

THIS WARRANTY GIVES YOU SPECIFIC LEGAL RIGHTS. YOU MAY ALSO HAVE OTHER RIGHTS WHICH VARY FROM STATE TO STATE.

<u>Your Product Model Number & Description:</u>	R-820J, R-820B Home Use Carousel Microwave Oven. (Be sure to have this information available when you need service for your Product.)
<u>Warranty Period for this Product:</u>	One (1) year parts and labor. The warranty period continues for an additional four (4) years, for a total of five (5) years, with respect to the magnetron tube in the Product for parts only; labor and service are not provided free of charge for this additional period.
<u>Additional Item(s) Excluded from Warranty Coverage (if any):</u>	Accessories, rubber or plastic parts, the turntable, light bulbs, glass parts or any printed materials.
<u>Where to Obtain Service:</u>	From a Sharp Authorized Servicer located In the United States. To find the location of the nearest Sharp Authorized Servicer, call Sharp toll free at 1-800-BE-SHARP (1-800-237-4277).
<u>What to do to Obtain Service:</u>	Ship prepaid or carry in your Product to a Sharp Authorized Servicer. Be sure to have Proof of Purchase available. If you ship the Product, be sure it is insured and packaged securely.

TO OBTAIN SUPPLY, ACCESSORY OR PRODUCT INFORMATION, CALL
1-800-BE-SHARP OR VISIT www.sharppusa.com.

Save the proof of purchase as it is needed should your oven ever require warranty service.

PRODUCT INFORMATION CARD

The product information card which is on the inside of the microwave oven carton should be completed within ten days of purchase and returned. We will keep it on file and help you access the information in case of loss, damage or theft. This will also enable us to contact you in the unlikely event that any adjustments or modifications are ever required for your oven.

IMPORTANT SAFETY INSTRUCTIONS

When using electrical appliances basic safety precautions should be followed, including the following:

WARNING - To reduce the risk of burns, electric shock, fire, injury to persons or exposure to excessive microwave energy:

1. **Read all instructions before using the appliance.**
2. Read and follow the specific **“PRECAUTIONS TO AVOID POSSIBLE EXPOSURE TO EXCESSIVE MICROWAVE ENERGY”** on inside front cover.
3. This appliance must be grounded. Connect only to properly grounded outlet. See **“GROUNDING INSTRUCTIONS”** on page 3.
4. Install or locate this appliance only in accordance with the provided installation instructions.
5. Some products such as whole eggs and sealed containers—for example, closed glass jars—are able to explode and should not be heated in this oven.
6. Use this appliance only for its intended use as described in this manual. Do not use corrosive chemicals or vapors in this appliance. This type of oven is specifically designed to heat, cook or dry food. It is not designed for industrial or laboratory use.
7. As with any appliance, close supervision is necessary when used by children.
8. Do not operate this appliance if it has a damaged cord or plug, if it is not working properly or if it has been damaged or dropped.
9. This appliance should be serviced only by qualified service personnel. Contact nearest Sharp Authorized Servicer for examination, repair or adjustment.
10. Do not cover or block any openings on the appliance.
11. Do not store or use this appliance outdoors. Do not use this product near water—for example, near a kitchen sink, in a wet basement, near a swimming pool or similar locations.
12. Do not immerse cord or plug in water.
13. Keep cord away from heated surfaces.
14. Do not let cord hang over edge of table or counter.
15. See door surface cleaning instructions on page 22.
16. To reduce the risk of fire in the oven cavity:
 - a. Do not overcook food. Carefully attend appliance when paper, plastic or other combustible materials are placed inside the oven to facilitate cooking.
 - b. Remove wire twist-ties from paper or plastic bags before placing bag in oven.
 - c. **If materials inside the oven ignite, keep oven door closed, turn oven off and disconnect the power cord or shut off power at the fuse or circuit breaker panel.**
 - d. Do not use the cavity for storage purposes. Do not leave paper products, cooking utensils or food in the cavity when not in use.
17. Liquids, such as water, coffee or tea are able to be overheated beyond the boiling point without appearing to be boiling. Visible bubbling or boiling when the container is removed from the microwave oven is not always present. **THIS COULD RESULT IN VERY HOT LIQUIDS SUDDENLY BOILING OVER WHEN A SPOON OR OTHER UTENSIL IS INSERTED INTO THE LIQUID.** To reduce the risk of injury to persons:
 - a. Do not overheat the liquid.
 - b. Stir the liquid both before and halfway through heating it.
 - c. Do not use straight-sided containers with narrow necks. Use a wide-mouthed container.
 - d. After heating, allow the container to stand in the microwave oven at least for 20 seconds before removing the container.
 - e. Use extreme care when inserting a spoon or other utensil into the container.
18. If the oven light fails, consult a SHARP AUTHORIZED SERVICER.
19. Do not operate any heating or cooking appliance beneath this appliance.
20. Do not mount unit over or near any portion of a heating or cooking appliance.
21. Do not mount over a sink.
22. Do not store anything directly on top of the appliance surface when the appliance is in operation.

SAVE THESE INSTRUCTIONS

INSTALLATION INSTRUCTIONS

Unpacking and Examining Your Oven

Remove:

1. all packing materials from inside the oven cavity; however, **DO NOT REMOVE THE WAVEGUIDE COVER**, which is located on the right cavity wall. Read enclosures and **SAVE** the Operation Manual.

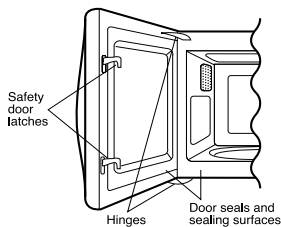

2. the feature sticker, if there is one, from the outside of the door.

Check the oven for any damage, such as misaligned or bent door, damaged door seals and sealing surfaces, broken or loose door hinges and latches and dents inside

the cavity or on the door. If there is any damage, do not operate the oven and contact your dealer or SHARP AUTHORIZED SERVICER.

Choosing a Location for Your Oven

You will use your oven frequently so plan its location for ease of use. The oven must be placed

on a countertop which is a minimum of 36 inches from the floor. Allow at least 2 inches on the sides, top and at the rear of the oven for air circulation. Be sure to position oven so that the rear cannot be touched inadvertently.

Do not place or install the oven in any area where heat and steam are generated; for example, next to or above a conventional gas or electric range or above a conventional wall oven. Heat and steam may damage the electronics or the mechanical parts of the oven.

Built-in Kit

Your oven can be built into a cabinet or wall—not near or above a heat source—using Sharp's Built-in Kit, Model RK-82K(black). If your dealer does not stock the kit, it can be ordered directly from the Sharp Accessories and Supplies Center. Have your credit card number available and call toll-free: 1-800-642-2122 for ordering the kit to be sent to your address.

The kit includes ducts and finish trim strips and easy-to-follow instructions for installation as well as the location of the power supply.

GROUNDING INSTRUCTIONS

This appliance must be grounded. This oven is equipped with a cord having a grounding wire with a grounding plug. It must be plugged into a wall receptacle that is properly installed and grounded in accordance with the National Electrical Code and local codes and ordinances. In the event of an electrical short circuit, grounding reduces risk of electric shock by providing an escape wire for the electric current.

WARNING – Improper use of the grounding plug can result in a risk of electric shock.

Electrical Requirements

The electrical requirements are a 120 volt 60 Hz, AC only, 15 amp. or more protected electrical supply. It is recommended that a separate circuit serving only this appliance be provided.

The oven is equipped with a 3-prong grounding plug. It must be plugged into a wall receptacle that is properly installed and grounded. Should you only have a 2-prong outlet, have a qualified electrician install a correct wall receptacle.

A 3-prong adapter may be purchased and used temporarily if local codes allow. Follow package directions.

A short power-supply cord is provided to reduce risk of becoming entangled in or tripping over a longer cord.

Extension Cord

If it is necessary to use an extension cord, use only a 3-wire extension cord that has a 3-blade grounding plug and a 3-slot receptacle that will accept the plug on the microwave oven. The marked rating of the extension cord should be AC 115-120 volt, 15 amp. or more.

Be careful not to drape the cord over the countertop or table where it can be pulled on by children or tripped over accidentally.

- Notes:**
1. If you have any questions about the grounding or electrical instructions, consult a qualified electrician or service person.
 2. Neither Sharp nor the dealer can accept any liability for damage to the oven or personal injury resulting from failure to observe the correct electrical connection procedures.

Radio or TV Interference

Should there be any interference caused by the microwave oven to your radio or TV, check that the microwave oven is on a different electrical circuit, relocate the radio or TV as far away from the oven as feasible or check position and signal of receiving antenna.

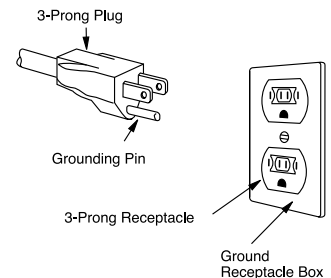

Permanent and Correct Installation

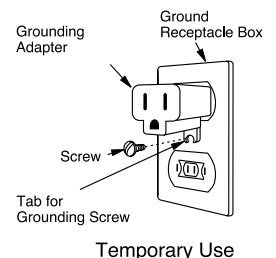

INFORMATION YOU NEED TO KNOW

ABOUT YOUR OVEN

This Operation Manual is valuable: read it carefully and always save it for reference.

A good microwave cookbook is a valuable asset. Check it for microwave cooking principles, techniques, hints and recipes. See pages 38 and 39 for ordering the Sharp Carousel Microwave Cookbook.

NEVER use the oven without the turntable and support nor turn the turntable over so that a large dish could be placed in the oven. The turntable will turn both clockwise and counterclockwise.

ALWAYS have food in the oven when it is on to absorb the microwave energy.

When using the oven at power levels below 100%, you may hear the magnetron cycling on and off. It is normal for the exterior of the oven to be warm to the touch when cooking or reheating.

Condensation is a normal part of microwave cooking. Room humidity and the moisture in food will influence the amount of moisture that condenses in the oven.

Generally, covered foods will not cause as much condensation as uncovered ones. Vents on the oven back must not be blocked.

After using **convection, grill, roast, AutoBake, AutoPizza, AutoGrill or AutoRoast**, you will hear the sound of the cooling fan. The fan may operate depending on the oven temperature.

Be aware that, unlike microwave-only ovens, convection microwave ovens have a tendency to become hot.

The oven is hot whenever the top grill, both grill or convection symbols are lighted in the display ().

The oven is for food preparation only. It should not be used to dry clothes or newspapers.

Your oven is rated 900 watts by using the IEC Test Procedure method. In using recipes or package directions, check food a minute or two before the minimum time and add time accordingly.

ABOUT FOOD

FOOD	DO	DON'T
Eggs, sausages, nuts, seeds fruits & vegetables	<ul style="list-style-type: none"> • Puncture egg yolks before cooking to prevent "explosion". • Pierce skins of potatoes, apples, squash, hot dogs and sausages so that steam escapes. 	<ul style="list-style-type: none"> • Cook eggs in shells. • Reheat whole eggs. • Dry nuts or seeds in shells.
POPCORN	<ul style="list-style-type: none"> • Use specially bagged popcorn for the microwave oven. • Listen while popping corn for the popping to slow to 1 or 2 seconds or use special Popcorn pad. • Use an overturned 9 or 10 inch oven proof glass pie plate on top of the turntable when popping bagged microwave popcorn. 	<ul style="list-style-type: none"> • Pop popcorn in regular brown bags or glass bowls. • Exceed maximum time on popcorn package.
Baby food	<ul style="list-style-type: none"> • Transfer baby food to small dish and heat carefully, stirring often. Check temperature before serving. • Put nipples on bottles after heating and shake thoroughly. "Wrist" test before feeding. 	<ul style="list-style-type: none"> • Heat disposable bottles. • Heat bottles with nipples on. • Heat baby food in original jars.
General	<ul style="list-style-type: none"> • Cut baked goods with filling after heating to release steam and avoid burns. • Stir liquids briskly before and after heating to avoid "eruption". • Use deep bowl, when cooking liquids or cereals, to prevent boilovers. 	<ul style="list-style-type: none"> • Heat or cook in closed glass jars or air tight containers. • Can in the microwave as harmful bacteria may not be destroyed. • Deep fat fry. • Dry wood, gourds, herbs or wet papers.

ABOUT UTENSILS AND COVERINGS

It is not necessary to buy all new cookware. Many pieces already in your kitchen can be used successfully in your new convection microwave oven. The chart below will help you decide what utensils and coverings should be used in each mode. Make sure the utensil does not touch the interior walls during cooking.

Utensils and Coverings	Microwave Only	Convection Grill	Roast
Aluminum foil	Yes Small flat pieces of aluminum foil placed smoothly on food can be used to shield areas from cooking or defrosting too quickly. Keep foil at least 1 inch from walls of oven.	Yes For shielding	Yes For shielding
Aluminum containers	Yes Can be used if 3/4 filled with food. Keep 1 inch away from walls and do not cover with foil.	Yes Grill-No cover	Yes Can be used if 3/4 filled with food. Keep 1 inch away from walls and do not cover with foil.
Browning dish	Yes Do not exceed recommended preheating time. Follow manufacturer's directions.	No	No
Glass ceramic (Pyroceram.®)	Yes Excellent	Yes Excellent	Yes Excellent
Glass, heat-resistant	Yes Excellent. Overturned pie plate necessary for popping popcorn.	Yes Excellent	Yes Excellent
Glass, non-heat-resistant	No	No	No
Lids, glass	Yes	Yes Grill-No cover	Yes
Lids, metal	No	Yes Grill-No cover	No
Metal cookware	No	Yes	Yes Do not use metal covering.
Metal, misc: dishes with metallic trim, screws, bands, handles. Metal twist ties	No	No	No
Oven cooking bags	Yes Good for large meats or foods that need tenderizing. DO NOT use metal twist ties.	Yes Grill-No	Yes DO NOT use metal twist ties.
Paper plates	Yes For reheating	No	No
Paper towels	Yes To cover for reheating and cooking. Do not use recycled paper towels which may contain metal filings.	No	No
Paper, ovenable	Yes	Yes For temperatures up to 400°F.	Yes For temperatures up to 400°F.
Microwave-safe plastic containers	Yes Use for reheating and defrosting. Some microwave-safe plastics are not suitable for cooking foods with high fat and sugar content. Follow manufacturer's directions.	No	No
Plastic, Thermoset®	Yes	Yes Are heat resistant up to 425°F	Yes
Plastic wrap	Yes Use brands specially marked for microwave use. DO NOT allow plastic wrap to touch food. Vent so steam can escape.	No	No
Pottery, porcelain stoneware	Yes Check manufacturer's recommendation for being microwave safe.	Yes	Yes Must be microwave safe AND ovenable.
Styrofoam	Yes For reheating	No	No
Wax paper	Yes Good covering for cooking and reheating	No	No
Wicker, wood, straw	Yes May be used for short periods of time. Do not use with high fat or high sugar content foods. Could char.	No	No

DISH CHECK. If you wish to check if a dish is safe for microwaving, place the empty dish in the oven and microwave on HIGH for 30 seconds. If the dish becomes very hot, do NOT use it for microwaving.

ACCESSORIES There are many microwave accessories available for purchase. Evaluate carefully before you purchase so that they meet your needs. A microwave-safe thermometer will assist you in determining correct doneness and assure you that foods have been cooked to safe temperatures when using microwave-only cooking. Sharp is not responsible for any damage to the oven when accessories are used.

ABOUT CHILDREN AND THE MICROWAVE

Children below the age of 7 should use the microwave oven with a supervising person very near to them. Between the ages of 7 and 12, the supervising person should be in the same room.

The child must be able to reach the oven comfortably; if not, he/she should stand on a sturdy stool.

At no time should anyone be allowed to lean or swing on the oven door.

Children should be taught all safety precautions: use potholders, remove coverings carefully, pay special attention to packages that crisp food because they may be extra hot.

Don't assume that because a child has mastered one cooking skill he/she can cook everything.

Children need to learn that the microwave oven is not a toy. See page 20 for Child Lock feature.

ABOUT MICROWAVE COOKING

- Arrange food carefully. Place thickest areas towards outside of dish.
- Watch cooking time. Cook for the shortest amount of time indicated and add more as needed. Food severely overcooked can smoke or ignite.
- Cover foods while cooking. Check recipe or cookbook for suggestions: paper towels, wax paper, microwave plastic wrap or a lid. Covers prevent spattering and help foods to cook evenly.
- Shield with small flat pieces of aluminum foil any thin areas of meat or poultry to prevent overcooking before dense, thick areas are cooked thoroughly.
- Stir foods from outside to center of dish once or twice during cooking, if possible.
- Turn foods over once during microwaving to speed cooking of such foods as chicken and hamburgers. Large items like roasts must be turned over at least once.
- Rearrange foods such as meatballs halfway through cooking both from top to bottom and from the center of the dish to the outside.
- Add standing time. Remove food from oven and stir, if possible. Cover for standing time which allows the food to finish cooking without overcooking.
- Check for doneness. Look for signs indicating that cooking temperatures have been reached.
 - Doneness signs include:**
 - Food steams throughout, not just at edge.
 - Center bottom of dish is very hot to the touch.
 - Poultry thigh joints move easily.
 - Meat and poultry show no pinkness.
 - Fish is opaque and flakes easily with a fork.

ABOUT SAFETY

- Check foods to see that they are cooked to the United States Department of Agriculture's recommended temperatures.

TEMP	FOOD
160°F	... for fresh pork, ground meat, boneless white poultry, fish, seafood, egg dishes and frozen prepared food.
165°F	... for leftover, ready-to-reheat refrigerated, and deli and carry-out "fresh" food.
170°F	... white meat of poultry.
180°F	... dark meat of poultry.

To test for doneness, insert a meat thermometer in a thick or dense area away from fat or bone. NEVER leave the thermometer in the food during cooking, unless it is approved for microwave oven use.

- ALWAYS use potholders to prevent burns when handling utensils that are in contact with hot food. Enough heat from the food can transfer through utensils to cause skin burns.
- Avoid steam burns by directing steam away from the face and hands. Slowly lift the farthest edge of a dish's covering and carefully open popcorn and oven cooking bags away from the face.
- Stay near the oven while it's in use and check cooking progress frequently so that there is no chance of overcooking food.
- NEVER use the cavity for storing cookbooks or other items.
- Select, store and handle food carefully to preserve its high quality and minimize the spread of foodborne bacteria.
- Keep waveguide cover clean. Food residue can cause arcing and/or fires.
- Use care when removing items from the oven so that the utensil, your clothes or accessories do not touch the safety door latches.
- Keep aluminum foil used for shielding at least 1 inch away from walls, ceiling and door.
- Use potholders and be careful when using convection, grill, roast, CompuBake, CompuPizza, CompuGrill or CompuRoast as cabinet, interior and door may be too hot to touch.

PART NAMES

MICROWAVE OVEN PARTS

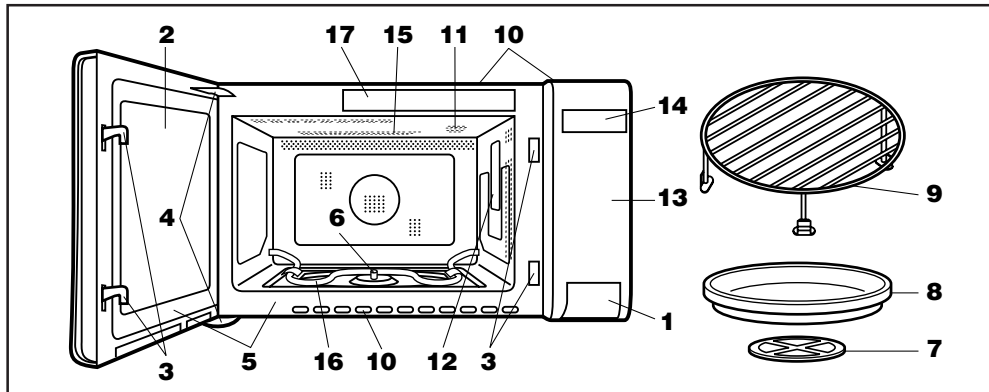

- | | |
|--|---|
| <p>1 One touch door open button
Push to open door.</p> <p>2 Oven door with see-through window</p> <p>3 Safety door latches
The oven will not operate unless the door is securely closed.</p> <p>4 Door hinges</p> <p>5 Door seals and sealing surfaces</p> <p>6 Turntable motor shaft</p> <p>7 Removable turntable support
Carefully place the turntable support in the center of the oven floor.</p> <p>8 Removable turntable
Place the turntable on the turntable support securely. The turntable will rotate clockwise or counterclockwise.</p> | <p>9 Rack
Place on the turntable.
The rack is designed especially for use in this oven only for convection, roast or grill cooking. DO NOT USE FOR MICROWAVE ONLY COOKING. Do not substitute a similar rack for this specially designed one.</p> <p>10 Ventilation openings</p> <p>11 Oven light
It will light when oven is operating or door is open.</p> <p>12 Waveguide cover: DO NOT REMOVE.</p> <p>13 Auto-Touch control panel</p> <p>14 Time display: 99 minutes, 99 seconds</p> <p>15 Top heater</p> <p>16 Bottom heater</p> <p>17 Menu label</p> |
|--|---|

NOTE: Whenever the top heater, bottom heater or convection symbols are lighted in the display, the oven may become very hot. Use caution when removing any item from the oven. Use heavy potholders or oven mitts.

INTERACTIVE DISPLAY

1. TOP HEATER SYMBOL
The symbol will light when the top heater is in use.

2. BOTTOM HEATER SYMBOL
The symbol will light when the bottom heater is in use.

3. CONVECTION SYMBOL
The symbol will light during convection cooking.

1 2 3

The two-line, Interactive Display spells out operating steps and shows cooking hints. When HELP is lighted in the display, touch the Custom Help pad to read a specific hint which may assist you.

PART NAMES

R-820J

R-820B

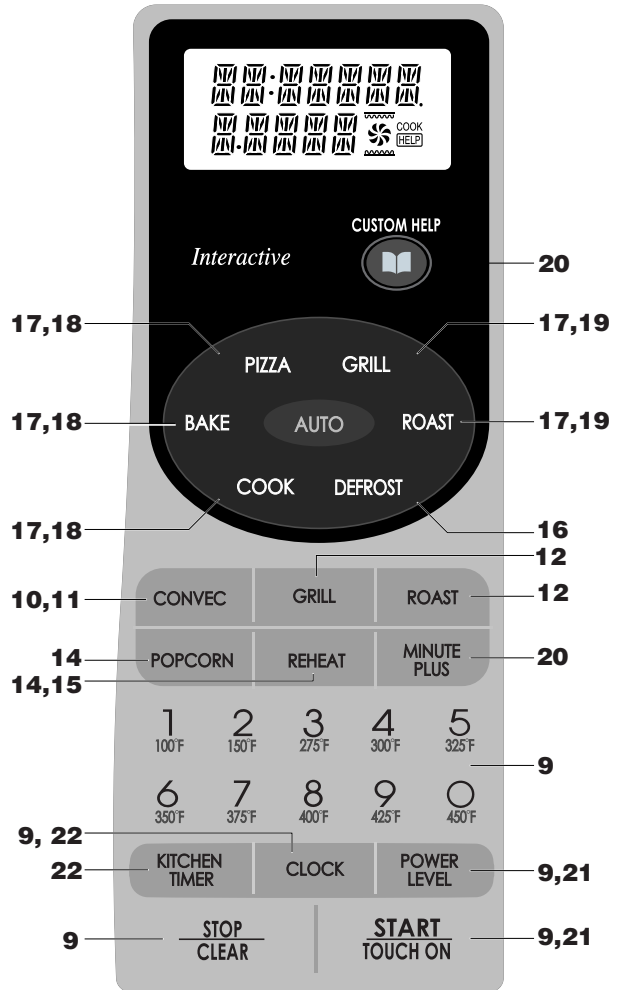
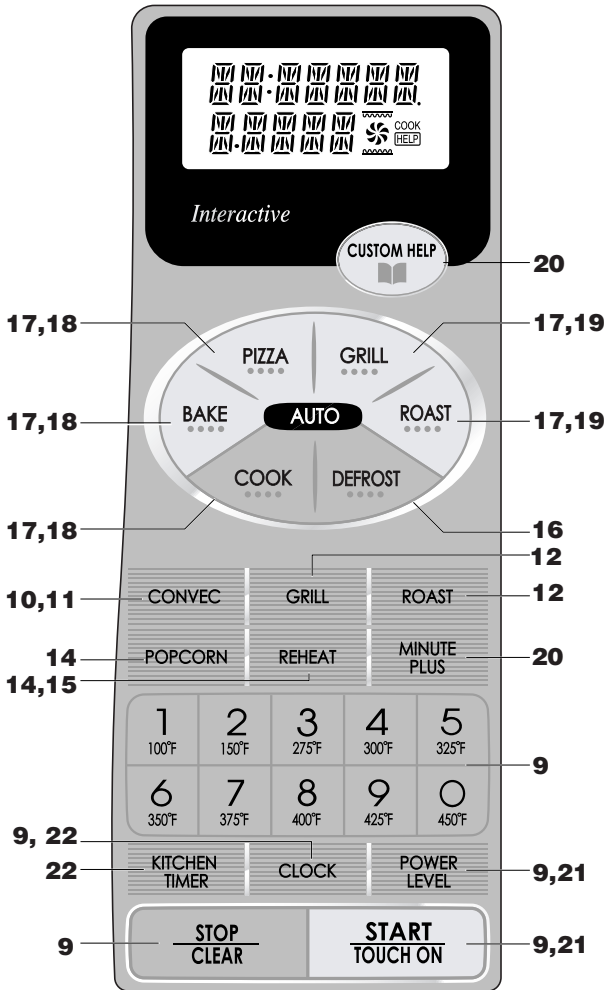

Number next to the control panel illustration indicates page on which there are a feature description and usage information.

BEFORE OPERATING

- Before operating your new microwave oven make sure you read and understand this operation manual completely.
- Before the oven can be used, follow these procedures:
 1. Plug in the oven. Close the door. The oven display will show SHARP SIMPLY THE BEST PRESS CLEAR AND PRESS CLOCK.
 2. Touch the Stop/Clear pad.
: will appear.
 3. Set clock.

TO SET THE CLOCK

- Suppose you want to enter the correct time of day 12:30 (A.M. or P.M.).

PROCEDURE	DISPLAY
1 CLOCK Touch Clock pad.	<div style="border: 1px solid black; padding: 2px; text-align: center;">ENTER</div> <div style="border: 1px solid black; padding: 2px; text-align: center;">TIME OF DAY</div>
2 1 2 3 0 Enter the correct time of day by touching the numbers in sequence.	<div style="border: 1px solid black; padding: 2px; text-align: center;">12:30</div>
3 CLOCK Touch Clock pad again.	<div style="border: 1px solid black; padding: 2px; text-align: center;">12:30</div>

This is a 12 hour clock. If you attempt to enter an incorrect clock time, ERROR will appear in the display. Touch the Stop/Clear pad and re-enter the time.

- If the electrical power supply to your microwave oven should be interrupted, the display will intermittently show SHARP SIMPLY THE BEST PRESS CLEAR AND PRESS CLOCK after the power is reinstated. If this occurs during cooking, the program will be erased. The time of day will also be erased. Simply touch Stop/Clear pad and reset the clock for the correct time of day.

NOTE: Your oven can be programmed with the door open except for Start/Touch On and Minute Plus.

STOP/CLEAR

Touch the Stop/Clear pad to:

1. Erase if you make a mistake during programming.
2. Cancel kitchen timer.
3. Stop the oven temporarily during cooking.
4. Return the time of day to the display.
5. Cancel a program during cooking, touch twice.

MANUAL OPERATION

MICROWAVE COOKING

Your oven can be programmed for 99 minutes 99 seconds (99.99). Always enter the seconds after the minutes, even if they are both zeros.

- Suppose you want to cook for 5 minutes at 100%.

PROCEDURE	DISPLAY
1 5 0 0 Enter cooking time.	<div style="border: 1px solid black; padding: 2px; text-align: center;">5.00</div>
2 START TOUCH ON Touch Start/ Touch On pad.	<div style="border: 1px solid black; padding: 2px; text-align: center;">5.00_{COOK}</div>

There are eleven preset power levels.

Using lower power levels increases the cooking time which is recommended for foods such as cheese, milk and long slow cooking of meats. Consult cookbook or recipes for specific recommendations.

TOUCH POWER LEVEL PAD ONCE THEN TOUCH	APPROXIMATE PERCENTAGE OF POWER	COMMON WORDS FOR POWER LEVELS
Power Level	100%	High
9	90%	
8	80%	
7	70%	Medium High
6	60%	
5	50%	Medium
4	40%	
3	30%	Med Low/Defrost
2	20%	
1	10%	Low
0	0%	

- Suppose you want to cook for 5 minutes at 30%.

PROCEDURE	DISPLAY
1 5 0 0 Enter cooking time.	<div style="border: 1px solid black; padding: 2px; text-align: center;">5.00</div>
2 POWER LEVEL 3 Touch Power Level pad. Enter power level.	<div style="border: 1px solid black; padding: 2px; text-align: center;">30 PER- CENT</div>
3 START TOUCH ON Touch Start/ Touch On pad.	<div style="border: 1px solid black; padding: 2px; text-align: center;">5.00_{COOK}</div>

You can program up to 4 automatic cooking sequences. Follow directions on page 21. Note that Power Level must be entered first when programming multiple sequences.

CONVECTION COOKING

During convection heating, hot air is circulated throughout the oven cavity to brown and crisp foods quickly and evenly. This oven can be programmed for ten different convection cooking temperatures for up to 99 minutes, 99 seconds.

The oven should not be used without the turntable in place, and it should never be restricted so that it cannot rotate. You may remove the turntable when preheating the oven and when preparing food to be cooked directly on the turntable.

Warning:

All of the oven parts, including the bottom heater as well as the rack and cooking containers, may become very hot. Use caution when removing any item from the oven. Use heavy potholders or oven mitts to PREVENT BURNS.

CONVECTION SETTINGS

SETTING

CONVECTION SETTINGS

1. Convection with preheat
2. Convection without preheat

SPECIAL CONVECTION SETTINGS

3. Cakes
4. Angel food cake
5. Yeast bread

1. To Preheat and cook with Convection

Your oven can be programmed to combine preheating and convection cooking operations. You can preheat to the same temperature as the convection temperature.

- Suppose you want to preheat to 350° F. and then cook 25 minutes at the same temperature.

PROCEDURE	DISPLAY
1 Touch Convec pad.	
2 Touch number pad for selected Convec setting.	
3 Select preheat temperature.	

4 Enter cooking time.	
5 Touch Start/Touch On pad.	
When the oven reaches the programmed temperature, a signal will sound 4 times.* The oven will stop, and directions will be displayed. Follow the indicated message.	
6 Touch Start/Touch On pad.	

- * If the oven door is not opened, the oven will automatically hold at the preheat temperature for 30 minutes. After this time has elapsed, an audible signal will sound, and the oven will turn off.

NOTE:

1. To program only preheat, touch the Start/Touch on pad after step 3. Preheating will start. When the oven reaches the programmed temperature, follow the indicated message.
2. If you are in the process of preheating and wish to check the actual oven temperature, simply touch the Convec pad. The actual oven temperature will be displayed as long as the Convec pad is touched. If the oven temperature is below 100°F at this time, will be displayed.

2. Cook with Convection without Preheat

To cook without preheat, touch 2 in step 2. Select the cooking temperature, time and press Start/Touch On pad, following the indicated message. Oven starts to cook immediately.

MANUAL OPERATION

3. 4. 5 Special Convection Settings

Your oven has pre-programmed settings which are ideal for special baking. All that is necessary is to enter cooking time. Use them as indicated to ensure baking success.

- Suppose you want to bake a cake for 20 minutes.

PROCEDURE	DISPLAY
1 <div style="border: 1px solid black; padding: 2px; display: inline-block; margin-bottom: 5px;">CONVEC</div> Touch Convec pad.	<div style="display: flex; justify-content: space-around;"> <div style="border: 1px solid black; padding: 2px;">SELECT</div> <div style="border: 1px solid black; padding: 2px;">CONVEC</div> </div> <div style="border: 1px solid black; padding: 2px; margin: 2px 0;">NUMBER</div> <div style="display: flex; justify-content: space-around;"> <div style="border: 1px solid black; padding: 2px;">SEE</div> <div style="border: 1px solid black; padding: 2px;">LABEL</div> </div>
2 <div style="border: 1px solid black; padding: 2px; display: inline-block; margin-bottom: 5px;">3</div> Select desired convec setting by touching the number pad.	<div style="border: 1px solid black; padding: 2px; margin-bottom: 5px;">CAKES</div> <div style="display: flex; justify-content: space-around;"> <div style="border: 1px solid black; padding: 2px;">ENTER</div> <div style="border: 1px solid black; padding: 2px;">COOKING TIME</div> </div>
3 <div style="display: flex; justify-content: space-around; margin-bottom: 5px;"> <div style="border: 1px solid black; padding: 2px;">2</div> <div style="border: 1px solid black; padding: 2px;">0</div> <div style="border: 1px solid black; padding: 2px;">0</div> <div style="border: 1px solid black; padding: 2px;">0</div> </div> Enter cooking time.	<div style="border: 1px solid black; padding: 5px; display: flex; align-items: center; justify-content: center;"> 20.00 HELP </div>
4 <div style="border: 1px solid black; padding: 2px; display: inline-block; margin-bottom: 5px;">START TOUCH ON</div> Touch Start/Touch On pad.	<div style="border: 1px solid black; padding: 5px; display: flex; align-items: center; justify-content: center;"> PREHEAT 350F COOK HELP </div>

When the oven reaches the temperature, a signal will sound 4 times*. The oven will stop, and directions will be displayed. Follow the indicated message.

5

START TOUCH ON

 Touch Start/ Touch On pad.

20.00
BAKE
COOK HELP

- * If the oven door is not opened, the oven will automatically hold at the preheat temperature for 30 minutes. After this time has elapsed, an audible signal will sound, and the oven will turn off.

NOTE: Should additional time be needed on the special convection settings, simply enter the additional time and touch Start/Touch On. This step must be done within 2 minutes of the original cycle end and before touching Stop/Clear.

CONVEC CHART

SETTING	OPTIONS	USED FOR
1. With preheat	Any temperature listed on number pads: 100, 150, 275, 300, 325, 350, 375, 400, 425 or 450°F.	Most baking for items requiring preheat.
2. Without preheat	Same as above	Baking when no preheating is acceptable.
3. Cakes	None	Special setting for baking cakes--especially good for bundt and tube cakes.
4. Angel food cake	None	Mix or your own recipe for angel food cake.
5. Yeast bread	None	Bread loaves and specialty shapes. May need additional time than recipe suggests if baking extra large loaves or bread made with whole grain flours.

GRILL COOKING

Your oven has two grill cooking options. Select the desired grill setting by touching the Grill pad.





It is not necessary to preheat for grill cooking.

GRILL SETTING

SETTING

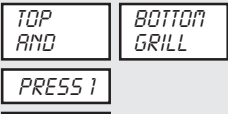
1. Top and Bottom Grill
2. Top Grill only

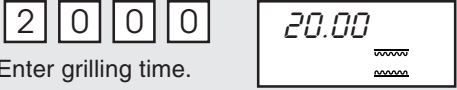
- Suppose you want to cook for 20 minutes using the top and bottom heaters.

PROCEDURE	DISPLAY
1 Touch Grill pad.	 
2 Select desired grill setting by touching the number pad.	
3 Enter grilling time.	
4 Touch Start/Touch On pad.	

Warning:

All of the oven parts, including the bottom heater as well as the rack and cooking containers, may become very hot. Use caution when removing any item from the oven. Use heavy potholders or oven mitts to PREVENT BURNS.

ROAST COOKING

Your oven has a pre-programmed setting that makes it easy to cook with both convection heat and microwave automatically.



The marriage of these two cooking methods produces juicy meats, as well as tender, flavorful poultry, all with just the right amount of browning and crispness.

ROAST SETTING

SETTING

- Oven temperature 325°F
Microwave power 30%

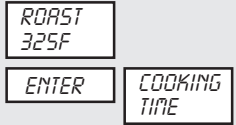
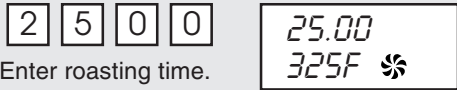
- Suppose you want to cook a roast for 25 minutes on Roast.

PROCEDURE	DISPLAY
1 Touch Roast pad.	 
2 Enter roasting time.	
3 Touch Start/Touch On pad.	

NOTE: The temperatures can be changed; however, the microwave power cannot. The oven temperature can be changed from 100°F. to 450°F. To change the temperature, touch ROAST twice. When the display says SELECT TEMP, touch desired temperature pad.

Warning:

All of the oven parts, including the bottom heater as well as the rack and cooking containers, may become very hot. Use caution when removing any item from the oven. Use heavy potholders or oven mitts to PREVENT BURNS.

Helpful Hints for Convection, Roast and Grill Cooking

Your Sharp Double Grill Convection Microwave Oven can cook any food perfectly because of the number of ways it can cook: microwave, roast (convection with microwave cooking), convection and grill. The Cooking Guides on pages 24 to 39 have excellent instructions, guidelines, hints, charts and recipes to help you get the best use of your oven. Consult them often until you are familiar with the oven.

Convection Cooking:

1. When preheating, the turntable can be left in or removed.
2. Do not cover turntable or rack with aluminum foil. It interferes with air flow that cooks food.
3. Round pizza pans are excellent cooking utensils for many convection-only items. Choose pans that do not have extended handles.
4. When baking, check for doneness after time has elapsed. If not completely done, let stand in oven a few minutes to complete cooking.

Grill Cooking

1. Using a preheated rack can give a grilled appearance to steaks, hot dogs etc.
2. Foods, such as vegetables or frozen snack foods, can be grilled directly on the turntable.

Roast Cooking

1. Meats and poultry are best when roasted directly on the rack. A shallow dish can be placed below the food if gravy is to be made from the drippings.
2. Less tender cuts can be roasted and tenderized using oven cooking bags.

NOTE: During ROAST, some metal baking utensils may cause arcing when they come in contact with the turntable, oven walls or rack. Arcing is a discharge of electricity that occurs when microwaves come in contact with metal.

SPECIAL FEATURES

POPCORN

Popcorn will automatically compute the correct cooking time and microwave power level for most brands of microwave popcorn.

- Suppose you want to pop a regular size (3.5 oz) bag of popcorn.

PROCEDURE	DISPLAY						
1							
<div style="border: 1px solid black; padding: 2px; display: inline-block;">POPCORN</div> Touch Popcorn pad.	<table border="1"> <tr> <td>REGULAR SIZE</td> <td>PRESS START</td> </tr> <tr> <td>FOR</td> <td>SNACK SIZE</td> </tr> <tr> <td>PRESS</td> <td>POPCORN AGAIN</td> </tr> </table>	REGULAR SIZE	PRESS START	FOR	SNACK SIZE	PRESS	POPCORN AGAIN
REGULAR SIZE	PRESS START						
FOR	SNACK SIZE						
PRESS	POPCORN AGAIN						

POPCORN CHART

FOOD	AMOUNT	PROCEDURE
Popcorn	1 package 3.0 - 3.5 oz (Regular) 1.5 - 1.75 oz (Snack)	Use only popcorn packaged for microwave oven use. Try several brands to decide which you like the best. Touch Popcorn, Start/Touch On for regular size bags. For snack size bags, touch Popcorn twice, Start/Touch ON. Do not try to pop unpopped kernels.

REHEAT

Reheat will automatically compute the correct warming time and microwave power level for foods shown in the chart on page 15.

- Suppose you want to use Reheat to warm 2 frozen rolls.

PROCEDURE	DISPLAY								
1									
<div style="border: 1px solid black; padding: 2px; display: inline-block;">REHEAT</div> Touch Reheat pad.	<table border="1"> <tr> <td>SELECT FOOD</td> <td>NUMBER</td> </tr> <tr> <td>SEE LABEL</td> <td></td> </tr> </table>	SELECT FOOD	NUMBER	SEE LABEL					
SELECT FOOD	NUMBER								
SEE LABEL									
2									
<div style="border: 1px solid black; padding: 2px; display: inline-block;">4</div> Select desired reheat setting by touching the number pad.	<table border="1"> <tr> <td>FRESH ROLL</td> <td>MUFFIN</td> </tr> <tr> <td>PRESS 1</td> <td></td> </tr> <tr> <td>FROZEN ROLL</td> <td>MUFFIN</td> </tr> <tr> <td>PRESS 2</td> <td></td> </tr> </table>	FRESH ROLL	MUFFIN	PRESS 1		FROZEN ROLL	MUFFIN	PRESS 2	
FRESH ROLL	MUFFIN								
PRESS 1									
FROZEN ROLL	MUFFIN								
PRESS 2									
3									
<div style="border: 1px solid black; padding: 2px; display: inline-block;">2</div> Touch 2 to warm frozen rolls/muffins.	<table border="1"> <tr> <td>HOW MANY</td> <td>NUMBER</td> </tr> <tr> <td>ENTER</td> <td></td> </tr> </table>	HOW MANY	NUMBER	ENTER					
HOW MANY	NUMBER								
ENTER									
4									
<div style="border: 1px solid black; padding: 2px; display: inline-block;">2</div> If you want to warm 2 rolls/muffins, touch 2.	<table border="1"> <tr> <td>2</td> <td>PRESS START</td> </tr> </table>	2	PRESS START						
2	PRESS START								

2 START TOUCH ON

Touch Start/Touch On pad. The oven will count down. The display will indicate END when cooking is complete.

NOTE:

1. Popcorn can be programmed with More or Less Time Adjustment. Touch the Power Level pad once or twice before pressing Start/Touch On pad. See page 21.
2. Popcorn has a cooking hint. Touch Custom Help when the HELP indicator is lighted in the display.
3. Use an overturned 9 or 10 inch oven proof glass pie plate on top of the turntable when popping bagged microwave popcorn.

5 START TOUCH ON

Touch Start/Touch On pad. The oven will count down. The display will indicate END when warming is complete.

NOTE:

1. Reheat can be programmed with More or Less Time Adjustment. Touch the Power Level pad once or twice after selecting the amount. See page 21.
2. Each food has a cooking hint. Touch Custom Help when the HELP indicator is lighted in the display.
3. Should you attempt to enter more or less than the allowed amount, an error message will appear in the display. More or less than the quantity listed in the chart should be cooked following the guidelines in any microwave book.
4. The final cooking result will vary according to the food condition (e.g. initial temperature, shape, quality). Check food for temperature after reheating. If additional time is needed, continue to reheat manually.

SPECIAL FEATURES

REHEAT CHART











FOOD	AMOUNT	PROCEDURE
1. Casserole	1 - 4 cups	Use this setting to reheat refrigerated canned or homemade pasta with sauce or other cooked casserole. For room temperature pasta or casserole, use Less option. For pasta without sauce double the quantity per setting. For example, measure 2 cups of cooked noodles and program for 1 cup. Cover with lid or plastic wrap. After cooking, let stand, covered, 2 to 3 minutes.
2. Dinner Plate	1 plate	Use this setting to reheat precooked foods from the refrigerator. Place meaty portions and bulky vegetables to outside of plate. Cut large items like baked potatoes in smaller pieces. Flatten foods such as mashed potatoes and other dense foods. Cover with wax paper or plastic wrap. ONE PLATE ONLY. After cooking, check that food is very hot throughout and that the bottom center of the plate is very hot. If not, continue heating using time and power level. Allow to stand, covered, 1 to 2 minutes.
	1 Regular	Touch 2 once after selecting Dinner Plate for a regular amount of food: approximately 4 oz. sliced meat or poultry, 1/2 cup potato or rice and 1/2 cup of vegetables or equivalent.
	1 Large	Touch 2 twice after selecting Dinner Plate for a larger amount of food on a dinner plate.
	1 Small	Touch 2 three times after selecting Dinner Plate for a smaller amount of food on a dinner plate.
3. Beverage, reheat	.5 - 2.0 cups	This setting is good for restoring cooled beverage to a better drinking temperature. Touch number 1 for reheat; then continue to touch number 1 for a .5 cup increase per touch. Stir after reheating.
Beverage, make coffee/tea	1 - 4 cups	Use this setting for heating COLD TAP WATER to a temperature somewhat below the boiling point to make instant coffee or tea. Touch number 2 to make coffee/tea; then continue to touch number 2 for a 1 cup increase per touch. Stir liquid briskly before and after heating to avoid "eruption".
4. Roll/muffin, fresh	1 - 6	Use this setting to warm rolls, muffins, biscuits, bagels, etc. Large items should be considered as 2 or 3 regular size. For refrigerated rolls or muffins, it may be necessary to double the entered amount to ensure the proper serving temperature. For example, enter quantity of 2 for 1 refrigerated muffin or roll. Arrange on plate; cover with paper towel.
Roll/muffin, frozen	1 - 6	Use this setting to warm rolls, muffins, biscuits, bagels, etc. Large item should be considered as 2 or 3 regular size. Arrange on plate; cover with paper towel.
5. Frozen entrees	6 - 17 oz.	Use for frozen convenience foods. It will give satisfactory results for most bands. You may wish to try several and choose your favorite. Remove package from outer wrapping and follow package directions for covering. Touch 5 for frozen entrees; continue to touch number 5 until ounces in display match package weight. After cooking, let stand, covered, for 1 to 3 minutes.

SPECIAL FEATURES

AUTO DEFROST

AutoDefrost automatically defrosts all the foods found in the AutoDefrost Chart below.

- Suppose you want to defrost a 2.0 pound steak.

PROCEDURE	DISPLAY
1  Touch Auto Defrost pad once.	 
2  Touch number 2 pad to select steak.	 
3   Enter weight by touching the number pads 2 and 0. (Ex: 2.0 lb steak.)	 
4  Touch Start/Touch On pad. The oven will stop and directions will be displayed. Follow the indicated message.	

- 5** After the 1st stage, open the door. Turn steak over and shield any warm portions. Close the door.

Touch Start/
Touch On pad.



- 6** After the 2nd stage, open the door. Shield any warm portions. Close the door.

Touch Start/
Touch On pad.



- 7** After defrost cycle ends, follow the directions.

NOTE:

1. To defrost other food or foods above or below the weights allowed on the AutoDefrost Chart, use time and 30% power. See Manual Defrost on page 21
2. AutoDefrost can be programmed with More or Less Time Adjustment. Touch the Power Level pad once or twice after entering the weight or quantity. See page 21.
3. Touch Custom Help when the HELP indicator is lighted in the display for a helpful hint.
4. If you attempt to enter more or less than the amount as indicated in the chart below, an error message will appear in the display.

AUTO DEFROST CHART

FOOD	AMOUNT	PROCEDURE
1. Ground meat	.5 - 3.0 lb	Remove any thawed pieces after each stage. Let stand, covered, for 5 to 10 minutes.
2. Steaks, chops fish	.5 - 4.0 lb	After each stage, rearrange and if there are warm or thawed portions, shield with small flat pieces of aluminum foil. Remove any meat or fish that is almost defrosted. Let stand, covered, for 10 to 20 minutes.
3. Chicken pieces	.5 - 3.0 lb	After each stage, rearrange pieces or remove portions should they become warm or thawed. Let stand, covered, for 10 to 20 minutes.
4. Roast	2.0 - 4.0 lb	Start defrosting with fat side down. After each stage, turn roast over and shield the warm portions with aluminum foil. Let stand, covered, for 30 to 60 minutes.
5. Casserole	2 - 6 cups	After audible signal, stir if possible. At end, stir well and let stand, covered, for 5 to 10 minutes.

NOTE: Check foods when oven signals. After final stage, small sections may still be icy. Let stand to continue thawing. Do not defrost until all ice crystals are thawed.













Shielding prevents cooking from occurring before the center of the food is defrosted. Use small smooth strips of aluminum foil to cover edges and thinner sections of the food.

SPECIAL FEATURES

AUTO COOK / BAKE / PIZZA / GRILL / ROAST

All of the Auto settings take the guesswork out of preparing many popular foods. Each food is cooked using the best cooking method and the proper cooking time.

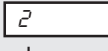
- Suppose you want to use AutoCook to cook 2 baked potatoes.

PROCEDURE	DISPLAY
1  Touch Auto Cook pad.	  
2  Touch 1 to cook baked potatoes.	    
 If you want to cook 2 baked potatoes, touch 2.	 
3  Touch Start/Touch On pad. The oven will count down. The display will indicate <i>LET STAND COVERED</i> when cooking is complete.	

NOTE:

1. These features can be programmed with More or Less Time Adjustment. Touch the Power Level pad once or twice after selecting the amount. See page 21.
2. Each food has a cooking hint. Touch Custom Help when the HELP indicator is lighted in the display.
3. Should you attempt to enter more or less than the allowed amount, an error message will appear in the display.
 More or less than the quantity listed in the chart should be cooked following the guidelines in any microwave book.
4. The final cooking result will vary according to the food condition (e.g. initial temperature, shape, quality). Check food for temperature after cooking. If additional time is needed, continue to cook manually.

Warning :

Whenever the top heater, bottom heater or convection symbols are lighted in the display, the oven may become very hot. Use caution when removing any item from the oven. Use heavy potholders or oven mitts.

AUTO COOK CHART

FOOD	AMOUNT	PROCEDURE
1. Baked potatoes	1 - 4 medium	Pierce. Place on paper-towel-lined turntable. After cooking, remove from oven, wrap in aluminum foil and let stand 5 to 10 minutes.
2. Vegetables, fresh	1 - 4 cups	For beans, carrots, corn and peas, add 1 tablespoon of water per cup. For broccoli, Brussels sprouts, cabbage and cauliflower, cook immediately after washing with no additional water. Cover with lid for tender vegetables or use plastic wrap or wax paper if you want crisper vegetables. If you like tender crisp vegetables, double or triple measured quantity per setting. For example, use 2 cups or 3 cups of zucchini but only select 1 cup. After cooking, remove from oven, stir, cover and let stand 3 to 5 minutes before serving.
3. Vegetables, frozen	1 - 4 cups	Add no water, Cover with lid or plastic wrap. After cooking, stir and let stand, covered, for 3 minutes.
4. Ground meat	.3 - 1.5 lb	Use this setting to cook ground beef or turkey as patties or in a casserole to be added to other ingredients. Place patties on a microwave-safe rack and cover with wax paper. Place ground meat in a casserole and cover with wax paper or plastic wrap. When oven stops, turn patties over or stir meat in casserole to break up large pieces. Re-cover and touch Start/Touch On. After cooking, let stand, covered, for 2 to 3 minutes.

SPECIAL FEATURES

AUTO COOK CHART (continued)

FOOD	AMOUNT	PROCEDURE
5. Seafood, fish	.3 - 1.5 lb	Arrange in ring around shallow glass dish (roll fillet with edges underneath). Cover with vented plastic wrap. You may wish to use the MORE setting for thicker fish steaks. After cooking, let stand, covered, for 3 minutes.

AUTO BAKE CHART

SETTING FOOD	PAN SIZE/QTY	PROCEDURE
1. French fries	.3 - 1 lb	Use frozen prepared French fries. Place on round baking sheet or directly on turntable.
2. Frozen snack	Number which fits on turntable.	Ideal setting to crisp frozen convenience foods such as waffles, French toast, pancakes, strudel etc.
3. Brownies	8" x 8" x 2"	Ideal for packaged brownie mix or your own recipe for 8" x 8" pan. Prepare according to directions and place in a greased and floured pan. After the preheat is over, place pan in the oven directly on the turntable. Cool before cutting into serving pieces.
4. Snack cake	8" x 8" x 2"	Ideal for packaged cake mix or your own recipe for 8" x 8" pan. Prepare according to directions and place in a greased and floured pan. After the preheat is over, place pan in the oven directly on the turntable. Should you discover that you like a cake more done touch Power Level once before preheating for an additional 2 minutes of baking time. Should you discover that you like a cake less done touch Power Level twice before preheating for 2 fewer minutes of baking time. Cool before frosting and serving.
5. Biscuits	8 - 10 (1 package of convenience biscuits)	Ideal for refrigerated convenience biscuits or your own recipe. Place in round baking pan or on round baking sheet. After preheating, place pan directly on turntable.

AUTO PIZZA CHART

SETTING FOOD	QUANTITY	PROCEDURE
1. Bake frozen pizza regular crust	1	Remove from package and unwrap. Place directly on the turntable. Setting is for 10" to 12" diameter. Touch Power Level twice for LESS if baking a 7" diameter pizza.
2. Bake frozen pizza rising crust	1	Remove from package and unwrap. Place directly on the turntable. Setting is for 10" to 12" diameter plain cheese pizza. Touch Power Level once for MORE if baking rising crust pizza with toppings. Touch Power Level twice before touching Start/Touch On for LESS if baking 7" diameter rising crust pizza.
3. Bake refrig pizza	1	Remove from package and unwrap. Place directly on the turntable.
4. Microwave pizza	1	Use for frozen microwave pizza. Remove from package unwrap. Follow package directions for use of package and/or silver crisping disk.
5. Reheat pizza	1 - 6 slices	Use for heating previously baked pizza slices. For previously baked frozen pizza, touch Power Level once before touching Start/Touch On for more time.

SPECIAL FEATURES

AUTO GRILL CHART

SETTING	FOOD	QUANTITY	PROCEDURE
1.	Hamburgers	1 - 7 (1/4 lb each)	Form patties and place on rack. Place rack on turntable.
2.	Steaks	.5 - 2 lb (.5 lb each)	Use this setting to grill steaks from 3/4" to 1" thick. Individual boneless steaks grill most evenly. Place steak on rack. Place rack on turntable. Setting is for medium doneness. To grill for well done, touch Power Level for MORE before touching Start/Touch On. To grill for rare, touch Power Level twice for LESS before touching Start/Touch On. Follow directions in the Interactive Display and turn over when directed to do so.
3.	Fish steaks	.5 - 2 lb	Use this setting to grill fish steaks from 3/4" to 1" thick. Place fish steaks on rack. Place rack on turntable.
4.	Boneless poultry	.5 - 2 lb	Use this setting for boneless chicken or turkey cutlets. Fold under any very thin ends so no overcooking occurs. Good to brush with olive oil, marinade or glaze during the cooking.
5.	Chicken pieces	.5 - 3 lb	Arrange pieces on rack. Place rack on turntable. Brush with glaze or barbecue sauce during last 10 - 15 minutes of grilling time. Follow directions in the Interactive Display and turn over when directed to do so.

AUTO ROAST CHART

SETTING	FOOD	QUANTITY	PROCEDURE
1.	Chicken, turkey (whole)	2.5 - 7 lb	Place breast side up on rack. Place rack on turntable. After roasting, remove from oven, cover with foil and let stand 5 to 10 minutes before carving and serving. Internal temperature of white meat should be 170°F. and of dark meat 180°F.
2.	Pork loin	2 - 3.5 lb	Boneless single pork loin is recommended because it cooks evenly. Place on rack. Place on turntable. After roasting, remove from oven, cover with foil and allow to stand 5 to 10 minutes before carving and serving. Internal temperature should be 160°F.
3.	Turkey breast (bone in)	3 - 6 lb	Season, if desired. Place on rack. Place on turntable. After roasting, remove from oven, cover with foil and allow to stand 10 minutes before carving and serving. Internal temperature should be 170°F.
4.	Beef eye of round (boneless)	2 - 4 lb	Season, if desired. Place on rack. Place on turntable. After roasting, remove from oven, cover with foil and allow stand 5 minutes. Setting is for medium doneness. Internal temperature should be 140 to 145°F.
5.	Cornish hens	1 - 6.5 lb	Choose similar sized hens. Place on rack breast side up. Place rack on turntable. May brush with sauce or glaze during roasting. After roasting, remove from oven, cover with foil and allow to stand 5 to 10 minutes. Internal temperature of white meat should be 170°F. and of dark meat 180°F.

OTHER CONVENIENT FEATURES

CUSTOM HELP

Custom Help provides 5 features which make using your oven easy because specific instructions are provided in the interactive display.

1. CHILD LOCK

The Child Lock prevents unwanted oven operation such as by small children. The oven can be set so that the control panel is deactivated or locked. To set, touch Custom Help, the number **1** and Start/Touch On. Should a pad be touched, LOCK ON will appear in the display.

To cancel, touch Custom Help and Stop/Clear.

2. AUDIBLE SIGNAL ELIMINATION









If you wish to have the oven operate with no audible signals, touch Custom Help, the number **2** and Stop/Clear.

To cancel and restore the audible signal, touch Custom Help, the number **2** and Start/Touch On.

3. AUTO START

If you wish to program your oven to begin cooking automatically at a designated time of day, follow this procedure:

- Suppose you want to start cooking a stew for 20 minutes on 50% at 4:30. Before setting, check to make sure the clock is showing the correct time of day.



PROCEDURE	
1 Touch Custom Help pad.	
2 Touch number 3.	
3 Enter the start time.	
4 Touch Clock pad.	
5 Enter cooking program.	  
6 Touch Start/Touch On pad.	

NOTE:

1. Auto Start can be used for manual cooking, CompuCook, or CompuRoast, if clock is set.
2. If the oven door is opened after programming Auto Start, it is necessary to touch the Start/Touch On pad for Auto Start time to appear in the readout so that the oven will automatically begin programmed cooking at the chosen Auto Start time.
3. Be sure to choose foods that can be left in the oven safely until the Auto Start time. Acorn or butternut squash are often a good choice.
4. If you wish to know the time of day, simply touch the Clock pad. As long as your finger is touching the Clock pad, the time of day will be displayed.

4. LANGUAGE SELECTION

The oven comes set for English language. To change, touch CUSTOM HELP and the number **4**. Continue to touch the number **4** until your choice is selected from the table below. Then, touch START/TOUCH ON pad.

Number 4 .	Language	Display
Once	English	
Twice	Espanol	
3 Times	French	

5. WEIGHT / TEMPERATURE SELECTION

The oven comes set for U.S. Customary Unit-pounds and Fahrenheit. You can change the unit to kgs and centigrade. To change, touch Custom Help and the number **5**. Continue to touch the number **5** until your choice is selected. Then, touch Start/Touch On.

HELP

Each setting of Special Features has a cooking hint. If you wish to check, touch Custom Help whenever HELP is lighted in the Interactive Display for these and other manual operation hints.

MINUTE PLUS

Minute Plus allows you to cook for a minute at 100% by simply touching the Minute Plus pad. You can also extend cooking time in multiples of 1 minute by repeatedly touching the Minute Plus pad during manual cooking.

- Suppose you want to heat a cup of soup for one minute.

PROCEDURE	
1 Touch Minute Plus pad.	

NOTE:

1. To use Minute Plus, touch pad within 3 minute after cooking, closing the door, touching the Stop/Clear pad or during cooking.

2. Minute Plus cannot be used with Special Features.

OTHER CONVENIENT FEATURES

MANUAL DEFROST

If the food that you wish to defrost is not listed on the AutoDefrost Chart or is above or below the limits in the "Amount" column on the AutoDefrost Chart, you need to defrost manually.

You can defrost any frozen food, either raw or previously cooked, by using Power Level 3. Follow the exact 3-step procedure found under Time Cooking on page 9. Estimate defrosting time and press 3 for 30% when you select the power level.

For either raw or previously cooked frozen food the rule of thumb is approximately 5 minutes per pound. For example, defrost 5 minutes for 1 pound of frozen spaghetti sauce.

Always stop the oven periodically to remove or separate the portions that are defrosted. If food is not defrosted at the end of the estimated defrosting time, program the oven in 1 minute increments on Power Level 3 until totally defrosted.

When using plastic containers from the freezer, defrost only long enough to remove from the plastic in order to place in a microwave-safe dish.

TOUCH ON

Touch On allows you to cook at 100% power by touching the Start/Touch On continuously. Touch On is ideal for melting cheese, bringing milk to just below boiling etc. The maximum cooking time is 3 minutes.

- Suppose you want to melt cheese on a piece of toast.

PROCEDURE

- 1** Continuously touch Start/Touch On pad. The cooking time will begin counting up. 
- 2** When the cheese is melted to desired degree, remove finger from Start/Touch On pad. Oven stops immediately.

NOTE:

1. Note time it takes for frequently cooked foods and program that time in the future.
2. Touch Start/Touch On pad within 3 minute after cooking, opening and closing the door or touching the Stop/Clear pad.
3. Touch On can only be used 3 times in a row. If more times are needed, open and close door or touch Stop/Clear.





MULTIPLE SEQUENCE COOKING

Your oven can be programmed for up to 4 automatic cooking sequences for the microwave mode and 2 automatic cooking sequences for convection, grill and roast mode, switching from one power level setting to another automatically.

Sometimes cooking directions tell you to start on one power level and then change to a different power level. Your oven can do this automatically.

- Suppose you want to cook roast beef for 5 minutes at 100% and then continue to cook for 30 minutes at 50%.

PROCEDURE

- 1** First touch Power Level pad twice for 100% power. Then enter cooking time. 

- 2** Touch Power Level pad. Touch number pad 5 for 50% power. Then enter second cooking time. 

- 3** Touch Start/Touch On pad. 

NOTE:

1. If Power Level pad is touched twice, HIGH POWER will be displayed.
2. If 100% is selected as the final sequence, it is not necessary to touch the Power Level pad.
3. If you wish to know power level, simply touch the Power Level pad. As long as your finger is touching the Power Level pad, the power level will be displayed.
4. Convection settings (No. 3, 4 and 5) cannot be programmed for multiple sequence cooking.

MORE OR LESS TIME ADJUSTMENT

Should you discover that you like any of Special Features settings slightly **more** done, touch the **Power Level** pad **once** after touching your choice of pads and before touching the Start/Touch On pad.

The display will show MORE.



Should you discover that you like any of Special Features settings slightly **less** done, touch the **Power Level** pad **twice** after touching your choice of pads and before touching the Start/Touch On pad.

The display will show LESS.

OTHER CONVENIENT FEATURES

KITCHEN TIMER

- Suppose you want to time a 3 minute long distance phone call.

PROCEDURE	
1	Touch Kitchen Timer pad. 
2	Enter time. 
3	Touch Start/Touch On pad. 

DEMONSTRATION MODE

To demonstrate, touch Clock, the number **0** and touch Start/Touch On and hold for 3 seconds. DEMO ON will appear in the display. Cooking operations and specific special features can now be demonstrated with no power in the oven. For example, touch Minute Plus and the display will show 1.00 and count down quickly to END.

To cancel, touch Clock, then the number **0** and Stop/Clear. If easier, unplug the oven from the electrical outlet and replug.

CLEANING AND CARE

Disconnect the power cord before cleaning or leave the door open to inactivate the oven during cleaning.

IMPORTANT:
Before cleaning, make sure the oven door, outer cabinet, oven cavity, air vent openings, turntable, turntable support and racks are cool.

Exterior

Clean the outside with mild soap and water. Then wipe with a clean dampened cloth and polish dry with a soft cloth. Do not use any type of household or abrasive cleaner.

Door

Wipe the window on both sides with a soft damp cloth to remove any spills or splatters. Metal parts will be easier to maintain if wiped frequently with a soft damp cloth. Avoid the use of spray and other harsh cleaners as they may stain, streak or dull the door surface.

Touch Control Panel

Wipe the panel with a soft cloth dampened slightly with water only. Dry with a soft cloth. Do not scrub or use any sort of chemical cleaners. Close door and touch Stop/Clear.

Interior

The oven should be wiped using hot soapy water and a sponge or soft cloth whenever splatters occur. Polish dry. You can hold the bottom heater up while cleaning under it. After cleaning, return it to the oven bottom.

For heavy stains, it may be necessary to use an oven cleaning gel; use only on the stainless steel interior of the oven. Follow the cleaner's directions exactly, always being sure to wipe using a sponge or soft cloth until all traces of cleaner are removed and then polish dry with a soft cloth.

DO NOT USE ABRASIVES OR SCOURING PADS ON YOUR OVEN AS THEY MAY SCRATCH. NEVER SPRAY OVEN CLEANERS DIRECTLY ON ANY PART OF YOUR OVEN.

After cleaning the interior thoroughly, residual grease may be removed from the interior ducts and heater by simply operating the oven on 450 °F. for 20 minutes without food. Ventilate the room if necessary.

Waveguide Cover

The waveguide cover is made from mica so requires special care. Keep the waveguide cover clean to assure good oven performance. Carefully wipe with a soft damp cloth any food splatters from the surface of the cover immediately after they occur. Built-up splashes may over-heat and cause smoke or possibly catch fire. Do not remove the waveguide cover.

Odor Removal

Occasionally, a cooking odor may remain in the oven. To remove, combine 1 cup water, grated peel and juice of 1 lemon and several whole cloves in a 2-cup glass measuring cup. Boil for several minutes using 100% power. Allow to set in oven until cool. Wipe interior with a soft cloth.

Turntable/Turntable Support/Rack

The turntable, turntable support and rack can be removed for easy cleaning. Wash them in mild, sudsy water; for stubborn stains use a mild cleanser and non-abrasive scouring sponge. They are also dishwasher-proof. Use upper rack of dishwasher for turntable support. Foods with high acidity, such as tomatoes or lemons, may cause the porcelain enamel turntable to discolor. Do not cook highly acidic foods directly on the turntable; if spills occur, wipe up immediately. The turntable motor shaft is not sealed, so excess water or spills should be wiped up immediately.

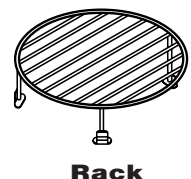
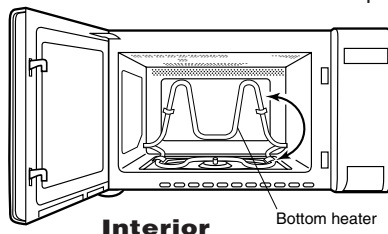
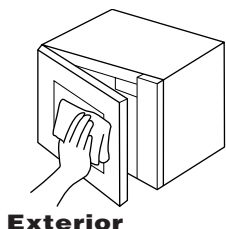

SERVICE CALL CHECK

Check the following before calling service:

- | | | |
|---|----------|---------|
| 1. Does the display light? | Yes_____ | No_____ |
| 2. When the door is opened, does the oven light come on? | Yes_____ | No_____ |
| 3. Place one cup of water in a glass measuring cup in the oven and close the door securely.
Operate the oven for one minute on 100% (HIGH) : | | |
| A. Does the oven light come on? | Yes_____ | No_____ |
| B. Does the cooling fan work?
(Put your hand over the rear ventilation openings.) | Yes_____ | No_____ |
| C. Does the turntable rotate?
(It is normal for the turntable to turn either direction.) | Yes_____ | No_____ |
| D. Does the COOK indicator light? | Yes_____ | No_____ |
| E. After one minute, did an audible signal sound? | Yes_____ | No_____ |
| F. Is the water in the oven warm? | Yes_____ | No_____ |
| 4. Remove water from the oven and program the oven for 3 minutes on GRILL option number 1. | | |
| A. Do the top and bottom heater symbols and COOK indicator light? | Yes_____ | No_____ |
| B. After 3 minutes, does the oven feel hot? (Pay special attention to prevent burns when checking the bottom heater.) | Yes_____ | No_____ |

If “NO” is the answer to any of the above questions, please check electrical outlet, fuse and/or circuit breaker. If they are functioning properly, CONTACT YOUR NEAREST SHARP AUTHORIZED SERVICER. A microwave oven should never be serviced by a “do-it-yourself” repair person.

- NOTE:**
1. If time appearing in the display is counting down very rapidly, check Demonstration Mode on page 22 and cancel.
 2. After cooking, the cooling fan may switch on to cool the oven cavity. When the cooling fan is on, you will hear the sound of the cooling fan.

SPECIFICATIONS

AC Line Voltage:	Single phase 120V, 60Hz, AC only
AC Power Required:	
Microwave	1450W 12.5 A
Grill/Convection	1550W 13.0 A
Output Power:	
Microwave	900W* (IEC Test Procedure)
Grill Heater	1000W (Top heater) 1500W (Top and bottom heater)
Frequency:	2450 MHz
Outside Dimensions:	20 ¹ / ₂ " (W) x 12 ¹ / ₈ " (H) x 19 ³ / ₄ " (D)
Cavity Dimensions:**	13 ⁷ / ₈ " (W) x 7 ¹ / ₂ " (H) x 14 ¹ / ₂ " (D)
Oven Capacity:**	0.9 Cu.Ft.
Cooking Uniformity:	Turntable system, 12 ³ / ₄ " diameter
Weight:	Approx. 44 lb

- ★ The International Electrotechnical Commission’s standardized method for measuring output wattage. This test method is widely recognized.
- ★★ Internal capacity is calculated by measuring maximum width, depth and height. Actual capacity for holding food is less.

In compliance with standards set by:

- FCC** – Federal Communications Commission Authorized.
- DHHS** – Complies with Department of Health and Human Services (DHHS) rule, CFR, Title 21, Chapter I, Subchapter J.
-  – This symbol on the nameplate means the product is listed by Underwriters Laboratories, Inc.

COOKING GUIDES



INTRODUCTION

The Grill 2 Convection Microwave oven is the ultimate cooking team. This state-of-the-art system brings together the best of all worlds. Enjoy the browning and crisping capabilities of convection plus the speed of microwave cooking. Microwaving brings out the natural flavor of foods and keeps them moist and juicy. Convection and grill cooking add the advantage of browning and crisping food beautifully. Roast is a combination setting which uses convection heat to seal and brown the outside while using microwave energy to make sure the interior is cooked.

What is CONVECTION Cooking?

With convection cooking, a high speed fan circulates air past the heat source and around the food. The superheated air browns and crisps the food beautifully. See page 34 for Convection Baking Chart.

- * Use the CONVEC settings for baking most items. Note that there are 3 special settings for baking cakes, angel food cake and yeast breads. These settings are specially designed to provide optimum baking of these foods.
- * The Interactive Display provides specific directions for using all of the settings.



What is GRILL Cooking?

When using GRILL, most food is elevated on the rack, allowing cooking to occur on all sides simultaneously. It is usually not necessary to turn foods over during grilling. Fats drip away from the food, providing for great flavor without all the fat. See page 31 for Grilling Chart.

- * Use the GRILL setting for everything you'd broil in a conventional oven—steaks, chops, burgers, chicken and fish.
- * Place rack on the turntable to allow juices to drain away from food.
- * Use the GRILL top only setting to brown and crisp just the tops of such foods as casseroles.

What is ROAST?

ROAST combines convection heat with microwave power to provide crisp brown exteriors and superior juiciness for meats and poultry. ROAST is preprogrammed to provide 30 percent microwave energy and 325°F. The temperature can be changed by simply selecting another after touching ROAST twice when programming. See page 12.

- * Use ROAST for meats, poultry and casseroles. See page 28 for times.
- * Place foods on the rack so that the air passes all around the food sealing in the juices.
- * Place a shallow oven-glass dish or disposable pizza pan below the rack to catch juices if gravy is desired. Also helps speed cleaning.
- * NO PREHEATING IS NECESSARY.

Convection Microwave Utensils

A wide variety of utensils may be used in convection and roast cooking. Remember that there is heat when cooking with convection, grill or roast; therefore utensils must be able to withstand the cooking temperature you are using. You may use:

- * the Carousel turntable as a baking sheet for cookies
- * the rack for either convection or roast cooking
- * traditional metal bakeware
- * round pizza pans. Choose those that do not have extended handles.
- * oven-glass baking dishes
- * plastics if indicated for use with heat; usually states temperature limit on the bottom. CHECK.

FOODS AND BEST COOKING METHODS

There's an easy way to cook each of your favorite foods. Matching the best method and setting to the food is the secret to success time after time. This chart keeps it simple by giving you the everyday guidelines you need. Now you can tell at a glance whether it's best to use a special setting, CONVEC, GRILL, ROAST or MICROWAVE.

FOOD	SPECIAL SETTING	CONVEC	GRILL	ROAST	MICROWAVE
Breads & Rolls					
Biscuits	AutoBake 5				
Bread Loaves - yeast		Convec 5			
Rolls - yeast		Convec 5			
Cakes					
Angel Food Cake		Convec 4			
Bundt		Convec 3			
Cupcakes		Yes			
Loaf Cakes or Quick Breads		Convec 3			
Muffins (regular size)		Yes			
Snack Cake 8" x 8" x 2"	AutoBake 4				
Tube Cakes		Convec 3			
Cookies					
Brownies 8" x 8" x 2"	AutoBake 3				
All Other Cookies		Yes			
Defrosting	AutoDefrost 1 -5				Yes
Desserts					
Cheesecake		Yes			
Cream Puffs or Eclairs		Yes			
Crisps or Cobblers		Yes Lower temp 25°			
Frozen Convenience Foods					
Entrees	Reheat 5				
French Fries	AutoBake 1				
Snacks	AutoBake 2				

FOOD AND BEST COOKING METHODS

FOOD	SPECIAL SETTING	CONVEC	GRILL	ROAST	MICROWAVE
Meat, Fish & Poultry					
Bacon					Yes
Casseroles	Reheat 1		Top only		
Chicken, whole	AutoRoast 1				
Chicken, boneless pieces	AutoGrill 4				
Chicken, bone-in pieces	AutoGrill 5				
Chops : Lamb, Pork, Veal			Yes		
Cornish Hens	AutoRoast 5				
Ground Meat	AutoCook 4				
Hamburgers	AutoGrill 1				
Ham Steak			Yes		
Hot Dogs			Yes		Yes
Fish/Seafood	AutoCook 5				
Fish Steaks	AutoGrill 3				
Meat Loaf				Yes	
Roasts Beef Eye Round	AutoRoast 4				
Pork Loin, boneless	AutoRoast 2				
Other				Yes	
Sausage			Yes		
Steaks	AutoGrill 2				
Turkey, breast	AutoRoast 3				
Turkey, cutlet	AutoGrill 4				
Turkey, whole	AutoRoast 1				
Pies					
Crust		Yes			
Custard or Pumpkin		Yes			
Double - Crust		Yes			
Frozen Prepared		Yes Lower temp 25°			
Variety Pies (pecan, chess, etc.)		Yes			
Pizza	AutoPizza 1 - 5				
Potatoes					
Crispy French Fries	AutoBake 1				
Quick Baked Potato	AutoCook 1			Yes	
Reheating					
	Reheat 1 - 4 AutoPizza 5				
Vegetables	AutoCook 1 - 3				

ROASTING

The ROAST setting roasts perfectly. Preheating the oven is not necessary for roasting meat and poultry. Place foods on the rack which holds meat out of its juices. Never cover the rack with aluminum foil. You don't need a pan because the turntable will catch the drippings.

HELPFUL TIPS:

- * Shield thin or bony areas of roasts or breast, wing tips and legs of poultry to prevent overbrowning. Use small smooth strips of aluminum foil.
- * Should you wish to have gravy, place a shallow oven-glass baking dish below the meat on the rack to collect any juices. When food is done, simply make gravy in the baking dish and cook using HIGH power.
- * Roast less-tender cuts of beef in heat-resistant and microwave-safe covered casserole or in oven cooking bag set in baking dish. Covering helps tenderize meat.
- * Check doneness after minimum time using a meat thermometer. Add additional time, if necessary.
- * After cooking, cover roasts with "tent" of foil and let stand 5 to 10 minutes before carving.

ROASTING CHART

CUT	TIME-MIN/LB ON ROAST	REMOVAL TEMPERATURE	INTERNAL TEMP. AFTER STANDING
Beef			
Roasts (tender cuts)	Rare: 10-12	120°F.	140°F.
	Medium: 11-13	130°F.	150°F.
	Well Done: 12-14	150°F.	160°F.
Roasts (less tender cuts)	Rare: 12-16	120°F.	140°F.
	Medium: 14-18	130°F.	150°F.
	Well Done: 20-22	150°F.	160°F.
Veal			
Roasts (boned, rolled, tied)	Well Done: 14-16	155°F.	165°-170°F.
Breast (stuffed)	Well Done: 11-13	160°F.	170°F.
Pork			
Roasts (boned, rolled, tied or bone-in)	Well Done: 15-17	165°F.	170°F.
Smoked Ham	7-9 min.	130°F.	140°F.
Lamb			
Leg Roasts	Rare: 11-13	120°F.	130°F.
	Medium: 13-15	135°F.	145°F.
	Well Done: 15-17	150°F.	160°F.
Poultry			
Chicken, whole (unstuffed)	AUTO ROAST 1	175°F.	185°F.
Chicken, pieces (bone-in)	AUTO GRILL 5	175°F.	185°F.
Poultry Cutlet(boneless)	AUTO GRILL 4	165°F.	170°F.
Turkey Breast	AUTO ROAST 3	165°F.	170°F.
Turkey, whole (unstuffed)	AUTO ROAST 1	175°F.	185°F.

MAIN DISH RECIPES

Pot Roast with Vegetables

- 4 to 5-pound round or chuck pot roast
- 1/2 teaspoon salt
- 1/2 teaspoon garlic powder
- 1/2 teaspoon dried thyme leaves
- 1/8 teaspoon pepper
- 4 potatoes, peeled and quartered
- 3 onions, quartered
- 2 carrots, sliced
- 3/4 cup water
- 2 tablespoons brown bouquet sauce

Makes 8 servings

Place meat in 4-quart casserole. Pat seasonings into meat. Add vegetables. Combine water and browning sauce; pour into casserole dish. Cover with lid.

Cook 21 to 23 minutes per pound on ROAST or until meat is fork-tender. Allow to stand 5 minutes.

Per Serving:

Calories:	325	Fat:	11 g.
Protein:	36 g.	Cholesterol:	102 mg.
Carbohydrate:	21 g.	Sodium:	227 mg.

Steak Roulade

- 1/4 cup red wine
- 1/4 cup soy sauce
- 1/4 cup vegetable oil
- 1 1/2 pounds flank steak
- 1 medium onion, diced
- 1 stalk celery, diced
- 1/2 green pepper, diced
- 1/2 cup sliced mushrooms
- 2 tablespoons margarine or butter
- 1/2 cup seasoned bread crumbs

Makes 4 servings

Combine wine, soy sauce and oil in large dish. Add steak and marinate several hours.

Combine remaining ingredients, except bread crumbs, in small bowl. Microwave at HIGH (100%) until vegetables are tender, 4 to 5 minutes. Stir in crumbs.

Remove meat from marinade. Spread filling evenly over meat. Roll meat up, starting at narrow end. Tie securely with string. Place in glass pie plate and on rack. Cook 30 minutes on ROAST or until internal temperature reaches 130°F.

Per Serving:

Calories:	461	Fat:	29 g.
Protein:	35 g.	Cholesterol:	90 mg.
Carbohydrate:	13 g.	Sodium:	536 mg.

Meat Loaf Surprise

- 1 1/2 pounds ground beef
- 1 egg
- 1 small onion, chopped
- 1 carrot, grated
- 1 stalk celery, finely chopped
- 1/2 cup seasoned bread crumbs
- 1/4 cup catsup
- 1/2 teaspoon dried thyme leaves
- 1/4 teaspoon garlic powder
- 1/8 teaspoon pepper
- 1/4 pound boiled ham, sliced
- 1/4 pound Swiss cheese, sliced

Makes 6 servings

Thoroughly combine all ingredients except ham and cheese. On a sheet of wax paper, press mixture into a 9 x 12-inch rectangle.

Layer sliced ham on meat, then cheese. Roll up, starting at narrow end. Seal ends to form loaf. Place seam side down in loaf pan, 9 x 5 inches. Cook 35 to 40 minutes on ROAST or until internal temperature reaches 155°F. Cover and allow to stand 5 to 10 minutes.

Per Serving:

Calories:	384	Fat:	23 g.
Protein:	30 g.	Cholesterol:	145 mg.
Carbohydrate:	12 g.	Sodium:	525 mg.

Pineapple Pork Roast

- 1 cup pineapple preserves
- 1/4 cup prepared mustard
- 1 tablespoon prepared horseradish
- 1 tablespoon soy sauce
- 3 1/2 pound boneless pork loin

Makes 6 servings

Combine all ingredients except pork roast in small bowl. Place roast on rack.

Follow directions in AUTO ROAST#2.

Cover roast with sauce during last 10 minutes of cooking. Internal temperature should be at least 160°F. Cover and let stand 10 minutes before serving. Extra sauce may be heated and served with roast.

Per Serving:

Calories:	394	Fat:	15 g.
Protein:	29 g.	Cholesterol:	93 mg.
Carbohydrate:	36 g.	Sodium:	376 mg.

MAIN DISH RECIPES

Stuffed Pork Chops

- 4 pork chops, 1¹/₄ inches thick
- 1 cup chopped apple
- ¹/₂ cup soft bread crumbs
- ¹/₂ cup chopped walnuts
- ¹/₄ cup chopped onion
- ¹/₄ cup raisins
- 1 egg
- 1 teaspoon dried parsley flakes
- ¹/₂ teaspoon dried thyme leaves
- ¹/₄ teaspoon ground sage
- ¹/₈ teaspoon pepper

Makes 4 servings

Make pocket in each chop. Combine remaining ingredients; mix well. Stuff each chop with one-fourth of the mixture. Place chops directly on turntable or round baking pan.

Cook 30 minutes on ROAST or until meat next to bone is no longer pink.

Per Serving:			
Calories:	451	Fat:	26 g.
Protein:	36 g.	Cholesterol:	156 mg.
Carbohydrate:	19 g.	Sodium:	100 mg.

Sesame Oven-Fried Chicken

- 1 egg
- ¹/₂ cup milk
- ¹/₂ cup all-purpose flour
- 2 tablespoons sesame seeds
- 1 teaspoon baking powder
- 2 teaspoons paprika
- 1 teaspoon garlic powder
- ¹/₂ teaspoon salt
- 2¹/₂ to 3¹/₂-pound broiler-fryer chicken, cut up
- ¹/₂ cup margarine or butter, melted

Makes 5 servings

Beat egg and milk in medium bowl. Combine flour, sesame seeds, baking powder, paprika, garlic powder and salt in plastic or paper bag. Dip chicken pieces in egg mixture, then shake in bag to coat. Arrange chicken pieces skin side up on turntable. Pour margarine evenly over chicken. Bake 40 to 45 minutes on ROAST. Chicken next to bone should no longer be pink at end.

Per Serving:			
Calories:	399	Fat:	27 g.
Protein:	26 g.	Cholesterol:	122 mg.
Carbohydrate:	12 g.	Sodium:	578 mg.

Herb Roasted Chicken

- 3 tablespoons margarine or butter, softened
- 1 clove garlic, minced
- 3 tablespoons grated Parmesan cheese
- ¹/₂ teaspoon ground sage
- ³/₄ teaspoon thyme leaves
- ³/₄ teaspoon basil leaves
- 5 to 6 pound roasting chicken

Makes 6 servings

Cream together margarine, garlic, Parmesan cheese, sage, thyme and basil.

Turn chicken breast side up and work your fingers under the skin at the openings on each side of the breast. Continue into thigh and leg and make the skin as smooth as possible. Using fingers, spread herb mixture evenly under skin.

Place chicken, breast side up on rack. Follow directions in AUTO ROAST #1. Chicken next to bone should no longer be pink at end.

Per Serving:			
Calories:	270	Fat:	15 g.
Protein:	32 g.	Cholesterol:	94 mg.
Carbohydrate:	1 g.	Sodium:	216 mg.

Mustard and Mayonnaise Chicken

- 2¹/₂ to 3-pound broiler-fryer chicken, cut up
- ¹/₄ cup spicy prepared mustard
- ¹/₄ cup mayonnaise

Makes 5 servings

Arrange chicken pieces skin side up on rack. Combine mustard and mayonnaise; spread on chicken pieces.

Follow directions in AUTO GRILL #5. Chicken next to bone should no longer be pink at end.

Per Serving:			
Calories:	233	Fat:	15 g.
Protein:	21 g.	Cholesterol:	72 mg.
Carbohydrate:	—	Sodium:	479 mg.

Glazed Stuffed Cornish Hens

- 1 cup chopped pecans
- ³/₄ cup apricot preserves
- ¹/₄ cup margarine or butter, melted
- 3 tablespoons orange juice concentrate
- 1 tablespoon lemon juice
- 1 cup seasoned stuffing cubes
- ¹/₂ cup water
- 2 Cornish hens (1¹/₂ pounds each)

Makes 4 servings

Combine pecans, preserves, melted margarine, orange juice concentrate and lemon juice. Combine half the sauce mixture with stuffing cubes and water. Stuff cavity of each bird. Truss birds.

Pour half of the remaining sauce over hens. Brush with remaining sauce halfway through cooking time.

Follow directions in AUTO ROAST #5. Meat next to bone should no longer be pink. Internal temperature of stuffing should register 165°F.

Per Serving:			
Calories:	743	Fat:	36 g.
Protein:	34 g.	Cholesterol:	74 mg.
Carbohydrate:	75 g.	Sodium:	670 mg.

Hearty Pizza

- 1 pound ground beef or
4 to 6 ounces sliced pepperoni
- 2 medium onions, chopped
- 2 cloves garlic, finely chopped
- 2 tablespoons olive oil
- 1 can (28 oz.) crushed tomatoes in puree
- 1 tablespoon dried oregano leaves
- 1 teaspoon dried basil leaves
- 1/2 teaspoon salt
- 1/8 teaspoon pepper
- 1/4 cup water (105°F - 115°F)
- 1 package active dry yeast
- 1/2 teaspoon salt
- 3/4 cup milk
- 2 tablespoons vegetable oil
- 3 cups all-purpose flour
- 2 cups shredded mozzarella cheese (about 8 ounces)
- Yellow cornmeal

Makes two 12-inch pizzas,
16 servings

If using ground beef, place in a medium-sized bowl. Microwave at HIGH (100%) until beef loses pink color, 4 to 6 minutes, stirring to break up beef after half the cooking time. Drain and set aside.

Combine onion, garlic and olive oil in medium bowl. Microwave at HIGH (100%) until vegetables are tender, 4 to 6 minutes. Stir in crushed tomatoes in puree, spices, 1/2 teaspoon salt and the pepper.

Microwave at HIGH (100%) until bubbly, about 3 minutes. Stir. Reduce power to MEDIUM (50%). Microwave until thickened, 6 to 8 minutes.

Sprinkle yeast on water in large bowl. Stir to dissolve. Add 1/2 teaspoon salt, milk, oil and flour to make a pliable dough. Knead until smooth, about 2 minutes. Place in well-greased large bowl; turn greased side up. Cover with clean, moist towel. Place in oven at 100°F. until double in size, about 40 minutes. (Dough is ready if an indentation remains when touched.)

Remove dough and turntable from oven. Preheat oven to 425°F. Punch dough down. Divide dough in half. With well-greased fingers, pat dough onto 2 greased 12 x 5/8-inch metal pizza pans, which have been sprinkled with cornmeal. Pinch dough to form edge. Prick crust. Place one pan on turntable and return to oven. Bake 14 to 16 minutes or until crust is golden brown. Top crust with pizza sauce, 1/2 of ground beef or pepperoni and 1/2 cheese. Bake at 425°F. 6 to 10 minutes or until cheese is melted and beginning to brown. Repeat baking procedure for second pizza.

Per Serving:

Calories:	245	Fat:	11 g.
Protein:	12 g.	Cholesterol:	26 mg.
Carbohydrate:	24 g.	Sodium:	333 mg.

Tamale Casserole

- 1 pound lean ground beef
- 1 medium onion, chopped
- 1 small green pepper, chopped
- 2 cans (8 ounces each) tomato sauce
- 1 clove garlic, minced
- 1 teaspoon chili powder
- 1 teaspoon taco seasoning mix
- 1/2 teaspoon sugar
- 1/4 teaspoon salt
- 1/4 teaspoon pepper

Corn Bread:

- 1/2 cup yellow cornmeal
- 1/2 cup all-purpose flour
- 2 teaspoons baking powder
- 1 tablespoon sugar
- 1/4 teaspoon salt
- 1/2 cup milk
- 1 egg
- 2 tablespoons melted shortening

Topping:

- 1/2 cup shredded Cheddar cheese (about 2 ounces)
- 1/4 cup sliced pitted black olives

Makes 6 servings

Mix ground beef, onion and green pepper in 2-quart casserole. Microwave at HIGH (100%) 5 minutes, stirring to break up beef after half the cooking time. Stir in tomato sauce, garlic, chili powder, taco seasoning mix, sugar, salt and pepper. Microwave at HIGH (100%) 5 minutes. Reduce power to MEDIUM-HIGH (70%). Microwave 5 minutes.

Combine cornmeal, flour, baking powder, sugar and salt in medium bowl. Stir in milk, egg and shortening. Beat mixture until almost smooth. Pour over beef mixture. Preheat oven to 400°F. After preheat, place casserole in oven and bake for 15 to 20 minutes at 400°F. or until corn bread is golden. Sprinkle with topping ingredients. Cool 5 minutes before serving.

Per Serving:

Calories:	341	Fat:	16 g.
Protein:	22 g.	Cholesterol:	108 mg.
Carbohydrate:	27 g.	Sodium:	909 mg.

GRILLING

Your oven grills giving tender, juicy results. Check chart below for approximate grill times. Program oven for the maximum time but check at the minimum time. If done, remove. If not, simply touch Start/Touch On and continue grilling, checking frequently until the desired doneness is achieved.

Preheating is not necessary so put food on rack, program the oven and touch Start/Touch On. It is wise to remove excess fat, slash edges and season, if desired. The rack should NOT BE COVERED BY FOIL. Food may be turned half way through the grilling time.

HELPFUL HINTS

- * Spray rack and turntable with nonstick vegetable cooking spray for easier cleanup.
- * Grill food in advance, if desired, then slice. Individual servings may be reheated as needed by microwaving at MEDIUM (50%).
- * Clean by turning rack over onto the turntable. Place cup of water in the turntable and heat for 2 minutes on HIGH power. Remove to finish cleaning. Wipe out oven interior.

GRILLING CHART

Cut	Weight/Thickness	Time on GRILL
Beef		
Rib-eye Steak	$\frac{3}{4}$ -1 in. 7-8 oz. each	AUTO GRILL 2 Choose rare, medium or well done
Steaks: Sirloin, Porterhouse, T-bone	1-1 $\frac{1}{2}$ in.	
Chuck Steak	1 in.	Rare: 12-14 min. Medium: 15-18 min.* Well Done: 19-23 min.*
London Broil	1-1 $\frac{1}{4}$ in. 2 $\frac{1}{2}$ -3 lbs.	Rare: 25-30 min. Medium: 31-40 min.*
Hamburgers	$\frac{1}{4}$ lb. each	AUTO GRILL 1
Pork		
Chops: loin or center	$\frac{3}{4}$ -1 in.	Well Done: 20-30 min.*
Sausage: Brown'n Serve	Patties: 1-2 in., 8 oz. - 1 lb.	10-12 min.
Fresh	Links: 8 oz. - 1 lb.	10-12 min.*
Ham slice, fully cooked	$\frac{3}{4}$ in.	10-12 min.
Frankfurters	1 lb.	7-9 min.*
Lamb		
Chops: rib, loin or center	$\frac{3}{4}$ in. 3-4 oz. each	Medium: 18-22 min.* Well Done: 23-25 min.*
Chicken		
Boneless	.5-2 lbs.	AUTO COOK 4
Broiler-Fryer, halved, quartered or cut up	.5-3 lbs.	AUTO GRILL 5
Fish		
Fillet	$\frac{1}{4}$ - $\frac{3}{4}$ in.	7-10 min.
Steaks	$\frac{3}{4}$ in.	AUTO GRILL 3

* May wish to turn food over halfway through grilling time.

GRILLING RECIPES

Oriental Flank Steak

- 1/4 cup sherry
- 2 tablespoons packed brown sugar
- 3/4 teaspoon salt
- 3 tablespoons soy sauce
- 3 tablespoons Hoisin sauce
- 3 tablespoons catsup
- 1 tablespoon minced fresh ginger
- 2 green onions, thinly sliced
- 1 to 1 1/2-pound flank steak

Makes 4 servings

Combine all ingredients except flank steak in medium bowl. Pour over steak. Marinate at least 2 hours or overnight.

Place flank steak on rack. Cook for 12 to 15 minutes on GRILL, brushing with marinade several times.

Per Serving:			
Calories:	226	Fat:	13 g.
Protein:	22 g.	Cholesterol:	60 mg.
Carbohydrate:	4 g.	Sodium:	421 mg.

Ginger Pork Kabobs

- 1 egg, beaten
- 1/2 cup crushed chow mein noodles
- 1/4 cup apple juice
- 2 tablespoons soy sauce
- 1 tablespoon grated gingerroot
- 1 pound ground pork
- 1 can (8 ounces) pineapple chunks (juice pack), drained
- 1 large red pepper, cut into 3/4-inch chunks
- 1/2 cup apple juice
- 2 tablespoons cider vinegar
- 1 teaspoon cornstarch

Makes 4 servings

Mix egg, crushed noodles, 1/4 cup apple juice, soy sauce and gingerroot. Crumble ground pork into mixture; blend thoroughly, shape into 1-inch balls. Set aside.

For glaze, mix 1/2 cup apple juice, vinegar and cornstarch in small bowl. Microwave at HIGH (100%) until thickened, 1 1/2 to 3 minutes, stirring every 30 seconds.

Thread pork balls alternately with pineapple and red pepper chunks on 4 wooden or metal skewers. Place on rack.

Brush kabobs with glaze. Cook for 15 to 20 minutes on GRILL. Turn over halfway through grill time and brush with glaze. Brush with remaining glaze before serving.

Per Serving:			
Calories:	256	Fat:	7 g.
Protein:	29 g.	Cholesterol:	153 mg.
Carbohydrate:	18 g.	Sodium:	652 mg.

Honey Mustard Chicken

- 1/2 cup coarse ground mustard
- 1/4 cup Dijon-style mustard
- 1/4 cup honey
- 2 to 3 pounds boneless chicken breasts and thighs, skin removed

Makes 4 servings

Combine coarse mustard, Dijon mustard and honey. Set aside.

Place chicken in 9-inch oven-safe dish. Put dish on rack. Follow directions in AUTO GRILL #5. When chicken is about half cooked, pour off any liquid and brush with sauce to cover chicken pieces completely. Chicken next to bone should no longer be pink at end.

Per Serving:			
Calories:	368	Fat:	8 g.
Protein:	50 g.	Cholesterol:	133 mg.
Carbohydrate:	19 g.	Sodium:	950 mg.

Steak Kabobs

- 1/4 cup sugar
- 1/4 cup soy sauce
- 1/4 cup white wine
- 1 tablespoon vegetable oil
- 1 teaspoon ground ginger
- 1/4 teaspoon salt
- 2 pounds lean top beef round steak, cut into 1-inch cubes
- 2 large green peppers, cut into chunks
- 8 cherry tomatoes, cut into halves
- 1 can (8 ounces) pineapple chunks (juice pack), drained

Makes 4 servings

Mix sugar, soy sauce, wine, oil, ginger and salt in medium bowl. Stir in steak cubes; cover. Marinate at room temperature 1 hour or at least 4 hours in refrigerator.

Remove steak cubes from marinade; reserve marinade. Thread steak cubes alternately with remaining ingredients on 8 wooden or metal skewers. Place on rack. Cook for 8 to 12 minutes on GRILL. Turn and brush with marinade. Continue to cook for 8 to 12 minutes on GRILL or until desired doneness.

Note: Skewers up to 10 inches can be used.

Per Serving:			
Calories:	432	Fat:	17 g.
Protein:	52 g.	Cholesterol:	153 mg.
Carbohydrate:	15 g.	Sodium:	381 mg.

GRILLING RECIPES

Grilled Salmon with Basil Sauce

- 2 tablespoons olive oil
- 1 clove garlic, minced
- 1/4 cup white wine
- 2 tablespoons lemon juice
- 1 cup fresh basil*
- 1/4 cup grated Parmesan cheese
- 1/2 teaspoon Dijon-style mustard
- 4 salmon steaks (1 1/4 to 1 1/2 pounds) or haddock, halibut, swordfish
- Cayenne pepper

Makes 4 servings

Combine oil, garlic, white wine and lemon juice in blender. Add basil, Parmesan cheese and mustard and blend until smooth.

Put one-fourth of basil sauce in bottom of 9-inch oven-safe dish. Arrange steaks on sauce and pour remaining sauce over tops of steaks. Sprinkle with cayenne.

Place dish on turntable. Follow directions in AUTO GRILL #3. Fish flakes easily when tested with a fork at end.

*If not available, substitute 1/2 cup fresh parsley and 2 tablespoons dried basil.

Per Serving:			
Calories:	357	Fat:	21 g.
Protein:	35 g.	Cholesterol:	97 mg.
Carbohydrate:	2 g.	Sodium:	209 mg.

Crunchy Crab Boats

- 1 can (6 ounces) fancy white crabmeat, drained
- 1 package (3 ounces) cream cheese, softened
- 1/2 cup chopped almonds
- 2 tablespoons green onions, chopped
- 1 tablespoon dry white wine
- 1 teaspoon lemon juice
- 1 teaspoon prepared horseradish
- 1/4 teaspoon garlic powder
- 1/4 teaspoon salt
- Dash of white pepper
- Dash of cayenne pepper
- 2 hard rolls, cut in half
- 1/4 cup shredded Swiss cheese

Makes 4 servings

Remove any bits of shell or cartilage from crab. Combine with next 10 ingredients. Mix well. Set aside. Toast rolls on GRILL-TOP ONLY for 3 minutes.

Spread one-fourth of crab filling on each roll half. Place Swiss cheese on top of each. Place on rack. Cook for 14 to 16 minutes on GRILL or until cheese is melted and crab is hot. Sprinkle with paprika and serve.

Per Serving:			
Calories:	292	Fat:	19 g.
Protein:	15 g.	Cholesterol:	57 mg.
Carbohydrate:	15 g.	Sodium:	416 mg.

Spicy Shrimp

- 1/4 cup white wine
- 1/4 cup water
- 3 tablespoons soy sauce
- 2 tablespoons sugar
- 1 tablespoon vegetable oil
- 2 teaspoons dried parsley flakes
- 1/8 to 1/4 teaspoon ground ginger
- Dash of hot pepper sauce
- 1 pound jumbo raw shrimp, shelled and deveined

Makes 4 servings

Mix all ingredients except shrimp in medium bowl. Stir in shrimp; cover. Marinate at room temperature 45 minutes or 3 hours in refrigerator.

Remove shrimp from marinade; reserve marinade. Place shrimp on round baking pan on turntable. Cook 18 to 20 minutes on GRILL, brushing with marinade after half the time.

Microwave remaining marinade at HIGH (100%) 2 minutes. Serve over rice or as a dipping sauce when served as an appetizer, if desired.

Per Serving:			
Calories:	109	Fat:	2 g.
Protein:	18 g.	Cholesterol:	129 mg.
Carbohydrate:	3 g.	Sodium:	319 mg.

Grilled Herbed Vegetables

- 2 pounds fresh vegetables of your choice (red onion, peppers, zucchini, portobello mushrooms, eggplant, etc.)
- 1/3 cup olive oil
- 2 tablespoons chopped fresh herbs or 2 teaspoons of dried herbs (thyme, rosemary, oregano, tarragon, etc.)

Makes 8 servings

Coat prepared vegetables with seasoned olive oil. Allow to stand for 30 minutes. Drain and pat dry. Preheat turntable on GRILL for 3 minutes. Cook for 20 to 30 minutes on GRILL, turning frequently until vegetables are tender when pierced with a fork and browned. Serve hot or at room temperature.

Per Serving:	Will depend on the varieties of vegetables used.		
Calories:	60	Fat:	6 g.
Protein:	1 g.	Cholesterol:	0 mg.
Carbohydrate:	2 g.	Sodium:	0 mg.

BAKING

In a convection oven, the moving evenly heated air bakes and browns foods beautifully. Preheating the oven is necessary for convection cooking and baking.

HELPFUL HINTS

- * Metal pizza pans are ideal for baking of cookies, biscuits and frozen convenience foods.
- * Use the turntable for shaping and baking yeast braids or other special shapes.
- * Remember to use CONVEC 3.4 and 5 for cakes, angel food cakes and yeast bread.

BAKING CHART

FOOD	PROCEDURE
Appetizers/snacks: Brown and serve, pastry	Follow recipe or package for CONVEC temperature and time OR use CompuBake #2 Frozen Snacks.
Biscuits: Your recipe, mix or refrigerator	Follow recipe or package for CONVEC temperature and time OR use CompuBake #5 Biscuits.
Breads Quick: Your recipe or mix	Follow recipe or package for CONVEC temperature and time.
Yeast: Your recipe or mix	Use CONVEC #5 Yeast Bread setting and follow recipe or package for time.
Cakes Angel food: Your recipe or mix	Use CONVEC #4 Angel Food Cake setting and follow recipe or package for time.
Bundt: Your recipe or mix	Use CONVEC #3 Cake setting and follow recipe or package for time.
Cheescake: Your recipe or mix	Follow recipe or package for CONVEC temperature and time.
Snack: Your recipe or mix	Follow recipe or package for CONVEC temperature and time OR use CompuBake #4 Snack Cake.
Tube/pound: Your recipe or mix	Use CONVEC #3 Cake setting and follow recipe or package for time.
Cookies: All kinds	Follow recipe or package for CONVEC temperature and time. Use round baking/pizza pans.
Crisps/cobblers: Your recipe or mix	Decrease recipe or package temperature 25 degrees and follow recipe or package times.
Muffins: All kinds	Follow recipe or package for CONVEC temperature and time. Use 6-cup muffins pans.
Pie Crust: Your recipe, mix or refrigerator (No filling)	Follow recipe or package for CONVEC temperature and time.
Double crust: Your recipe	Follow recipe for CONVEC temperature and time.
Frozen prepared custard or fruit	Decrease package temperature 25 degrees and follow package time.
Single crust: Your recipe	Bake crust first until set but not browned. Place filling in prebaked crust and follow recipe for CONVEC temperature and time.
Pizza Frozen: Regular crust	Bake using AutoPizza #1.
Frozen: Rising crust	Bake using AutoPizza #2.
Home made: Your recipe	Follow recipe for CONVEC temperature and time.
Refrigerated	Bake using AutoPizza #3.

BAKING RECIPES

Chocolate Chip "Pizza"

- 1 cup all-purpose flour
 - 1/8 teaspoon baking soda
 - 1/2 teaspoon baking powder
 - 1/8 teaspoon salt
 - 1/4 cup granulated sugar
 - 3/4 cup packed brown sugar
 - 1/2 cup margarine or butter
 - 1/2 teaspoon vanilla
 - 1 egg
 - 1 package (6 ounces) chocolate chips
 - 1/2 cup chopped nuts (optional)
- Makes 1 11"-12" "pizza"

Preheat oven to 350°F.

Combine flour, soda, baking powder and salt; set aside. Cream together sugars, margarine and vanilla. Beat until creamy. Beat in egg. Gradually add flour mixture; mix well. Stir in chocolate chips and nuts.

Spread mixture into 1 ungreased 11 to 12 inch round pizza pan. Bake 22 to 24 minutes at 350°F or until wooden pick inserted in center comes out clean. Let cool in pan. Cut into 16 wedges.

Per Serving:			
Calories:	208	Fat:	13 g.
Protein:	2 g.	Cholesterol:	17 mg.
Carbohydrate:	23 g.	Sodium:	108 mg.

Carousel Crackles

- 1/2 cup semisweet chocolate chips
- 1/2 cup packed brown sugar
- 3 tablespoons vegetable oil
- 1 egg
- 1/2 teaspoon vanilla
- 1/2 cup all-purpose flour
- 1/2 teaspoon baking powder
- 1/4 teaspoon salt
- 1/4 cup finely chopped walnuts
- 1/4 cup powdered sugar

Makes 2 dozen

Place chocolate chips in large mixing bowl. Microwave at HIGH (100%) until melted, about 2 minutes. Blend in brown sugar and oil. Add egg and beat well. Stir in vanilla. Combine flour, baking powder and salt; stir into chocolate mixture. Mix in nuts. Chill dough at least 1 hour.

Preheat oven to 350°F. Drop dough by rounded teaspoonfuls into powdered sugar; roll to coat. Plate 2 inches apart on greased round baking pans. Bake 12 to 14 minutes at 350°F. Cool on wire racks.

Per Serving:			
Calories:	72	Fat:	4 g.
Protein:	1 g.	Cholesterol:	6 mg.
Carbohydrate:	10 g.	Sodium:	20 mg.

Onion-Cheese Bread

- 1/2 cup chopped onion (about 1 medium)
 - 1 tablespoon margarine or butter
 - 1 1/2 cups buttermilk baking mix
 - 1/2 cup milk
 - 1 egg, well beaten
 - 1/2 cup shredded sharp Cheddar cheese
 - 2 tablespoons snipped parsley or 1 tablespoon dried parsley flakes
 - 2 tablespoons margarine or butter
 - 1/2 cup shredded sharp Cheddar cheese
- Makes 8 servings

Combine onion and 1 tablespoon margarine in small bowl. Microwave at HIGH (100%) until onion is tender, about 2 minutes. Set onion aside.

Preheat oven to 400°F. Mix baking mix, milk and egg until just moistened in medium bowl. Stir in onion, 1/2 cup cheese and the parsley. Spread in greased square baking pan, 8 x 8 inches. Dot with 2 tablespoons margarine; sprinkle with 1/2 cup cheese. Bake at 400°F. until wooden pick inserted in center comes out clean, about 20 minutes.

Per Serving:			
Calories:	210	Fat:	14 g.
Protein:	7 g.	Cholesterol:	50 mg.
Carbohydrate:	15 g.	Sodium:	422 mg.

Zucchini Muffins

- 1 1/2 cups all-purpose flour
- 1/2 cup sugar
- 1 teaspoon baking powder
- 1/2 teaspoon ground cinnamon
- 1/2 teaspoon salt
- 1 cup grated zucchini
- 1/2 cup chopped walnuts
- 1/2 cup raisins
- 1 egg
- 1/3 cup vegetable oil

Makes 1 dozen

Preheat oven to 400°F.

Combine dry ingredients in medium bowl. Mix in remaining ingredients until just moistened. Spoon batter into 2 greased 6-cup medium muffin pans.

Bake each pan 25 to 35 minutes at 400°F or until tops spring back when touched lightly with finger.

Per Serving:			
Calories:	204	Fat:	10 g.
Protein:	3 g.	Cholesterol:	23 mg.
Carbohydrate:	26 g.	Sodium:	125 mg.

Chocolate Chip Banana Crumb Loaf

- 1 package (14 ounces) banana bread mix or banana muffin mix
- $\frac{3}{4}$ cup semisweet chocolate mini morsels ingredients to complete mix

Crumb Topping:

- $\frac{1}{2}$ cup chopped walnuts
- $\frac{1}{2}$ cup all-purpose flour
- 2 tablespoons granulated sugar
- 2 tablespoons packed brown sugar
- $\frac{1}{4}$ cup margarine or butter

Makes 12 servings

Preheat oven to 350°F.

Grease and flour 9 x 5-inch loaf pan. For easy removal of finished loaf, place a 2 $\frac{1}{2}$ x 16-inch strip of wax paper lengthwise in pan with both ends extending above top of pan.

Combine mix and morsels. Prepare bread mix according to package directions or muffin mix according to loaf pan directions. Pour into prepared pan. Combine remaining dry ingredients in small bowl. Cut in margarine until mixture resembles coarse crumbs. Top batter with this mixture.

Bake 55 to 65 minutes at 350°F. If wooden pick inserted in center does not come out clean, let stand in oven a few minutes to complete cooking. Cool 5 minutes; remove from pan by lifting both ends of wax paper. Cool completely on wire rack.

Per Serving:			
Calories:	338	Fat:	19 g.
Protein:	4 g.	Cholesterol:	46 mg.
Carbohydrate:	40 g.	Sodium:	245 mg.

Classic Cranberry Tea Cake

- $\frac{3}{4}$ cup margarine or butter, softened
- 1 $\frac{1}{2}$ cups sugar
- 3 eggs
- 2 $\frac{1}{2}$ teaspoons almond extract
- 3 cups all-purpose flour
- 1 $\frac{1}{2}$ teaspoons baking powder
- 1 $\frac{1}{2}$ teaspoons baking soda
- $\frac{3}{4}$ teaspoon salt
- 1 $\frac{1}{2}$ cups sour cream
- $\frac{3}{4}$ cup canned whole berry cranberry sauce

Makes 16 servings

Preheat oven using CONVEC #3.

Thoroughly grease and flour 12-cup fluted bundt cake pan. With an electric mixer, beat margarine. Gradually add sugar and beat until fluffy. Add eggs, one at a time, beating well after each addition. Add extract.

Sift dry ingredients together and add alternately with the sour cream. Fold in cranberries.

Sour Cream Pound Cake

- 4 cups all-purpose flour
- 2 teaspoons baking powder
- 1 teaspoon baking soda
- $\frac{1}{2}$ teaspoon salt
- 2 cups sugar
- 1 cup margarine or butter, softened
- 4 eggs
- 1 teaspoon vanilla
- 2 cups dairy sour cream
- $\frac{1}{2}$ cup sugar
- $\frac{1}{4}$ cup finely chopped walnuts
- 2 tablespoons ground cinnamon

Makes 12 servings

Preheat oven using CONVEC #3.

Mix flour, baking powder, baking soda and salt in medium bowl. Set aside. Beat 2 cups sugar and the margarine until light and fluffy. Add eggs, one at a time, beating well after each. Mix in vanilla. Stir in flour mixture alternately with sour cream, beating after each addition until smooth. Set aside.

Combine $\frac{1}{2}$ cup sugar, the nuts and cinnamon. Pour half the batter into well-greased 10-inch tube pan; sprinkle with half of filling. Repeat with remaining batter and filling.

Bake 60 minutes on CONVEC #3. If wooden pick inserted in center does not come out clean, let stand in oven a few minutes to complete cooking. Cool 10 minutes; remove from pan. Cool completely on wire rack.

Per Serving:			
Calories:	586	Fat:	28 g.
Protein:	8 g.	Cholesterol:	109 mg.
Carbohydrate:	77 g.	Sodium:	456 mg.

Pour into prepared pan and bake 50 to 60 minutes on CONVEC #3 or until wooden pick inserted in center comes out clean. Allow to cool on counter 30 minutes. Turn out onto plate and allow to finish cooling before glazing.

Glaze:

- $\frac{3}{4}$ cup powdered sugar
- $\frac{1}{2}$ teaspoon almond extract
- 2 teaspoons warm water
- $\frac{1}{4}$ cup toasted sliced almonds

Combine first 3 ingredients. Drizzle on cake and top with almonds.

Per Serving:			
Calories:	350	Fat:	16 g.
Protein:	5 g.	Cholesterol:	62 mg.
Carbohydrate:	48 g.	Sodium:	360 mg.

BAKING RECIPES

Coconut Oatmeal Pie

- 3 eggs, well beaten
- 1 cup packed brown sugar
- $\frac{2}{3}$ cup granulated sugar
- $\frac{2}{3}$ cup quick-cooking oats
- $\frac{2}{3}$ cup shredded coconut
- $\frac{1}{2}$ cup milk
- 2 tablespoons margarine or butter, melted
- 1 teaspoon vanilla
- $\frac{1}{2}$ cup broken pecans
- 1 9-inch unbaked pie shell

Makes 8 servings

Preheat oven to 375°F. Combine all ingredients except pecans in large bowl. Add pecans; mix well. Pour into pie shell. Bake 35 to 45 minutes at 375°F. or until set.

Per Serving:			
Calories:	504	Fat:	25 g.
Protein:	7 g.	Cholesterol:	104 mg.
Carbohydrate:	66 g.	Sodium:	215 mg.

Fudge Brownie Pie

- $\frac{1}{4}$ cup margarine or butter
- $\frac{3}{4}$ cup packed brown sugar
- 1 tablespoon instant espresso coffee
- 3 eggs
- 1 bag (12 ounces) semisweet chocolate chips
- $\frac{1}{4}$ cup all-purpose flour
- 1 cup chopped pecans
- 1 9-inch unbaked pie shell
- $1\frac{1}{2}$ teaspoons rum extract
- 1 cup whipping cream, whipped stiffly
- Chocolate sprinkles

Makes 12 servings

Preheat oven to 350°F.

Cream margarine and brown sugar until light and fluffy. Stir in espresso. Add eggs, one at a time, beating well after each.

Place chips in 4-cup measure or small bowl. Microwave at MEDIUM (50%) until melted, 1 to 2 minutes, stirring 2 or 3 times. Stir chocolate, flour and pecans into butter, sugar, egg mixture. Pour into pie shell.

Bake 35 to 45 minutes at 350°F. Cool. Fold rum extract into whipped cream. Spread on top of pie and decorate with sprinkles.

Per Serving:			
Calories:	480	Fat:	35 g.
Protein:	5 g.	Cholesterol:	96 mg.
Carbohydrate:	42 g.	Sodium:	168 mg.

Harvest Fruit Pie

- 2 cups all-purpose flour
- 1 teaspoon salt
- 1 teaspoon ground cinnamon
- $\frac{2}{3}$ cup plus 2 tablespoons vegetable shortening

- 4 to 5 tablespoons cold water
- $\frac{3}{4}$ cup sugar
- $\frac{1}{4}$ cup all-purpose flour
- $\frac{1}{2}$ teaspoon ground cinnamon
- $\frac{1}{2}$ teaspoon ground nutmeg
- 6 cups sliced, peeled apples and pears
- 2 tablespoons margarine or butter
- 1 tablespoon milk
- 1 tablespoon sugar

Makes 8 servings

Preheat oven to 400°F. Combine 2 cups flour, the salt and 1 teaspoon cinnamon in medium bowl. Cut in shortening. Sprinkle in water, 1 tablespoon at a time, until flour is moistened. Gather dough into ball; divide in half. Roll each half into 9-inch circle. Ease 1 circle into 9-inch pie pan.

Combine $\frac{3}{4}$ cup sugar, $\frac{1}{4}$ cup flour, $\frac{1}{2}$ teaspoon cinnamon and the nutmeg; mix with apples and pears. Turn into pastry-lined pan; dot with margarine. Cover with top crust. Brush crust with milk; sprinkle with 1 tablespoon sugar. Trim, seal and flute. Cut small slits in top crust.

Bake 50 to 55 minutes at 400°F. or until juices begin to bubble.

Per Serving:			
Calories:	469	Fat:	23 g.
Protein:	4 g.	Cholesterol:	—
Carbohydrate:	63 g.	Sodium:	302 mg.

White Chocolate Brownie Wedges

- $\frac{1}{2}$ cup margarine or butter
- 4 ounces white chocolate squares, cut into pieces
- 2 eggs
- $\frac{1}{2}$ cup sugar
- 2 teaspoons vanilla extract
- $1\frac{1}{4}$ cups of flour
- $\frac{1}{2}$ cup of semi-sweet chocolate pieces
- $\frac{1}{4}$ cup of Heath Bar candy pieces

Makes 12 wedges

Preheat oven using AUTO BAKE #4. Grease and flour a 9-inch round cake pan. In small bowl, combine butter and 2 ounces of white chocolate squares. Microwave on HIGH (100%) for 1 to 2 minutes until melted. Set aside.

In a small bowl, beat eggs until frothy. Add sugar and continue beating until light in color. Add melted white chocolate and vanilla. Stir in flour and mix well. Fold in remaining 2 ounces of white chocolate, semi-sweet chocolate pieces and Heath pieces. Bake at AUTO BAKE #4. Cool on wire rack. Cut into 12 wedges.

Per Serving:			
Calories:	280	Fat:	16 g.
Protein:	3.5 g.	Cholesterol:	50 mg.
Carbohydrate:	32 g.	Sodium:	44 mg.

No-Knead Cheddar Dill Bread

- 2½ to 3 cups all-purpose flour
- 1 tablespoon sugar
- 2 teaspoons dill weed
- 1 teaspoon dill seeds
- 1 teaspoon salt
- ¼ teaspoon baking soda
- 1 package active dry yeast
- 1 cup small-curd cottage cheese
- ¼ cup water
- 1 tablespoon margarine or butter
- 1 egg
- 2 cups shredded sharp Cheddar cheese
- 1 egg, slightly beaten
- Poppy seeds

Makes one 8-inch round loaf,
16 servings

Combine 1 cup of flour, sugar, dill weed, dill seeds, salt, baking soda and dry yeast in large mixing bowl.

Combine cottage cheese, water and margarine in 2-cup glass measure. Microwave at HIGH (100%) 2 minutes. Add cottage cheese mixture, egg and Cheddar

cheese to dry ingredients. Stir well. Add enough flour to make a stiff dough.

Soak a cloth with hot water, wring it out and place it over mixing bowl. Let dough rise in oven at 100°F. until double in size, about 1 hour.

Grease well an 8-inch round cake pan. Place in pan bottom a wax paper, circle cut to fit. Place a strip of wax paper, 2½ x 25 inches, around pan edge. Grease both wax paper circle and strip. Stir dough down and put in prepared pan, patting the dough to smooth it. Let dough rise in 100°F. oven until double in size, 35 to 45 minutes.

Preheat oven using CONVEC #5.

Brush bread lightly with beaten egg and sprinkle top with poppy seeds. Bake 30 to 40 minutes on CONVEC #5. Remove from pan. Cool on wire rack.

Per Serving:

Calories:	168	Fat:	7 g.
Protein:	8 g.	Cholesterol:	51 mg.
Carbohydrate:	17 g.	Sodium:	319 mg.

----- Cut along this line -----

COOKBOOK INFORMATION

Great recipes

~ Reliable microwave
reference guide

~ Many color photos

~ Step-by-step
instructions

~ Nutritional
information for
each recipe

~ Durable wipe-clean
soft cover with 128

8 1/2 x 11 pages

~ Helpful tips and
special techniques

SHARP® CAROUSEL MICROWAVE COOKBOOK

TO ORDER

Simply call this toll-free number : **1-800-642-2122**.
Please have your credit card ready.

If you prefer to order by mail, complete and return the order form on page 39. Please include check or money order (payable to Sharp Accessories & Supplies Center) for \$6.00 plus \$4.25 shipping & handling and tax, if applicable, per book.

SATISFACTION GUARANTEED

You must be completely satisfied with the Sharp Carousel Microwave Cookbook. If, within 14 days, you are dissatisfied for any reason, simply return the book and we'll gladly refund your \$6.00 plus tax.

(SOLAMENTE ESCRITO EN INGLES!)

BAKING RECIPES

Hearty Cheese Caraway Bread

- 6³/₄ cups all-purpose flour
- 3 tablespoons sugar
- 2¹/₂ teaspoons salt
- ¹/₄ teaspoon baking soda
- 1 package rapid rise yeast
- 2 teaspoons caraway seeds
- 1 cup milk
- 1 cup water
- ¹/₃ cup margarine or butter
- 1³/₄ cups grated sharp Cheddar cheese
- ¹/₄ cup melted margarine or butter (for greasing)

Makes 2 loaves,
24 servings

Set aside 1 cup of flour. In large bowl, mix remaining flour, sugar, salt, baking soda, yeast and caraway seeds. Heat milk, water and ¹/₃ cup of margarine until hot to touch, approximately 2¹/₂ to 3 minutes on MEDIUM (50%); stir into dry ingredients. Mix in only enough reserved flour to make soft dough. Turn out onto lightly floured surface; knead until smooth and elastic, about 8 to 10 minutes. Cover; let rise 10 minutes.

Divide dough in half; roll half into a 15 x 9-inch rectangle. Sprinkle ³/₄ cup of grated cheese evenly over dough. Roll tightly from short end to other. Pinch dough together at ends and along seam. Repeat with second half of dough.

Brush tops of loaves with melted margarine and sprinkle top with 2 tablespoons from the remaining cheese. Press gently on top of loaves. Place each loaf in a buttered 8¹/₂ x 4¹/₂ x 2-inch loaf pan. Let rise in oven on 100°F. 40 minutes.

Preheat oven using CONVEC #5.

Bake 40 to 45 minutes on CONVEC #5 or until golden brown. Remove from pans and cool on wire racks.

Per Serving:			
Calories:	216	Fat:	8 g.
Protein:	6 g.	Cholesterol:	9 mg.
Carbohydrate:	30 g.	Sodium:	343 mg.

Cut along this line

COOKBOOK ORDER FORM

Please send me _____ cookbooks at \$10.25 each \$ _____

Illinois sales tax, (if applicable) per book \$.44 no. of books _____ \$ _____

TOTAL ORDER AMOUNT \$ _____

I have enclosed a check made payable to Sharp Accessories & Supplies Center.

Please bill my VISA MASTERCARD AMERICAN EXPRESS

Acct. No. _____ Expiration date ____ / ____

Signature _____

(All credit card orders must be signed.)

Name _____

Address _____

City _____ State _____ Zip _____

Daytime Phone No. () _____

Mail to: SHARP Accessories & Supplies Center
2130 Townline Road
Peoria, Illinois 61615-1560

Prices are subject to change without notice.

NOTES

REHEAT

- 1 Toque el botón Reheat.
- 2 Seleccione el ajuste de recalentamiento deseado (Por ejemplo, Toque 4 y 2 para calentar rollos/bollos.)
- 3 Toque 2 para 2 rollos/bollos.
- 4 Toque el botón Start/Touch On.

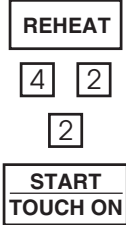

CUADRO DE REHEAT

ALIMENTOS	CANTIDAD
1. Casserole (Caserola)	1 - 4 tazas
2. Dinner Plate (Plato principal)	1 plato 1 Regular 1 Grande 1 Pequeño
3. Bebidas, recalentamiento	.5 - 2 tazas
Bebidas, haga café/té	1 - 4 tazas
4. Rollo/bollo fresco	1 - 6
Rollo/bollo congelado	1 - 6
5. Entradas congeladas	6 - 17 oz.

AUTO DEFROST

- 1 Toque el botón Auto Defrost.
- 2 Seleccione el ajuste Auto Defrost deseado (Por ejemplo: toque 2 para descongelar un churrasco.)
- 3 Toque los botones de números 2 y 0. (Por ejemplo: 2,0 lbs. de carne de churrasco.)
- 4 Toque el botón Start/Touch On. Durante el descongelado, el horno se detendrá: verifique al comida. Toque el botón Start/Touch On para continuar el descongelado.

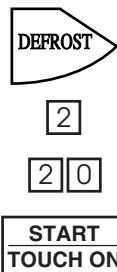

CUADRO DE AUTO DEFROST

ALIMENTOS	CANTIDAD
1. Carne picada	.5 - 3.0 libras
2. Churrasco, chuleta o pescado	.5 - 4.0 libras
3. Pedazos de pollo	.5 - 3.0 libras
4. Asado	2.0 - 4.0 libras
5. Cacerola	2 - 6 tazas

AUTO COOK/BAKE/PIZZA/GRILL/ROAST

- 1 Toque el botón AutoCook.
- 2 Seleccione el ajuste de AutoCook deseado. (Por ejemplo Toque 1 para cocinar papas al horno.)
- 3 Toque 2 para 2 papas al horno.
- 4 Toque el botón Start/Touch On.

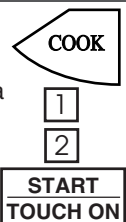

CUADRO DE AUTO COOK

ALIMENTOS	CANTIDAD
1. Papas al horno	1 - 4 medjano
2. Verduras, frescas	1 - 4 tazas
3. Verduras, congeladas	1 - 4 tazas
4. Carne picada	.3 - 1.5 libras
5. Productos del mar, pescado	.3 - 1.5 libras

CUADRO DE AUTO BAKE

ALIMENTOS	CANTIDAD
1. Papas fritas	.3 - 1 libras
2. Bocado congelado	Número que cabe en placa giratoria
3. Torta de chocolate	8" x 8" x 2"
4. Torta para picar	8" x 8" x 2"
5. Bizcochos	8 - 10 (1 paquete de bizcochos convenientes)

CUADRO DE AUTO PIZZA

ALIMENTOS	CANTIDAD
1. Pizza al horno congelada con base normal	1
2. Pizza al horno congelada con base de levadura	1
3. Pizza al horno refrigerada	1
4. Pizza para microondas	1
5. Pizza recalentada	1 - 6 pedazos

CUADRO DE AUTO GRILL

ALIMENTOS	CANTIDAD
1. Hamburguesas	1 - 7 (1/4 lb. c/u)
2. Churrascos	.5 - 2 libras
3. Churrascos de pescado	.5 - 2 libras
4. Pollo sin hueso	.5 - 2 libras
5. Piezas de pollo	.5 - 3 libras

CUADRO AUTO ROAST

ALIMENTOS	CANTIDAD
1. Pollo, pavo (entero)	2.5 - 7 libras
2. Pierna de cerdo	2 - 3.5 libras
3. Pechuga de pavo (con hueso)	3 - 6 libras
4. Rodajas de carne (sin hueso)	2 - 4 libras
5. Codorniz	1 - 6.5 libras

GUIA AUTO-TOUCH

Para mayor información y precauciones de seguridad, consulte el Manual de Operaciones.

FIJACION DEL RELOJ

Si en la pantalla aparece *SHARP SIMPLY THE BEST PRESS CLEAR AND PRESS CLOCK* toque primero Stop/Clear.

1 Toque el botón Clock.

CLOCK

2 Ponga la hora correcta tocando los números en orden. (Ej: 12:30)

1 2 3 0

3 Toque nuevamente el botón Clock.

CLOCK

OPERACION MANUAL

Cocinando con energía alta

1 Programe el tiempo para cocinar tocando los botones de números. (Ej: 1 min. 30 seg.)

1 3 0

2 Toque el botón Start/Touch On.

START
TOUCH ON

Cocinando con energía variable

1 Después del paso 1 anterior, toque el botón Power Level.

POWER
LEVEL

2 Seleccione el nivel de potencia (Por ejemplo: 50%)

5

3 Toque el botón Start/Touch On.

START
TOUCH ON

COCINADO POR CONVECCIÓN

1 Toque el botón Convec.

CONVEC

2 Seleccione el ajuste de Convec deseado. (Por ejemplo Toque 1 para Convección con precalentamiento.)

1

3 Seleccione la temperatura de precalentamiento/cocinado. (Por ejemplo Toque 6 para 350°F.)

6

4 Entre el tiempo de cocinado tocando los botones de número. (Ejemplo: 25 min.)

2 5 0 0

5 Toque el botón Start/Touch On.

START
TOUCH ON

AJUSTES DE CONVECCIÓN

1. Convección con precalentamiento

2. Convección sin precalentamiento

3. Tortas

4. Torta de comida Angel

5. Pan de la levadura

COCINADO POR GRILL

1 Toque el botón Grill.

GRILL

2 Seleccione el ajuste Grill deseado. (Por ejemplo Toque 1 para el grill de arriba y abajo.)

1

3 Entre la hora de grill tocando los botones de número (Ejemplo 20 min.)

2 0 0 0

4 Toque el botón Start/Touch On.

START
TOUCH ON

AJUSTES DE GRILL

1. Grill superior e inferior

2. Sólo grill superior

COCINADO DE ROAST

1 Toque el botón Roast.

ROAST

2 Entre el tiempo de asado tocando los botones de número. (Ejemplo: 25 min.)

2 5 0 0

3 Touch Start/Touch On pad.

START
TOUCH ON

POPCORN

1 Toque el botón Popcorn una vez para el tamaño normal.

POPCORN

2 Toque el botón Start/Touch On.

START
TOUCH ON

* Para las bolsas de tamaño comida rápida, toque el botón POPCORN dos veces y Start/Touch On.

MINUTO EXTRA

Toque el botón Minute Plus para un minuto al 100% de energía, o para añadir un minuto cuando cocine en el modo manual. Continúe tocándolo para añadir más minutos.

MINUTE
PLUS

Touch On

Toque continuamente el botón Start/Touch On para una cocción de potencia al 100%. Suelte su dedo y el horno se detendrá instantáneamente.

START
TOUCH ON

AUTO-TOUCH GUIDE

REHEAT

- 1 Touch Reheat pad.
- 2 Select desired reheat setting.
(Ex. Touch 4 and 2 to warm frozen rolls/muffins.)
- 3 Touch 2 for 2 rolls/muffins.
- 4 Touch Start/Touch On pad.

REHEAT

4 2

2

START
TOUCH ON

REHEAT CHART

FOOD	AMOUNT
1. Casserole	1 - 4 cups
2. Dinner Plate	1 plate 1 Regular 1 Large 1 Small
3. Beverage, reheat	.5 - 2 cups
Beverage, make coffee/tea	1 - 4 cups
4. Roll/muffin, fresh	1 - 6
Roll/muffin, frozen	1 - 6
5. Frozen entrees	6 - 17 oz.

AUTO DEFROST

- 1 Touch AutoDefrost pad.
- 2 Select desired AutoDefrost setting.
(Ex: touch 2 to defrost steak.)
- 3 Touch number pad 2 and 0.
(Ex: 2.0 lb steak.)
- 4 Touch Start/Touch On pad. During defrosting, the oven will stop; check food. Touch Start/Touch On pad to continue defrosting.

DEFROST

2

2 0

START
TOUCH ON

AUTO DEFROST CHART

FOOD	AMOUNT
1. Ground meat	.5 - 3.0 lb
2. Steaks, chops or fish	.5 - 4.0 lb
3. Chicken pieces	.5 - 3.0 lb
4. Roast	2.0 - 4.0 lb
5. Casserole	2 - 6 cups

AUTOCOOK/BAKE/PIZZA/ GRILL/ROAST

- 1 Touch AutoCook pad.
- 2 Select desired AutoCook setting.
(Ex. Touch 1 to cook baked potatoes.)
- 3 Touch 2 for 2 baked potatoes.
- 4 Touch Start/Touch On pad.

COOK

1

2

START
TOUCH ON

AUTO COOK CHART

FOOD	AMOUNT
1. Baked potatoes	1 - 4 medium
2. Vegetables, fresh	1 - 4 cups
3. Vegetables, frozen	1 - 4 cups
4. Ground meat	.3 - 1.5 lb
5. Seafood, fish	.3 - 1.5 lb

AUTO BAKE CHART

FOOD	AMOUNT
1. French fries	.3 - 1 lb
2. Frozen snack	Number which fits on turntable.
3. Brownies	8" x 8" x 2"
4. Snack cake	8" x 8" x 2"
5. Biscuits	8 - 10 (1 package of convenience biscuits)

AUTO PIZZA CHART

FOOD	AMOUNT
1. Bake frozen pizza regular crust	1
2. Bake frozen pizza rising crust	1
3. Bake refig pizza	1
4. Microwave pizza	1
5. Reheat pizza	1 - 6 slices

AUTO GRILL CHART

FOOD	AMOUNT
1. Hamburgers	1 - 7 (1/4 lb each)
2. Steaks	.5 - 2 lb
3. Fish steaks	.5 - 2 lb
4. Boneless poultry	.5 - 2 lb
5. Chicken pieces	.5 - 3 lb

AUTO ROAST CHART



FOOD	AMOUNT
1. Chicken, turkey (whole)	2.5 - 7 lb
2. Pork loin	2 - 3.5 lb
3. Turkey breast (bone in)	3 - 6 lb
4. Beef eye of round (boneless)	2 - 4 lb
5. Cornish hens	1 - 6.5 lb

AUTO-TOUCH GUIDE

For more complete information and safety precautions, refer to your Operation Manual.

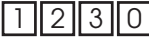

SET CLOCK

If SHARP SIMPLY THE BEST PRESS CLEAR AND PRESS CLOCK is in the display, first touch Stop/Clear.

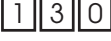

- 1 Touch Clock pad. 
- 2 Enter correct time of the day by touching numbers in sequence. 
- 3 Touch Clock pad again. 

MANUAL OPERATION





High Power Cooking

- 1 Enter cooking time by touching number pads. (Ex: 1 min. 30 sec.) 

- 2 Touch Start/Touch On pad.

Variable Power Cooking

- 1 After Step 1 above, touch Power Level pad. 

- 2 Select power level. (Ex: 50%.)
- 3 Touch Start/Touch On pad. 





CONVECTION COOKING

- 1 Touch Convec pad. 
- 2 Select desired Convec setting. (Ex. Touch 1 for Convection with preheat.) 
- 3 Select preheat/cooking temperature. (Ex. Touch 6 for 350 °F.) 
- 4 Enter cooking time by touching number pads. (Ex. 25 min.) 
- 5 Touch Start/Touch On pad. 

CONVECTION SETTINGS

1. Convection with preheat
2. Convection without preheat
3. Cakes
4. Angel food cake
5. Yeast bread



GRILL COOKING

- 1 Touch Grill pad. 
- 2 Select desired Grill setting. (Ex. Touch 1 for top and bottom grill.) 
- 3 Enter grilling time by touching number pads. (Ex. 20 min.) 
- 4 Touch Start/Touch On pad. 



GRILL SETTINGS

1. Top and Bottom Grill
2. Top Grill only

ROAST COOKING

- 1 Touch Roast pad. 
- 2 Enter roasting time by touching number pads. (Ex. 25 min.) 
- 3 Touch Start/Touch On pad. 

POPCORN

- 1 Touch Popcorn pad once for regular size. 
 - 2 Touch Start/Touch On pad. 
- * For snack size bags, touch POPCORN pad twice and Start/Touch On.

MINUTE PLUS

Touch Minute Plus for one minute at 100% power or to add a minute during manual cooking. Continue to touch for additional minutes. 

Touch On

Continuously touch Start/Touch On pad for 100% power cooking. Remove finger and oven will stop instantly. 

Continued on the Inside Back Cover

Carousel® is registered trademarks of Sharp Corporation.

SHARP

SHARP ELECTRONICS CORPORATION
Sharp Plaza, Mahwah, NJ 07430-2135

TINSEB053WRRZ-D41
Printed in Thailand

Free Manuals Download Website

<http://myh66.com>

<http://usermanuals.us>

<http://www.somanuals.com>

<http://www.4manuals.cc>

<http://www.manual-lib.com>

<http://www.404manual.com>

<http://www.luxmanual.com>

<http://aubethermostatmanual.com>

Golf course search by state

<http://golfingnear.com>

Email search by domain

<http://emailbydomain.com>

Auto manuals search

<http://auto.somanuals.com>

TV manuals search

<http://tv.somanuals.com>