

MODEL  
**FO-P610/FO-P630**

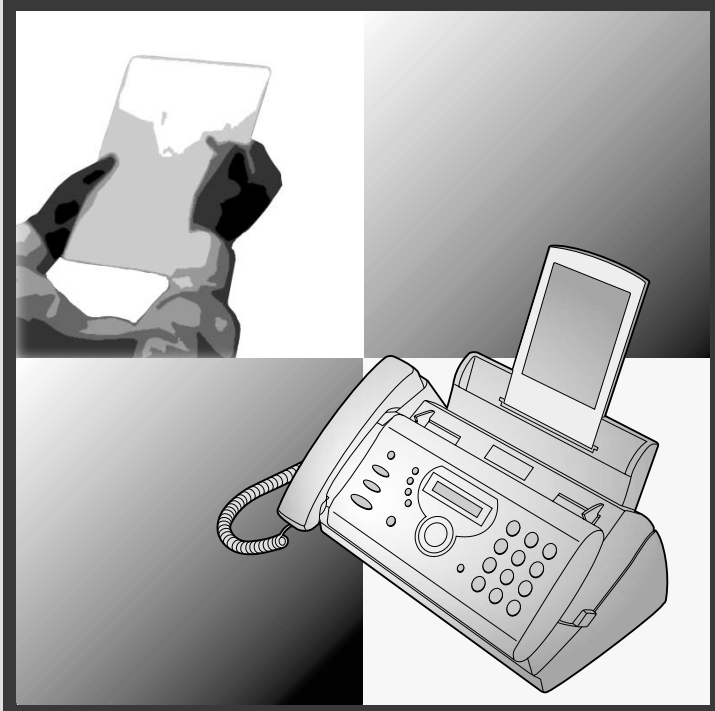

***FACSIMILE***  
OPERATION MANUAL

1. Installation
2. Sending Faxes
3. Receiving Faxes
4. Making Copies
5. Answering Machine Connection
6. Special Functions
7. Printing Lists
8. Maintenance
9. Troubleshooting

**SHARP®**

# SHARP

## WARRANTY

*Facsimile Products*

### Congratulations on Your Purchase!

This Sharp product is warranted against manufacturing defects for a period of twelve (12) months from the date of original purchase.

In the event of any defect arising in the equipment during the warranty period, such repairs should only be carried out by the Dealer from which the unit was originally purchased or a Service Centre approved by Sharp to service this type of equipment. These repairs would be carried out at no charge to the owner, subject to the conditions specified herein.

The owner is responsible for any transportation and insurance costs if the product has to be returned for repair.

This warranty does not extend to accessories or defects or injuries caused by or resulting from causes not attributable to faulty parts or the manufacture of the product, including but not limited to, defect or injury caused by or resulting from misuse, abuse, neglect, accidental damage, improper voltage, liquid spillage, vermin infestation, software, use of consumables other than those approved by Sharp, or any alterations made to the product which are not authorised by Sharp.

Please retain your sales documentation, as this should be produced to validate a warranty claim.

This warranty is in addition to and in no way limits, varies or excludes any express and implied rights and remedies under any relevant legislation in the country of sale. However, to the extent permitted by such legislation, Sharp excludes any liability for any indirect or consequential damages arising from the purchase or use of the product.

To the extent permitted by law, Sharp excludes all implied warranties and conditions and where the product is one that is not normally required for personal, domestic or household use, Sharp limits its liability to the repair or replacement (at Sharp's option) of materials or workmanship which are found by Sharp to be defective.

For your reference, please enter the particulars of your purchase below and retain, with your purchase documentation.

Model No. \_\_\_\_\_

Serial No. \_\_\_\_\_

Date of Purchase \_\_\_\_\_

Place of Purchase \_\_\_\_\_

SPform046 (Dec2001)

FOR LOCATION ENQUIRIES WITHIN  
**AUSTRALIA**  
REGARDING YOUR LOCAL  
SHARP APPROVED SERVICE CENTRE

CALL SHARP

LOCAL CALL: **1 300 135 022**  
FACSIMILE: (02) 9672 1210

WEB: [www.sharp.net.au](http://www.sharp.net.au)

SHARP CORPORATION OF AUSTRALIA PTY. LIMITED  
A.B.N. 40 003 039 405  
1 Huntingwood Drive, Huntingwood NSW 2148

FOR THE SERVICING OF PRODUCTS  
PURCHASED IN  
**NEW ZEALAND**  
CONTACT YOUR SELLING DEALER/RETAILER  
OR FOR REFERRAL TO A  
SERVICE CENTRE,  
CALL SHARP CUSTOMER SERVICES  
TELEPHONE: **09 573 0111**  
FACSIMILE: 09 573 0113  
WEB: [www.sharpnz.co.nz](http://www.sharpnz.co.nz)

SHARP CORPORATION OF NEW ZEALAND LIMITED  
59 Hugo Johnston Drive Penrose, Auckland

Important Notice: This warranty applies only to products sold in Australia & New Zealand

# Introduction

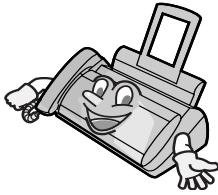

Welcome, and thank you for choosing a Sharp fax machine! The features and specifications of your new Sharp fax are shown below.

<b>Automatic dialling</b>	30 numbers
<b>Imaging film</b>	<b>Initial starter roll</b> (included with machine): 10 m (approx. 30 A4 pages) <b>Replacement roll</b> (not included): <b>FO-9CR</b> 60 m (one roll yields approx. 180 A4 pages)
<b>Memory size*</b>	448 KB (approx. 24 average pages)
<b>Modem speed</b>	<b>FO-P610:</b> 9,600 bps <b>FO-P630:</b> 14,400 bps (With automatic fallback to lower speeds)
<b>Transmission time*</b>	<b>FO-P610:</b> Approx. 15 seconds <b>FO-P630:</b> Approx. 6 seconds (memory transmission)
<b>Resolution</b>	<b>Horizontal:</b> 8 pels/mm <b>Vertical:</b> Standard: 3.85 lines/mm Fine /Halftone: 7.7 lines/mm Super fine: 15.4 lines/mm
<b>Automatic document feeder</b>	10 pages max. (A4 size, 80 g/m <sup>2</sup> paper)
<b>Recording system</b>	Thermal transfer recording
<b>Halftone (grayscale)</b>	64 levels
<b>Compression scheme</b>	<b>FO-P610:</b> MR, MH, Sharp (H2) <b>FO-P630:</b> MR, MH, MMR
<b>Paper tray capacity</b> (60 - 80 g/m <sup>2</sup> paper)	Approx. 50 A4-size sheets (at room temperature; maximum stack height should not cover the line on the tray)

\*Based on Sharp Standard Chart at standard resolution in Sharp special mode, excluding time for protocol signals (i.e., ITU-T phase C time only).

<b>Display</b>	16-digit LCD display
<b>Applicable telephone line</b>	Public switched telephone network
<b>Compatibility</b>	ITU-T (CCITT) G3 mode
<b>Input document size</b>	<b>Automatic feeding:</b> Width: 148 to 210 mm Length: 140 to 297 mm <b>Manual feeding:</b> Width: 148 to 210 mm Length: 140 to 600 mm
<b>Effective scanning width</b>	210 mm max.
<b>Effective printing width</b>	204 mm max.
<b>Contrast control</b>	Automatic/Dark selectable
<b>Reception modes</b>	TEL/FAX, TEL, FAX, A.M. (Note: A.M. mode is for connecting an answering machine)
<b>Copy function</b>	Single / Multi (99 copies/page)
<b>Telephone function</b>	Yes (cannot be used if power fails)
<b>Power requirements</b>	230 - 240 V AC, 50 Hz
<b>Operating temperature</b>	5 - 35°C
<b>Humidity</b>	25 - 85% RH
<b>Power consumption</b>	Standby: 2.8 W Maximum: 110 W
<b>Dimensions</b> (without attachments)	Width: 327 mm Depth: 193 mm Height: 163 mm
<b>Weight</b> (without attachments)	Approx. 2.8 kg

As a part of our policy of continuous improvement, SHARP reserves the right to make design and specification changes for product improvement without prior notice. The performance specification figures indicated are nominal values of production units. There may be some deviations from these values in individual units.

## ***Important safety information***

For your safety, if any of your equipment is not operating properly or should any physical damage occur to the equipment where internal parts may become exposed, the equipment should be immediately disconnected from the phone line and then the power line and returned to a SHARP authorised Service Centre for inspection, repair, or disposal.

In Australia, installing or modifying telephone lines should only be done by an ACA licensed serviceman. In New Zealand, installing or modifying telephone lines should be done in accordance with Telecom wiring practices.

This facsimile machine is designed for use in Australia and New Zealand only.

Do not disassemble this machine or attempt any procedures not described in this manual. Refer all servicing to qualified service personnel.

Do not install or use the machine near water, or when you are wet. For example, do not use the machine near a bath tub, wash bowl, kitchen sink or laundry tub, in a wet basement, or near a swimming pool. Take care not to spill any liquids on the machine.

Unplug the machine from the telephone socket and then the power outlet and consult a qualified service representative if any of the following situations occur:

- Liquid has been spilled into the machine or the machine has been exposed to rain or water.
- The machine produces odors, smoke, or unusual noises.
- The power cord is frayed or damaged.
- The machine has been dropped or the housing damaged.

Do not allow anything to rest on the power cord, and do not install the machine where people may walk on the power cord.

This machine must only be connected to a 230 - 240 V, 50 Hz, earthed (3-prong) outlet. Connecting it to any other kind of outlet will damage the machine and invalidate the warranty.

Never insert objects of any kind into slots or openings on the machine. This could create a risk of fire or electric shock. If an object falls into the machine that you cannot remove, unplug the machine and consult a qualified service representative.

Do not place this machine on an unstable cart, stand or table. The machine could be seriously damaged if it falls.

Never install telephone wiring during a lightning storm.

Never install telephone sockets in wet locations unless the socket is specifically designed for wet locations.

Never touch bare telephone wires or terminals unless the telephone line has been disconnected at the network interface.

Use caution when installing or modifying telephone lines.

Avoid using a telephone (other than a cordless type) during an electrical storm. There may be a remote risk of electric shock from lightning.

Do not use a telephone to report a gas leak in the vicinity of the leak.

The power outlet must be installed near the equipment and must be easily accessible.

**WARNING NOTICE:**

**NO** calls can be made to or from this fax machine during a mains power failure.

**WARNING:** Australian Communications Authority (ACA) regulations state that no unauthorised changes or modifications to this equipment are permitted.

**Note:** Complies with ACA and NZ TELECOM standard AS/NZS3548 regarding emission of electromagnetic interference.

These limits are designed to provide reasonable protection against interference in an installation. This equipment generates, uses, and can radiate radio frequency energy and, if not installed and used in accordance with the instructions, may cause interference. However, there is no guarantee that interference will not occur in a particular installation.

If this equipment does cause interference to radio or television reception, which can be determined by turning the equipment off and on, the user is encouraged to try to correct the interference by one or more of the following measures:

- Reorient or relocate the receiving antenna.
- Increase the separation between the equipment and the receiver.
- Connect the equipment to an outlet on a different circuit to that which the receiver is connected.
- Consult the dealer or an experienced radio/TV technician for help.

**For Australia:** The Ringer Equivalence Number (REN) for this equipment is written on the back of the machine. The sum of all Ringer Equivalence Numbers (REN's) on your telephone line should not exceed 3 to assure correct service from your telephone company.

#### **IMPORTANT NOTICE FOR NEW ZEALAND USERS**

Please note:

The grant of a Telepermit for any item of terminal equipment indicates only that Telecom has accepted that the item complies with the minimum conditions for connection to its network. It indicates no endorsement of the product by Telecom, nor does it provide any sort of warranty. Above all, it provides no assurance that any item will work correctly in all respects with another item of Telepermitted equipment of a different make or model, nor does it imply that any product is compatible with all of Telecom's network services.

This equipment shall not be set up to make automatic calls to the Telecom `111' Emergency Service.

To avoid telephone charges for local calls, be sure to store numbers without area code in your auto-dial locations.

This equipment may not provide for the effective hand-over of a call to another device connected to the same line.

---

# ***Table of Contents***

<b>Introduction</b>	<b>1</b>
<hr/>	
<b>A Look at the Operation Panel</b>	<b>7</b>
<hr/>	
<b>1. Installation</b>	<b>10</b>
<hr/>	
Unpacking Checklist . . . . .	10
Connections . . . . .	11
Loading the Imaging Film . . . . .	15
Loading Printing Paper . . . . .	17
Entering Your Name and Fax Number . . . . .	19
Setting the Date and Time . . . . .	21
Setting the Reception Mode . . . . .	23
Volume Adjustment . . . . .	24
<b>2. Sending Faxes</b>	<b>26</b>
<hr/>	
Transmittable Documents . . . . .	26
Loading the Document . . . . .	27
Adjusting the Resolution and Contrast . . . . .	28
Sending a Fax by Normal Dialling . . . . .	30
Sending a Fax by Automatic Dialling . . . . .	31
Sending a Fax From Memory . . . . .	39
<b>3. Receiving Faxes</b>	<b>41</b>
<hr/>	
Using TEL/FAX Mode . . . . .	41
Using A.M. Mode . . . . .	42
Using FAX Mode . . . . .	43
Using TEL Mode . . . . .	44
Optional Reception Settings . . . . .	47
Substitute Reception to Memory . . . . .	49
<b>4. Making Copies</b>	<b>50</b>
<hr/>	

<b>5. Answering Machine Connection</b>	<b>52</b>
Connecting an Answering Machine . . . . .	52
Using the Answering Machine Connection . . . . .	53
Optional A.M. Mode Settings . . . . .	54
<b>6. Special Functions</b>	<b>58</b>
Caller ID (Requires Subscription to Service) . . . . .	58
Distinctive Ring (Requires Subscription to Service) . . . . .	63
Blocking Reception of Unwanted Faxes . . . . .	64
Polling (Requesting a Fax Transmission) . . . . .	65
<b>7. Printing Lists</b>	<b>66</b>
<b>8. Maintenance</b>	<b>69</b>
<b>9. Troubleshooting</b>	<b>72</b>
Problems and Solutions . . . . .	72
Messages and Signals . . . . .	77
Clearing Paper Jams . . . . .	80
<b>Quick Reference Guide</b>	<b>82</b>
<b>Index</b>	<b>83</b>



# A Look at the Operation Panel

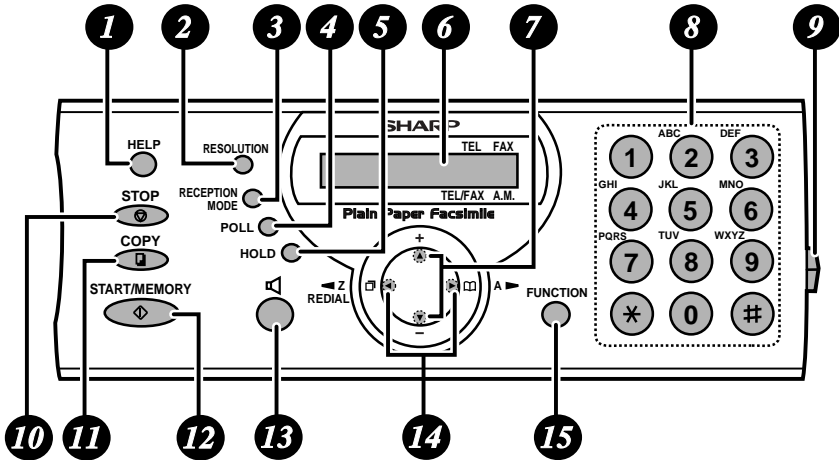



- 1 HELP key**  
Press this key to print out the Help List, a quick reference guide to the operation of your fax machine.
- 2 RESOLUTION key**  
When a document is in the feeder, press this key to adjust the resolution for faxing or copying (page 28).
- 3 RECEPTION MODE key**  
Press this key to select the reception mode (an arrow in the display will point to the currently selected reception mode; page 23).
- 4 POLL key**  
Press this key after dialling another fax machine to receive a document (previously loaded in the other machine's feeder) without assistance from the operator of the other machine (page 65).
- 5 HOLD key**  
Press this key to put the other party on hold during a phone conversation (page 46).
- 6 Display**  
This displays messages and prompts to help you operate the machine.

- 7 UP and DOWN arrow keys**  
**Enlarge/reduce setting:** When making a copy of a document, press these keys to select an enlarge/reduce setting (page 50).  
**Volume setting:** When a document is not in the feeder, press these keys to change the speaker volume when the **SPEAKER** key has been pressed, or the ringer volume at any other time (page 24).  
**FUNCTION key settings:** Press these keys after pressing the **FUNCTION** key to scroll through the FUNCTION MODE settings.
- 8 Number keys**  
Use these keys to dial numbers, and enter numbers and letters when storing auto-dial numbers.
- 9 Panel release**  
Press this release to open the operation panel.
- 10 STOP key**  
Press this key to cancel an operation before it is completed.
- 11 COPY key**  
When a document is in the feeder, press this key to make a copy of a document (page 50).
- 12 START/MEMORY key**  
Press this key after dialling to begin fax transmission (page 30). Press this key before dialling to send a fax through memory (page 39).
- 13 SPEAKER key**  
Press this key to listen to the line and fax tones through the speaker when faxing a document.
- 14 Left and right arrow keys**  
**Auto-dial numbers:** When sending a fax or making a phone call, press these keys to scroll through your auto-dial numbers (page 34), the "REVIEW CALLS" list (only available if you have Caller ID; page 58), and the last number dialled (redial; page 36).  
**FUNCTION key settings:** Press the right arrow key after scrolling with the up and down arrow keys to select a **FUNCTION** key setting.
- 15 FUNCTION key**  
Press this key followed by the arrow keys to select special functions and settings.

## ***Monitoring phone conversations***

When speaking through the handset, you can press  to allow a third person to listen to the conversation through the speaker. (To turn off the speaker, press the key again.)

To adjust the volume of the speaker when monitoring a conversation, press  for high or  for low (the volume setting reverts to low each time the handset is replaced).

Note that **the speaker cannot be used for speaking**; it is only for listening.

To avoid feedback (a loud howling sound), be sure to turn off the speaker (press  once again) before you replace the handset.

# 1. Installation

## Unpacking Checklist

Before setting up, make sure you have all of the following items.



If any are missing, contact your dealer or retailer.



Paper tray

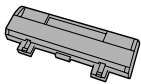

Paper tray extension

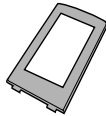

Operation manual



Gears (2)



Adapter (for Australia)



Handset



Handset cord

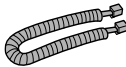

Telephone line cord



Imaging film (initial starter roll)

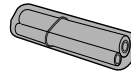

Adapter (for New Zealand)

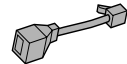

## Points to keep in mind when setting up

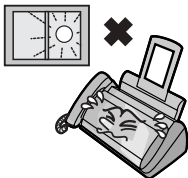

Do not place the machine in direct sunlight.

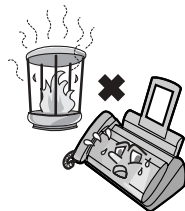

Do not place the machine near heaters or air conditioners.

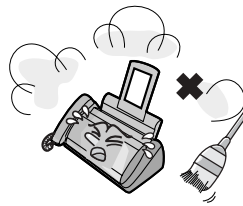

Keep dust away from the machine.

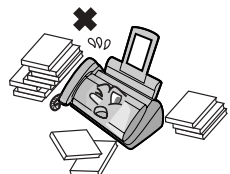

Keep the area around the machine clear.

### About condensation

If the machine is moved from a cold to a warm place, it is possible that condensation may form on the scanning glass, preventing proper scanning of documents for transmission. To remove the condensation, turn on the power and wait approximately two hours before using the machine.

# Connections

## Connecting the handset

Connect the handset as shown and place it on the handset rest.

- ◆ The ends of the handset cord are identical, so they will go into either socket.

Make sure the handset cord goes into the socket marked with a handset symbol on the side of the machine!

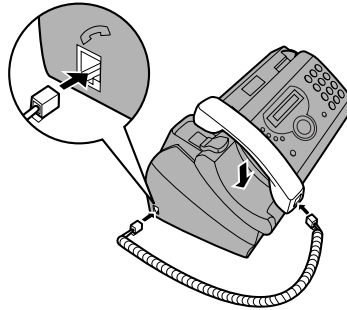
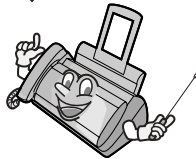

Use the handset to make ordinary phone calls, or to transmit and receive faxes manually.

## Connecting the power cord

Plug the power cord into a 230 - 240 V, 50 Hz, earthed AC (3-prong) outlet.

- ◆ When disconnecting the fax, unplug the telephone line cord before unplugging the power cord.
- ◆ Caution: The power outlet must be installed near the equipment and must be easily accessible.

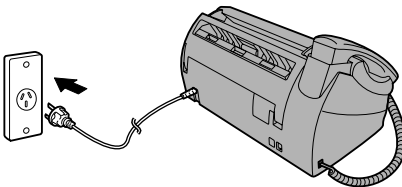

The machine does not have a power on/off switch, so the power is turned on and off by simply plugging in or unplugging the power cord.







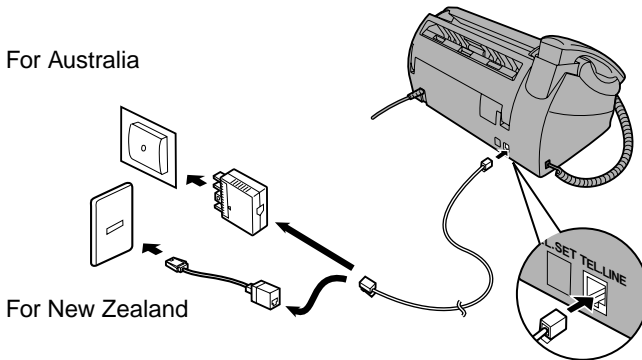





## Connecting the telephone line cord

Insert one end of the telephone line cord into the adapter. Insert the other end of the line cord into the socket on the back of the machine marked **TEL. LINE**. Plug the adapter into the telephone socket on the wall.



### Setting the dial mode:

The fax machine is set for tone dialling. If you are on a pulse dial line, you must set the fax machine for pulse dialling. Press the keys on the operation panel as follows:

- |  |  |
|--|--|
| <p><b>1</b> Press <b>FUNCTION</b>  <b>once</b> and  <b>once.</b></p>               | <p>Display:</p> <p><b>OPTION SETTING</b> </p>                                      |
| <p><b>2</b> Press  <b>once</b> and  <b>3 times.</b></p>                        | <p><b>DIAL MODE</b> </p>  |
| <p><b>3</b> Press  <b>once.</b></p>   | <p><b>1=TONE, 2=PULSE</b></p>  |
| <p><b>4</b> <b>Select the dial mode:</b><br/> <b>TONE:</b>  <b>PULSE:</b> </p> | <p>The display briefly shows your selection, then:</p> <p><b>PSEUDO RING</b> </p> |
| <p><b>5</b> Press <b>STOP</b>  <b>to exit.</b></p>  |  |

**Note:** For all units installed in New Zealand, select "1" for tone dialling. The pulse setting "2" will not operate correctly and must not be used.

**Comments:**

- ◆ The fax machine is not designed for use on a line which has call waiting, call forwarding, or certain other special services offered by your telephone company. If you attempt to use the fax machine in conjunction with any of these services, you may experience errors during transmission and reception of facsimile messages.
- ◆ The fax machine is not compatible with digital telephone systems.
- ◆ If your area experiences a high incidence of lightning or power surges, we recommend that you install surge protectors for the power and telephone lines. Surge protectors can be purchased from your dealer or at most telephone specialty stores.

***Moving your fax and reconnecting***

Should it be necessary to move your fax to a new location, first disconnect the telephone line cord before disconnecting the power lead. When reconnecting, it is necessary to connect the power lead before connecting the telephone line cord.

***Attach the paper tray and paper tray extension***

Attach the paper tray

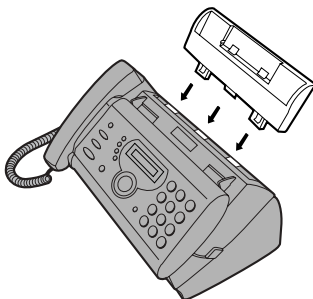

Attach the paper tray extension

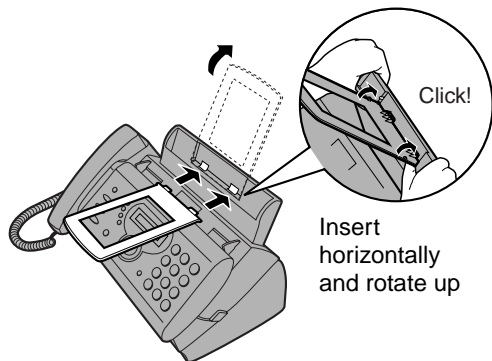

**Note:** The paper tray extension has a top side and a bottom side. If you cannot insert the tabs into the holes, turn the support over.

## Extension phone (optional)

If desired, you can connect an extension phone to the **TEL. SET** socket on the fax.

- ◆ To connect an answering machine to your fax, see page 52.

- 1** Remove the seal covering the **TEL. SET** socket.

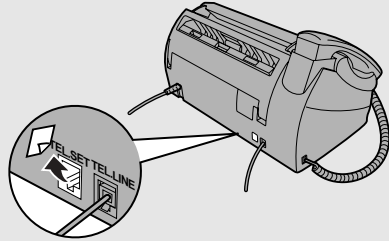

- 2** Connect the extension phone line to the **TEL. SET** socket.

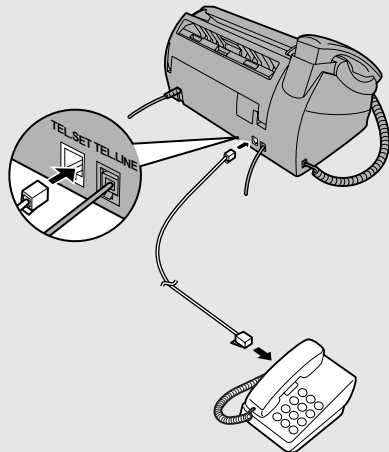

**Note:** In New Zealand, not all standard telephones and answering machines will respond to incoming ringing when connected to the extension socket of the equipment.



## Loading the Imaging Film

Your fax uses a roll of imaging film to create printed text and images. The print head in the fax applies heat to the imaging film to transfer ink to the paper. Follow the steps below to load or replace the film.

- ◆ The initial starter roll of imaging film included with the machine can print about 30 A4-size pages.
- ◆ When replacing the film, use a roll of SHARP **FO-9CR** imaging film. One roll can print about 180 A4-size pages.

### Important!

If the wrong type of film is loaded, printing will not be possible.

### Near end of film detection:

At approximately 3 m from the end of the imaging film (approximately 10 pages can still be printed), "NEAR END OF FILM / REPLACE FILM" will appear in the display. This alerts you that you will soon need to replace the film. Correct operation of this function is only guaranteed when SHARP **FO-9CR** imaging film is used.

- 1** Remove the paper from the paper tray and open the operation panel (press **1**).

If you are loading the imaging film for the first time, go to Step 4.

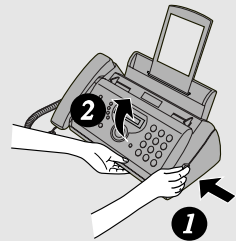

- 2** Remove the used film and empty spool.

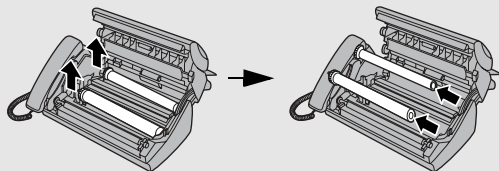

- 3** Remove the two green gears from the spools. **DO NOT DISCARD THE TWO GREEN GEARS!**

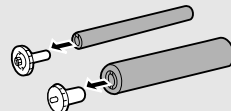

**4 Remove the new roll of imaging film from its packaging.**

- Cut the band that holds the rolls together.

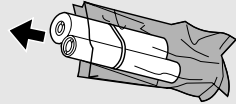

**5 Insert the green gears.**

Make sure the gears fit into the slots in the ends of the rolls.

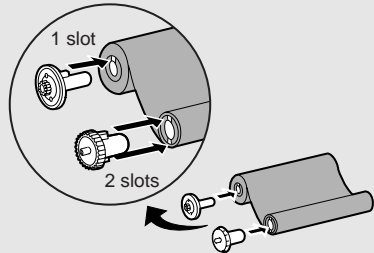

**6 Insert the film into the print compartment.**

Fit ends of rolls onto hubs

Ensure that both gears are properly seated by pushing down lightly on the gears.

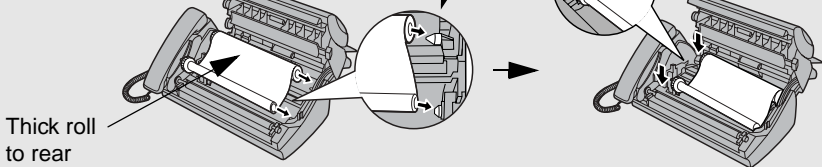

**7 Rotate the front gear as shown until the film is taut.**

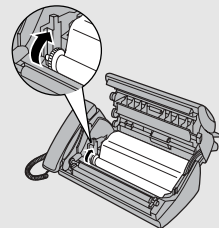

**8 Close the operation panel (press down on both sides to make sure it clicks into place).**

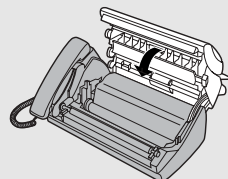

## Loading Printing Paper

You can load up to 50 sheets of A4-size, 60 - 80 g/m<sup>2</sup> paper in the paper tray (at room temperature; maximum stack height should not be higher than the line on the tray).

- 1 Fan the paper, and then tap the edge against a flat surface to even the stack. Make sure the stack edges are even.**

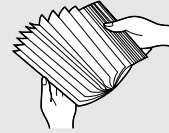

- 2 Insert the stack of paper into the tray, *PRINT SIDE DOWN*.**

- If paper remains in the tray, take it out and combine it into a single stack with the new paper.
- Be sure to load the paper so that printing takes place on the **print** side of the paper. Printing on the reverse side may result in poor print quality.
- **GENTLY LOAD PAPER INTO THE PAPER TRAY.**
- **DO NOT FORCE IT DOWN INTO THE FEED SLOT.**

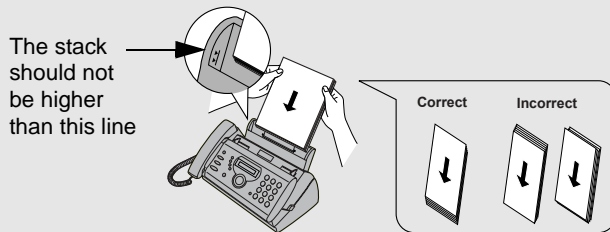

**Note:** Do not use paper that has already been printed on, or paper that is curled.

**Note:** If at any time the display shows the alternating messages at right, check the printing paper. If the tray is empty, add paper. If there is paper in the tray, take it out and then reinsert it.

When you are finished, press **START/MEMORY** .

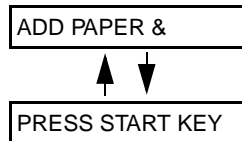



## Print contrast setting

Your fax has been set at the factory to print at normal contrast. If desired, you can change the print contrast setting to LIGHT.

**1** Press **FUNCTION** once and  once. Display: OPTION SETTING 

**2** Press  once and  twice. PRINT CONTRAST 

**3** Press  once. 1:NORMAL

**4** Select the print contrast:  
NORMAL: 1 LIGHT: 2 COPY CUT-OFF 

The display briefly shows your selection, then:

**5** Press  to return to the date and time display.

# Entering Your Name and Fax Number

Before you begin sending faxes, enter your name and fax (telephone) number as explained below and set the date and time as explained on page 21.

Once you enter this information, it will automatically appear at the top of each fax page you send.

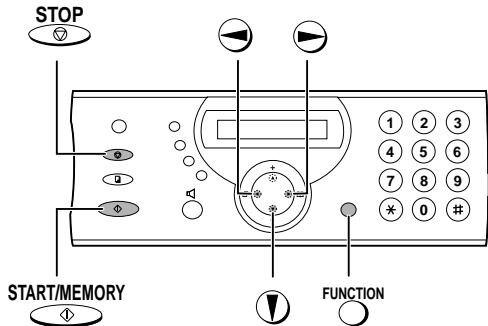

**1** Press **FUNCTION** once and **STOP** twice.

Display:

ENTRY MODE

**2** Press **START/MEMORY** once.

OWN NUMBER SET

**3** Press **START/MEMORY** once.

ENTER FAX #

**4 Enter your fax number by pressing the number keys (max. 20 digits).**

- To insert a space between digits, press . To enter a "+", press .
- To clear a mistake, press .

**5 Press to enter the fax number in memory.**

**6 Enter your name by pressing number keys for each letter as shown in the chart below. Up to 24 characters can be entered.**

Example: SHARP = 7777 44 2 777 7

SPACE =	G =	N =	U =
A =	H =	O =	V =
B =	I =	P =	W =
C =	J =	Q =	X =
D =	K =	R =	Y =
E =	L =	S =	Z =
F =	M =	T =	

- ◆ To enter two letters in succession that require the same key, press after entering the first letter.
- ◆ To clear a mistake, press .
- ◆ To enter a lower case letter, continue pressing the key for the letter until the lower case letter appears. To enter one of the following symbols, press or repeatedly: . / ! " # \$ % & ' ( ) \* + , - ; < = > ? @ [ ¥ ] ^ \_ ' { | } → ←

**7 Press to**

Display:

**DATE&TIME SET**

**8 Press to return to the date and time display.**

## Setting the Date and Time

The date and time appear in the display and are printed at the top of every page you fax. Set the date and time as shown below.

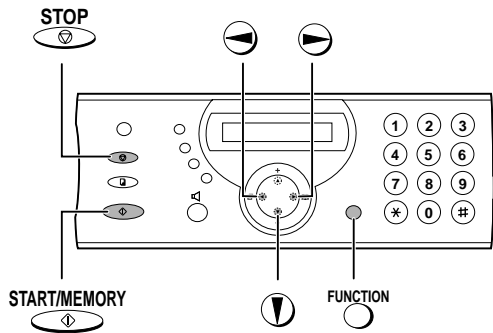
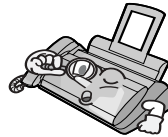

**1** Press **FUNCTION** once and **STOP** twice. Display: **ENTRY MODE**

**2** Press **RIGHT** once and **STOP** once. **DATE&TIME SET**

**3** Press **RIGHT** once. The currently set date appears (example): **DATE 15-08-2003**

**4** Enter a two-digit number for the day ("01" to "31").

Example: the 5<sup>th</sup> **0** **5** → **DATE 05-08-2003**

- To correct a mistake, press **LEFT** to move the cursor back to the mistake and then enter the correct number.

## Setting the Date and Time

- 5** Enter a two-digit number for the month (“01” for January, “02” for February, “12” for December, etc.).

Example: January 0 1 → DATE 05-01-2003

- 6** Enter the year (four digits).

The currently set time appears (example):

Example: 2003 2 0 0 3 → TIME 12:19

- 7** Enter a two-digit number for the hour (“00” to “23”) and a two-digit number for the minute (“00” to “59”).

Example: 9:25 0 9 2 5 → 05-JAN 09:25

- 8** Press **START/MEMORY** to start the clock. → ANTI JUNK #

- 9** Press **STOP** to return to the date and time display.



## Setting the Reception Mode

Your fax has four modes for receiving incoming faxes:

### FAX mode:

Select this mode when you only want to receive faxes on your line. The fax machine will automatically answer all calls and receive incoming faxes.

### TEL mode:

This mode is the most convenient for receiving phone calls. Faxes can also be received; however, all calls must first be answered by picking up the fax's handset or an extension phone connected to the same line.

### TEL/FAX mode:

This mode is convenient for receiving both faxes and voice calls. When a call comes in, the fax will detect whether it is a voice call (including manually dialed faxes), or an automatically dialed fax. If it is a voice call, the fax will make a special ringing sound to alert you to answer. If it is an automatically dialed fax, reception will begin automatically.

### A.M. mode:

Use this mode only if you have connected an answering machine to the fax (see Chapter 5). Select this mode when you go out to receive voice messages in your answering machine and faxes on your fax machine.

## Setting the reception mode

Press **RECEPTION MODE** until the arrow in the display points to the desired mode.

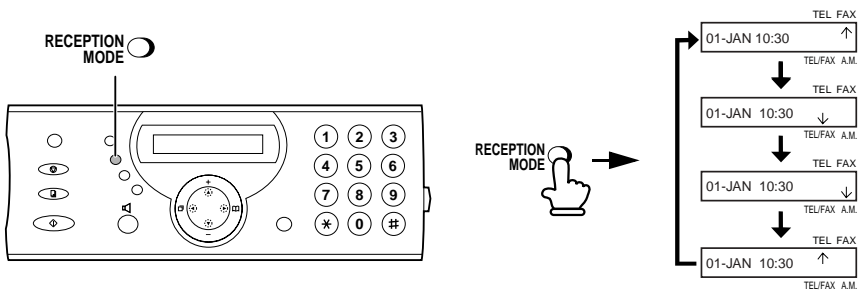

For more information on receiving faxes in FAX, TEL, and TEL/FAX modes, see Chapter 3, *Receiving Faxes* (page 41). For more information on using A.M. mode, see Chapter 5.

## Volume Adjustment

You can adjust the volume of the speaker and ringer using the up and down arrow keys.

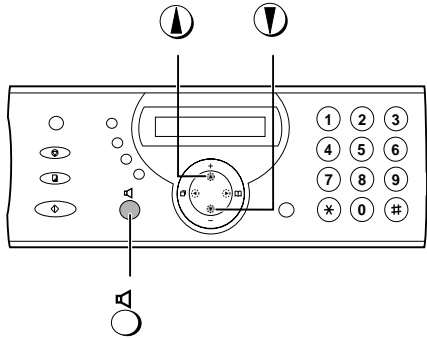

## Speaker

**1** Press 

**2** Press  or  until the display shows the desired volume level.

- Press  again to turn off the speaker.

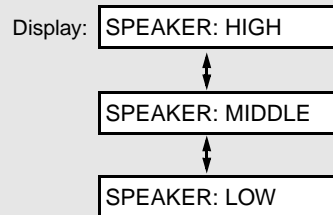

## Ringer

**1** Press  or .

(Make sure  has not been pressed and a document is not loaded in the feeder.)

- The ringer will ring once at the selected level, then the date and time will reappear in the display.

Display:

RINGER: HIGH



RINGER: MIDDLE



RINGER: LOW



RINGER: OFF OK ?

**2** If you selected RINGER: OFF OK ?,

press  .

**Note:** When the reception mode is set to TEL, the ringer will still ring at LOW if turned off.

## 2. Sending Faxes

### Transmittable Documents

#### Size and weight

The size and weight of documents that you can load in the document feeder depend on whether you load one page at a time or several pages at once.

#### Loading one page at a time:

Minimum size

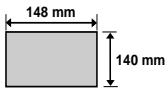

Maximum size

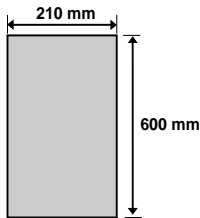

#### Loading up to 10 pages at once:

Minimum size

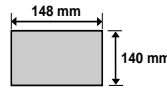

Maximum size

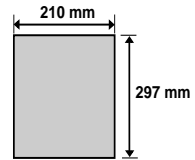

Minimum weight

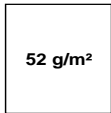

Maximum weight

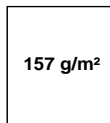

Minimum weight

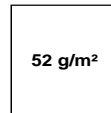

Maximum weight

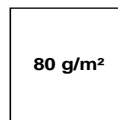

**Note:** Letters or graphics on the edges of a document will not be scanned.

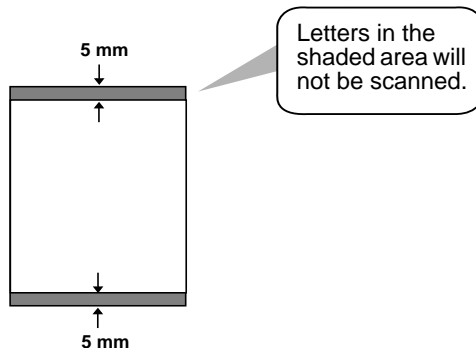

## Other restrictions

- ◆ The scanner cannot recognise yellow, greenish yellow, or light blue ink.
- ◆ Ink, glue, and correcting fluid on documents must be dry before they pass through the document feeder.
- ◆ All clips, staples, and pins must be removed from documents before loading in the feeder. If these are not removed, they may damage the machine.
- ◆ Documents which are patched, taped, torn, smaller than the minimum size, carbon backed, easily smudged, or have a slippery coated surface should be photocopied, and the copy loaded in the feeder.

## Loading the Document

Up to 10 pages can be placed in the feeder at one time. The pages will automatically feed into the machine starting from the bottom page.

- ◆ If you need to send or copy more than 10 pages, place the additional pages gently and carefully in the feeder just before the last page is scanned. Do not try to force them in, as this may cause double-feeding or jamming.
- ◆ If your document consists of several large or thick pages which must be loaded one at a time, insert each page into the feeder as the previous page is being scanned. Insert gently to prevent double-feeding.

- 1 Adjust the document guides to the width of your document.**

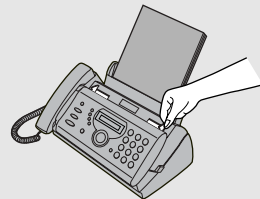

- 2 Insert the document face down in the document feeder. The top edge of the document should enter the feeder first.**

- READY TO SEND will appear in the display.

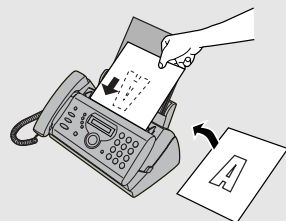

- 3 Adjust the resolution and/or contrast settings as explained in *Resolution and Contrast* below, then dial the receiving machine as explained on page 30.

## Adjusting the Resolution and Contrast

If desired, you can adjust the resolution and contrast before sending a document.

The default resolution setting is STANDARD and the default contrast setting is AUTO.



You must adjust the settings each time you don't want to use the default settings.



**Note:** The resolution and contrast settings are only effective for sending a document. They are not effective for receiving a document.

### Resolution settings

STANDARD	Use STANDARD for ordinary documents. This setting gives you the fastest and most economical transmission.
FINE	Use FINE for documents containing small letters or fine drawings.
SUPER FINE	Use SUPER FINE for documents containing very small letters or very fine drawings.
HALF TONE	Use HALF TONE for photographs and illustrations. The original will be reproduced in 64 shades of gray.

## Contrast settings

AUTO

Use AUTO for normal documents.

DARK

Use DARK for faint documents.

### 1 Load the document(s).

- The document must be loaded before the resolution and contrast can be adjusted.

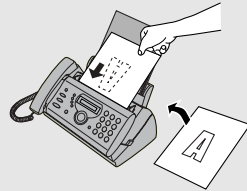

### 2 Press **RESOLUTION** one or more times until the desired resolution and contrast settings appear in the display.

- The first time you move through the list of resolution settings, the contrast setting AUTO will appear next to each resolution setting. The second time you move through the list, the contrast setting DARK will appear.

Display:

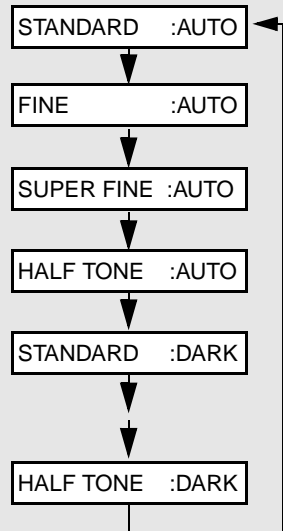

**Note:** In order to transmit in SUPER FINE resolution, the receiving fax machine must also have that resolution. If it doesn't, your machine will automatically step down to the next best available setting.

## ***Sending a Fax by Normal Dialling***

With Normal Dialling, you pick up the handset (or press ) and dial by pressing the number keys.

- ◆ If a person answers, you can talk with them through the handset before sending the fax. (If you pressed , you must pick up the handset to talk.)
- ◆ Normal Dialling allows you to listen to the line and make sure the other fax machine is responding.

### **1 Load the document(s).**

- If desired, press  to set the resolution and/or contrast.

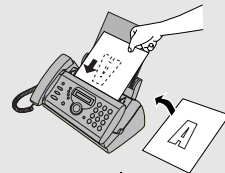

READY TO SEND

### **2 Pick up the handset or press . Listen for the dial tone.**

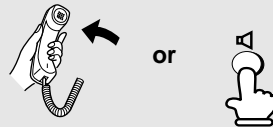

### **3 Dial the number of the receiving machine by pressing the number keys.**



### **4 Wait for the connection. Depending on the setting of the receiving machine, you will either hear a fax tone or the other person will answer.**

- If the other party answers, ask them to press their Start key (if you pressed , pick up the handset to speak with them). This causes the receiving machine to issue a fax tone.



**5** When you hear the fax tone, press  . Replace the handset.



- If the transmission is completed successfully, the fax will beep once.
- If an error occurs, the fax will beep three times and print a Transaction Report to inform you of the problem (see page 67).

**Note:**



If the transmission is unsuccessful and DOCUMENT JAMMED appears in the display, remove the document as explained on page 80.

## Sending a Fax by Automatic Dialling

You can store up to 30 fax or phone numbers in the machine for automatic dialling.

- ◆ Auto-dial numbers are dialled by pressing  until the desired number appears in the display, and then .

### Storing fax and phone numbers for automatic dialling

**1** Press  once and  once.

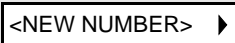

Display:



**2** Press  once.





























































**3** Enter the fax or voice number by pressing the number keys. Up to 32 digits can be entered. (Note: A space cannot be entered.)



- To clear a mistake, press .
- If a pause is required between any of the digits to access a special service or an outside line, press  . The pause appears as a hyphen (two seconds per pause). Several pauses can be entered in a row.

**4** Press .

**5** Enter a name by pressing number keys for each letter as shown in the chart below. Up to 15 characters can be entered. (If you do not wish to enter a name, go directly to Step 6.)



Example: SHARP = 7777 44 2 777  7

SPACE = 	G = 	N =  	U =  
A = 	H =  	O =   	V =   
B =  	I =   	P = 	W = 
C =   	J = 	Q =  	X =  
D = 	K =  	R =   	Y =   
E =  	L =   	S =    	Z =    
F =   	M = 	T = 	

- ◆ To enter two letters in succession that require the same key, press  after entering the first letter.
- ◆ To enter a lower case letter, continue pressing the key for the letter until the lower case letter appears. To enter one of the following symbols, press  or  repeatedly: . / ! " # \$ % & ' ( ) \* + , - : ; < = > ? @ [ ¥ ] ^ \_ ' { | } → ←

**6** Press **START/MEMORY** 

Display:



 NEW NUMBER 

**7** Return to Step 2 to store another number, or press **STOP**  to return to the date and time display.

**Note:** The fax machine uses a lithium battery to keep automatic dialling numbers and other programmed information in memory when the power is turned off. Battery power is consumed primarily when the power is off. With the power kept continuously off, the life of the battery is about 5 years. If the battery dies, have your dealer or retailer replace it. Do not try to replace it yourself.



## Editing and clearing auto-dial numbers

If you need to make changes to a previously stored auto-dial number, or clear a number, follow these steps:

**1** Press  once and  once.

Display:



**<NEW NUMBER>** 

**2** Press  or  until the number you wish to edit or clear appears in the display.

**3** Press  once.



**1=EDIT, 2=CLEAR**

**4** Select EDIT or CLEAR:

EDIT:  CLEAR: 



- If you selected CLEAR, go to Step 8.

**5** If you selected EDIT, make the desired changes to the number.

- Press  or  to move the cursor to the digit or digits you wish to change, and then enter the new digit. The new digit will replace the old digit.
- If you do not wish to change the number, go directly to Step 6.

**6** Press 

**7** Make the desired changes to the name.

- Press  or  to move the cursor to the letter or letters you wish to change, and then press the appropriate number key repeatedly until the desired letter appears (see Step 5 on page 32). The new letter will replace the old letter.
- If you do not wish to change the name, go directly to Step 8.

**8** Press **START/MEMORY** 

**9** Return to Step 2 to edit or clear another number, or press **STOP**  to return to the date and time display.

## Using an auto-dial number



Once you have stored a fax or phone number, you can use it to send a fax or make a phone call.

**1** If you are sending a fax, load the document(s).

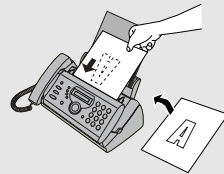
- If desired, press **RESOLUTION**  to set the resolution and/or contrast.



**READY TO SEND**

**2** Press  (or ) until the name of the other party appears in the display (if no name was stored, the number will appear).

**3** If you are sending a fax, press **START/MEMORY** . Dialling and transmission begins.

- If the transmission is completed successfully, the fax will beep once.
- If an error occurs, the fax will beep three times and print a Transaction Report to inform you of the problem (see page 67).

**If you are making a phone call, lift the handset. Dialling begins.**

## Sending a fax by Direct Keypad Dialling

You can also enter a full number with the number keys and then press the **START/MEMORY**  key to begin dialling. You can use this method to dial a full number when you don't need to speak to the other party before faxing.

### 1 Load the document(s).

- If desired, press **RESOLUTION**  to set the resolution and/or contrast.

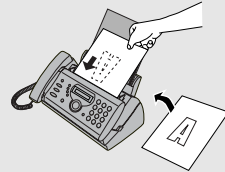

READY TO SEND

### 2 Enter the number of the receiving machine by pressing the number keys.

- If a pause is required between any of the digits to access a special service or an outside line, press **FUNCTION** . The pause will appear as a hyphen (two seconds per pause). Several pauses can be entered in a row.

### 3 Check the display. If the number of the receiving machine shown is correct, press **START/MEMORY** .

- If the number is not correct, press **STOP**  to backspace and clear one digit at a time, and then re-enter the correct digit(s).

## Redial

You can automatically redial the last number dialled. This procedure can be used to send a fax or make a phone call.

**1** If you are sending a fax, load the document(s).

- If desired, press  to set the resolution and/or contrast.

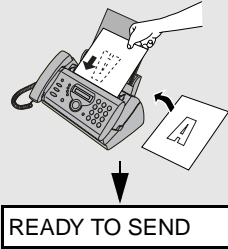

**2** Press  once. <REDIAL> appears in the display, followed by the last number dialled. Make sure the number that appears is the number you wish to dial.

**3** If you are sending a fax, press . Dialling and transmission begins.

If you are making a phone call, lift the handset. Dialling begins.

**Note:**

If a fax transmission is unsuccessful and DOCUMENT JAMMED appears in the display, remove the document as explained on page 80. (This may occur if the other fax machine doesn't respond properly when you attempt to send the document.)

## ***Automatic redialling***

If you use automatic dialling (including Direct Keypad Dialling) to send a fax and the line is busy, the fax machine will automatically redial the number. The fax machine will make two redial attempts at an interval of five minutes. During this time, RECALLING will appear in the display, followed by a two-digit number assigned to the fax job. You will not be able to dial any other locations while the message appears.



- ◆ To stop automatic redialling, press **STOP** .
- ◆ Under certain conditions (for example if a person answers the call on a telephone), automatic redialling may stop before two redialling attempts are made.

## Error Correction Mode



**Important:** This function is only available on the FO-P630.

The fax machine is set to automatically correct any distortions in a transmission due to noise on the telephone line before printing at the receiving end. This function is called Error Correction Mode (ECM). ECM is effective for both transmissions and receptions, and is only effective when the other fax machine has ECM as well.

When there is considerable noise on the line, you may find that transmission with ECM turned on takes longer than normal. If you prefer a faster transmission time, you can try turning ECM off.

**1** Press  **once** and  **once.**

OPTION SETTING 

**2** Press  **once** and  **4 times.**

ECM MODE 

**3** Press  **once.**

1=YES, 2=NO

**4** Press  **to select YES,** or  **to select NO.**

The display briefly shows your selection, then:

RECEIVE RATIO 

**5** Press  **to return to the date and time display.**



## Sending a Fax From Memory

You can scan a document into the fax's memory and send the document from memory. This increases transmission speed and allows you to send a fax to multiple destinations in a single operation. After transmission, the document is automatically cleared from memory.

### Broadcasting (sending a fax to multiple destinations)

This function allows you to send the same fax to as many as 20 different locations in just one operation.

- ◆ When sending to multiple locations, only auto-dial numbers can be used to dial the numbers of the receiving machines.

#### 1 Load the document(s).

- If desired, press **RESOLUTION**  to set the resolution and/or contrast.

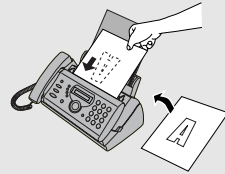



#### 2 Press **START/MEMORY**

#### 3 Press (or ) until the name of the number appears in the display (if no name was stored, the number will appear).

#### 4 Press to select the number.

#### 5 Repeat Steps 3 and 4 for each of the other locations to which you wish to send the fax (maximum of 20).

- To check your selected locations, press  to scroll through them. To delete a location, scroll to the location and then press **STOP** .





### 6 When you are ready to begin transmission, press .

- A Transaction Report is automatically printed out after Broadcasting is completed. Check the "Note" column of the report to see if any of the locations are marked "Busy" or have a communication error code. If so, send the document to those locations again.

## Memory transmission



You can also send a fax through memory when sending to a single location. This is convenient when sending to locations where the line is often busy, as it saves you from waiting to pick up the original document and frees the feeder for other operations.

To send a fax through memory, load the document, press  , and then dial using one of the following methods:

- ◆ Press the number keys to enter the fax number and then press  .
- ◆ Press  repeatedly to select an auto-dial number and press  .
- ◆ Press  once to select the last number dialled and press  .

## If the memory becomes full...

If the memory becomes full while the document is being scanned, MEMORY IS FULL and SEE MANUAL will alternately appear in the display.

- ◆ Press  if you want to transmit the pages which have been stored up to that point in memory. The remaining pages will be ejected from the feeder. After transmission, the memory will be cleared and you can transmit the remaining pages. You will also need to transmit the page which was being scanned when the memory filled up.
- ◆ Press  if you want to cancel the entire transmission.

# 3. Receiving Faxes

## Using TEL/FAX Mode

To select TEL/FAX mode, press **RECEPTION MODE** until the arrow in the display points to TEL/FAX.

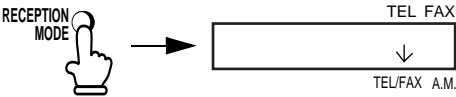
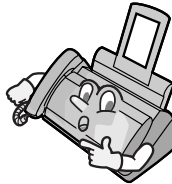

When the reception mode is set to TEL/FAX, your fax machine automatically answers all calls on two rings. After answering, your fax monitors the line for about five seconds to see if a fax tone is being sent.

- ◆ If your fax machine detects a fax tone (this means that the call is an automatically dialed fax), it will automatically begin reception of the incoming document.
- ◆ If your fax machine doesn't detect a fax tone (this means that the call is a voice call or manually dialed fax), it will make a ringing sound (called pseudo ringing) for 15 seconds to alert you to answer. If you don't answer within this time, your fax will send a fax tone to the other machine to allow the calling party to send a fax manually if they desire.

**Note:** Only the fax will alert you to voice calls or manually dialed faxes by pseudo ringing. An extension phone connected to the same line will not ring after the connection has been established.



### Pseudo Ring Duration for Tel/Fax Mode

If desired, you can change the duration of pseudo ringing in Tel/Fax mode.

**1** Press **FUNCTION** once and **▲** once.

Display:

**OPTION SETTING** **↕**





**2** Press  once and  4 times.

PSEUDO RING 

**3** Press  once.

1=15 SECONDS

**4** Enter a number as follows for the desired duration:

- |   |             |             |
|---|-------------|-------------|
|  | 15 SECONDS  | 15 seconds  |
|  | 30 SECONDS  | 30 seconds  |
|  | 60 SECONDS  | 60 seconds  |
|  | 120 SECONDS | 120 seconds |

The display briefly shows your selection, then:

QUIET TIME 

**Note for New Zealand:** Telecom regulations do not permit the 60-second and 120-second settings to be used.

**5** Press  to return to the date and time display.

## Using A.M. Mode

To select A.M. mode, press  until the arrow in the display points to A.M.

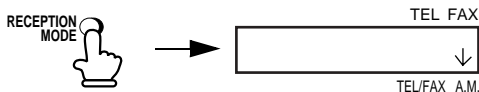

In A.M. mode, your fax will automatically receive voice and fax messages if you have connected an answering machine to the fax machine. See Chapter 5 for more details.

## Using FAX Mode

To select FAX mode, press  
RECEPTION MODE  until the arrow in  
the display points to FAX.

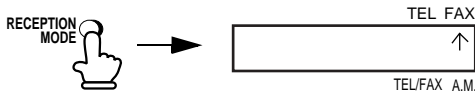

When the reception mode is set to FAX, the fax machine will automatically answer all calls on two rings and receive incoming faxes.

- ◆ If you pick up the handset before the machine answers, you can talk to the other party and/or receive a fax as explained in *Using TEL Mode* on page 44.

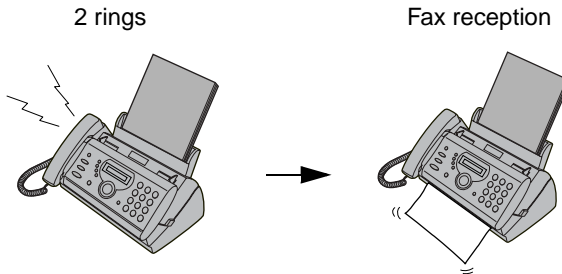

## Changing the number of rings

If desired, you can change the number of rings on which the fax machine answers incoming calls in FAX and TEL/FAX mode. Any number from 2 to 4 can be selected.

**1** Press  **once and**  **once.**

Display:

**OPTION SETTING** 

**2** Press  once.

NUMBER OF RING 

**3** Press  once.

ENTER (2-4) (2)

**4** Enter the desired number of rings (any number from 2 to 4).

The display briefly shows your selection, then:

Example: 3 rings 

FAX REMOTE # 

**5** Press  to return to the date and time display.

## Using TEL Mode



To select TEL mode, press  
RECEPTION MODE  until the arrow in  
the display points to TEL.

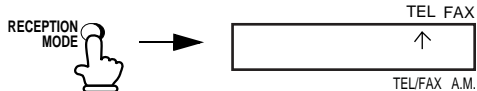

When the reception mode is set to TEL, you must answer all calls by picking up the fax machine's handset or an extension phone connected to the same line.

## Answering with the fax's handset

- 1** When the fax machine rings, pick up the handset.

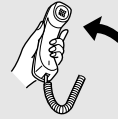

- 2** If you hear a fax tone, wait until the display shows **RECEIVING** and then replace the handset.



**RECEIVING**

**Note:** If you have set the Fax Signal Receive setting (page 47) to NO, press **START/MEMORY**  to begin reception.

- 3** If the other party first speaks with you and then wants to send a fax, press **START/MEMORY**  **RECEIVING**  after speaking. (Press before the sender presses their Start key.)

- When **RECEIVING** appears in the display, hang up.



## Answering on an extension phone

- 1** Answer the extension phone when it rings.



- 2** If you hear a soft fax tone, wait until your fax responds (the extension phone will go dead), then hang up.

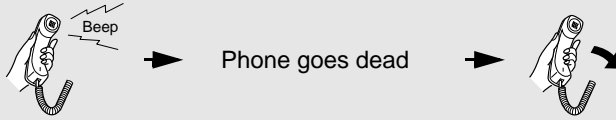

- 3** If the fax doesn't respond, or if the other party first talks to you and then wants to send a fax, press **5** once and **\*** twice on the extension phone (only on a tone dial phone). This signals the fax to begin reception. Hang up.

- The above step is necessary if you have set the Fax Signal Receive setting (see below) to NO.
- Your fax will not accept the signal to begin reception (5\*\*\*) if a document is loaded in its feeder.
- In New Zealand, not all standard telephones and answering machines will respond to incoming ringing when connected to the extension socket of the equipment.

## ***Putting a call on hold***

To put the other party on hold during a phone conversation, press **HOLD** .



When this is done, they cannot hear you. You can put the handset back in the cradle without breaking the connection. When you are ready to speak with the other party again, pick up the handset. If you did not put the handset back in the cradle, press **HOLD**  again to resume conversation.



## Optional Reception Settings



### Fax Signal Receive

Your fax will automatically begin reception if you hear a soft fax tone after answering a call on your fax or an extension phone. If you use a computer fax modem to send documents on the same line, you must turn this function off in order to prevent your fax from mistakenly attempting to receive documents from the computer fax modem. Follow the steps below to change the setting.

**1** Press  once and  once.

Display:



OPTION SETTING 

**2** Press  once and  5 times on the FO-P610, or 6 times on the FO-P630.

FAX SIGNAL RX 

**3** Press  once.

1=YES, 2=NO

**4** Press  to turn on the function, or  to turn it off.



The display briefly shows your selection, then:

CALLER-ID 

**5** Press  to return to the date and time display.



### Changing the number for remote fax activation

If desired, you can use a number other than 5 to activate fax reception from an extension telephone. You can select any number from 0 to 9.

**1** Press  once and  once.

Display:

OPTION SETTING 

**2** Press  once and  once.

FAX REMOTE # 

**3** Press  once.

ENTER (0-9) (5)

- 4** Enter the desired number (any number from 0 to 9).

The display briefly shows your selection, then:

Example: 3 



TRANSACTION 

- 5** Press  to return to the date and time display.

### Reception Ratio



The fax has been set at the factory to automatically reduce the size of received documents to fit the size of the printing paper. This ensures that data on the edges of the document are not cut off. If desired, you can turn this function off and have received documents printed at full size.

- ◆ If a document is too long to fit on the printing paper, the remainder will be printed on a second page. In this case, the cut-off point may occur in the middle of a line.
- ◆ Automatic reduction may not be possible if the received document is too large, contains too many fine graphics or images, or is sent at high resolution. In this case, the remainder of the document will be printed on a second page.

- 1** Press  once and  once.

Display:



OPTION SETTING 

- 2** Press  once and  3 times.

RECEIVE RATIO 

- 3** Press  once.

1=AUTO, 2=100%

- 4** Press  to select AUTO, or  to select 100%.

The display briefly shows your selection, then:

PRINT CONTRAST 

- 5** Press  to return to the date and time display.

## ***Substitute Reception to Memory***

In situations where printing is not possible, such as when your fax runs out of paper, the imaging film needs replacement, or the paper jams, incoming faxes will be received to memory.

When you have received a document in memory, FAX RX IN MEMORY will appear in the display, alternating with ADD PAPER & PRESS START KEY or CHECK FILM / CHECK COVER / CHECK PAPER JAM. When you add paper (and press , replace the imaging film, or clear the jam, the stored documents will automatically print out.

### **Caution!**

When documents are stored in memory, do not turn the power off. This will erase all of the contents.

## 4. Making Copies

Your fax machine can also be used to make copies. Single and multiple copies (up to 99 per original) can be made, enabling your fax to double as a convenience office copier.

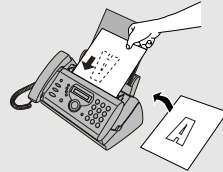

### 1 Load the document(s) face down. (Maximum of 10 pages.)

- If desired, press **RESOLUTION**  to set the resolution and/or contrast. (The default resolution setting for copying is FINE.)



READY TO SEND

### 2 If desired, select an enlarge/reduce setting, and/or select the number of copies per original:

- ENLARGE/REDUCE: Press  or  until the desired setting appears in the display. Settings are 100%, 125%, 135%, 50%, 73%, 88%, 94%, and AUTO. (The default setting is 100%.)

Example: Press  twice → **RATIO: 125%**

- Number of copies per original: Press the number keys to enter a number from 1 to 99. (The default setting is 1.)

Example: Press  for five copies → **5**

### 3 When you are ready to begin copying, press **COPY** .

#### If MEMORY IS FULL appears...

If the memory becomes full while a document is being scanned, MEMORY IS FULL and SEE MANUAL will alternately appear in the display and the document will automatically feed out. This may happen if the resolution is set to SUPER FINE, or if you selected an enlarge/reduce setting, or if you are making more than one copy per original. To avoid using memory, use STANDARD or FINE for the resolution, 100% for the enlarge/reduce setting, and make only one copy per original.

## Copy Cut-off

When making a copy of a document that is longer than the printing paper, use the copy cut-off setting to select whether the remaining part of the document will be cut off or printed on a second page. The initial setting is YES (cut off the remainder). To change the setting, follow the steps below.

**1** Press **FUNCTION** once and **▲** once.

Display:

OPTION SETTING 

**2** Press **▶** once and **▲** once.

COPY CUT-OFF 

**3** Press **▶** once.

1=YES, 2=NO

**4** Press **①** to set copy cut-off to YES (the remaining part of the document will not be printed), or **②** to set copy cut-off to NO (the remaining part will be printed on a second page).

The display briefly shows your selection, then:

NUMBER OF RING 

**5** Press **STOP** to return to the date and time display.

---

# 5. Answering Machine Connection

## Connecting an Answering Machine

If desired, you can connect an answering machine to your fax machine's **TEL. SET** socket. This will allow you to receive both voice messages and faxes when you are out.

- ◆ **Important:** If the answering machine is not connected to the **TEL. SET** socket on the fax as shown, the setup will not operate properly.

- 
- 1** Remove the seal covering the **TEL. SET** socket.

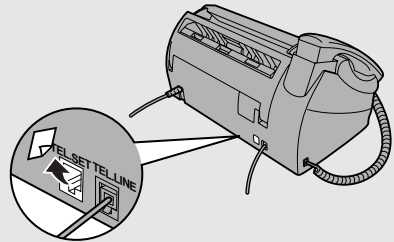

- 2** Connect the answering machine's telephone line plug to the **TEL. SET** socket.

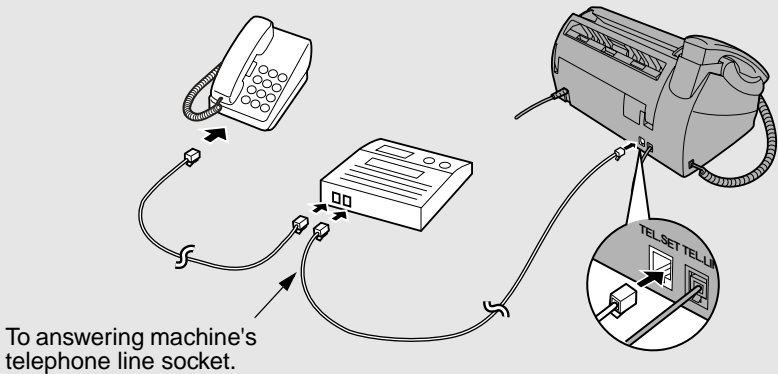

**Note:** When FaxAbility or Fax Duet (distinctive ring) is used, the answering machine may be connected to any extension of the same line.

**Important:** In New Zealand, not all standard telephones and answering machines will respond to incoming ringing when connected to the extension socket of the equipment.

### Changing the outgoing message

The outgoing message (OGM) of your answering machine should be changed to inform callers who want to send a fax to press their Start key. For example, your message might go as follows:

"Hello. You've reached the ABC company. No one is available to take your call right now. Please leave a message after the beep or press your facsimile Start key to send a fax. Thank you for calling."

- ◆ It is advisable to keep the length of the message under 10 seconds. If it is too long, you may have difficulty receiving faxes sent by automatic dialling.
- ◆ If your outgoing message must be longer than 10 seconds, leave a pause of about four seconds at the beginning of the message. This will give your fax a chance to detect fax tones sent when automatic dialling is used.

## Using the Answering Machine Connection

### 1 Set the reception mode to A.M.

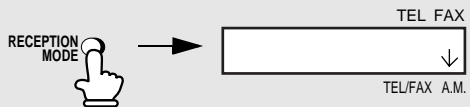

### 2 Set your answering machine to auto answer.

- ◆ Your answering machine must be set to answer on a maximum of two rings. If not, you may not be able to receive faxes sent by automatic dialling.

**Note:** If your answering machine has a remote retrieval function, make sure the code used to activate remote retrieval is different from the code used to activate fax reception with an extension telephone (see Chapter 3, *Receiving Faxes*). If they are the same, entering the code from an outside telephone to retrieve messages will cause the fax machine to be activated.

### ***How answering machine mode operates***

While you are out, all of your incoming calls will be answered by your answering machine and its outgoing message will play. Voice callers can leave a message. During this time, your fax will quietly monitor the line. If your fax detects a fax tone or a duration of silence greater than four seconds, it will take over the line and begin reception.

- ◆ If the connection is not good or there is noise on the line, the answering machine and/or fax machine may not respond properly.
- ◆ The call counter on your answering machine may indicate that voice messages were received, when only fax messages were received.
- ◆ To prevent the fax from taking over the line and beginning reception if you call in from an external phone or answer on an extension phone, press any three keys (other than the code to activate fax reception, "5", "✳", and "✳") on the dial pad of the phone. This can only be performed from a phone capable of tone dialling.

When you return and turn off your answering machine, be sure to change the reception mode back to TEL/FAX, FAX, or TEL!



## ***Optional A.M. Mode Settings***

If necessary, you can use the following settings to improve the response of the answering machine connection to incoming calls.

### ***Quiet Detect Time***

This function causes the fax machine to take over the line and begin reception if a certain duration of silence is detected after the answering machine answers.













Time selections for the period of silence are 1 to 10 seconds. Quiet Detect Time has been set to 4 seconds at the factory. This gives the best performance with most answering machines; however, you may need to adjust this setting depending on the disconnect time of your answering machine.

Some answering machines may have unusually fast disconnect times (equal to or very slightly less than 4 seconds), which means that the answering machine may disconnect the line before fax reception can begin. In this case, try a Quiet Detect Time setting of about 3 seconds.

If the fax machine is interrupting callers before they can leave a message, try a longer Quiet Detect Time setting. If your outgoing message includes a period of silence, make sure that the setting is longer than that period of silence, or re-record your outgoing message to shorten the silence.

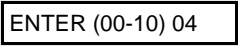
**Note:** Quiet Detect Time can be turned off by entering "00" for the time. Note, however, that the fax machine will not be able to receive faxes sent manually by Normal Dialling.



To change the setting, follow the steps below.

<p><b>1</b> Press  once and  once.</p>	<p>Display:  </p>
<p><b>2</b> Press  once and  5 times.</p>	<p></p>
<p><b>3</b> Press  once.</p>	<p></p>
<p><b>4</b> Enter a number from 01 to 10, or enter 00 to turn off the function.</p> <p>Example: 3 seconds  </p>	<p>The display briefly shows your selection, then:  </p>
<p><b>5</b> Press  to return to the date and time display.</p>	

## Quiet Detect Start Time



This setting can be used to delay the start of the Quiet Detect Time function. For example, if you want to insert a pause at the beginning of your answering machine's outgoing message to ensure clear detection of fax signals, you can use this setting to delay the start of silence detection so that the pause will not cause the fax to take over the line.

Quiet Detect Start Timing has been set to five seconds at the factory. You can change this setting by entering a 2-digit number equal to the desired number of seconds of the delay, or turn the function off by entering **00**. As general guide, the delay time should be slightly longer than the pause before the outgoing message.

**1** Press  once and  once.

Display:

OPTION SETTING 

**2** Press  once and  6 times.

QUIET START 

**3** Press  once.

ENTER (00-15) 05

**4** Enter a 2-digit number (from 01 to 15) for the number of seconds of the delay, or enter 00 to turn off the function.

The display briefly shows your selection, then:

ON A.M. FAILURE 

Example: 5 seconds  

**5** Press  to return to the date and time display.

## On A.M. Failure

When this function is turned on, your fax will answer the call after 4 rings if the answering machine for some reason fails to answer before that time. This ensures that you will receive fax messages even if the answering machine's tape fills up or the answering machine is not turned on.

This function has been turned off at the factory. If you want to turn it on, follow the steps below:



### Note:

When this function is turned on, make sure that the answering machine is set to answer on 3 rings or less. If it isn't, the fax will always answer first, preventing callers from leaving voice messages.

**1** Press  once and  once.

Display:



OPTION SETTING 

**2** Press  once and  7 times.

ON A.M. FAILURE 

**3** Press  once.

1=YES, 2=NO

**4** Press  to turn on the function, or  
 to turn it off.

The display briefly shows your selection, then:

DISTINCTIVE 

**5** Press  to return to the date and time display.



## 6. Special Functions

### Caller ID (Requires Subscription to Service)

If you subscribe to a caller identification service from your telephone company, you can set your fax machine to display the name and number of the caller while the fax rings.



**Important:**



- ◆ To use this function, you must subscribe to a caller identification service from your telephone company.
- ◆ Your fax may not be compatible with some caller identification services.

**1** Press  once and  once.

Display:



OPTION SETTING  

**2** Press  once and  4 times on the FO-P610, or 5 times on the FO-P630.



CALLER-ID  

**3** Press  once.

1=YES, 2=NO

**4** Press  (YES) to turn on Caller ID.  
(To turn off Caller ID, press  .)

COUNTRY SELECT

**5** Press  if you are in Australia, or  if you are in New Zealand.

The display briefly shows your selection, then:

FO-P610: RECEIVE RATIO  

FO-P630: ECM MODE  

**6** Press  to return to the date and time display.

## How Caller ID operates

When you receive a call, the name and phone number of the caller will alternately appear in the display, beginning just before the second ring. The information will continue to be displayed until the line is disconnected.

**Note:** Some caller ID services may not provide the name of the caller. In this case, only the phone number will appear.

Display example

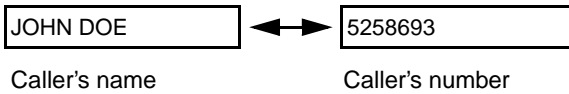

## Display messages

One of the following messages will appear while the fax rings if caller information is not available.

NO SERVICE	No caller information was received from your telephone company. Make sure that the telephone company has activated your service.
CALLER-ID ERROR	Noise on the telephone line prevented reception of caller information.
UNAVAILABLE (OUT OF AREA in New Zealand)	The call was made from an area which does not have a caller identification service, or the caller's service is not compatible with that of your local phone company.
PRIVATE (ANONYMOUS in New Zealand)	Caller information was not provided by the telephone company at the caller's request.

## Viewing the Caller ID list

If you subscribe to a Caller ID service and have turned on the Caller ID function, your fax machine will keep information on the most recent 30 calls and faxes you have received. You can view this information, which consists of the name and number of each caller, in the Caller ID List.

## Caller ID (Requires Subscription to Service)



**Note:** For all units installed in New Zealand, the direct use of the displayed number for call back does not operate properly and must not be used. It is necessary to manually enter the verified correct number for the party called. This will often require the addition or deletion of leading digits from the number shown on the display when dialling manually.

- ◆ After you have received 30 calls, each new call will delete the oldest call.
- ◆ All calls will be erased if you unplug the fax or a power failure occurs.

Follow the steps below to view the Caller ID List in the display. If desired, you can immediately dial a number when it appears.

**1** Press  twice.





**2** Press  or  to scroll through the list.

**3** If you want to dial one of the numbers in the list, scroll through the list until the number appears in the display.

- **Fax:** If you want to send a fax, load the document and then press  .  
Dialling and transmission begin.

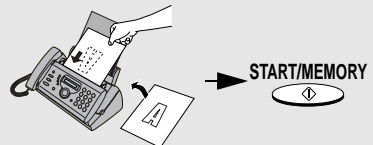
**Fax:**



- **Voice call:** If you want to make a voice call, pick up the handset (or press  ). Dialling begins automatically. (If you pressed  , pick up the handset when the other party answers.)

**Voice call:**



**4** Press  when you have finished viewing the list.

## To delete calls from the Caller ID list

If you want to delete a single call from the caller list, press **#** while the call appears in the display. If you want to delete all calls from the list, hold **#** down for at least 3 seconds while you are viewing any number in the list.

## Priority Call

With Caller ID turned on, you can set your fax to make a special ringing sound when you receive a call from a designated phone number. This lets you know immediately who is calling without having to look at the display.

To use this function, enter the desired phone number by following the steps below (only one phone number can be entered).

**1** Press **FUNCTION** once and **▼** 2 times. Display: **ENTRY MODE** **↕**

**2** Press **▶** once and **▲** once. **PRIORITY #** **↕**

**3** Press **▶** once. **1=SET, 2=CLEAR**

**4** Press **1** to store a number.  
(To clear a previously stored number, press **2** and go to Step 6.)

**5** Enter the number by pressing the number keys (max. 20 digits).

**6** Press **START/MEMORY** to store (or clear) the number. **OWN NUMBER SET** **↕**

**7** Press **STOP** to return to the date and time display.

## ***Blocking voice calls***

With Caller ID turned on, you can use the Anti Junk Fax function described in *Blocking Reception of Unwanted Faxes* in this chapter to block voice calls as well as faxes from your specified Anti Junk Number.

In this case, when a voice call or a fax comes in from the number you have specified as a "Junk Number", your fax will terminate the call as soon as it receives the calling phone number from the caller ID service. The caller will hear a 3-second high-pitch tone to signal the call's termination. In Australia the call will not break off until the caller has hung up..

To use this function, enter the number that you wish to block as explained in *Blocking Reception of Unwanted Faxes* (see page 64). Only one number can be blocked.



## Distinctive Ring (Requires Subscription to Service)







If you subscribe to a distinctive ring service from your telephone company, you will need to turn on the distinctive ring function. When this is done, your fax will signal voice calls by the normal ring pattern, and fax transmissions by a special ring pattern. In the case of a fax transmission, your fax machine will automatically answer the call and receive the fax.

The distinctive ring function is used with the reception mode set to FAX. When your fax number is dialled, your fax machine will signal the call with a special ringing sound, then answer automatically and begin reception after the number of rings set with the Number of Rings setting (the initial setting is 2 rings—refer to *Using Fax Mode* in Chapter 3). When your voice number is dialled, the fax machine will signal the call with the normal ringing sound to let you know that you must answer personally.

The initial setting for distinctive ring is NO. If set to YES, both Australian (Fax Duet) and New Zealand (FaxAbility) distinctive ring are supported.

### Important:

- ◆ The distinctive ring function can only be used if you subscribe to a distinctive ring service from your telephone company. Do not turn on distinctive ring if you are on a normal line, as the fax machine will not operate properly.
- ◆ If you turn on distinctive ring, the fax will not operate in TEL/FAX reception mode.

<b>1</b> Press  once and  once.	Display: <input type="text" value="OPTION SETTING"/>
<b>2</b> Press  once and  6 times on the FO-P610, or 7 times on the FO-P630.	<input type="text" value="DISTINCTIVE"/>
<b>3</b> Press  once.	<input type="text" value="1=YES, 2=NO"/>
<b>4</b> Press  to turn on the function, or  to turn it off.	The display briefly shows your selection, then: <input type="text" value="FAX SIGNAL RX"/>



**5** Press  to return to the date and time display.

**6** Set the reception mode to FAX.





## Blocking Reception of Unwanted Faxes

The Anti Junk Fax function allows you to block reception of faxes from a party that you specify. This saves paper by not printing out unwanted "junk" faxes. To use this function, follow the steps below to enter the fax number from which you do not wish to receive faxes. One fax number can be entered.

**1** Press  once and  twice.

Display:



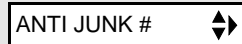

**2** Press  once and  twice.

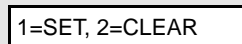

**3** Press  once.



**4** Press  to store an Anti Junk number, or  to clear a previously stored number (if you are clearing a number, go to Step 6).

**5** Enter the fax number by pressing the number keys (max. 20 digits).



**6** Press  and then press  to return to the date and time display.

## Polling (Requesting a Fax Transmission)

Polling allows you to call another fax machine and have it send a document (previously loaded in its feeder) to your machine without assistance from the operator of the other machine.

- ◆ **Hint:** Polling is useful when you want the receiving fax machine, not the transmitting fax machine, to bear the cost of the call.

### 1 Dial the fax machine you want to poll using one of the following methods:

- Enter the full number using the numeric keys.
- Pick up the handset (or press ) and dial the full number. Wait for the fax answerback tone.
- If the number has been stored for automatic dialling, press  or  until the name (or number) of the other party appears in the display.

### 2 Press **POLL** .

- If you used the handset, replace it when POLLING appears in the display. Reception will begin.

# 7. Printing Lists

You can print lists showing settings and information entered in the fax machine. The lists are described below. To print a list, follow these steps.

1 Press **FUNCTION** once and **▼** once.

Display:

LISTING MODE **↕**

2 Press **▶** once.

TEL # LIST **↕**

3 Press **▲** or **▼** until the desired list appears in the display.

4 Press **▶** once.

PRESS START KEY

5 Press **START/MEMORY** to print the list.

## Telephone Number List

This list shows the fax and phone numbers that have been stored for automatic dialling.

## Setup List

This list shows your current selections for the **FUNCTION** key settings. The list also shows your name and fax/telephone number as entered in the machine, and a sample of the header printed at the top of every page you transmit (**HEADER PRINT**).

```

                                SETUP LIST                30-JUL-2003 11:20
-----
FOR:
***ENTRY MODE***
DNTI JUNK NUMBER
PRIORITY CALL NO.
SENDER'S NAME
SENDER'S TELEPHONE NUMBER
HEADER PRINT
30-JUL-2003 11:20                                     P.01
-----
***OPTION SETTING***
NUMBER OF RINGS IN AUTO ANSWER ROSE  2 RINGS
TEL/FAX REHOTE NO.                   (S)***
TRANSACTION PRINT SELECT              ERROR ONLY
RIVAL MODE                            TONE
PSEUDO RINGING DURATION               100
QUIET DETECT TIME                     045
QUIET DETECT START TIMING             025
FAX ANSWER WHEN A.M. FAILS           NO
DISTINCTIVE RINGING                   NO
FAX SIGNAL RECEIVE                    YES
CALLER-ID                             YES(AUSTRALIA)
RECEPTION RATIO                       AUTO
PRINT CONTRAST                        NORMAL
COPY CUT OFF                           YES
-----
```

## Caller-ID List

This list shows information about your 30 most recent calls. (This list is only available if you are using the Caller ID function.)

## Transaction Report

This report is printed out automatically after an operation is completed to allow you to check the result. Your fax machine is set at the factory to print out the report only when an error occurs.



- ◆ The Transaction report cannot be printed on demand.

### Headings in Transaction Report

<b>SENDER/ RECEIVER</b>	The name or fax number of the other machine involved in the transaction. If that machine does not have an ID function, the communication mode will appear (for example, "G3").
<b>START</b>	The time at which transmission/reception started.
<b>TX/RX TIME</b>	Total time taken for transmission/reception.
<b>PAGES</b>	Number of pages transmitted/received.
<b>NOTE</b>	(One of the following notes will appear under <b>NOTE</b> in the report to indicate whether the transaction was successful, and if not, the reason for the failure.)  <b>OK</b> - Transmission/reception was successful.  <b>P.FAIL</b> - A power failure prevented the transaction.  <b>JAM</b> - The printing paper or document jammed, preventing the transaction.  <b>BUSY</b> - The fax was not sent because the line was busy.  <b>COM.E-0 to COM.E-7</b> - A telephone line error prevented the transaction. See <i>Line error</i> on page 72.  <b>CANCEL</b> - The transaction was cancelled because the <b>STOP</b> key was pressed, no document was in the feeder, or the other machine requested transmission using a function which your fax machine does not have. If you were attempting to fax, make sure a document is in the feeder. If you were receiving, contact the faxing party to see how they are trying to send to you.



## Transaction Report print condition

You can change the condition under which a Transaction Report is printed out. Follow the steps below.

**1** Press  **once** and  **once.**

Display:

OPTION SETTING 

**2** Press  **once** and  **twice.**





TRANSACTION 

**3** Press  **once.**

1:ALWAYS PRINT

(Selections appear alternately)

**4** Press a number from  to  to select the condition for printing.

- |   |              |  |
|---|--------------|--|
|    | ALWAYS PRINT | A report will be printed after each transmission, reception, or error. |
|    | ERROR/MEMORY | A report will be printed after an error or a memory operation.         |
|    | SEND ONLY    | A report will be printed after each transmission.                      |
|  | ERROR ONLY   | A report will be printed only when an error occurs.                    |
|  | NEVER PRINT  | A report will never be printed.  |

The display briefly shows your selection, then:

DIAL MODE 

**5** Press  to return to the date and time display.

## Help List

This list provides a brief guide to the operation of the machine. Press  to print the list.

## 8. Maintenance

### Print head

Clean the print head frequently to ensure optimum printing performance.

**Note:** Remove the paper from the paper tray before cleaning the print head.

- 1** Unplug the telephone line and then the power cord, and open the operation panel (press **0**).

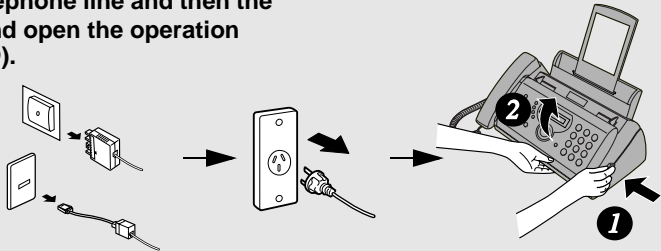

- 2** Take the imaging film out of the print compartment and place it on a sheet of paper.

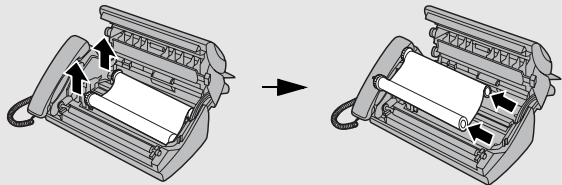

- 3** Wipe the print head with isopropyl alcohol or denatured alcohol.

#### Caution!

- Do not use benzene or thinner. Avoid touching the print head with hard objects.
- The print head may be hot if your fax machine has just received a large number of documents. If this is the case, allow the print head to cool prior to cleaning.

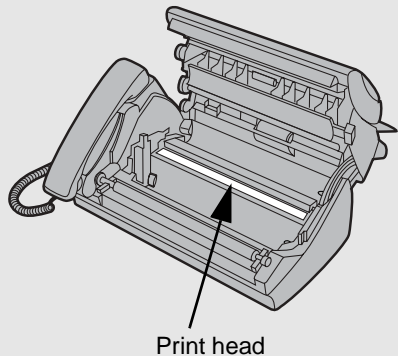

- 4** Place the imaging film back in the print compartment.

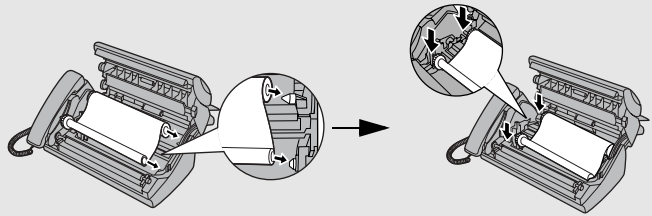

- 5** Rotate the front gear until the film is taut, and then close the operation panel (press down on both sides to make sure it clicks into place).

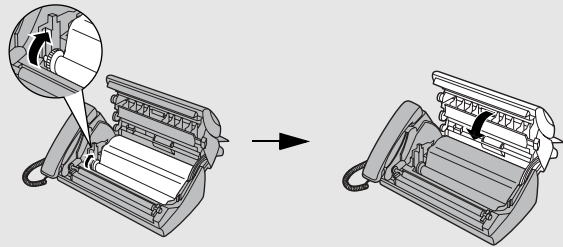

## Scanning glass and rollers

Clean the scanning glass and rollers frequently to ensure the quality of transmitted images and copies.

**Note:** Remove the paper from the paper tray before cleaning the scanning glass and rollers.

- 1** Open the operation panel (press **1**).

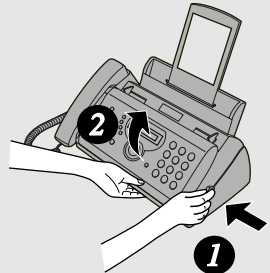



- 2** Flip up the green levers on each side of the white roller.

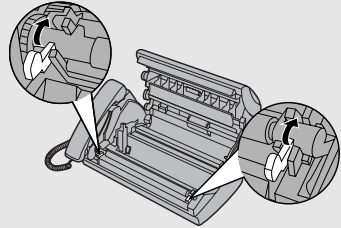

- 3** Wipe the scanning glass (under the white roller) and rollers with a cotton swab.

- Make sure that all dirt and stains (such as correcting fluid) are removed. Dirt and stains will cause vertical lines on transmitted images and copies.

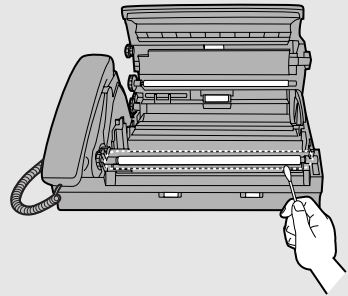

**If the scanning glass is difficult to clean**

If you find it difficult to remove dirt from the scanning glass, you can try moistening the swab with isopropyl alcohol or denatured alcohol. Take care that no alcohol gets on the rollers.

- 4** Flip down the green levers on each side of the white roller. Rotate the front gear until the film is taut, and then close the operation panel (press down on both sides to make sure it clicks into place).

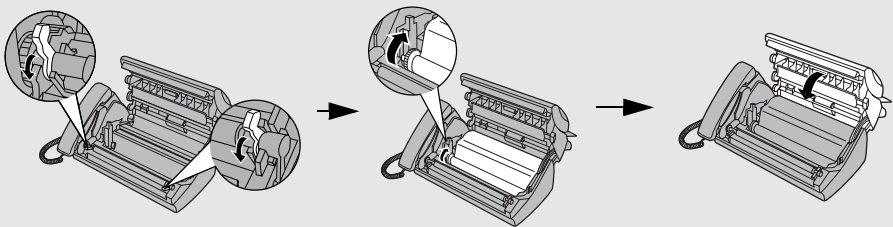

## The housing

Wipe the external parts and surface of the machine with a dry cloth.

**Caution!**

Do not use benzene or thinner. These solvents may damage or discolor the machine.

---

# 9. Troubleshooting

## Problems and Solutions

### Line error

Problem	Solution
LINE ERROR appears in the display.	<p data-bbox="423 443 977 496">Try the transaction again. If the error persists, check the following:</p> <ul data-bbox="423 528 983 1007" style="list-style-type: none"><li data-bbox="423 528 983 608">• Check the connection. The cord from the <b>TEL. LINE</b> socket to the wall socket should be no longer than two meters.</li><li data-bbox="423 639 983 692">• Make sure there are no modem devices sharing the same telephone line.</li><li data-bbox="423 724 983 777">• Check with the other party to make sure their fax machine is functioning properly.</li><li data-bbox="423 809 983 836">• Have your telephone line checked for line noise.</li><li data-bbox="423 868 983 920">• Try connecting the fax machine to a different telephone line.</li><li data-bbox="423 952 983 1007">• If the problem still occurs, your fax machine may need service.</li></ul>

## Dialling and transmission problems

Problem	Solution
No dial tone when you pick up the handset or press the <b>SPEAKER</b> key.	<ul style="list-style-type: none"> <li>• Make sure the handset cord is connected to the correct socket. See <i>Connecting the handset</i> on page 11.</li> </ul>
Dialling is not possible.	<ul style="list-style-type: none"> <li>• Make sure the power cord is properly plugged into a power outlet.</li> <li>• Make sure that the telephone line is properly connected to both the <b>TEL. LINE</b> socket and the wall socket.</li> <li>• Make sure that the fax machine is set to the correct dialling mode for your telephone line. See <i>Dial mode</i> on page 12.</li> </ul>
The power is on, but no transmission takes place.	<ul style="list-style-type: none"> <li>• Make sure that the receiving machine has paper.</li> <li>• Make sure that the telephone line cord is plugged into the <b>TEL. LINE</b> socket, and not the <b>TEL. SET</b> socket.</li> <li>• If the receiving machine is in manual mode with no attendant, reception will not be possible.</li> <li>• Check the display for error messages.</li> <li>• Pick up the handset and check for a dial tone.</li> </ul>
Nothing is printed at the receiving end.	<ul style="list-style-type: none"> <li>• Make sure that the document for transmission is placed face down in the feeder.</li> </ul>
A distorted image is received at the other end.	<ul style="list-style-type: none"> <li>• Noise on the telephone line may cause distortion. Try sending the document again.</li> <li>• Make a copy of the document on your fax machine. If the copy is also distorted, your fax machine may need service.</li> </ul>

### ***Reception and copying problems***

<b>Problem</b>	<b>Solution</b>
The power is on, but no reception takes place.	<ul style="list-style-type: none"> <li>• Make sure that the telephone line cord is plugged into the <b>TEL. LINE</b> socket, and not the <b>TEL. SET</b> socket.</li> </ul>
The printing paper comes out blank when you try to receive a document.	<ul style="list-style-type: none"> <li>• Make sure that the document is loaded properly in the feeder of the transmitting machine. Make a copy or print a report to confirm the printing ability of your machine.</li> </ul>
General print quality is poor.	<ul style="list-style-type: none"> <li>• It is important to select a paper that is appropriate for the thermal transfer printer in your fax. We recommend using laser quality paper that has a very smooth finish. Copier paper will work, but it sometimes tends to yield a lighter print quality.</li> </ul>
The received document is faint.	<ul style="list-style-type: none"> <li>• Ask the other party to send higher contrast documents. If the contrast is still too low, your fax machine may need service. Make a copy or print a report to check your machine's printing ability.</li> </ul>
Received images are distorted.	<ul style="list-style-type: none"> <li>• Noise on the telephone line may cause distortion. Have the other party try sending the document again.</li> <li>• The print head may be dirty. See <i>Print head</i> on page 69.</li> <li>• Make a copy or print a report on your fax machine. If the copy or report is also distorted, your fax machine may need service.</li> </ul>
A received document or copy prints out in strips.	<ul style="list-style-type: none"> <li>• Make sure the operation panel is completely closed (press down on both sides of the panel).</li> </ul>
The quality of copies is poor and/or dark vertical lines appear.	<ul style="list-style-type: none"> <li>• Any dirt or material on the scanning glass will cause spots to appear on copies and transmitted faxes. Clean the scanning glass as explained on page 70.</li> </ul>

Reception/copying is interrupted.	<ul style="list-style-type: none"> <li>• If reception or copying takes place continuously for a long time, the print head may overheat. Turn off the power and let it cool down. If overheating frequently occurs, try changing the print contrast setting to LIGHT (see page 18).</li> </ul>
Dark vertical lines appear on copies and received faxes.	<ul style="list-style-type: none"> <li>• Try changing the print contrast setting to LIGHT (see page 18).</li> </ul>

### ***Answering machine connection***

<b>Problem</b>	<b>Solution</b>
The answering machine connection does not operate properly.	<ul style="list-style-type: none"> <li>• Make sure your fax machine's reception mode is set to A.M.</li> <li>• Make sure your fax machine's <b>TEL. LINE</b> socket is connected to the wall socket. Make sure your fax machine's <b>TEL. SET</b> socket is connected to your answering machine's telephone line socket (not the answering machine's extension phone socket).</li> <li>• Make sure your answering machine's outgoing message is under 10 seconds.</li> <li>• Make sure that the Quiet Detect Time setting is set to three or four seconds (see page 54).</li> </ul>

## General problems

Problem	Solution
A loud howling sound occurs when the speaker is used.	<ul style="list-style-type: none"> <li>Feedback (a loud howling sound) may occur if you replace the handset while the speaker is on. To avoid feedback, turn off the speaker (press the <b>SPEAKER</b> key ) before you replace the handset.</li> </ul>
Auto-dial numbers cannot be stored in the fax.	<ul style="list-style-type: none"> <li>Make sure the fax is plugged in and the imaging film has been loaded. (Auto-dial numbers cannot be stored if the imaging film has not been loaded.) See <i>Loading the Imaging Film</i> on page 15.</li> </ul>
Nothing appears in the display.	<ul style="list-style-type: none"> <li>Make sure the power cord is properly plugged into a power outlet.</li> <li>Connect another electrical appliance to the outlet to see if it has power.</li> </ul>
The machine does not respond when you press any of its keys.	<ul style="list-style-type: none"> <li>If a beep sound is not made when you press the keys, unplug the power cord and then plug it in again several seconds later.</li> </ul>
Automatic document feeding does not work for transmission or copying.	<ul style="list-style-type: none"> <li>Check the size and weight of the document (see <i>Transmittable Documents</i> on page 26).</li> </ul>
Bell tinkle (New Zealand)	<ul style="list-style-type: none"> <li>The operation of this equipment on the same line as the telephone or other equipment with audible warning devices or automatic ring detectors will give rise to bell tinkle or noise and may cause false tripping of the ring detector. Should such a problem occur, contact your authorised Sharp Service Centre for information.</li> </ul>

# Messages and Signals

## Display messages

Note: If you have turned on the Caller ID function, see page 59 for display messages related to Caller ID.

ADD PAPER & / PRESS START KEY (alternating messages)	Check the printing paper. If the tray is empty, add paper and then press the <b>START/MEMORY</b> key. If there is paper in the tray, make sure it is inserted correctly (take out the stack, align the edges evenly, and then reinsert it in the tray) and then press the <b>START/MEMORY</b> key.
CHECK FILM/ CHECK COVER/ CHECK PAPER JAM (alternating messages)	These alternating messages appear when there is a problem in the print compartment that prevents printing. Check to see if the imaging film is not loaded properly or if it has been used up and needs replacement. Make sure the operation panel is completely closed (press down on both sides). If a paper jam has occurred, clear the jam as explained in the following section, <i>Clearing Paper Jams</i> .
CHECK PAPER SIZE	An incorrect size of paper has been loaded in the paper tray. Remove the paper and load A4-size paper.
DOCUMENT JAMMED	The original document is jammed. See the following section, <i>Clearing Paper Jams</i> . Document jams will occur if you load more than 10 pages at once or load documents that are too thick (see page 26).
FAX RX IN MEMORY	A fax has been received in memory because the imaging film needs replacement, you have run out of printing paper, or the paper is jammed. The fax will print out automatically when the problem is fixed.
FUNCTION MODE	The <b>FUNCTION</b> key has been pressed.
INCORRECT FILM/ CHECK FILM	The wrong type of imaging film is loaded in the machine. Printing is not possible. The machine can only print when SHARP FO-9CR imaging film is loaded.

## Messages and Signals

LINE ERROR	Transmission or reception was not successful. Press the <b>STOP</b> key to clear the message and then try again. If the error persists, see <i>Line Error</i> on page 72.
MEMORY IS FULL/ SEE MANUAL (alternating messages)	The memory is full. This may occur during fax reception if too much data is received before the pages can be printed out. If faxes have been received to memory because printing is not possible (an additional message will indicate the problem), resolve the problem so that printing can continue (see <i>Substitute Reception to Memory</i> on page 49). If you are attempting to transmit from memory, see <i>If the memory becomes full</i> on page 40. If you are copying, see <i>If MEMORY IS FULL appears</i> on page 50.
MEMORY PRINTING	The fax is preparing to or printing out a document from memory.
NEAR END OF FILM/ REPLACE FILM	This message appears 3 m from the end of the imaging film (approximately 10 pages can still be printed), and alerts you that you will soon need to replace the film.
NO DATA	This appears if you attempt to search for an auto-dial number when none have been stored.
OFF HOOK	This appears if you forgot to replace the handset after using it to dial and send a fax. Replace the handset or press the <b>STOP</b> key to clear the message.
ON HOOK DIAL	The <b>SPEAKER</b> key has been pressed and the fax machine is waiting for you to dial.
OVER HEAT	The print head has overheated. Operation can be continued after it cools. If overheating frequently occurs, try changing the print contrast setting to LIGHT (see page 18).
PRINT HEAD FAIL/ YOU NEED SERVICE (alternating messages)	The print head has failed and requires service.
READY TO SEND	A document has been loaded and the fax machine is waiting for you to begin faxing or copying.



RECALLING	This appears if you attempt to send a fax by automatic dialling and the line is busy or the receiving fax machine does not answer. Your fax machine will automatically reattempt the call. (See <i>Automatic redialling</i> on page 37.)
TOTAL PAGE(S) 01	Number of pages transmitted, received, or copied.

### ***Audible signals***

Continuous tone	3 seconds	Indicates the end of transmission, reception, or copying.
Intermittent tone (3 beeps)	5 seconds (1 second on, 1 second off)	Indicates incomplete transmission, reception, or copying.
Rapid intermittent tone	35 seconds (0.7 seconds on, 0.3 seconds off)	Indicates that the handset is off hook.

# Clearing Paper Jams

## Clearing a jammed document

If the original document doesn't feed properly during transmission or copying, or DOCUMENT JAMMED appears in the display, first try pressing

START/MEMORY



. If the document doesn't feed out, remove it as explained below.

### Important:

Do not try to remove a jammed document without releasing it as explained below. This may damage the feeder mechanism.

- 1** Press **1** and slowly open the operation panel until it is half open.

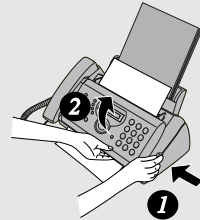

- 2** Flip up the green levers on each side of the white roller.

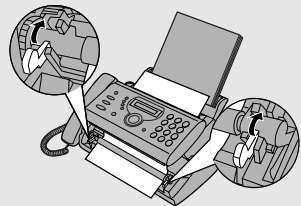

- 3** Gently remove the document.

- Be careful not to tear the document.

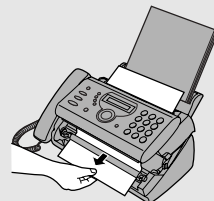

- 4** Flip down the green levers on each side of the white roller. Rotate the front gear until the film is taut, and then close the operation panel (press down on both sides to make sure it clicks into place).

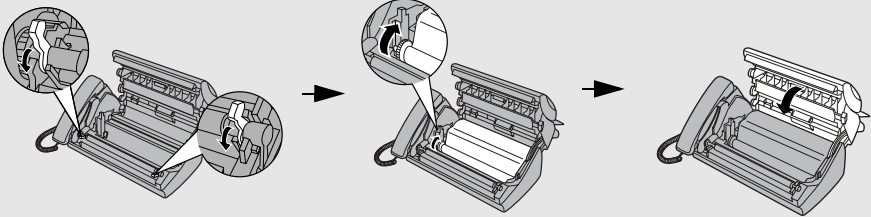

### Clearing jammed printing paper

- 1** Open the operation panel (press ❶).

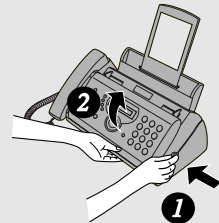

- 2** Gently pull the jammed paper out of the machine, making sure no torn pieces of paper remain in the print compartment or rollers.

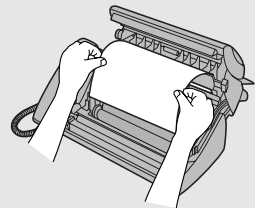

- 3** Rotate the front gear until the film is taut, and then close the operation panel (press down on both sides to make sure it clicks into place).

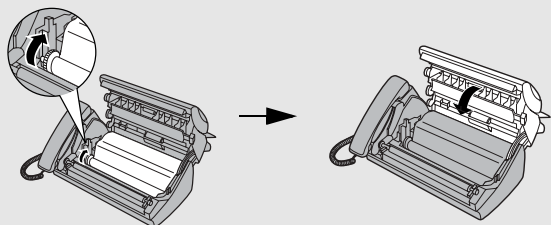



# Quick Reference Guide

## Sending Faxes

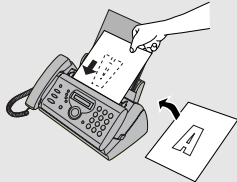

Place your document (up to 10 pages) face down in the document feeder.



### Normal Dialling

1. Lift the handset or press .
2. Dial the fax number.
3. Wait for the reception tone (if a person answers, ask them to press their Start key).
4. Press .

### Automatic Dialling

1. Press  or  until the name of the other party appears in the display (if no name was stored, the number will appear).
2. Press .

### Direct Keypad Dialling

1. Dial the fax number.
2. Press .

## Receiving Faxes

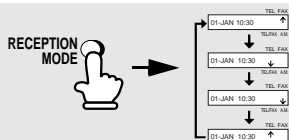



**FAX mode:** The fax machine automatically answers and receives faxes.

**TEL mode:** Answer all calls (even faxes) by picking up the handset. To begin fax reception, press .

**TEL/FAX mode:** The fax machine automatically answers and receives faxes. Voice calls are signalled by a special ringing sound.

**A.M. mode:** Select this mode when an answering machine is connected to the fax and the answering machine is turned on.

## Storing Auto Dial Numbers

1. Press  once and  twice.
2. Enter the full fax/phone number.
3. Press .

4. Enter a name by pressing number keys. (To enter two letters in succession that require the same key, press  after entering the first letter.)

SPACE = 1	G = 4	N = 6 6	U = 9 9
A = 2	H = 4 4	O = 6 6 6	V = 8 8 8
B = 2 2	I = 4 4 4	P = 7	W = 9
C = 2 2 2	J = 5	Q = 7 7	X = 9 9
D = 3	K = 5 5	R = 7 7 7	Y = 9 9 9
E = 3 3	L = 5 5 5	S = 7 7 7 7	Z = 9 9 9 9
F = 3 3 3	M = 6	T = 8	

5. Press  and then .

---

# Index

## A

- A.M. reception mode, 23, 42, 53
- Answering machine connection
  - Activating, 53
  - Connecting, 52
  - On A.M. Failure, 57
  - Quiet Detect Start Time, 56
  - Quiet Detect Time, 54
  - Troubleshooting, 75
- Anti Junk Fax, 64
- Audible signals, 79
- Auto-dial numbers
  - Storing, 31
  - Using, 34

## C

- Caller ID, 58-62
- Caller ID List, 67
- Contrast, 29
- Copies, 50
- Copy cut-off setting, 51

## D

- Date, setting, 21
- Dial mode, 12
- Dialling
  - Automatic, 34
  - Direct Keypad, 35
  - Normal, 30
- Direct Keypad Dialling, 35
- Display messages, 77
- Distinctive ring, 63
- Document feeder, 27
- Document guides, 27
- Document restrictions, 27
- Document sizes, 26
- Document, maximum scanning size, 26

## E

- ECM (Error Correction Mode), 38
- Extension telephone
  - Connecting, 14
  - Using, 45

## F

- Fax Ability (distinctive ring), 63
- Fax Duet (distinctive ring), 63
- FAX reception mode, 23, 43
- Fax Signal Receive, 47

## H

- Half-tone setting, 28
- Handset, 11
- Hold, 46
- Housing, cleaning, 71

## I

- Imaging film, replacing, 15

## J

- Jams, clearing, 80-81

## L

- Letters, entering, 20, 32
- Line error, 72
- Loading paper, 17
- Loading the document, 27

## M

- Memory transmission, 40
- Memory, substitute reception to, 49

## N

- Normal Dialling, 30
- Number of rings in FAX reception mode, 43

## Index

### P

Paper jams, clearing, 80-81  
Paper tray extension, 13  
Paper, loading, 17  
Polling, 65  
Power cord, 11  
Print contrast setting, 18  
Print head, cleaning, 69-70  
Priority Call, 61  
Pseudo Ring Duration, 41

### R

Reception mode  
    A.M. mode, 23, 42, 53  
    FAX mode, 23, 43  
    TEL mode, 23, 44  
    TEL/FAX mode, 23, 41  
Reception Ratio setting, 48  
Redialling, 36  
Resolution, 28  
Ringer volume, 25

### S

Scanning glass, cleaning, 70  
Sender's name and number, entering,  
    19-20  
Setup List, 66  
Speaker volume, 24

### T

TEL reception mode, 23, 44  
TEL. LINE socket, 12  
TEL. SET socket, 14, 52  
TEL/FAX reception mode, 23, 41  
Tel/Fax Remote Number, 47  
Telephone line cord, 12  
Telephone Number List, 66  
Time, setting, 21  
Transaction Report, 67  
    Setting print condition, 68  
Troubleshooting, 72-76

# **SHARP®**

**SHARP CORPORATION OF AUSTRALIA PTY.LTD.**

**A.C.N. 003 039 405**

**1 Huntingwood Drive, Huntingwood, Blacktown, N.S.W., 2148**

**SHARP CORPORATION OF NEW ZEALAND LIMITED.**

**Cnr Mahunga Drive & Hastie Ave. Mangere Bridge, Auckland**

**New Zealand**

**SHARP CORPORATION**

PRINTED IN THAILAND  
(TINSE4381XHTZ)

## Free Manuals Download Website

<http://myh66.com>

<http://usermanuals.us>

<http://www.somanuals.com>

<http://www.4manuals.cc>

<http://www.manual-lib.com>

<http://www.404manual.com>

<http://www.luxmanual.com>

<http://aubethermostatmanual.com>

Golf course search by state

<http://golfingnear.com>

Email search by domain

<http://emailbydomain.com>

Auto manuals search

<http://auto.somanuals.com>

TV manuals search

<http://tv.somanuals.com>