

TIPS

The supplied clamps can be attached to the stand rods and shelf board bar to hold the cables.

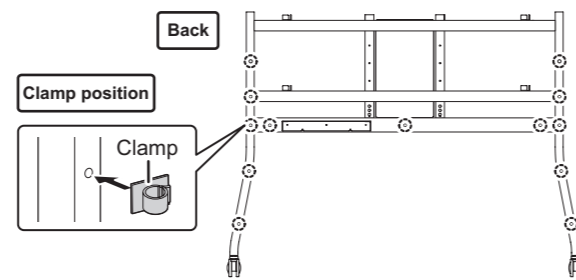

Specifications

Model	PN-ZS701
Height adjustment	4 positions Center height of the screen Approx. 1310 mm (51-9/16 inch) [A], approx. 1210 mm (47-5/8 inch) [B], approx. 1110 mm (43-11/16 inch) [C], approx. 1010 mm (39-3/4 inch) [D] (Depends on the position of the mounting brackets attached in Step 1-(4).)
Dimensions	See the diagram at right
Weight	Approx. 48 kg (105.8 lbs.)

Units: mm (inch)
(Note that the values shown are approximate values.)

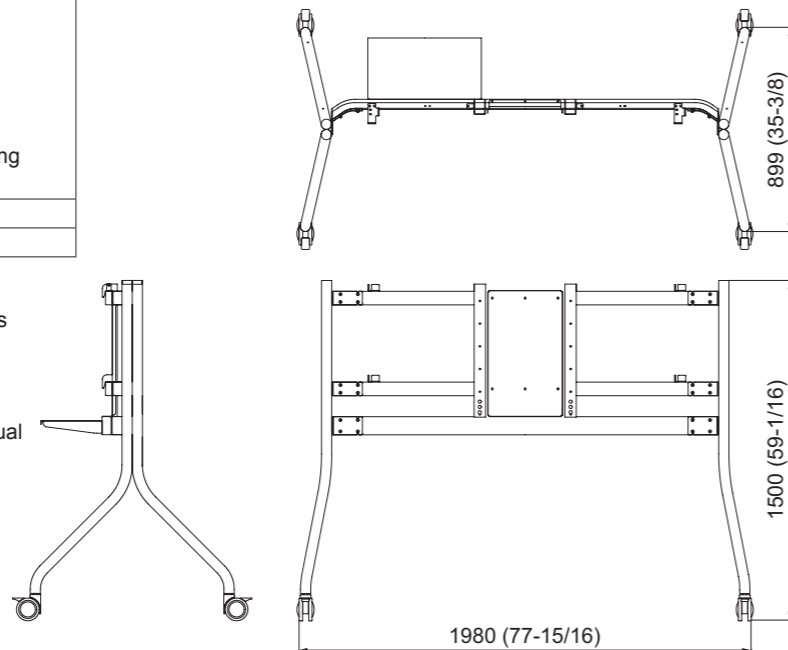

As a part of our policy of continuous improvement, SHARP reserves the right to make design and specification changes for product improvement without prior notice. The performance specification figures indicated are nominal values of production units. There may be some deviations from these values in individual units.

SHARP
SHARP CORPORATION

Printed in China
TINSE1212MPZZ(1)

SHARP

Operation Manual TROLLEY STAND PN-ZS701

Applicable models (as of September 2011) LCD MONITOR PN-L702B

(Available models differ according to region.)

● Thank you for purchasing a SHARP product.

Before using the product, please be sure to read this operation manual carefully. In particular, be sure to read the section "To ensure safe and correct use". After reading the manual, keep it in a convenient location where it can be accessed at any time.

TIPS

- This product was shipped after strict quality control and inspection; however, if breakage or a malfunction should be found, contact your SHARP dealer or your nearest customer contact.
- Please understand that SHARP CORPORATION bears no responsibility for errors made during use by the customer or a third party, nor for any other malfunctions or damage to this product arising during use, except where indemnity liability is recognized under law.
- This product and its accessories may be upgraded without advance notice.

To ensure safe and correct use

This operation manual and the product use various displays and labels to ensure safe use. Ignoring these displays and labels and incorrectly using the product could have results as classified below.

Please read the following warning symbol information before reading the rest of this section, and be sure to strictly observe all instructions.

Warning: Not following these instructions could result in death or serious injury.

- **The installation must be performed by qualified service personnel.**
Improper installation work may cause the monitor to fall or topple over, resulting in injury.
- **Do not place the stand on an unstable surface. Do not subject to intense shock or vibration.**
Toppling or falling may occur, causing injury.
- **Only use this product with specified models. Do not modify the stand or the accessories.**
Otherwise, the monitor may fall or the stand may topple over, resulting in injury.
- **Lock the casters when using the stand.**
Toppling may occur, causing injury.
- **Do not transport the stand with a monitor attached.**
If the monitor mounting attachments become broken or damaged, the monitor may fall or the stand may break or topple, resulting in injury.
- **Use the supplied screws. Tighten all screws firmly.**
Insufficient tightening may cause the monitor to fall or the stand to topple over, resulting in injury.

Caution: Not following these instructions could result in injury or property damage.

- **Do not climb onto or lean on the stand and monitor.**
Toppling may occur, causing injury.
- **If deformation or cracks are discovered, stop using the stand.**
Using the stand without repairing the problem may cause the monitor to fall or the stand to topple, resulting in injury.
- **Take suitable preventative measures to reduce the risk of this product falling or toppling due to an earthquake or other circumstances.**
The equipment for preventing falling and toppling will not be effective if the wall or table to which the equipment is attached is not sufficiently strong. Reinforce the wall or table sufficiently. These measures to prevent falling and toppling are intended to reduce the risk of injury and other harm, however, their effectiveness is not guaranteed in all earthquakes.

Supplied components

If any components should be missing, please contact your dealer.

- Left and right stand rods (x1 each) □ Mounting bars (x2) □ Shelf board bar (x1) □ Mounting brackets (x2)
- Reinforcement angle (x1) □ Shelf board (x1) □ Fixed angles (x2) □ Casters (x4) □ Spring washers (x4)
- Spacer angles (x4) □ Screws (M4x10) (x26) □ Screws (M6x14) (x28) □ Grip fixing brackets (x2)
- Clamps (x6) □ Spanner (x1) □ Operation Manual (this manual)

Usage precautions

- When moving the stand, follow the precautions below.
 - Turn off the power of the monitor and any connected devices, and disconnect the power cord and external cables.
 - Unlock the casters.
 - This work requires 2 or more people.
 - Do not place any items on the shelf board.



- After moving the stand, make sure that the casters and stand rods have not become loose.
- When using the stand, orient the front casters so they face forward and the rear casters so they face backward, and lock them.
- When transporting (by truck, etc.), remove the monitor.
 - For removal and reassembly after transport, consult your dealer. The customer should not attempt this work.
- The load capacity of the shelf board is 15 kg (33.1 lbs.).

Installation procedure (for SHARP dealers and service engineers)

! Caution

- Our company will bear no responsibility for accidents or injuries caused by improper installation or mishandling.
- Installation requires at least 4 people. To prevent damage, remove watches and jewelry such as rings.
- Connect the cables to the monitor before installing the monitor.
- Take care not to catch or pinch the cables.
- Tighten all screws firmly with a screwdriver.
- Keep the grip fixing brackets and grips in a safe place, as they are necessary for installing and removing the monitor.

1. Prepare the monitor.

- (1) Spread a soft thick cloth (such as a blanket) on a stable level surface on which the entire monitor can be placed, and place the monitor on it with the LCD panel facing down.
- (2) Move the attachment position of the lower left and right handles (x1 each) one level up on the monitor.
 - For details, refer to the manual for the monitor.
- (3) If the tray is to be installed, attach the tray mounting fittings to the monitor.
 - For details, refer to the manual for the monitor.
 - Do not install the tray yet.
- (4) Secure the mounting brackets (x2) with the screws (M6x14) (x4).
 - Adjust the height of the monitor using the attachment positions [A], [B], [C] and [D] as shown.
 - * Be sure to attach the mounting brackets in the indicated positions. If attached in different positions, the stand or monitor may fall or topple.
- (5) Place the monitor back in the shipping box and stand it upright.
- (6) Remove the left and right handles (x2 each) from the monitor.
 - For details, refer to the manual for the monitor.
- (7) Remove the grips from the handles. (x4)

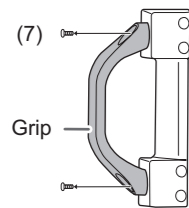
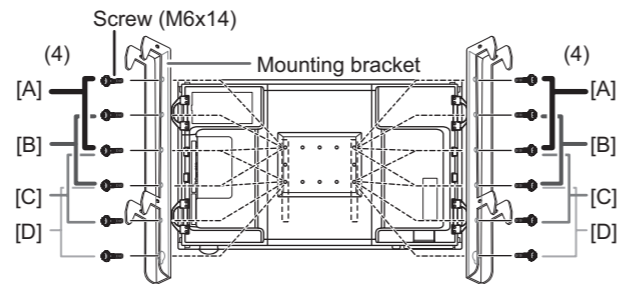
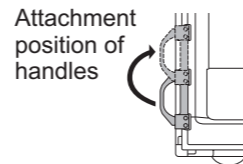

- (8) Attach the removed grips (x4) to the grip fixing brackets (x2) with the screws (x8) removed in Step (7).

- Attach the grips so they are oriented toward the front of the monitor.

- (9) Attach the grip fixing brackets (x2) with the screws (x8) removed in Step (6).

- The position for attaching the grip fixing brackets varies depending on the position of the mounting brackets.

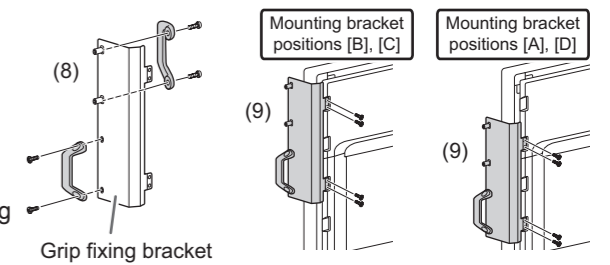

2. Assemble the stand.

- (1) Attach the casters (x4) to the left and right stand rods and lock the casters.

- Insert the spring washers (x4) between the rods and casters, and tighten firmly with the spanner (supplied).

- (2) Provisionally attach the screws (M6x14) (x2) to the shelf board bar, and hang the bar on the left and right stand rods.

- * Hang the bar so that the side with 3 screw holes in the center faces upward.

- (3) Provisionally attach the shelf board bar with the remaining screws (M6x14) (x6).

- (4) Provisionally attach the screws (M6x14) (x2) to the upper mounting bar, and hang it on the left and right stand rods.

- * Hang the bar so that the side with screw holes faces upward.

- (5) Provisionally attach the upper mounting bar to the left and right stand rods with the screws (M6x14) (x6).

- (6) Provisionally attach the lower mounting bar to the left and right stand rods in the same way as the upper mounting bar.

- (7) Firmly tighten the screws (x24) attached in Steps (2) to (6) to secure the shelf board bar and the mounting bars.

- (8) Attach the reinforcement angle with the screws (M4x10) (x9).

- (9) Attach the shelf board.

- The shelf board can be attached on either the left or right side.

- ① Provisionally attach the screws (M4x10) (x2) to the shelf board bar, and hang the shelf board on it.

- ② Securely tighten the screws provisionally tightened in ① and secure the remaining 3 positions with the screws (M4x10) (x3).

- (10) Lift the monitor by the grips on the grip fixing brackets, and hang the monitor on the mounting bars.

- * Take care not to pinch your hand.

- 4 or more people are required to lift the monitor. Lift the monitor straight up without tilting it.

- (11) Secure the mounting brackets and mounting bars with the fixed angles (x2) and screws (M4x10) (x4).

- (12) Remove the grip fixing brackets.

- (13) Secure the spacer angles (x4) with the screws (M4x10) (x8).

- Make sure that the spacer angles touch the back of the monitor before securing them.

- The orientation and position of the spacer angles vary depending on the height of the monitor.

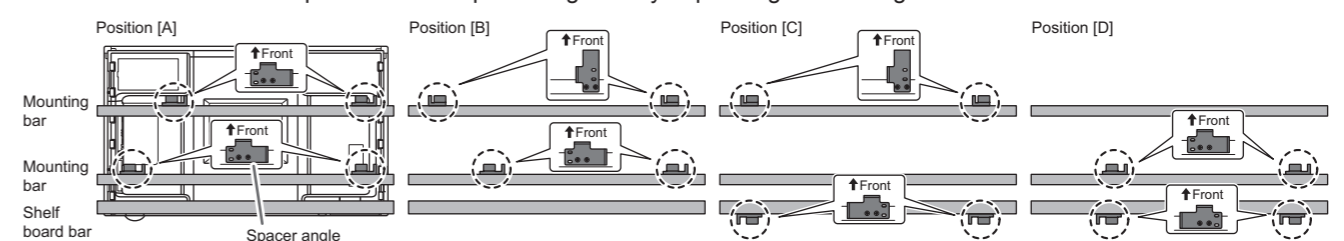

- (14) If the tray is to be attached, attach the tray onto the tray mounting fittings.

- For details, refer to the manual for the monitor.

Free Manuals Download Website

<http://myh66.com>

<http://usermanuals.us>

<http://www.somanuals.com>

<http://www.4manuals.cc>

<http://www.manual-lib.com>

<http://www.404manual.com>

<http://www.luxmanual.com>

<http://aubethermostatmanual.com>

Golf course search by state

<http://golfingnear.com>

Email search by domain

<http://emailbydomain.com>

Auto manuals search

<http://auto.somanuals.com>

TV manuals search

<http://tv.somanuals.com>