

SHARP®

XG-NV4SU

LCD PROJECTOR
PROJECTEUR LCD
PROYECTOR LCD

OPERATION MANUAL
MODE D'EMPLOI
MANUAL DE OPERACION

ENGLISH

FRANÇAIS

ESPAÑOL



NOM 1245  NYCE

 **Notevision**

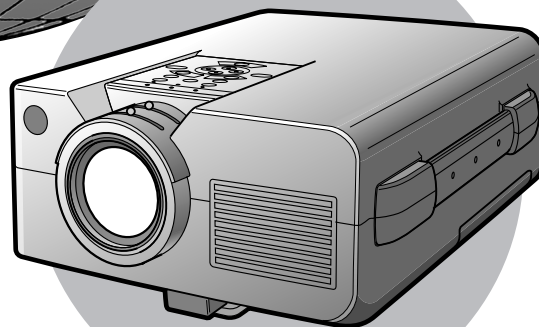

Before using the LCD projector, please read this operation manual carefully.

OPERATION MANUAL

ENGLISH

IMPORTANT

For your assistance in reporting the loss or theft of your Color LCD Projector, please record the Serial Number located on the bottom of the projector and retain this information. Before recycling the packaging, please be sure that you have checked the contents of the carton thoroughly against the list of "Supplied Accessories" on page 5.

Model No.: XG-NV4SU

Serial No.:

There are two important reasons for prompt warranty registration of your new SHARP LCD Projector, using the REGISTRATION CARD packed with the projector.

1. WARRANTY





This is to assure that you immediately receive the full benefit of the parts, service and labor warranty applicable to your purchase.

2. CONSUMER PRODUCT SAFETY ACT

To ensure that you will promptly receive any safety notification of inspection, modification, or recall that SHARP may be required to give under the 1972 Consumer Product Safety Act, PLEASE READ CAREFULLY THE IMPORTANT "LIMITED WARRANTY" CLAUSE. U.S.A. ONLY

WARNING: High brightness light source. Do not stare into the beam of light, or view directly. Be especially careful that children do not stare directly into the beam of light.

WARNING: To reduce the risk of fire or electric shock, do not expose this product to rain or moisture.

 <div style="border: 1px solid black; padding: 5px; margin: 5px auto; width: 80%;"> <p>CAUTION RISK OF ELECTRIC SHOCK. DO NOT REMOVE SCREWS EXCEPT SPECIFIED USER SERVICE SCREW.</p> </div> 	 <p>The lightning flash with arrowhead symbol, within an equilateral triangle, is intended to alert the user to the presence of uninsulated "dangerous voltage" within the product's enclosure that may be of sufficient magnitude to constitute a risk or electric shock to persons.</p>
<p>CAUTION: TO REDUCE THE RISK OF ELECTRIC SHOCK, DO NOT REMOVE COVER. NO USER-SERVICEABLE PARTS EXCEPT LAMP UNIT. REFER SERVICING TO QUALIFIED SERVICE PERSONNEL.</p>	 <p>The exclamation point within a triangle is intended to alert the user to the presence of important operating and maintenance (servicing) instructions in the literature accompanying the product.</p>







WARNING: FCC Regulations state that any unauthorized changes or modifications to this equipment not expressly approved by the manufacturer could void the user's authority to operate this equipment. U.S.A. ONLY

INFORMATION

This equipment has been tested and found to comply with the limits for a Class A digital device, pursuant to Part 15 of the FCC Rules. These limits are designed to provide reasonable protection against harmful interference when the equipment is operated in a commercial environment. This equipment generates, uses, and can radiate radio frequency energy and, if not installed and used in accordance with the operation manual, may cause harmful interference to radio communications. Operation of this equipment in a residential area is likely to cause harmful interference, in which case the user will be required to correct the interference at his own expense. U.S.A. ONLY

The enclosed computer cable and Macintosh adaptor must be used with the device. The cable and adaptor are provided to ensure that the device complies with FCC Class A verification. U.S.A. ONLY

Contents

	Important Information	Important Safeguards	3	Important Information
		Usage Guidelines	4	
		For SHARP Assistance (U.S.A. only)	4	
		Outstanding Features	5	
		Supplied Accessories	5	
		Part Names	6	
		Projector	6	
		Wireless Mouse Remote Control	7	
		Operating the Wireless Mouse Remote Control	8	
	Operation	Setting Up the Projector (Standard Setup)	10	Operation
		Adjusting the Height of the Picture	10	
		Basic Operations	11	
		Connecting the Power Cord	11	
		Turning on the Main Power	11	
		Turning on the Power	11	
		Adjusting the Focus	11	
		Adjusting the Zoom	11	
		Selecting the On-screen Display Language	11	
		Selecting the Video Input System Mode	12	
		Selecting the Input Mode	12	
		Checking the Input Mode	13	
		Adjusting the Volume	13	
		Turning off the Power	13	
		Using the Menu Screens	14	
		Picture Adjustments	15	
		Computer Adjustments	16	
		Auto Sync Adjustment	16	
		Manual Adjustment	16	
		Mode Adjustment	16	
		Initial Reset	17	
		Memory Select	17	
		Computer Mode Memory Adjustments	17	
		Audio Adjustments	18	
	Useful Features	Checking the System Setup	19	Useful Features
		Background Level (VIDEO mode only)	19	
		Black Screen Function	20	
		Auto Sync Display Function (RGB mode only)	20	
		Blue Screen Function (VIDEO mode only)	21	
		Using the Input Mode On-screen Display Override Function	21	
		Using the Reverse/Invert Image Function	22	
	Setup & Connections	Relationship between Projector Distance and Picture Size	23	Setup & Connections
		Reversed Image and Ceiling-mount Setups	24	
		Connecting a Computer	25	
		“Plug and Play” Function	25	
		Using the Remote Mouse Receiver and RS-232C Port	25	
		Connecting to the Computer Input Port	26	
		Connecting Video Equipment	27	
	Maintenance & Troubleshooting	Air Filter Maintenance	28	Maintenance & Troubleshooting
		Lamp/Maintenance Indicators	29	
		Replacing the Projection Lamp	30	
		Using the Kensington Lock	31	
		Troubleshooting	31	
	Appendix	Transporting the Projector	32	Appendix
		Connection Pin Assignments	33	
		RS-232C Port Specifications	33	
		Input Signals (Recommended Timing)	35	
		Specifications	36	
		Dimensions	37	



Important Safeguards

Electrical energy can perform many useful functions. This product has been engineered and manufactured to ensure your personal safety. But IMPROPER USE CAN RESULT IN POTENTIAL ELECTRICAL SHOCK OR FIRE HAZARD. In order not to defeat the safeguards incorporated into this LCD Projector, observe the following basic rules for its installation, use and servicing. For your own protection and reliable usage of your LCD Projector, please be sure to read these "Important Safeguards" carefully before use.

1. Read Instructions—All the safety and operating instructions should be read before the product is operated.
2. Retain Instructions—The safety and operating instructions should be retained for future reference.
3. Heed Warnings—All warnings on the product and in the operating instructions should be adhered to.
4. Follow Instructions—All operating and use instructions should be followed.
5. Cleaning—Unplug this product from the wall outlet before cleaning. Do not use liquid cleaners or aerosol cleaners. Use a damp cloth for cleaning.
6. Attachments—Do not use attachments not recommended by the product manufacturer as they may cause hazards.
7. Water and Moisture—Do not use this product near water – for example, near a bathtub, wash bowl, kitchen sink, or laundry tub; in a wet basement; or near a swimming pool; and the like.
8. Accessories—Do not place this product on an unstable cart, stand, tripod, bracket, or table. The product may fall, causing serious injury to a child or adult, and serious damage to the product. Use only with a cart, stand, tripod, bracket, or table recommended by the manufacturer, or sold with the product. Any mounting of the product should follow the manufacturer's instructions, and should use a mounting accessory recommended by the manufacturer.
9. A product and cart combination should be moved with care. Quick stops, excessive force, and uneven surfaces may cause the product and cart combination to overturn.



10. Ventilation—Slots and openings in the cabinet are provided for ventilation to ensure reliable operation of the product and to protect it from overheating. The openings should never be covered or blocked by placing the product on a bed, sofa, rug, or other similar surface. This product should not be placed in a built-in installation such as a book-case or rack unless proper ventilation is provided or the manufacturer's instructions have been adhered to.
11. Power Sources—This product should be operated only from the type of power source indicated on the marking label. If you are not sure of the type of power supply to your home, consult your product dealer or local power company. For products intended to operate from battery power, or other sources, refer to the operating instructions.
12. Grounding or Polarization—This product is equipped with a three-wire grounding-type plug, a plug having a third (grounding) pin. This plug will only fit into a grounding-type power outlet. This is a safety feature. If you are unable to insert the plug into the outlet, contact your electrician to replace your obsolete outlet. Do not defeat the safety purpose of the grounding-type plug.
13. Power-Cord Protection—Power-supply cords should be routed so that they are not likely to be walked on or pinched by items placed upon or against them, paying particular attention to cords at plugs, convenience receptacles, and the point where they exit from the product.
14. Lightning—For added protection for this product during a lightning storm, or when it is left unattended and unused for long periods of time, unplug it from the wall outlet and disconnect the cable system. This will prevent damage to the product due to lightning and power-line surges.
15. Overloading—Do not overload wall outlets, extension cords, or integral convenience receptacles as this can result in a risk of fire or electric shock.
16. Object and Liquid Entry—Never push objects of any kind into this product through openings as they may touch dangerous voltage points or short-out parts that could result in a fire or electric shock. Never spill liquid of any kind on the product.
17. Servicing—Do not attempt to service this product yourself as opening or removing covers may expose you to dangerous voltage or other hazards. Refer all servicing to qualified service personnel.
18. Damage Requiring Service—Unplug this product from the wall outlet and refer servicing to qualified service personnel under the following conditions:
 - a. If the power-supply cord or plug is damaged.
 - b. If liquid has been spilled, or objects have fallen into the product.
 - c. If the product has been exposed to rain or water.
 - d. If the product does not operate normally by following the operating instructions. Adjust only those controls that are covered by the operating instructions, as an improper adjustment of other controls may result in damage and will often require extensive work by a qualified technician to restore the product to normal operation.
 - e. If the product has been dropped or damaged in any way.
 - f. If the product exhibits a distinct change in performance—this indicates a need for service.
19. Replacement Parts—When replacement parts are required, be sure the service technician has used replacement parts specified by the manufacturer or with the same characteristics as the original part. Unauthorized substitutions may result in fire, electric shock, or other hazards.
20. Safety Check—Upon completion of any service or repairs to this product, ask the service technician to perform safety checks to determine that the product is in proper operating condition.
21. Wall or Ceiling Mounting—This product should be mounted to a wall or ceiling only as recommended by the manufacturer.
22. Heat—This product should be situated away from heat sources such as radiators, heat registers, stoves, or other products (including amplifiers) that produce heat.

Usage Guidelines

Cautions Concerning the Laser Pointer

The laser pointer on the remote control emits a laser beam from the laser light window. This is a Class II laser which may impair your sight if directed into the eyes. The three marks shown on the right are caution labels for the laser beam.

- Do not look into the laser light window or shine the laser beam on yourself or others. (The laser beam used in this product is harmless when directed onto the skin. However, be careful not to project the beam directly into the eyes.)
- Always use the laser pointer at temperatures between 41°F and 104°F (+5°C and +40°C).
- Use of controls or adjustments, or performance of procedures other than those specified herein may result in hazardous radiation exposure.

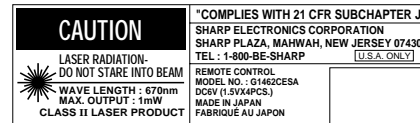

AVOID EXPOSURE-LASER
RADIATION IS EMITTED
FROM THIS APERTURE.

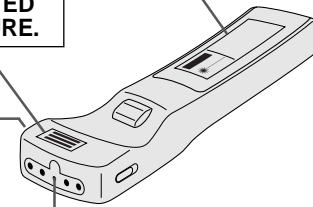

Laser light window

Cautions Concerning the Setup of the Projector

- For minimal servicing and to maintain high image quality, SHARP recommends that this projector be installed in an area free from humidity, dust and cigarette smoke. When the projector is subjected to these environments, the lens and filter must be cleaned more often. Periodically the filter should be replaced and the projector should be cleaned internally. As long as the projector is properly maintained in this manner, use in these environments will not reduce the overall operation life. Please note that all internal cleaning must be performed by an Authorized Sharp Industrial LCD Products Dealer or Service Center.
- Do not expose the projector to extreme heat or cold.
Operating temperature: 41°F to 104°F (+5°C to +40°C)
Storage temperature: -4°F to 140°F (-20°C to +60°C)
- Do not tilt the projector at an angle greater than 5°.

Notes on Operation

- The exhaust vent, the lamp cage cover and adjacent areas may be extremely hot during projector operation. To prevent injury, do not touch these areas until they have sufficiently cooled.
- Allow at least 4 inches (10 cm) of space between the cooling fan (exhaust vent) and the nearest wall or obstruction.
- If the cooling fan becomes obstructed, a protection device will automatically turn off the projector lamp. This does not indicate a malfunction. Remove the projector power cord from the wall outlet and wait at least 10 minutes. Then turn on the power by plugging the power cord back in. This will return the projector to the normal operating condition.

Temperature Monitor Function

If the projector starts to overheat due to setup problems or a dirty air filter, "TEMP." will flash in the upper-left corner of the picture. If the temperature continues to rise, the lamp will turn off, the TEMPERATURE WARNING indicator on the projector will flash, and after a 90-second cooling-off period the power will shut off. Refer to "Lamp/Maintenance Indicators" on page 29, when "TEMP." appears on the screen.

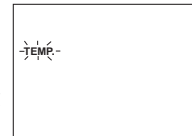

NOTE

- The cooling fan regulates the internal temperature, and its performance is automatically controlled. The sound of the fan may change during projector operation due to changes in the fan speed.

Lamp Monitor Function

When the projector is turned on after the lamp has been used for 1,900 hours, the LAMP REPLACEMENT indicator will light red and "LAMP" will flash in yellow on the screen to advise you to replace the lamp. See pages 30 and 31 for replacing the lamp. If the lamp has been used for 2,000 hours, the projector power will automatically turn off and the projector will enter standby mode. Refer to "Lamp/Maintenance Indicators" on page 29, when "LAMP" appears on the screen.

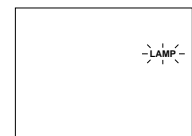

Remote Control Handling Precaution

- Do not expose the remote control to shocks, liquids or high humidity. The remote control may not operate normally if exposed to direct sunlight or other intense light sources. Should this occur, reposition the light source or the projector.
- When not using the remote control, turn off the Main Power switch to avoid draining the batteries.

For SHARP Assistance (U.S.A. only)

If you encounter any problems during setup or operation of this projector, first take a look at the section "Troubleshooting" on page 31. If this operation manual does not answer your question, please call toll free 1-800-BE-SHARP (1-800-237-4277) for further assistance. Or, send us an e-mail at lcdsupport@sharplcd.com.

Our World Wide Web address is <http://www.sharp-usa.com/>.

Outstanding Features

The SHARP LCD Projector enables easy projection of large screen, full-color computer and video images that can be projected directly onto a video screen or white wall. This lightweight, convergence-free system allows for easy installation.

DIRECT COMPUTER COMPATIBILITY

A multi-scan RGB input accepts signals from XGA (1,024 dots × 768 lines compressed), SVGA (800 dots × 600 lines), VGA (640 dots × 480 lines) and Macintosh (832 dots × 624 lines maximum) compatible computers without the need for any additional hardware.

NOTE

- Due to the native pixel resolution of the LCD panels (804 × 604), this projector will not display Mac 832 × 624 resolution images full screen.

HIGH IMAGE QUALITY

Three LCD panels contain 485,616 × RGB pixels to achieve exceptionally bright, high quality images.

INTELLIGENT COMPRESSION

XGA images are compressed and projected without image data loss.

VERSATILE WIRELESS MOUSE REMOTE CONTROL

- Built-in wireless mouse allows simultaneous operation of projector and computer.
- Built-in laser pointer enables professional presentations.

FLEXIBLE USE

- In addition to standard front projection, the menu driven functions can be used to instantly reverse the image for rear projection and invert the image for ceiling mounting projection.
- Screen projection size adjustable from 40 to 300 inches.

USE WITH "PLUG AND PLAY"

Plug and Play function compatible with VESA DDC 1 and DDC 2B standards.

MULTILINGUAL ON-SCREEN DISPLAY

On-screen Display can be set to any of eight languages.







AUTO SYNC FUNCTION

Automatically synchronizes RGB input signals from a computer for optimum images.

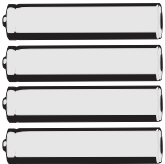
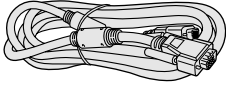
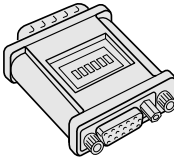
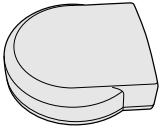
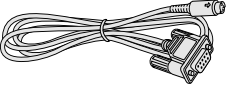
BUILT-IN SPEAKER

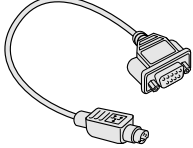
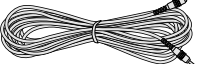
Built-in 2 W amplifier and speaker eliminate the need for external audio components.

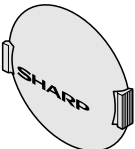
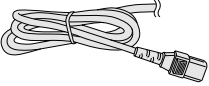
Supplied Accessories

 Remote control RRMCG1462CESA	 Four AA size batteries	 Computer cable QCNW-5108CEZZ	 Macintosh adaptor OPLGJ1512CEZZ	 Remote mouse receiver RUNTK0632CEZZ
 Mouse control serial cable QCNW-5112CEZZ	 Mouse control cable for IBM PS/2 QCNW-5113CEZZ	 Mouse control cable for Mac QCNW-5114CEZZ	 Computer audio cable QCNW-4870CEZZ	 Extra air filter PFILD0076CEZZ
 Lens cap GCOVH1307CESA	 Power cord QACCU5013CEZZ	 Carrying bag GCASN0001CESA		



Part Names

For details on the use of each control and terminal, refer to the page number indicated in the brackets.

Projector

Front View

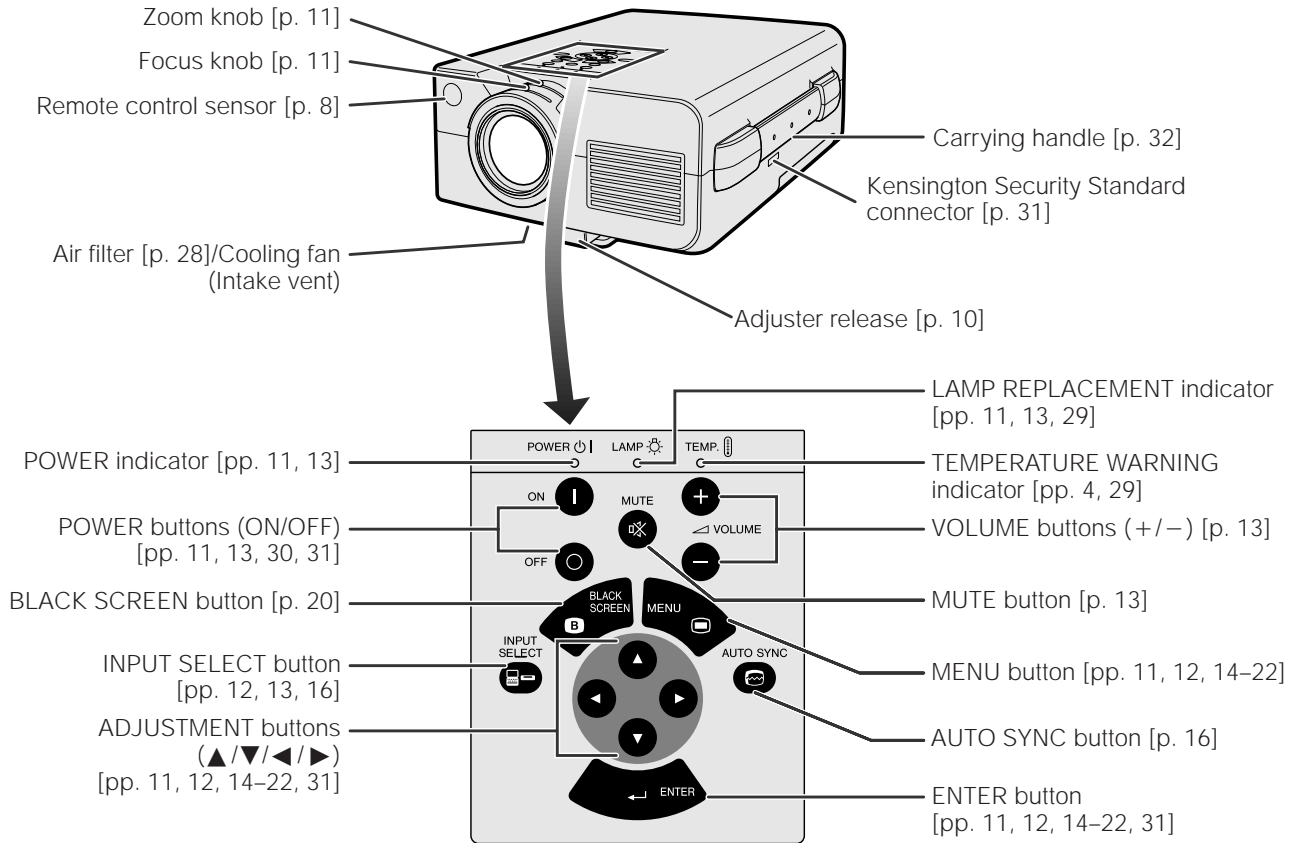

Side and Rear View

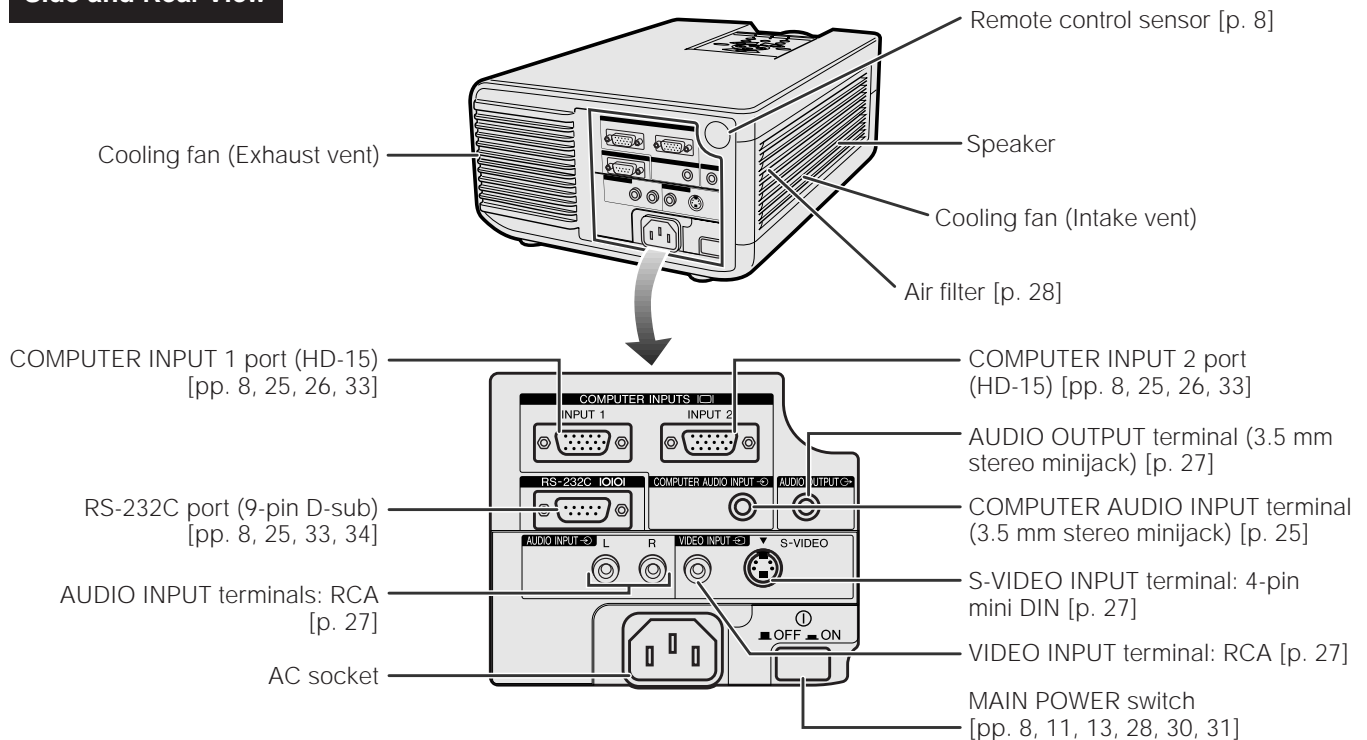



Wireless Mouse Remote Control

Front View

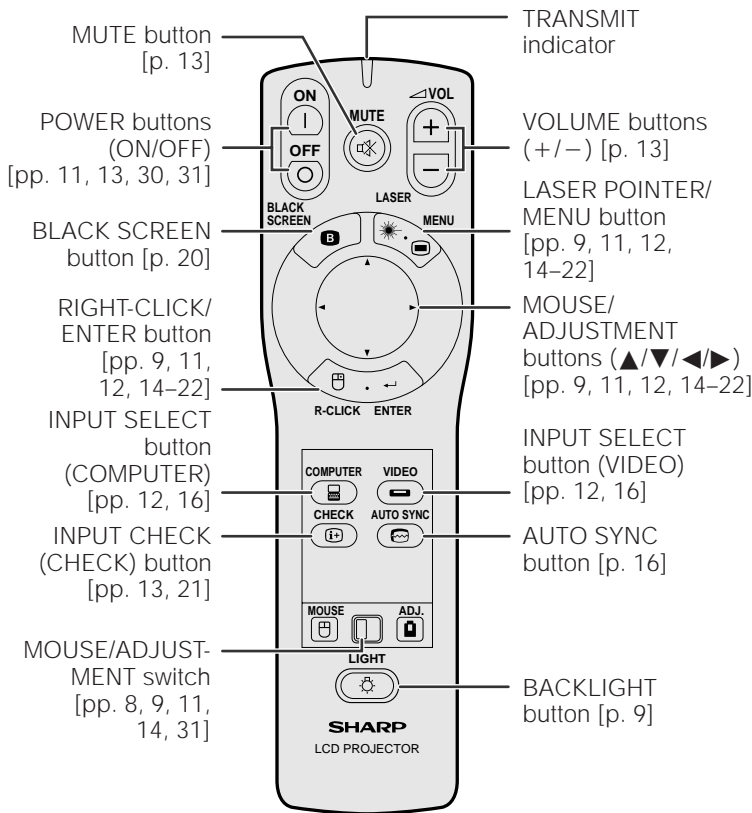

Side View

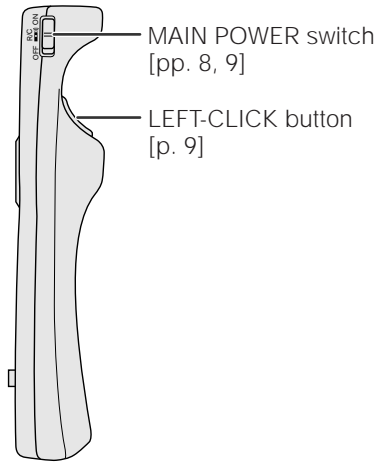

Top View

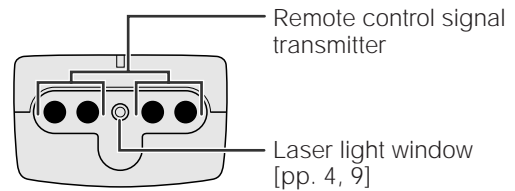

Rear View

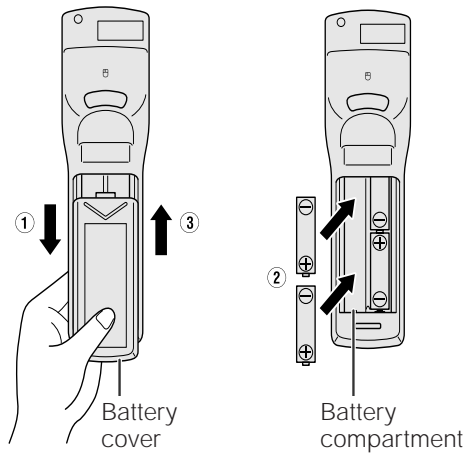

Inserting the batteries

1. Press in and downward on the arrow mark and remove the battery cover.
2. Insert four AA size batteries making sure their polarities match the + and - marks inside the battery compartment.
3. Insert the side tabs of the battery cover into their slots and press in the cover until properly seated.

NOTE

Incorrect use of batteries may cause them to leak or burst.

- Insert the batteries with the + and - polarities as indicated.
- Do not mix different brands of batteries. The life expectancy of the new batteries will be shortened and the old batteries may leak.
- Maintain the batteries in clean condition.
- Remove the batteries if the remote control will not be used for an extended period of time.
- When the batteries have been used up, remove them immediately to prevent leakage and damage. Leaked battery fluid may irritate the skin. Remove any battery fluid by wiping with a cloth.
- Due to storage conditions and the shelf life of the supplied batteries, they may run out after a short time. Should this occur, replace them with new batteries as soon as possible.



Part Names

Transmission range

Reception range

Max. distance: 23' (7 m)

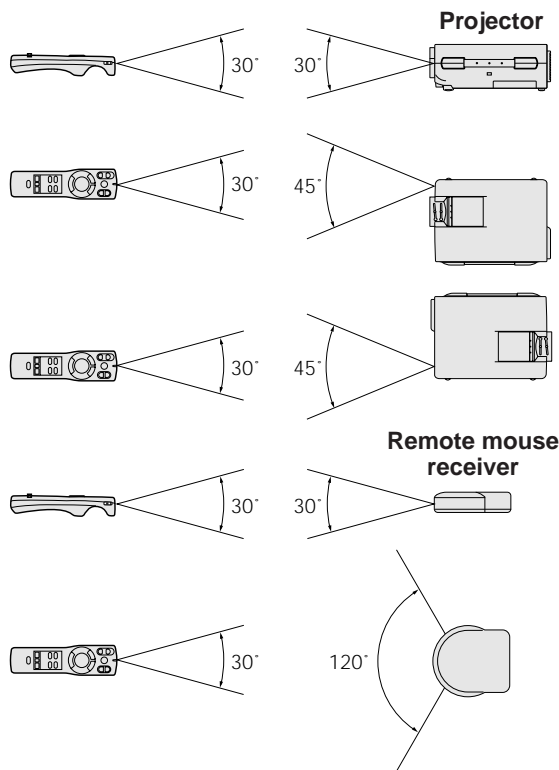

Remote control and remote mouse receiver positioning

The remote control can be used to control the projector in the ranges shown on the left.

The remote mouse receiver can be used with the remote control in the ranges shown to control the mouse functions of a connected computer. (See page 25 for details.)

NOTE

- The signal from the remote control can be reflected off the screen for easy operation. However, the effective distance of the signal may differ due to the screen material.



Operating the Wireless Mouse Remote Control

This remote control can be used for basic operations of the projector as well as operations of a connected computer by using the wireless mouse functions and remote mouse receiver. Together with the laser pointer, this can help you create a more professional presentation.

a. Connecting the projector to the computer

Connect the projector and the computer with the supplied computer cable. When using the remote mouse receiver to operate the computer, connect the remote mouse receiver to the computer. See pages 25 and 26 for details on these connections.

CAUTION

- Always turn on the projector first, then the computer on.

b. Wireless Mouse Operation

- After connecting the projector and the computer, turn them on.
- Slide the **MAIN POWER** switch on the side of the remote control to ON.
- When using the remote control as a wireless mouse, slide the **MOUSE/ADJUSTMENT** switch to the **MOUSE** position. When using the remote control to operate the projector, slide the switch to the **ADJ.** position.

CAUTION

- Do not connect or remove the mouse control cable and the computer cable to or from the computer while it is on. This may damage the computer.

NOTE

- The wireless mouse or RS-232C function may not operate if your computer port is not correctly set up. Please refer to the operation manual of the computer for details on setting up/installing the correct mouse driver.



Operating the Wireless Mouse Remote Control

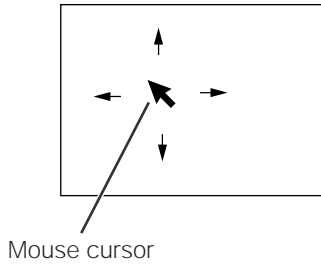

c. Moving the mouse cursor

Press ▲/▼/◀/▶ on the remote control to move the mouse cursor on the screen.

NOTE

- The amount of pressure applied to the ▲/▼/◀/▶ buttons determines the speed the mouse cursor travels. If you lightly press the periphery of the ▲/▼/◀/▶ buttons, the mouse cursor moves slowly. If you press hard, the mouse cursor moves quickly.
- The mouse sensitivity can also be adjusted from your computer's operating system.

d. Selecting the mouse button for two-button mouse systems

Use **LEFT-CLICK** on the back of the remote control to correspond to the left mouse button on two-button mouse systems, and **RIGHT-CLICK** on the front of the remote control to correspond to the right button.

NOTE

- For one-button systems, use either the **LEFT-CLICK** or **RIGHT-CLICK** button.

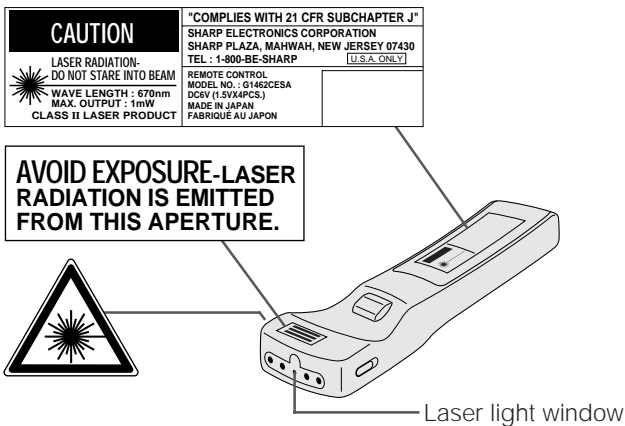

Using the laser pointer

The laser pointer on the remote control emits a laser beam from the laser light window. This is a Class II laser which may impair your sight if directed into the eyes. The three marks shown on the left are caution labels for the laser beam.

- Do not look into the laser light window or shine the laser beam on yourself or others. (The laser beam used in this product is harmless when directed onto the skin. However, be careful not to project the beam directly into the eyes.)
- Always use the laser pointer at temperatures between 41°F and 104°F (+5°C and +40°C).
- Use of controls or adjustments, or performance of procedures other than those specified herein may result in hazardous radiation exposure.

Press **LASER POINTER** (☼) to activate the laser pointer. When the button is pressed, the light stays on. When the button is released, the light automatically goes off.

NOTE

- For safety reasons, the laser pointer automatically goes off after 1 minute of continuous use. To turn it on again, press **LASER POINTER** (☼) one more time.

Using the remote control in a dark room

When the position of the **MOUSE/ADJUSTMENT** switch is changed, the functions of certain buttons on the remote control also change. You can determine the function of a button by the color of its backlight display. See the table on the left.

Press **BACKLIGHT** to turn on the backlights of the operation buttons for about five seconds.

NOTE

- If the **MAIN POWER** switch on the remote control is left on for more than 10 minutes without operation, the power will automatically turn off. To turn the power back on, press any button on the remote control for more than one second.

Button name	Position of MOUSE/ADJUSTMENT switch	
	MOUSE	ADJ.
LASER POINTER/MENU	LASER POINTER (GREEN)	MENU (RED)
RIGHT-CLICK/ENTER	RIGHT-CLICK (GREEN)	ENTER (RED)
MOUSE/ADJUSTMENT	MOUSE (NOT LIT)	ADJUSTMENT (NOT LIT)
LEFT-CLICK	ON (NOT LIT)	—
BLACK SCREEN	ON (RED)	
POWER ON/OFF		
VOLUME		
MUTE		
COMPUTER		
VIDEO		
INPUT CHECK		
AUTO SYNCHRONIZATION		



Setting Up the Projector (Standard Setup)

Optimal image quality can be achieved when the projector is positioned perpendicular to the screen with all feet flat and level.

NOTE

- Position the screen so that it is not in direct sunlight or room light. Light falling directly onto the screen washes out colors, making viewing difficult. Close the curtains and dim the lights when setting the screen in a sunny or bright room.

Example of a standard setup

Top View

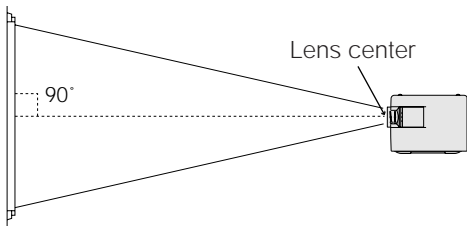

The projector lens should be centered in the middle of the screen.

Side View

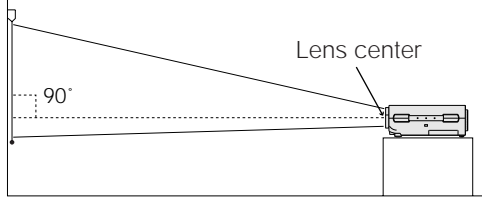

If the lens center is not perpendicular to the screen, the image will be distorted, making viewing difficult.

NOTE

- For information on projector distance and picture size, see page 23.
- For reversed image and ceiling-mount setups, see page 24.
- A polarizing screen cannot be used with this projector.



Adjusting the Height of the Picture

You can adjust the height of the picture by raising the projector with the adjuster release.

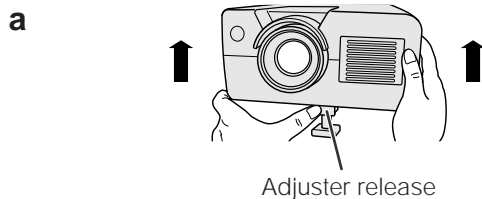

a. Extending the adjuster leg

Press the adjuster release and lift the projector to the desired angle.

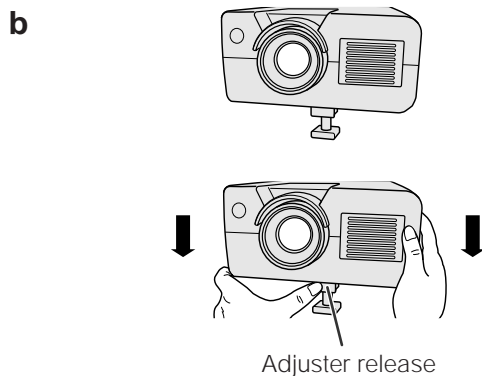

b. Locking the adjuster leg in position

Remove your hand from the adjuster release, and then release the projector once you are sure the adjuster leg has locked in position.

Returning the projector to its original position

While holding the projector, press the adjuster release and slowly lower the projector to its original position.

NOTE

- The projector is adjustable up to approximately 5° from the horizontal.
- When an adjustment is made, the image may become distorted, depending on the relative positions of the projector and the screen.

CAUTION

- Do not press the adjuster release when the adjuster leg is extended without firmly holding the projector.
- Do not hold the lens when lifting or lowering the projector.
- When lowering the projector, be careful not to get your fingers caught in the area between the adjuster leg and the projector.



Basic Operations

a

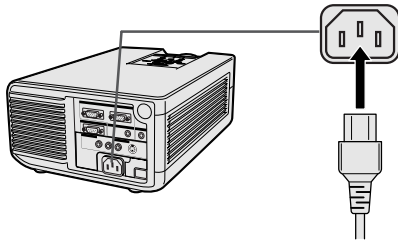

a. Connecting the Power Cord

Plug the supplied power cord into the AC socket on the back of the projector.

b

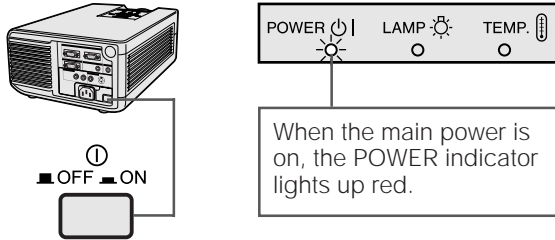

b. Turning on the Main Power

Press the **MAIN POWER** switch on the back of the projector. The **POWER** indicator lights up red and the projector enters standby mode.

NOTE

- When the main power is not on, the remote control cannot be used to operate the projector.

c

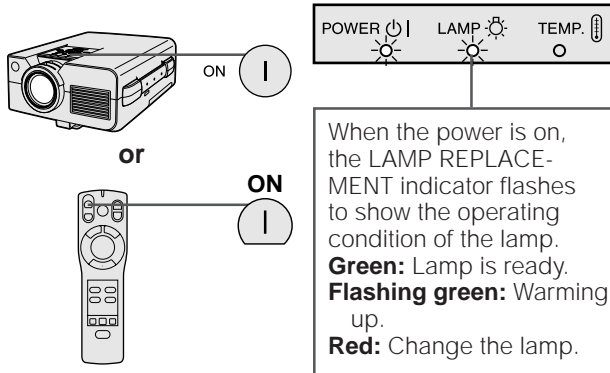

c. Turning on the Power

Press **POWER ON** on the projector or the remote control.

NOTE

- The flashing green LAMP REPLACEMENT indicator shows that the lamp is warming up. Wait until the indicator stops flashing before operating the projector.
- If the power is turned off and then immediately turned on again, it may take a short while before the lamp turns on. (During this period, the LAMP REPLACEMENT indicator flashes.)
- After the projector is unpacked and turned on for the first time, a slight odor may be emitted from the exhaust vent. This odor will soon disappear with use.

d

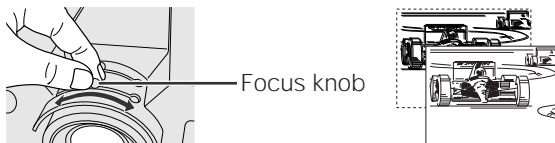

d. Adjusting the Focus

Slide the focus knob until the image on the screen becomes clear.

e

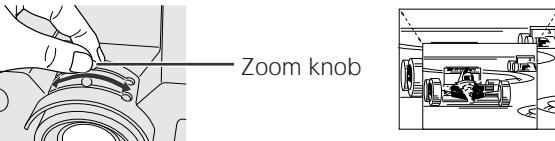

e. Adjusting the Zoom

Slide the zoom knob. The image can be adjusted to the desired size within the zoom range.

f. Selecting the On-screen Display Language

(See page 14 for details on using the menu screens.)

The On-screen Display is set to "ENGLISH" at the factory. The language for the On-screen Display can be set to English, German, Spanish, Dutch, French, Italian, Swedish or Japanese.

- Press **MENU** to display the menu screen. Press **ADJUSTMENT ▲/▼** to select "LANGUAGE". Then press **ENTER** to display the "LANGUAGE" screen.
- Press **ADJUSTMENT ▲/▼** to select the language you want to display on the screen. Then press **ENTER**. The On-screen Display is now programmed to display in the language selected.

On-screen Display

f.1

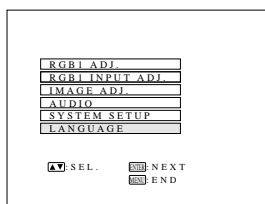

f.2

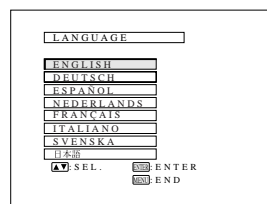



On-screen Display

g.1

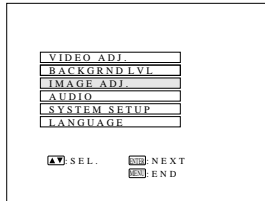

g.2

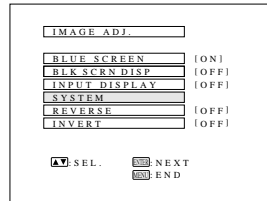

g.3

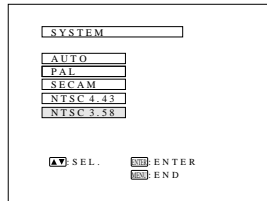

g. Selecting the Video Input System Mode

The video input system mode is set to "AUTO" at the factory; however, it can be changed to a different system mode, if the selected system mode is not compatible with the connected audiovisual equipment (such as when a color image appears in black and white, etc.).

1. Press **MENU** to display the menu screen. Press **ADJUSTMENT ▲/▼** to select "IMAGE ADJ." Then press **ENTER** to display the "IMAGE ADJ." screen.
2. Press **ADJUSTMENT ▲/▼** to select "SYSTEM". Then press **ENTER** to display the "SYSTEM" screen.
3. Press **ADJUSTMENT ▲/▼** to select the desired video system mode. Then press **ENTER**.

NOTE

- In AUTO mode, "PAL", "SECAM", "NTSC 4.43" or "NTSC 3.58" is displayed on the screen for a few seconds when the system mode is changed using **INPUT SELECT** on the projector.
- When the system mode is set to "AUTO", you may not receive a clear picture due to signal differences. Should this occur, switch to the color system you are viewing.

h

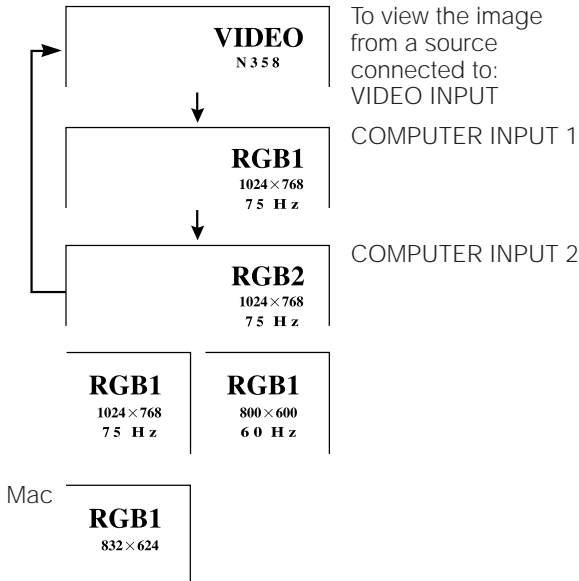

h. Selecting the Input Mode

1. Press **INPUT SELECT** on the projector to select the input mode. When you press the button, the current input mode will be displayed on the screen for 4 seconds. If you press it again while the input mode is displayed, the mode changes as shown on the left.

NOTE

- The input mode can be selected by directly pressing **COMPUTER** or **VIDEO** on the remote control. (When **COMPUTER** is pressed, "RGB1" and "RGB2" will appear accordingly.)

2. Press **INPUT SELECT** on the projector to confirm the selected input mode.

NOTE

- In VIDEO mode, the video system being received will be indicated below the "VIDEO" display.
- In RGB mode, the resolution being displayed will be indicated below the "RGB1" or "RGB2" display.
- When no signals are being received, "NO SIGNAL" will be displayed. When a signal that the projector is not preset to receive is being received, "NOT REG." will be displayed.
- The picture size differs in "RGB", "PAL", "SECAM" and "NTSC" modes.

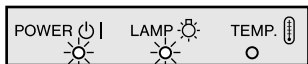
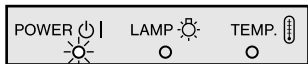
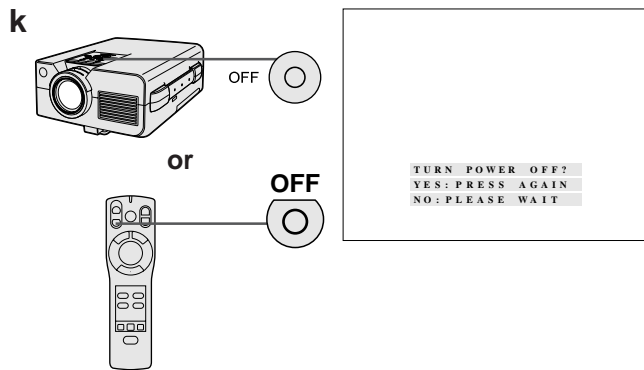
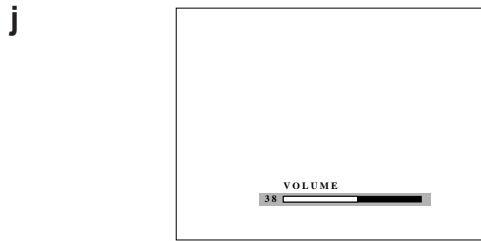
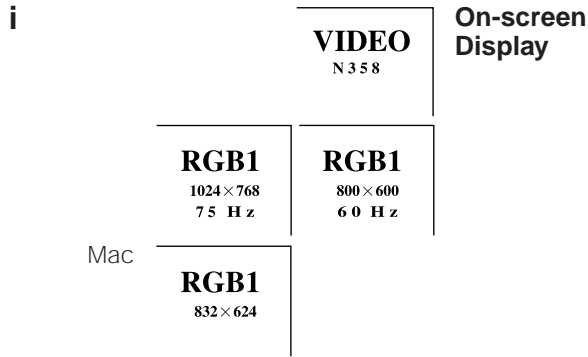

i. Checking the Input Mode

Press **INPUT SELECT** on the projector or **INPUT CHECK** on the remote control. The current input mode will be displayed on the screen for 4 seconds.

j. Adjusting the Volume

Press **VOLUME (VOL) + / -** on the projector or the remote control. The number of displayed segments (0-60) increases or decreases as the volume is raised or lowered.

To temporarily turn off the sound

Press **MUTE** on the projector or the remote control.

To turn the sound back on

Press **MUTE** once again.

k. Turning off the Power

1. Press **POWER OFF** on the projector or the remote control. The screen on the left will appear.
2. To turn off the power, press **POWER OFF** again while the screen is displayed. The power is now temporarily turned off.

NOTE

- If you accidentally pressed **POWER OFF** and do not want to turn off the power, wait until the screen disappears.

When **POWER OFF** is pressed twice, the **POWER** indicator will light up red and the cooling fan will run for about 90 seconds. The projector will then enter standby mode.

The power can be turned on again by pressing **POWER ON** on the projector or the remote control. When the power is turned on, the **POWER** indicator and the **LAMP REPLACEMENT** indicator light green.

NOTE

- When the main power is off on the projector, the power cannot be turned on from the remote control.

Using the Menu Screens

This projector has two sets of menu screens that allow you to adjust the picture and various projector settings. These menu screens can be operated from the projector or the remote control with the following buttons.

Remote control

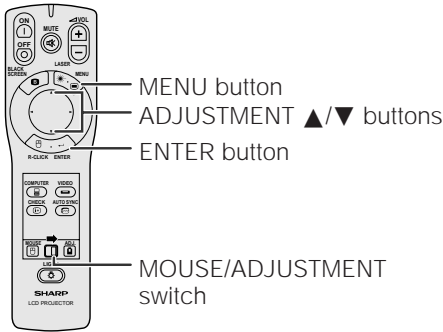

Projector

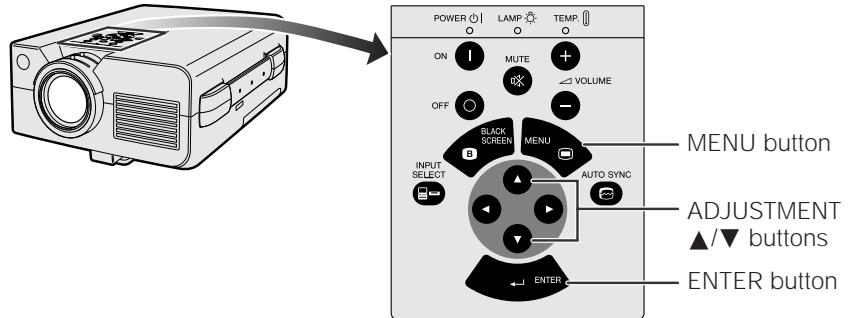

(When using the remote control to operate the menu screens, slide the MOUSE/ADJUSTMENT switch to the ADJ. position.)

1. Press MENU on the projector or the remote control to display the RGB1, RGB2 or VIDEO mode menu screen.

Menu Screen in RGB1 Mode

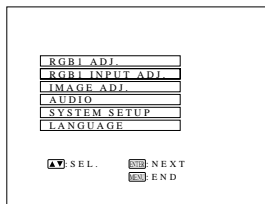

Items on the RGB1 or RGB2 Menu Screen

RGB ADJUSTMENT	PICTURE, BRIGHT, RED, BLUE (p. 15)
RGB INPUT ADJUSTMENT	AUTO SYNC, CLOCK, PHASE, HORIZONTAL POSITION, VERTICAL POSITION, MODE, MEMORY SELECT (pp. 16, 17)
IMAGE ADJUSTMENT	AUTO SYNC DISPLAY, BLACK SCREEN DISPLAY, INPUT DISPLAY, REVERSE, INVERT (pp. 20–22)
AUDIO	TREBLE, BASS (p. 18)
SYSTEM SETUP	RESOLUTION, HORIZONTAL FREQUENCY, VERTICAL FREQUENCY, LAMP USAGE TIME (p. 19)
LANGUAGE	ENGLISH, DEUTSCH, ESPAÑOL, NEDERLANDS, FRANÇAIS, ITALIANO, SVENSKA, JAPANESE (p. 11)

Menu Screen in VIDEO Mode

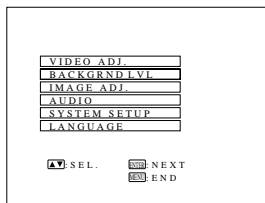

Items on the VIDEO Menu Screen

VIDEO ADJUSTMENT	PICTURE, BRIGHT, COLOR, TINT, SHARPNESS (p. 15)
BACKGROUND LEVEL	RED, BLUE (p. 19)
IMAGE ADJUSTMENT	BLUE SCREEN, BLACK SCREEN DISPLAY, INPUT DISPLAY, SYSTEM, REVERSE, INVERT (pp. 12, 20–22)
AUDIO	TREBLE, BASS (p. 18)
SYSTEM SETUP	LAMP USAGE TIME (p. 19)
LANGUAGE	ENGLISH, DEUTSCH, ESPAÑOL, NEDERLANDS, FRANÇAIS, ITALIANO, SVENSKA, JAPANESE (p. 11)

2. Press ADJUSTMENT ▲/▼ on the projector or the remote control to select the item you want to adjust, then press ENTER to display the sub menu screen.

NOTE

- For details on items on the sub menu screen and their settings, see pages indicated in the tables above.



Picture Adjustments

This projector's picture is factory preset to standard settings. However, you can adjust it to suit your own preferences by adjusting the four picture modes: "PICTURE", "BRIGHT", "RED" and "BLUE". The adjustments can be stored in the "RGB1", "RGB2" and "VIDEO" modes separately. (The following steps are used as an example in adjusting the picture in "RGB1 ADJ." mode.)

On-screen Display

a

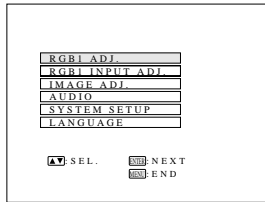

a. Displaying the "RGB1 ADJ." screen

Press **MENU** to display the menu screen. Press **ADJUSTMENT** ▲/▼ to select "RGB1 ADJ." Then press **ENTER** to display the "RGB1 ADJ." screen.

NOTE

- The menu screen is displayed for about 30 seconds.

b.1

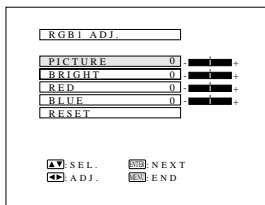

or

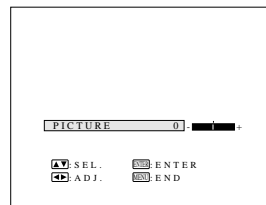

b. Adjusting the picture

1. Press **ADJUSTMENT** ▲/▼ to select the item you want to adjust.
To display only the adjustment item, press **ENTER** after selecting the item. Only the setting screen for the selected adjustment item will appear.
2. Press **ADJUSTMENT** ◀▶ to move the ◐ mark of the selected adjustment item to the desired setting.
3. Press **ENTER** to return to the "RGB1 ADJ." screen.

NOTE

- The "RGB1 ADJ." screen is displayed for about 30 seconds.

Description of Adjustment Items

Selected item	ADJUSTMENT ◀	ADJUSTMENT ▶
PICTURE	For less contrast	For more contrast
BRIGHT	For less brightness	For more brightness
RED	For weaker red	For stronger red
BLUE	For weaker blue	For stronger blue
COLOR	For less color intensity	For more color intensity
TINT	Skin tones become purplish	Skin tones become greenish
SHARPNESS	For less sharpness	For more sharpness
RESET	All RGB video adjustment items are returned to the factory preset settings.	

NOTE

- To reset all adjustment items, select "RESET" on the "RGB 1 ADJ." screen and press **ENTER**.

NOTE

- When a VIDEO input mode is selected, only "PICTURE", "BRIGHT", "COLOR", "TINT" and "SHARPNESS" can be adjusted.
- "TINT" appears only in "NTSC 3.58" mode.

To return to normal screen, press MENU.



Computer Adjustments

When displaying computer patterns which repeat every dot (tiling, vertical stripes, etc.), interference may occur between the LCD pixels, causing flickering, vertical stripes, or contrast irregularities in portions of the screen. Should this occur, adjust "CLOCK", "PHASE", "H-POS" and "V-POS" for optimum computer image.

On-screen Display

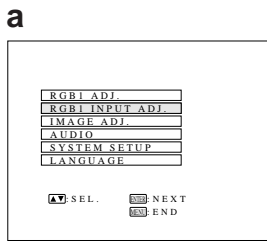

b

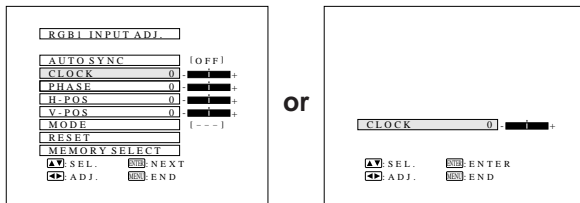

a. Displaying the "RGB1 INPUT ADJ." screen

Press **INPUT SELECT** to select the input you want to adjust ("RGB1" in this example) and press **MENU** to display the menu screen. Press **ADJUSTMENT** ▲/▼ to select "RGB1 INPUT ADJ." Then press **ENTER** to display the "RGB1 INPUT ADJ." screen.

b. Adjusting the computer input item

Press **ADJUSTMENT** ▲/▼ to select the item you want to adjust. To display only the item you want to adjust, press **ENTER** after selecting the item with **ADJUSTMENT** ▲/▼. Then press **ADJUSTMENT** ◀/▶ to adjust the item.

Description of Adjustment Items

Auto Sync Adjustment

Used to automatically adjust the RGB input signals when turning on the projector to achieve optimum images.

NOTE

- When "AUTO SYNC" is set to "ON", adjustments to the computer settings are automatically made when the projector is turned on or when the COMPUTER/RGB mode is changed.
- When "AUTO SYNC" is set to "OFF", automatic adjustments can be made by pressing **AUTO SYNC** on the projector or the remote control.

During Auto Sync Adjustment, the On-screen Display on the left appears.

NOTE

- Auto Sync Adjustment may take some time to complete depending on the image of the computer connected to the projector.
- To display a blue screen (in place of the Auto Sync Adjustment screen), see "Auto Sync Display Function (RGB mode only)" on page 20.

Manual Adjustment

Used when Auto Sync Adjustment is not effective.

CLOCK SPEED ADJUSTMENT (FAST/SLOW): Used to adjust the input signal horizontal frequency and the dot clock.

PHASE ADJUSTMENT (UP/DOWN): Used to reduce image distortion or improve contrast.

HORIZONTAL POSITION ADJUSTMENT (LEFT/RIGHT): Used to center the on-screen image by moving it to the left or right.

VERTICAL POSITION ADJUSTMENT (UP/DOWN): Used to center the on-screen image by moving it up or down.

Mode Adjustment

CONNECTING TO IBM-PC COMPUTERS

- Ordinarily, the type of input signal is detected and the correct resolution mode (Text or Graphics) is automatically selected. However, for the following signals, set "MODE" to "ON" or "OFF" to select the projector's resolution mode to match the computer display mode properly.

720 dots × 400 lines, 720 dots × 350 lines (Text Mode)

640 dots × 400 lines, 640 dots × 350 lines (Graphic Mode)

- For text mode, set "MODE" to "OFF".
- For graphic mode, set "MODE" to "ON".

CONNECTING TO MACINTOSH SERIES COMPUTERS

- When connecting to a Macintosh II with 35 kHz dot frequency, set "MODE" to "ON".
- When connecting to a Macintosh LC Series computer with 34.79 kHz dot frequency, set "MODE" to "OFF".



- When connecting third party video cards and other Macintosh computers, set "MODE" to "ON" or "OFF" to select the correct display mode.
- When the input signal is automatically detected or when there is no input signal, "MODE(---)" appears on the screen and the display mode cannot be changed.

Initial Reset

To return "CLOCK", "PHASE", "H-POS" and "V-POS" adjustments to their initial settings, select "RESET" and then press **ENTER**.

Memory Select

Used to store up to seven computer mode adjustments. (See below.)

NOTE

- Avoid displaying computer patterns which repeat every other line (horizontal stripes). (Flickering may occur, making the image hard to see.)

To return to normal screen, press **MENU**.

Computer Mode Memory Adjustments

This projector allows you to store up to seven RGB input adjustment settings for use with various computers. Once these settings are stored, they can be easily selected each time you connect the computer to the projector.

a. Customizing the RGB input adjustment settings

1. Press **MENU** to display the menu screen. Press **ADJUSTMENT** ▲/▼ to select "RGB1 INPUT ADJ." Then press **ENTER** to display the "RGB1 INPUT ADJ." screen.
2. Press **ADJUSTMENT** ▲/▼ to select "MEMORY SELECT". Then press **ENTER** to display the "MEMORY SELECT" screen.
3. Press **ADJUSTMENT** ▼ once, then press **ADJUSTMENT** ◀▶ to select the number of the memory adjustment mode you want to adjust.

NOTE

- If the memory position has not been set, "NON" will appear on the screen.
 - Memory No. 0 cannot be set. It contains the fixed factory preset setting.
4. Press **ADJUSTMENT** ▲/▼ to select "SETTING". Then press **ENTER** to return to the "RGB1 INPUT ADJ." screen.
 5. Press **ADJUSTMENT** ▲/▼ to select the item you want to adjust. Then press **ADJUSTMENT** ◀▶ to adjust the setting.
 6. Press **MENU** to store the adjusted RGB input adjustment setting under the number of the selected memory adjustment mode.

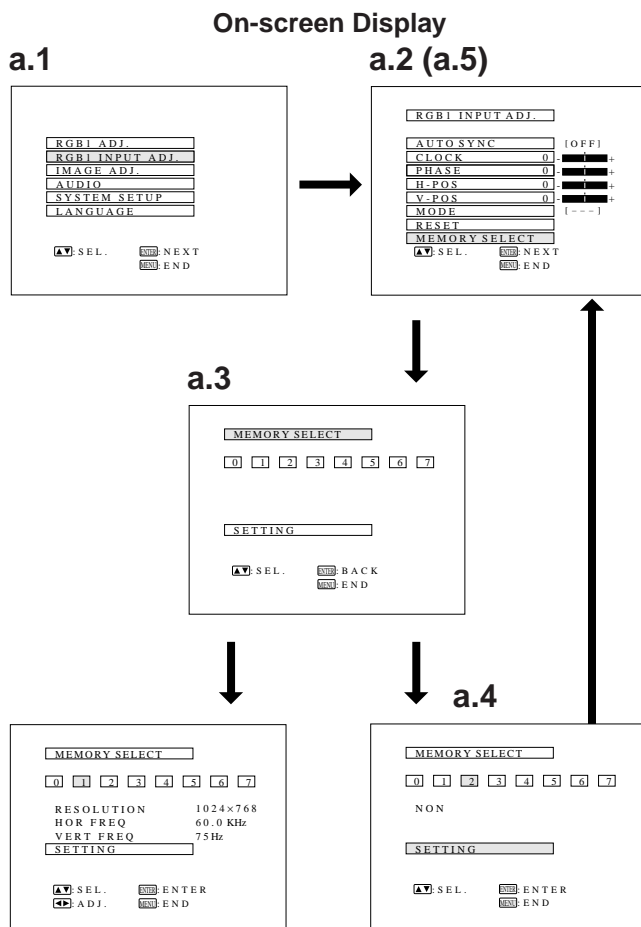



Audio Adjustments

This projector's audio is factory preset to standard settings. However, you can adjust it to suit your own preferences by adjusting "TREBLE" and "BASS".

a On-screen Display

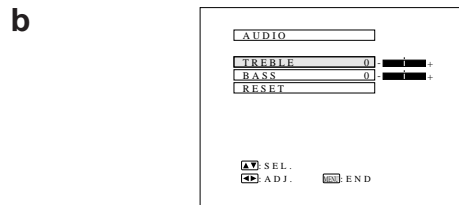
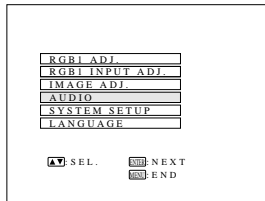

a. Displaying the "AUDIO" screen

Press **MENU** to display the menu screen. Press **ADJUSTMENT ▲/▼** to select "AUDIO". Then press **ENTER** to display the "AUDIO" screen.

b. Adjusting the audio

1. Press **ADJUSTMENT ▲/▼** to select the audio item you want to adjust.
2. Press **ADJUSTMENT ◀/▶** to move the **0** mark of the selected adjustment item to the desired setting.

Description of Adjustment Items

Selected item	ADJUSTMENT ◀	ADJUSTMENT ▶
TREBLE	For weaker treble	For stronger treble
BASS	For weaker bass	For stronger bass
RESET	All audio adjustment items are returned to the factory preset setting. NOTE • To reset all adjustment items, select "RESET" on the "AUDIO" screen and press ENTER .	

To return to normal screen, press **MENU**.



Checking the System Setup

This function allows you to check the current input signal and lamp usage time.

a On-screen Display

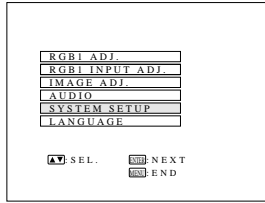

b

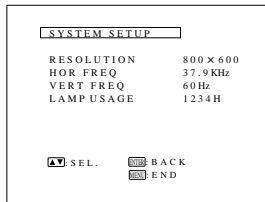

a. Displaying the “SYSTEM SETUP” screen

Press **MENU** to display the menu screen. Press **ADJUSTMENT ▲/▼** to select “SYSTEM SETUP”. Then press **ENTER** to display the “SYSTEM SETUP” screen.

b. Checking the system setup

The current system condition, including the lamp usage time, will be displayed.

NOTE

- In VIDEO mode, the resolution and frequency settings will not be displayed.

To return to normal screen, press **MENU**.



Background Level (VIDEO mode only)

This function allows you to adjust the picture white balance (“RED” and “BLUE”) for the selected video input to achieve optimal image quality.

NOTE

- This function cannot be used when RGB mode is selected.

a

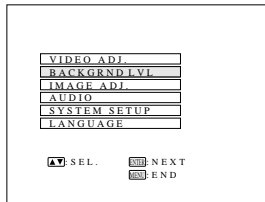

a. Displaying the “BACKGRND LVL” screen

Press **MENU** to display the menu screen. Press **ADJUSTMENT ▲/▼** to select “BACKGRND LVL”. Then press **ENTER** to display the “BACKGRND LVL” screen.

b.1

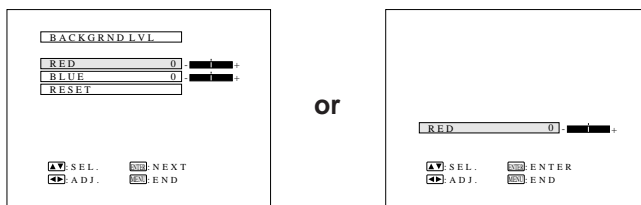

b. Adjusting the background level

1. Press **ADJUSTMENT ▲/▼** to select the item you want to adjust. To display only the adjustment item, press **ENTER** after selecting the item. Only the setting screen for the selected adjustment item will appear.
2. Press **ADJUSTMENT ◀▶** to move the **0** mark of the selected adjustment item to the desired setting.

To return to normal screen, press **MENU**.

NOTE

- See the table on page 15 for the description of adjustment items.

Black Screen Function

This function can be used to superimpose a black screen over a presentation image.

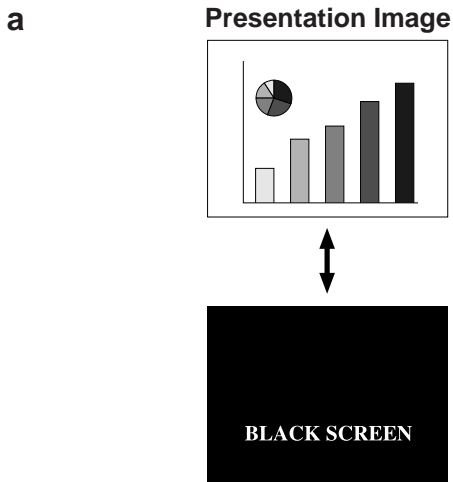

a. Blacking out the image

Press **BLACK SCREEN** on the projector or the remote control to black out the image. "BLACK SCREEN" appears on the screen. To return to the presentation image press **BLACK SCREEN** again.

NOTE

- When "BLK SCR N DISP" on the "IMAGE ADJ." screen is set to "OFF", the On-screen Display ("BLACK SCREEN") will not appear during black screen. See the following section.

Turning off the On-screen Display

The On-screen Display ("BLACK SCREEN") that appears during black screen can be turned off. When "BLK SCR N DISP" is set to "OFF", the On-screen Display will not appear during black screen.

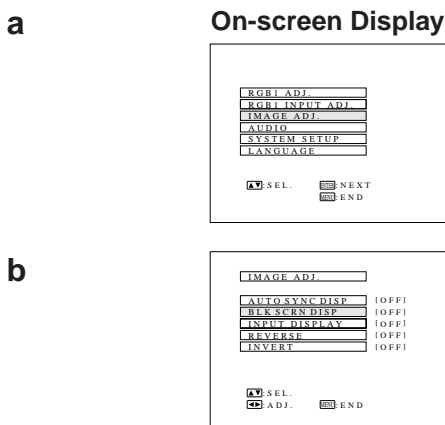

a. Displaying the "IMAGE ADJ." screen

Press **MENU** to display the menu screen. Press **ADJUSTMENT ▲/▼** to select "IMAGE ADJ." Then press **ENTER** to display the "IMAGE ADJ." screen.

b. Turning on the black screen On-screen Display override function

Press **ADJUSTMENT ▲/▼** to select "BLK SCR N DISP". Then press **ADJUSTMENT ◀/▶** to select "OFF".

To return to normal screen, press **MENU**.

Auto Sync Display Function (RGB mode only)

This function can be used to display a blue screen (in place of the Auto Sync Adjustment screen) during Auto Sync Adjustment (see p. 16).

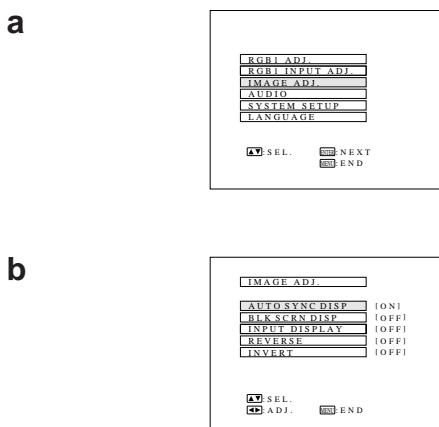

a. Displaying the "IMAGE ADJ." screen

Press **MENU** to display the menu screen. Press **ADJUSTMENT ▲/▼** to select "IMAGE ADJ." Then press **ENTER** to display the "IMAGE ADJ." screen.

b. Turning on the auto sync display function

Press **ADJUSTMENT ▲/▼** to select "AUTO SYNC DISP". Then press **ADJUSTMENT ◀/▶** to select "ON". A blue screen will now appear during Auto Sync Adjustment. (When "AUTO SYNC DISP" is set to "OFF", the screen displays the image during Auto Sync Adjustment.)

To return to normal screen, press **MENU**.



Blue Screen Function (VIDEO mode only)

This function can be used to display a blue screen when the video input terminal is not connected to anything, when the video equipment is turned off, or when no video signal is being input through the video input terminal.

NOTE

- This function cannot be used when RGB mode is selected.

a On-screen Display

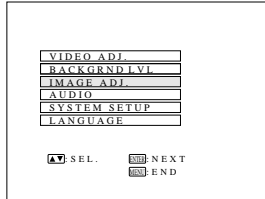

a. Displaying the “IMAGE ADJ.” screen

Press **MENU** to display the menu screen. Press **ADJUSTMENT ▲/▼** to select “IMAGE ADJ.” Then press **ENTER** to display the “IMAGE ADJ.” screen.

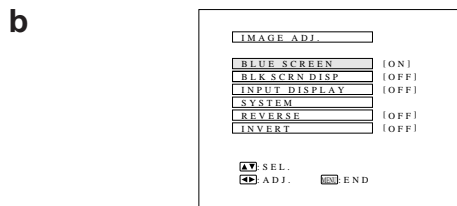

b. Turning on the blue screen

Press **ADJUSTMENT ▲/▼** to select “BLUE SCREEN”. Then press **ADJUSTMENT ◀/▶** to select “ON”.

To return to normal screen, press MENU.

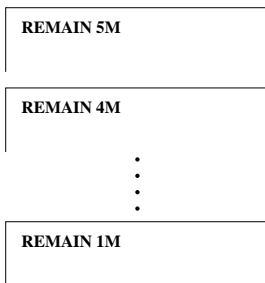

- When the blue screen is on, and no video signal is input via the input terminal for more than 15 minutes, the power automatically turns off.
- The On-screen Displays as shown on the left appear at one minute intervals for five minutes before the power is turned off.



Using the Input Mode On-screen Display Override Function

This function allows you to turn off the On-screen Displays (“RGB1 800 × 600, 60 Hz”, etc.) that appear during input select (see pages 12 and 13 for details). Once “INPUT DISPLAY” is set to “OFF”, the On-screen Displays will not appear even if **INPUT CHECK** on the remote control is pressed.

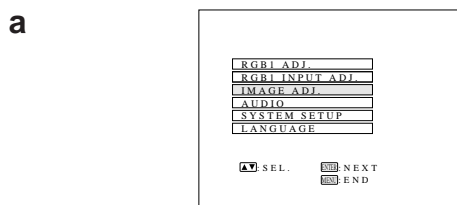

a. Displaying the “IMAGE ADJ.” screen

Press **MENU** to display the menu screen. Press **ADJUSTMENT ▲/▼** to select “IMAGE ADJ.” Then press **ENTER** to display the “IMAGE ADJ.” screen.

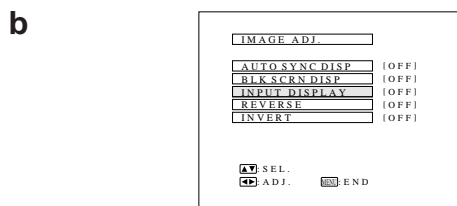

b. Turning on the input mode On-screen Display override function

Press **ADJUSTMENT ▲/▼** to select “INPUT DISPLAY”. Then press **ADJUSTMENT ◀/▶** to select “OFF”.

To return to the normal screen, press MENU.



Using the Reverse/Invert Image Function

This projector is equipped with a reverse/invert image function which allows you to reverse or invert the projected image.

NOTE

- This function is useful for the reversed image and ceiling-mount setups. See page 24 for these setups.

On-screen Display

a

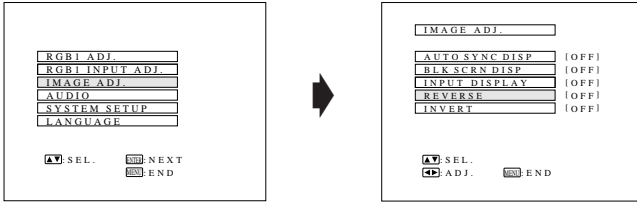

a. Displaying the “IMAGE ADJ.” screen

Press **MENU** to display the menu screen. Press **ADJUSTMENT ▲/▼** to select “IMAGE ADJ.” Then press **ENTER** to display the “IMAGE ADJ.” screen.

NOTE

- The last screen selected is displayed for about 30 seconds.

b

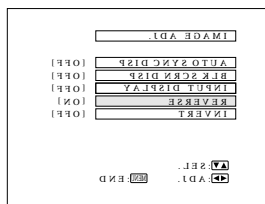

b. Reversed image mode

Press **ADJUSTMENT ▲/▼** to select “REVERSE”. Then press **ADJUSTMENT ◀/▶** to select “ON”. The reversed image will appear.

c

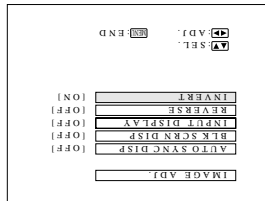

c. Inverted image mode

Press **ADJUSTMENT ▲/▼** to select “INVERT”. Then press **ADJUSTMENT ◀/▶** to select “ON”. The inverted image will appear.

d

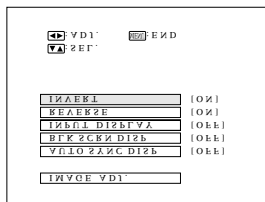

d. Reversed inverted image mode

Set “REVERSE” and “INVERT” to “ON”. The reversed inverted image will appear.

To return to normal screen, press MENU.



Relationship between Projector Distance and Picture Size

- The zoom lens enables adjustment of the picture size within the adjustment range.
- For optimum picture adjustment, the projector should be placed at a distance from the screen according to the desired picture size (see the table below).

NOTE

- Optimal image quality can be achieved with the projector positioned perpendicular to the screen with all feet flat and level.

Distance from screen

Example picture size: 100 inches (254 cm)

Zoom adjustment range:
19' 6" (6.0 m)–13' 1" (4.0 m)

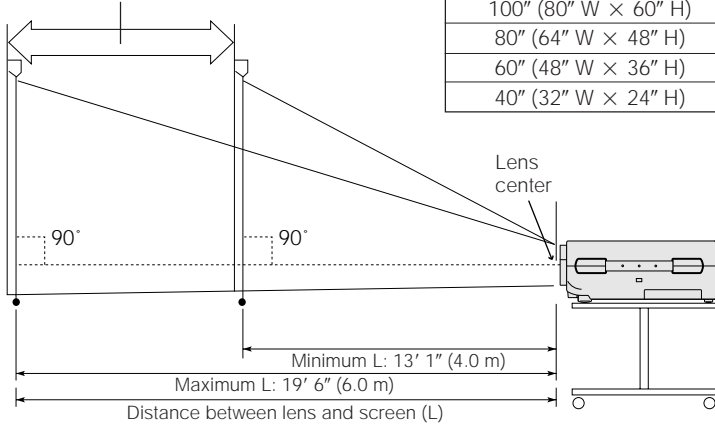

Picture size (diag.)	Projection distance (L)	
	Maximum projection distance	Minimum projection distance
300" (240" W × 180" H)	59' 2" (18.1 m)	39' 8" (12.1 m)
200" (160" W × 120" H)	39' 4" (12.0 m)	26' 5" (8.1 m)
150" (120" W × 90" H)	29' 5" (9.0 m)	19' 8" (6.0 m)
100" (80" W × 60" H)	19' 6" (6.0 m)	13' 1" (4.0 m)
80" (64" W × 48" H)	15' 6" (4.8 m)	10' 4" (3.2 m)
60" (48" W × 36" H)	11' 7" (3.6 m)	7' 8" (2.4 m)
40" (32" W × 24" H)	7' 7" (2.4 m)	5' 1" (1.6 m)

The formula for picture size and projection distance

$$y_1 = (0.1982x - 0.219) \times 3.28$$

$$y_2 = (0.1333x - 0.21) \times 3.28$$

x: Picture size (diag.) (inches)

y₁: Maximum projection distance (feet)

y₂: Minimum projection distance (feet)

NOTE

- There is an error of ± 4 inches (± 10 cm) in the formula above.

Above is an illustration of maximum and minimum projection distances for the XG-NV4SU with a picture size of 100 inches (254 cm). Move the projector forward or backward if the edges of the image are distorted.

Height of Projector

Adjust to match the setup configuration.

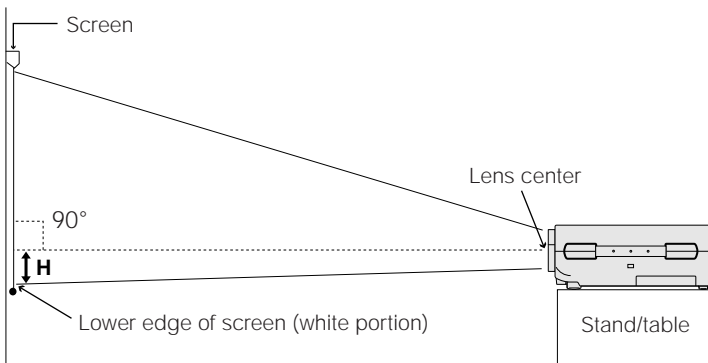

Picture size (diag.)	Distance from lens center to lower edge of screen (H)
300" (240" W × 180" H)	18" (45.8 cm)
200" (160" W × 120" H)	12" (30.5 cm)
150" (120" W × 90" H)	9" (22.9 cm)
100" (80" W × 60" H)	6" (15.3 cm)
80" (64" W × 48" H)	4 51/64" (12.2 cm)
60" (48" W × 36" H)	3 19/32" (9.2 cm)
40" (32" W × 24" H)	2 25/64" (6.1 cm)

Ceiling Mount

When the projector is in the inverted position, use the upper edge of the screen as the base line.

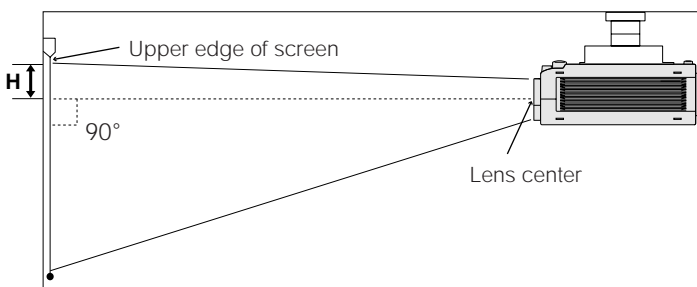



Reversed Image and Ceiling-mount Setups

Using the Reverse/Invert Image Function makes the following setups possible. See page 22 for use of this function.

Example of a reversed image setup

- By placing a mirror (normal flat type) in front of the lens and using the horizontal image reverse function, the image reflected from the mirror can be projected onto the screen.
- Rear projection with a rear projection screen is also possible when using the horizontal image reverse function.

Side View

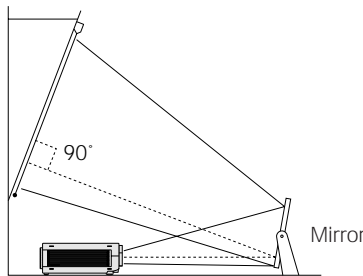

The projector lens should be centered in the middle of the screen.

Side View

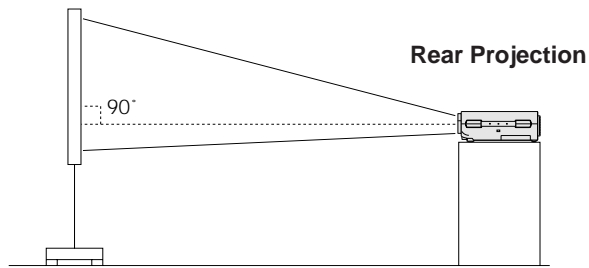

If the lens center is not perpendicular to the screen, the image will be distorted, making viewing difficult.

CAUTION

- When using a mirror, be sure to carefully position both the projector and the mirror so the light does not shine into the eyes of the audience.

Example of a ceiling-mount setup

- Ceiling-mount is possible when using the optional ceiling-mount bracket.
- Before mounting the projector, be sure to contact your nearest Authorized Sharp Industrial LCD Products Dealer or Service Center to obtain the manufacturer recommended ceiling mount bracket (sold separately). (AN-XGCM50 Ceiling Mount Bracket, AN-EP101AP Extension Tube for AN-XGCM50.)

Top View

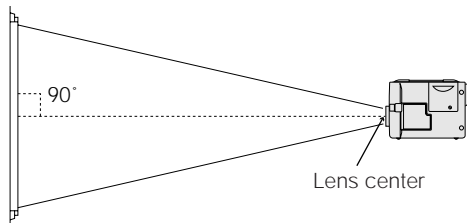

Side View

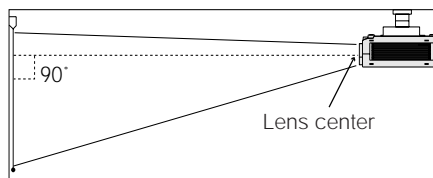

NOTE

- If the relative positions of the projector and the screen are not properly aligned, the image will be distorted.
- A polarizing screen cannot be used with this projector.



Connecting a Computer

You can connect your projector to a computer for easy projection of full color computer images. See page 26 for details on the connections.

Connecting the projector to the computer

Connect one end of the supplied computer cable into the COMPUTER INPUT (1 or 2) port on the projector and the other end into the RGB signal output port (Monitor Out) on the computer. When using the remote mouse receiver to operate the computer, plug the supplied mouse control cable from the remote mouse receiver to the computer.

CAUTION

- Before connecting, be sure to turn both the projector and the computer off. After making all connections, turn the projector on first. The computer should always be turned on last.

NOTE

- Please carefully read the operation manual of the computer you will be connecting.
- Refer to page 35 "Input Signals (Recommended Timing)" for a list of computers connectable to the projector. Use with computers other than those listed may cause some of the functions not to work.

NOTE

- When connecting to a Macintosh Series computer, use the supplied Macintosh adaptor.

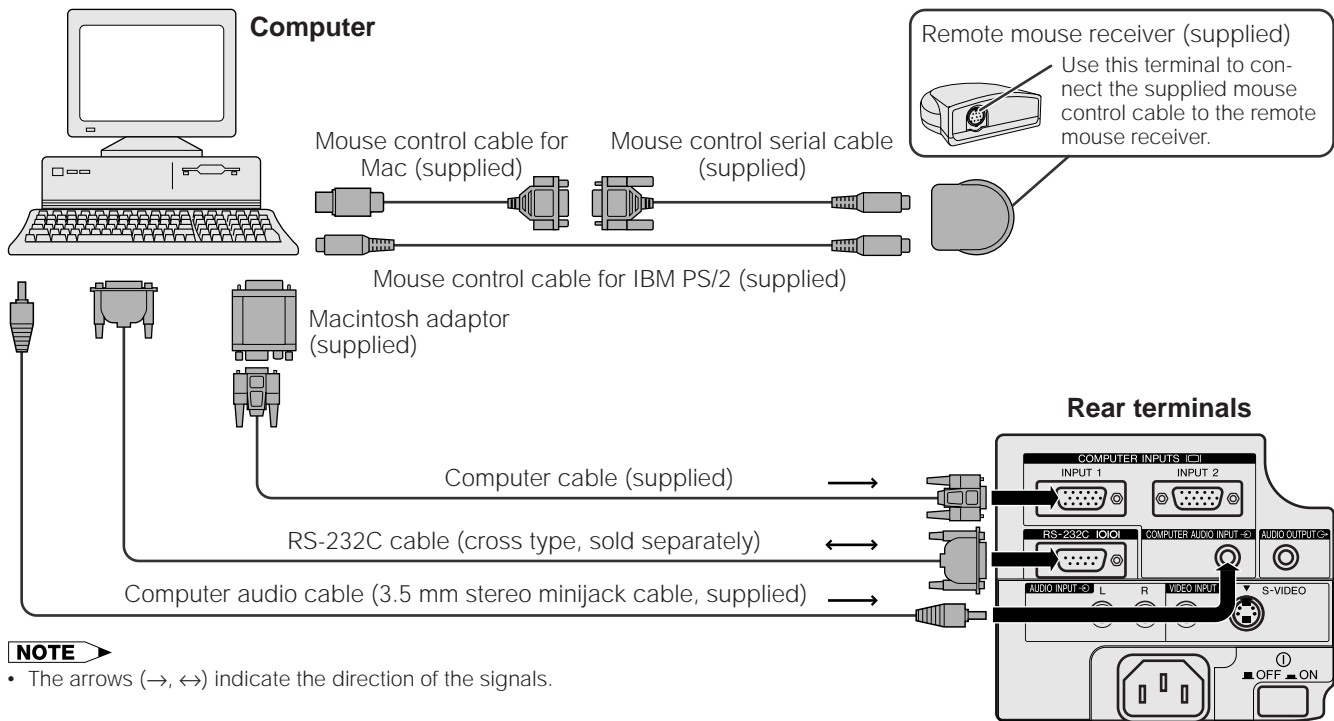

NOTE

- The arrows (→, ↔) indicate the direction of the signals.

“Plug and Play” Function

This projector is compatible with VESA-standard DDC 1/DDC 2B. The projector and a VESA DDC compatible computer will communicate their setting requirements, allowing for quick and easy setup.

NOTE

- The DDC, Plug and Play function of this projector operates only when used in conjunction with a VESA DDC compatible computer.

Using the Remote Mouse Receiver and RS-232C Port

- The remote mouse receiver can be used with the remote control to operate the computer. Plug the supplied mouse control cable from the remote mouse receiver to the computer.
- When the RS-232C port on the projector is connected to a computer with an RS-232C cable (cross type, sold separately), the computer can be used to control the projector and check the status of the projector. See pages 33 and 34 for details.

CAUTION

- Do not connect or remove the mouse control cables or RS-232C cable to or from the computer while it is on. This may damage your computer.

NOTE

- The wireless mouse functions can operate computers compatible with IBM PS/2, serial (RS-232C) or Apple ADB type mouse systems.
- The wireless mouse or RS-232C function may not operate if your computer port is not correctly set up. Please refer to the operation manual of the computer for details on setting up/installing the correct mouse driver.



Connecting to the Computer Input Port

You can connect your projector to a computer for easy projection of full-color computer images.

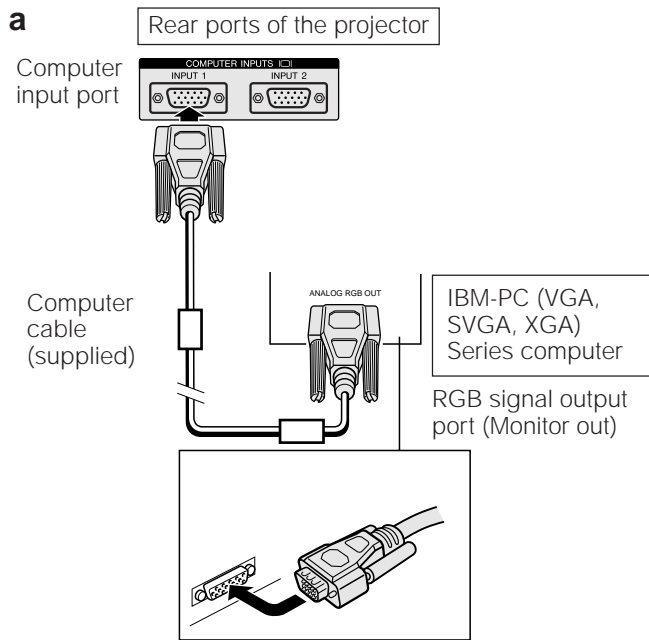

b.1 Macintosh adaptor (supplied)

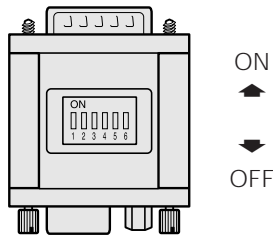

b.2 Macintosh adaptor (supplied)

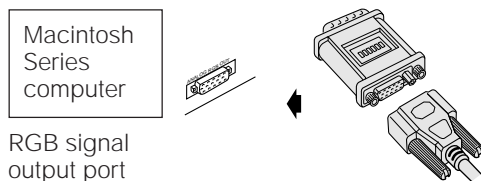

b.3 Rear ports of the projector

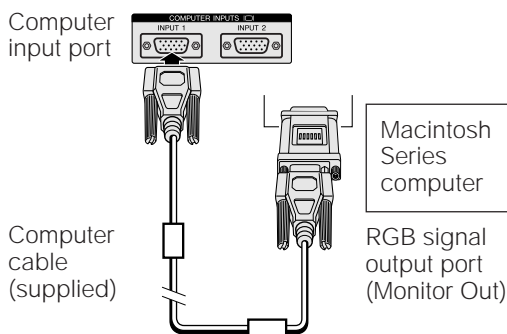

a. Connecting an IBM-PC (VGA, SVGA, XGA) Series computer

1,024 × 768 maximum resolution

Plug one end of the supplied computer cable into the COMPUTER INPUT port on the projector and the other end into the RGB signal output port (Monitor Out) on the computer, and secure the plugs by tightening the thumb screws.

NOTE

- This connection can be made only when using a computer with a VGA/SVGA/XGA or Mac display output port.

b. Connecting a Macintosh Series computer

640 × 480 or 832 × 624 resolution

- Set the proper switches on the supplied Macintosh adaptor.
 - For 640 × 480 resolution, set switches 1 and 2 to "ON" and 3, 4, 5 and 6 to "OFF".
 - For 832 × 624 resolution, set switches 2 and 4 to "ON" and 1, 3, 5 and 6 to "OFF".
- Connect the supplied Macintosh adaptor to the supplied computer cable and the RGB signal output port (Monitor Out) on your Macintosh Series computer, as shown on the left, and secure the plugs by tightening the thumb screws.
- Firmly plug the other end of the supplied computer cable into the COMPUTER INPUT port on the projector and secure the plugs by tightening the thumb screws.

NOTE

- Once the adaptor is connected to a computer and the computer is turned on, the display mode cannot be changed even if the switches on the adaptor are reset.
- The supplied Macintosh adaptor is only for use with H-SYNC and V-SYNC output. When connecting a Macintosh Series computer that only outputs C-SYNC, use a C-SYNC output adaptor (sold separately).

c. Connecting other compatible computers

When connecting the projector to a compatible computer other than an IBM-PC (VGA/SVGA/XGA) or Macintosh series, a separate cable may be needed. Please contact your dealer for more information.

NOTE

- Connecting computers other than the recommended types may result in damage to the projector, the computer, or both.



Connecting Video Equipment

You can connect your projector to a VCR, laser disk player or external audio components.

CAUTION

- Always turn off the projector while connecting to video equipment, in order to protect both the projector and the equipment being connected.

NOTE

- The S-VIDEO INPUT terminal uses a video signal system in which the picture is separated into a color and a luminance signal to realize a higher-quality image.
- By using external audio components, the volume can be amplified for greater sound.

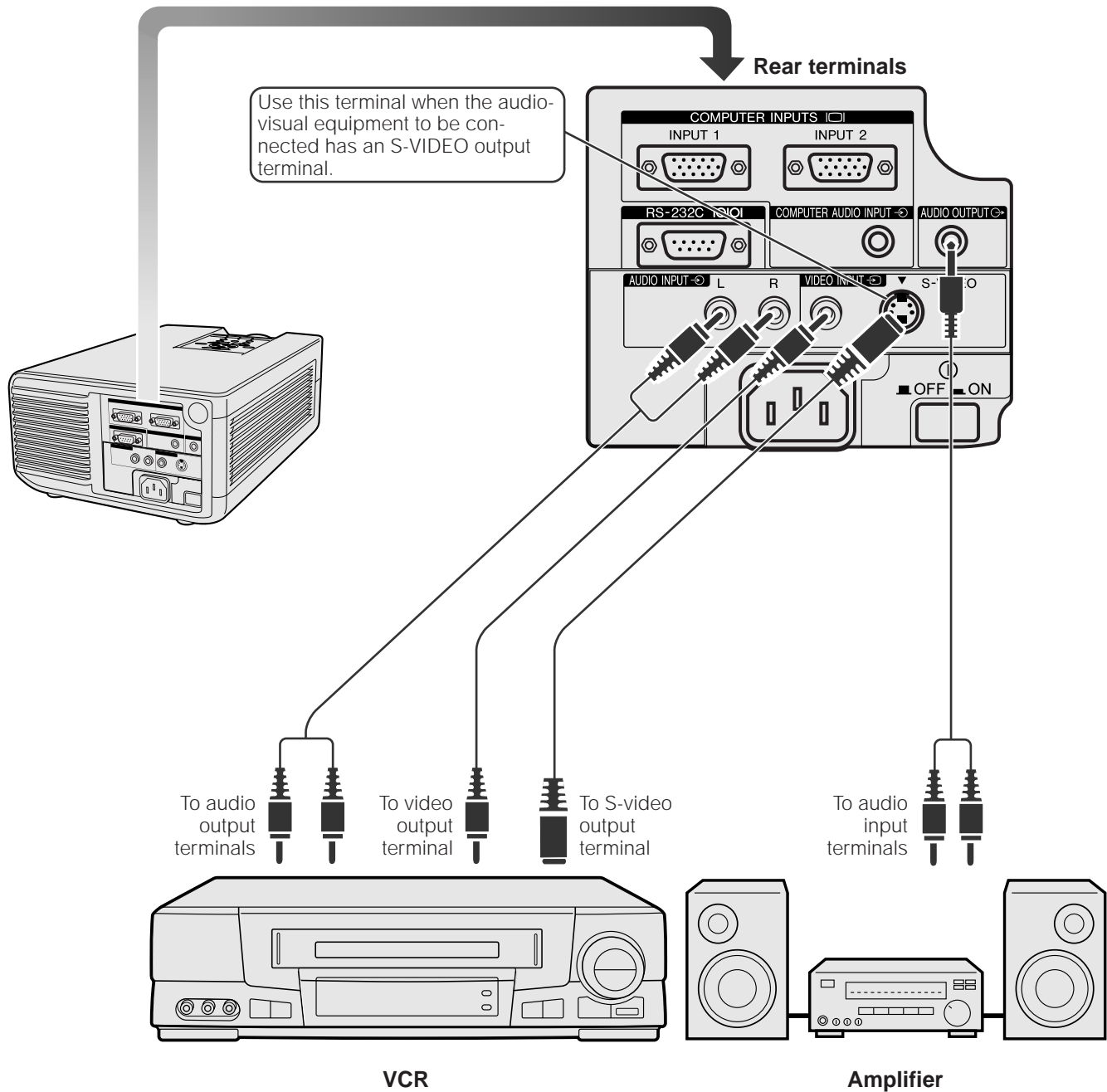



Air Filter Maintenance

- This projector is equipped with two air filters to ensure the optimal operating condition of the projector.
- The air filters should be cleaned every 100 hours of use. Clean the filters more often when the projector is used in a dusty or smoky location.
- Have your nearest Authorized Sharp Industrial LCD Products Dealer or Service Center exchange the filter (PFILD0076CEZZ) when it is no longer possible to clean it.

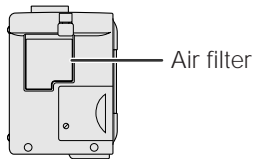

Bottom View

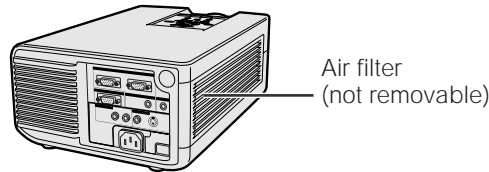

Side and Rear View

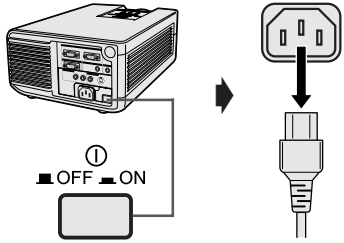
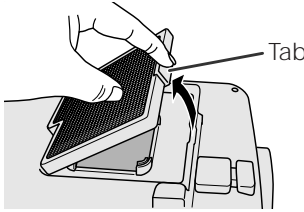
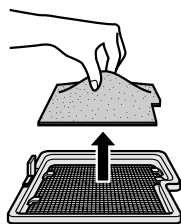

Cleaning and replacing the bottom air filter

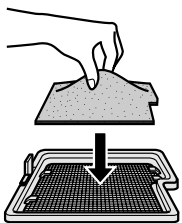
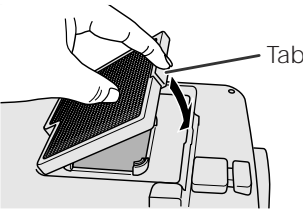
<p>1 Turn off the main power.</p> <p>Turn off the MAIN POWER switch. Then unplug the power cord.</p> 	<p>2 Remove the bottom filter cover.</p> <p>Turn over the projector. Press the tab and lift open the filter cover in the direction of the arrow.</p> 	<p>3 Remove the air filter.</p> <p>Grasp the air filter between your fingers and lift it out of the filter cover.</p> 
<p>4 Clean the air filter.</p> <p>Clean the dust off the air filter and cover with a vacuum cleaner extension hose.</p> 	<p>5 Replace the air filter.</p> <p>Place the air filter underneath the tabs on the filter frame.</p> 	<p>6 Replace the filter cover.</p> <p>Insert the tab on the end of the filter cover into the filter cover opening and press the filter cover into position.</p> 

NOTE

- Be sure the filter cover is securely installed. The power will not turn on unless it is correctly installed.

Cleaning the side air filter

If dust or dirt has collected inside the air filter, clean the filter with a vacuum cleaner extension hose.

NOTE

- The side air filter cannot be removed.



Lamp/Maintenance Indicators

Lamp

The lamp in this projector operates for approximately 2,000 cumulative hours, depending on the usage environment. When the lamp has been used for 1,900 hours, the LAMP REPLACEMENT indicator will light red and "LAMP" will flash in yellow on the screen. It is recommended that the lamp be replaced after 1,900 cumulative hours of use or when you notice a significant deterioration of the picture and color quality.

If the lamp has been used for 2,000 hours, the projector power will automatically turn off and the projector will enter standby mode. If you turn on the power after the lamp has been used for 2,000 hours, "LAMP" will flash in red on the screen and the power will turn off. See pages 30 and 31 for replacing the lamp. The lamp usage time can be checked with the On-screen Display (see page 19).

NOTE

- As the usage environment can vary significantly, the projector lamp may not operate for 2,000 hours.

CAUTION

- Intense light hazard. Do not attempt to look into the aperture and lens while the projector is operating.

Maintenance Indicators

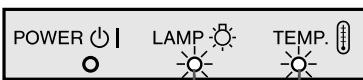

LAMP REPLACEMENT indicator

TEMPERATURE WARNING indicator

- The warning lights on the projector indicate problems inside the projector.
- There are two warning lights: a TEMPERATURE WARNING indicator which warns that the projector is too hot, and a LAMP REPLACEMENT indicator which lets you know when to change the lamp.
- If a problem occurs, either the TEMPERATURE WARNING indicator or the LAMP REPLACEMENT indicator will light up red, and the power will shut off. After turning off the power, follow the procedures given below.

Warning Indicator	Condition	Problem	Possible Solution
TEMPERATURE WARNING indicator	The internal temperature is abnormally high.	• Blocked air intake.	• Relocate the projector to an area with proper ventilation.
		• Clogged air filter.	• Clean the filter. (See page 28.)
		• Cooling fan breakdown. • Internal circuit failure.	• Take the projector to your nearest Authorized Sharp Industrial LCD Products Dealer or Service Center for repair.
LAMP REPLACEMENT indicator	The lamp does not light up.	• Burnt-out lamp. • Lamp circuit failure.	• Carefully replace the lamp. (See pages 30 and 31.) • Take the projector to your nearest Authorized Sharp Industrial LCD Products Dealer or Service Center for repair.
	The lamp requires replacement.	• Lamp has been used for over 1,900 hours.	

NOTE

- If the TEMPERATURE WARNING indicator lights up, follow the above possible solutions and then wait until the projector has cooled down completely before turning the power back on. (At least 5 minutes.)
- If the power is turned off and then turned on again, as during a brief rest, the LAMP REPLACEMENT indicator may be triggered, preventing the power from going on. Should this occur, take the power cord out of the wall outlet and put it back in again.



Replacing the Projection Lamp

The lamp in this projector operates for approximately 2,000 cumulative hours, depending on the usage environment. When the lamp has been used for 1,900 hours, the LAMP REPLACEMENT indicator will light red and "LAMP" will flash in yellow on the screen. It is recommended that the lamp be replaced after 1,900 cumulative hours of use or when you notice a significant deterioration of the picture and color quality. If the lamp has been used for 2,000 hours, the projector power will automatically turn off and the projector will enter standby mode. (Refer to "Lamp/Maintenance Indicators" on page 29.) The lamp usage time can be checked with the On-screen Display (see page 19).

If the new lamp does not light after replacement, take your projector to the nearest Authorized Sharp Industrial LCD Products Dealer or Service Center for repair. Purchase a replacement lamp unit (lamp/cage module) of the current type BQC-XGNV4SU/1 from your nearest Authorized Sharp Industrial LCD Products Dealer or Service Center. Then carefully change the lamp by following the instructions below. If you wish, you may have the lamp replaced at your nearest Authorized Sharp Industrial LCD Products Dealer or Service Center.

IMPORTANT NOTE TO U.S. CUSTOMERS:

The lamp included with this projector is backed by a 90-day parts and labor limited warranty. All service of this projector under warranty, including lamp replacement, must be obtained through an Authorized Sharp Industrial LCD Products Dealer or Service Center. For the name of the nearest Authorized Sharp Industrial LCD Products Dealer or Service Center, please call toll-free: 1-800-BE-SHARP (1-800-237-4277). **U.S.A. ONLY**

Removing and installing the lamp unit

CAUTION

- Do not remove the lamp cage directly after operation of the projector. The lamp may be extremely hot. Wait at least one hour after the power cord is disconnected to allow the surface of the lamp cage to fully cool before removing the lamp cage.
- Be sure to remove the lamp cage by the handle. Be sure not to touch the glass surface of the lamp cage or the inside of the projector.
- To avoid injury to yourself and damage to the lamp, be sure to carefully follow the steps below.
- Before or after replacing the lamp, be sure to clean the air filters. See page 28 for cleaning the air filters.

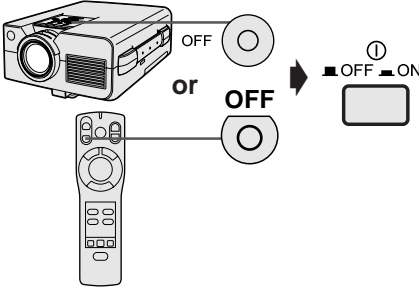
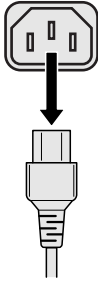
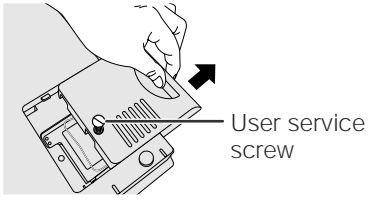
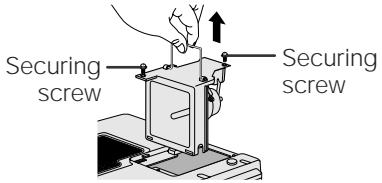
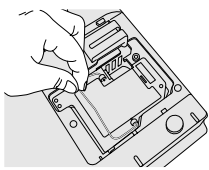
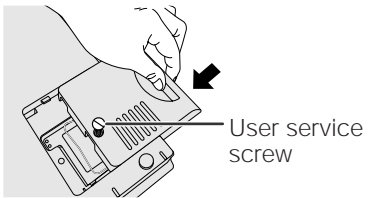
<p>1 Turn off the main power.</p> <p>Press POWER OFF. After the cooling fan stops, turn off the MAIN POWER switch.</p> 	<p>2 Disconnect the power cord.</p> <p>Unplug the power cord from the AC socket.</p> 	<p>3 Slide the lamp cage cover out.</p> <p>Turn over the projector and unfasten the user service screw that secures the lamp cage cover. Then slide the cover in the direction of the arrow.</p> 
<p>4 Remove the lamp cage.</p> <p>Remove the securing screws from the lamp cage. Hold the lamp cage by the handle and pull it towards you.</p> 	<p>5 Replace the lamp cage (after changing the lamp).</p> <p>Press the lamp cage firmly into the lamp cage compartment. Fasten the securing screws.</p> 	<p>6 Slide the lamp cage cover in.</p> <p>Slide the lamp cage cover in the direction of the arrow. Then fasten the user service screw.</p> 





Replacing the Projection Lamp

Resetting the lamp timer

NOTE

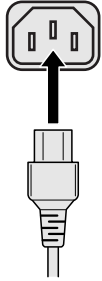
- Reset the lamp timer only after replacing the lamp.

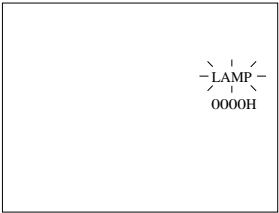
<p>1 Connect the power cord.</p> <p>Plug the power cord into the AC socket of the projector.</p> 	<p>2 Reset the lamp timer.</p> <p>While pressing ADJUSTMENT ▼, ► and ENTER on the projector, turn on the MAIN POWER switch.</p> 	<p>"LAMP 0000H" is displayed, indicating that the lamp timer is reset.</p> 
---	---	--



Using the Kensington Lock

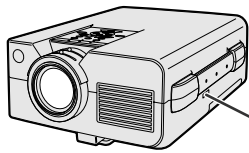

Kensington Security Standard connector

This projector has a Kensington Security Standard connector for use with a Kensington MicroSaver Security System. Refer to the information that came with the system for instructions on how to use it to secure the projector.



Troubleshooting

Problem	Check
No picture and no sound.	<ul style="list-style-type: none"> Projector power cord is not plugged into the wall outlet. MAIN POWER switch is not on. Input is wrong. (See pages 12 and 13.) Cables improperly connected to rear panel of the projector. (See pages 25, 26 and 27.) Remote control batteries have run down. (See page 7.) Main power of the remote control is not turned on. Remote control's MOUSE/ADJUSTMENT switch is set to MOUSE.
Sound is heard but no picture appears.	<ul style="list-style-type: none"> Cables improperly connected to rear panel of the projector. (See pages 25, 26 and 27.) PICTURE and BRIGHTNESS adjustments are set to minimum position. (See page 15.) On-screen Display ("BLACK SCREEN") is turned off and Black Screen function is turned on, creating a black image. (See page 20.)
Color is faded or poor.	<ul style="list-style-type: none"> COLOR and TINT adjustments are not correct. (See page 15.)
Picture is blurred.	<ul style="list-style-type: none"> Adjust the focus. (See page 11.) Projection distance is too long or too short to allow for proper focus. (See page 23.)
Picture appears but no sound is heard.	<ul style="list-style-type: none"> Cables improperly connected to rear panel of the projector. (See pages 25, 26 and 27.) Volume is set to minimum. (See page 13.)
An unusual sound is occasionally heard from the cabinet.	<ul style="list-style-type: none"> If the picture is normal, the sound is due to cabinet shrinkage caused by temperature changes. This will not affect operation or performance.
Maintenance indicator lights up.	<ul style="list-style-type: none"> Refer to "Lamp/Maintenance Indicators" on page 29.

Transporting the Projector

When transporting the projector, carry it by the carrying handle on the side of the projector. A soft-side carrying bag is also provided to transport the projector.

Using the Carrying Handle

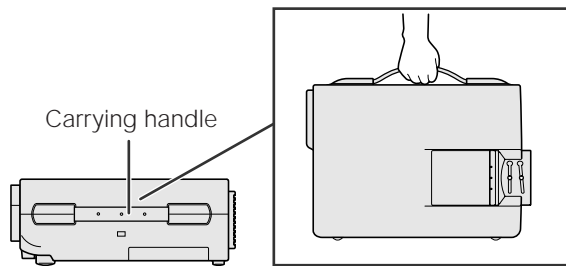

CAUTION

- Always put on the lens cap to prevent damage to the lens when transporting the projector.
- Do not lift or carry the projector by the lens or the lens cap as this may damage the lens.

Using the Carrying Bag

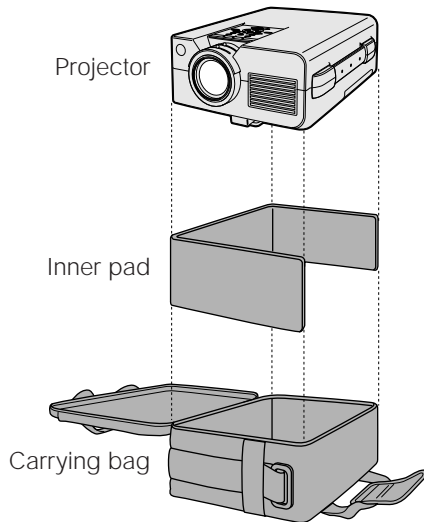

Before placing the projector into the carrying bag, set up the inner pad inside the bag as shown.

CAUTION

- The supplied carrying bag is made exclusively for the projector and its supplied accessories. Do not place other items into the carrying bag with the projector or use the bag to transport items other than the projector and its accessories.
- This bag is provided merely to transport the projector and its accessories, not to protect these products from damage as a result of rough handling. Do not expose these products to shocks or impact when transported in the carrying bag.
- Wait until the projector has sufficiently cooled before placing it into the carrying bag. If the projector is placed into the bag while it is still hot, the heat may damage the bag lining.

Attaching the shoulder strap to the carrying bag

1 Take the shoulder strap out.

The shoulder strap is stored in the pocket located in front of the carrying bag.

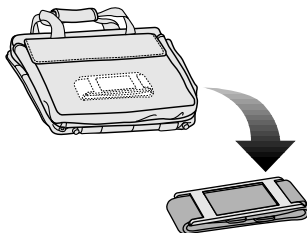

2 Fasten the shoulder strap to the carrying bag.

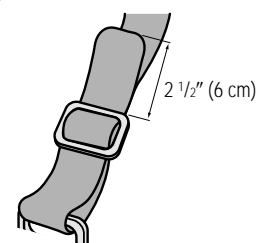
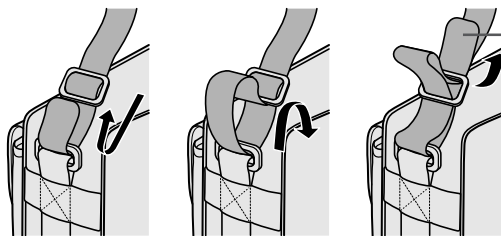

The strap should extend at least 2 1/2" (6 cm) from the buckle.

Follow the same procedure for the other end of the strap.



Connection Pin Assignments

Analog Computer 1 and 2 Signal Input

Ports: 15-pin mini D-sub female connector

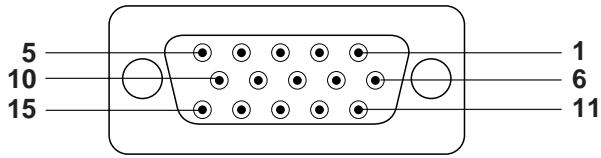

Computer Input

Analog

- | | |
|------------------------|----------------------------|
| 1. Video input (red) | 9. Not connected |
| 2. Video input (green) | 10. GND |
| 3. Video input (blue) | 11. GND |
| 4. Reserve input 1 | 12. Bi-directional data |
| 5. Composite sync | 13. Horizontal sync signal |
| 6. Earth (red) | 14. Vertical sync signal |
| 7. Earth (green) | 15. Data clock |
| 8. Earth (blue) | |

RS-232C Port: 9-pin D-sub male connector

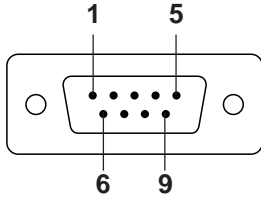

Pin No.	Signal	Name	I/O	Reference
1	CD			Not connected
2	RD	Receive Data	Input	Connected to internal circuit
3	SD	Send Data	Output	Connected to internal circuit
4	ER			Not connected
5	SG	Signal Ground		Connected to internal circuit
6	DR	Data Set Ready	Output	Not connected
7	RS	Request to Send	Output	Connected to internal circuit
8	CS			Not connected
9	CI			Not connected



RS-232C Port Specifications

PC control

A computer can be used to control the projector by connecting an RS-232C cable (cross type, sold separately) to the projector. (See page 25 for connection.)

Communication conditions

Set the serial port settings of the computer to match that of the table on the next page.

Signal format: Conforms to RS-232C standard.

Baud rate: 9,600 bps

Data length: 8 bits

Parity bit: NON

Stop bit: 1 bit

Flow control: None

Basic format

Commands from the computer are sent in the following order: command, parameter, and return code. After the projector processes the command from the computer, it sends a response code to the computer.

Command format

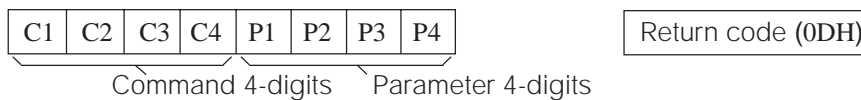

Response code format

Normal response



Problem response (communication error or incorrect command)



When more than one code is being sent, send each command only after the OK response code for the previous command from the projector is verified.

NOTE

- When using the computer control function of the projector, the projector operating status cannot be read to the computer. Therefore, confirm the status by transmitting the display commands for each adjustment menu and checking the status with the On-screen Display. If the projector receives a command other than a menu display command, it will execute the command without displaying the On-screen Display.



RS-232C Port Specifications

Commands

EXAMPLE

- When "BRIGHT" of RGB 1 IMAGE ADJUSTMENT is set to -10.

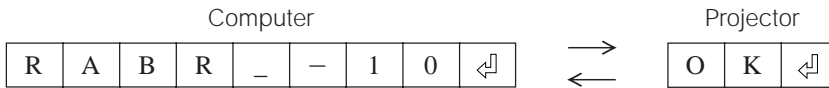

NOTE

- If a dash (_) appears in the parameter column, enter a space. If an asterisk (*) appears, enter a value in the range indicated in brackets under CONTROL CONTENTS.

CONTROL ITEM	COMMAND				PARAMETER				CONTROL CONTENTS
	C1	C2	C3	C4	P1	P2	P3	P4	
POWER SETTING	P	O	W	R	_	_	_	0	POWER OFF
	P	O	W	R	_	_	_	1	POWER ON
INPUT SWITCHING	I	V	E	D	_	_	_	1	VIDEO
	I	R	G	B	_	_	_	1	RGB 1
	I	R	G	B	_	_	_	2	RGB 2
INPUT CHECK	I	C	H	K	_	_	_	0	INPUT CHECK
LANGUAGE SELECTION	M	E	L	A	_	_	_	1	ENGLISH
	M	E	L	A	_	_	_	2	DEUTSCH
	M	E	L	A	_	_	_	3	ESPAÑOL
	M	E	L	A	_	_	_	4	NEDERLANDS
	M	E	L	A	_	_	_	5	FRANÇAIS
	M	E	L	A	_	_	_	6	ITALIANO
	M	E	L	A	_	_	_	7	SVENSKA
	M	E	L	A	_	_	_	8	JAPANESE
VIDEO SYSTEM SELECTION	M	E	S	Y	_	_	_	1	AUTO
	M	E	S	Y	_	_	_	2	PAL
	M	E	S	Y	_	_	_	3	SECAM
	M	E	S	Y	_	_	_	4	NTSC 4.43
	M	E	S	Y	_	_	_	5	NTSC 3.58
VIDEO IMAGE ADJUSTMENT	V	A	P	I	_	*	*	*	PICTURE (-30 - +30)
	V	A	B	R	_	*	*	*	BRIGHT (-30 - +30)
	V	A	C	O	_	*	*	*	COLOR (-30 - +30)
	V	A	T	I	_	*	*	*	TINT (-30 - +30)
	V	A	S	H	_	*	*	*	SHARPNESS (-30 - +30)
	V	A	R	E	_	_	_	0	VIDEO DISPLAY
	V	A	R	E	_	_	_	1	RESET
	V	A	R	E	_	_	_	1	RESET
VIDEO BACKGROUND LEVEL	W	B	R	D	_	*	*	*	RED (-30 - +30)
	W	B	B	E	_	*	*	*	BLUE (-30 - +30)
	W	B	R	E	_	_	_	1	RESET
VOLUME ADJUSTMENT	V	O	L	A	_	_	*	*	VOLUME (00 - 60)
	M	U	T	E	_	_	_	0	MUTE OFF
	M	U	T	E	_	_	_	1	MUTE ON
AUDIO ADJUSTMENT	A	A	T	E	_	*	*	*	TREBLE (-30 - +30)
	A	A	B	A	_	*	*	*	BASS (-30 - +30)
	A	A	R	E	_	_	_	0	AUDIO DISPLAY
	A	A	R	E	_	_	_	1	RESET

NOTE

- RGB INPUT ADJUSTMENT can only be set in the displayed computer mode.

CONTROL ITEM	COMMAND				PARAMETER				CONTROL CONTENTS
	C1	C2	C3	C4	P1	P2	P3	P4	
RGB 1 ADJUSTMENT	R	A	P	I	_	*	*	*	PICTURE (-30 - +30)
	R	A	B	R	_	*	*	*	BRIGHT (-30 - +30)
	R	A	R	D	_	*	*	*	RED (-30 - +30)
	R	A	B	E	_	*	*	*	BLUE (-30 - +30)
	R	A	R	E	_	_	_	0	RGB 1 DISPLAY
	R	A	R	E	_	_	_	1	RESET
RGB 2 ADJUSTMENT	R	B	P	I	_	*	*	*	PICTURE (-30 - +30)
	R	B	B	R	_	*	*	*	BRIGHT (-30 - +30)
	R	B	R	D	_	*	*	*	RED (-30 - +30)
	R	B	B	E	_	*	*	*	BLUE (-30 - +30)
	R	B	R	E	_	_	_	0	RGB 2 DISPLAY
	R	B	R	E	_	_	_	1	RESET
RGB INPUT AUTO SYNCHRONIZATION	A	A	D	J	_	_	_	0	AUTO SYNC OFF
	A	A	D	J	_	_	_	1	AUTO SYNC ON
	A	D	J	S	_	_	_	1	AUTO SYNC START
RGB INPUT ADJUSTMENT	I	N	C	L	_	*	*	*	CLOCK (-60 - +60)
	I	N	P	H	_	*	*	*	PHASE (-60 - +60)
	I	A	H	P	_	*	*	*	H-POS (-60 - +60)
	I	A	V	P	_	*	*	*	V-POS (-30 - +30)
	I	A	R	E	_	_	_	0	RGB INPUT DISPLAY
	I	A	R	E	_	_	_	1	RESET
SCREEN SETTING	I	M	B	E	_	_	_	0	BLUE SCREEN OFF
	I	M	B	E	_	_	_	1	BLUE SCREEN ON
	I	M	D	I	_	_	_	0	INPUT DISPLAY OFF
	I	M	D	I	_	_	_	1	INPUT DISPLAY ON
	I	M	R	E	_	_	_	0	REVERSE OFF
	I	M	R	E	_	_	_	1	REVERSE ON
	I	M	I	N	_	_	_	0	INVERT OFF
	I	M	I	N	_	_	_	1	INVERT ON
	I	M	A	S	_	_	_	0	AUTO SYNC DISPLAY OFF
	I	M	A	S	_	_	_	1	AUTO SYNC DISPLAY ON
	VIDEO CONFIRMATION	S	Y	S	E	_	_	_	0
BLACK SCREEN	I	M	B	K	_	_	_	0	BLACK SCREEN OFF
	I	M	B	K	_	_	_	1	BLACK SCREEN ON
	I	M	B	O	_	_	_	0	BLACK SCREEN DISPLAY OFF
	I	M	B	O	_	_	_	1	BLACK SCREEN DISPLAY ON
SCREEN MODE MEMORY	M	E	M	A	_	_	_	0	MEMORY RELEASE
	M	E	M	A	_	_	_	*	MEMORY SELECTION (1-7)



Input Signals (Recommended Timing)

The computer output signal timing of different types of computer signals are shown below for reference.

For IBM and compatibles

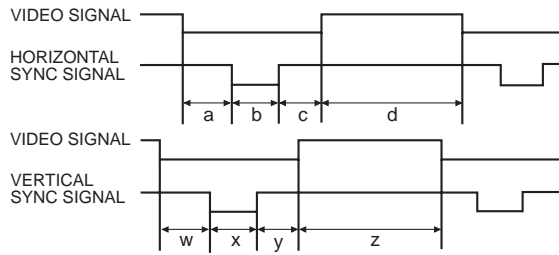

For Macintosh Series

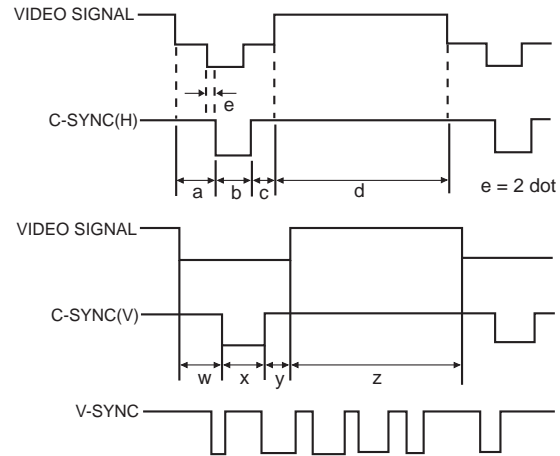

MODE		IBM					IBM	IBM	IBM	IBM	IBM	IBM	IBM	IBM	Apple	Apple	Apple		
		VGA					VESA	SVGA	SVGA	SVGA	SVGA	XGA	XGA	XGA	Macintosh™ IIsi	Macintosh™ LC	Macintosh™		
		Text		Graphic			Graphic	Graphic	VESA Guideline	VESA Standard	VESA Standard	VESA Guideline	VESA Standard	VESA Standard	VESA Standard	13" Monitor	13" Monitor	16" Monitor	
		720 dots		640 dots			640 dots	800 dots	800 dots	800 dots	800 dots	800 dots	1,024 dots	1,024 dots	1,024 dots	640 dots	640 dots	832 dots	
		350 lines	400 lines	350 lines	400 lines	480 lines	480 lines	600 lines	600 lines	600 lines	600 lines	600 lines	600 lines	768 lines	768 lines	768 lines	480 lines	480 lines	624 lines
VIDEO	LEVEL	0.7Vp-p 75Ω load					0.7Vp-p 75Ω load	0.7Vp-p 75Ω load	0.7Vp-p 75Ω load	0.7Vp-p 75Ω load	0.7Vp-p 75Ω load	0.7Vp-p 75Ω load	0.7Vp-p 75Ω load	0.7Vp-p 75Ω load	1Vp-p max. 75Ω load	0.7Vp-p max. 75Ω load	0.7Vp-p max. 75Ω load		
	TYPE	R • G • B					R • G • B	R • G • B	R • G • B	R • G • B	R • G • B	R • G • B	R • G • B	R • G • B	R • G • B C.SYNC	R • G • B C.SYNC	R • G • B C.SYNC		
H S Y N C	FRONT PORCH	a	dot	17		14		24	24	40	56	16	24	24	16	64	78	31	
	SYNC	b	dot	108		96		40	72	128	120	80	136	136	96	64	62	65	
	BACK PORCH	c	dot	55		50		128	128	88	64	160	160	144	176	96	116	224	
	VIDEO PERIOD	d	dot	720		640		640	800	800	800	800	1,024	1,024	1,024	640	640	832	
	1H (a+b+c+d)		dot	900		800		832	1,024	1,056	1,040	1,056	1,344	1,328	1,312	864	896	1,152	
			μs	31.7774		31.7776		26.413	28.444	26.400	20.800	21.333	20.677	17.707	16.660	28.5714	28.595	20.124	
	1 dot		ns	35.3082		39.7219		31.746	27.777	25.000	20.000	20.202	15.385	13.3	12.7	33.0688	31.914063	17.468	
	1/H		kHz	31.4689		31.4688		37.860	35.156	37.879	48.077	46.875	48.363	56.476	60.023	35.0000	34.971149	49.693	
1/dot		MHz	28.322		25.175		31.500	36.000	40.000	50.000	49.500	65.000	75.0	78.75	30.2400	31.334149	57.246		
V S Y N C	LEVEL		TTL	TTL	TTL		TTL	TTL	TTL	TTL	TTL	TTL	TTL	TTL	TTL	TTL	TTL	TTL	
	SYNC POLARITY	+/-	+	-	+	-	-	+/-	+	+	+	-	-	+	-	-	-	-	
FRONT PORCH	w	H	38	13	38	13	11	9	1	1	37	1	3	3	1	3	3	1	
SYNC	x	H	2	2	2	2	2	3	2	4	6	3	6	6	3	3	3	3	
BACK PORCH	y	H	59	34	59	34	32	28	22	23	23	21	29	29	28	39	39	39	
VIDEO PERIOD	z	H	350	400	350	400	480	480	600	600	600	600	768	768	768	480	480	624	
1V (w+x+y+z)		H	449	449	449	449	525	520	625	628	666	625	806	806	800	525	525	667	
		ms	14.2681	14.2681	14.2681	14.2681	16.6832	13.735	17.778	16.579	13.853	13.333	16.666	14.272	13.328	15.00	15.00	13.423	
1/v		Hz	70.0866	70.0866	70.0863	70.0863	59.9405	72.809	56.250	60.317	72.188	75.000	60.006	70.069	75.029	66.67	66.67	74.502	
LEVEL			TTL	TTL	TTL	TTL	TTL	TTL	TTL	TTL	TTL	TTL	TTL	TTL	TTL	TTL	TTL	TTL	
SYNC POLARITY	+/-		-	+	-	+	-	-	+/-	+	+	+	-	-	+	-	-	-	

NOTE

- Due to the native pixel resolution of the LCD panels (804 × 604), this projector will not display Mac 832 × 624 resolution images full screen.
- When connecting a notebook computer to the projector for display on an (800 × 600) LCD screen, the screen may not show a full picture image. See page 17, "Computer Mode Memory Adjustments" for details.
- This projector may not be able to display images from notebook computers in simultaneous (CRT/LCD) mode. Should this occur, turn off the LCD display on the notebook computer and output the display data in "CRT only" mode. Details on how to change display modes can be found in your notebook computer's operation manual.



Specifications

Product type	LCD Projector
Model	XG-NV4SU
Video system	PAL/SECAM/NTSC 3.58/NTSC 4.43
Display method	LCD panel × 3, RGB optical shutter method
LCD panel	Panel size: 0.9" (13.9 [H] × 18.5 [W] mm) Display method: Translucent TN liquid crystal panel
Lens	Drive method: TFT (Thin Film Transistor) Active Matrix panel No. of dots: 485,616 dots (804 [H] × 604 [V])
Projection lamp	1-1.5× zoom lens, F2.0-2.6, f = 37-55.5 mm
Brightness (ANSI lumen)	AC 150 W lamp
Contrast ratio	600 ANSI lumens
Video input signal	200:1
S-video input signal	RCA Connector: VIDEO, composite video, 1.0 Vp-p, sync negative, 75 Ω terminated RCA Connector: AUDIO, 0.5 Vrms more than 22 kΩ (stereo)
Horizontal resolution	4-pin mini DIN connector
Audio output	Y (luminance signal): 1.0 Vp-p, sync negative, 75 Ω terminated C (chrominance signal): Burst 0.286 Vp-p, 75 Ω terminated
Computer RGB input signal	580 TV lines (video input) 2 W (monaural) <i>Video signal</i> 15-PIN MINI D-SUB CONNECTOR (Computer Input Port 1, 2): RGB separate type analog input: 0-0.7 Vp-p, positive, 75 Ω terminated STEREO MINIJACK: AUDIO, 0.5 Vrms, more than 22 kΩ (stereo) HORIZONTAL SYNC. SIGNAL: TTL level (positive/negative) or composite sync (Apple only) VERTICAL SYNC. SIGNAL: Same as above
Computer input signal	9-pin D-sub male connector (RS-232C Input Port)
Speaker system	3 3/32" (8 cm) round
Rated voltage	AC 110-120/220-240 V
Input current	1.8 A/1.0 A
Rated frequency	50/60 Hz
Power consumption	250 W
Operating temperature	41°F to 104°F (+5°C to +40°C)
Storage temperature	-4°F to 140°F (-20°C to +60°C)
Cabinet	Plastic
I/R Carrier frequency	40 kHz
Laser Pointer of Remote Control	<i>Wave length</i> 670 nm <i>Max. output</i> 1 mW Class II Laser Product
Dimensions (approx.)	9 1/64" (W) × 4 49/64" (H) × 12 13/64" (D) (229 × 121 × 310 mm) (main body only) 9 19/32" (W) × 5 3/64" (H) × 13 17/64" (D) (243.5 × 128 × 337 mm) (including an adjuster leg and projecting parts)
Weight (approx.)	9.9 lbs. (4.5 kg)
Supplied accessories	Remote control, Four AA batteries, Computer cable (9' 10", 3 m), Macintosh adaptor, Remote mouse receiver, Mouse control serial cable (3' 3", 1 m), Mouse control cable for IBM PS/2 (3' 3", 1 m), Mouse control cable for Mac (6 45/64", 17 cm), Computer audio cable (9' 10", 3 m), Extra air filter, Lens cap (attached), Power cord (9' 10", 3 m), Carrying bag
Replacement parts	Lamp unit (Lamp/cage module) (BQC-XGNV4SU/1), Remote control (RRMCG1462CESA), Computer cable (QCNW-5108CEZZ), Macintosh adaptor (QPLGJ1512CEZZ), Remote mouse receiver (RUNTK0632CEZZ), Mouse control serial cable (QCNW-5112CEZZ), Mouse control cable for IBM PS/2 (QCNW-5113CEZZ), Mouse control cable for Mac (QCNW-5114CEZZ), Computer audio cable (QCNW-4870CEZZ), Air filter (PFILD0076CEZZ), Lens cap (GCOVH1307CESA), Power cord (QACCU5013CEZZ), Carrying bag (GCASN0001CESA)

This SHARP projector uses LCD (Liquid Crystal Display) panels. These very sophisticated panels contain 485,616 pixels (× RGB) TFTs (Thin Film Transistors).

As with any high technology electronic equipment such as large screen TVs, video systems and video cameras, there are certain acceptable tolerances that the equipment must conform to. This unit has some inactive TFTs within acceptable tolerances which may result in illuminated or inactive dots on the picture screen.

This will not affect the picture quality or the life expectancy of the unit.

If you have any questions about this matter, please call toll free 1-800-BE-SHARP (1-800-237-4277). U.S.A. ONLY

Specifications are subject to change without notice.



Dimensions

Rear View

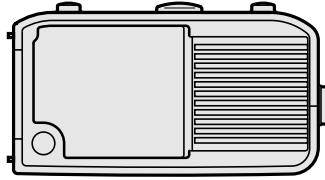

Top View

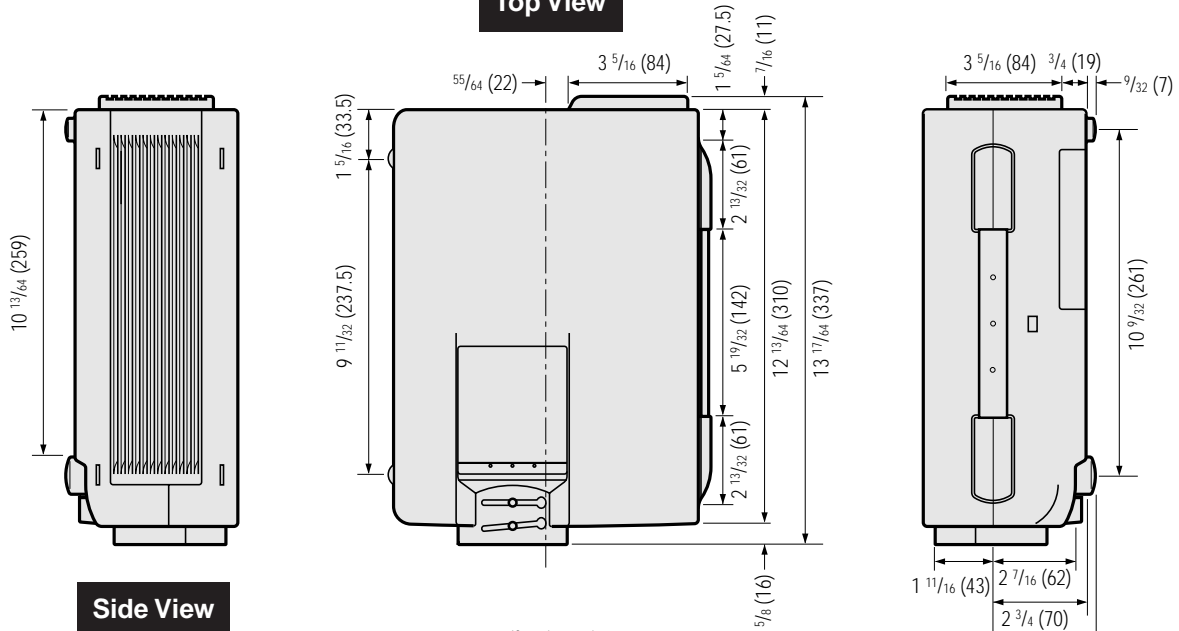

Side View

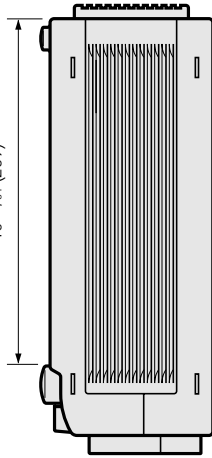

Front View

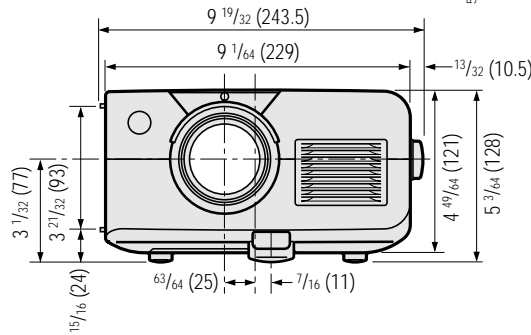

Bottom View

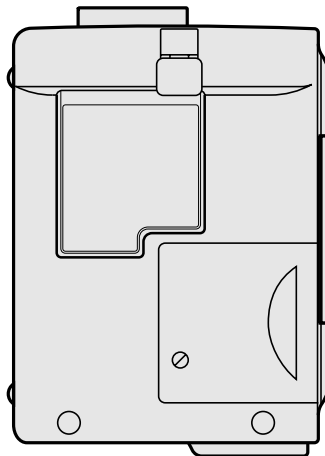



Notes

SHARP CORPORATION

OSAKA, JAPAN

Printed in Japan
Imprimé au Japon
Impreso en Japón
TINS-6505CEN1
T1970-A
8P09-JWG

Free Manuals Download Website

<http://myh66.com>

<http://usermanuals.us>

<http://www.somanuals.com>

<http://www.4manuals.cc>

<http://www.manual-lib.com>

<http://www.404manual.com>

<http://www.luxmanual.com>

<http://aubethermostatmanual.com>

Golf course search by state

<http://golfingnear.com>

Email search by domain

<http://emailbydomain.com>

Auto manuals search

<http://auto.somanuals.com>

TV manuals search

<http://tv.somanuals.com>