

SHARP®

ENGLISH

MODEL

CD-SW440N

MINI COMPONENT SYSTEM

OPERATION MANUAL

CD-SW440N Mini Component System consisting of CD-SW440N (main unit), CP-S440N (speaker system) and CP-SW440N (subwoofer).

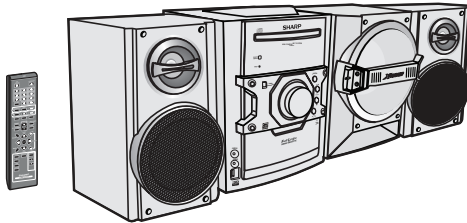

ENERGY STAR® Program Information



Products that have earned the ENERGY STAR® are designed to protect the environment through superior energy efficiency.

ENERGY STAR® is a U.S. registered mark.



iPod is a trademark of Apple Inc., registered in the U.S. and other countries.

CD-R/RW
Playable

MP3

COMPACT
DISC
DIGITAL AUDIO

USB
PLAYBACK



Accessories

Please confirm that only the following accessories are included.

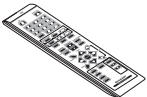
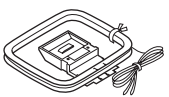
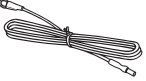
 Remote control x 1 RRMCGA205AWSA	 AM loop antenna x 1 QANTLA004AWZZ	 FM antenna x 1 92LFANT1535A
--	---	---

Special Note

Supply of this product does not convey a license nor imply any right to distribute content created with this product in revenue-generating broadcast systems (terrestrial, satellite, cable and/or other distribution channels), revenue-generating streaming applications (via Internet, intranets and/or other networks), other revenue-generating content distribution systems (pay-audio or audio-on-demand applications and the like) or on revenue-generating physical media (compact discs, digital versatile discs, semiconductor chips, hard drives, memory cards and the like). An independent license for such use is required. For details, please visit <http://mp3licensing.com>

MPEG Layer-3 audio coding technology licensed from Fraunhofer IIS and Thomson.

"Made for iPod" means that an electronic accessory has been designed to connect specifically to iPod and has been certified by the developer to meet Apple performance standards.

Apple is not responsible for the operation of this device or its compliance with safety and regulatory standards.



TINSZA625AWZZ

SHARP CORPORATION

Printed in Malaysia

10B R MW ①

Download from www.Somanuals.com. All Manuals Search And Download.

CONSUMER LIMITED WARRANTY

SHARP ELECTRONICS CORPORATION warrants to the first consumer purchaser that this Sharp brand product (the "Product"), when ship in its original container, will be free from defective workmanship and materials, and agrees that it will, at its option, either repair the defect or replace the defective Product or part thereof with a new or remanufactured equivalent at no charge to the purchaser for parts or labor for the period(s) set forth below.

This warranty does not apply to any appearance items of the Product nor to the additional excluded item(s) set forth below nor to any Product the exterior of which has been damaged or defaced, which has been subjected to improper voltage or other misuse, abnormal service or handling, or which has been altered or modified in design or construction.

In order to enforce the rights under this limited warranty, the purchaser should follow the steps set forth below and provide proof of purchase to the servicer.

The limited warranty described herein is in addition to whatever implied warranties may be granted to purchasers by law. ALL IMPLIED WARRANTIES INCLUDING THE WARRANTIES OF MERCHANTABILITY AND FITNESS FOR USE ARE LIMITED TO THE PERIOD(S) FROM THE DATE OF PURCHASE SET FORTH BELOW. Some states do not allow limitations on how long an implied warranty lasts, so the above limitation may not apply to you.

Neither the sales personnel of the seller nor any other person is authorized to make any warranties other than those described herein, or to extend the duration of any warranties beyond the time period described herein on behalf of Sharp.

The warranties described herein shall be the sole and exclusive warranties granted by Sharp and shall be the sole and exclusive remedy available to the purchaser. Correction of defects, in the manner and for the period of time described herein, shall constitute complete fulfillment of all liabilities and responsibilities of Sharp to the purchaser with respect to the Product, and shall constitute full satisfaction of all claims, whether based on contract, negligence, strict liability or otherwise. In no event shall Sharp be liable, or in any way responsible, for any damages or defects in the Product which were caused by repairs or attempted repairs performed by anyone other than an authorized servicer. Nor shall Sharp be liable or in any way responsible for any incidental or consequential economic or property damage. Some states do not allow the exclusion of incidental or consequential damages, so the above exclusion may not apply to you.

THIS WARRANTY GIVES YOU SPECIFIC LEGAL RIGHTS. YOU MAY ALSO HAVE OTHER RIGHTS WHICH VARY FROM STATE TO STATE.

Model Specific Section

Your Product Model Number & Description:

CD-SW440N Mini Component System

(Be sure to have this information available when you need service for your Product.)

Warranty Period for this Product:

One (1) year parts and labor from the date of purchase.

Additional Item(s) Excluded from Warranty Coverage (if any):

Non-functional accessories, supplies, and consumable items.

Where to Obtain Service:

At a Sharp Authorized Servicer located in the United States. To find a location of the nearest Sharp Authorized Servicer, call Sharp toll free at 1-800-BE-SHARP.

What to do to Obtain Service:

Ship prepaid or carry in your Product to a Sharp Authorized Servicer. Be sure to have **Proof of Purchase** available. If you ship the Product, be sure it is insured and packaged securely.

TO OBTAIN SUPPLY, ACCESSORY OR PRODUCT INFORMATION, CALL **1-800-BE-SHARP**

SHARP ELECTRONICS CORPORATION

Sharp Plaza, Mahwah, New Jersey 07495-1163

System connections

■ Precautions

- Please ensure that the equipment is positioned in a well ventilated area and ensure that there is at least 4" (10 cm) of free space along the sides, top and back of the equipment.

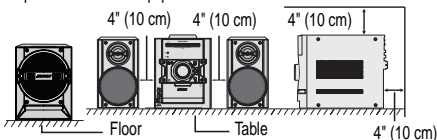

- Do not place subwoofer system on the same surface as main unit to prevent sound interruption during playback.

■ Speaker light-up connection

Connect the speaker light-up wires to the SPEAKERS LIGHT-UP sockets for speaker illumination. To turn off the speaker light-up feature, press the CLEAR/DIMMER button on the remote control for 2 seconds or more.

■ Speaker connection

- Connect the black wire to the minus (-) terminal, and the red wire to the plus (+) terminal.
- Do not make a mistake when connecting the right and left speakers. The right speaker is the one on the right side when you face the unit.
- Do not let the bare speaker wires touch each other.
- Do not allow any objects to fall into or to be placed in the bass reflex ducts.
- Do not stand or sit on the speakers. You may be injured.
- Never mistake the FRONT SPEAKERS and the SUBWOOFER terminals. The unit or the speakers may be damaged.
- If you use other speakers with an impedance lower than that specified, the unit may be damaged.
Front speakers: 4 ohms, Subwoofer: 8 ohms.



System connections (continued)

Make sure to unplug the AC power cord before making any connections.

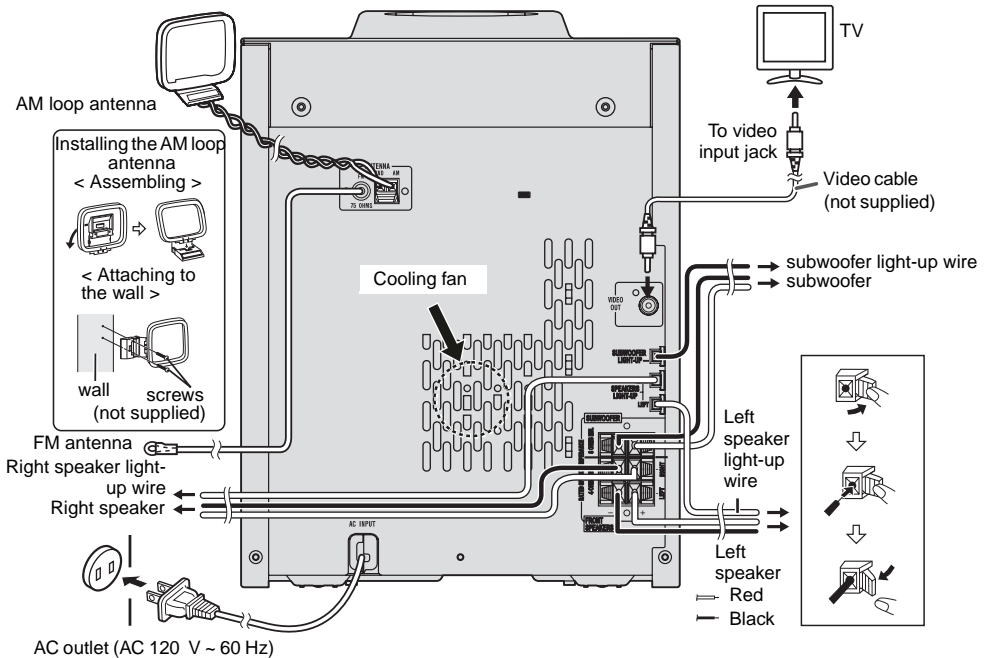

Cooling fan :

The main unit is built with a cooling fan at the rear of the unit for improved cooling. Please do not cover the opening of the fan with any obstacles, as this will block proper ventilation.

Remote control

Battery installation

Use 2 "AAA" size batteries (UM/SUM-4, R3, HP-16 or similar). Batteries are not included.

- 1 Open the battery cover.
- 2 Insert the batteries according to the direction indicated in the battery compartment.
When inserting or removing the batteries, push them toward the (-) battery terminals.
- 3 Close the cover.

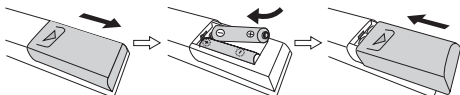

Caution:

- Replace all old batteries with new ones at the same time.
- Do not mix old and new batteries.
- Remove the batteries if the unit will not be used for a long period of time. This will prevent potential damage due to battery leakage.
- Do not use rechargeable batteries (nickel-cadmium battery, etc.).
- Installing the batteries incorrectly may cause the unit to malfunction.
- Batteries (battery pack or batteries installed) shall not be exposed to excessive heat such as sunshine, fire or the like.

Notes concerning use:

- Replace the batteries if the operating distance is reduced or if the operation becomes erratic. Purchase 2 "AAA" size batteries (UM/SUM-4, R3, HP-16 or similar).
- Periodically clean the transmitter on the remote control and the sensor on the unit with a soft cloth.
- Exposing the sensor on the unit to strong light may interfere with operation. Change the lighting or the direction of the unit if this occurs.
- Keep the remote control away from moisture, heat, shock and vibrations.

General control

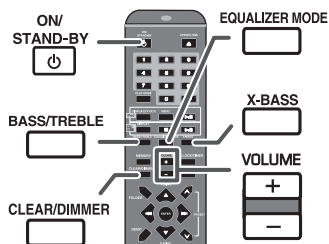
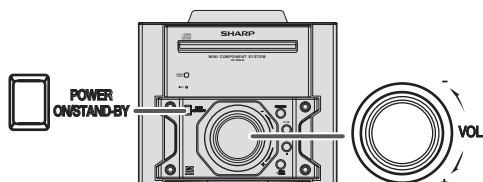

To turn the power on

The first time the unit is plugged in, the unit will enter the demonstration mode. You will see words scroll and the subwoofer and front speaker will light up in flashing mode.

- 1 Press the DEMO button to cancel the demonstration mode. The subwoofer and front speaker light up will be off.
- 2 Press the ON/STAND-BY button to turn the power on.

Function	Main unit	Remote control	Operation
Power on / off			Press to turn the power on or to go to stand-by mode.
Demo on / off	—		Press to enter to demonstration on or off mode.

Display brightness control

To dim the display brightness, hold down the CLEAR/DIMMER button on the remote control for 2 seconds or more.

Volume auto fade-in

If you turn off and on the main unit with the volume set to 27 or higher, the volume starts at 16 and fades in to the last set level.

Subwoofer and front speaker light up control

The subwoofer and front speaker will light up according to the level of the music source played back. To turn on/off the light, hold down the CLEAR/DIMMER button on the remote control for 2 seconds or more.

Volume control

Turn the volume knob toward VOL +/- (on main unit) or press VOLUME +/- (on remote control) to increase or decrease the volume.

X-Bass control

When the power is first turned on, the unit will enter the extra bass mode which emphasizes the bass frequencies, and "X-BASS" will appear. To cancel the extra bass mode, press the X-BASS button on the remote control.

Bass control

- 1 Press the BASS/TREBLE button to select "BASS".
- 2 Within 5 seconds, press the VOLUME (+ or -) button to adjust the bass.

Treble control

- 1 Press the BASS/TREBLE button to select "TREBLE".
- 2 Within 5 seconds, press the VOLUME (+ or -) button to adjust the treble.

Equalizer

When the EQUALIZER MODE button is pressed, the current mode setting will be displayed. To change to a different mode, press the EQUALIZER MODE button repeatedly until the desired sound mode appears.

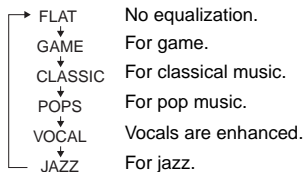

Auto power on function

When you press any of these buttons during stand-by mode, the unit turns on.

- ►/|| button on the main unit : The unit turns on and playback of the last function will start (iPod, CD, TUNER, USB, TAPE, AUDIO IN).
- iPod button on the remote control : The unit turns on and iPod function is activated.
- CD button on the remote control : The unit turns on and CD function is activated.
- TUNER button on the remote control : The unit turns on and TUNER function is activated.
- USB button on the remote control : The unit turns on and USB function is activated.
- TAPE button on the remote control : The unit turns on and TAPE function is activated.
- AUDIO IN button on the remote control : The unit turns on and AUDIO IN function is activated.

Auto power off function

In the stop mode of disc, USB or tape operation, the main unit enters the stand-by mode after 15 minutes of inactivity.

Listening to the iPod

Supported iPod models:

- iPod nano (software 1.2 above)
- iPod mini (software 1.2 above)
- iPod (5th generation) (software 1.3 above) (Dock connector equipped Click Wheel model)
- iPod (4th generation) (software 3.0.2 above) (Dock connector equipped Click Wheel model)
- iPod nano (2nd generation) (software 1.0.0 above)
- iPod nano (3rd generation) (software 1.0.3 above)
- iPod nano (4th generation) (software 1.0.3 above)
- iPod classic (software 1.0.3 above)
- iPod touch (software 1.1 above)
- iPod touch (2nd generation) (software 2.1 above)

Caution:

Please update your iPod unit to the latest software version from Apple's homepage before using it.

■ iPod adaptor connection

Notes:

- iPhone is not supported by this system.
- You can use an audio cable to connect your iPod to the AUDIO IN jack if:
 1. your iPod adaptor does not fit into the iPod dock on the main unit.
 2. you have an iPod that does not have an iPod adaptor.
 3. you have an iPod that does not have an iPod 30 pin connector.

■ To insert iPod adaptor

- 1 Press the ON/STAND-BY button to turn the power on.
- 2 Insert the iPod adaptor into the iPod dock and connect your iPod.

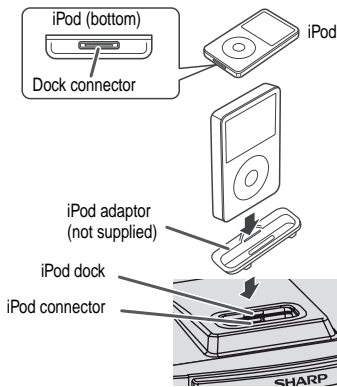

■ iPod playback

- 1 Press the ON/STAND-BY button to turn the power on.
- 2 Press the iPod button on the remote control or FUNCTION button repeatedly on the main unit to select iPod function.
- 3 Insert iPod unit in iPod dock of main unit.
- 4 Press the ►/|| button to start playback.

Notes:

- Once the iPod is connected to the unit it will begin charging.
- The iPod unit cannot be charged while the main unit is in the stand-by mode or during USB mode.
- Please make sure to set iPod unit to either NTSC or PAL to match your TV signal. Please visit Apple's homepage for further information.

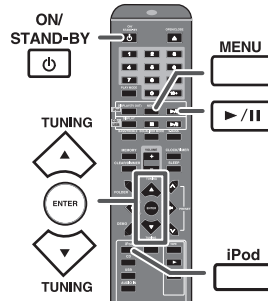
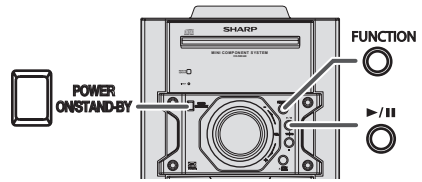

■ To remove iPod adaptor

Insert the tip of a screwdriver ("—" type, small) into the iPod adaptor hole as shown and lift upward to remove.

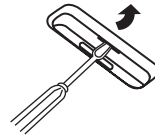

■ To disconnect iPod

Simply remove the iPod from the iPod dock. It is safe to do so even during playback.

■ Navigating the iPod menus

- 1 Press the MENU button to view the menu on iPod unit. Press it again to go back to previous menu.
- 2 Use the TUNING (▼ or ▲) button on the remote control to select an item on the menu and then press ENTER button.

Note:

When navigating the iPod menus with remote control, do not operate any of the buttons on the iPod unit. The volume level is adjusted by pressing the VOL (+ or -) button on the main unit or the remote control. Adjusting the volume on the iPod unit gives no effect.

iPod operation:

The operations described below depend on the generation iPod you are using.

System on operation:

When the main unit is powered on, the iPod unit will automatically power on when docked in the unit (including TIMER function/exclude USB function).

System off (stand-by operation):

When the main unit is turned to stand-by mode, the docked iPod unit will automatically turn to stand-by mode.

Listening to the iPod (continued)

Listening to a CD or MP3/WMA disc

■ Watching videos on a TV connected to iPod

- 1 Press the DISPLAY (TV OUT) button for more than 2 seconds. "TV DISP" will appear on display.
- 2 Press the ENTER button to start playback.

Notes:

- If the TV Out setting is already turned on at video menu, the video is automatically displayed on the TV screen when ENTER key is pressed.
- To return to watching video on iPod screen, press the MENU button to enter video menu. Then press the DISPLAY (TV OUT) button for more than 2 seconds until "iPodDISP" appears.
- During iPod video playback, pressing the DISPLAY (TV OUT) button will not toggle video out display between iPod and TV.

iPod playback detection function:

Once the play button on the iPod unit is pressed, the main unit will automatically change to iPod function overriding the previous function selected.

Caution:

- Unplug all accessories for the iPod before inserting it into the iPod dock.
- Stop button (■) at main unit is invalid during iPod function.

■ Various iPod functions

Function	Main unit	Remote control	Operation
Play			Press in the pause mode.
Pause			Press in the playback mode.
Track up/down	—		Press in the playback or pause mode. If you press the button in the pause mode, press the button to start the desired track.
Fast forward/reverse	—		Press and hold down in the playback mode. Release the button to resume playback.
Display	—	DISPLAY(TV OUT) 	iPod back light ON. Press for more than 2 seconds to toggle the video out display between iPod or TV.
Repeat	—	PLAY MODE 	Press to toggle repeat mode.
Shuffle	—	PLAY MODE 	Press and hold down to toggle shuffle mode.
iPod Menu	—	MENU 	Press to view the iPod menu during iPod function.
iPod Enter	—	ENTER 	Press to confirm the selection.
iPod Cursor Up/Down	—	TUNING 	Press to select the iPod menu.

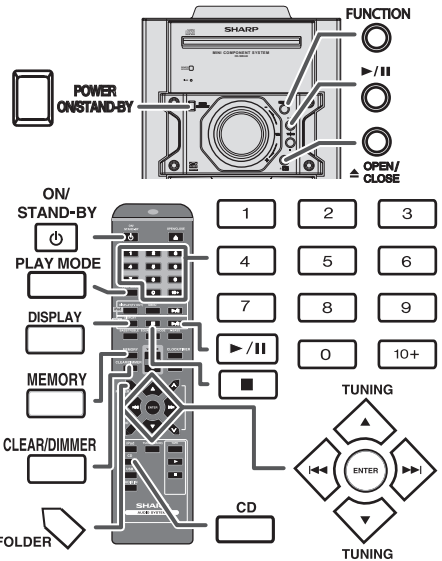

■ Disc playback

- 1 Press the ON/STAND-BY button to turn the power on.
- 2 Press the CD button on the remote control or FUNCTION button repeatedly on the main unit to select CD function.
- 3 Press the OPEN/CLOSE button to open the disc tray.
- 4 Place the disc on the disc tray, label side up.
- 5 Press the OPEN/CLOSE button to close the disc tray.
- 6 Press the (CD) button to start playback. After the last track is played, the unit will stop automatically.

Notes for CD or MP3/WMA disc:

- When the end of the last track is reached during fast forward, "END" will appear on the display and CD operation will be paused. When the beginning of the first track is reached during fast reverse, the unit will enter the playback mode (only for CD).
- Rewritable multi-session discs with unfinished writing, can still be played.

■ Various disc functions

Function	Main unit	Remote control	Operation
Pause			Press in the playback mode. Press the button to resume playback from the paused point.
Track up/down	—		Press in the playback or stop mode. If you press the button in the stop mode, press the button to start the desired track.
Fast forward/reverse	—		Press and hold down in the playback mode. Release the button to resume playback.

Listening to a CD or MP3/WMA disc (continued)

Direct track search

By using the Direct Search buttons, the desired tracks on the current disc can be played.

Use the Direct Search buttons on the remote control to select the desired track while playing the selected disc.

- The Direct Search buttons allow you to select up to number 9.
- When selecting number 10 or higher, use the "10+" button.

A. For example, to choose 13

- 1 Press the "10+" button once.
- 2 Press the "1" button.
- 3 Press the "3" button.

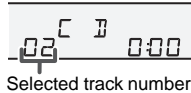

B. For example, to choose 130

- 1 Press the "10+" button twice.
- 2 Press the "1" button.
- 3 Press the "3" button.
- 4 Press the "0" button.

Notes:

- A track number higher than the number of tracks on the disc cannot be selected.
- During random play, direct search is not possible.

To stop playback:

Press the ■ (CD ■) button.

Repeat play

Repeat play can play one track, all tracks or a programmed sequence continuously.

To repeat one track:

Press the PLAY MODE button repeatedly until "1-REPEAT" appears. Press the ►/|| (CD ►/||) button.

To repeat all tracks:

Press the PLAY MODE button repeatedly until "ALL REPEAT" appears. Press the ►/|| (CD ►/||) button.

To repeat desired tracks:

Perform steps 1 - 5 in "Programmed play" section on pages 6 - 7 and then press the PLAY MODE button repeatedly until "ALL REPEAT" appears.

To cancel repeat play:

Press the PLAY MODE button repeatedly until "NORMAL" appears and "↵" disappears.



Random play

The tracks on the disc can be played in random order automatically.

To random play all tracks:

Press and hold down PLAY MODE button on the remote control until "RANDOM" appears. Press the ►/|| (CD ►/||) button.

To cancel random play:

Press and hold the PLAY MODE button until "NORMAL" appears and "R" disappears.

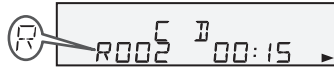

Notes:

- If you press the ►► button during random play, you can move to the track selected next by the random operation. On the other hand, the button does not allow you to move to the previous track. The beginning of the track being played will be located.
- In random play, the unit will select and play tracks automatically. (You cannot select the order of the tracks.)

Caution:

After performing repeat play, be sure to press the ■ (CD ■) button. Otherwise, the disc will play continuously.

Programmed play (CD)

- 1 While in the stop mode, press the MEMORY button on the remote control to enter the programing save mode.



- 2 Press the ◀◀ or ▶▶ buttons on the remote control to select the desired track.

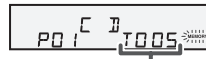

Selected track number

- 3 Press the MEMORY button to save the track number.



- 4 Repeat steps 2 - 3 for other tracks. Up to 32 tracks can be programmed. If you want to check the programmed tracks, press the MEMORY button repeatedly. If you make a mistake, the programmed tracks can be cleared by pressing the CLEAR/DIMMER button.

- 5 Press the ►/|| (CD ►/||) button to start playback.

Listening to a CD or MP3/WMA disc (continued)

Programmed play (MP3/WMA)

- 1 While in the stop mode, press the MEMORY button to enter the programming save mode.



- 2 Press the TUNING (▼ or ▲) button on the remote control to select the desired folder.



Then press the ◀◀ or ▶▶ button on the remote control to select the desired tracks.

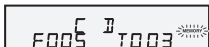

- 3 Press the MEMORY button to save the folder and track number.
- 4 Repeat steps 2 – 3 for other folder/tracks. Up to 32 tracks can be programmed.
- 5 Press the ▶/|| (CD ▶/||) button to start playback.

To cancel the programmed play mode:

During programmed stop mode, press the ■ (CD ■) button. The display will show "MEM CLEAR" and all the programmed contents will be cleared.

Adding tracks to the program:

If a program has been previously stored, the "MEMORY" indicator will be displayed. Then follow steps 1 - 3 to add tracks. The new tracks will be stored after the last track of the previous program.

Notes:

- When a disc is ejected, the program is automatically canceled.
- If you press the ON/STAND-BY button to enter the stand-by mode or change the function from CD to another, the programmed selections will be cleared.
- During the program operation, random play is not possible.

Procedure to playback MP3/WMA disc with folder mode on

To play back CD-R/RW.

- 1 Press the CD button, and load an MP3/WMA disc. After disc is loaded, disc info will be displayed.

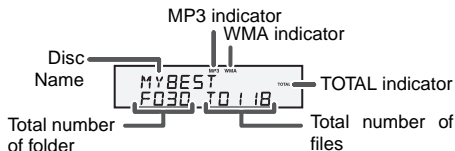

- 2 Press the FOLDER button, and press the TUNING (▼ or ▲) button on the remote control to select desired playback folder. (Folder mode on)



- 3 Select desired file to be played back by pressing the ◀◀ or ▶▶ button.
- 4 Press the ▶/|| (CD ▶/||) button. Playback will start and file name will be displayed.

- Title, Artist and Album name are displayed if they are recorded on the disc.
- In case of playback with the folder mode on, press the TUNING (▼ or ▲) button on the remote control, and the folder can be selected even though it is in playback/pause mode. It will continue playback/pause mode in the 1st track of the selected folder.
- Display content can be changed by pressing the DISPLAY button.

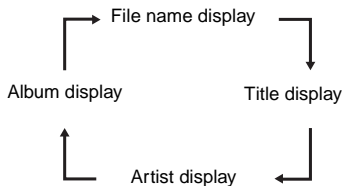

Note:

If "NO SUPPORT" is displayed, it means "Copyright protected WMA file" or "Not supported playback file" is selected.

Listening to USB mass storage device/MP3 player

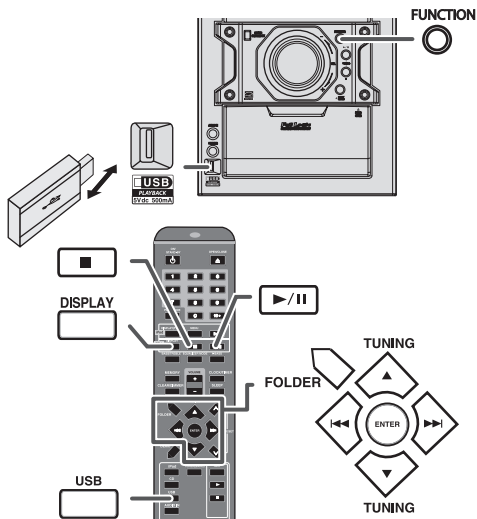

- Press the ►/|| (USB ►/||) button. Playback will start and the file name will be displayed.
 - Title, Artist and Album name are displayed if they are recorded in the USB memory device.
 - Display content can be changed by pressing the DISPLAY button.

■ To remove USB memory device

- Press the ■ (USB ■) button to stop playback.
- Disconnect USB memory device from the USB terminal.

Notes:

- SHARP will not be held liable for the loss of data while the USB memory device is connected to the audio system.
- This USB memory's format supports FAT 16 or FAT 32.
- SHARP cannot guarantee that all USB memory devices will work on this audio system.
- USB cable is not recommended for use in this audio system to connect to USB memory device. Use of the USB cable will affect the performance of this audio system.
- This USB memory cannot be operated via USB hub or external HDD-storage.
- The USB terminal in this unit is not intended for a PC connection but is used for music streaming with a USB memory device.
- If unplayable file is played on this product, "NO SUPPORT" is indicated.
- This product relates to USB mass storage devices and MP3 players. It may however face some irregularities due to various unforeseen reasons from some devices. Should this happen, turn off the unit and then turn it on again.
- The USB port is only intended for direct connection to a USB memory device without any cable.
- Playback order for MP3 files may differ depending on the writing software used during file download.
- Bitrate which is supported by MP3 is 32-320 kbps, WMA is 64-160 kbps.
- Playlists are not supported on this unit.
- This unit can display Folder Name or File Name up to 32 characters.
- Folders with non playable files are also counted.
- The display playback time may not be displayed correctly when playing back a variable bitrate file.
- The ID3TAG information supported are TITLE, ARTIST and ALBUM only. Title name, artist name and album name can be displayed by pressing the DISPLAY button during file playback or pause mode.
- WMA meta tag also supports title, artist and album name which are recorded in WMA files. Copyright protected WMA files cannot be played back.

Note:
This USB mass storage device or MP3 player is not compatible with MTP and AAC file systems.

■ To playback USB/MP3 player with folder mode off

- Press the USB button on the remote control or FUNCTION button repeatedly on main unit to select USB function. Connect the USB memory device that has MP3/WMA format files on the unit. When the USB memory is connected to the main unit, the device information will be displayed.
- Select desired file to be played back by pressing the ◀◀ or ▶▶ button.
- Press the ►/|| (USB ►/||) button. Playback will start and the file name will be displayed.
 - Title, Artist and Album name are displayed if they are recorded in the USB memory device.
 - Display content can be changed by pressing the DISPLAY button.

Note:
To pause playback:
Press the ►/|| (USB ►/||) button.

■ To playback USB/MP3 player with folder mode on

- Press the USB button on the remote control or FUNCTION button repeatedly on main unit to select USB function. Connect the USB memory device that has MP3/WMA format files on the unit. When the USB memory is connected to the main unit, the device information will be displayed.
- Press the FOLDER button, and press the TUNING (▼ or ▲) button on the remote control to select desired playback folder. To start playback with folder mode on, go to step 4. To change the playback folder, press the TUNING (▼ or ▲) button on the remote control to select another folder.
- Select desired file to be played back by pressing the ◀◀ or ▶▶ button.

The following functions are the same as CD operations:

	Page
Direct track search	6
Repeat play	6
Random play	6
Programmed play	6

Note:

If USB memory device is not connected, "NO MEDIA" will be shown on the display.

Listening to the radio

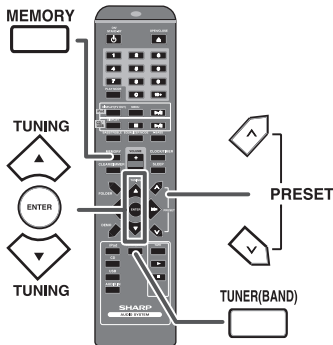
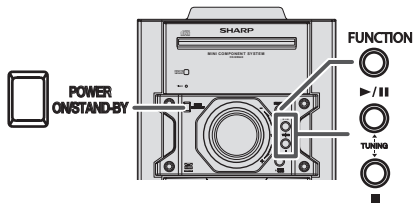

■ Presetting a station

You can store 40 AM and FM stations in memory and recall them at the push of a button. (Preset tuning)

- 1 Perform steps 1 - 3 in "Tuning".
- 2 Press the MEMORY button.

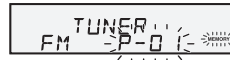

- 3 Within 30 seconds, press the PRESET (∨ or ∧) button to select the preset channel number. Store the stations in memory, in order, starting with preset channel 1.
- 4 Within 30 seconds, press the MEMORY button to store that station in memory. If the "MEMORY" and preset number indicators disappear before the station is memorized, repeat the operation from step 2.
- 5 Repeat steps 1 - 4 to set other stations, or to change a preset station. When a new station is stored in the memory, the station previously memorized for that preset channel number will be erased.

Note:

The backup function protects the memorized stations for a few hours should there be a power failure or the AC power cord become disconnected.

■ To recall a preset station

Press the PRESET (∨ or ∧) button for less than 0.5 seconds to select the desired station.

■ To scan the preset stations

The stations saved in the memory can be scanned automatically. (Preset memory scan)

- 1 Press the PRESET (∨ or ∧) button for more than 0.5 seconds. The preset number will flash and the programmed stations will be tuned in sequentially, for 5 seconds each.
- 2 Press the PRESET (∨ or ∧) button again when the desired station is located.

■ To erase entire preset memory

- 1 Press the ON/STAND-BY button to enter the stand-by mode.
- 2 While pressing down the FUNCTION button, press the POWER ON/STAND-BY button until "TUNER CLEAR" appears.



■ Tuning

- 1 Press the ON/STAND-BY button to turn the power on.
- 2 Press the FUNCTION button on the main unit or TUNER (BAND) button on the remote control repeatedly to select the desired frequency band (FM stereo, FM mono or AM).
- 3 Press the TUNING (∨ or ∧) button to tune in to the desired station.

Manual tuning:

Press the TUNING (∨ or ∧) button repeatedly to tune in to the desired station.

Auto tuning:

When the TUNING (∨ or ∧) button is pressed for more than 0.5 seconds, scanning will start automatically and the tuner will stop at the first receivable broadcast station.

Notes:

- When radio interference occurs, auto scan tuning may stop automatically at that point.
- Auto scan tuning will skip weak signal stations.
- To stop the auto tuning, press the TUNING (∨ or ∧) button again.

To receive an FM stereo transmission:

- Press the FUNCTION button on main unit or TUNER (BAND) button on remote control repeatedly to select stereo mode and "ST" indicator will be displayed. "∞" will appear when an FM broadcast is in stereo.
- If the FM reception is weak, press the TUNER (BAND) button to extinguish the "ST" indicator. The reception changes to monaural, and the sound becomes clearer.

Listening to a cassette tape

Note:

Tape recording function is not available in this unit.

Before playback:

- For playback, use normal or low-noise tapes for the best sound. (Metal or CrO₂ tapes are not recommended.)
- Do not use C-120 tapes or poor-quality tapes, as they may cause malfunctions.
- Before loading a tape into the cassette compartment, tighten the slack with a pen or a pencil.

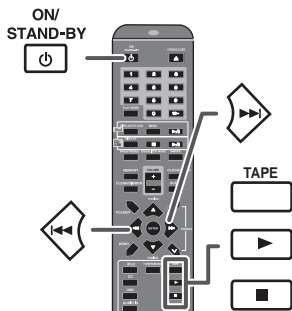
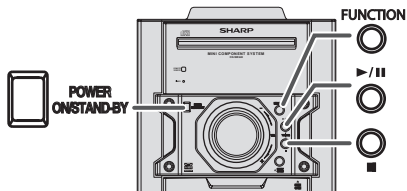

Various tape functions

Function	Main unit	Remote control	Operation
Tape playback 			Press in the stop mode.
Stop 			Press in the playback, fast forward or fast rewind mode.
Fast forward/ Fast rewind			Press in the playback or stop mode.

Caution:

- To remove the cassette, press the ■ (TAPE ■) button, and then open the compartment.
- If a power failure occurs during tape operation, the tape head will remain engaged with the tape and the cassette door will not open. In this case, wait until the power is restored.

Tape playback

- 1 Press the ON/STAND-BY button to turn the power on.
- 2 Press the FUNCTION button on main unit repeatedly or TAPE button on remote control to select TAPE function.
- 3 Open the cassette door by pushing the area marked "▲ PUSH OPEN".

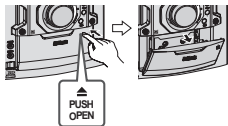

- 4 Load a cassette into the cassette compartment.

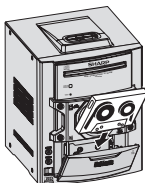

- 5 Press the >|| (TAPE >) button to start playback.

Setting the clock (Remote control only)

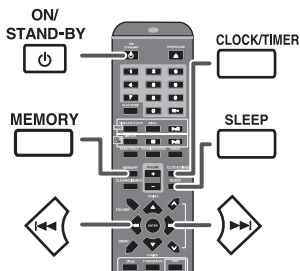

In this example, the clock is set for the 12-hour (AM 12:00) display.

- 1 Press the ON/STAND-BY button to turn the power on.
- 2 Press the CLOCK/TIMER button.
- 3 Within 10 seconds, press the MEMORY button. Press the ◀◀ or ▶▶ button to select 12-hour or 24-hour display and then press the MEMORY button.

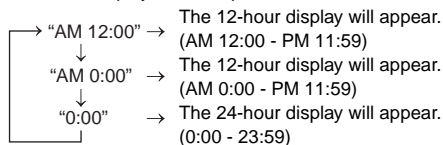

- 4 To adjust the hour, press the ◀◀ or ▶▶ button and then press the MEMORY button. Press the ◀◀ or ▶▶ button once to advance the time by 1 hour. Hold it down to advance continuously.
- 5 To adjust the minutes, press the ◀◀ or ▶▶ button and then press the MEMORY button. Press the ◀◀ or ▶▶ button once to advance the time by 1 minute.

To confirm the time display:

Press the CLOCK/TIMER button. The time display will appear for about 5 seconds.

Note:

The "CLOCK" will appear or time will be displayed when the AC power supply is restored after a power failure or unplugging the unit. If incorrect, readjust the clock as follows.

To readjust the clock:

Perform "Setting the clock" from step 1. If the "CLOCK" does not appear in step 2, step 3 (for selecting the 12-hour or 24-hour display) will be skipped.

To change the 12-hour or 24-hour display:

- 1 Clear all the programmed contents. [Refer to "Factory reset, clearing all memory" on page 14 for details.]
- 2 Perform "Setting the clock" from step 1 onwards.

Timer and sleep operation (Remote control only)

Once timer:

Once timer play works for one time only at a preset time.

Daily timer:

Daily timer play works at the same preset time every day. For example, set the timer as a wake-up call every morning.

Using the once timer and daily timer in combination:

For example, use the once timer to listen a radio program, and use the daily timer to wake up.

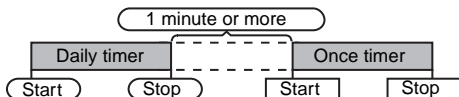

Timer playback

Before setting timer:

- Check that the clock is set to the correct time (refer to page 11). If it is not set, you cannot use the timer function.
- For timer playback: Plug in USB or load disc/cassette or dock iPod to be played.



- 1 Press the ON/STAND-BY button to turn the power on.
- 2 Press and hold the CLOCK/TIMER button.
- 3 Within 10 seconds, press the ◀◀ or ▶▶ button to select "ONCE SET" or "DAILY SET", and press the MEMORY button. Set the clock to the correct time if "ONCE SET" or "DAILY SET" does not appear.
- 4 Within 10 seconds, press the ◀◀ or ▶▶ button to select "TIMER SET", and press the MEMORY button.
- 5 To adjust the hour, press the ◀◀ or ▶▶ button and then press the MEMORY button.
- 6 To adjust the minutes, press the ◀◀ or ▶▶ button and then press the MEMORY button.
- 7 Set the time to finish as in steps 5 and 6 above.
- 8 To select the timer playback source (CD, TUNER, USB, iPod, TAPE or AUDIO IN), press the ◀◀ or ▶▶ button. Press the MEMORY button. When you select the tuner, select a station by pressing the ◀◀ or ▶▶ button, and then press the MEMORY button. If a station has not been programmed, "NO PRESET" will be displayed and timer setting will be canceled.
- 9 Adjust the volume using the VOLUME control, and then press the MEMORY button. Do not turn the volume up too high.
- 10 Press the ON/STAND-BY button to enter the power stand-by mode. The "TIMER" indicator lights up and the unit is ready for timer playback.

Timer and sleep operation (Remote control only) (continued)

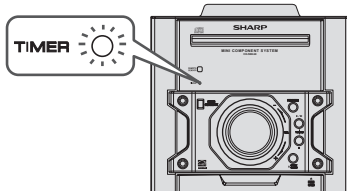

- 11 When the preset time is reached, playback will start. The volume will increase gradually until it reaches the preset volume. The "⊙" indicator will blink during timer playback. The "DAILY" indicator will blink during timer playback.
- 12 When the timer end time is reached, the system will enter the power stand-by mode automatically.

Once timer:

The timer will be canceled.

Daily timer:

The timer operates at the same time every day. It will continue until the daily timer setting is canceled. Cancel the daily timer when it is not in use.

Notes:

- When performing timer playback using another unit connected to the USB terminal or AUDIO IN jack, select "USB" or "AUDIO IN" in step 8.
- This unit will turn on or enter the power stand-by mode automatically. However, the connected unit will not turn on or off. To stop the timer playback, follow step "Canceling the timer setting" of this page.

Checking the timer setting:

- 1 Turn the power on and press and hold down the CLOCK/TIMER button.
- 2 Within 10 seconds, press the ◀◀ or ▶▶ button to select "ONCE SET" or "DAILY SET", and press the MEMORY button.
- 3 Within 10 seconds, press the ◀◀ or ▶▶ button to select "TIMER CALL", and press the MEMORY button.

Canceling the timer setting:

- 1 Turn the power on and press and hold down the CLOCK/TIMER button.
- 2 Within 10 seconds, press the ◀◀ or ▶▶ button to select "ONCE SET" or "DAILY SET", and press the MEMORY button.
- 3 Within 10 seconds, press the ◀◀ or ▶▶ button to select "TIMER OFF", and press the MEMORY button. Timer will be canceled (the setting will not be canceled).

Reusing the memorized timer setting:

The timer setting will be memorized once it is entered. To reuse the same setting, perform the following operations.

- 1 Turn the power on and press and hold down the CLOCK/TIMER button.
- 2 Within 10 seconds, press the ◀◀ or ▶▶ button to select "ONCE SET" or "DAILY SET", and press the MEMORY button.
- 3 Within 10 seconds, press the ◀◀ or ▶▶ button to select "TIMER ON", and press the MEMORY button.
- 4 Press the ON/STAND-BY button to enter the power stand-by mode.

■ Sleep operation

The radio, compact disc, iPod and USB can all be turned off automatically.

- 1 Play back the desired sound source.
- 2 Press the SLEEP button.
- 3 Within 10 seconds, press the SLEEP button repeatedly to select the time.
10 → 20 → 30 → 80 → 90
- 4 "SLEEP" will appear.
- 5 The unit will enter the power stand-by mode automatically after the preset time has elapsed. The volume will be turned down 1 minute before the sleep operation finishes.

To confirm the remaining sleep time:

- 1 While "SLEEP" is indicated, press the SLEEP button.

To cancel the sleep operation:

Press the ON/STAND-BY button while "SLEEP" is indicated. To cancel the sleep operation without setting the unit to the stand-by mode, proceed as follows.

- 1 While "SLEEP" is indicated, press the SLEEP button.
- 2 Within 10 seconds, press the SLEEP button repeatedly to select "SLEEP 00".

■ To use timer and sleep operation together

Sleep and timer playback:

For example, you can fall asleep listening to the radio and wake up to CD in the next morning.

- 1 Set the sleep time (see above, steps 1 - 5).
- 2 While the sleep timer is set, set the timer playback (steps 2 - 9, page 11).

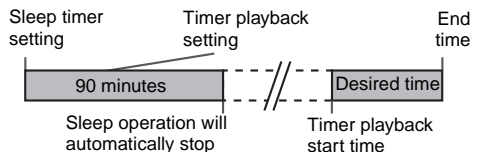

Enhancing your system

The connection cord is not included. Purchase a commercially available cord as shown below.

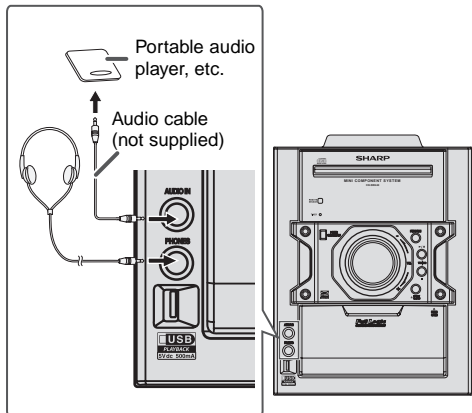

■ Listening to the playback sounds of portable audio player, etc.

- 1 Use a connection cord to connect the portable audio player etc. to the AUDIO IN jack. When using video equipment, connect the audio output to this unit and the video output to a television.
- 2 Press the ON/STAND-BY button to turn the power on.
- 3 Press the AUDIO IN button on the remote control or FUNCTION button repeatedly on main unit to select AUDIO IN function.
- 4 Play the connected equipment. If volume level of the connected device is too high, sound distortion may occur. Should this happen, lower the volume of the connected device. If volume level is too low, increase the volume of the connected device.

Note:

To prevent noise interference, place the unit away from the television.

■ Headphones

- Do not turn the volume on to full at switch on and listen to music at moderate levels. Excessive sound pressure from earphones and headphones can cause hearing loss.
- Before plugging in or unplugging the headphones, reduce the volume.
- Be sure your headphones have a 1/8" (3.5 mm) diameter plug and impedance between 16 and 50 ohms. The recommended impedance is 32 ohms.
- Plugging in the headphones disconnects the speakers automatically. Adjust the volume using the VOLUME control.

Troubleshooting chart

Many potential problems can be resolved by the owner without calling a service technician.

If something is wrong with this product, check the following before calling your authorized SHARP dealer or service center.

■ General

Symptom	Possible cause
● The clock is not set to the correct time.	● Did a power failure occur? Reset the clock. (Refer page 11)
● When a button is pressed, the unit does not respond.	● Set the unit to the power stand-by mode and then turn it back on. ● If the unit still malfunctions, reset it. (Refer page 14)
● No sound is heard.	● Is the volume level set to "0"? ● Are the headphones connected? ● Are the speaker wires disconnected?

■ CD player

Symptom	Possible cause
● Playback does not start.	● Is the disc loaded upside down?
● Playback stops in the middle or is not performed properly.	● Does the disc satisfy the standards? ● Is the disc distorted or scratched?
● Playback sounds are skipped, or stopped in the middle of a track.	● Is the unit located near excessive vibrations? ● Is the disc very dirty? ● Has condensation formed inside the unit?

■ Remote control

Symptom	Possible cause
● The remote control does not operate.	● Is the AC power cord of the unit plugged in? ● Is the battery polarity correct? ● Are the batteries dead? ● Is the distance or angle incorrect? ● Does the remote control sensor receive strong light?

■ Cassette deck

Symptom	Possible cause
● Sound skipping. ● Cannot hear treble. ● Sound Fluctuation.	● Is there any slack? ● Is the tape stretched? ● Are the capstans, pinch rollers or heads dirty?
● Cannot remove the tape.	● If a power failure occurs during playback, the heads remain engaged with the tape. Do not open the compartment with great force.

Troubleshooting chart (continued)

USB

Symptom	Possible cause
<ul style="list-style-type: none"> ● Device cannot be detected. 	<ul style="list-style-type: none"> ● Is there any MP3/WMA file available? ● Is the device properly connected? ● Is it an MTP device? ● Does the device contain AAC file only?
<ul style="list-style-type: none"> ● Playback does not start. 	<ul style="list-style-type: none"> ● Is it a copyright protected WMA file? ● Is it a false MP3 file?
<ul style="list-style-type: none"> ● Wrong time display. ● Wrong file name display. 	<ul style="list-style-type: none"> ● Is Variable Bitrate file being played back? ● Is the File Name written in Chinese or Japanese characters?

iPod

Symptom	Possible cause
<ul style="list-style-type: none"> ● No sound is produced. No image appears on the TV/monitor. 	<ul style="list-style-type: none"> ● The iPod is not playing. ● The iPod is not properly connected to the unit. ● Is the AC power cord of the unit plugged in? ● The video cable is not properly connected. ● The TV/monitor's input selection is not properly set.
<ul style="list-style-type: none"> ● iPod will not charge. 	<ul style="list-style-type: none"> ● Wrong iPod adaptor is used. ● The iPod is not making full contact with the iPod connector. ● The main unit is in stand-by mode. ● Using 3rd generation iPod.

Tuner

Symptom	Possible cause
<ul style="list-style-type: none"> ● The radio makes unusual noises continuously. 	<ul style="list-style-type: none"> ● Is the unit placed near the TV or computer? ● Is the FM antenna or AM loop antenna placed properly? Move the antenna away from the AC power cord if it is located nearby.

Condensation

Sudden temperature changes, storage or operation in an extremely humid environment may cause condensation inside the cabinet (CD pickup, etc.) or on the transmitter on the remote control. Condensation can cause the unit to malfunction. If this happens, leave the power on with no disc in the unit until normal playback is possible (about 1 hour). Wipe off any condensation on the transmitter with a soft cloth before operating the unit.

Before transporting the unit

Remove the iPod, USB memory device and disc from the unit. Then, set the unit to the power stand-by mode. Carrying the unit with iPod or USB memory device left docked or discs left inside can damage the unit.

If problem occurs

When this product is subjected to strong external interference (mechanical shock, excessive static electricity, abnormal supply voltage due to lightning, etc.) or if it is operated incorrectly, it may malfunction.

If such a problem occurs, do the following:

- 1 Set the unit to the stand-by mode and turn the power on again.
- 2 If the unit is not restored in the previous operation, unplug and plug in the unit again, and then turn the power on.

Note:

If neither operation above restores the unit, clear all the memory by resetting it.

Factory reset, clearing all memory

- 1 Press the ON/STAND-BY button to enter the power stand-by mode.
- 2 While pressing down the OPEN/CLOSE button, press the POWER ON/STAND-BY button until "ALL CLEAR" appears.



Caution:

This operation will erase all data stored in memory including clock, timer settings, tuner preset, and CD program.

Care of compact discs

Compact discs are fairly resistant to damage, however mistracking can occur due to an accumulation of dirt on the disc surface. Follow the guidelines below for maximum enjoyment from your CD collection and player.

- Do not write on either side of the disc, particularly the non-label side from which signals are read. Do not mark this surface.
- Keep your discs away from direct sunlight, heat and excessive moisture.
- Always hold the CDs by the edges. Fingerprints, dirt or water on the CDs can cause noise or mistracking. If a CD is dirty or does not play properly, clean it with a soft, dry cloth, wiping straight out from the center, along the radius.

Maintenance

Cleaning the CD pickup lens

In order to ensure proper operation of the CD player, preventative maintenance (cleaning of the laser pickup lens) should be performed periodically. Lens cleaners are commercially available. Contact your local CD software dealer for options.

Cleaning the cabinet

Periodically wipe the cabinet with a soft cloth and a diluted soap solution, then with a dry cloth.

Caution:

- Do not use chemicals for cleaning (gasoline, paint thinner, etc.). It may damage the cabinet.
- Do not apply oil to the inside of the unit. It may cause malfunctions.

Specifications

As part of our policy of continuous improvement, SHARP reserves the right to make design and specification changes for product improvement without prior notice. The performance specification figures indicated are nominal values of production units. There may be some deviations from these values in individual units.

General

Power source	AC 120 V ~ 60 Hz
Power consumption	102 W
Dimensions	Width: 9 - 7/16" (240 mm) Height: 12 - 7/16" (315.5 mm) Depth: 11 - 5/32" (283.2 mm)
Weight	13.9 lbs. (6.3 kg)

Amplifier

Output power	<p>Front Speakers RMS: Total 200 watts (100 watts per channel into 4 ohms at 1 kHz, 10% total harmonic distortion) FTC: 75 watts minimum RMS per channel into 4 ohms from 100 Hz to 20 kHz, 10% total harmonic distortion.</p> <p>Subwoofer RMS: 150 watts into 8 ohms at 70 Hz, 10% total harmonic distortion FTC: 130 watts RMS into 8 ohms from 50 Hz to 120 Hz, 10% total harmonic distortion.</p>
Output terminals	Speakers: 4 ohms Headphones: 16 - 50 ohms (recommended: 32 ohms) Video output : 1Vp-p
Input terminals	Audio In (audio signal): 250 mV/47 k ohms

CD player

Type	Single disc multi-play compact disc player
Signal readout	Non-contact, 3-beam semiconductor laser pickup
D/A converter	Multi bit D/A converter
Frequency response	20 - 20,000 Hz
Dynamic range	90 dB (1 kHz)

Cassette deck

Frequency response	50 - 14,000 Hz (normal tape)
Signal/noise ratio	50 dB (playback)
Wow and flutter	0.35% (WRMS)

USB

USB host interface	<ul style="list-style-type: none"> Complies with USB 1.1 (Full Speed)/ 2.0 Mass Storage Class. Support Bulk only and CBI protocol.
Support file	<ul style="list-style-type: none"> MPEG 1 Layer 3 WMA (Non DRM)
Bitrate support	<ul style="list-style-type: none"> MP3 (32 ~ 320 kbps) WMA (64 ~ 160 kbps)
Other	<ul style="list-style-type: none"> Maximum total number of MP3/WMA files is 1024. Maximum total number of folders is 255 INCLUSIVE of root directory. The ID3TAG information supported are TITLE, ARTIST and ALBUM only. Supports ID3TAG version 1 and version 2.
File system support	<ul style="list-style-type: none"> Support USB devices with Microsoft Windows/DOS/FAT 12/ FAT 16/ FAT 32. 2 kbyte block length for sector.

Tuner

Frequency range	FM: 87.5 - 108 MHz AM: 530 - 1,720 kHz
------------------------	---

Speaker

Front Speaker	
Type	2-way type speaker system 2" (5 cm) tweeter 5-1/8" (13 cm) woofer
Maximum input power	200 W
Rated input power	100 W
Impedance	4 ohms
Dimensions	Width: 7-1/16" (180 mm) Height: 11-13/16" (300 mm) Depth: 8" (204 mm)
Weight	6.0 lbs. (2.7 kg)/each
Subwoofer	
Type	Subwoofer system 8" (16 cm) woofer
Maximum input power	300 W
Rated input power	150 W
Impedance	8 ohms
Dimensions	Width: 9-1/16" (230 mm) Height: 11-13/16" (300 mm) Depth: 12" (305 mm)
Weight	9.7 lbs. (4.4 kg)

Free Manuals Download Website

<http://myh66.com>

<http://usermanuals.us>

<http://www.somanuals.com>

<http://www.4manuals.cc>

<http://www.manual-lib.com>

<http://www.404manual.com>

<http://www.luxmanual.com>

<http://aubethermostatmanual.com>

Golf course search by state

<http://golfingnear.com>

Email search by domain

<http://emailbydomain.com>

Auto manuals search

<http://auto.somanuals.com>

TV manuals search

<http://tv.somanuals.com>