

SINGER

112W140

Form 246Bw

Rev. (445)

Printed in U. S. A.

112w140

LIST OF PARTS



MACHINE No. 112w140

*** A TRADE MARK OF
THE SINGER MANUFACTURING COMPANY

INSTRUCTIONS FOR OILING

To ensure easy running and prevent unnecessary wear of the parts which are in movable contact, the machine requires oiling and when in continuous use, "TYPE B" or "TYPE D" OIL, sold only by Singer Sewing Machine Company, should be applied at least twice each day to all oil holes marked "OIL", as instructed in Form 2427w.

"TYPE D" OIL is stainless.

INDEX

	Page
Accessories.....	15
Arm Cap and Thread Guide.....	28
Attachment Slide Plates.....	18
Bobbin Winder.....	16
" " "v" Belt Drive.....	18
Feed Dogs.....	19
Foot Lifter.....	28
Knee Lifter.....	17
Machine No. 112w140.....	5
Miscellaneous Parts.....	30
Needle Holders.....	21
Numerical List of Parts.....	31
Presser Feet.....	21
Strip Reels.....	28-29
Strip Tension Device.....	29
Thread Unwinder.....	17
Throat Plates.....	27

Copyright, U. S. A., 1938, 1939, 1940,
1941, 1944 and 1945
by The Singer Manufacturing Co.
All Rights Reserved for all Countries

INSTRUCTIONS FOR ORDERING

In ordering from this list, use ONLY the PART number in the FIRST column.

The number stamped on a Sewing Machine Part is the number of the Single Part only, except when the part includes Set Screws, Clamping Screws, Studs and Rollers Spun on, Small Wires riveted, or Parts soldered together, etc., which it is necessary to furnish in combination.

Every combination of parts sent out has its specific number which, although not stamped on Parts (except in above case), must be used when ordering the combination.

Each number always indicates the SAME PART in whatever list it appears, or for whatever Machine.

The letters after some of the numbers indicate the style of finish only, as follows:

- A. Hardened, Polished, Nickel Plated and Buffed.
- B. Polished, Nickel Plated and Buffed.
- C. Hardened only.
- D. Polished only.
- E. Soft, not polished.
- F. Hardened and Polished.
- H. Blued.
- J. Nickel Plated only.
- R. Merlized.
- X. Black Oxide.
- XC. Hardened and Black Oxide.
- Y. Black Nickel only.

These letters MUST BE USED when they appear in the list and AFTER the number, as in the list.

In this series:

200001 to 201500 and 350001 to 351500 are Screw Numbers.
201501 to 201800 and 351501 to 351800 are Nut Numbers.
201801 to 202000 and 351801 to 352000 are Roller Numbers.
202001 to 350000 are Numbers of Machine Parts.

The figures in the second column refer only to the plate in which the illustration of the part is shown and are NOT TO BE USED in ordering.

Two or more numbers over a cut indicate that the difference between such parts is not visible in an illustration.

Parts marked with an asterisk (*) are furnished when repairs are made at the factory.

LIST OF PARTS COMPLETE

FOR

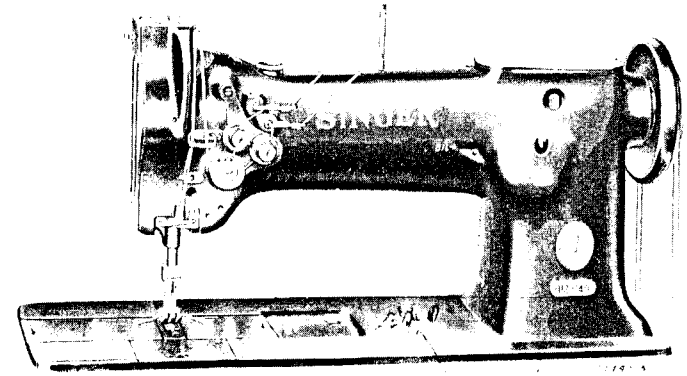

*3500 to 35000
years. 112w*

MACHINE No. 112w140

TWO NEEDLE HIGH SPEED COMPOUND FEED

BALL BEARING, SAFETY CLUTCH

For Corsets, Cloaks and Clothing Generally

Made in gauges from 1/32 to 1 1/2 inches.

No.	Plate	Name
*248401	----	Arm with 202135
224002	17811	" Cap
200278H	17811	" " Screw
202248	17811	" " " Washer
204235	17806	" Position Pin (2)
200004E	17806	" Screw (3)
202005	17806	" " Washer (3)
248440	17811	" Shaft with 224392 and 350431E
249440	17811	" " Ball Bearing
*240054	17811	" " " " Collar with two 200378C
240055	17811	Arm Shaft Ball Bearing Collar 240054 with 249440
200378C	17811	Arm Shaft Ball Bearing Collar Set Screw

PARTS FOR MACHINE NO. 112W140

No.	Plate	Name
240056	17811	Arm Shaft Ball Bearing Retaining Washer
*240053	17811	Arm Shaft Bushing (back)
240057	17811	Arm Shaft Bushing (back) (ball bearing) complete, Nos. 240053, 240055 and 240056
200335C	17811	Arm Shaft Bushing (back) Set Screw
263096	17811	" " " (front) with 223847
223847	17811	" " " " Oil Packing (wick)
200502H	17811	Arm Shaft Bushing (front) Oil Packing Thumb Screw
204329	17811	Arm Shaft Bushing (front) Oil Pad
200341C	17811	" " " " Set Screw
224103	17806	" " Connection Belt
224104	17806	" " " " Pulley with 200327C, 200602C and two 202253
200602C	17806	Arm Shaft Connection Belt Pulley Position Screw
200327C	17806	Arm Shaft Connection Belt Pulley Set Screw
202253	17806	Arm Shaft Connection Belt Pulley Spring Flange
224139	17808	Arm Shaft Connection Belt Timing Plate
200164B	17808	Arm Shaft Connection Belt Timing Plate Screw (2)
224392	17811	Arm Shaft Oil Packing (wick)
350431E	17811	" " " " Stop Screw
224144	16290	Attachment Slide Plate with 213479 and 236061
236061	16290	Attachment Slide Plate Friction Slide
213479	16290	" " " " " " " " Spring
248456	17811	Balance Wheel (disc) "V" belt groove (outside diam. of belt groove 2.9 in) with 201346C and 350107C
248402	17811	Balance Wheel (disc) (belt groove 2-1/8 in. diam.) with 200328C and 200335C
Note: Balance Wheel 248402 is furnished with this machine unless otherwise specified on order.		
350419H	17811	Balance Wheel Adjusting Screw
200328C	17811	" " " " Position Screw
350107C	17811	" " " " " " " "
200335C	17811	" " " " Set Screw
201346C	17811	" " " " " " " "
*248403	-----	Bed with 203376
202258	17806	" Hinge Connection (2)
200570E	17806	" " " " Screw (4)
54897	17808	" Oil Cup (3)
223852	16290	Bed Slide (back)

PARTS FOR MACHINE NO. 112W140

9

No.	Plate	Name
223811	16290	Bed Slide (back) Stop
223812	16290	" " " " Spring
223853	16290	" " (front), for use with Throat Plates, in gauges from 1/32 to 1/2 inch
224043	16290	Bed Slide (front), for use with Throat Plates, in gauges from 17/32 to 1 inch
224044	16290	Bed Slide (front), for use with Throat Plates, in gauges from 1-1/32 to 1-1/2 inch
203470	17803	Bobbin (2)
*248459	-----	" Case (chromium plated)
203648	17803	" " Latch
*202056	-----	" " " Pin
203473	17803	" " " Plunger
203474	17803	" " " Spring
241674	17803	" " Oiling Felt
241675	17803	" " " " Retainer
350405C	17803	" " " " " Screw
248404	17804	" " Opener
224005	17804	" " " Lever with 201349C, 201542C and 203101
201349C	17804	Bobbin Case Opener Lever Driving Screw Stud
201542C	17804	Bobbin Case Opener Lever Driving Screw Stud Nut
203101	17804	Bobbin Case Opener Lever Driving Screw Stud Oil Packing (wick)
265088	17804	Bobbin Case Opener Lever Hinge Stud with 202277
202277	17804	Bobbin Case Opener Lever Hinge Stud Oil Packing (wick)
201246C	17804	Bobbin Case Opener Lever Hinge Stud Set Screw
248405	17804	Bobbin Case Opener Lever Link
200118D	17804	" " " " Screw
236083	17803	" " Tension Spring
201016F	17803	" " " " Regulating Screw
200594C	17803	Bobbin Case Tension Spring Screw
203216	17803	" " Washer (cloth)
248460	17803	Bobbin Case complete, Nos. 200594C, 201016F, 202056, 203216, 203473, 203474, 203648, 236083, 241674, 241675, 248459 and two 350405C
210911	16290	Face Plate
202135	16290	" " Position Pin
200473H	16290	" " Thumb Screw
248406	17807	Feed Bar with 200336E and 201535E
248407	17807	" " 248406 with 200040C, 224052 and 225837
350393C	17807	Feed Bar Hinge Screw (driving)
201518E	17807	" " " " Nut

No.	Plate	Name	No.	Plate	Name
224058	16298	Feed Dog, 50 needle hole, needles 1/8 in. apart, for needle sizes 14 and 15 in gauges 1/32, 3/64 and 1/16 in., for 224059	248420	17807	Feed Driving Rock Shaft Bushing (left) (split)
223637	16254	Feed Dog, 50 needle hole, for needle sizes 14 and 15, in gauges 3/32, 1/8 and 5/32 in., for 224030	200347C	17807	Feed Driving Rock Shaft Bushing (left) Pinch Screw
223639	16254	Feed Dog, 50 needle hole, for needle sizes 14 and 15, in gauges 3/16 and 7/32 in., for 224031	201007C	17807	Feed Driving Rock Shaft Bushing (left) Pinch Screw Set Screw
223638	16254	Feed Dog, 50 needle hole, for needle sizes 14 and 15, in gauges from 1/4 to 13/32 in., in steps of 1/32 in., for 223884	202355	17807	Feed Driving Rock Shaft Bushing (left) Pinch Screw Set Screw Packing (brass)
223634	16254	Feed Dog, 50 needle hole, for needle sizes 14 and 15, in gauges from 7/16 to 31/32 in., in steps of 1/32 in., for 224033	248421	17807	Feed Driving Rock Shaft Bushing (right) (split)
223641	16255	Feed Dog, 50 needle hole, for needle sizes 14 and 15, in gauges from 1 to 1-1/2 in., in steps of 1/32 in., for 224035	200327C	17807	Feed Driving Rock Shaft Bushing (right) Pinch Screw
200106E	16254	Feed Dog Screw (2)	200347C	17807	Feed Driving Rock Shaft Bushing (right) Pinch Screw Set Screw
200336E	17807	" " Support Screw	202355	17807	Feed Driving Rock Shaft Bushing (right) Pinch Screw Set Screw Packing (brass)
201535E	17807	" " " Nut	224141	17807	Feed Driving Rock Shaft Crank with 200019E
248409	17808	" Driving Crank (Eccentric End) with 248410 and 248411	200019E	17807	Feed Driving Rock Shaft Crank Pinch Screw
248408	17807	Feed Driving Crank (Rock Shaft End) with 200030H	202625	17807	Feed Driving Rock Shaft Stop Collar with two 200383C (2)
248410	17808	Feed Driving Crank Oiling Felt	200383C	17807	Feed Driving Rock Shaft Stop Collar Set Screw
248411	17808	" " " " " Staple	248449	17806	Feed Indicating Disc with 200958C
248412	17807	" " " Oil Leader (brass)	200958C	17806	" " " Set Screw
200030H	17807	" " " Pinch Screw	224154	17808	" Lifting Eccentric with 201220C
248413	17808	" " Eccentric	224052	17807	" " " Fork with 200173D and 223655
248414	17808	" " " Adjusting Disc	200040C	17807	Feed Lifting Eccentric Fork Screw
248415	17808	" " " " " Spring	225837	17807	" " " " " Washer
248416	17808	" " " " " " "	223655	17807	" " " Oiling Felt
		Collar with two 200382C	200173D	17807	" " " " " Screw
200382C	17808	Feed Driving Eccentric Adjusting Disc Spring Collar Set Screw	201220C	17808	" " " Set Screw
248417	17808	Feed Driving Eccentric Friction Gib	248422	17808	" Regulating Stud
200350H	17808	" " " " " " "	248423	17808	" " " Cotter Pin
		Adjusting Screw	248424	17808	" " " Socket
200369D	17808	Feed Driving Eccentric Friction Gib Adjusting Screw Set Screw	248425	17808	" " " Spring
248441	17808	Feed Driving Eccentric Friction Gib Adjusting Screw Set Screw Packing (brass)	248447	17808	Feed Regulating Stud complete, Nos. 248422 to 248425
248418	17808	Feed Driving Flange with 200382C, 201220C, two each 200350H, 200369D and 248441	*248444	-----	Hook (sewing)
201220C	17808	Feed Driving Flange Position Screw	248445	17803	" 248444 with 203525, 224025, two each 200590H and 201253F
200382C	17808	" " " Set Screw	248463	17803	Hook and Bobbin Case complete, Nos. 248445 and 248460
223650	17807	" " Rock Shaft	249365	17804	Hook Ball Bearing
248419	17807	" " " 223650 with 201518E, 248407 and 350393C	350394E	17804	" " " Adjusting Screw
			200403C	17804	" " " " " Set Screw
			204479	17804	Hook Ball Bearing Adjusting Screw Set Screw Packing (brass)
			248430	17804	Hook Ball Bearing Washer (felt)
			248429	17804	" " " " " (steel)

No.	Plate	Name
223867	17808	Hook Driving Gear (spiral) with 200362C and 201222C (2)
201222C	17808	Hook Driving Gear Position Screw
200362C	17808	" " " " Set Screw
248431	17804	" " Pinion (spiral) with two 200382C
200382C	17804	Hook Driving Pinion Set Screw
248432	17808	" " Shaft
249440	17808	" " " " Ball Bearing
*240060	17808	" " " " " Collar with 200378C and 201220C
240061	17808	Hook Driving Shaft Ball Bearing Collar 240060 with 249440
201220C	17808	Hook Driving Shaft Ball Bearing Collar Position Screw
200378C	17808	Hook Driving Shaft Ball Bearing Collar Set Screw
*240056	17808	Hook Driving Shaft Ball Bearing Retaining Washer
*240058	17808	Hook Driving Shaft Bushing (back)
240063	17808	Hook Driving Shaft Bushing (back) (ball bearing) complete, Nos. 240056, 240058 and 240061
200327C	17808	Hook Driving Shaft Bushing (back) Set Screw
224112	17808	Hook Driving Shaft Connection Belt Pulley with 202253 and two 201254C
201254C	17808	Hook Driving Shaft Connection Belt Pulley Set Screw
202253	17808	Hook Driving Shaft Connection Belt Pulley Spring Flange
203525	17803	Hook Gib
201253F	17803	" " Screw
248433	17805	" Saddle (left) with 200009E and 201246C
248434	17804	Hook Saddle (right) with 200009E and 201246C
223680	17808	Hook Saddle Bearing (left)
200327C	17808	" " " " Set Screw
223681	17808	" " " (right)
200335C	17808	" " " " Set Screw
248435	17804	" " Oil Pad (felt)
200009E	17804	" " Pinch Screw
248438	17805	Hook Saddle (left) complete, Nos. 200118D, 200403C, 204479, 224005, 248404, 248405, 248430, 248431, 248433, 248463, 265088, 350394E, two each 248429, 249365 and four 248435
248439	17804	Hook Saddle (right) complete, Nos. 200118D, 200403C, 204479, 224005, 248404, 248405, 248430, 248431, 248434, 248463, 265088, 350394E, two each 248429, 249365 and four 248435
200006E	17804	Hook Saddle Screw (2)
225585	17804	" " " Washer (2)

No.	Plate	Name
224025	17803	Hook Washer
200590H	17803	" " Screw
240067	16290	Knee Lifter Connection Lever
200262H	16290	" " " " Hinge Screw
223684	16290	Knee Lifter Connection Lever Lifting Rod with 202302
202302	16290	Knee Lifter Connection Lever Lifting Rod Cotter Pin
206628	16290	Knee Lifter Connection Lever Lifting Rod Spring
227227	16290	Knee Lifter Connection Lever Lifting Rod Spring Collar with 200113F
200113F	16290	Knee Lifter Connection Lever Lifting Rod Spring Collar Set Screw
240068	16290	Knee Lifter Lifting Lever
200262H	16290	" " " " Hinge Screw
223686	17809	Needle Bar
238251	17809	" " Connecting Link
264718	17809	" " " " Oil Guard
201183D	17809	" " " " " Screw
249393	17809	Needle Bar Connecting Link Stud with 202254
202254	17809	Needle Bar Connecting Link Stud Oil Packing (wick)
200374C	17809	Needle Bar Connecting Link Stud Set Screw
200383C	17809	Needle Bar Connecting Link Stud Set Screw
264714	17809	Needle Bar Connecting Stud with 200072C and 202277
202277	17809	Needle Bar Connecting Stud Oil Packing (wick)
200072C	17809	Needle Bar Connecting Stud Pinch Screw
248442	17809	" " Crank with 200335C, 200374C, 200383C, 200428C and 249393
248464	17809	Needle Bar Crank 248442 with 202400, 223881, 238251, 249398 and 264714
203172	17809	Needle Bar Crank Friction Washer
200428C	17809	" " " Position Screw
200335C	17809	" " " Set Screw
248436	17809	" " Rock Frame
248437	17809	" " " " Hinge Stud
200347C	17809	" " " " " " Set Screw
202666	17809	Needle Bar Rock Frame Position Bracket
200098F	17809	Needle Bar Rock Frame Position Bracket Screw
223690	16609	Needle Bar Rock Frame Rock Shaft
223691	16609	" " " " " " 223690 with 200387C and 210920
223692	16609	Needle Bar Rock Frame Rock Shaft Crank with 200029E

No.	Plate	Name
223693	17806	Needle Bar Rock Frame Rock Shaft Crank Connection with 203277
201407C	17806	Needle Bar Rock Frame Rock Shaft Crank Connection Hinge Screw (lower)
206758	17806	Needle Bar Rock Frame Rock Shaft Crank Connection Hinge Screw (lower) Oil Packing (wick)
201517E	17806	Needle Bar Rock Frame Rock Shaft Crank Connection Hinge Screw (lower) Nut
200833C	17806	Needle Bar Rock Frame Rock Shaft Crank Connection Hinge Screw (upper)
201522E	17806	Needle Bar Rock Frame Rock Shaft Crank Connection Hinge Screw (upper) Nut
202277	17806	Needle Bar Rock Frame Rock Shaft Crank Connection Oil Packing (wick)
200029E	16609	Needle Bar Rock Frame Rock Shaft Crank Pinch Screw
202668	16609	Needle Bar Rock Frame Slide Block
210920	16609	" " " " " " 202668 with 201141C
201141C	16609	Needle Bar Rock Frame Slide Block Screw Stud
200387C	16609	Needle Bar Rock Frame Slide Block Screw Stud Set Screw
236649	17810	Needle Holder, needles 1/8 in. apart and must be set diagonally, in gauges 1/32, 3/64, 1/16 and 3/32 in., with 201030F and two 200141F
223878	17810	Needle Holder, in gauges from 3/32 to 15/32 in., in steps of 1/32 in., with 201030F and two 200141F
223863	17810	Needle Holder, in 1/2 to 3/4 in., in steps of 1/32 in., with 201030F and two 200141F
223864	17810	Needle Holder, in gauges from 25/32 to 1-1/2 in., in steps of 1/32 in., with 201030F and two 200141F
201030F	17810	Needle Holder Screw
200141F	17810	" Set Screw
208566	17809	Presser Bar with 200074F
207072	17809	" " Bushing (2)
200352C	17809	" " " Set Screw (2)
202671	17809	" " Lifter
200653C	17809	" " " Hinge Screw
207963	17809	" " Lifting Releasing Lever Bracket
200975F	17809	Presser Bar Lifting Releasing Lever Bracket Guide Screw
206608	17809	Presser Bar Lifting Releasing Lever Bracket Spring
202337	17809	Presser Bar Position Guide
202338	17809	" " " " Lever with 200086F
200086F	17809	Presser Bar Position Guide Lever Pinch Screw

No.	Plate	Name
200352C	17809	Presser Bar Position Guide Set Screw
207965	16290	" " Spring (flat)
210949	17809	" " " Bracket with 200086C
200086C	17809	" " " " Pinch Screw
200538C	16290	" " " Regulating Screw
200948F	16290	" " " Support Screw
230795	16292	" Foot Hinge Pin
224126	16292	" " Plate, for 224127
223798	16296	" " " " 223799
224061	16296	" " " " 224062
224079	16296	" " " " 224080
224081	16296	" " " " 224082
224083	16296	" " " " 224084
223770	16296	" " " " 223771
224067	16297	" " " " 224068
224085	16297	" " " " 224086
224087	16297	" " " " 224088
224077	16297	" " " " 224078
224132	16296	" " " " 224133
224157	16292	" " " " 224158
200074F	17809	" " Screw
223309	16292	" " Shank
224127	16292	Presser Foot (hinged) complete, 50 needle hole, needles 1/8 in. apart, in gauges 1/32, 3/64 and 1/16 in., Nos. 223309, 224126 and 230795
224158	16292	Presser Foot (hinged) complete, 50 needle hole, in gauges 3/32 and 1/8 in., Nos. 223309, 224157 and 230795
223799	16296	Presser Foot (hinged) complete, 50 needle hole, in gauges 5/32 and 3/16 in., Nos. 223309, 223798 and 230795
224062	16296	Presser Foot (hinged) complete, 50 needle hole, in gauges 7/32, 1/4, 9/32 and 5/16 in., Nos. 223309, 224061 and 230795
224080	16296	Presser Foot (hinged) complete, 50 needle hole, in gauges 11/32, 3/8, 13/32 and 7/16 in., Nos. 223309, 224079 and 230795
224082	16296	Presser Foot (hinged) complete, 50 needle hole, in gauges 15/32, 1/2, 17/32 and 9/16 in., Nos. 223309, 224081 and 230795
224084	16296	Presser Foot (hinged) complete, 50 needle hole, in gauges 19/32 and 5/8 in., Nos. 223309, 224083 and 230795
223771	16296	Presser Foot (hinged) complete, 50 needle hole, in gauges 21/32, 11/16, 23/32 and 3/4 in., Nos. 223309, 223770, 230795
224133	16296	Presser Foot (hinged) complete, 50 needle hole, in gauges from 25/32 to 15/16 in., in steps of 1/32 in., Nos. 223309, 224132 and 230795

No.	Plate	Name
224068	16297	Presser Foot (hinged) complete, 50 needle hole, in gauges 31/32, 1, 1-1/32 and 1-1/16 in., Nos. 223309, 224067 and 230795
224086	16297	Presser Foot (hinged) complete, 50 needle hole, in gauges 1-3/32, 1-1/8, 1-5/32 and 1-3/16 in., Nos. 223309, 224085 and 230795
224088	16297	Presser Foot (hinged) complete, 50 needle hole, in gauges from 1-7/32 to 1-7/16 in., in steps of 1/32 in., Nos. 223309, 224087 and 230795
224078	16297	Presser Foot (hinged) complete, 50 needle hole, in gauges 1-15/32 and 1-1/2 in., Nos. 223309, 224077 and 230795
223881	17809	Take-up Lever
249398	17809	" " Driving Stud with 202277
202277	17809	" " " " Oil Packing (wick)
202400	17809	Take-up Lever Hinge Stud with 202423
202423	17809	" " " " Oil Packing (wick)
200383C	17809	Take-up Lever Hinge Stud Set Screw
202401	17809	" " Oiling Felt
200132E	17809	" " " " Screw
223702	16289	Tension Bracket with two each 201224B and 236060
200159F	16289	Tension Bracket Screw
223705	16289	Tension Bracket complete, Nos. 200978H, 201199F, 223702, 223703, 223706, 237174 two each 13710, 200309E, 204271, 223704, three 201572H and four 244048
244048	16289	Tension Disc
236060	16289	" " Position Pin
223703	16289	" Release Lever
235072	17809	" " " Rod
200309E	16289	" " " Screw
223704	16289	" " Plunger
204271	16289	" " Washer
13710	16289	" Spring
201224B	16289	" Stud
201572H	16289	" Thumb Nut
223706	16289	Thread Controller Disc
200978H	16289	" " " Screw
237174	16289	" " Spring
241360	16289	" " " Stop
200132E	16289	" " " Screw
201199F	16289	" " Stud with 204925
200061C	16289	" " " Set Screw
201572H	16289	" " " Thumb Nut
204925	16289	" " " Washer
224028	17811	" Guide
224040	16289	" "
210954	16289	" " (lower)

No.	Plate	Name
210955	16289	Thread Guide (upper)
200582H	16289	" " Screw (4)
240034	16289	" Retainer (2)
200366H	16289	" " Set Screw (2)
224059	16298	Throat Plate, for 224058, in gauges 1/32, 3/64 and 1/16 inch
224030	16254	Throat Plate, for 223637, in gauges 3/32, 1/8 and 5/32 inch
224031	16254	Throat Plate, for 223639, in gauges 3/16 and 7/32 inch
223884	16254	Throat Plate, for 223638, in gauges from 1/4 to 13/32 in., in steps of 1/32 inch
224033	16254	Throat Plate, for 223634, in gauges from 7/16 to 31/32 in., in steps of 1/32 inch
224035	16255	Throat Plate, for 223641, in gauges from 1 to 1-1/2 in., in steps of 1/32 inch
200161D	16254	Throat Plate Clamp Screw
203376	16254	" " Position Pin
691F	16254	" " Screw

ACCESSORIES

No.	Plate	Name
200157B	16290	Attachment Screw
203470	17803	Bobbin (10)
*225482	-----	" Case Screw Driver Blade
*225483	-----	" " " " Handle
225497	17620	Bobbin Case Screw Driver complete, Nos. 225482 and 225483
135 x 7	-----	Needles, twelve, size 14
224121	16644	Drip Pan, 20 in. long, with four 3/4 in. wire nails
41400	17620	Machine Rest Pin (wood)
120342	17620	Oiler (copper plated) with 120343
120343	17620	" Spout, 3-1/2 in. long
225498	17620	Screw Driver (7-1/4 in. long)
225554	17620	Wrench (steel)

BOBBIN WINDER

(SWINGING AUTOMATIC, RIGHT HAND)

259428	18312	Brake (leather)
259429	18312	" Clamp
200113F	18312	" " Screw
225453	18312	Frame with 202277 and 259660
225454	18312	" Hinge Pin
202277	18312	" Oil Packing (wick)
259660	18312	" " Well Washer
225455	18312	" Spring
225456	18312	" " Plunger
225368	18312	Pulley with 200380C
200380C	18312	" Set Screw
225381	18312	Spindle
225444	18312	Stop Latch
200056E	18312	" " Screw
225458	18312	" " Thumb Lever
225459	18312	" " " " Hinge Stud
225459	18312	" " " " Joint Stud
202478	18312	" " Trip Lever
200299H	18312	" " " " Hinge Screw
225461	18312	Tension Bracket with 201499H
200082D	18312	" " Screw
228026	18312	" " " " Washer
2102	18312	" Disc
13710	18312	" Spring
201499H	18312	" Stud
201572H	18312	" " Thumb Nut
225462	18312	Bobbin Winder Tension Bracket complete, Nos. 13710, 201572H, 225461 and two 2102
259430	18312	Bobbin Winder and Tension Bracket Base

No.	Plate	Name
259431	18312	Universal Bobbin Winder complete, Nos. 200056E, 200082D, 200113F, 200299H, 202478, 225368, 225381, 225444, 225453 to 225456, 225458, 225462, 228026, 259428 to 259430, two each 225459 and wood screws 3/4 in., No. 12, R.H.B.

KNEE LIFTER

228359	16643	Rock Lever with two 350231C
228360	16643	" " Bracket with 200347C and three wood screws 7/8 in., No. 12
228361	16643	Rock Lever Bracket 228360 with 228359, 228363, 228367, 228386 and 228455
228362	16643	Rock Lever Extension with 200529C
350231C	16643	" " " " Set Screw
228363	16643	" " Hinge Pin
228364	16643	" " Knee Plate with 350231C
228388	16643	" " " " Arm
350231C	16643	" " " " Set Screw
350231C	16643	" " " " Set Screw
228455	16643	" " Position Spring
228365	16643	" " Rod
200529C	16643	" " " " Set Screw
228386	16643	" " Spring
228367	16643	" " Stop Stud
200347C	16643	" " " " Set Screw
228368	16643	Knee Lifter complete, Nos. 228361, 228362, 228364, 228365 and 228388

(Other Knee Lifter Parts are listed with parts of machine head.)

THREAD UNWINDER
FOR THREE SPOOLS

225259	16257	Spool Rest (for one spool) (flat) with 201018C
225257	16257	Spool Rest (for two spools) (flat) with 201018C
150203	16257	Spool Rest Cushion (felt)
225388	16257	" " Rod
200383C	16257	" " " " Set Screw
201018C	16257	" " " " Set Screw
259658	16257	" Stand with 200383C
225391	16257	Thread Guide
201696H	16257	" " Lock Nut
225326	16257	" " Position Cup
225324	16257	" " Rod with 208AL and 225322
208AL	16257	" " " " Screw
225322	16257	" " " " Washer
259143	16257	Thread Unwinder (for three spools) complete, Nos. 201696H, 225257, 225259, 225324, 225326, 225388, 259658, three each 150203, 225391 and wood screws 7/8 in., No. 12

ATTACHMENT SLIDE PLATES

No.	Plate	Name
224144	16290	Attachment Slide Plate with 213479 and 236061
224146	16290	Attachment Slide Plate with 213479 and 236061, for use with depressed Throat Plates

BOBBIN WINDER

(SWINGING AUTOMATIC, RIGHT HAND)

FOR "V" BELT DRIVE

259428	18312	Brake (leather)
259429	18312	" Clamp
200113F	18312	" " Screw
225453	18312	Frame with 202277 and 259660
225454	18312	" Hinge Pin
202277	18312	" Oil Packing (wick)
259660	18312	" " Well Washer
225455	18312	" Spring
225456	18312	" " Plunger
259461	18312	Pulley with 200380C
200380C	18312	" Set Screw
225381	18312	Spindle
225444	18312	Stop Latch
200056E	18312	" " Screw
225458	18312	" " Thumb Lever
225459	18312	" " " " Hinge Stud
225459	18312	" " " " Joint Stud
202478	18312	" " Trip Lever
200299H	18312	" " " " Hinge Screw
225461	18312	Tension Bracket with 201499H
200082D	18312	" " Screw
228026	18312	" " " " Washer
2102	18312	" Disc
13710	18312	" Spring
201499H	18312	" Stud
201572H	18312	" " Thumb Nut
225462	18312	Bobbin Winder Tension Bracket complete, Nos.13710,201572H,225461 and two 2102
259662	18312	Bobbin Winder and Tension Bracket Base
259462	18312	Universal Bobbin Winder complete, Nos. 200056E,200082D,200113F,200299H, 202478,225381,225444,225453 to 225456,225458,225462,228026,259428, 259429,259461,259662,two each 225459 and wood screws 3/4 in.,No.12,R.H.B.

FEED DOGS

No.	Plate	Name
224058	16298	Feed Dog,50 needle hole,needles 1/8 in.apart,for needle sizes 14 and 15 in gauges 1/32,3/64 and 1/16 in., for 224059
223629	16254	Feed Dog,46 needle hole,for needle sizes 16 and 18,in gauges 1/8,5/32, 3/16 and 7/32 in.,for 224030
224014	16298	Feed Dog,46 needle hole,for needle sizes 16 and 18,in gauges 1/8,5/32, 3/16 and 7/32 in.,for 224038
223630	16254	Feed Dog,40 needle hole,for needle sizes 20 and 22,in gauges 1/8,5/32, 3/16 and 7/32 in.,for 224030
223637	16254	Feed Dog,50 needle hole,for needle sizes 14 and 15,in gauges 3/32 to 7/32 in.,in steps of 1/32 in.,for 224030
223889	16254	Feed Dog,53 needle hole,for needle sizes 12 and 13,in gauges 3/32 to 7/32 in.,in steps of 1/32 in.,for 224030
223639	16254	Feed Dog,50 needle hole,for needle sizes 14 and 15,in gauges 3/16 and 7/32 in.,for 224031
224015	16298	Feed Dog,50 needle hole,for needle sizes 14 and 15,in gauges 3/16 and 7/32 in.,for 224039
224007	16254	Feed Dog,53 needle hole,for needle sizes 12 and 13,in gauges 3/16 and 7/32 in.,for 224031
223890	16254	Feed Dog,53 needle hole,for needle sizes 12 and 13,in gauges from 1/4 to 13/32 in.,in steps of 1/32 in., for 223884
223628	16254	Feed Dog,46 needle hole,for needle sizes 16 and 18,in gauges from 1/4 to 13/32 in.,in steps of 1/32 in., for 223884
224009	16254	Feed Dog,46 needle hole,for needle sizes 16 and 18,in gauges from 1/4 to 13/32 in.,in steps of 1/32 in., for 224036
223631	16254	Feed Dog,40 needle hole,for needle sizes 20 and 22,in gauges from 1/4 to 13/32 in.,in steps of 1/32 in., for 223884
223638	16254	Feed Dog,50 needle hole,for needle sizes 14 and 15,in gauges from 1/4 to 13/32 in.,in steps of 1/32 in., for 223884

20

FEED DOGS

No.	Plate	Name	No.	Plate	Name
224057	16254	Feed Dog,50 needle hole,for needle sizes 14 and 15,in gauges from 1/4 to 13/32 in.,in steps of 1/32 in.,for 224036	224055	16298	Feed Dog,46 needle hole,for needle sizes 16 and 18,in gauges from 7/8 to 1-1/2 in.,in steps of 1/32 in.,for 224056
224010	16254	Feed Dog,50 needle hole,for needle sizes 14 and 15,in gauges from 7/16 to 27/32 in.,in steps of 1/32 in.,for 224057 and 224034	224008	16255	Feed Dog,40 needle hole,for needle sizes 20 and 22,in gauges from 1 to 1-1/2 in.,in steps of 1/32 in.,for 224034
224011	16254	Feed Dog,46 needle hole,for needle sizes 16 and 18,in gauges from 7/16 to 27/32 in.,in steps of 1/32 in.,for 224037 and 224054	NEEDLE HOLDERS		
223632	16254	Feed Dog,46 needle hole,for needle sizes 16 and 18,in gauges from 7/16 to 31/32 in.,in steps of 1/32 in.,for 224033	236649	17810	Needle Holder,needles 1/8 in.apart and must be set diagonally,in gauges 1/32,3/64,1/16 and 3/32 in.,with 201030F and two 200141F
223633	16254	Feed Dog,40 needle hole,for needle sizes 20 and 22,in gauges from 7/16 to 31/32 in.,in steps of 1/32 in.,for 224033	236650	17810	Needle Holder,needles 3/32 in.apart and must be set diagonally,in gauges 1/32,3/64 and 1/16 in.,with 201030F and two 200141F
223634	16254	Feed Dog,50 needle hole,for needle sizes 14 and 15,in gauges from 7/16 to 31/32 in.,in steps of 1/32 in.,for 224033	223878	17810	Needle Holder,in gauges from 3/32 to 15/32 in.,in steps of 1/32 in.,with 201030F and two 200141F
223891	16254	Feed Dog,53 needle hole,for needle sizes 12 and 13,in gauges from 7/16 to 31/32 in.,in steps of 1/32 in.,for 224033	223863	17810	Needle Holder,in gauges from 1/2 to 3/4 in.,in steps of 1/32 in.,with 201030F and two 200141F
223635	16255	Feed Dog,46 needle hole,for needle sizes 16 and 18,in gauges from 1 to 1-1/2 in.,in steps of 1/32 in.,for 224035	223864	17810	Needle Holder,in gauges from 25/32 to 1-1/2 in.,in steps of 1/32 in.,with 201030F and two 200141F
223636	16255	Feed Dog,40 needle hole,for needle sizes 20 and 22,in gauges from 1 to 1-1/2 in.,in steps of 1/32 in.,for 224035	PRESSER FEET		
223641	16255	Feed Dog,50 needle hole,for needle sizes 14 and 15,in gauges from 1 to 1-1/2 in.,in steps of 1/32 in.,for 224035	230795	16292	Presser Foot Hinge Pin
224012	16255	Feed Dog,50 needle hole,for needle sizes 14 and 15,in gauges from 1 to 1-1/2 in.,in steps of 1/32 in.,for 224029	224175	16291	" " Needle Guide
224013	16255	Feed Dog,46 needle hole,for needle sizes 16 and 18,in gauges from 1 to 1-1/2 in.,in steps of 1/32 in.,for 224029	200172H	16291	" " " " Screw
224006	16255	Feed Dog,40 needle hole,for needle sizes 20 and 22,in gauges from 1 to 1-1/2 in.,in steps of 1/32 in.,for 224029	224126	16292	" " Plate,for 224127
223640	16255	Feed Dog,46 needle hole,for needle sizes 16 and 18,in gauges from 7/8 to 1-1/2 in.,in steps of 1/32 in.,for 224032	224186	16292	" " " " 224187
			224157	16292	" " " " 224158
			224188	16292	" " " " 224189
			223758	16292	" " " " 223759
			224173	16292	" " " " 224174
			224168	16292	" " " " 224169
			224065	16293	" " " " 224066
			224190	16293	" " " " 224191
			224171	16293	" " " " 224172
			224183	16293	" " " " 224184
			224071	16293	" " " " 224072
			224073	16293	" " " " 224074
			224075	16293	" " " " 224076
			224181	16293	" " " " 224182
			224163	16293	" " " " 224164
			223796	16293	" " " " 223797

PRESSER FEET

No.	Plate	Name
223694	16294	Presser Foot Plate, for
224155	16294	" " " "
223754	16294	" " " "
223756	16294	" " " "
224063	16294	" " " "
224069	16294	" " " "
223696	16295	" " " "
224128	16295	" " " "
224130	16295	" " " "
223772	16295	" " " "
225284	16295	" " " "
224134	16295	" " " "
223798	16296	" " " "
224061	16296	" " " "
223746	16296	" " " "
224079	16296	" " " "
223698	16296	" " " "
224081	16296	" " " "
223748	16296	" " " "
224083	16296	" " " "
223744	16296	" " " "
223770	16296	" " " "
223750	16296	" " " "
224132	16296	" " " "
223785	16296	" " " "
224067	16297	" " " "
224085	16297	" " " "
224087	16297	" " " "
224077	16297	" " " "
224124	16297	" " " "
224177	16297	" " " "
224179	16297	" " " "
223309	16292	Presser Foot Shank
229541	16291	" " Spring Guide in gauges from 1/8 to 1/2 in., in steps of 1/32 in., for 224165
200172H	16291	Presser Foot Spring Guide Screw
224060	16291	" " for 1/32 in. gauge, needles 1/8 in. apart
224166	16291	Presser Foot, 50 needle hole, in gauges from 1/8 to 1/2 in., in steps of 1/32 inch
224192	16291	Presser Foot, 53 needle hole, in gauges from 5/16 to 9/16 in., in steps of 1/32 inch
224185	16291	Presser Foot, 50 needle hole, in gauges from 1/8 to 5/16 in., in steps of 1/32 in., for strip work
224170	16291	Presser Foot, 46 needle hole, in gauges from 9/32 to 1-1/2 in., in steps of 1/32 in., for strip work
224165	16291	Presser Foot, 53 needle hole, in gauges from 1/8 to 1/2 in., in steps of 1/32 in., with 200172H and 229541
224176	16291	Presser Foot, adjustable from 3/32 to 7/32 in., with two 224175 and four 200172H, for inside staying

PRESSER FEET

No.	Plate	Name
224127	16292	Presser Foot (hinged) complete, 50 needle hole, needles 1/8 in. apart, in gauges 1/32, 3/64, 1/16 and 3/32 in., Nos. 223309, 224126 and 230795
224187	16292	Presser Foot (hinged) complete, 53 needle hole, in gauges 3/32, 1/8, 5/32 and 3/16 in., Nos. 223309, 224186 and 230795
224158	16292	Presser Foot (hinged) complete, 50 needle hole, in gauges 3/32, 1/8, 5/32 and 3/16 in., Nos. 223309, 224157 and 230795
224189	16292	Presser Foot (hinged) complete, 40 needle hole, in gauges 1/8, 5/32, and 3/16 in., Nos. 223309, 224188 and 230795
223759	16292	Presser Foot (hinged) complete, 50 needle hole, in gauges 7/32, 1/4, 9/32 and 5/16 in., Nos. 223309, 223758 and 230795, for stitching front steels in corsets
224174	16292	Presser Foot (hinged) complete, 50 needle hole, in gauges from 3/16 to 5/16 in., in steps of 1/32 in., Nos. 223309, 224173 and 230795
224169	16292	Presser Foot (hinged) complete, 50 needle hole, in gauges from 11/32 to 5/8 in., in steps of 1/32 in., Nos. 223309, 224168 and 230795
224066	16293	Presser Foot (hinged) complete, 53 needle hole, in gauges 3/32, 1/8, 5/32 and 3/16 in., Nos. 223309, 224065 and 230795, for lap seam felling
224191	16293	Presser Foot (hinged) complete, 50 needle hole, in gauges 1/8, 5/32 and 3/16 in., Nos. 223309, 224190 and 230795
224172	16293	Presser Foot (hinged) complete, 53 needle hole, in gauges 1/8, 5/32 and 3/16 in., Nos. 223309, 224171 and 230795
224184	16293	Presser Foot (hinged) complete, 53 needle hole, in gauges 1/8, 5/32 and 3/16 in., Nos. 223309, 224183 and 230795, for felling
224072	16293	Presser Foot (hinged) complete, 50 needle hole, in gauges 7/32, 1/4, 9/32 and 5/16 in., Nos. 223309, 224071 and 230795
224074	16293	Presser Foot (hinged) complete, 50 needle hole, in gauges 11/32, 3/8, 13/32 and 7/16 in., Nos. 223309, 224073 and 230795
224076	16293	Presser Foot (hinged) complete, 50 needle hole, in gauges 21/32, 11/16, 23/32 and 3/4 in., Nos. 223309, 224075 and 230795

No.	Plate	Name
224182	16293	Presser Foot (hinged) complete, 53 needle hole, in gauges 21/32, 11/16 23/32 and 3/4 in., Nos. 223309, 224181 and 230795
224164	16293	Presser Foot (hinged) complete, 50 needle hole, in gauges from 15/32 to 5/8 in., in steps of 1/32 in., Nos. 223309, 224163 and 230795
223797	16293	Presser Foot (hinged) complete, 50 needle hole, in gauges from 5/16 to 1-1/2 in., in steps of 1/32 in., Nos. 223309, 223796 and 230795, for shirt facing
223695	16294	Presser Foot (hinged) complete, 50 needle hole, in gauges from 1/8 to 5/16 in., in steps of 1/32 in., Nos. 223309, 223694 and 230795, for lap seam felling
224156	16294	Presser Foot (hinged) complete, 53 needle hole, in gauges from 1/8 to 5/16 in., in steps of 1/32 in., Nos. 223309, 224155 and 230795, for lap seam felling
223755	16294	Presser Foot (hinged) complete, 50 needle hole, in gauges 11/32, 3/8, 13/32 and 7/16 in., Nos. 223309, 223754 and 230795, for lap seam felling
223757	16294	Presser Foot (hinged) complete, 50 needle hole, in gauges 1/2, 17/32 and 9/16 in., Nos. 223309, 223756 and 230795, for lap seam felling
224064	16294	Presser Foot (hinged) complete, 50 needle hole, in gauges from 15/32 to 5/8 in., in steps of 1/32 in., Nos. 223309, 224063 and 230795, for lap seam felling
224070	16294	Presser Foot (hinged) complete, 50 needle hole, in gauges 21/32, 11/16, 23/32 and 3/4 in., Nos. 223309, 224069 and 230795, for lap seam felling
223697	16295	Presser Foot (hinged) complete, 40 needle hole, in gauges 1/4, 9/32 and 5/16 in., Nos. 223309, 223696 and 230795, for overall felling
224129	16295	Presser Foot (hinged) complete, 40 needle hole, in gauges from 1/4 to 7/16 in., in steps of 1/32 in., Nos. 223309, 224128 and 230795
224131	16295	Presser Foot (hinged) complete, 40 needle hole, in gauges from 15/32 to 5/8 in., in steps of 1/32 in., Nos. 223309, 224130 and 230795
223773	16295	Presser Foot (hinged) complete, 50 needle hole, in gauges from 1/8 to 5/16 in., in steps of 1/32 in., Nos. 223309, 223772 and 230795, for lap seam felling

No.	Plate	Name
225285	16295	Presser Foot (hinged) complete, 50 needle hole, in gauges from 11/32 to 1-1/2 in., in steps of 1/32 in., Nos. 223309, 225284 and 230795
224135	16295	Presser Foot (hinged) complete, 46 needle hole, in gauges from 1/8 to 5/16 in., in steps of 1/32 in., Nos. 223309, 224134 and 230795, for patch pocket work
223799	16296	Presser Foot (hinged) complete, 50 needle hole, in gauges 5/32 and 3/16 in., Nos. 223309, 223798 and 230795
224062	16296	Presser Foot (hinged) complete, 50 needle hole, in gauges 7/32, 1/4, 9/32 and 5/16 in., Nos. 223309, 224061 and 230795
223747	16296	Presser Foot (hinged) complete, 46 needle hole, in gauges 7/32, 1/4, 9/32 and 5/16 in., Nos. 223309, 223746 and 230795
224080	16296	Presser Foot (hinged) complete, 50 needle hole, in gauges 11/32, 3/8, 13/32 and 7/16 in., Nos. 223309, 224079 and 230795
223699	16296	Presser Foot (hinged) complete, 46 needle hole, in gauges 11/32, 3/8, 13/32 and 7/16 in., Nos. 223309, 223698 and 230795
224082	16296	Presser Foot (hinged) complete, 50 needle hole, in gauges 15/32, 1/2, 17/32 and 9/16 in., Nos. 223309, 224081 and 230795
223749	16296	Presser Foot (hinged) complete, 46 needle hole, in gauges 15/32, 1/2, 17/32 and 9/16 in., Nos. 223309, 223748 and 230795
224084	16296	Presser Foot (hinged) complete, 50 needle hole, in gauges 19/32 and 5/8 in., Nos. 223309, 224083 and 230795
223745	16296	Presser Foot (hinged) complete, 46 needle hole, in gauges 19/32 and 5/8 in., Nos. 223309, 223744 and 230795
223771	16296	Presser Foot (hinged) complete, 50 needle hole, in gauges 21/32, 11/16, 23/32 and 3/4 in., Nos. 223309, 223770 and 230795
223751	16296	Presser Foot (hinged) complete, 46 needle hole, in gauges 21/32, 11/16, 23/32 and 3/4 in., Nos. 223309, 223750 and 230795
224133	16296	Presser Foot (hinged) complete, 50 needle hole, in gauges from 25/32 to 15/16 in., in steps of 1/32 in., Nos. 223309, 224132 and 230795
223786	16296	Presser Foot (hinged) complete, 46 needle hole, in gauges from 25/32 to 15/16 in., in steps of 1/32 in., Nos. 223309, 223785 and 230795

PRESSER FEET

No.	Plate	Name
224068	16297	Presser Foot (hinged) complete, 50 needle hole, in gauges 31/32, 1, 1-1/32 and 1-1/16 in., Nos. 223309, 224067 and 230795
224086	16297	Presser Foot (hinged) complete, 50 needle hole, in gauges 1-3/32, 1-1/8, 1-5/32 and 1-3/16 in., Nos. 223309, 224085 and 230795
224088	16297	Presser Foot (hinged) complete, 50 needle hole, in gauges from 1-7/32 to 1-7/16 in., in steps of 1/32 in., Nos. 223309, 224087 and 230795
224078	16297	Presser Foot (hinged) complete, 50 needle hole, in gauges 1-15/32 and 1-1/2 in., Nos. 223309, 224077 and 230795
224125	16297	Presser Foot (hinged) complete, 46 needle hole, in gauges 1-15/32 and 1-1/2 in., Nos. 223309, 224124 and 230795
224180	16297	Presser Foot (hinged) complete, 46 needle hole, in gauges 1-3/32, 1-1/8, 1-5/32 and 1-3/16 in., Nos. 223309, 224179 and 230795
224178	16297	Presser Foot (hinged) complete, 40 needle hole, in gauges from 1-7/32 to 1-7/16 in., in steps of 1/32 in., Nos. 223309, 224177 and 230795
248450	16291	Presser Foot Plate
226080	16291	" " " Spring
248455	16291	" " " Shank
248451	16291	Presser Foot (hinged) complete, 53 needle hole, in gauges 3/16, 7/32 and 1/4 in., Nos. 226080, 230795, 248450 and 248455
201031F	16291	Presser Foot Screw
248452	16291	" " " Spring Guide
248453	16291	" " " " Bracket with 201535E and 350422J
350422J	16291	Presser Foot Spring Guide Screw Stud
201535E	16291	" " " " " " " Nut
248454	16291	Presser Foot (hinged) with Spring Guide complete, in gauges 3/16, 7/32 and 1/4 in., Nos. 201031F and 248451 to 248453
248457	16291	Presser Foot, 53 needle hole, in 3/16, 7/32 and 1/4 in. gauge
248458	16291	Presser Foot with Spring Guide complete, in gauges 3/16, 7/32 and 1/4 in., Nos. 201031F, 248452, 248453 and 248457

THROAT PLATES

No.	Plate	Name
224059	16298	Throat Plate, for 224058, in gauges 1/32 3/64 and 1/16 inch
224038	16298	Throat Plate with two each 201132D and 237318, for 224014, in gauges 1/8, 5/32, 3/16 and 7/32 inch
224039	16298	Throat Plate with two each 201132D and 237318, for 224015, in gauges 3/16 and 7/32 inch
224030	16254	Throat Plate, for 223629, 223630, 223637 and 223889, in gauges from 3/32 to 7/32 in., in steps of 1/32 inch
224031	16254	Throat Plate, for 223639 and 224007, in gauges 3/16 and 7/32 inch
223884	16254	Throat Plate, for 223628, 223631, 223638 and 223890, in gauges from 1/4 to 13/32 in., in steps of 1/32 inch
224036	16254	Throat Plate, for 224009 and 224057, in gauges from 1/4 to 13/32 in., in steps of 1/32 inch
224053	16298	Throat Plate with two each 201132D and 237318, for 224009, in gauges from 1/4 to 13/32 in., in steps of 1/32 inch
224054	16298	Throat Plate with two each 201132D and 237318, for 224010 and 224011, in gauges from 7/16 to 27/32 in., in steps of 1/32 inch
224033	16254	Throat Plate, for 223632 to 223634 and 223891, in gauges from 7/16 to 31/32 in., in steps of 1/32 inch
224037	16254	Throat Plate, for 224010 and 224011, in gauges from 7/16 to 27/32 in., in steps of 1/32 inch
224035	16255	Throat Plate, for 223635, 223636, 223641, in gauges from 1 to 1-1/2 in., in steps of 1/32 inch
224029	16255	Throat Plate, for 224006, 224012 and 224013, in gauges from 1 to 1-1/2 in., in steps of 1/32 inch
224032	16255	Throat Plate, for 223640, in gauges from 7/8 to 1-1/2 in., in steps of 1/32 inch
224056	16298	Throat Plate with two each 201132D and 237318, for 224055, in gauges from 7/8 to 1-1/2 in., in steps of 1/32 inch
224034	16255	Throat Plate, for 224008, in gauges from 1 to 1-1/2 in., in steps of 1/32 inch
237318	16298	Throat Plate Edge Guide
201132D	16298	" " " " " Screw

ARM CAP AND THREAD GUIDE

No.	Plate	Arm
224045	16300	Arm Cap
223604	16300	" " Thread Guide
223605	16300	" " " " 223604 with 210991 and two 200179H
210991	16300	Arm Cap Thread Guide- Latch Spring
200179H	16300	" " " " " " Screw
200172H	16300	" " " " " " Screw
224046	16300	Arm Cap and Thread Guide complete, Nos. 223605, 224045 and two 200172H

FOOT LIFTER

PARTS REQUIRED FOR CHANGING FROM KNEE
LIFTER TO FOOT LIFTER

223733	16290	Foot Lifter Lifting Lever Extension
200082D	16290	" " " " " " Screw(?)
227561	16290	" " " " " " Spring
200835D	16290	" " " " " " Stop Screw

FOOT LIFTER

227952	17620	Lever with 227954
227678	17620	" Chain, 48 in. long with 202784
227954	17620	" " Hook (lower)
202784	17620	" " " (upper)
225016	17620	" Hinge Pin
227953	17620	" Stand with two wood screws 1 in., No. 12
227955	17620	Foot Lifter Lever complete, Nos. 225016, 227678, 227952 and 227953

STRIP REELS

ATTACHED TO THE TOP OF THE ARM

226199	17800	Strip Reel Disc (6 in. diam.) with 225980
226198	17800	Strip Reel Disc (9 in. diam.) with 225980
225980	17800	Strip Reel Disc Base
227113	17800	" " " " Rod (lower) with Strip Guide
227115	17800	Strip Reel Disc Rod (upper) with Strip Guide
227116	17800	Strip Reel Disc Rod Collar
227210	17800	" " " " " " 227116 with 200731E and 227327
200731E	17800	Strip Reel Disc Rod Collar Wing Screw

No.	Plate	Name
201484C	17800	Strip Reel Disc Rod Set Screw
227327	17800	" " " " Tension Spring (spiral)
227108	17800	Strip Reel Support with two 201484C
200017C	17800	" " " " Screw
227212	17800	Double Strip Reel complete, Nos. 200017C 227108, 227113, 227115, two each 226198, 226199 and 227210

STRIP REEL

ATTACHED TO THE UNDER SIDE OF THE BENCH

226199	17800	Strip Reel Disc (6 in. diam.) with 225980
225980	17800	Strip Reel Disc Base
227148	17800	" " " " Rod
227116	17800	" " " " Collar
227210	17800	" " " " " " 227116 with 200731E and 227327
200731E	17800	Strip Reel Disc Rod Collar Wing Screw
201484C	17800	" " " " Set Screw
227327	17800	" " " " Tension Spring (spiral)
227138	17800	Strip Reel Support with 201484C
227139	17800	Strip Reel complete, Nos. 227138, 227148, 227210, two each 226199 and wood screws 1 in., No. 10

STRIP TENSION DEVICE

231363	17801	Strip Tension Base
231364	17801	" " " " Plate with 200457D, 201599H and two 200383C
200457D	17801	Strip Tension Plate Adjusting Thumb Screw
201599H	17801	Strip Tension Plate Adjusting Thumb Screw Nut
200383C	17801	Strip Tension Plate Set Screw
231365	17801	" " " " Shaft
231366	17801	" " " " Spring
231367	17801	" " " " " " Adjusting Collar with 200380C
200380C	17801	Strip Tension Plate Spring Adjusting Collar Set Screw
231368	17801	Strip Tension Strip Guide
200162D	17801	" " " " " " Screw
231369	17801	Strip Tension Device complete, (adjust- able for strips up to 3 in., in width) Nos. 231363 to 231367, two each 200162D, 231368 and wood screws 1 in., No. 12H

MISCELLANEOUS PARTS

USED IN CONJUNCTION WITH THREAD UNWINDER

No.	Plate	Name
60913	16257	Spool Weight with 60914
60914	16257	" " Center Pin
225377	16257	" Wire (for small spools)
27739	16257	Thread Cone (wood)
225390	16257	" " Holder

<p>223633-40 223632-46 223634-50 223891-53</p> <p>224033</p> <p>15=1</p> <p>5-33724 TS</p> <p>7/16 to 31/32 In steps of 1/32 inch</p>	<p>223631-40 223628-46 223638-50 223890-53</p> <p>223884</p> <p>15=1</p> <p>1/4 to 13/32 In steps of 1/32 inch</p>	<p>223630-40 223629-46 223637-50 223889-53</p> <p>224030</p> <p>203376</p> <p>200106E</p> <p>200161D</p> <p>691F</p> <p>3/32-1/8-5/32-3/16-7/32</p> <p>224037</p> <p>15=1</p> <p>7/16 to 27/32 In steps of 1/32 inch</p>	<p>224009-46 224057-50</p> <p>224036</p> <p>15=1</p> <p>1/4 to 13/32 In steps of 1/32 inch</p>	<p>223642-46 223639-50 224007-53</p> <p>224031</p> <p>15=1</p> <p>3/16-7/32</p>	<p>224011-46 224010-50</p> <p>224037</p> <p>15=1</p>
---	--	--	--	---	--

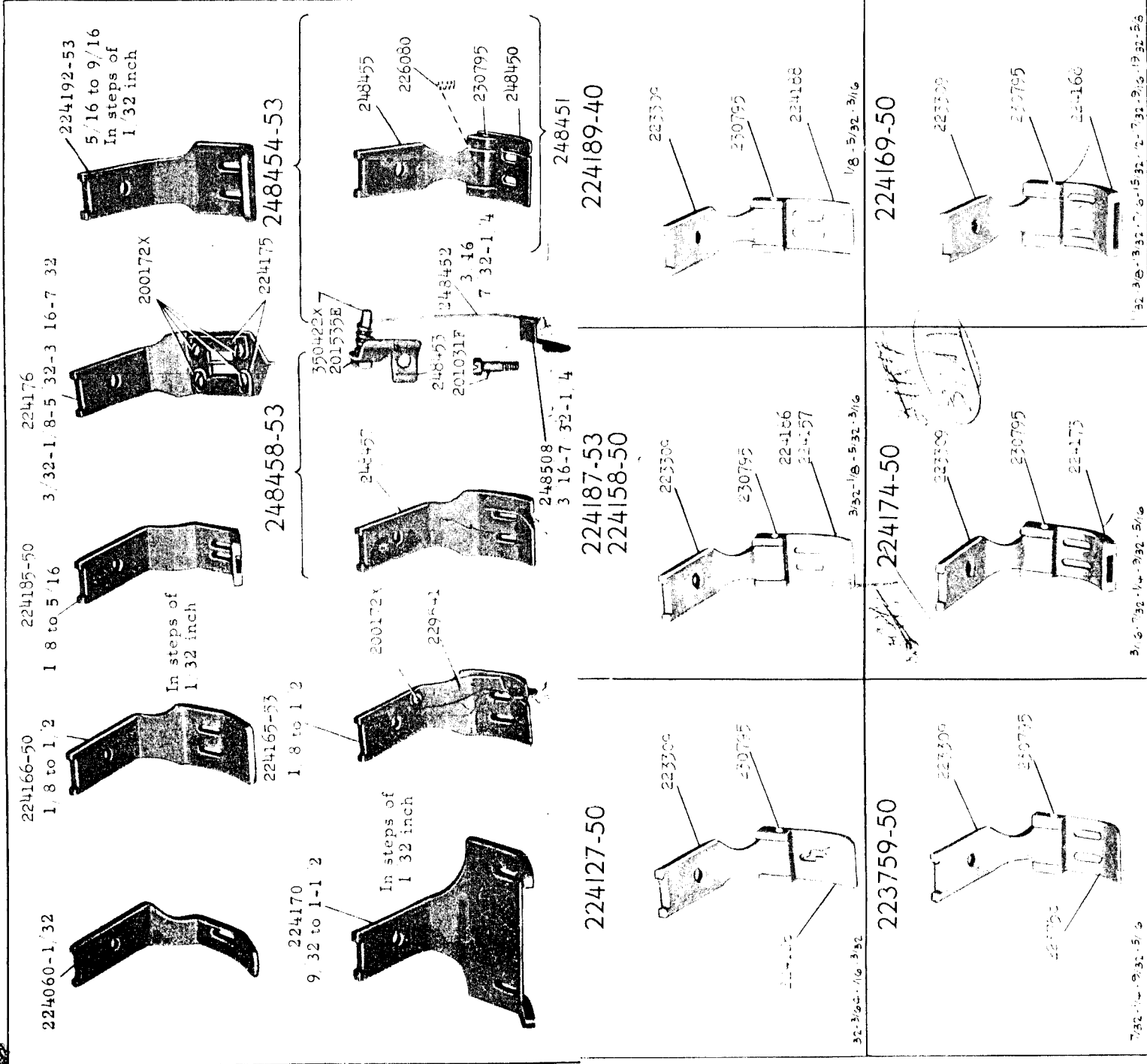

<p>224066-53</p> <p>223309 230795 224065</p> <p>3/32 - 7/8 - 5/32 - 3/16</p>	<p>224191-50 224172-53</p> <p>223309 230795 224190 224171</p> <p>1/8 - 5/32 - 3/16</p>	<p>224184-53</p> <p>223309 230795 224185</p> <p>1/8 - 5/32 - 3/16</p>	<p>224072-50</p> <p>223309 230795 224071</p> <p>7/32 - 1/4 - 9/32 - 5/16</p>
<p>224164-50</p> <p>223309 230795</p> <p>224163</p> <p>15/32 TO 5/8 IN STEPS OF 1/32"</p>	<p>224074-50</p> <p>223309 230795 224073</p> <p>11/32 - 3/8 - 3/32 - 7/16</p>	<p>224076-50 224182-53</p> <p>223309 230795 224075 224181</p> <p>21/32 - 1/16 - 23/32 - 3/4</p>	<p>223797-50</p> <p>223309 230795 223796</p> <p>5/16" TO 1 1/2" IN STEPS OF 1/32"</p>
<p>223695-50 224156-53</p> <p>223309 230795 223694 224155</p> <p>1/8 - 5/32 - 3/16 - 7/32 - 1/4 - 9/32 - 5/16</p>	<p>223755-50</p> <p>223309 230795 223754</p> <p>11/32 - 3/8 - 3/32 - 7/16</p>	<p>223757-50</p> <p>223309 230795 223756</p> <p>1/2 - 17/32 - 9/16</p>	<p>224070-50</p> <p>223309 230795 224069</p> <p>21/32 - 1/16 - 23/32 - 3/4</p>

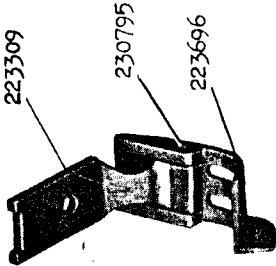
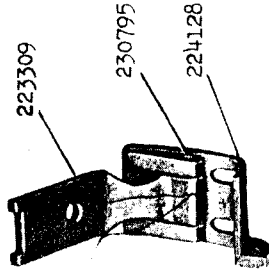
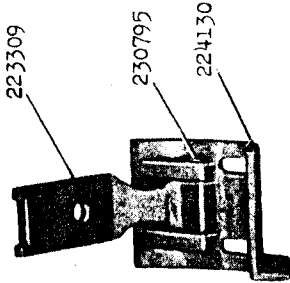
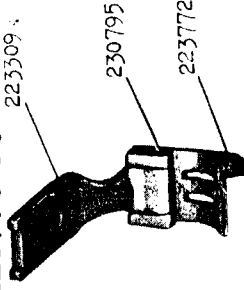
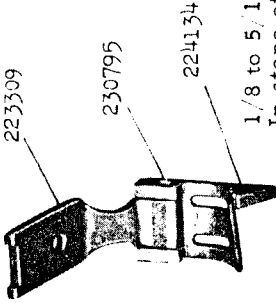
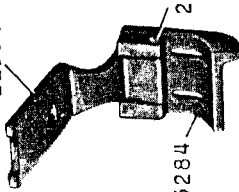
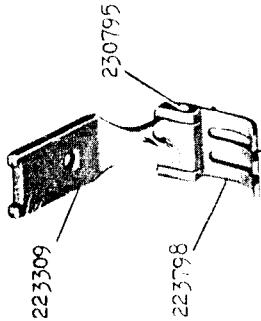
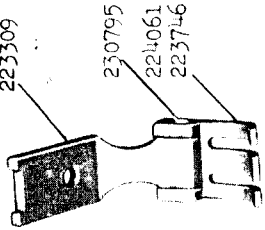
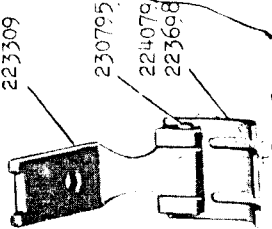
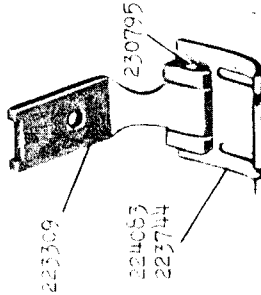
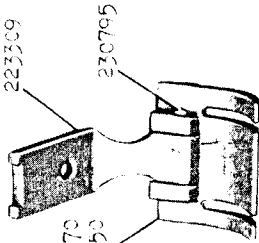
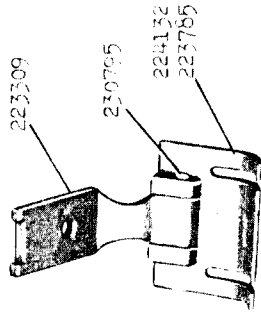
<p>223697-40 1/4 to 7/16 In steps of 1/32 inch</p> 	<p>224129-40 1/4 to 7/16 In steps of 1/32 inch</p> 	<p>224131-40 15/32 to 5/8 In steps of 1/32 inch</p> 
<p>223773-50 1/8 to 5/16 In steps of 1/32 inch</p> 	<p>224135-46 1/8 to 5/16 In steps of 1/32 inch</p> 	<p>225285-50 11/32 to 1-1/2 In steps of 1/32 inch</p> 
<p>223799-50 5/32 - 3/16</p> 	<p>224062-50 223747-46 7/32 - 1/2 - 9/32 - 5/16</p> 	<p>224080-50 223699-46 11/32 - 3/8 - 13/32 - 7/16</p> 
<p>224084-50 223745-46 19/32 - 5/8</p> 	<p>223771-50 223751-46 2/32 - 1/16 - 23/32 - 3/4</p> 	<p>224133-50 223786-46 25/32 - 3/16 - 27/32 - 7/8 - 19/32 - 5/16</p> 

541001

224068-50

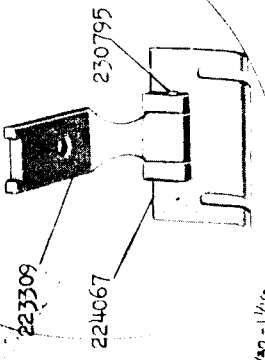

1 5/32 - 1 1/32 - 1 1/16

224078-50
224125-46

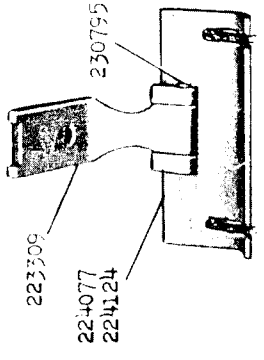

1 5/32 - 1 1/2

224086-50

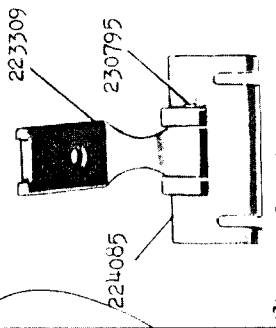

1 3/32 - 1 1/8 - 1 5/32 - 1 3/16

224180-46

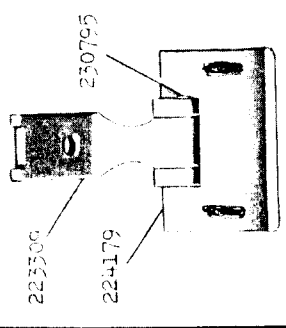

1 3/32 - 1 1/8 - 1 5/32 - 1 3/16

224088-50

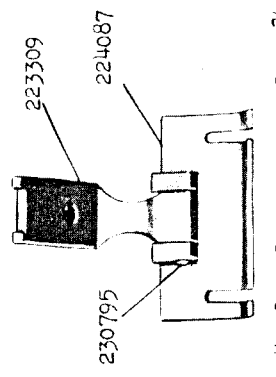

1 7/32 - 1 1/4 - 1 9/32 - 1 5/16 - 1 1/32 - 1 3/8 - 1 1 3/32 - 1 7/16

224178-40

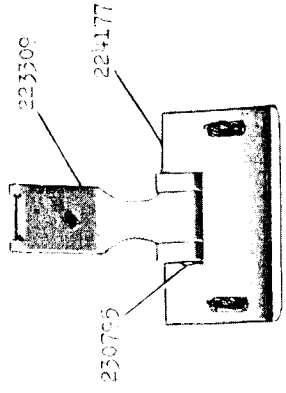

1 7/32 - 1 1/4 - 1 9/32 - 1 5/16 - 1 1/32 - 1 3/8 - 1 1 3/32 - 1 7/16

200161D
224059

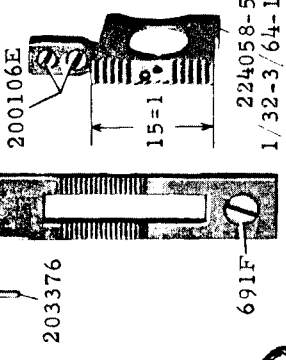

203376
200106E
15=1
224058-50
1/32-3/64-1/16

1 3/32 - 1 1/8 - 1 5/32 - 1 3/16

224014-46

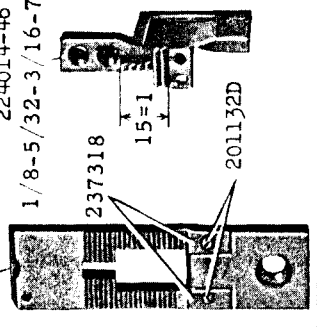

1 8-5/32-3/16-7/32
237318
15=1
201132D

224058-50
1/32-3/64-1/16

691F

16298 - 5/8

224053

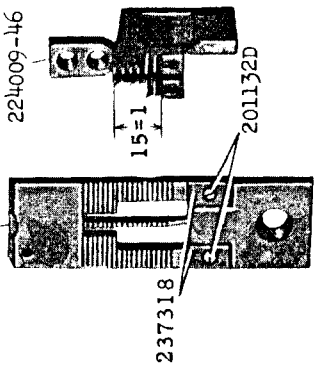

224009-46
15=1
201132D
237318

224054
224010-50
224011-46

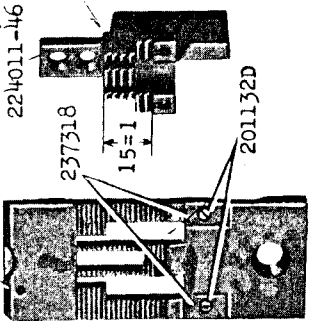

237318
15=1
201132D

224056

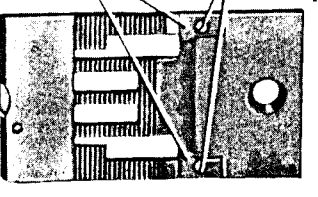

224055-46
237318
201132D
15=1

1/4 to 13/32
In steps of 1/32 inch

7/16 to 27/32
In steps of 1/32 inch

7/8 to 1-1/2
In steps of 1/32 inch

16300 - 2/3

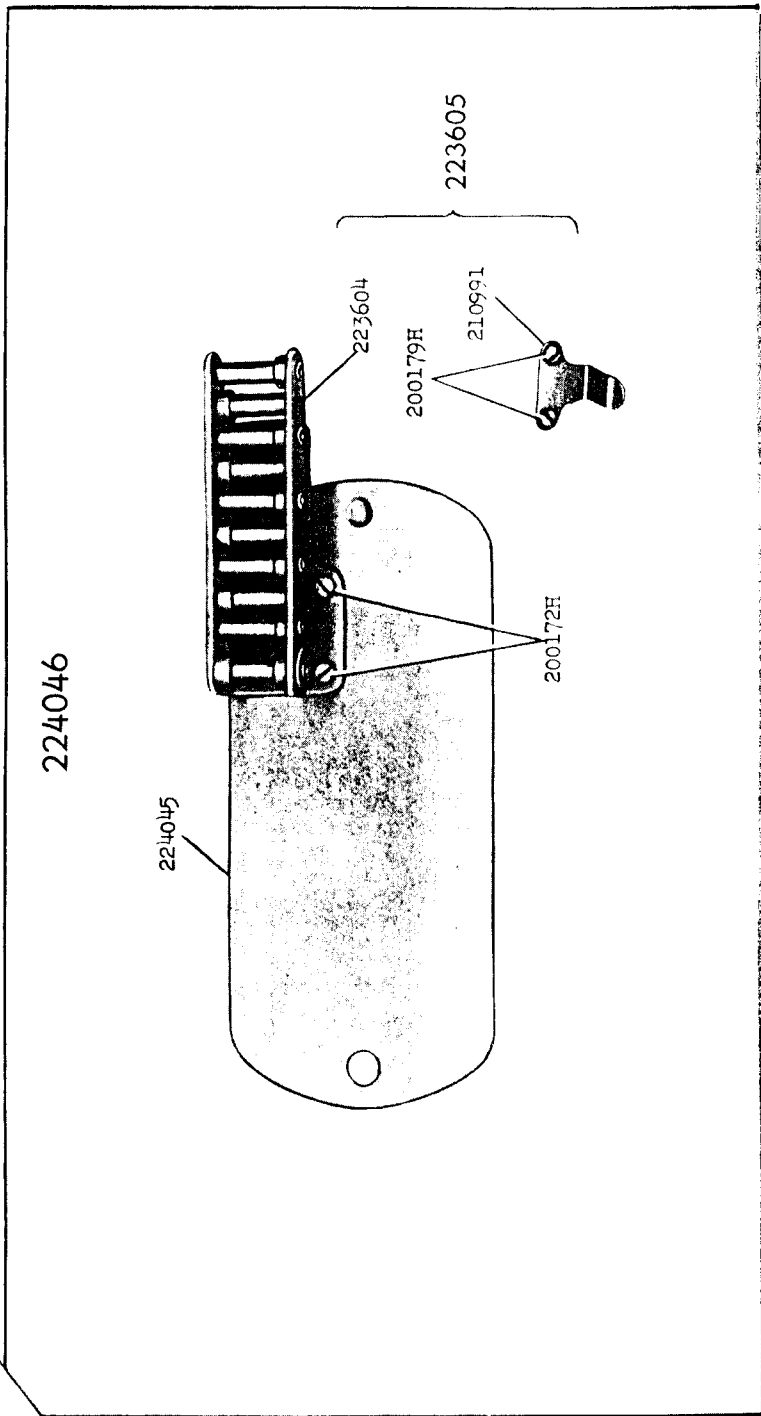

16609 - 1/2

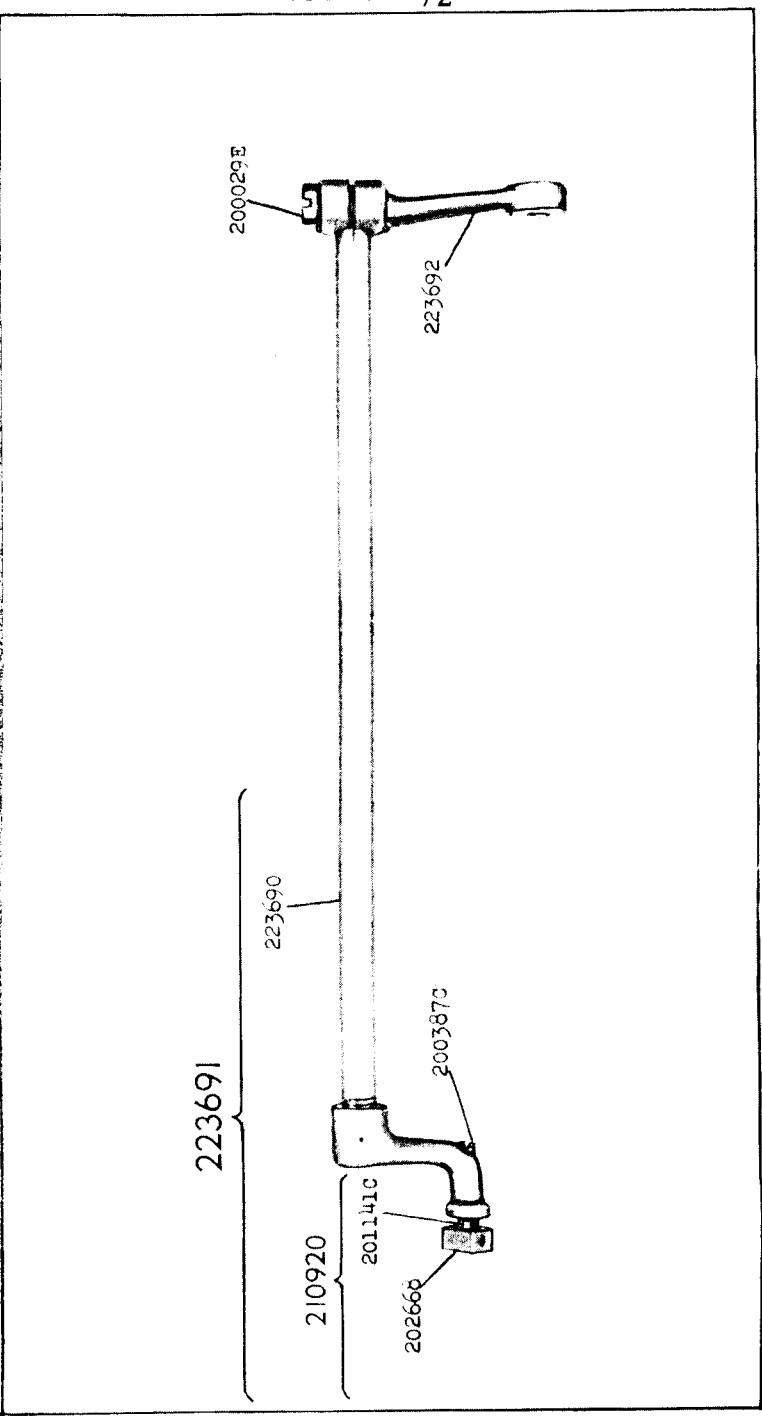

16643 - 3/8

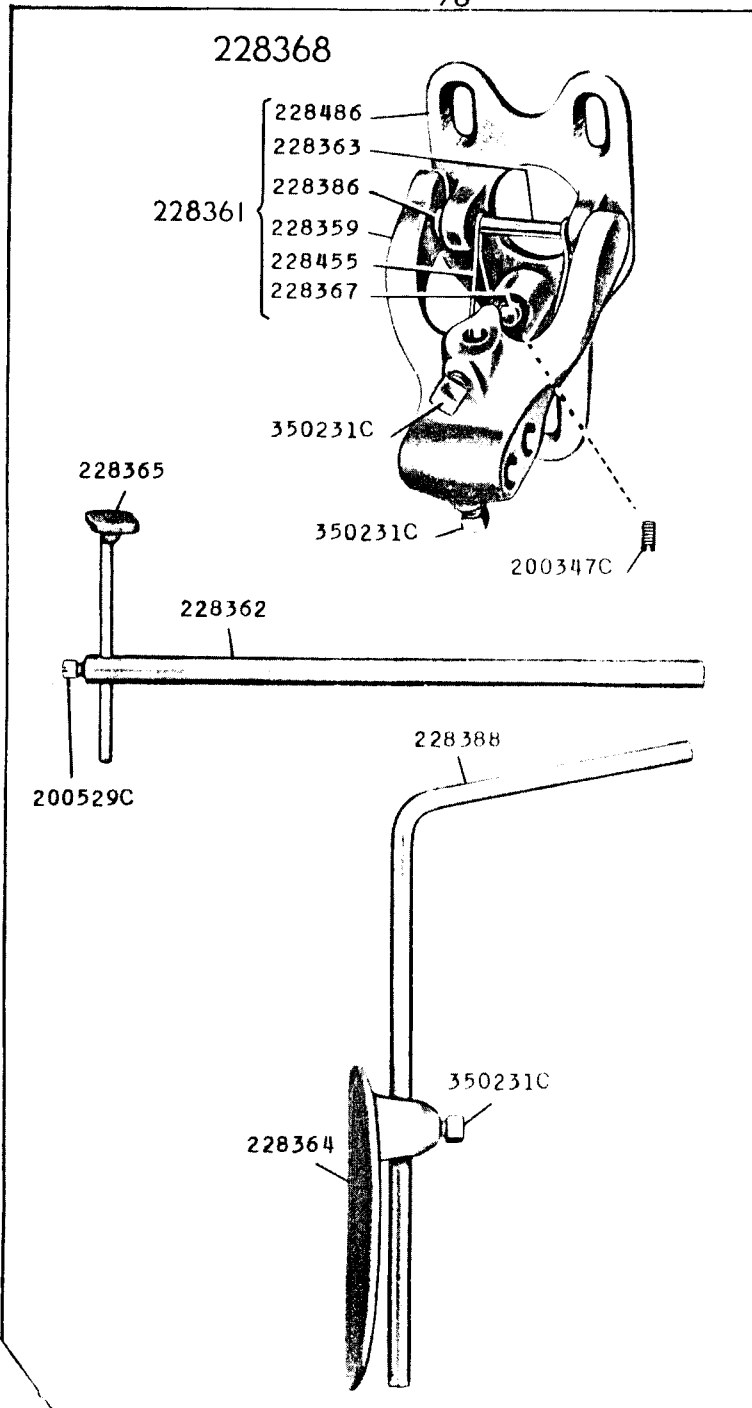

16644 - 1/3

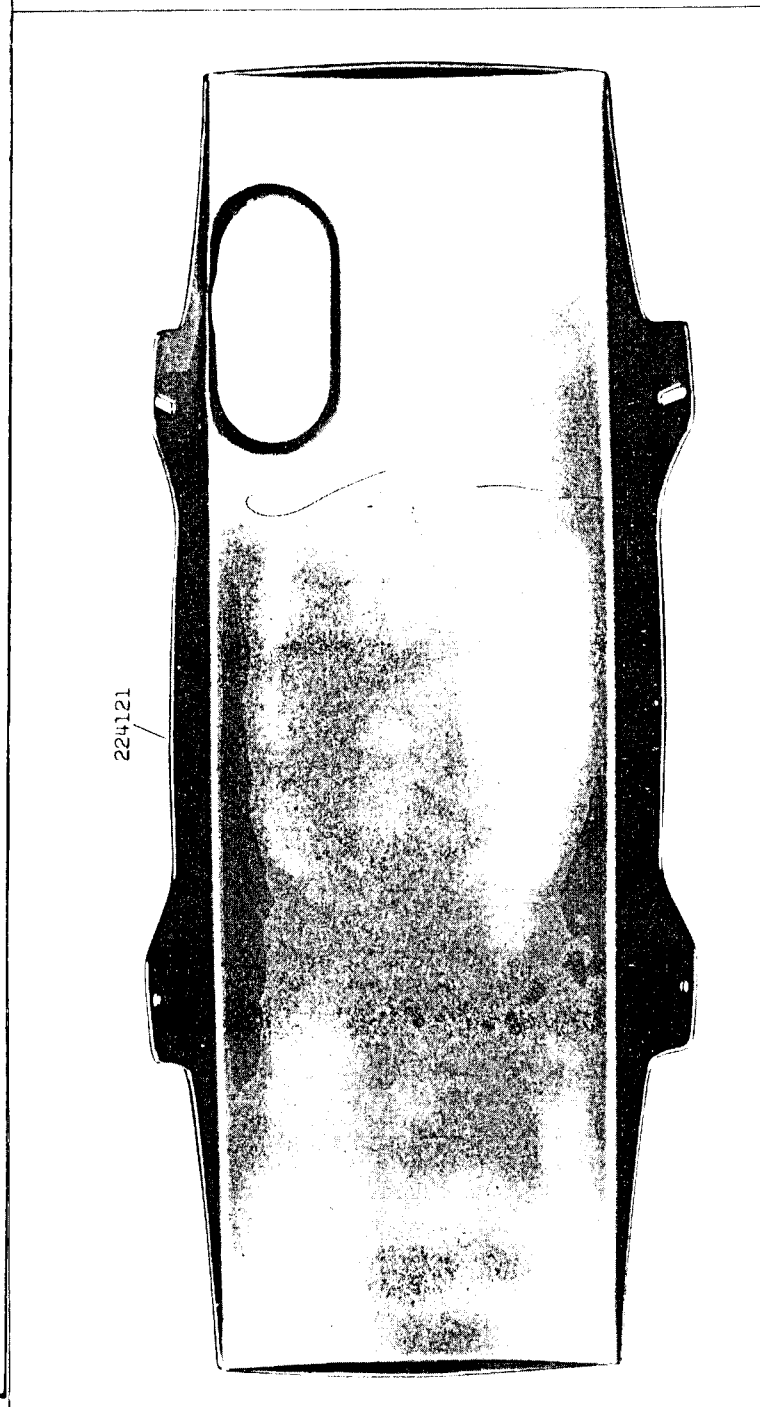

17620 - 1/3

17800 1/6

227955

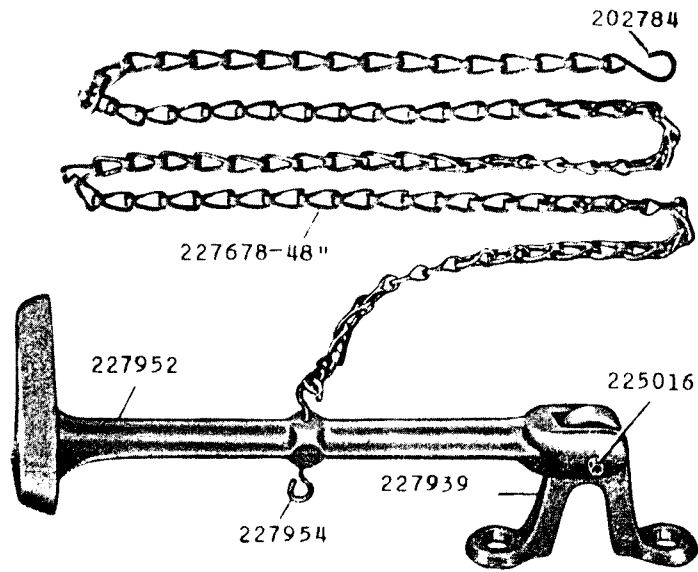

227212

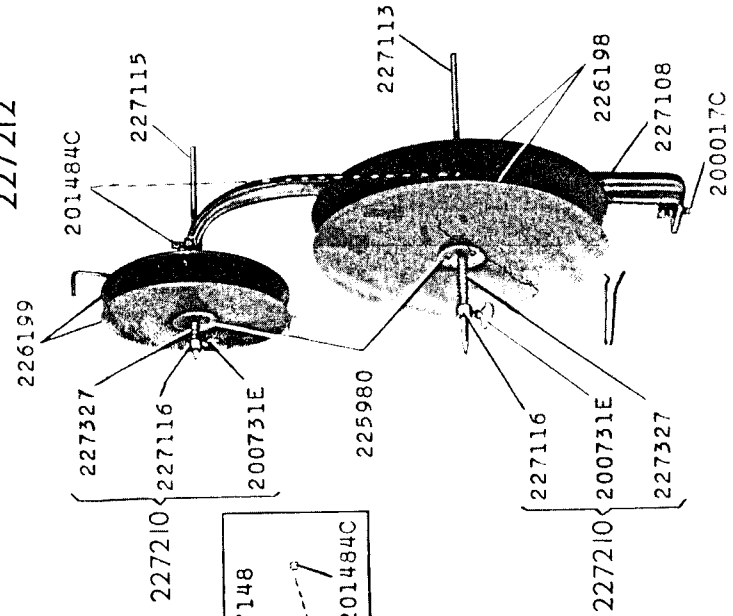

120342

41400

225498

225554

228476

120343

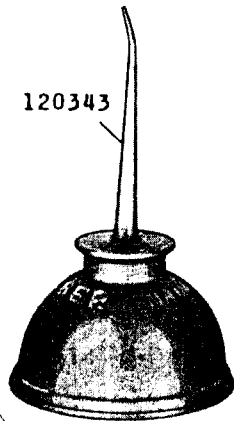

227139

226199

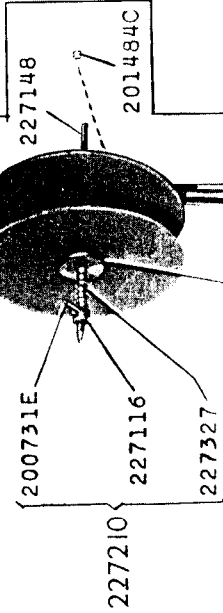

17801 1/2

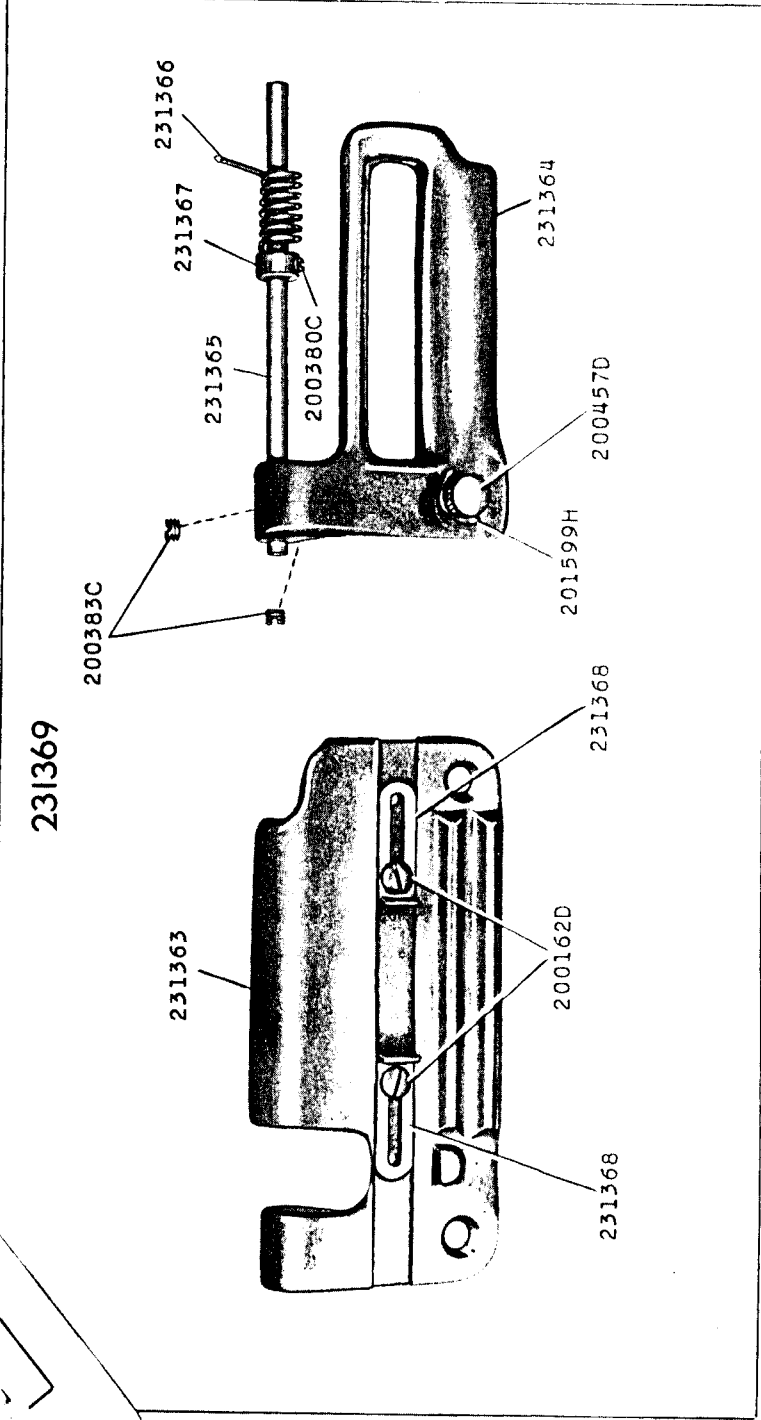

17803

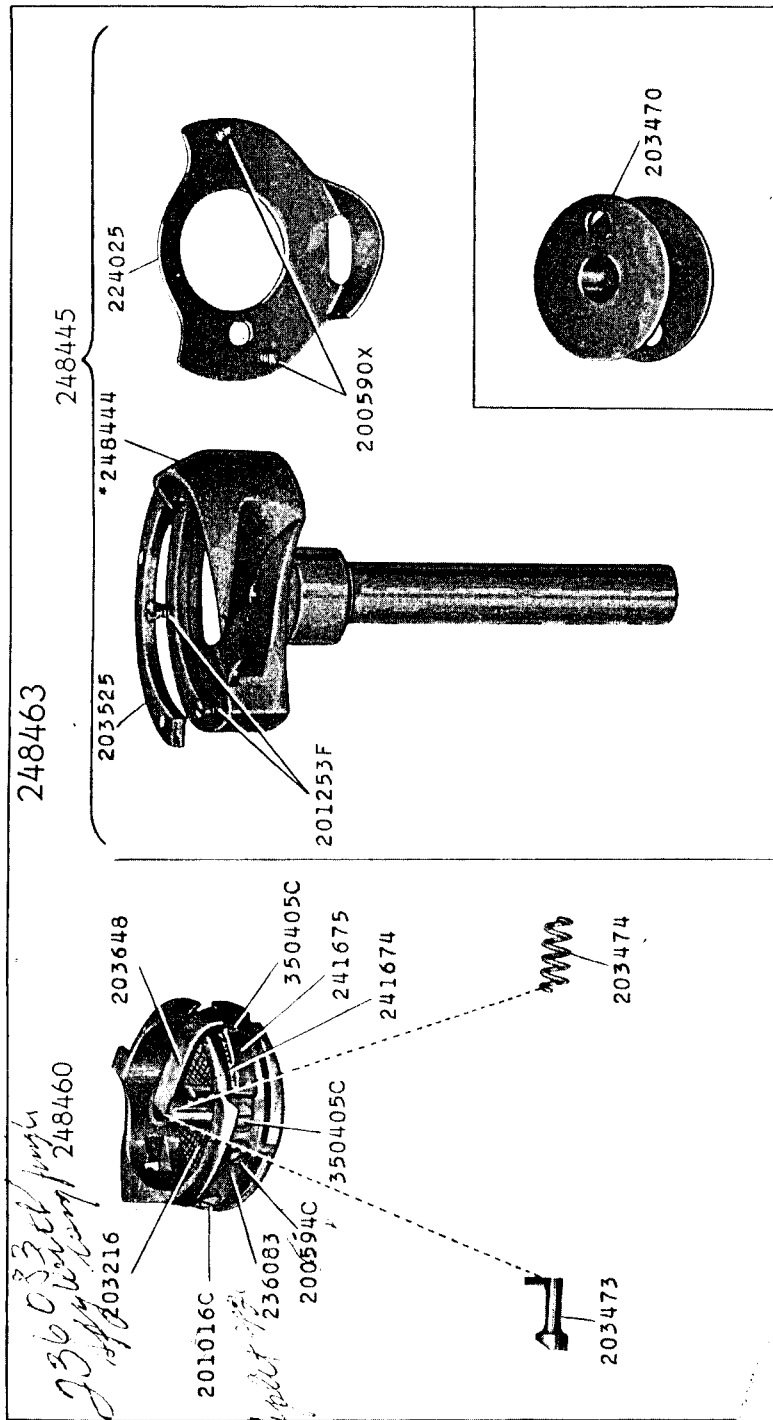

236033 248460
236033 248460
203216

17804 - 5/8

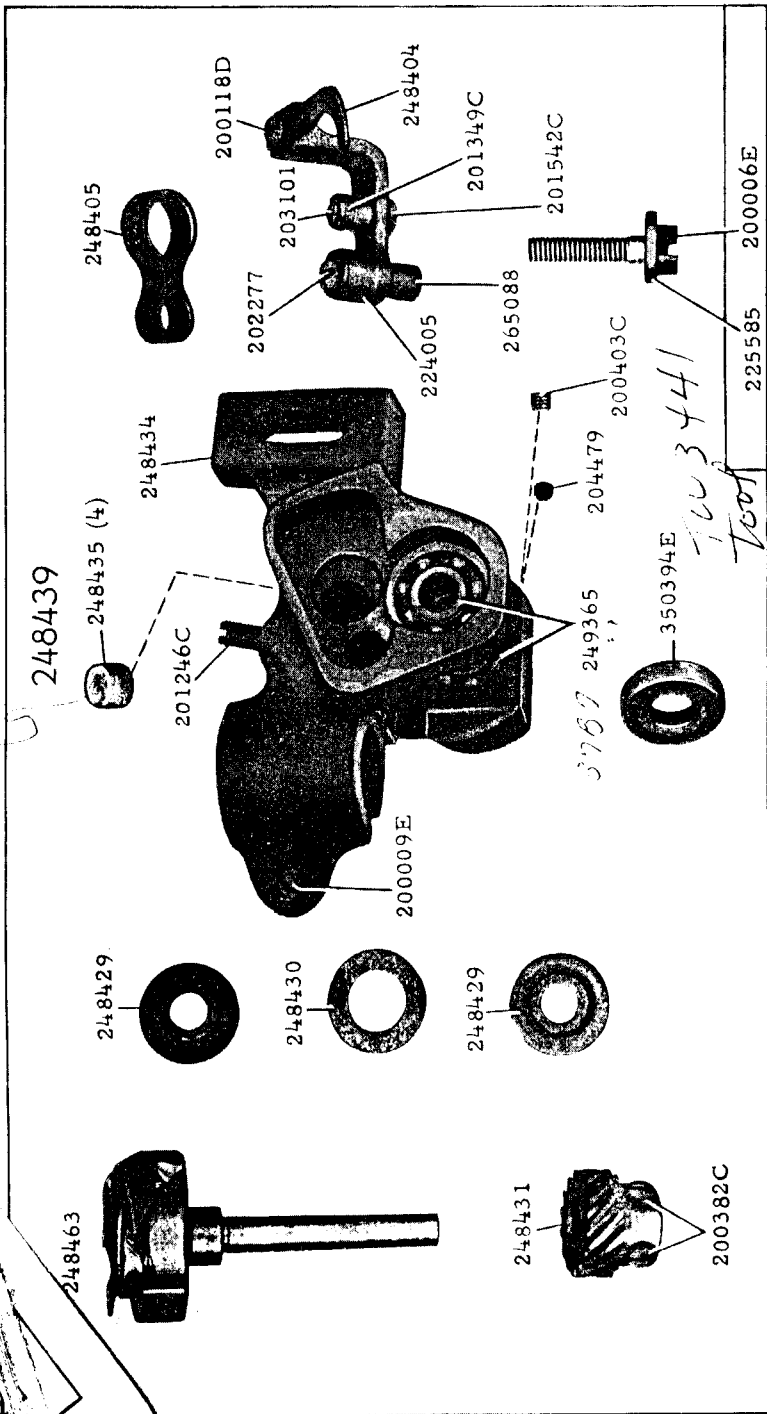

17805 - 5/8

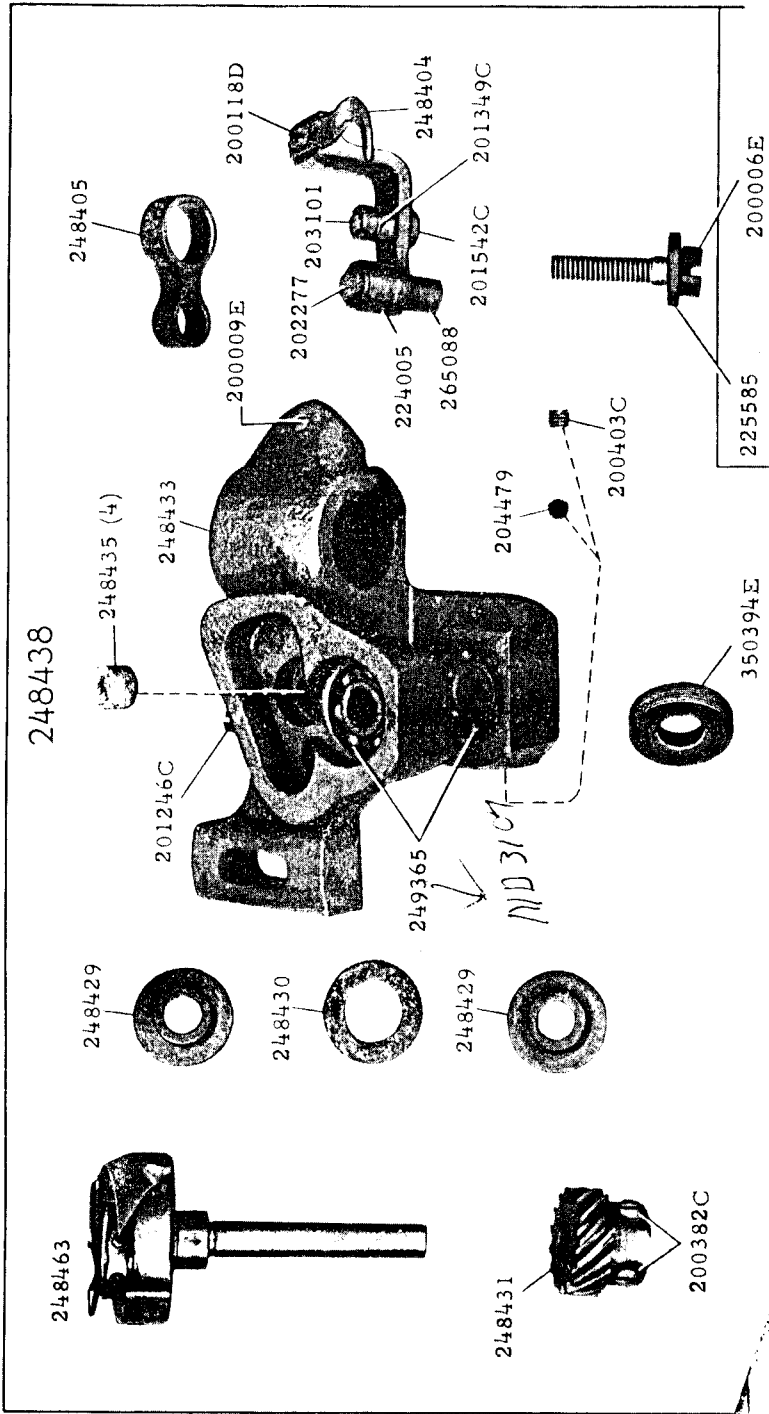

17808 - 3/8

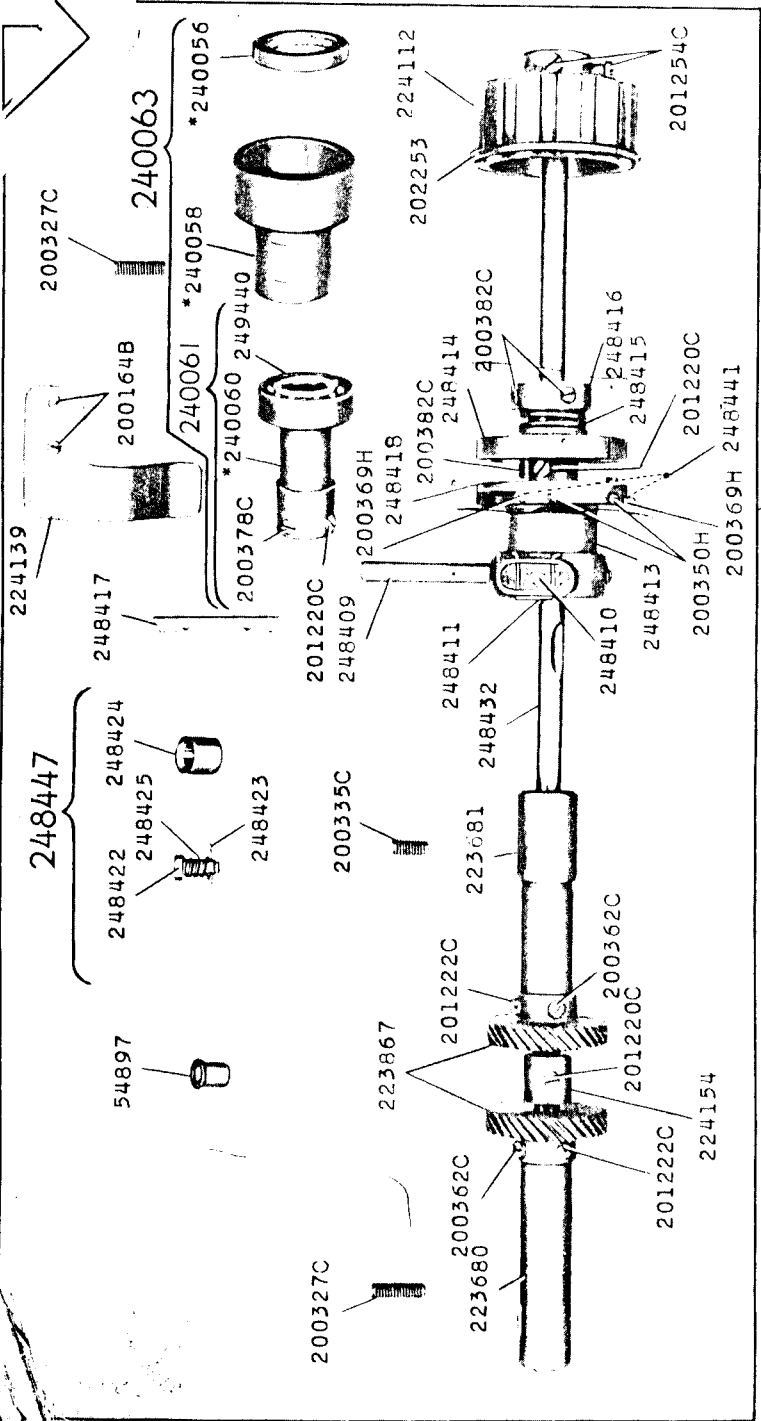

17809 - 3/8

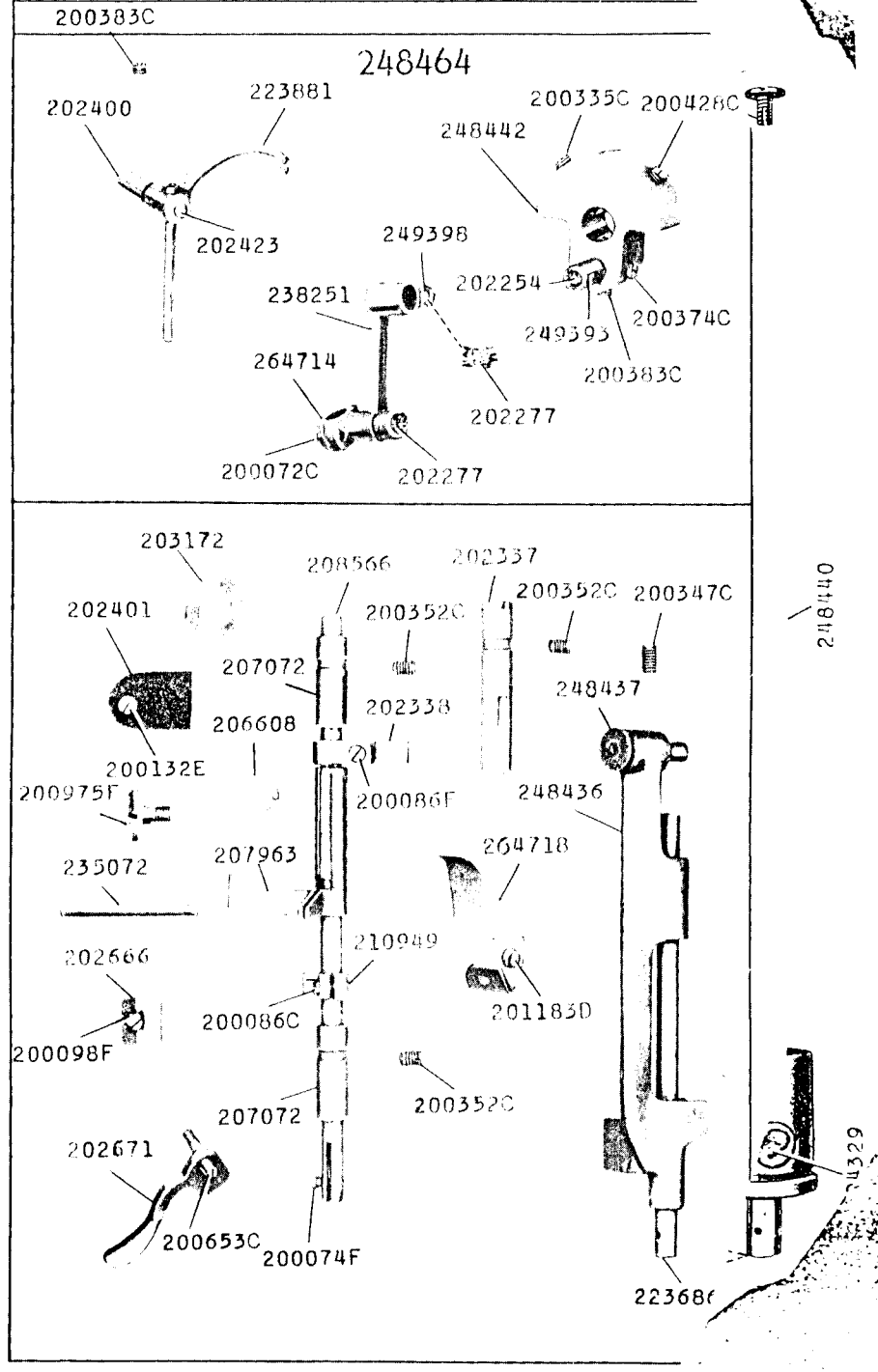

3494

100A

17810

223878
3/32" TO 15/32"
IN STEPS OF 1/32"

223863
1/2" TO 3/4"
IN STEPS OF 1/32"

236649
1/32" 3/64" 1/16" 3/32"
1/8" APART

236650
1/32" 3/64" 1/16"
3/32" APART

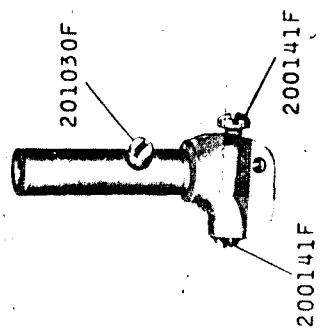
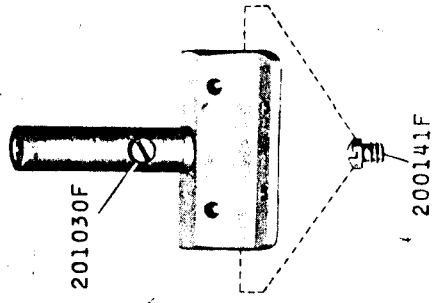
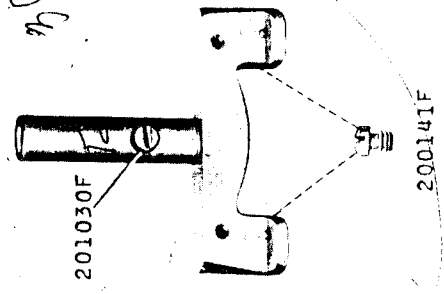

17811 - 3/8

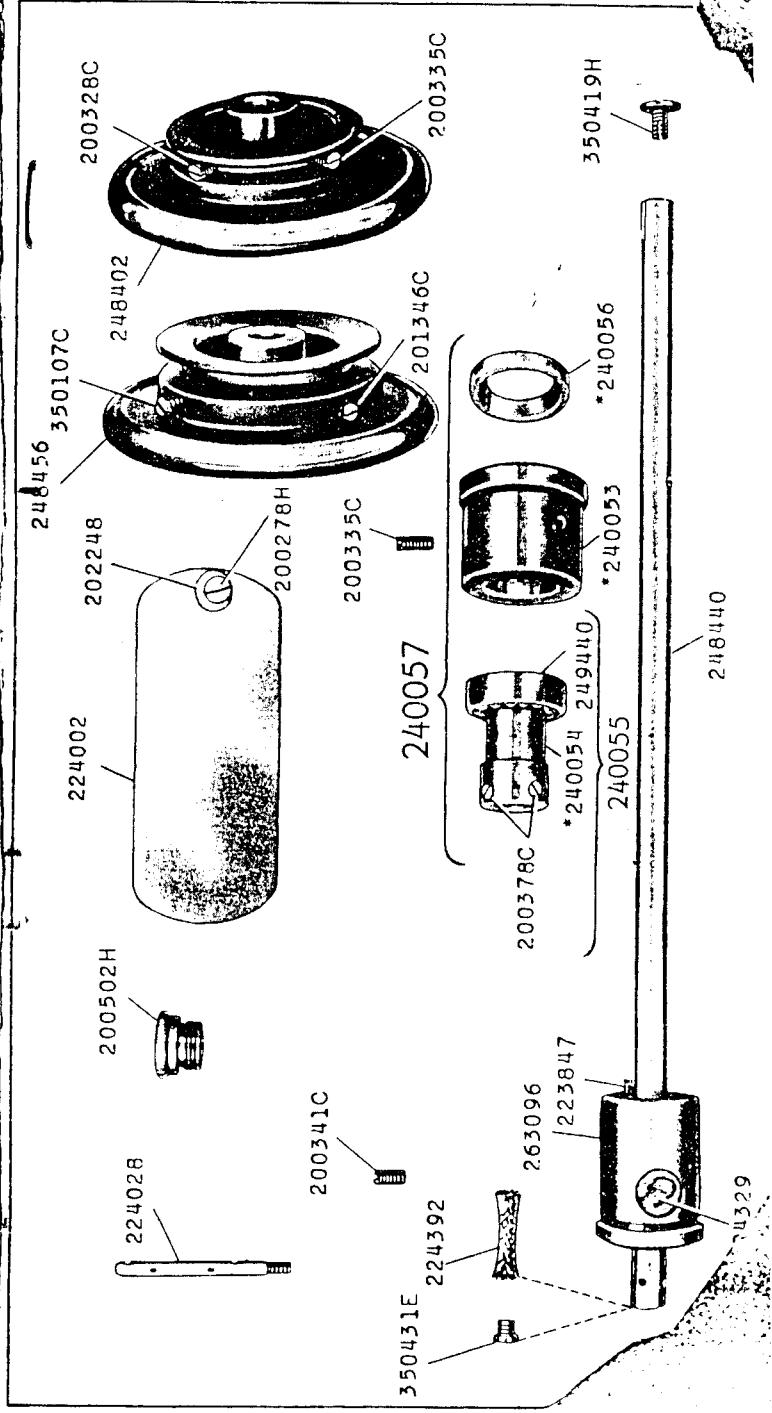

Free Manuals Download Website

<http://myh66.com>

<http://usermanuals.us>

<http://www.somanuals.com>

<http://www.4manuals.cc>

<http://www.manual-lib.com>

<http://www.404manual.com>

<http://www.luxmanual.com>

<http://aubethermostatmanual.com>

Golf course search by state

<http://golfingnear.com>

Email search by domain

<http://emailbydomain.com>

Auto manuals search

<http://auto.somanuals.com>

TV manuals search

<http://tv.somanuals.com>