

# *Sunfire* | HRS™

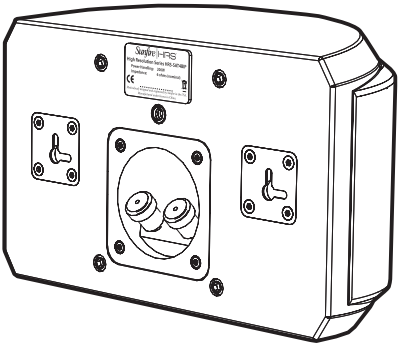

*High Resolution Series  
Surround Loudspeaker*

*HRS-SAT4BIP*

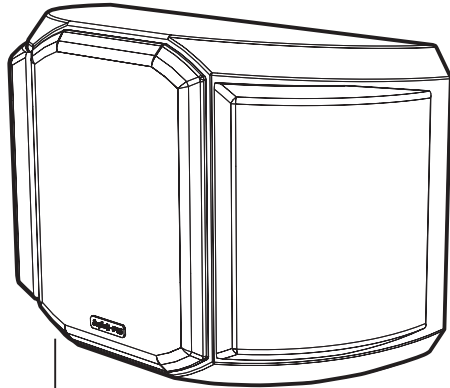

*User's Manual*

# Important Safety Instructions

1. Read Instructions.
2. Keep these Instructions.
3. Heed all Warnings.
4. Follow all Instructions.
5. Do not use this apparatus near water.
6. Clean only with a dry cloth.
7. Do not install near any heat sources such as radiators, heat registers, stoves, or other apparatus (including amplifiers) that produce heat.
8. Refer all servicing to qualified service personnel. Servicing is required when the apparatus has been damaged in any way, such as a connector is damaged, liquid has been spilled or objects have fallen into the apparatus, the apparatus has been exposed to rain or moisture, does not operate normally, or has been dropped.
9. Object and Liquid Entry — Care should be taken so that objects do not fall into and liquids are not spilled into the inside of the apparatus.



**WARNING:** THIS LOUDSPEAKER IS CAPABLE OF PRODUCING VERY HIGH SOUND PRESSURE LEVELS. YOU MUST TAKE EVERY PRECAUTION TO PROTECT YOUR HEARING FROM PERMANENT DAMAGE.



## Contents

Safety Instructions.....	2
Introduction .....	3
Features .....	5
Location .....	6
Using a subwoofer .....	7
Installation .....	8
Specifications .....	10
Troubleshooting .....	11
Service Assistance .....	11

For more information on this and other Sunfire products, please visit our website:

**[www.sunfire.com](http://www.sunfire.com)**



## Introduction

Thank you for purchasing these Sunfire High Resolution Series surround loudspeakers. We hope you enjoy them and the music they make as much as we have enjoyed creating them for you.

These loudspeakers follow a great heritage of both world-class loudspeaker designs and industry-leading subwoofer technologies.

The HRS-SAT4BIP surround loudspeakers are designed as a perfect match to our HRS subwoofers, center and satellite loudspeakers, resulting in an amazing home theater experience... the kind of heart-felt experience that could only come from Sunfire.

## Unpacking

Your Sunfire High Resolution Series loudspeakers should reach you in perfect condition. If you do notice any shipping damage, please contact Sunfire immediately.

Gently lift out the loudspeakers and all the packing material. It is important to save all the packing materials and the box in case your loudspeakers ever needs to be moved or shipped for repair.

Make sure that you keep your sales receipt. It is the only way to establish the duration of your Limited Warranty and it may come in useful for insurance purposes.

## Features

- Perfectly matched to the HRS subwoofers, and the HRS-SAT4 and HRS-SAT4C loudspeakers to form a complete system
- HRS-SAT4BIP can be wall-mounted, or placed on a cabinet or shelf. They can be used for surround, and surround-back applications
- Two-way, high pressure design with fully-sealed enclosure, offers wide, diffuse rear/side channels for an enhanced home theater experience
- 4.5" High Back-emf driver
- Dual 1" ring radiating tweeters
- 110 dB maximum output
- 200 watts maximum power
- Magnetic grilles
- Gold-plated spring terminals
- High gloss multi-layer cabinet finish

## Care

If a loudspeaker needs servicing, please read the Troubleshooting section on page 11. If a problem persists, please contact your nearest authorized Sunfire Dealer.

Please take a moment to fill out and mail the Sunfire Customer Response card. Also read the serial number located on the rear label and record it here:

Serial Number: \_\_\_\_\_

Purchased from: \_\_\_\_\_

Date: \_\_\_\_\_

## Overview

The HRS-SAT4BIP surround loudspeakers are specifically designed to provide high output and high performance for your home theater. Years of research and decades of experience have gone into these amazing loudspeakers.

Sunfire created the category of small-box, high-power subwoofers more than a decade ago with the original True Subwoofer. This design relies on high-pressure, "High Back-emf" technology that provides very high bass output from a very small box. When migrating this subwoofer technology to the woofer of these HRS surround loudspeakers, you get the same advantages: high output, small size, high efficiency, and years of trouble-free operation.

## Woofers

The "Trifilar" voice coil (actually 3 dual voice coils wound in parallel) has a much higher output than conventional multi-layer voice coil designs, and is also significantly lighter. This, combined with the lightweight and incredibly-strong Kevlar® cone, means that the driver responds very quickly. As a result, drum kicks, and other percussive effects will sound tighter and more lifelike. Having a lightweight woofer means that it has improved top-end response. This makes for smoother integration with the tweeter in the critical upper midrange, lower treble range – where much of the vocal information lives. As a result, vocals and dialog sound very natural – not muffled or tinny.

The woofer's 1" excursion is up to four times that of conventional woofers, and provides the highest power handling in its class.

The cast aluminum basket offers more rigidity than the typical stamped variety. When driven at high volume, they will not flex, and the result is tight bass at high volume, with very low distortion.

## Tweeter

The tweeters used in the surround loudspeakers represent a unique approach to tweeter design that results in unrivaled performance. It shares design elements with tweeters found in very expensive European loudspeakers, with a frequency response that is flat to above 20 kHz for crystal-clear detail from any source.

The 1" ring radiating silk dome offers instantaneous response and wide dispersion. The tweeter's vented back chamber contributes to high power handling, improves frequency response with lower distortion, and provides superior transition from high frequencies to the critical midrange.

## Cabinet and baffle

The woofer and tweeters are mounted to a cast aluminum front baffle that is clamped to the cabinet from the rear, forming a fully-sealed enclosure. This clamping design produces a stiff cabinet that is very resistant to vibration, resulting in tight bass response, high fidelity reproduction, and high output for music and movies.

Nine layers of paint and clear coats provide an elegant scratch-resistant finish that matches the HRS subwoofers and loudspeakers.

# Features

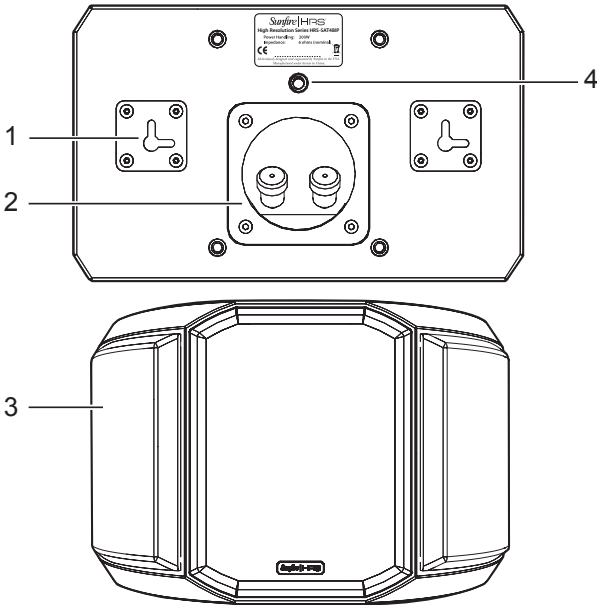

## 1. Mounting Brackets

Each surround loudspeaker has two keyhole brackets that allow for wall mounting horizontally or vertically.

## 2. Binding Posts

The gold-plated spring-loaded terminals accept bare wire, tinned-wire, or pins. Always use high quality connections and speaker wires, and make sure there are no loose fittings or stray wire strands.

Connect the positive speaker-level output of your power amplifier or receiver to the positive (red) input of the loudspeaker. Connect the negative speaker-level output of your power amplifier or receiver to the negative (black) input of the loudspeaker.

Make sure that the positive and negative connections do not touch, or this may damage your power amplifier.

## 3. Grilles

The tweeter and woofer grilles are held in place with small magnets, and can be easily removed if required. Gently pry them off by hand by lifting the corners one at a time.

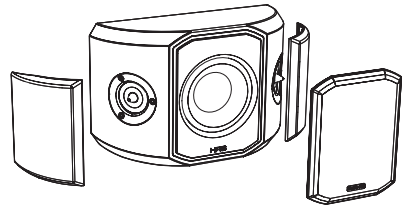

The magnetic logo badge fits either vertically or horizontally in shallow recesses in the woofer grille, depending on how you are using the loudspeaker.

## 4. Threaded Insert

This 1/4-20 threaded insert allows the loudspeaker to be attached to commonly available wall mounts, instead of using the keyhole brackets.

# Loudspeaker Locations

To find the best location for your left, right, and center loudspeakers and the subwoofer, we recommend that you consult their owner's manuals. The HRS-SAT4BIP bipole loudspeakers are used as surround and surround-back loudspeakers in the following configurations.



Keep the loudspeakers away from any TV display, computer, VCR or magnetic tapes and discs. This will reduce the chance of the magnetic fields upsetting the TV screen or erasing magnetic media.

## 5.1 Configuration

Place each surround loudspeaker an equal distance away from the central listening position, and keep them at least one or two feet above ear level (with you sitting down).

They can be placed on the side walls at either side of the listening position as shown below, or further back, up to approximately 20 degrees behind you.

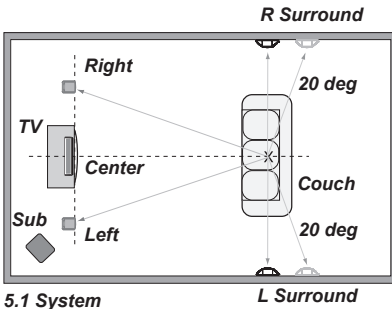

5.1 System

L Surround

The tweeters will create desired reflections from the side and rear walls. This broadens the soundstage so that you cannot distinguish the sound as coming from the loudspeakers, but rather from a larger area behind you.

## 7.1 Configuration

Sunfire home theater processors and receivers have two extra outputs for surround back loudspeakers. These create a wonderful sense of realism in surround effects during playback of Dolby Digital EX, Dolby Pro Logic IIx, and DTS-ES.

Set the surround back loudspeakers behind and between the surround loudspeakers.

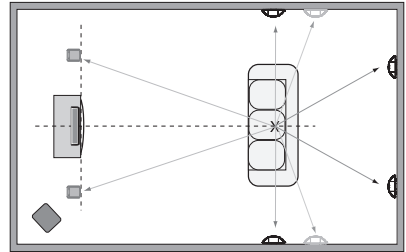

7.1 System

# Using a subwoofer



The loudspeakers are designed to be used with a subwoofer to fill in the lower frequency range. They are not designed to accept 200 watts of power at the full frequency range.

The Sunfire High Resolution Series subwoofers are a perfect match for these surround loudspeakers. There are a variety of HRS subwoofer models to choose from to match your system.

Ideally, your system should be designed so the surround loudspeakers receive the range above 95 Hz, with a subwoofer to handle the frequencies below 95 Hz.

Sunfire home theater processors and receivers have a bass management system that allows you to redirect the bass frequency range of each channel to the subwoofer. The advantages are :

- The overall bass of the system is improved, as subwoofers, such as Sunfire's powered HRS subwoofers are specially designed for this frequency range.
- The subwoofer can simultaneously play the bass from all of the loudspeakers, in addition to it's own low frequency effects channel (LFE).
- There is no loss in perception of the position of movie or music sound effects, as the ear cannot easily locate the position of bass sound sources.
- Compact loudspeakers can be used for front, center and surrounds, as they do not have to reproduce the low frequency range. This leads to a saving in room space.
- Your amplifiers do not waste power reproducing the low frequency range.

## Subwoofer Location

The best location for a single subwoofer can be found by following these steps:

1. Place the subwoofer on your couch or favorite easy-listening chair.
2. You can then either run a calibration (noise) signal through it, or play some of your favorite music samples with heavy bass.
3. Walk around the room, standing in all the positions where you might be able to place the subwoofer. This is usually somewhere close to the corners of the room. Try locations fairly close to the front loudspeakers, and try crouching down low.
4. Find the place in the room where the bass output from the subwoofer is most even. Shut things down and install the subwoofer there.
5. This is the best position for the subwoofer. The bass will sound the best when you are sitting in your normal listening position.

# Installation

Read the details on page 6 to help determine the best position for your loudspeakers.

The loudspeakers can be wall-mounted, or simply placed on shelves or cabinets

To wall-mount the loudspeakers, please follow the instructions below.

## Tools required:

- Phillips screwdriver
- Pencil or other marker
- Electric drill and 5/16" drill bit
- Level
- Safety glasses
- Step ladder if needed
- Electronic stud finder
- Wood screws and dry wall anchors with screws are supplied

## Preliminary steps:

- Clear the area where you are going to work, so it will be safe.



Make sure there is no wiring, or gas or water pipes behind the wall where you are going to drill!

- Temporarily remove any wall-mounted flat screen display if you will be working close to it.
- We recommend mounting the loudspeakers into a wall stud.
- We recommend that the loudspeakers are mounted horizontally, although vertical mounting is offered as an option.
- If you have to mount the loudspeakers onto a masonry wall, we recommend that you consult with your hardware supplier to buy suitable masonry hardware.

The HRS-SAT4BIP weighs 7.0 lb. (3.2 kg). You should allow a good safety margin when mounting. If in doubt, please contact your Sunfire dealer for professional installation.



## Wall-mounting the HRS-SAT4BIP

The HRS-SAT4C comes with a wall-mount template to help mark the correct position for the two mounting screws. It is recommended that you get at least one of the screws into a wall stud, if possible. If this is not possible, then two dry wall anchors and screws are supplied.

1. Use a studfinder to find the location of a suitable wall stud.
2. Position the wall-mount template so that one of the holes is over the wall stud centerline, at the right height. Use a level to make sure that the two holes are horizontal (or vertical, if that is your preference).

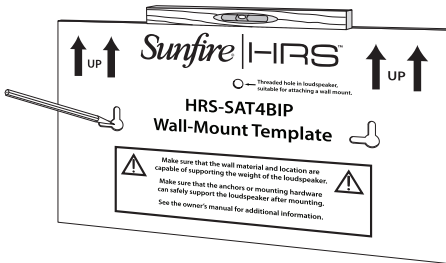

3. Mark the wall with a pencil in the location of the two holes, and remove the template.
4. Put on your safety glasses. With a 5/16" drill bit, drill through the dry wall at each mark, without drilling into the wall stud. Remove any dust.
5. For holes into a wall stud, screw in the supplied woodscrew into the wall stud by hand, until the head is sticking out approximately 1/8".

6. For holes into dry wall, press a dry wall anchor into each hole, and gently tap them in flush. Tighten the screws by hand, until the heads are sticking out approximately 1/8".
7. To reduce the chance of the loudspeaker vibrating against the wall, place the supplied anti-vibration pads in two locations on the rear panel as shown.

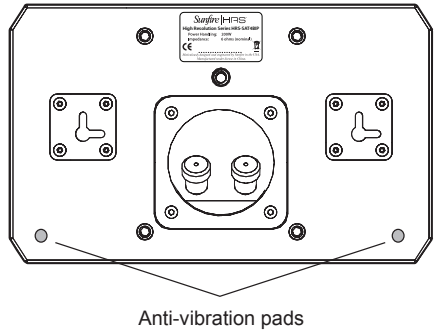

8. Connect your speaker wires to the back of the loudspeaker, making sure of the correct polarity. Secure the wires so their weight is not pulling against the terminals.
9. Hold the loudspeaker in place, so the keyholes line up with the screws on the wall. Make sure that the screwheads are securely in the keyhole slots. If the loudspeaker feels loose, drive the screws in further and remount the loudspeaker.

# Specifications

## Design

2 way, High Pressure

## Drive Units

HF: Dual 1-inch ring radiating tweeters

LF: 4.5-inch High Back-emf

## Frequency Response

95 Hz to 30 kHz

## Maximum Power

200 watts

## Minimum Power

25 watts

## Sensitivity (2.83 V/1 meter)

89 dB

## Maximum Output

110 dB

## Impedance

6 ohms nominal

## Connections

1 pair of gold plated spring terminals

## Dimensions

(Maximum dimensions, including grille)

Height 6.75" (171.5 mm)

Width 10.0" (255 mm)

Depth 4.35" (110.6 mm)

Weight 7.0 lb. (3.2 kg)

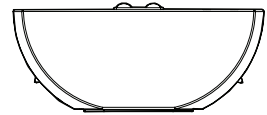
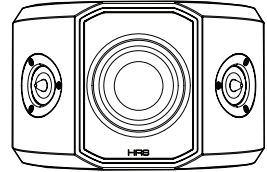
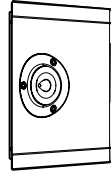

© 2009 Sunfire, a division of Elan Home Systems, LLC.

All rights reserved. Sunfire reserves the right to improve its products at any time. Therefore, specifications are subject to change without notice.

Manual 913-160-00 Rev A

# Troubleshooting

The HRS-SAT4BIP loudspeakers are designed and built to provide years of trouble-free performance. Most problems that occur can usually be solved by checking your setup, or by making sure all components are fully operational.

The following information will help you deal with common problems you may experience. If a problem persists, please contact your Dealer for assistance.

## Poor or no sound

- Check all the connections from the loudspeaker to the amplifier or receiver. Swap loudspeakers around, and see if the poor sound follows a particular loudspeaker.
- Check that your amplifier is not driven too hard or is clipping. Even a low-powered amplifier driven into clipping can cause distortion, or damage your loudspeakers.
- Many processor/preamps can send test tones through all the loudspeakers in your system. Use this to adjust the volume of each channel until they are all playing at the same level. Make sure that any bass management options are set correctly, and any channels using the loudspeakers are set to "small," or "95 Hz."
- If the system bass is weak only when playing surround sources, check that your processor is correctly set to decode the surround modes, such as Dolby Digital or DTS.
- Some DVD discs have a menu that allows you to select which soundtrack to play. Check that the correct surround audio soundtrack is selected.

## Service Assistance

If your Sunfire product ever requires service, write to us or call:

### Sunfire,

1300 E New Circle Road, Suite 150

Lexington, KY 40505

Phone 859-514-8290

Fax: 859-269-7972

You will be directed to an authorized Sunfire Service Station or receive instructions to ship the unit to the factory. Please save the original shipping carton and packing materials in case shipping is required. Please do not ship Parcel Post.

**NOTE:** Before sending in your unit for repair, you must call Sunfire for return authorization.

Include a complete description of the problem, indicating how you have it connected, the associated equipment in your system and a copy of your purchase receipt. Initial shipping costs are not paid by Sunfire; return ground shipping costs will be prepaid if repairs were covered by the scope of this Warranty.

# Sunfire | HRS™

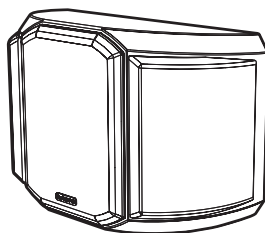
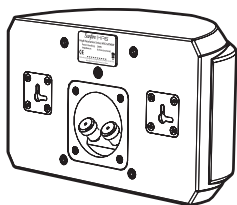

*High Resolution Series  
Surround  
Loudspeaker  
HRS-SAT4BIP*

---

*Sunfire*

*1300 E New Circle Road Phone: 859-514-8290*

*Suite 150,*

*Fax: 859-269-7972*

*Lexington, KY 40505*

*www.sunfire.com*

Manual 913-160-00 Rev A

## Free Manuals Download Website

<http://myh66.com>

<http://usermanuals.us>

<http://www.somanuals.com>

<http://www.4manuals.cc>

<http://www.manual-lib.com>

<http://www.404manual.com>

<http://www.luxmanual.com>

<http://aubethermostatmanual.com>

Golf course search by state

<http://golfingnear.com>

Email search by domain

<http://emailbydomain.com>

Auto manuals search

<http://auto.somanuals.com>

TV manuals search

<http://tv.somanuals.com>