

TOSHIBA

OWNER'S MANUAL

Color Television

COLORSTREAM®

32AFX61

36AFX61

Owner's Record

The model number and serial number are on the back of your TV. Record these numbers in the spaces below. Refer to these numbers whenever you communicate with your Toshiba dealer about this TV.

Model number:

Serial number:

Introduction

Connecting
your TV

Using the
Remote Control

Setting up
your TV

Using the TV's
Features

Appendix

Index

Important Information

WARNING

TO REDUCE THE RISK OF FIRE OR ELECTRIC SHOCK, DO NOT EXPOSE THIS APPLIANCE TO RAIN OR MOISTURE.

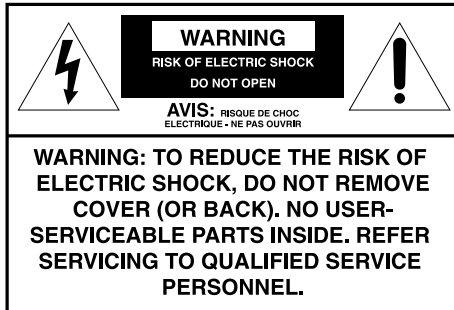

The lightning symbol in the triangle tells you that the voltage inside this product may be strong enough to cause an electric shock. **DO NOT TRY TO SERVICE THIS PRODUCT YOURSELF.**



The exclamation mark in the triangle tells you that important operating and maintenance instructions follow this symbol.

CAUTION

TO PREVENT ELECTRIC SHOCK, DO NOT USE THIS POLARIZED PLUG WITH AN EXTENSION CORD RECEPTACLE OR OTHER OUTLET UNLESS THE PRONGS CAN BE FULLY INSERTED INTO THE OUTLET TO PREVENT ANY EXPOSURE OF THE PRONGS ON THE POLARIZED PLUG.

ATTENTION

POUR PRÉVENIR LES CHOC ÉLECTRIQUES NE PAS UTILISER CETTE FICHE POLARISÉE AVEC UN PROLONGATEUR, UNE PRISE DE COURANT OU UNE AUTRE SORTIE DE COURANT, SAUF SI LES LAMES PEUVENT ÊTRE INSÉRÉS À FOND SANS EN LAISSER AUCUNE PARTIE À DÉCOUVERT.

CAUTION

The plug has one prong wider than the other and will fit only one way into a standard electrical outlet (120 volt AC, 60 Hz). If the plug does not fit into the outlet, try turning it around. If the plug still does not fit, the outlet is probably non-standard and must be replaced by a qualified electrician. Do not tamper with the plug or try to force it into a non-standard outlet.

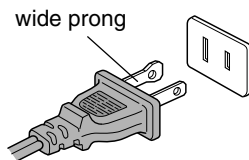

Note to CATV system installers in the USA

This reminder is provided to call the CATV system installer's attention to Article 820-40 of the NEC, which provides guidelines for proper grounding, and, in particular, specifies that the cable ground shall be connected to the grounding system of the building, as close to the point of cable entry as practical.

Precautions

Installing your TV

- Place the TV on the floor or on a sturdy platform. The mounting surface should be flat and steady. If you install the TV on a soft floor, make sure that the floor is not damaged by the weight of the TV.
- This TV set may be used only with the Toshiba stands shown on page 48. Use with other stands may result in instability, causing possible injury.
- Place the TV far enough away from the walls to allow proper ventilation. This will prevent the TV from overheating and avoid possible damage to the TV. Avoid dusty areas too.

Using your TV

- Do not stand or climb on the TV.
- Do not put any heavy object on top of the TV.
- Do not place containers with liquids such as drinks or cosmetics on the TV. If any foreign material or water leaks into the TV, unplug the power cord and contact your dealer.
- Avoid displaying stationary images on your TV screen for extended periods of time. Stationary patterns generated by a Multi-Window display, computer displays, video games, stock market reports, etc., can become permanently engrained on the picture tube. This damage is not protected by your warranty because it is the result of misuse. If you wish to use your TV to display still images, reduce brightness and contrast settings. Never leave a Multi-Window, computer, or video game display unattended.

Cleaning your TV

- To clean the TV screen:
 1. First remove the plug from the power outlet to avoid possible shock hazard.
 2. Use a clean cellulose sponge or chamois cloth dampened with a solution of mild detergent and warm water to clean the TV screen and trim. Do not use too much water on the TV screen. Water spills into the cabinet and may cause damage to the TV. Avoid excess water.
 3. Remove any extra moisture with the same cloth or a dry one.

CAUTION

Never use strong solvents such as thinner, benzene or other chemicals on or near cabinet, as they might damage the finish of the cabinet.

Introduction	4	Using the preview function	30
Welcome to Toshiba	4	Using the favorite function	30
Exploring your new TV	4	Using the strobe function	30
Connecting your TV	5	Using the LOCKS menu	31
Connecting a VCR	5	Entering the PIN code	31
Connecting a cable converter box	6	Using the V-CHIP menu	32
Connecting a cable converter box and VCR	6	ENABLE BLOCKING	32
Connecting a DVD player or satellite receiver and a VCR	7	TV RATING (Independent rating system for broadcasters)	32
Connecting a DVD player with ColorStream® and a VCR	7	MPAA RATING (Independent rating system for movies)	33
Connecting two VCRs	8	BLOCKING OPTION	33
Connecting a camcorder	9	Unlocking programs temporarily	34
Connecting an audio system	9	Locking channels	34
Connecting an A/V receiver	10	Locking video inputs	35
Using the remote control	11	Changing the PIN code	35
Preparing the remote control for use	11	Adjusting the picture	36
Installing the remote control batteries	11	Selecting the picture mode	36
Remote Control functional key chart	12	Adjusting the picture quality	36
Programming the remote control for use with your audio/video devices	14	Saving new preference	37
Device code setup	14	Using the flesh tone feature	37
Searching and sampling the code of a device (991)	14	Using the noise reduction feature	37
Verifying the device code (990)	15	Selecting the color temperature	38
Using the Volume Lock feature (993)	15	Resetting your picture adjustments	38
Operational feature Reset (980)	15	Watching video input	39
Device code table	16	Labeling the video input sources	39
Learning about the remote control	20	Using the closed caption feature	40
Setting up your TV	21	Setting the sleep timer	41
Learning about the menu system	21	Setting the clock	41
Changing the on-screen display language	22	Adjusting the sound	42
Selecting the antenna input	22	Muting the sound	42
Using the TV/ VIDEO button on the TV to select the antenna input	22	Selecting stereo/SAP broadcasts	42
Adding channels to the TV's memory	23	Using the surround sound feature	43
Programming channels automatically	23	Adjusting the sound quality	43
Adding and erasing channels manually	24	Resetting your audio adjustments	44
Adjusting the tilt correction feature	24	Using the CYCLONE™ sub-woofer system	44
Changing channels	24	Turning off the built-in speakers	45
Using the TV's features	25	Selecting the Audio Out sound	45
Adjusting the channel settings	25	Using the StableSound™ feature	46
Switching between two channels	25	Selecting the menu display background	46
Programming your favorite channels	25	Displaying on-screen information	46
Labeling channels	26	Viewing the demonstration mode	47
Watching picture-in-picture (PIP)	28	Understanding the auto power off feature	47
Switching the main and small pictures	29	Understanding the last mode memory feature	47
Changing the position of the small picture	29	Appendix	48
Freezing the small picture	29	Specifications	48
Using Multi-Window feature	29	Troubleshooting	49
		Limited United States Warranty	50
		Index	51

Introduction

Welcome to Toshiba

Congratulations! You have purchased one of the finest TVs on the market. The goal of this manual is to guide you through setting up and operating your Toshiba TV as quickly as possible.

This manual applies to models 32AFX61 and 36AFX61. Before you start reading, check your model number by looking at the rear of the TV.

Instructions in this manual are based on using the remote control. You can also use the controls on the TV if they have the same name as those on the remote control.

Please read all the safety and operating instructions carefully, and keep the manual for future reference.

Exploring your new TV

You can operate your TV by using the buttons on the front panel or the remote control. The back panel and front panel (behind the door) provide all the terminal connections you will need to connect other equipment to your TV.

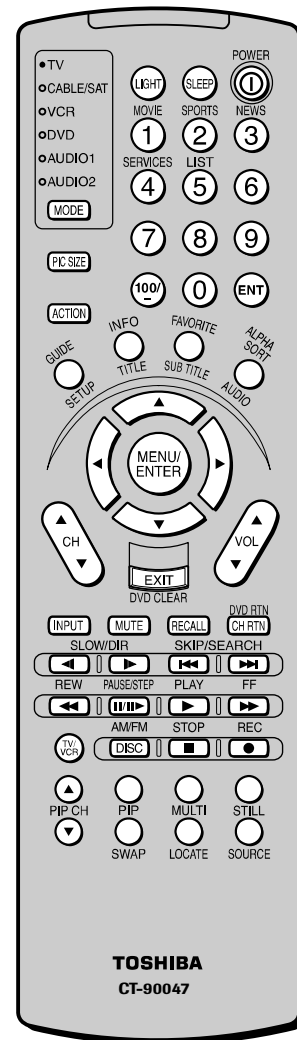
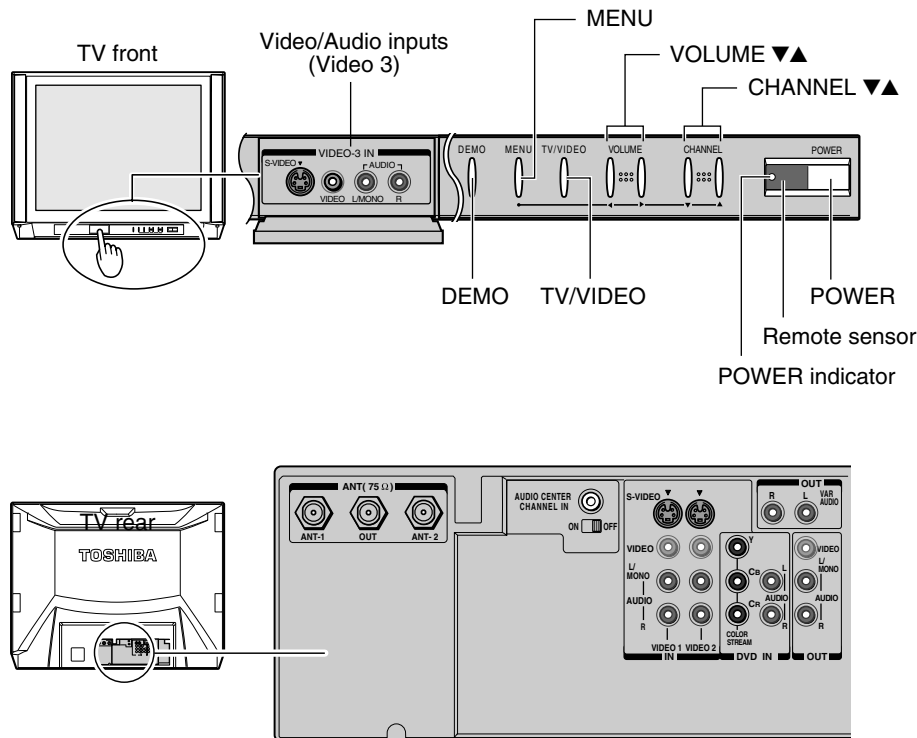

Connecting your TV

If you have not connected electronic equipment before, or you have been frustrated in the past, you may wish to read this section. (Cables are not supplied.)

- A coaxial cable is the standard cable that comes in from your antenna or cable converter box. Coaxial cables use "F" connectors.
- Audio and video cables are usually color-coded according to use: yellow for video and red and white for audio. The red audio cable is for the stereo right channel, and the white audio cable is for the stereo (or mono) left channel. If you look at the rear panel of the TV, you will see that the terminals are color-coded in the same manner as the cables.
- S-video cables provide better picture performance. S-video cables can only be used with S-video compatible components.
- ColorStream® cables come in sets of three. A ColorStream connection will provide the best picture performance.

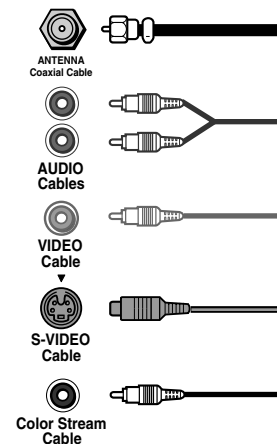

Caution:

Do not plug the TV in until you have finished connecting all of your equipment.

Connecting a VCR

This connection allows you to watch local channels and video programs, play or record on the VCR while watching TV, and record from one channel while watching another channel.

You will need:

- one coaxial cable
- one pair of audio cables (one single audio cable for a mono VCR)
- one video cable (one S-video cable for an S-VHS VCR)

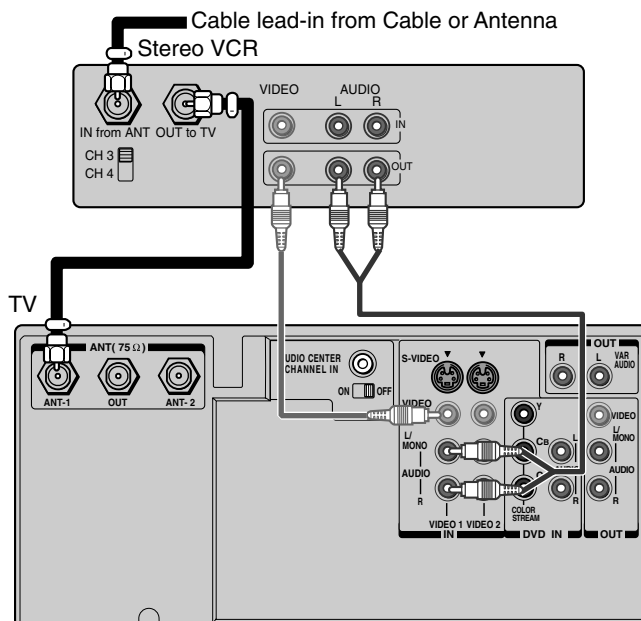

Caution:

If you have a mono VCR, connect L/Mono to VCR Audio OUT using only one audio cable.

If you have an S-VHS VCR, use an S-video cable (in the S-Video inputs) instead of a regular video cable.

Do not connect a regular video cable and an S-video cable to Video-1 (or Video-2) at the same time. Doing so will distort the picture.

Connecting a cable converter box

This connection allows you to watch cable and premium channels.

To use the TV's features, select ANT-1. To view premium channels, select ANT-2 and tune the TV to channel 3 or 4 (whichever channel is vacant in your area), then use the converter box to change channels.

You will need:

- two coaxial cables

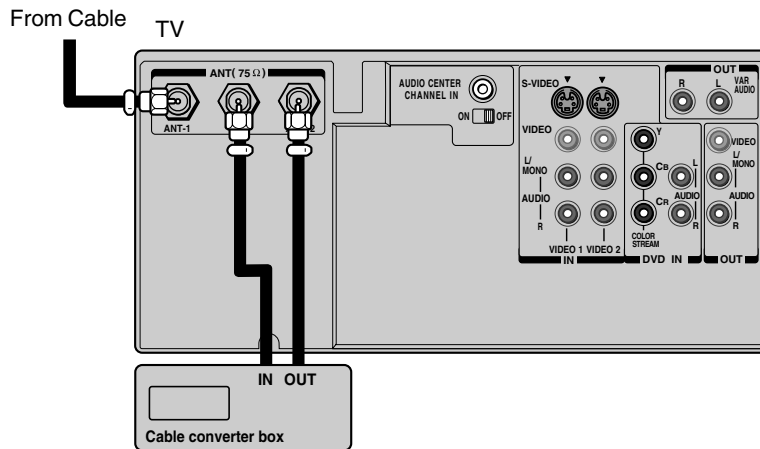

Note:

When you use a converter box with your TV, the remote control will not operate some features, such as programming your favorite channels, labeling channels, and locking channels.

Connecting a cable converter box and VCR

This connection allows you to watch and record basic and premium cable channels, watch videotapes, and record one TV channel while watching another TV channel. To use the TV's features, select ANT-1. To view premium channels or record with the VCR, select ANT-2, change the TV channel to 3 or 4 (whichever channel is vacant in your area), and then use the converter box to change channels.

You will need:

- one two-way cable signal splitter
- three coaxial cables
- one pair of audio cables (one single audio cable for a mono VCR)
- one video cable (one S-video cable for an S-VHS VCR)

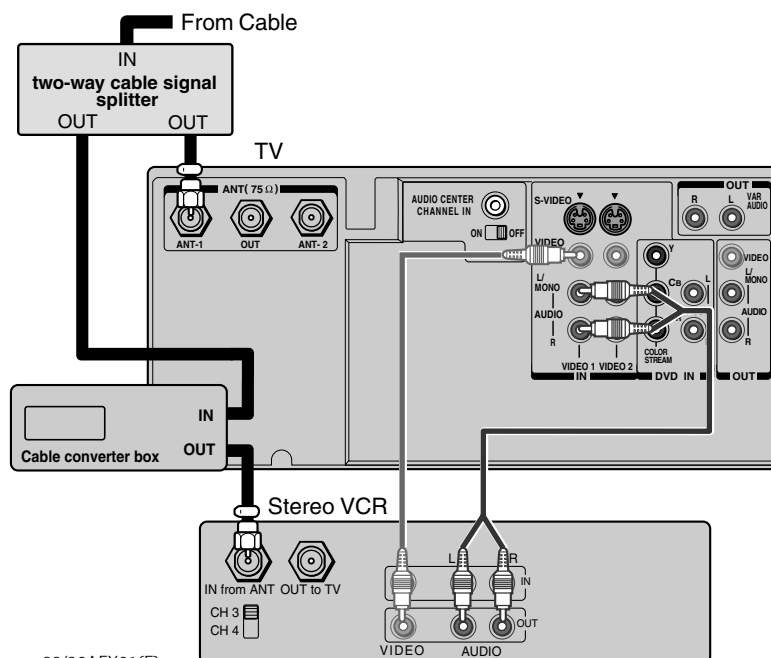

Note:

If you have a mono VCR, connect L/Mono to VCR Audio OUT using only one audio cable.

If you have an S-VHS VCR, use an S-video cable (in the S-video jacks) instead of a regular video cable. Do not connect both a regular video cable and an S-video cable to Video-1 (or Video-2) at the same time. Doing so will distort the picture.

When you use a converter box with your TV, the remote control will not operate some features, such as programming your favorite channels, labeling channels, and locking channels.

Connecting a DVD player or satellite receiver and a VCR

This connection allows you to watch DVD/satellite, VCR, and TV programs. You can record one TV channel while watching another channel.

You will need:

- one coaxial cable
- two pairs of audio cables (one single and one pair of audio cables for a mono VCR)
- one video cable (between the TV and VCR)
- one S-video cable (between the TV and DVD player/satellite receiver)

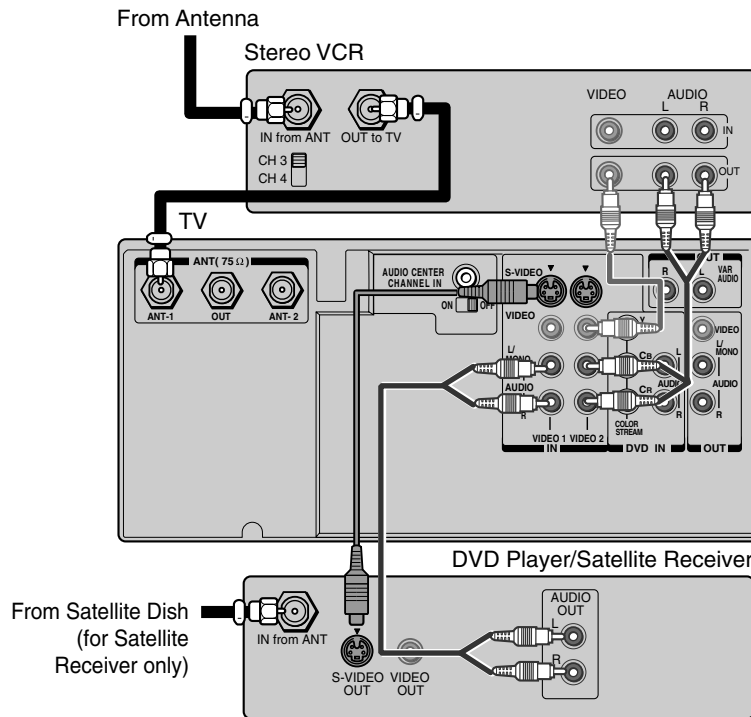

Note:

For the highest possible picture quality from a non-ColorStream DVD player/satellite receiver, you must use an S-video cable between the TV and DVD player/satellite receiver. (If your DVD player or satellite receiver is ColorStream-compatible, see page 8).

Do not connect both an S-video cable and a regular video cable to Video-1 (or Video-2) at the same time. Doing so will distort the picture.

Do not connect the DVD player/satellite receiver and VCR to the same video channel on the TV. (See the illustration, which shows the DVD player/satellite receiver connected to Video-1 and the VCR connected to Video-2.)

Caution:

The unauthorized recording of television programs, videotapes, DVDs, and other materials may infringe upon the provisions of copyright laws.

Connecting a DVD player with or without ColorStream® and a VCR

This connection allows you to watch DVD, VCR, and TV programs, and record TV and some DVD programs. You can record from one source while watching a program from another source.

Your TV has ColorStream component video inputs. Connecting your TV to a ColorStream-compatible DVD player (such as a Toshiba ColorStream DVD player) can greatly enhance picture quality and realism.

You will need:

- one coaxial cable
- three pairs of audio cables (two single and one pair of audio cables for a mono VCR)
- two video cables
- one set of ColorStream video cables (one S-video cable for a non-ColorStream DVD player; see notes at right of illustration on next page).

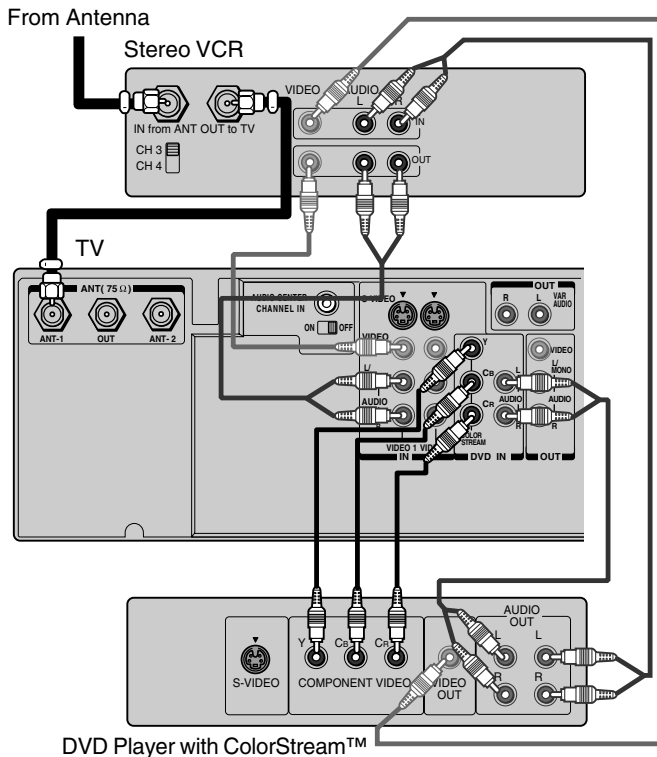

Note:

For the highest possible picture quality, you must use the ColorStream connections between the TV and DVD player. You can connect the ColorStream cables from the DVD player to either ColorStream jack on the TV (HD1 or HD2).

The ColorStream HD1 and HD2 jacks can be used with Progressive (480p) and Interlace (480i, 1080i) scan systems.

If your DVD player is not ColorStream-compatible, use the S-video connections (both audio and video) instead of the ColorStream connections.

Do not connect both S-Video and ColorStream cables between the TV and DVD player at the same time. Doing so will distort the picture.

To record from the DVD player (when authorized), set the VCR to Line IN. To monitor recording from the DVD player, set the VCR to Line IN and the TV to Video-1.

Caution:

The unauthorized recording of television programs, videotapes, DVDs, and other materials may infringe upon the provisions of copyright laws.

Connecting two VCRs

This connection allows you to record (dub/edit) from one VCR to another VCR while watching a videotape. You can also record from one TV channel while watching another channel.

You will need:

- one coaxial cable
- two pairs of audio cables (two single audio cables for mono VCRs)
- two video cables (two S-video cables for S-VHS VCRs)

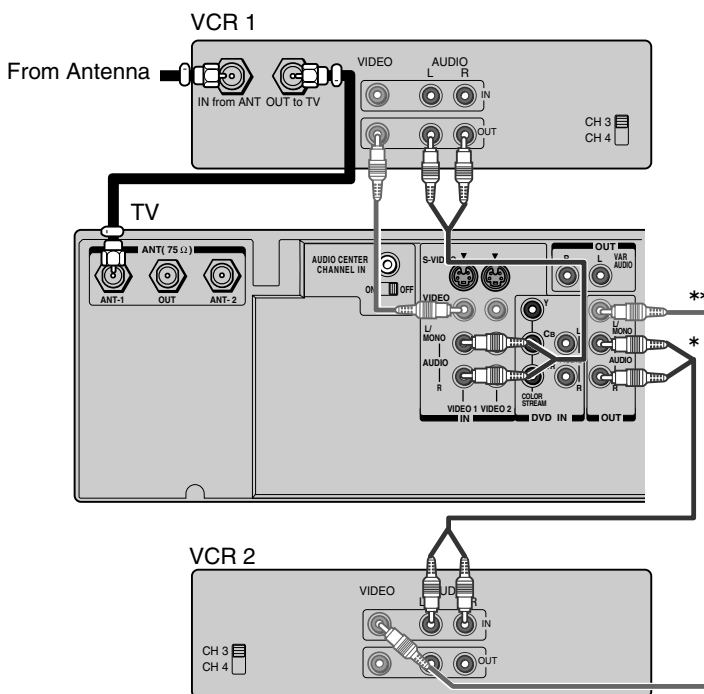

Note:

Do not connect the same VCR to the output and input jacks on the TV at the same time.

If you have S-VHS VCRs, use S-video cables (in the S-video jacks) instead of regular video cables. Do not connect both a regular video cable and an S-video cable to Video-1 (or Video-2) at the same time.

To dub or edit, VCR 2 must select Line IN, and the TV must select Video-1.

* The Audio OUT jacks can output the sound of either the Main or PIP picture (see "Selecting the Audio OUT sound" on page 45).

** The Video OUT jack does not output the PIP picture.

Caution:

The unauthorized recording of television programs, videotapes, DVDs, and other materials may infringe upon the provisions of copyright laws.

Connecting a camcorder

This connection allows you to watch video materials recorded on a camcorder.

You will need:

- one pair of audio cables
- one video cable (one S-video cable for an S-VHS camcorder)

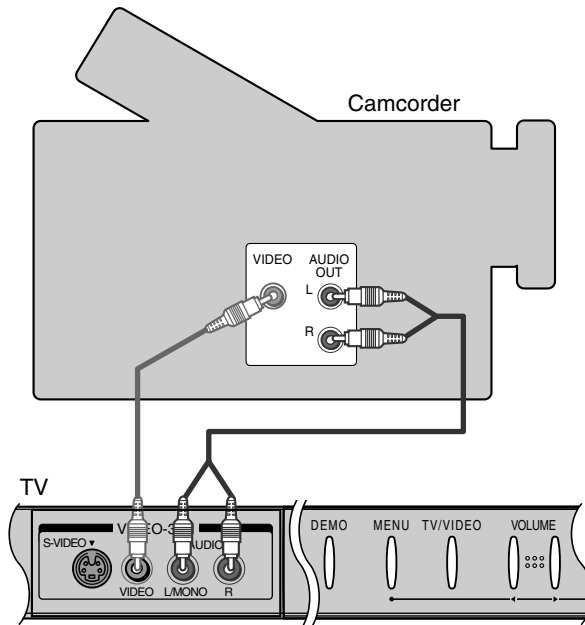

Note:

If you have an S-VHS camcorder, the picture quality will increase if you use an S-video cable (in the S-video jacks) instead of a regular video cable.

Do not connect both a regular video cable and an S-video cable to at the same time.

Connecting an audio system

This connection allows you to use an audio amplifier to adjust the audio level. This also allows you to use external speakers.

To control the audio, turn on the TV and the stereo amplifier, and turn off the built-in speakers. (See "Turning off the built-in speakers" on page 45.)

You will need:

- one pair of audio cables

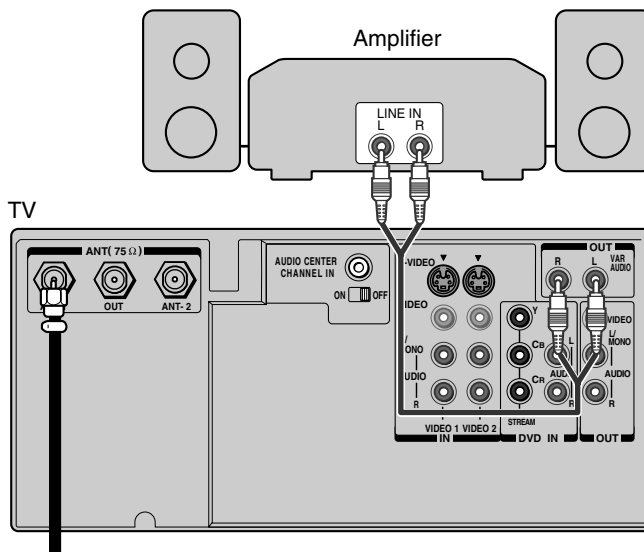

From Cable, Cable Box or Antenna

Note:

To hear sound when using an external audio amplifier, the volume of both the TV and amplifier must be set above 0 (zero).

For example, if the volume of the TV is set to 0, you will not be able to hear any sound, even if the volume of the amplifier is at its highest level.

Connecting an A/V receiver

This connection allows you to use an A/V (audio/video) receiver to enhance your TV's sound.

If you have a system with Dolby Pro Logic® surround sound, you can add to the realism of the sound by using the TV speakers as center channel speakers.

You will need:

- one pair of audio cables
- one single audio cable for the audio center channel
- one video cable

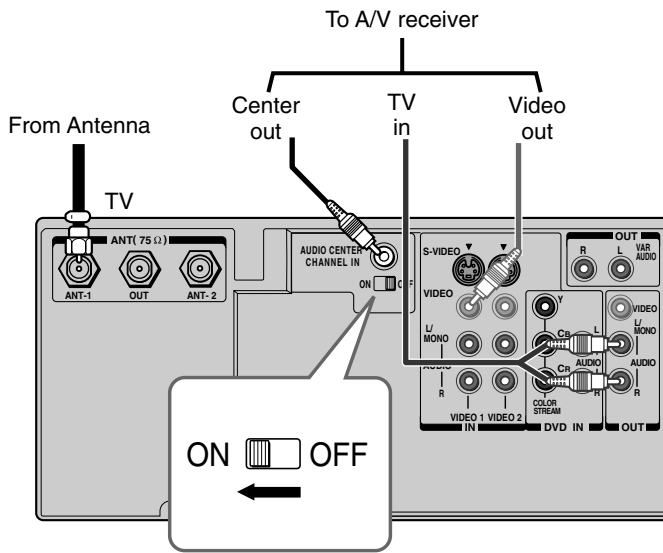

Caution:

To avoid damaging the speakers, turn the TV off before connecting or disconnecting the Audio Center Channel cable.

Note:

Refer to the instructions provided with your A/V receiver for details about your sound system.

When the Audio Center Channel ON/OFF switch is in the ON position, the TV speakers will function only as center channel speakers.

To adjust the volume of the center channel speakers, use the center level control on the A/V receiver.

To use the TV speakers as normal speakers, set the Audio Center Channel ON/OFF switch to the OFF position.

Dolby Pro Logic* surround sound system connection example

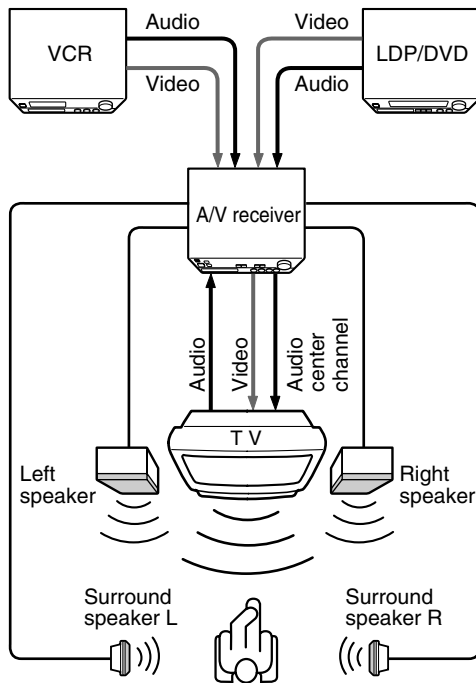

*Dolby Pro Logic is a registered trademark of Dolby Laboratories Licensing Corporation.

Using the remote control

Preparing the remote control for use

Your Toshiba TV remote control has one dedicated TV mode and five universal modes: VCR, Cable/SAT, DVD, Audio1, and Audio2. The target and default devices being programmed for each mode are as follows:

Target device/Mode mapping

Mode	Device
TV	Toshiba TV
CABLE/SAT	Universal Cable, Satellite
VCR	Universal VCR, DVD, LD, Cassette
DVD	Universal DVD, VCR, LD, Cassette
AUDIO1	Universal Audio: Amp., Tuner, Misc.Audio, CD/MD
AUDIO2	Universal Audio: CD/MD, Amp., Tuner, Misc.Audio

Default device codes

Mode	Default device
TV	Toshiba TV
CABLE/SAT	Toshiba Satellite receiver
VCR	Toshiba VCR
DVD	Toshiba DVD
AUDIO1	Pioneer Audio receiver
AUDIO2	Pioneer LD

Repeatedly press MODE to cycle among the modes. If you own different brands of audio/video devices, you first have to program your remote control (see "Programming the remote control for use with your audio/video devices" on page 14).

Installing the remote control batteries

To install the batteries:

- Slide the battery cover off the back of the remote control.

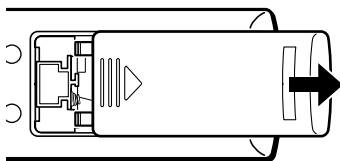

- Install two "AA" size alkaline batteries. Match the + and - signs on the batteries to the signs on the battery compartment.

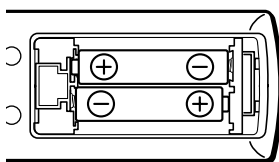

- Slide the battery cover back on the remote control until the lock snaps.

Note:

Your TV remote control may not operate certain features on your VCR, DVD player, cable TV converter, or other electronic device.

Refer to the owner's manuals for your other devices to determine their available features. If your TV remote control does not operate a specific feature on another device, use the remote control that came with the device.

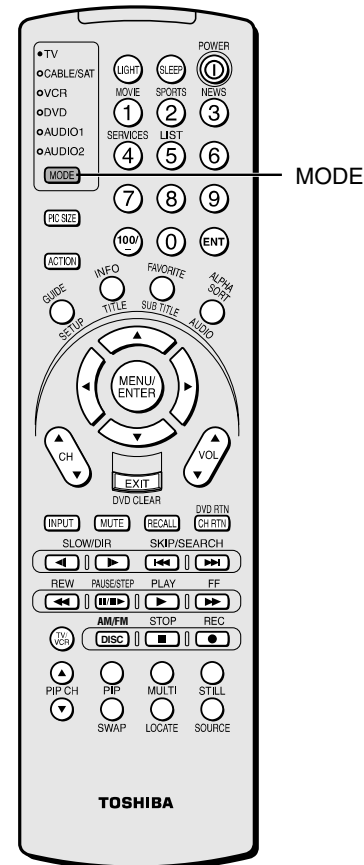

Note:

- Battery life expectancy is about one year with normal use.

Caution:

- Dispose of batteries in a designated disposal area. Do not throw batteries into a fire.
- Do not mix battery types or combine used batteries with new ones.
- If the batteries are dead or you do not intend to use the remote control for a long time, remove the batteries to prevent battery acid from leaking into the battery compartment.

Remote Control functional key chart

Key Label	Toshiba TV (TV)	Cable (CBL/SAT)	Satellite (CBL/SAT)	VCR	DVD/LD	Receiver (AUDIO)	CD/MD (AUDIO)	Cassette (VCR)
LIGHT	Illuminates the remote. Toggles the Illumination mode on and off.							
SLEEP	Sleep timer	---	---	---	---	---	---	---
POWER	Power	Power	Power	Power	Power	Power	Power	Power
1/MOVIE	Digit 1	Digit 1	Digit 1	Digit 1	Digit 1	AV input 1	Digit 1	Digit 1
2/SPORTS	Digit 2	Digit 2	Digit 2	Digit 2	Digit 2	AV input 2	Digit 2	Digit 2
3/NEWS	Digit 3	Digit 3	Digit 3	Digit 3	Digit 3	AV input 3	Digit 3	Digit 3
4/SERVICES	Digit 4	Digit 4	Digit 4	Digit 4	Digit 4	AV input 4	Digit 4	Digit 4
5/LIST	Digit 5	Digit 5	Digit 5	Digit 5	Digit 5	CD	Digit 5	Digit 5
6	Digit 6	Digit 6	Digit 6	Digit 6	Digit 6	Tuner	Digit 6	Digit 6
MODE	Device mode selection for the remote control							
PIC SIZE	This button is not available for this TV model or any other device connected to this TV.							
7	Digit 7	Digit 7	Digit 7	Digit 7	Digit 7	Phono	Digit 7	Digit 7
8	Digit 8	Digit 8	Digit 8	Digit 8	Digit 8	Cassette	Digit 8	Digit 8
9	Digit 9	Digit 9	Digit 9	Digit 9	Digit 9	Aux	Digit 9	Digit 9
ACTION	---	Menu	Action, Menu	Menu	Menu	---	---	---
100/-	100	100	100	100	100	100	100	100
0	Digit 0	Digit 0	Digit 0	Digit 0	Digit 0	Digit 0	Digit 0	Digit 0
ENT	---	CH Enter	CH Enter	CH Enter	---	---	---	---
GUIDE/SETUP	---	Guide	Guide	Program	DVD setup	Program	Program	---
INFO/TITLE	TV preview	← TV	INFO	← TV	TITLE= Top menu	← TV	← TV	← TV
FAVORITE/ SUBTITLE	Favorite CH	---	Favorite CH	---	Subtitle	---	---	---
ALPHASORT/ AUDIO	---	---	Alphasort	---	Audio	---	---	---
MENU/ ENTER	Menu open/ Enter	Select	Select	Enter	Enter	---	---	---
▲▼	Menu select	Menu select	Menu select	Menu select	Menu select	---	---	---
◀▶/FAV ◀▶	Menu select/ FAV ◀▶	Menu select	Menu select	Menu select	Menu select	---	---	---
VOL ▲▼	Volume up/down*	Volume up/down*	Volume up/down*	Volume up/down*	Volume up/down*	Volume up/down*	Volume up/down*	---
EXIT/ DVD CLEAR	Exit	Exit	Exit	Exit	DVD clear	Exit/Clear	Exit/Clear	Exit/Clear
CH ▲▼	Channel up/down	Channel up/down	Channel up/down	Channel up/down	---	Channel up/down	---	---
INPUT	TV/Video select	← TV	← TV	VCR input	← TV	Input	← TV	← TV
MUTE	Sound mute*	Sound mute*	Sound mute*	Sound mute*	Sound mute*	Sound mute*	Sound mute*	---
RECALL	On-screen display	On-screen display	On-screen display	On-screen display	On-screen display	---	---	---
CH RTN/ DVD RTN	Previous channel	Previous channel	Previous channel	Previous channel	DVD return	---	---	---
SLOW/ DIR ▶ ◀	---	---	---	Forward ---	Forward Reverse	---	---	---
SKIP/ SEARCH ▶ ◀	---	---	---	---	Forward Reverse	CH forward CH reverse	Forward Reverse	Forward Reverse
REW	VCR →	VCR →	VCR →	Rewind	Rewind	Rewind	Rewind	Rewind
PAUSE/STEP	VCR →	VCR →	VCR →	Pause	Pause	Pause	Pause	Pause
PLAY	VCR →	VCR →	VCR →	Play	Play	Play	Play	Play
FF	VCR →	VCR →	VCR →	F. Forward	F. Forward	F. Forward	F. Forward	F. Forward
TV/VCR	VCR →	Bypass A/B	TV/SAT	TV/VCR	---	---	---	---

DISC AM/FM	---	---	---	---	Disc shift	AM/FM	Disc shift	Deck side A/B switch
STOP	VCR →	VCR →	VCR →	Stop	Stop	Stop	Stop	Stop
REC	VCR →	VCR →	VCR →	Record	---	Record	Record	Record
PIP CH ▲▼	PIP Channel up/down	← TV	← TV	← TV	← TV	← TV	← TV	← TV
PIP	PIP on/off	← TV	← TV	← TV	← TV	← TV	← TV	← TV
MULTI	Strobe	← TV	← TV	← TV	← TV	← TV	← TV	← TV
STILL	PIP Still	← TV	← TV	← TV	← TV	← TV	← TV	← TV
SWAP	PIP Swap	← TV	← TV	← TV	← TV	← TV	← TV	← TV
LOCATE	PIP Locate	← TV	← TV	← TV	← TV	← TV	← TV	← TV
SOURCE	PIP Source	← TV	← TV	← TV	← TV	← TV	← TV	← TV

Notes:

- “---” will send nothing.
- “← TV” will jump to TV.
- “VCR →” will jump to last active VCR or DVD. Active VCR/DVD is defined as the mode that remains for a minimum of 5 seconds, or if a key is pressed in that mode.
- * The VOLUME and MUTE will jump to “TV” by default. When the volume is unlocked, all the devices will have their own volume. The AUDIO1/2 (Receiver, CD) modes will have their own volume even if Volume Lock is on TV, CABLE/SAT, VCR, or DVD. See “Using the Volume Lock feature” on page 15.

Programming the remote control for use with your audio/video devices

Device code setup

1. Refer to the device code table on pages 16–19 to find the code for the brand of your device.

If more than one code is listed, try each one separately until you find one that works.

2. Repeatedly press MODE until the device mode indicator (CABLE/SAT, VCR, DVD, AUDIO1, AUDIO2) lights up.
3. While holding down the RECALL button, press the Channel Number buttons to enter the four-digit code for your device. If a valid code is entered, the mode indicator will blink two times. If an invalid code is entered, the mode indicator will blink one long blink.
4. Point the remote control at the device and press POWER to test the code.

If the device responds to the remote control, you have entered the correct code.

If the device does not respond to the remote control, you may have entered the wrong code. Repeat steps 3 and 4 using another code.
5. To control the TV, repeatedly press MODE until the TV mode indicator lights up.

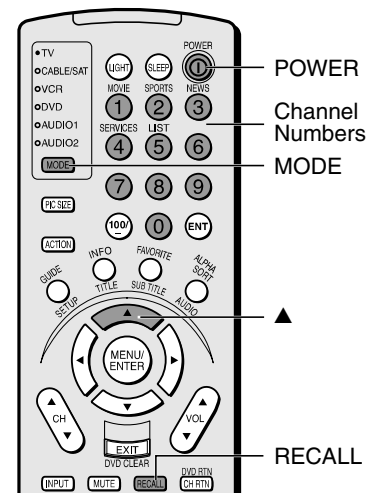

Note:

- Every time you replace the batteries, you must reprogram the remote control.
- Some newer VCRs are capable of working on either of two remote codes. These VCRs have a switch labeled "VCR1/VCR2." If your VCR has this kind of switch and does not respond to any of the codes for your VCR brand, set the switch to the other position (VCR1 or VCR2) and reprogram the remote control.

Searching and sampling the code of a device (991)

If you do not know the device code for a particular target unit, you can cycle the remote through the available codes for that device mode and sample functions in order to find the code that properly operates the desired target device. The keys available to be sampled, provided they are applicable to that mode, are 0, 1, 2, 3, POWER, VOL ▲, CH ▲, PLAY and STOP. Invalid keys will be ignored while in program mode.

To cycle through each available device code and sample its functions:

1. Press MODE to select the mode you want to set up.
2. While holding down RECALL, press 9–9–1. The remote control will enter program mode.
3. Point the remote control at the target device and press POWER (or other function buttons that are available to be sampled).
4. If the device responds to the remote control:

Press RECALL to store the device code.

The mode indicator will blink two times and the remote control will exit program mode.

If the device does not respond to the remote control:

Press ▲, and then press POWER.

Repeat this step until the device responds to the remote control, and then press RECALL.

Note: When a search cycle is complete, the mode indicator will blink three times. The remote control will begin to cycle through the available codes again. If no key is pressed within 10 seconds while programming, the remote control will exit the program mode and return to the previous code.

Verifying the device code (990)

Use this feature to verify the codes for your other electronic devices. The number of blinks after pressing the 1, 2, 3, and 4 buttons is the 4-digit code set up for that mode.

For example, to verify the device code of the VCR mode:

1. Repeatedly press MODE to select VCR mode.
2. While holding down RECALL, press 9–9–0.
3. Press 1 → 2 blinks.
4. Press 2 → 3 blinks.
5. Press 3 → 4 blinks.
6. Press 4 → 5 blinks.

This verifies that the device code of the VCR mode is “2345.”

Using the Volume Lock feature (993)

For the TV, CABLE/SAT, VCR, and DVD modes, the volume controls (VOL ▲▼ and MUTE) can be programmed (locked) to the selected device mode. This feature does not apply to the AUDIO1/2 modes.

For example, to lock the volume controls to always jump to the CABLE/SAT mode:

1. Repeatedly press MODE to select the CABLE/SAT mode.
2. While holding down RECALL, press 9–9–3.
3. Press VOL ▲. The Mode indicator will blink two times (locked).

The following table describes in more detail the Volume Lock implementation.

Volume Locked to:	TV	CBL/SAT	VCR	DVD	AUD1	AUD2
TV (default)	TV	TV	TV	TV	AUD1	AUD2
CBL/SAT	CBL/SAT	CBL/SAT	CBL/SAT	CBL/SAT	AUD1	AUD2
VCR	VCR	VCR	VCR	VCR	AUD1	AUD2
DVD	DVD	DVD	DVD	DVD	AUD1	AUD2
AUD1	AUD1	AUD1	AUD1	AUD1	AUD1	AUD1
AUD2	AUD2	AUD2	AUD2	AUD2	AUD2	AUD2

To reset the volume controls to the original device code:

1. While holding down RECALL, press 9–9–3.
2. Press VOL ▼. The Mode indicator will blink four times (unlocked).

Operational feature Reset (980)

This feature clears all setup features not related to “Device code set up” and resets the Volume Lock to “TV.”

To reset the features:

While holding down RECALL, press 9–8–0.

The Mode indicator will blink two times, and then pause and blink two more times.

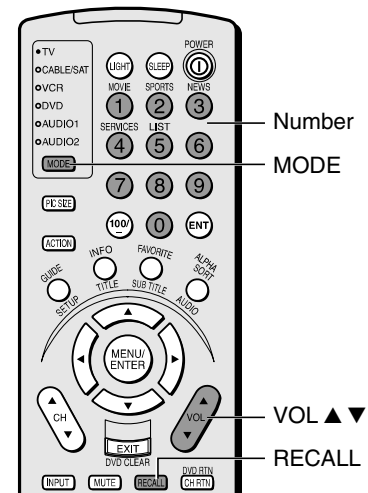

Device code table

Cable box setup codes

Brand name	Code number
ABC	0020, 0022, 0026, 0027, 0030, 0032, 0033, 0036
Allegro	0172, 0334
Americast	0918
Antronix	0041, 0226
Archer	0041, 0172, 0226, 0816
BBT	0286
Belcor	0075
Bell & Howell	0033
Bell South	0918
Cable Star	0075
Cabletenna	0041
Cableview	0041
Century	0172
Citizen	0172, 0334
Colour Voice	0044, 0050
Comtronics	0059
Contec	0038
Digi	0656
Eastern	0021
Emerson	0816
Everquest	0034, 0059
Focus	0419
GC Electronics	0075, 0226
Garrard	0172
Gemini	0034, 0089, 0816
General Instrument	0030, 0295, 0495, 0829
GoldStar	0059, 0163
Goodmind	0816
Hamlin	0028, 0039, 0053, 0278, 0292
Hitachi	0030
Hytex	0026
Jasco	0034, 0172, 0334
Jerrold	0022, 0030, 0031, 0033, 0034, 0043, 0295, 0495, 0829
Linsay	0459
Magnavox	0046
Memorex	0019
Movie Time	0082, 0175
NSC	0082, 0089, 0175
Novaplex	0637
Oak	0026, 0038
Optimus	0040
Panasonic	0019, 0040, 0126
Panther	0656
Paragon	0019
Philips	0044, 0046, 0050, 0172
Pioneer	0042, 0163, 0552, 0896
Popular Mechanics	0419
Prelude	0789
Pulsar	0019
Quasar	0019
RCA	0040
Radio Shack	0034, 0334, 0816, 0902
Realistic	0226
Recoton	0419
Regal	0039, 0278, 0292
Regency	0021
Rembrandt	0030, 0089
Runco	0019

SL Marx	0059
Samsung	0059, 0163
Scientific Atlanta	0027, 0036, 0496, 0896
Seam	0529
Signal	0034, 0059
Signature	0030
Sprucer	0040
StarSight	0441, 0561
Starcom	0022, 0034
Stargate	0034, 0059, 0789, 0816
Starquest	0034
Sylvania	0020
TFC	0329
TV86	0082
Tandy	0277
TeleCaption	0240
Televue	0059
Texscan	0020
Timeless	0437
Tocom	0031, 0032
Toshiba	0019
Tusa	0034
Unika	0041, 0172, 0226
United Artists	0026
Universal	0041, 0075, 0172, 0210, 0226
Viewstar	0046, 0082, 0277
Zenith	0019, 0073, 0544, 0918
Zentek	0419

Satellite Receiver setup codes

Brand name	Code number
AlphaStar	0791
Chaparral	0072, 0235
Curtis Mathes	0080
Echostar	0288, 0299, 0794, 1024
Expressvu	0794
General Instrument	0380, 0646, 0888
HTS	0794
Hitachi	0838
Homecable	0257
Hughes Network Systems	0768
IQ	0229
IQ Prism	0229
JVC	0794
Jerrold	0380, 0646
Legend	0288
Macom	0080
Magnavox	0741, 0743
Memorex	0288, 0743
Next Level	0888
Panasonic	0720
Philips	0741, 0743
Primestar	0380, 0646
RCA	0162, 0411, 0585, 0874
Radio Shack	0888
Realistic	0071
STS	0229
Sony	0658
Star Choice	0888
Toshiba	0080, 0101, 0768, 0809, 1071, 1072, 1073
Uniden	0071, 0093, 0257, 0741, 0743
Zenith	0080, 0875

Device code table

VCR setup codes

Brand name	Code number			
Admiral	0067, 0228	Kenwood	0057, 0060, 0086,	Radix
Adventura	0019		0403	Randex
Aiko	0297	Kodak	0054, 0056	Realistic
Aiwa	0019, 0056, 0326	LXI	0056	
Akai	0060, 0072, 0080,	Lloyd's	0019, 0227	
	0125	Logik	0091	ReplayTV
America Action	0297	MEI	0054	Ricoh
American High	0054	MGA	0062, 0080, 0259	Runco
Asha	0259	MGN Technology	0259	STS
Audiovox	0056	MTC	0019, 0259	Samsung
Beaumarck	0259	Magnasonic	0297	
Bell & Howell	0123	Magnavox	0019, 0054, 0058,	Sanky
Broksonic	0021, 0140, 0203,		0100, 0129, 0168	Sansui
	0228, 0314, 0380,	Magnin	0259	
	0498	Marantz	0054, 0100	Sanyo
CCE	0091, 0297	Marta	0056	
Calix	0056	Matsushita	0054, 0181, 0473	Scott
Canon	0054	Memorex	0019, 0054, 0056,	
Capehart	0039		0058, 0065, 0066,	Sears
Carver	0100		0067, 0123, 0181,	
Cineral	0297		0228, 0259, 0326,	
Citizen	0056, 0297		0473, 1056, 1181,	
Colt	0091		1281	Semp
Craig	0056, 0066, 0091,	Minolta	0061, 0124	Sharp
	0259, 0290	Mitsubishi	0062, 0067, 0080,	Shintom
			0086	Shogun
Curtis Mathes	0054, 0060, 0079,	Motorola	0054, 0067	Singer
	0181	Multitech	0019, 0091	Sony
Cybernex	0070, 0259	NAD	0077	
Daewoo	0039, 0064, 0297,	NEC	0057, 0059, 0060,	Sunpak
	0580		0086, 0123	Sylvania
Daytron	0039	Nikko	0056	
Denon	0061	Nikon	0053, 0272	
Dynatech	0019	Noblex	0259	Symphonic
Electrohome	0056	Olympus	0054	TMK
Electroponic	0056	Optimus	0056, 0067, 0077,	Tatung
Emerex	0051		0123, 0181, 0451,	Teac
Emerson	0019, 0021, 0055,		0473, 1067, 1081,	Technics
	0056, 0062, 0080,		1181, 1281	Teknika
	0087, 0107, 0140,	Optonica	0081	Thomas
	0203, 0227, 0228,	Orion	0021, 0203, 0228,	Tivo
	0231, 0297, 0313,		0314, 0498	Toshiba
	0314, 0380, 0498,	Panasonic	0054, 0096, 0181,	
	0580		0244, 0473, 0635,	Totevision
Fisher	0066, 0073, 0085,		1081, 1181, 1281	Unitech
	0123	Penney	0054, 0056, 0057,	Vector
Fuji	0052, 0054		0059, 0061, 0073,	Vector Research
Funai	0019	Pentax	0061, 0124	Video Concepts
GE	0054, 0067, 0079,	Philco	0054, 0228, 0498	Videosonic
	0221, 0259	Philips	0054, 0081, 0100,	Wards
			0129, 0637, 1100,	
Garrard	0019		1200	
Go Video	0451, 0545, 0662	Pilot	0056	White Westinghouse
GoldStar	0056, 0057	Pioneer	0077, 0086	XR-1000
Gradiente	0019, 0027	Portland	0039	Yamaha
HI-Q	0066	Profitronic	0259	Zenith
Harley Davidson	0019	Proscan	0079, 0221	
Harman/Kardon	0057, 0100	Protec	0091	
Harwood	0087, 0091	Pulsar	0058, 0070	
Headquarter	0065	Quarter	0065	
Hitachi	0019, 0060, 0061,	Quartz	0065	
	0124	Quasar	0054, 0096, 0181,	
Hughes Network			0473, 1181	
Systems	0061	RCA	0054, 0061, 0067,	
JVC	0027, 0060, 0086,		0079, 0096, 0124,	
	0403		0125, 0168, 0221,	
Jensen	0060		0259	
KEC	0056, 0297	Radio Shack	0019, 1056	
KLH	0091			

Device code table

DVD setup codes

Brand name	Code number
Aiwa	0660
Denon	0509, 0653
GE	0541
Harman/Kardon	0601
JVC	0577, 0642
Kenwood	0553
Magnavox	0522
Marantz	0558
Mitsubishi	0540
Onkyo	0522, 0646
Optimus	0590
Panasonic	0509, 0651
Philips	0522, 0558
Pioneer	0544, 0590, 0651
Proscan	0541
RCA	0541
Samsung	0592
Sharp	0649
Sherwood	0652
Sony	0552
Technics	0509
Theta Digital	0590
Toshiba	0522
Yamaha	0509, 0564
Zenith	0522, 0610

Laser Disc setup codes

Brand name	Code number
Aiwa	0222
Carver	0083, 0213, 0342
Denon	0078, 0191
Disco Vision	0042
Funai	0222
Harman/Kardon	0213
Hitachi	0042
Magnavox	0213, 0236
Marantz	0083, 0213
Mitsubishi	0078
NAD	0078
Optimus	0078
Panasonic	0223
Philips	0083, 0213
Pioneer	0042, 0078
Quasar	0223
Realistic	0222
Samsung	0342
Sega	0042
Sony	0212, 0220
Technics	0223
Theta Digital	0213
Yamaha	0236

CD Player setup codes

Brand name	Code number
ADC	0037
Adcom	0174, 0253
Aiwa	0143, 0176
Akai	0175
Audio Alchemy	0213
Audio-Technica	0189
BSR	0213, 0264
Burmester	0439
California Audio Labs	0048, 0322
Carrera	0213
Carver	0176, 0198, 0318, 0456
DAK	0264
DKK	0019
Denon	0022, 0892
Emerson	0174, 0183, 0324, 0488
Fisher	0107, 0193, 0198, 0361
GE	0028
Garrard	0264, 0299, 0412, 0439
Genexxa	0051, 0183, 0324
Harman/Kardon	0176, 0192, 0445
Hitachi	0051, 0174
JVC	0091
Kenwood	0047, 0056, 0209, 0645, 0700, 0845
Kodak	0306
Krell	0176
Kyocera	0037
LXI	0324
Linn	0176
Luxman	0112
MCS	0048
MTC	0439
Magnavox	0176, 0324
Marantz	0048, 0176, 0199
McIntosh	0306
Mission	0176
NAD	0038, 0318
NEC	0253
NSM	0176
Nikko	0183, 0189, 0193
Onkyo	0120, 0887
Optimus	0019, 0051, 0056, 0106, 0164, 0198, 0213, 0215, 0299, 0324, 0361, 0439, 0445, 0456, 0487, 1082
Panasonic	0048, 0322, 0386, 0771
Parasound	0213, 0439
Philips	0176, 0306, 0645
Pioneer	0051, 0263, 0324, 0487, 1082
Proton	0176
QED	0176
Quasar	0048
RCA	0028, 0072, 0174, 0198, 0324, 0783
Realistic	0174, 0183, 0198, 0199, 0439
Rotel	0176, 0439
SAE	0176
STS	0037
Sansui	0176, 0221, 0324
Sanyo	0106, 0198
Scott	0174, 0183, 0324
Sears	0324
Sharp	0056, 0199, 0880
Sherwood	0199, 0215, 0445, 1086
Sony	0019, 0204, 0509, 0623, 0624
Soundesign	0164
Tascam	0439
Teac	0193, 0199, 0412, 0439
Technics	0048, 0322
Toshiba	0038, 0318
Vector Research	0213
Victor	0091
Wards	0072, 0176
Yamaha	0055, 0189, 0206
Yorx	0480

Device code table

Amplifier setup codes

Brand name	Code number
Aiwa	0425
Carver	0288
Curtis Mathes	0319
Denon	0179
GE	0097
Harman/Kardon	0911
JVC	0350
Linn	0288
Magnavox	0288
Marantz	0288
Optimus	0319, 0414
Panasonic	0327
Philips	0288, 0911
Pioneer	0032, 0319
Realistic	0414
Sony	0239, 0708
Soundesign	0097
Technics	0327
Toshiba	0372
Victor	0350
Wards	0032, 0097
Yamaha	0373

Cassette Player setup codes

Brand name	Code number
Aiwa	0048, 0216, 0219
Akai	0302
Carver	0048
Denon	0095
Fisher	0093
Garrard	0327, 0458
Harman/Kardon	0048, 0201
JVC	0263, 0292
Kenwood	0089
Magnavox	0048
Marantz	0028, 0048
Mitsubishi	0302
Onkyo	0154, 0155, 0301
Optimus	0046, 0239, 0356, 0458
Panasonic	0248
Philips	0048
Pioneer	0046, 0118, 0239
Revox	0209
Sansui	0028, 0048
Sherwood	0356
Sony	0189, 0262, 0310
Teac	0327
Technics	0248
Toshiba	0360, 0361
Victor	0292
Wards	0046
Yamaha	0113, 0116

Misc. Audio setup codes

Brand name	Code number
Aiwa	0029, 0178, 0423
Fisher	0071
Harman/Kardon	0496
JBL	0496
JVC	0092
Jerrold	0478, 0539
Nikko	0395
Paramount Pictures	0336
RCA	0075
SSI	0336
Schneider	0395
Scientific Atlanta	0479
Sony	0029, 0178, 0595
Soundesign	0395
Starcom	0478
Yorx	0395

Receiver setup codes

Brand name	Code number
ADC	0550
Adcom	0635
Aiwa	0140, 0177, 0208, 0424, 1108, 1424
Akai	0095, 0243
Capetronic	0550
Carver	0027, 0061, 0208, 0379, 1108, 1208
Casio	0214
Clarinette	0214
Curtis Mathes	0099
Denon	0023, 0292, 0790, 1123, 1179
Emerson	0443
Fisher	0061, 0238, 0379
Garrard	0443, 0482
Harman/Kardon	0129, 0208, 0910
Inkel	0081
JBL	0129
JVC	0093
Kenwood	0046, 0061, 0096, 0205, 0332, 0333, 1046, 1071, 1332, 1588
Koss	0443
LXI	0200
Linn	0208
Lloyd's	0214
MCS	0058, 0365
Magnavox	0147, 0208, 0214, 0410, 0550, 1108, 1208
Marantz	0058, 0147, 0208, 1108, 1208
Modulaire	0214
NAD	0339
NEC	0254
Nakamichi	0116, 0366
Onkyo	0119, 0154, 0399
Optimus	0061, 0099, 0196, 0200, 0205, 0238, 0550, 0689, 0757, 0820, 1042
Panasonic	0058, 0328, 0537, 1537
Penney	0214
Philips	0208, 0410, 1108, 1208

Pioneer	0033, 0099, 0169, 0550, 0649, 1042
Proscan	1273
Quasar	0058
RCA	0073, 0365, 0379, 0549, 0550, 1173, 1273
Realistic	0182, 0200, 0214
Sansui	0208, 0212, 0365, 1108
Sanyo	0238, 0820
Scott	0182, 0341
Sharp	0205
Sherwood	0081, 0510, 0521
Sony	0177, 0187, 0493, 1061, 1077, 1177, 1277
Soundesign	0689
Sunfire	0332, 0333, 1071, 1332
Teac	0182, 0482
Technics	0058, 0227, 0328, 0537, 1327, 1328, 1537
Thorens	1208
Victor	0093
Wards	0033, 0073, 0099, 0177, 0208
Yamaha	0195, 0205, 1195
Yorx	0214
Zenith	0876

Learning about the remote control

Only the buttons used for operating the TV are described here.

POWER turns the TV on and off.

SLEEP allows access to the automatic TV shut-off function (page 41).

LIGHT The first press of the LIGHT button lights the keypad and turns on the Illumination mode. With the Illumination mode on, pressing any other key lights the keypad for 5 seconds (10 seconds if the remote control is in programming mode). Subsequent presses of the LIGHT button toggle the Illumination mode on and off.

Channel Numbers (0-9, 100) allow direct access to channels (page 24).

MODE cycles through the six device modes (TV, CABLE/SAT, VCR, DVD, AUDIO1, AUDIO2). The mode indicator will remain lit for 10 seconds.

FAVORITE allows access to the multi-window feature (page 30).

INFO allows access to multi-window feature (page 30).

MENU allows access to on-screen programming menus (page 21).

ENTER sets programming menu information (page 21).

▲▼◀▶ Buttons select or adjust programming menus (page 21).

(FAV) ◀▶ Buttons select your favorite channels (page 25).

VOL ▲▼ adjusts the volume level.

EXIT exits programming menus (page 21).

CH ▲▼ cycles through programmed channels (page 24).

CH RTN returns to the last viewed channel (page 25).

TV/VCR toggles between TV and VCR modes.

RECALL displays on-screen information (page 46).

MUTE mutes the sound (page 42).

INPUT selects the video input source (page 39).

PIP Buttons allow access to PIP functions (page 28).

PIP turns the PIP on and off.

PIP CH ▲▼ selects the PIP channel.

MULTI allows access to the multi-window feature.

STILL freezes the PIP picture.

SWAP switches the main and PIP pictures.

LOCATE changes the position of the PIP picture.

SOURCE selects the PIP signal input source.

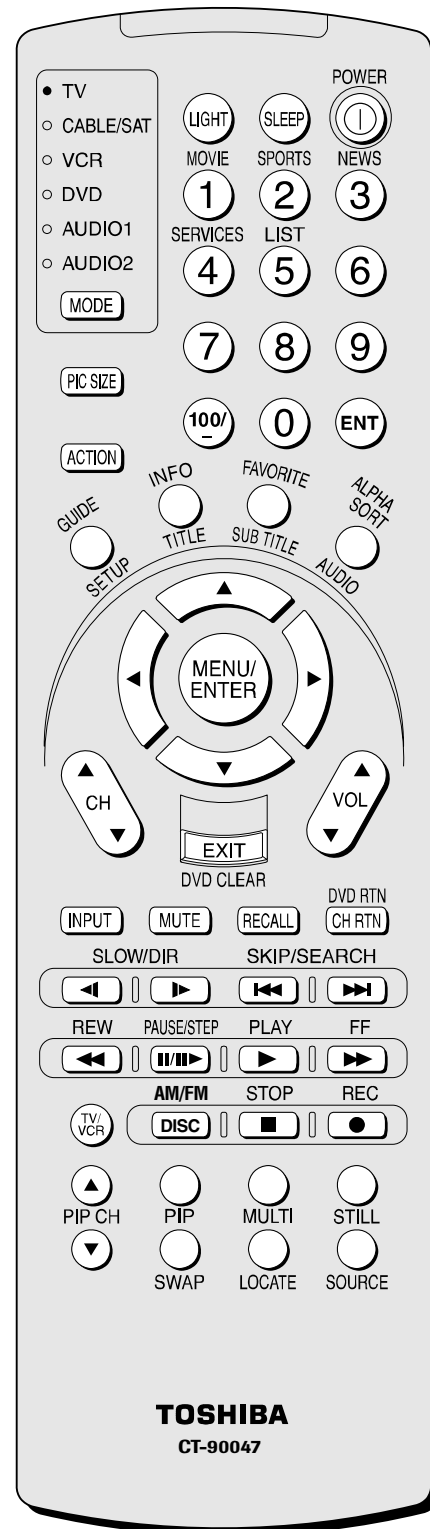

Setting up your TV

Learning about the menu system

After you have installed the batteries and programmed the remote control, you will need to set some preferences on the TV using the menu system. You can access the menus using the buttons on your TV or remote control.

- Press MENU to display the menu system.
- Press ◀ or ▶ to select a menu.
- Press ▲ or ▼ to select an item.
- Press ◀ or ▶ to select or adjust a setting.
- If you do not make a selection within 15 seconds, the main menus close automatically (6 seconds for the other menus).
- To close an on-screen display instantly, press EXIT.

All menu adjustments are saved automatically, whether you press EXIT to close the display or not.

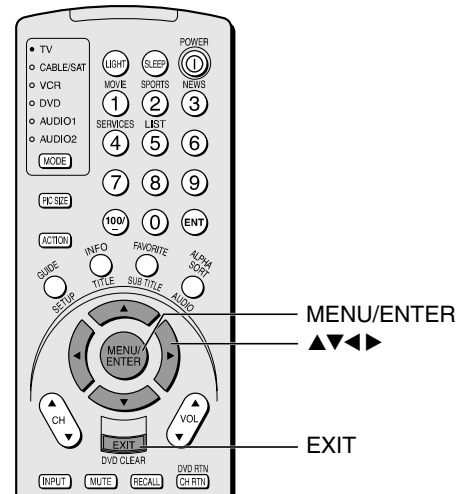
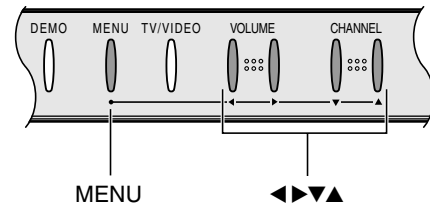
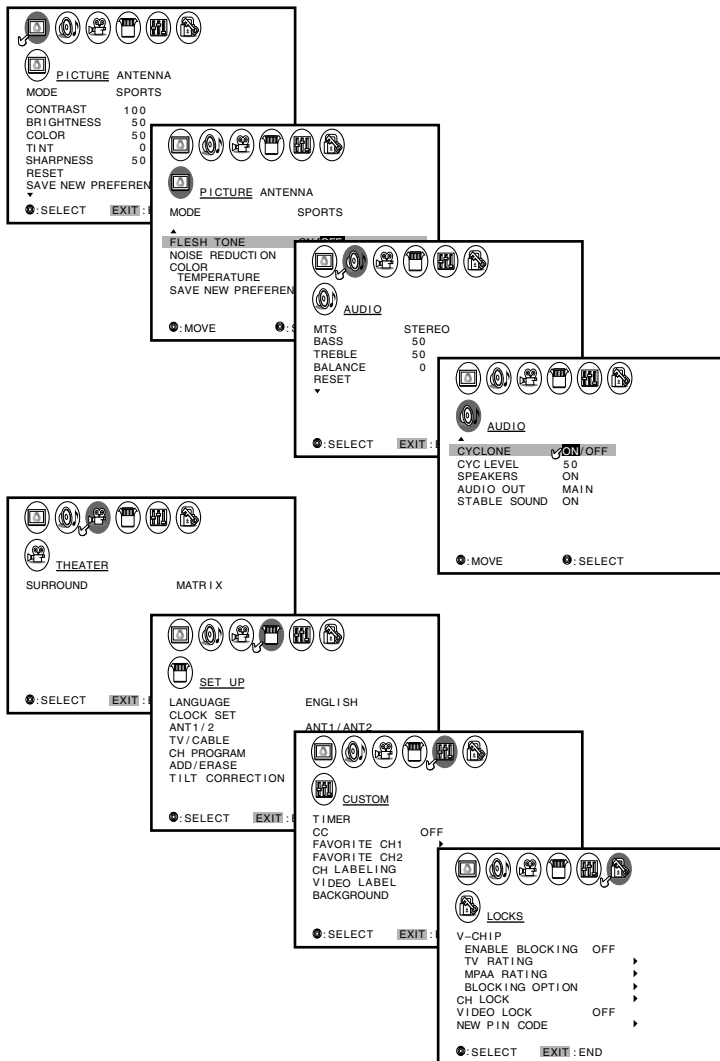

Note:

- The menu illustrations on the following pages have been distorted for easy reference.
- You can change the background of the menu. See page 46 for details.

Changing the on-screen display language

You can choose from three different languages (English, French and Spanish) for the on-screen display of adjustment menus and messages.

To select an on-screen display language:

1. Press MENU, and then press ◀ or ▶ until the SET UP menu appears.
2. Press ▲ or ▼ to highlight LANGUAGE.

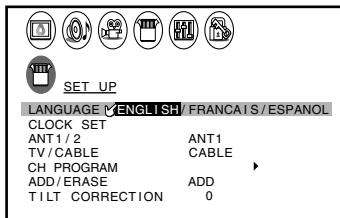

3. Press ◀ or ▶ to highlight your desired language.

Selecting the antenna input

You can connect to two different antenna signal sources (ANT 1 or ANT 2).

To select the antenna input using the menu system:

1. Press MENU, and then press ◀ or ▶ to highlight the SET UP menu.
2. Press ▲ or ▼ to highlight ANT 1/2.

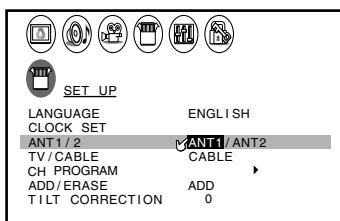

3. Press ◀ or ▶ to highlight either ANT 1 or ANT 2, depending on the antenna terminal you wish to use.

Using the TV/VIDEO button to select the antenna input

To select the antenna input using the TV/VIDEO button:

1. Press the TV/VIDEO button on the TV (see illustrations below). The current signal source displays in purple.

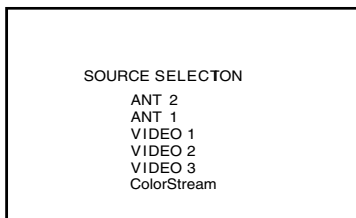

Pressing TV/VIDEO on the TV changes the current signal source.

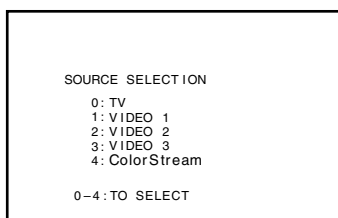

Pressing INPUT on the remote control displays the current signal source. (To change the source, select 0-4; to change the antenna input, use the menu or the TV/VIDEO button on the TV.)

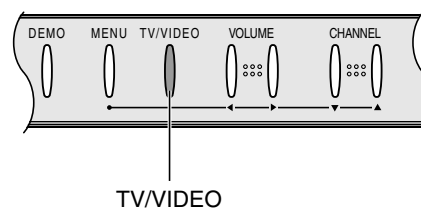
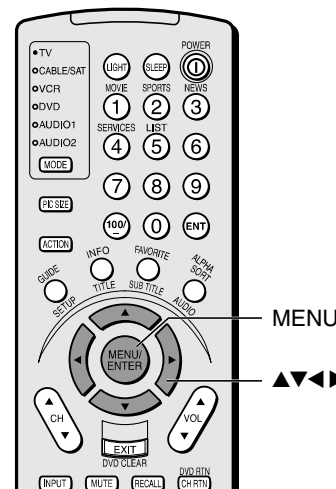
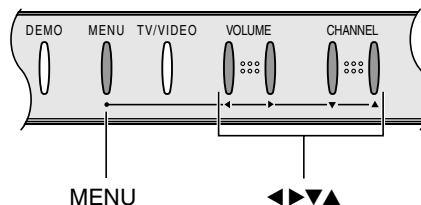

Adding channels to the TV's memory

When you press Channel ▲ or ▼, your TV will stop only on the specific channels stored in the TV's channel memory. Follow the steps below and on the next page to program channels into the TV's memory.

Programming channels automatically

Your TV can automatically detect all active channels in your area and store them in its memory. After the channels are stored automatically, you can manually add or erase individual channels. If you use both ANT-1 and ANT-2 input sources, you must program channels for each.

To program channels automatically:

1. Press MENU, and then press ◀ or ▶ until the SET UP menu appears.
2. Press ▲ or ▼ until TV/CABLE is highlighted.
3. Press ◀ or ▶ to highlight either TV or CABLE, depending on which you use. If you use an antenna, highlight TV. If you use cable, highlight CABLE.

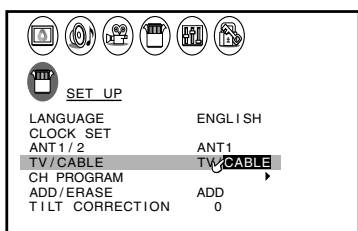

4. Press ▼ to highlight CH PROGRAM.

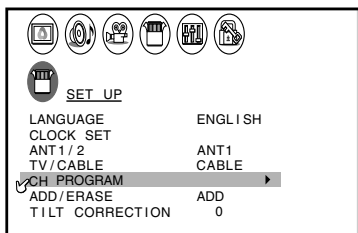

5. Press ◀ or ▶ to start channel programming. The TV will automatically cycle through all the TV or cable channels (depending on which you selected), and store all active channels in the channel memory.

While the TV is cycling through the channels, the message "Programming Now—Please Wait" appears.

6. When channel programming is complete, the message "Completed" appears.
7. Press CH ▲ or ▼ to view the programmed channels.

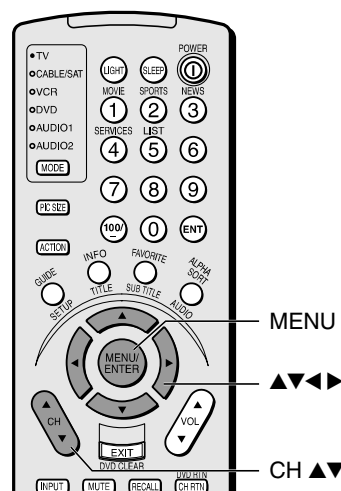

Adding and erasing channels manually

After you have programmed the channels automatically, you can manually add or erase specific channels.

To manually add or erase channels:

1. Select the channel you want to add or erase. If you are adding a channel, you must select the channel using the Channel Number buttons.
2. Press MENU, and then press ◀ or ▶ until the SET UP menu appears.
3. Press ▲ or ▼ to highlight ADD/ERASE.

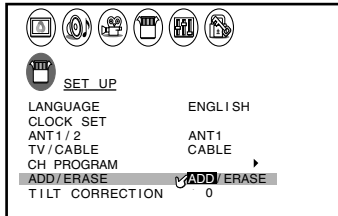

4. Press ◀ or ▶ to select ADD or ERASE, depending on the function you want to perform.
5. Repeat steps 1–4 for other channels you want to add or erase.

Adjusting the tilt correction feature

When you install the TV or change the direction of the TV, the picture may become tilted because of the earth's magnetic field. If this happens, make the following adjustment.

To adjust the tilt correction:

1. Press MENU, and then press ◀ or ▶ until the SET UP menu appears.
2. Press ▲ or ▼ to highlight TILT CORRECTION.
3. Press ◀ or ▶ to correct the picture tilt between +10 and -10.

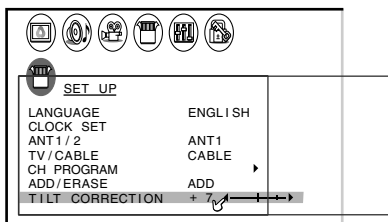

Changing channels

To change to the next programmed channel:

Press Channel ▲ or ▼ on the TV or remote control.

To change to a specific channel (programmed or unprogrammed):

Press the Channel Number buttons (0–9 and 100).

For channels 100 and higher, press the 100 button and then the next two numbers. For example, to select channel 125, press 100–2–5.

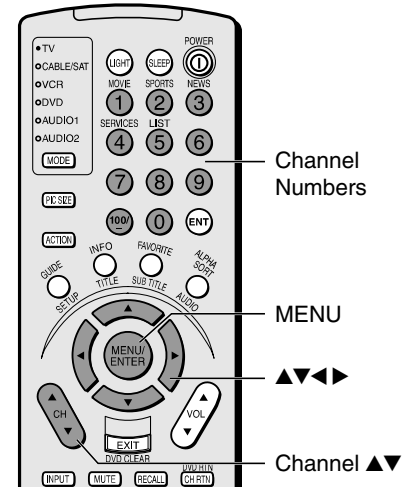
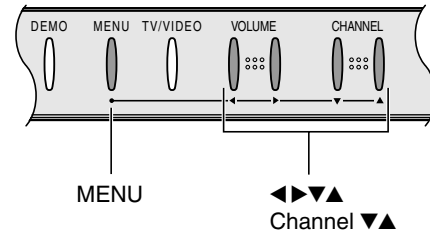

Using the TV's features

Adjusting the channel settings

Switching between two channels

You can switch between two channels without entering an actual channel number each time.

To switch between two channels:

1. Select the first channel you want to view.
2. Select a second channel with the Channel Number buttons (0-9, 100).
3. Press CH RTN. The previous channel will be displayed.

Each time you press CH RTN, the TV will switch back and forth between the two channels.

Programming your favorite channels

You can preset up to 9 of your favorite channels each for FAVORITE CH 1 and FAVORITE CH 2 modes using the Favorite Channel Programming feature. Because this feature scans through only your favorite channels, it allows you to skip other channels you do not normally watch.

To program your favorite channels:

1. Press MENU, then press ◀ or ▶ until the CUSTOM menu appears.
2. Press ▲ or ▼ to highlight FAVORITE CH1 or FAVORITE CH2.

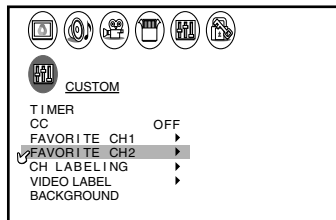
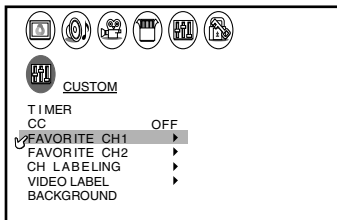

3. Press ◀ or ▶ to display the FAVORITE CH1 menu, for example.

CH INPUT will be highlighted.

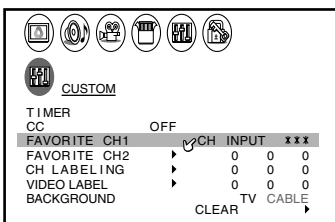

4. Press the Channel Number buttons to enter one of your favorite channels.
5. Press ENTER.
6. Repeat steps 4 and 5 for other channels.

To select your favorite channels:

Press (FAV) ◀ or ▶.

To scan your favorite channels in a 9-picture multi-window:

Press FAVORITE (see page 30 for details).

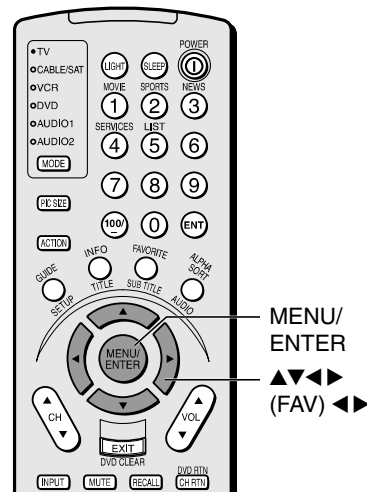
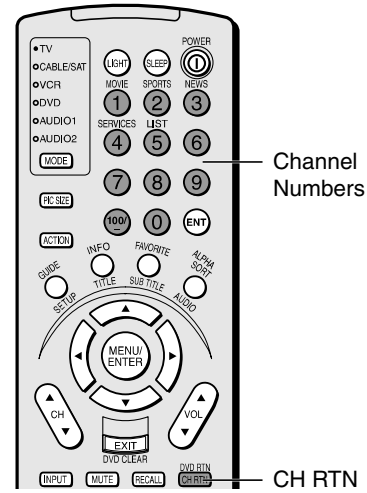

Note:

- The (FAV) ◀▶ buttons will operate as the menu ◀▶ buttons while the menu display is on the screen.
- The favorite channel feature is not available in ANT2 mode.

To clear your favorite channels:

1. Press MENU, and then press ◀ or ▶ until the CUSTOM menu appears.
2. Press ▲ or ▼ to highlight FAVORITE CH2, for example.
3. Press ◀ or ▶ to display the FAVORITE CH2 menu.

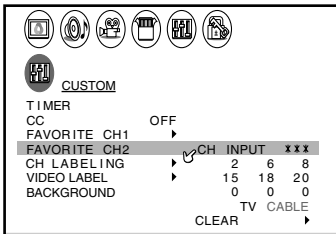

4. Press ▲ or ▼ to highlight CLEAR, and then press ▶ or ◀ until "0" replaces the channel numbers you have programmed.

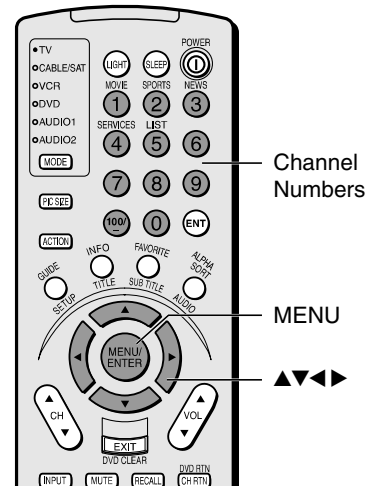
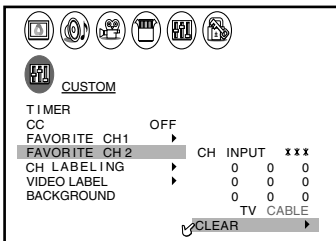

Labeling channels

Channel labels appear above the on-screen channel number display each time you turn on the TV, select a channel, or press the RECALL button. You can choose any four characters to identify the channels.

To create channel labels:

1. Press MENU, and then press ◀ or ▶ until the CUSTOM menu appears.
2. Press ▲ or ▼ to highlight CH LABELING.
3. Press ◀ or ▶ to display the CH LABELING menu.
CH INPUT will be highlighted.

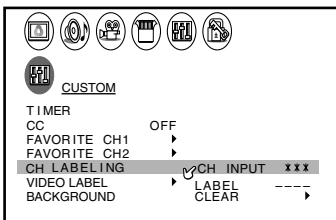

4. Press the Channel Number buttons to select the channel you want to label.

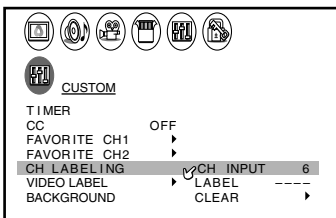

5. Press ▼ to highlight LABEL.

- Repeatedly press ◀ or ▶ to select a character for the first space, and then press ENTER.

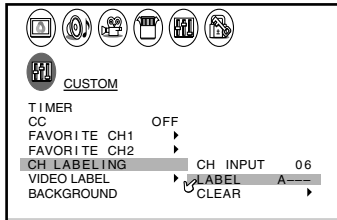

- Repeat step 6 to enter the rest of the characters.

If you would like a blank space in the label name, you must choose an empty space from the list of characters. Otherwise, a dash “-” will appear in that space.
- Repeat steps 4 through 6 for other channels. You can assign labels to a maximum of 32 channels.

To erase channel labels:

- Press MENU, then press ◀ or ▶ until the CUSTOM menu appears.
- Press ▲ or ▼ to highlight CH LABELING.
- Press ◀ or ▶ to display the CH LABELING menu.
- Press ▼ to highlight CH INPUT, and then select the channel you want to clear with the Channel Number buttons.
- Press ▼ to highlight CLEAR.

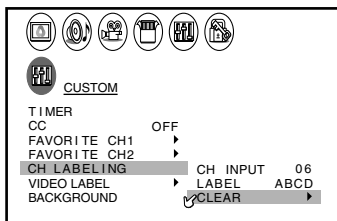

- Press ◀ or ▶ to erase the channel label.
- Repeat steps 4–6 to erase other channel labels.

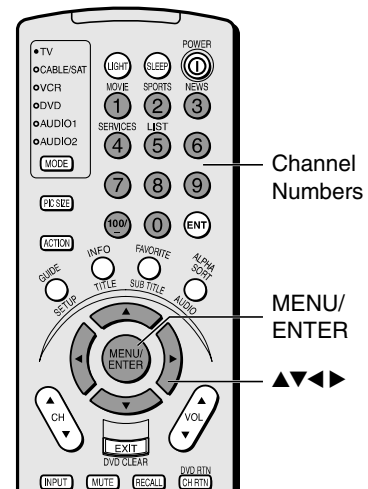

Watching picture-in-picture (PIP)

The picture-in-picture (PIP) feature allows you to watch two pictures at the same time. The smaller picture can come from a TV broadcast or an external source, such as a VCR.

To display a TV broadcast as a small picture:

1. Turn on the TV and select the program you want to watch.
2. Press PIP once to display a small picture. A window 1/9 the size of the screen will appear. Press PIP a second time to display a 1/16-size window.

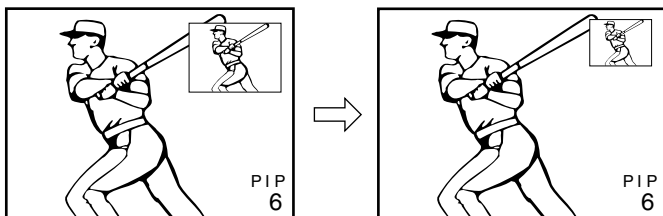

3. Press PIP CH ▲▼ to choose the program you want to be displayed as a small picture.

If the V-CHIP feature is active and you try to watch a TV program that exceeds the rating limits you set, the TV will enter into the program block mode. See “Using the V-CHIP menu” on page 32.

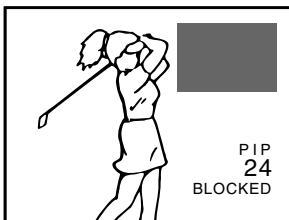

To display a picture from an external source as a small picture:

1. Make sure you have connected the external source equipment properly. For more information, see the “Connecting your TV” on page 5.
2. Turn on the TV and select the program you want to watch.
3. Press PIP once to display a small picture. A window 1/9 the size of the screen will appear. Press PIP a second time to display a 1/16-size window.
4. Repeatedly press SOURCE to select the input source (VIDEO 1, VIDEO 2, or VIDEO 3) for the small picture. The selected source will be displayed in purple. ColorStream cannot be selected.
5. You can play a tape as the small picture or select a channel for the small picture using the VCR’s channel button.

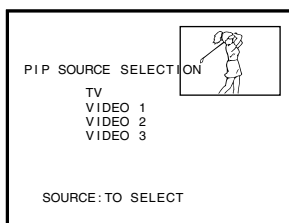

To turn PIP off:

Press PIP once or twice, depending on the size of the small picture screen you selected.

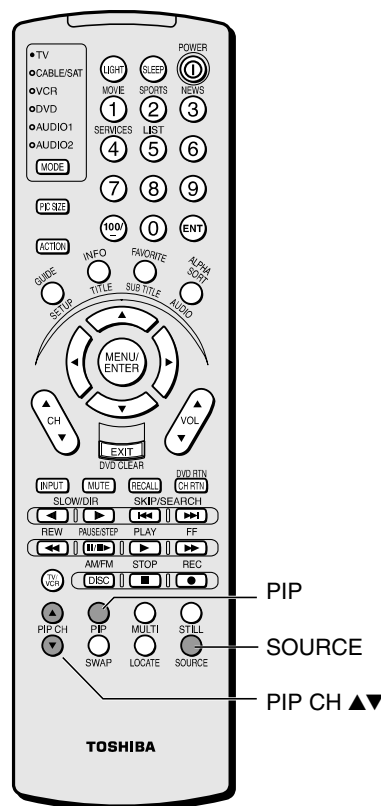

Note:

- PIP cannot be turned on when the ColorStream input is being viewed.
- You cannot display the signal sources input through the ANT-2 terminal as a small picture.
- You can choose to hear the sound of either the main or PIP picture (see “Selecting the audio out sound” on page 45).

Switching the main and small pictures

Press SWAP while you are using the PIP feature to switch the main and small pictures. The main and small pictures will switch each time you press the SWAP button.

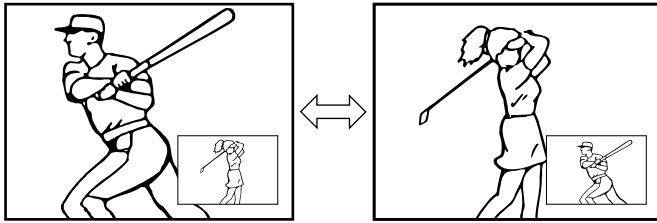

Changing the position of the small picture

Press LOCATE repeatedly while you are watching a small picture. The display position of the small picture will change in the following order:

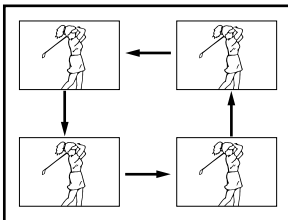

Freezing the small picture

Press STILL while you are watching a small picture. The small picture will become a still picture. To return to the moving picture, press STILL again.

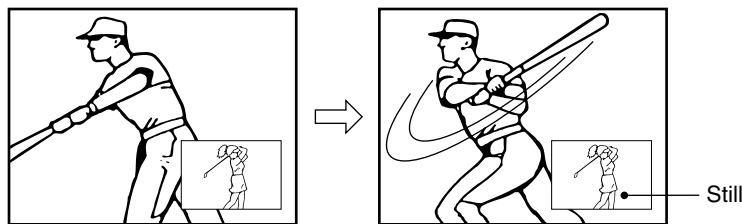

Using the Multi-Window feature

The Multi-Window feature provides two channel search modes. One is the Preview that scans the channels programmed in the TV memory by the CH PROGRAM function (6-picture multi-search), and the other is the Favorite that scans the channels programmed in the TV memory by the FAVORITE CH function (9-picture multi-search).

The Strobe function is convenient when watching a quickly moving picture such as a sports program.

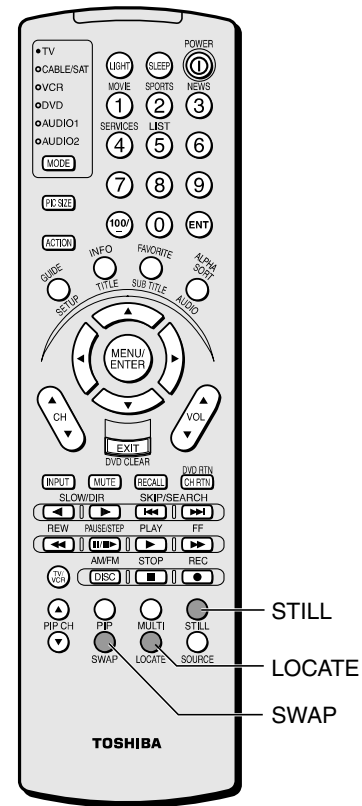

STILL
LOCATE
SWAP

Using the preview function

Press INFO to scan the channels you previously programmed into the TV's memory (see "Adding channels to the TV's memory" on page 23). A 6-picture multi-window scan will start.

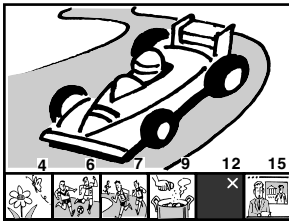

To cancel the preview function:
Press INFO again.

Using the favorite function

1. Press FAVORITE to scan the channels you previously programmed into the TV's memory (see "Programming your favorite channels" on page 25). A 9-picture multi-window scan will start. The first window will display as a moving picture.
2. Press ▲▼◀▶ to select the channel you want to watch. The selected channel will display as a moving picture in the 9-picture multi-window.
3. Press ENTER to display the channel you selected in step 2 as a normal picture.

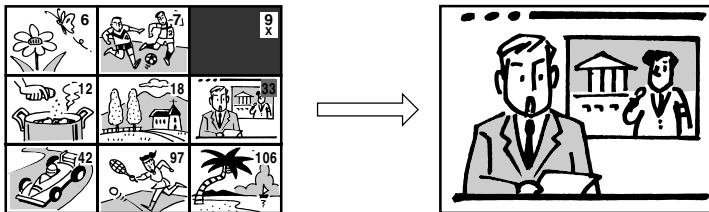

Each time you press FAVORITE, the display will change in the following order:

FAVORITE CH1 — FAVORITE CH2 — Off

To cancel the favorite function:
Press FAVORITE again.

Using the strobe function

Press MULTI to start the strobe function. A 9-picture multi-window strobe starts for the current main picture.

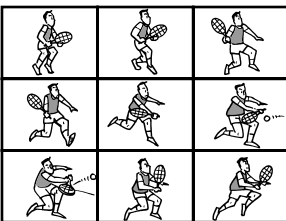

For example, you can strobe the action of the TV program you are watching, or view a decisive moment of a sports program that was previously recorded.

To cancel the strobe function:
Press MULTI again.

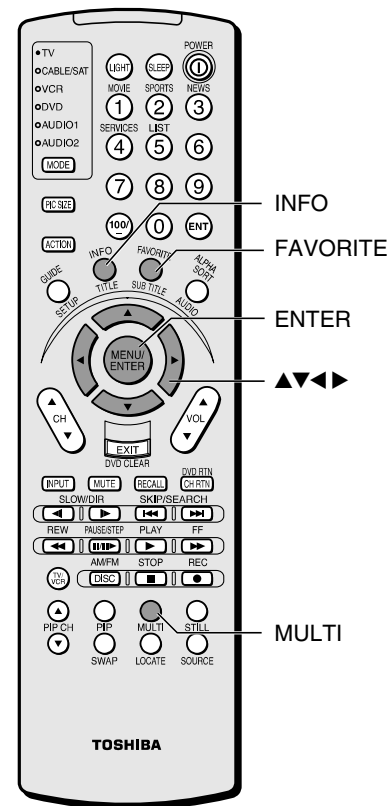

Note:

- A program or channel you set up as blocked in the Locks menu may not always display as blocked during INFO (preview) or FAVORITE multi-window scanning. When blocked properly, the program will appear as a black window with an "X" under the channel number.
- The preview (INFO) function does not work when ANT 2 mode is selected.
- The INFO (preview), FAVORITE, and MULTI (strobe) functions do not work when the main picture source is ColorStream.

Using the LOCKS menu

The LOCKS menu includes the V-Chip, CH Lock, Video Lock, and New PIN Code functions. You can use these functions after entering the correct PIN code.

Entering the PIN code

1. Press MENU, and then press ◀ or ▶ until the LOCKS menu appears.

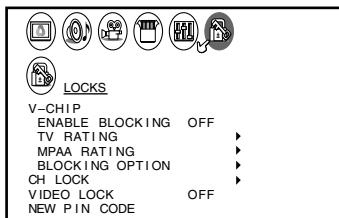

2. Press ▲ or ▼ to display the pin code entering mode.
 - Factory reset status: Set your 4-digit code by pressing the Number buttons (0–9).
 - When the PIN code is already stored: Press the Channel Number buttons (0–9) to enter the 4-digit PIN code used for blocking channels.

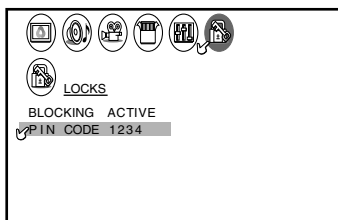

If a wrong PIN code is entered, the message “Incorrect” will appear. Enter the code again.

If you cannot remember the PIN code you stored, while you are in the PIN code entering mode, press RECALL four times within 5 seconds. The PIN code you stored will be released (returned to factory reset status).

3. Press ENTER to display the LOCKS menu.

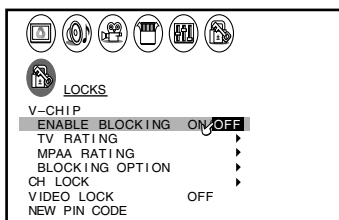

Continue to set each item following the steps on the next page.

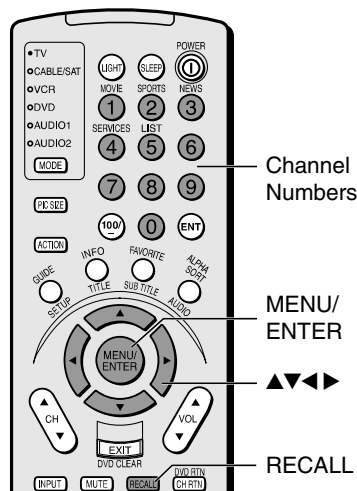

Using the V-CHIP menu

Some TV programs and movies include signals that classify the content of the program (violence, sex, dialog, language). The V-CHIP control feature in this TV detects the signals and blocks the programs according to your selections. To use this feature, perform the following setup.

ENABLE BLOCKING

1. From the LOCKS menu, select ENABLE BLOCKING.
2. Press ◀ or ▶ to select ON or OFF.
ON : To enable your setting (Lock)
OFF: To release your setting (Unlock)

Note: The CH LOCK function is not affected by this selection.

TV RATING (Independent rating system for broadcasters)

1. From the LOCKS menu, select TV RATING.
2. Press ◀ or ▶ to display the TV RATING menu.
3. Press ▼ or ▲ to select item.
4. Press ▶ to lock (displays "X")
Press ◀ to unlock (displays "✓")
5. Repeat steps 3 and 4 to set the next item.

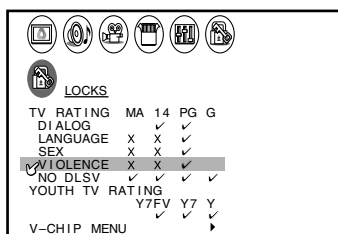

The TV age-based ratings and content themes you can lock are listed in the table below.

Ratings	Description and Content themes
MA	Mature Audience Only (This program is specifically designed to be viewed by adults and therefore may be unsuitable for children under 17.) L) Crude or indecent language S) Explicit sexual activity V) Graphic violence
14	Parents Strongly Cautioned (This program contains some material that many parents would find unsuitable for children under 14 years of age.) D) Intensely suggestive dialog L) Strong, coarse language S) Intense sexual situations V) Intense violence
PG	Parental Guidance Suggested (This program contains material that parents may find unsuitable for younger children.) D) Some suggestive dialog L) Infrequent coarse language S) Some sexual situations V) Moderate violence
G	General Audience (Most parents would find this program suitable for all ages.)
Y7, Y7FV	Directed to Older Children (This program is designed for children age 7 and above. Note: Programs in which fantasy violence may be more intense or more combative than other programs in this category are designated Y7FV.)
Y	All Children (This program is designed to be appropriate for all children)

LOCKS menu

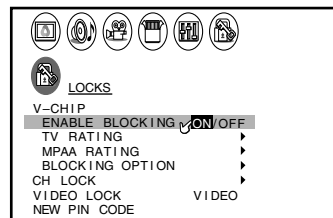

To select each item:
Press ▼ or ▲.

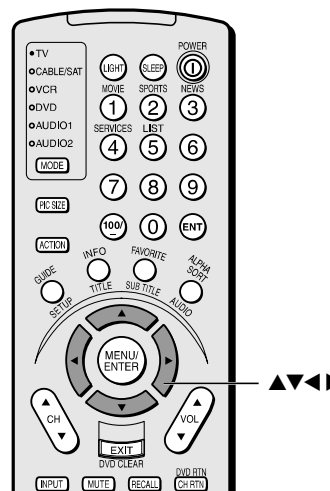

Press RECALL to display the rating of the TV program you are currently watching.

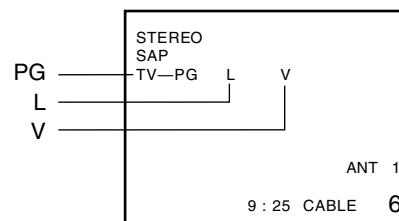

MPAA RATING (Independent rating system for movies)

1. From the LOCKS menu, select MPAA RATING.
2. Press ◀ or ▶ to display the MPAA RATING menu, and then press ▼ or ▲ to highlight MPAA RATING.
3. Press ▶ to lock ("X") or ◀ to unlock ("✓").

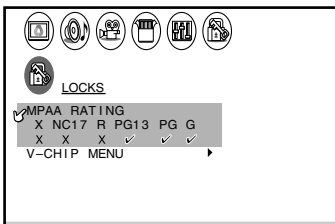

The movie ratings you can lock are described as follows:

- X : X-rated (For adults only)
- NC17 : Not intended for anyone 17 and under
- R : Restricted (Under 17 requires accompanying parent or adult guardian.)
- PG13 : Parents Strongly Cautioned (Some material may be inappropriate for children under 13)
- PG : Parental Guidance Suggested (Some material may not be suitable for children)
- G : General Audience (Appropriate for all ages)

BLOCKING OPTION

1. From the LOCKS menu, select BLOCKING OPTION.
2. Press ◀ or ▶ to display the BLOCKING OPTION menu, and then press ▲ or ▼ to select the item.

MPAA UNRATED:

Press ◀ or ▶ to select ON (Lock) or OFF (Unlock) for unrated programs on MPAA rating system.

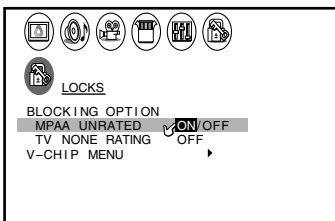

TV NONE RATING:

Press ◀ or ▶ to select ON (lock) or OFF (unlock) for programs rated NONE in the TV PARENTAL GUIDELINES.

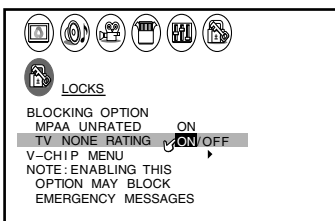

V-CHIP MENU:

Press ◀ or ▶ to return to the LOCKS menu.

LOCKS menu

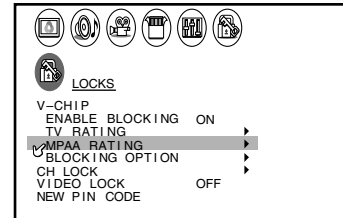

To select each item:

Press ▼ or ▲.



Caution:

Be aware that setting the TV None Rating to ON may block emergency information. The menu will display the note, "Enabling this option may block emergency messages" to warn you of this possibility.

Note:

The picture-in-picture (PIP) will not be locked even if the TV None Rating is set to ON (locked).

Unlocking programs temporarily

1. If you try to watch a TV program that exceeds the rating limits you set, the TV will enter into the program lock mode.

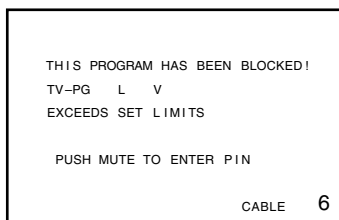

2. If you want to watch the locked program temporarily, press MUTE.
3. Press the Channel Number buttons (0-9) to enter the 4-digit PIN code you stored (see “Entering the PIN code” on page 31).

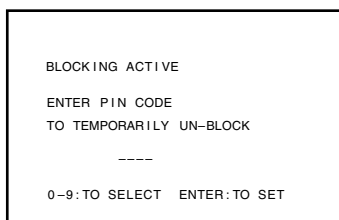

4. Press ENTER.

If the number is correct, the lock mode will be released and the normal picture will appear.

All locking is disabled until the TV is turned off, and will be enabled when the TV is turned on again.

If a wrong PIN code is entered, the message “Incorrect PIN code” appears. Enter the code again.

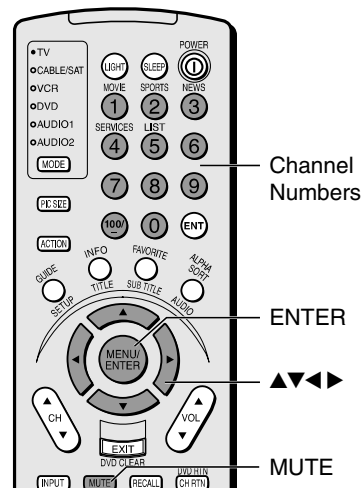

Locking channels

With the CH LOCK feature, you can lock specific channels. You will not be able to tune locked channels with the Channel ▲▼ buttons or Channel Number buttons unless you clear the setting.

You can lock a maximum of eight channels.

To lock channels:

1. From the LOCKS menu, select CH LOCK.
2. Press ◀ or ▶ to display the CH LOCK menu.
3. Press the Channel Number buttons to enter the channel you want to lock. (The channel you are currently watching cannot be locked.)
4. Press ENTER.

LOCKS menu

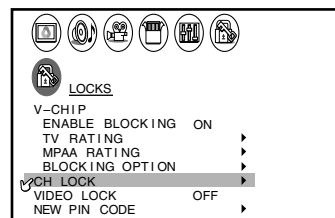

To select each item:

Press ▼ or ▲.

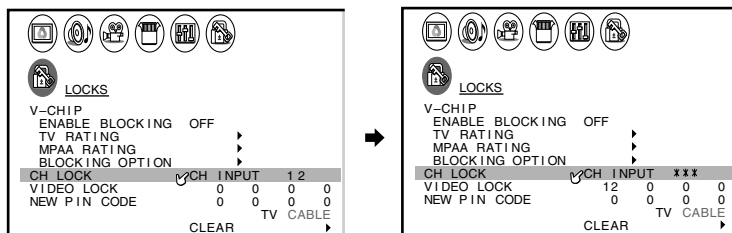

5. Repeat steps 3 and 4 for other channels.

To unlock channels:

1. From the LOCKS menu, select CH LOCK.
2. Press ◀ or ▶ to display the CH LOCK menu.
3. Press ▲ or ▼ to highlight CLEAR.
4. Press ◀ or ▶ until "0" replaces the channel numbers you have locked. Note: This clears all locked channels at once. You cannot unlock individual channels.

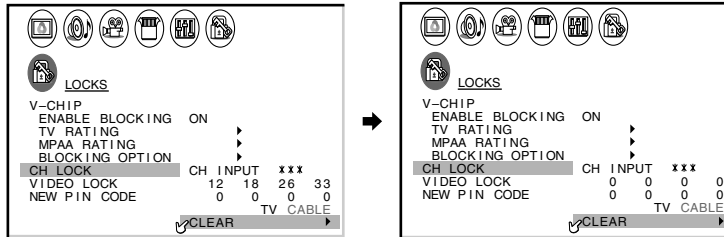

Locking video inputs

You can use the VIDEO LOCK feature to lock the input sources (Video 1, Video 2, Video 3, ColorStream) and channels 3 and 4. You will not be able to select the input sources using the TV/VIDEO button or Channel Number buttons unless you clear the setting.

Note: The Video Lock feature is independent of the Enable Blocking option of V-Chip control.

To set up the video lock:

1. From the LOCKS menu, select VIDEO LOCK.
 2. Press ◀ or ▶ to highlight the level of video locking you want, as follows:
 - VIDEO : Locks Video 1, Video 2, Video 3, and ColorStream.
 - VIDEO+ : Locks Video 1, Video 2, Video 3, ColorStream, and channels 3 and 4. This option should be used if you use the antenna terminal to play videotapes.
- Note:** Make sure the PIP is not on channel 3 or 4.
- OFF : Unlocks all video input sources.

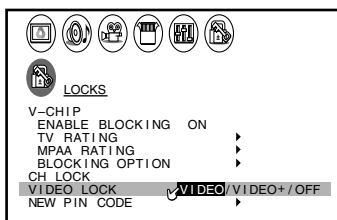

Changing the PIN code

1. From the LOCKS menu, select NEW PIN CODE.
2. Press the Number buttons (0–9) to enter a 4-digit code. The numbers you enter will replace the dashes in the display.

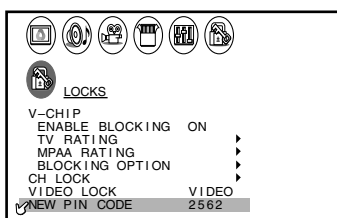

3. Press ENTER. The new PIN code is now active.

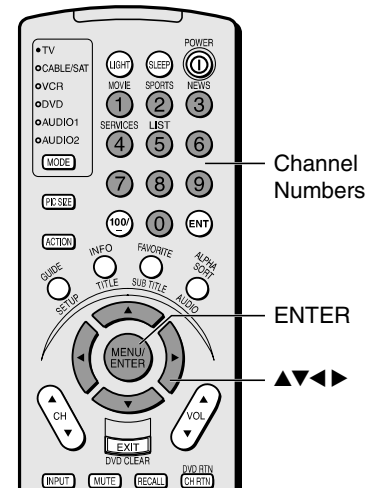

Adjusting the picture

Selecting the picture mode

You can select your desired picture type from four preset picture modes: Sports, Standard, Movie, and Preference.

Mode	Picture Quality
Sports	Bright and dynamic picture (factory setting)
Standard	Standard picture setting (factory setting)
Movie	Movie-like picture setting (factory setting)
Preference	Your personal preference*

*(see "Saving new preference" on page 37.)

To select the picture mode:

1. Press MENU, then press ◀ or ▶ until the PICTURE menu appears.
2. Press ▼ or ▲ to select MODE.
3. Press ◀ or ▶ to highlight the mode you prefer.

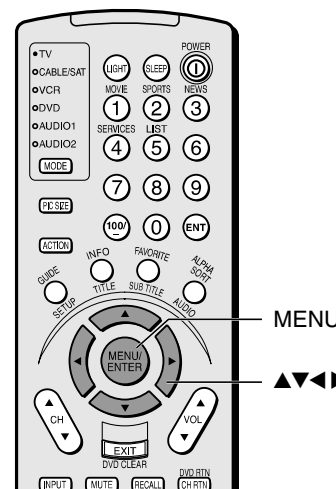
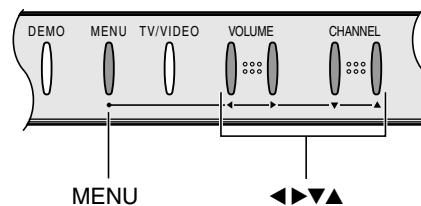
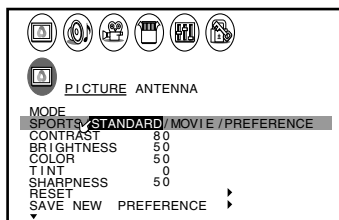

Adjusting the picture quality

You can adjust the picture quality to your personal preferences, including the contrast, brightness, color, tint, sharpness, flesh tone, noise reduction, and color temperature.

Selection	◀ Pressing ▶	
Contrast	lower	higher
Brightness	darker	lighter
Color	paler	deeper
Tint	reddish	greenish
Sharpness	softer	sharper

To adjust the picture quality:

1. Press MENU, and then press ◀ or ▶ until the PICTURE menu appears.
2. Press ▼ or ▲ until the item you want to adjust is highlighted.
3. Press ◀ or ▶ to adjust the level.

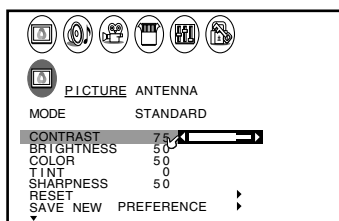

The PICTURE qualities you have adjusted can be saved in the TV's memory with the Save New Preference feature (see page 37). You can keep these settings or choose factory set options as described under "Selecting the picture mode" above.

Note:

If you select one of the factory-set picture modes (Sports, Standard, or Movie) and then change a picture quality setting (for example, increase the contrast), the picture mode automatically changes to Preference in the Picture menu.

To save your new picture quality settings, you must select "Save New Preference" before closing the Picture menu or the TV will return to the previous picture mode.

Saving new preference

You can save the PICTURE qualities (contrast, brightness, color, tint, and sharpness) you adjusted in the picture preference mode.

To save your new preferences:

1. Press MENU, and then press ◀ or ▶ until the PICTURE menu appears.
2. Press ▲ or ▼ to highlight SAVE NEW PREFERENCE.
3. Press ◀ or ▶. When complete, the menu displays "DONE."

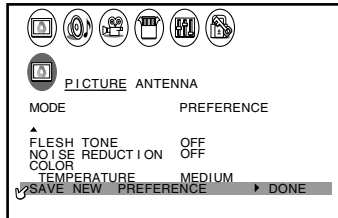

You can choose your saved preferences by selecting PREFERENCE in the picture mode feature (see "Selecting the picture mode" on page 36).

Using the flesh tone feature

This feature allows you to obtain natural flesh tones by correcting the differences in tint among TV stations.

To turn on the flesh tone feature:

1. Press MENU, and then press ◀ or ▶ until the PICTURE menu appears.
2. Press ▲ or ▼ to highlight FLESH TONE.
3. Press ◀ or ▶ to highlight ON.

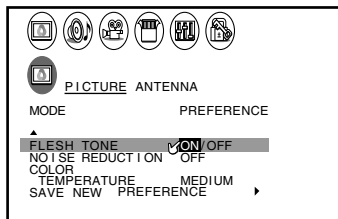

To turn off the flesh tone feature:

Highlight OFF in step 3 above.

Using the noise reduction feature

This feature allows you to reduce visible interference in your TV picture. This is useful when receiving a broadcast with a weak signal or playing a videotape or disc damaged by repeated use.

To turn on the noise reduction feature:

1. Press MENU, and then press ◀ or ▶ until the PICTURE menu appears.
2. Press ▲ or ▼ to highlight NOISE REDUCTION.
3. Press ◀ or ▶ to highlight ON.

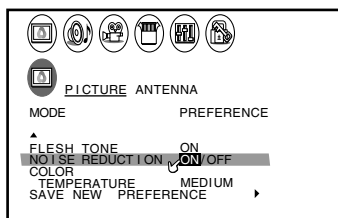

To turn off the noise reduction feature:

Highlight OFF in step 3 above.

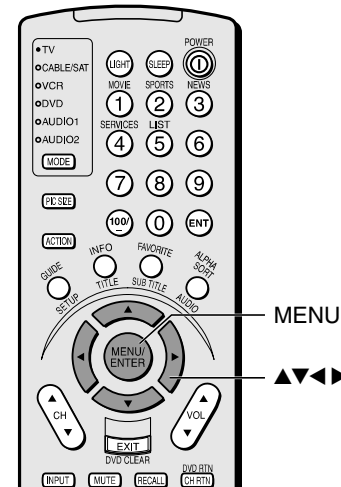

Selecting the color temperature

You can change the quality of the picture by selecting from three preset color temperatures: cool, medium, and warm.

Mode	Picture Quality
Cool	Blueish
Medium	Neutral
Warm	Reddish

To select the color temperature:

1. Press MENU, and then press ◀ or ▶ until the PICTURE menu appears.
2. Press ▲ or ▼ to highlight COLOR TEMPERATURE.
3. Press ◀ or ▶ to highlight the mode you prefer.

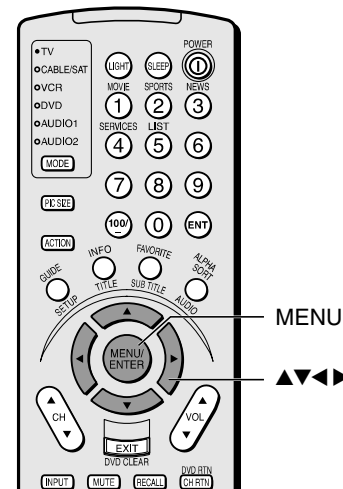
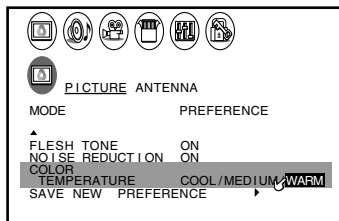

Resetting your picture adjustments

The RESET function returns the picture qualities to the following factory settings:

Contrast max (100)	Color temperature cool
Brightness center (50)	Noise reduction off
Color center (50)	Picture mode sports
Tint center (0)	
Sharpness center (50)	

To reset your picture adjustments:

1. Press MENU, and then press ◀ or ▶ until the PICTURE menu appears.
2. Press ▲ or ▼ to highlight RESET.
3. Press ◀ or ▶.

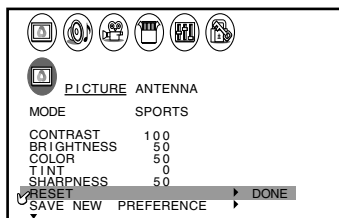

Note:

If you press RESET on the remote control (instead of selecting it in the menu), you will reset both your picture and your audio adjustments to their factory settings.

Watching video input

You can use the INPUT button on the remote control or the TV/VIDEO button on the TV to view a signal coming from other devices connected to your TV, such as VCRs or video disc players. Select VIDEO 1, VIDEO 2, VIDEO 3, or ColorStream, depending on which input jacks are used for connecting the devices (see “Connecting your TV” on page 5).

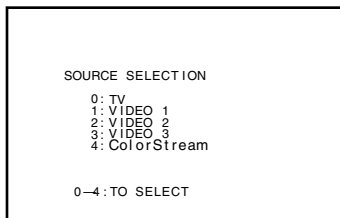

Pressing INPUT on the remote control displays the current signal source (to change the source, select 0-4).

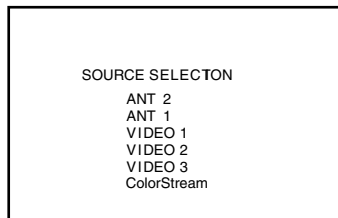

Pressing TV/VIDEO on the TV changes the current signal source.

Labeling the video input sources

The Video Label feature allows you to label each video input source for your TV from the following list of preset labels:

- : Uses the default label name
- VCR : Video cassette recorder
- DVD : Digital video disc player
- DTV : Digital TV set-top box
- SAT : Satellite box
- CBL : Cable box

To label the video input sources:

1. Press MENU, and then press ◀ or ▶ until the CUSTOM menu appears.
2. Press ▲ or ▼ to highlight VIDEO LABEL.

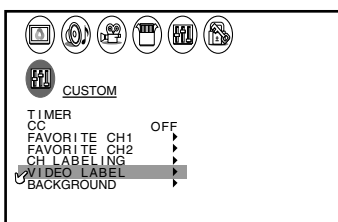

3. Press ◀ or ▶ to display the VIDEO LABEL menu.
4. Press ▲ or ▼ to highlight the video source you want to label.
5. Press ◀ or ▶ to select the appropriate label for that input source.

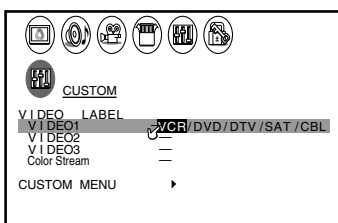

6. Finish labeling the other video sources as desired. To return to the previous menu, press ▲ or ▼ to highlight CUSTOM MENU, and then press ◀ or ▶.
7. To exit the menu, press EXIT.

Note:

- When ColorStream is selected, the video OUT signal will not have color.
- To receive a video OUT signal, a video or S-video IN jack must be used instead of the ColorStream connection.
- While the PIP is on the screen, if ColorStream is selected, the PIP will disappear.

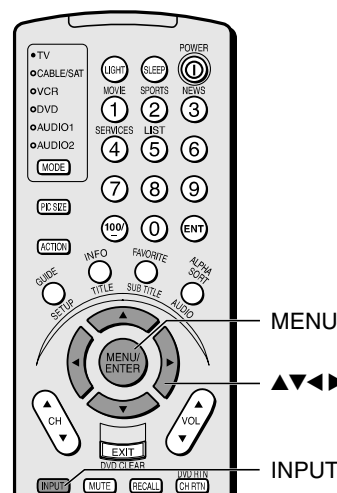
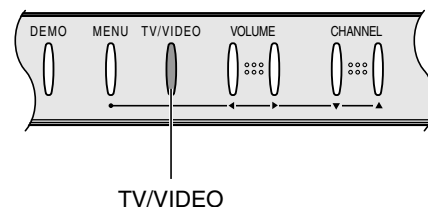

Using the closed caption feature

The closed caption feature has two options:

- Captions—An on-screen display of the dialogue, narration, and sound effects of programs and videos that are closed-captioned (usually identified as “CC” in program guides).
- Text—An on-screen display of information not related to the program, such as weather or stock data (when provided by individual stations).

To view captions or text:

1. Tune the TV to the desired program or video.
2. Press MENU, and then press ◀ or ▶ until the CUSTOM menu appears.
3. Press ▼ or ▲ to highlight CC.

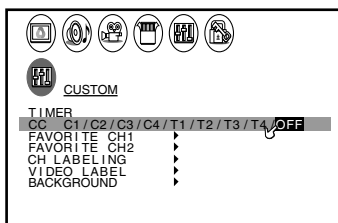

4. Press ◀ or ▶ to highlight the preferred closed caption mode:
 - To view captions, highlight C1, C2, C3, or C4 (C1 displays the primary language in your area).

Note: If the program or video you selected is not closed-captioned, no captions will display on-screen.



- To view text, highlight T1, T2, T3, or T4.

Note: If text is not available, a black rectangle may appear on your screen. If this happens, turn the Closed Caption feature off.

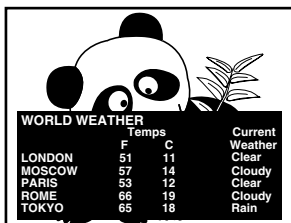

To turn the closed-caption feature off, highlight OFF in the Closed Caption menu.

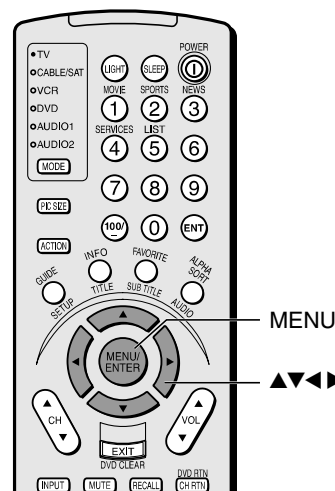

Note:

A closed caption signal may not be decoded in the following situations:

- When a videotape has been dubbed
- When the signal reception is weak
- When the signal reception is nonstandard

Setting the sleep timer

To set the sleep timer to turn the TV off automatically:

1. Press SLEEP (or MENU and ▲▼) to display the CUSTOM menu. TIMER will be highlighted.
2. After the number position starts to blink, press SLEEP repeatedly to enter the length of time until the TV turns off automatically (in 10-minute increments to a maximum of 180).

The SLEEP button can also be used to increment the time interval of 10 minutes up to 180 minutes.

3. Press ENTER to start the timer.

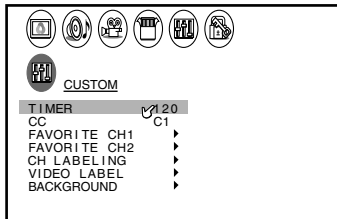

To cancel the sleep timer:

Press POWER two times.

Setting the clock

To set the clock:

1. Press MENU, and then press ◀ or ▶ until the SET UP menu appears.
2. Press ▲ or ▼ to highlight CLOCK SET.
3. After the number position starts to blink, press the Channel Number buttons (0–9) to enter the correct time. The clock operates on a 12-hour cycle.
4. Press ENTER to start the clock.

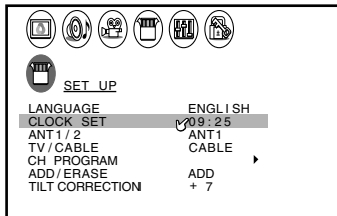

To display the time on-screen:

Press RECALL.

Note :

To display the amount of time remaining until the TV turns off automatically, press SLEEP once. To clear the display, press EXIT.

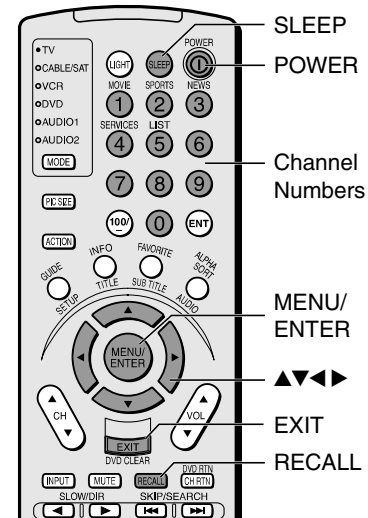

Note:

If the power source for the TV is interrupted (for example, the power cord is unplugged or a power failure occurs), you will need to reset the clock.

Adjusting the sound

Muting the sound

Press MUTE to temporarily turn off the sound. While the sound is off, the screen will display the word MUTE in the lower right corner. To restore the sound, press MUTE again.

When you press the MUTE button, the Closed Caption feature is automatically activated. To deactivate this feature, press MUTE again. This feature works only when the Closed Caption mode is set to OFF. See "Using the closed caption feature" on page 40 for more information.

Selecting stereo/SAP broadcasts

The multi-channel TV sound (MTS) feature allows you to listen to high-fidelity stereo sound while you watch TV. MTS can also transmit a second audio program (SAP) containing a second language, music, or other audio information (when provided by individual stations).

When the TV receives a stereo or SAP broadcast, the word STEREO or SAP appears on-screen every time the TV is turned on, the channel is changed, or RECALL is pressed.

The MTS feature is not available when the TV is in VIDEO mode.

To listen to stereo sound:

1. Press MENU, and then press ◀ or ▶ until the AUDIO menu appears.

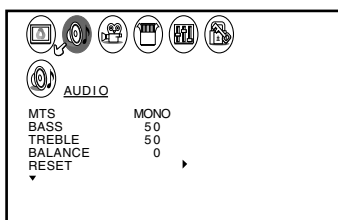

2. Press ▲ or ▼ to highlight MTS.
3. Press ◀ or ▶ to highlight STEREO.

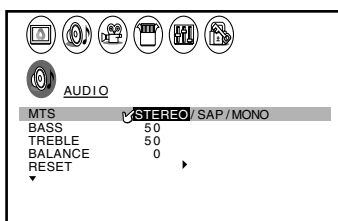

You can leave your TV in STEREO mode because it automatically outputs the type of sound being broadcast (stereo or monaural). If the stereo sound is noisy, select MONO to reduce the noise. The word STEREO or SAP displays in yellow in the menu when the TV receives the signal.

To listen to SAP (if available):

1. Press MENU, and then press ◀ or ▶ until the AUDIO menu appears.
2. Press ▲ or ▼ to highlight MTS.
3. Press ◀ or ▶ to highlight SAP. You will hear the station's second audio program (if available) from the speakers while viewing the original program's picture (see note at right).

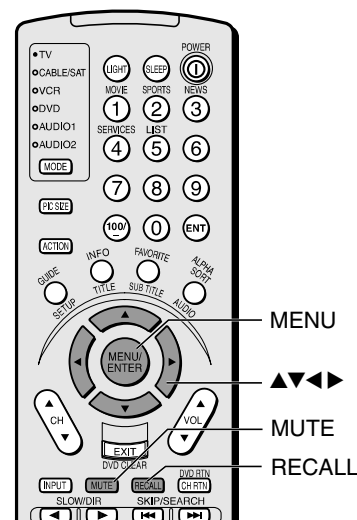
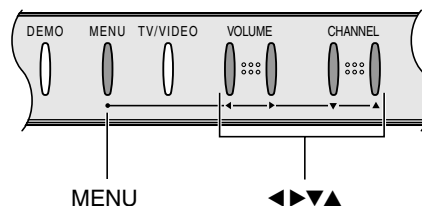

Note:

A second audio program (SAP) can be heard only on those TV stations that offer it.

For example, some TV stations broadcast music as a second audio program. If the TV is in SAP mode, you will see the current program on the screen but hear music instead of the program's normal audio.

However, if the TV is in SAP mode but the station you are watching is not broadcasting a second audio program, you will see the picture but not hear any sound. If this happens, put the TV in STEREO mode to hear the station's normal audio.

Using the surround sound feature

The surround sound feature expands the audio listening field wider and deeper to create exceptional sound quality from the TV's speakers. The feature uses stereo signals from a TV broadcast or video input.

To turn on the surround sound feature:

1. Select the STEREO mode (see "Selecting stereo/SAP broadcasts" on page 42).
2. Press MENU, and then press ◀ or ▶ until the THEATER menu appears.
3. Press ▲ or ▼ to highlight SURROUND.
4. Press ◀ or ▶ to highlight MATRIX.

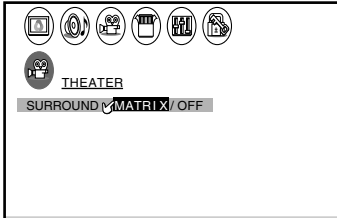

To turn off the surround sound feature:

Highlight OFF in step 4 above.

In general, you can leave your TV in MATRIX mode because it will automatically output the type of sound being broadcast (surround stereo or monaural).

Adjusting the sound quality

You can change the quality of your TV's sound by adjusting the bass, treble, and balance.

To adjust the sound quality:

1. Press MENU, then press ◀ or ▶ until the AUDIO menu appears.
2. Press ▲ or ▼ to highlight the item you want to adjust.

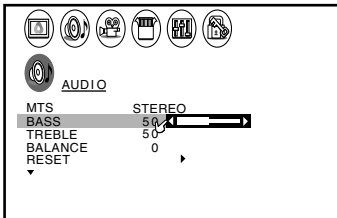

3. Press ◀ or ▶ to adjust the level.
 - ◀ makes the sound quality weaker or decreases the balance in the right channel, depending on the item selected.
 - ▶ makes the sound quality stronger or decreases the balance in the left channel, depending on the item selected.

Note:

When the MATRIX surround mode is selected, the StableSound™ feature is automatically turned off (see "Using the StableSound feature" on page 46).

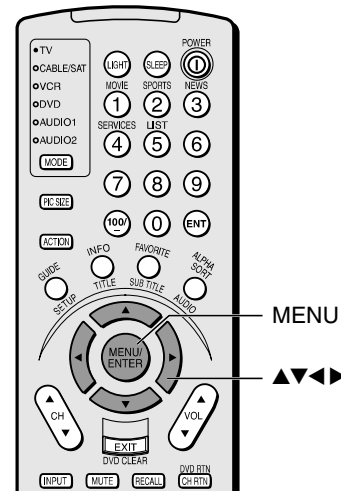

Resetting your audio adjustments

The RESET function returns your audio adjustments to the following factory settings:

- Bass center (50)
- Treble center (50)
- Balance center (0)

To reset your audio adjustments:

1. Press MENU, and then press ◀ or ▶ until the AUDIO menu appears.
2. Press ▲ or ▼ to highlight RESET.
3. Press ◀ or ▶. The menu displays "DONE."

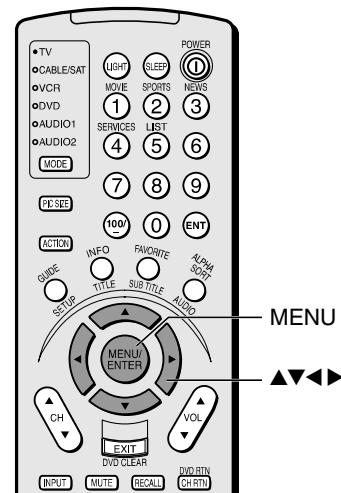
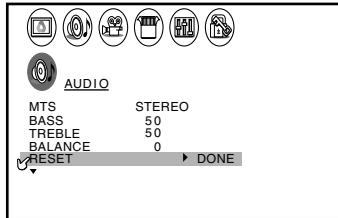

Using the CYCLONE™ sub-woofer system

Toshiba's CYCLONE™ ABX (Acoustic Bass eXpansion) system provides dynamic acoustic reproduction in a self-enclosed bass-reflex sub-woofer system.

To turn on the CYCLONE sub-woofer:

1. Press MENU, and then press ◀ or ▶ until the AUDIO menu appears.
2. Press ▲ or ▼ to highlight CYCLONE.
3. Press ◀ or ▶ to highlight ON.

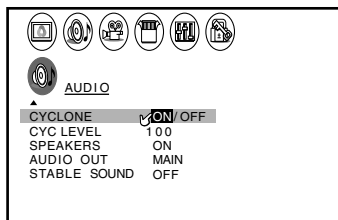

To adjust the CYCLONE level:

4. Press ▲ or ▼ to highlight CYCLONE LEVEL.
5. Press ◀ or ▶ to adjust the CYCLONE level (volume).
Press ▶ to increase the sub-woofer volume.
Press ◀ to decrease the sub-woofer volume.

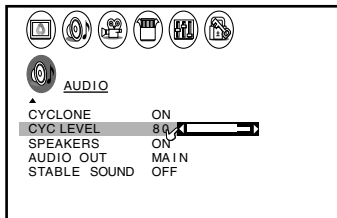

To turn off the CYCLONE sub-woofer:

Highlight OFF in step 3 above.

Note:

The CYCLONE sub-woofer signal does not pass through the VARIABLE AUDIO OUT jacks (see "Connecting an audio system" on page 9); however, the AUDIO menu will appear when the buttons are pressed.

Turning off the built-in speakers

Use this feature to turn the TV speakers off when you connect an audio system. (See “Connecting an audio system” on page 9.)

To turn off the built-in speakers:

1. Press MENU, and then press ◀ or ▶ until the AUDIO menu appears.
2. Press ▲ or ▼ to highlight SPEAKERS.
3. Press ◀ or ▶ to highlight OFF.

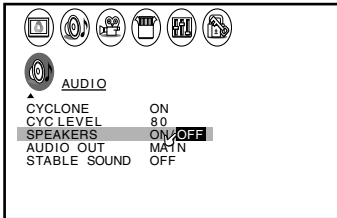

To turn on the built-in speakers:

Highlight ON in step 3 above.

Selecting the Audio OUT sound

This feature allows you to select the sound source (MAIN or PIP) that is output from the Audio OUT jacks (see page 10).

This is useful when amplifying or recording the PIP sound with the external equipment while hearing the sound of main picture through the built-in speakers.

To select the Audio OUT sound:

1. Press MENU, then press ◀ or ▶ until the AUDIO menu appears.
2. Press ▲ or ▼ to highlight AUDIO OUT.
3. Press ◀ or ▶ to highlight MAIN or PIP.

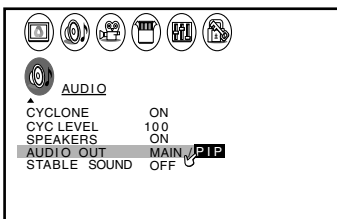

- MAIN: Main picture sound.
- PIP : Selected PIP sound.

Note:

Make sure the volume control of your audio amplifier is set to a moderate listening level.

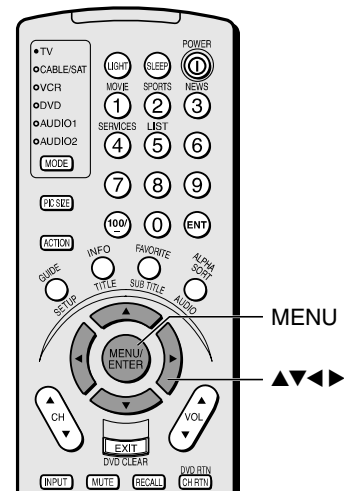

Note:

If the PIP mode is selected and the PIP window is not on the screen, the Audio OUT jacks will not output a signal.

Using the StableSound™ feature

The StableSound™ feature limits the maximum volume level to prevent extreme changes in volume when the TV's signal source is changed.

To turn on the StableSound feature:

1. Press MENU, and then press ◀ or ▶ until the AUDIO menu appears.
2. Press ▲ or ▼ to highlight STABLE SOUND.
3. Press ◀ or ▶ to highlight ON.

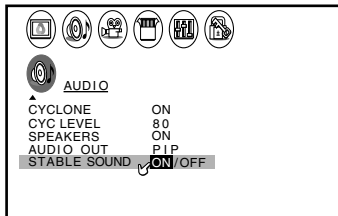

To turn off the StableSound feature:

Highlight OFF in step 3 above.

Selecting the menu display background

You can change the background of the menu display by selecting either shaded or solid (gray).

To select the background:

1. Press MENU, and then press ◀ or ▶ until the CUSTOM menu appears.
2. Press ▲ or ▼ to highlight BACKGROUND.
3. Press ◀ or ▶ to highlight either SHADED or SOLID.

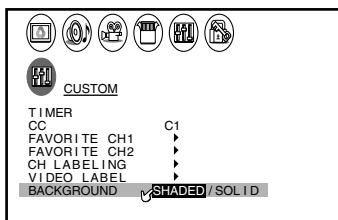

Displaying on-screen information

Press RECALL to display the following information on-screen:

- Antenna mode (when in TV mode)
- Channel number or VIDEO mode selected
- Time (if set)
- Channel label (if set)
- Stereo or SAP (second audio program) audio status
- V-CHIP rating status

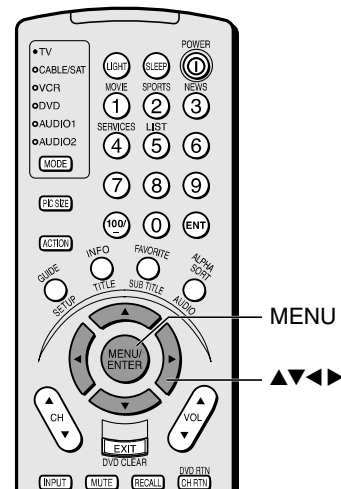
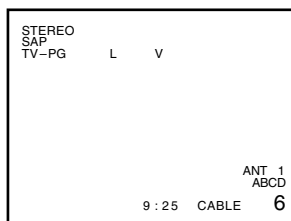

Note:

When the STABLESOUND feature is turned on, the surround sound feature is automatically turned off (see page 43).

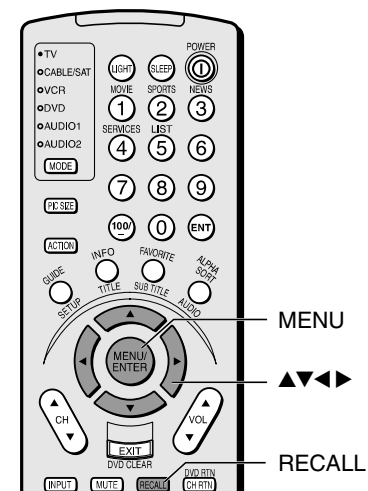

Viewing the demonstration mode

When you press DEMO on the TV, the TV will automatically display a variety of its on-screen menus and special features. This function is provided for demonstration purposes only.

To stop the demonstration mode:

Press DEMO again.

Understanding the auto power off feature

The TV will automatically turn itself off after approximately 15 minutes if it is tuned to a vacant channel or a station that completes its broadcast for the day. This feature does not work in VIDEO mode.

Understanding the last mode memory feature

If the power is cut off while you are viewing the TV, the last mode memory feature turns the TV on automatically when the power is resupplied.

If the power is going to be off for a long time or you are going to be away from your TV, unplug the power cord to prevent the TV from turning on in your absence.

Appendix

Specifications

Television System	NTSC standard
Channel Coverage	VHF: 2 through 13 UHF: 14 through 69 Cable TV: Mid band (A-8 through A-1, A through I) Super band (J through W) Hyper band (AA through ZZ, AAA, BBB) Ultra band (65 through 94, 100 through 125)
Power Source	120 V AC, 60 Hz
Power Consumption	32AFX61: 142 W; 36AFX61: 136 W
Audio Power	Main : 10 W + 10 W Sub-woofer : 13 W
Speaker Type	Main : Two 2-3/8 × 4-3/4 inches (60 × 120 mm) Sub-woofer : One 4 inches (100 mm) round
Video/Audio Terminals	S-VIDEO INPUT Y: 1 V(p-p), 75 ohm, negative sync. C: 0.286 V(p-p) (burst signal), 75 ohm VIDEO/AUDIO INPUT VIDEO: 1 V(p-p), 75 ohm, negative sync. AUDIO: 150 mV(rms) (30% modulation equivalent, 47 kohm) ColorStream™ (component video) INPUT Y: 1V(p-p), 75 ohm Cb: 0.7 V(p-p), 75 ohm Cr: 0.7 V(p-p), 75 ohm AUDIO: 150 mV(rms), 47 kohm VIDEO/AUDIO OUTPUT VIDEO: 1 V(p-p), 75 ohm, negative sync. AUDIO: 150 mV(rms) (30% modulation equivalent, 4.7 kohm) VARIABLE AUDIO OUTPUT 0–300 mV(rms) (30% modulation equivalent, 4.7 kohm) AUDIO CENTER CHANNEL INPUT 300 mV(rms) (30% modulation equivalent, 10 kohm)
Dimensions	32AFX61 Width : 34-1/2 inches (875 mm) Height : 26-9/16 inches (675 mm) Depth : 22-5/8 inches (575 mm) 36AFX61 Width : 38-1/4 inches (972 mm) Height : 29-5/8 inches (753 mm) Depth : 24-1/4 inches (615 mm)
Mass	32AFX61: 150 lbs. (68.1 kg) 36AFX61: 207 lbs. (94.0 kg)
Supplied Accessories	Remote Control with 2 size “AA” alkaline batteries
Optional TV stand	32AFX61: ST3261 36AFX61: ST3661

Design and specifications are subject to change without notice.

Troubleshooting

Before calling a service technician, please check the following table for a possible cause of the problem and some solutions.

Problem	Solution
TV will not turn on	<ul style="list-style-type: none">• Make sure the power cord is plugged in, then press POWER.• The remote control batteries may be dead. Replace the batteries.
No picture, no sound	<ul style="list-style-type: none">• Check the antenna/cable connections.
No sound, picture OK	<ul style="list-style-type: none">• The sound may be muted. Press VOLUME.• The station may have broadcast difficulties. Try another channel.• Check that the SPEAKERS function in the AUDIO menu is set correctly.
Poor sound, picture OK	<ul style="list-style-type: none">• The station may have broadcast difficulties. Try another channel.
Poor picture, sound OK	<ul style="list-style-type: none">• Check the antenna connections.• The station may have broadcast difficulties. Try another channel.• Adjust the PICTURE menu.
Poor reception of broadcast channels	<ul style="list-style-type: none">• The station may have broadcast difficulties. Try another channel.• Check the antenna connections.• If you are using a VCR, make sure the TV/VCR button is set correctly.
Cannot receive above channel 13	<ul style="list-style-type: none">• Make sure the TV/CABLE switch is set to the mode that corresponds with the signal source (antenna or cable).
Black box appears on the screen	<ul style="list-style-type: none">• The closed caption feature may be set to one of the Text modes (T1, T2, T3, or T4). Turn closed captioning off.
Unable to select a certain channel	<ul style="list-style-type: none">• The channel may be locked out with the CH LOCK feature, or erased with the ADD/ERASE feature.
Multiple images	<ul style="list-style-type: none">• The station may have broadcast difficulties. Try another channel.• Antenna reception may be poor. Use a highly directional outdoor antenna.
Poor color or no color	<ul style="list-style-type: none">• The station may have broadcast difficulties. Try another channel.• Adjust the TINT and/or COLOR in the PICTURE menu.• If you change the direction of the TV while the TV is activated, the picture may suffer from color shading. If so, turn off the TV and allow it to cool for about 30 minutes, then turn on the TV again. The picture should improve.
No stereo or SAP sound from a known MTS broadcast	<ul style="list-style-type: none">• Make sure the MTS feature is set properly.
The remote control does not operate	<ul style="list-style-type: none">• Make sure the appropriate device mode is selected.• There may be an obstruction between the remote control and the remote control sensor. Remove the obstruction.• The remote control batteries may be dead. Replace the batteries.
Cannot access signal input sources (Video1, Video2, Video3, or ColorStream) or Channels 3 and 4	<ul style="list-style-type: none">• Check the Video Lock feature.

Limited United States Warranty

Toshiba America Consumer Products, Inc. ("TACP") and Toshiba Hawaii Inc. ("THI") make the following limited warranties. These limited warranties extend to the original consumer purchaser or any person receiving this set as a gift from the original consumer purchaser and to no other purchaser or transferee.

Limited One (1) Year Warranty

TACP and THI warrant this product and its parts against defects in materials or workmanship for a period of one (1) year after the date of original retail purchase. During this period, TACP and THI will repair or replace a defective part, at their option, with a new or refurbished part, without charge to you. TACP/THI Authorized Service Station personnel will come to your home when warranty service is required. Depending on the type of repair required, the service will either be performed in your home or the set will be taken to the TACP/THI authorized service station for repair and returned to your home at no cost to you.

Limited Two (2) Year Warranty of Picture Tube

TACP and THI further warrant the picture tube in this product against defects in materials or workmanship for a period of two (2) years after the date of original retail purchase. During this period, TACP and THI will repair or replace a defective picture tube at their option, with a new or refurbished picture tube, without charge to you, except that if a defective picture tube is replaced after one (1) year from the date of the original retail purchase, you pay labor charges involved in the replacement.

Rental Units

The warranty for rental units begins with the first rental or thirty (30) days from the date of shipment to the rental firm, whichever comes first.

Commercial Units

Products sold and used for commercial use have a limited ninety (90) day warranty for all parts, labor and picture tube.

Owner's Manual and Demographic Card

You should read this owner's manual thoroughly before operating this product. You should complete and mail the enclosed Demographic card within ten days after you., or the person who has given you this product as a gift, purchased this product. This is one way to enable TACP/THI to provide you with better customer service and improved products. Failure to return the Demographic card will not affect your rights under this warranty.

Your Responsibility

The above warranties are subject to the following conditions;

- (1) You must retain your bill of sale or provide other proof of purchase.
- (2) All warranty servicing of this product must be made by an Authorized TACP/THI Service Station.
- (3) These warranties are effective only if the product is purchased and operated in the U.S.A. or Puerto Rico.
- (4) Labor service charges for set installation, set up, adjustment of customer controls and installation or repair of antenna systems are not covered by this warranty. Reception problems caused by inadequate antenna systems are your responsibility.
- (5) Warranties extend only to defects in materials or workmanship as limited above and do not extend to any product or parts which have been lost or discarded by you or to damage to products or parts caused by misuse, accident, damage caused by Acts of God, such as lightning or fluctuations in electric power, improper installation, improper maintenance or use in violation of instructions furnished by us; or to units which have been modified or had the serial number removed, altered, defaced or rendered illegible.

How to Obtain Warranty Service

If after following all of the operating instructions in this manual and checking the section "Troubleshooting," you find that service is needed:

- (1) To find the nearest Toshiba Authorized Service Station, visit our web site at www.toshiba.com/tacp/cus_svc.html, or call us toll-free at 1-800-631-3811.

In Hawaii, contact Toshiba Hawaii, Inc., 327 Kamakee Street, Honolulu, HI 96814, (808) 591-9281.
- (2) Present your bill of sale or other proof to the Authorized Service Station. "Authorized TACP/THI service station personnel will come to your home when warranty service is required. Depending on the type of repair required, the service will either be performed in your home or the set will be taken to the TACP/THI authorized service station for repair, and returned to your home at no cost to you."

For additional information, visit our web site:
www.toshiba.com/tacp

All warranties implied by state law, including the implied warranties of merchantability and fitness for a particular purpose, are expressly limited to the duration of the limited warranties set forth above. With the exception of any warranties implied by state law as hereby limited, the foregoing warranty is exclusive and in lieu of all other warranties, guarantees, agreements and similar obligations of manufacturer or seller with respect to the repair or replacement of any parts. In no event shall TACP or THI be liable for consequential or incidental damages.

No person, agent, distributor, dealer or company is authorized to change, modify or extend the terms of these warranties in any manner whatsoever. The time within which action must be commenced to enforce any obligation of TACP or THI arising under this warranty or under any state, or law of the United States or any state thereof, is hereby limited to 90 days from the date you discover or should have discovered, the defect. This limitation does not apply to implied warranties arising under state law.

This warranty gives you specific legal rights and you may also have other rights which may vary from state to state. Some states do not allow limitation on how long an implied warranty lasts, when an action may be brought, or the exclusion or limitation of incidental or consequential damages, so the above provisions may not apply to you.



ATTENTION CANADIAN CONSUMERS:

Canadian consumers are requested to complete the special Canadian "Warranty Registration Form" enclosed, and forward this completed form with a copy of bill of sale to TOSHIBA OF CANADA to "Register and Validate" their warranty.

Products purchased in the U.S.A. and used in Canada are not covered by these warranties.

Products Purchased in Canada and used in the U.S.A. are not covered by these warranties.

REV. 09-01

Index

A

A/V receiver connection	10
ANT 1/2	22
Antenna cables	5
Audio cables	5
AUDIO OUT sound, selecting	45
Audio system connection	9
Auto power off	47

B

BACKGROUND selection	46
----------------------------	----

C

Cable box connection	6
Camcorder connection	9
CH LABEL	26
CH LOCK	34
CH RTN button	25
Channel Number buttons	24
Channel programming	
ADD/ERASE	24
Automatic programming	23
TV/CABLE selection	23
Channel ▲ ▼ buttons	24
Clock, setting	41
Closed caption	40
ColorStream® cables	5
CYCLONE® sub-woofer	44

D

DEMO button	47
DVD connection	7

F I

(FAV) ◀▶ buttons	25
FAVORITE button	30
FAVORITE CH	25
Flesh tone	37
Front of the TV	4
INFO button	30
INPUT button	39

L M

Language selection	22
Last mode memory	47
Locks menu	31
Menu system	21
MTS feature	42
MULTI button	30
Multi-Window feature	
Favorite function	30
Preview function	30
Strobe function	30
MUTE button	42

P

Picture adjustments	
COLOR TEMPERATURE	38
FLESH TONE	37

Picture adjustments (continued)	
NOISE REDUCTION	37
Picture mode	36
Picture quality	36

Picture in Picture (PIP)	
LOCATE button	29
PIP button	28
PIP CH ▲ ▼ buttons	28
SOURCE button	28
STILL button	29
SWAP button	29

R

RECALL button	46
---------------------	----

Remote control

Battery installation	11
Device code table	16–19
Functional key chart	12
Learning about the buttons	20
Operational feature Reset	15
Programming	14
Searching and sampling the code	14
Verifying the device code	15
Volume Lock feature	15
RESET	38, 44

S

SAP sound	42
Satellite receiver connection	7
SLEEP timer	41
Sound quality adjustments	43
SPEAKERS on/off	45
Specifications	48
STABLE SOUND™	46
Stereo sound	42
Sub-woofer, CYCLONE®	44
Surround sound	43
S-video cables	5

T

TILT CORRECTION	24
Troubleshooting	49
TV/VIDEO button	22

V

V-CHIP

BLOCKING OPTION	33
ENABLE BLOCKING	32
MPAA RATING	33
NEW PIN CODE	35
PIN code, entering	31
TV RATING	32
Unlocking programs	34
VCR connection	5–8
Video cables	5
VIDEO LABEL	39
VIDEO LOCK	35

W

Warranty	50
----------------	----

TOSHIBA AMERICA CONSUMER PRODUCTS, INC.

HEAD OFFICE/82 TOTOWA ROAD, WAYNE, NEW JERSEY 07470
NATIONAL SERVICE DIVISION:1420B TOSHIBA DRIVE, LEBANON, TN 37087

TOSHIBA HAWAII, INC.

HEAD OFFICE/327 KAMAKEE STREET, HONOLULU, HAWAII 96814, U.S.A. TEL: (808) 591-9281

TOSHIBA OF CANADA LTD.

HEAD OFFICE/191 McNABB STREET MARKHAM, ONTARIO L3R 8H2, CANADA TEL: (905) 470-5400
SERVICE CENTERS/TORONTO: 191 McNABB STREET MARKHAM, ONTARIO L3R 8H2, CANADA TEL: (905) 470- 5400
MONTREAL: 1643, NORTH SERVICE RD., TRANS-CANADA HIGHWAY, DORVAL QUEBEC, H9P 1J1, CANADA
TEL: (514) 856-4100
VANCOUVER: 22171 FRASERWOOD WAY, RICHMOND, B.C. V6W 1J5, CANADA TEL: (604) 303-2500

MANUFACTURED BY

TOSHIBA AMERICA CONSUMER PRODUCTS, INC.

ColorStream and CYCLONE are registered trademarks of Toshiba Corporation.
Stable Sound is a trademark of Toshiba America Consumer Products, Inc.

PRINTED IN USA
(01-06)R

TOSHIBA

23565239

Free Manuals Download Website

<http://myh66.com>

<http://usermanuals.us>

<http://www.somanuals.com>

<http://www.4manuals.cc>

<http://www.manual-lib.com>

<http://www.404manual.com>

<http://www.luxmanual.com>

<http://aubethermostatmanual.com>

Golf course search by state

<http://golfingnear.com>

Email search by domain

<http://emailbydomain.com>

Auto manuals search

<http://auto.somanuals.com>

TV manuals search

<http://tv.somanuals.com>