

Operator: Save these instructions for future use!

FAILURE TO READ AND FOLLOW ALL INSTRUCTIONS CAREFULLY BEFORE INSTALLING OR OPERATING THIS CONTROL COULD CAUSE PERSONAL INJURY AND/OR PROPERTY DAMAGE.

DESCRIPTION

The 37E73A-9XX INTELLI-IGNITION™ control is a combination gas valve, ignition control, and thermostat for use on Power Vented water heaters. The microcomputer in the control supervises the ignition sequence and timings for the water heater, and provides diagnostic codes in case of system malfunction. The control provides direct burner ignition using the White-Rodgers' Silicon Nitride ignitor. The control uses the INTELLI-IGNITION™ technology to greatly extend the ignitor's life.

Adjustable Regulator Controls: The gas regulator on this control requires no field service. The regulator is factory adjustable for the proper burner gas pressure.



PRECAUTIONS

⚠ WARNING

“WHAT TO DO IF YOU SMELL GAS”

- Do not try to light any appliance.
- Do not touch any electrical switch; do not use any phone in your building.
- Immediately call your gas supplier from a neighbor's phone. Follow the gas supplier's Instructions.
- If you cannot reach your gas supplier, call the fire department.

⚠ WARNING

Do not use this Natural Gas control on LP Gas water heater. Improper operation could occur, resulting in personal injury and/or death due to Carbon Monoxide (CO) poisoning, fire, or explosion. Check for proper gas type as listed on the rating plate affixed to the water heater.

CONTENTS

Description	1
Precautions	1
Specifications	2
Installation	2
Operation.....	7
Wiring.....	6
Troubleshooting	8

⚠ WARNING



FIRE, SHOCK AND EXPLOSION HAZARDS

- Shut off main gas to appliance for service or until installation is complete.
- Disconnect electric power before servicing.
- Do not exceed the specified voltage.
- Replace existing control with recommended model.
- Protect the control from direct contact with water (dripping, spraying, rain, etc.)
- If the control has been in direct contact with water, replace the control.
- Label all wires before disconnection when servicing controls. Wiring errors can cause improper and dangerous operation.
- Route and secure wiring away from flame.
- Ensure proper earth grounding of appliance.
- Ensure proper connection of line neutral and line hot wires.
- Do not use tools to operate this control.
- Do not take control apart, there are no serviceable parts inside.
- Do not use control if it has been flooded.
- Never stand on the control or use as a step.

SPECIFICATION

ELECTRICAL RATINGS:

Input and Frequency: 120 VAC, 60 Hz

Output Ratings:

Ignitor Load: 2 Amps maximum

Inducer Draft Motor: 3 Amps Full Load, 4 Amps Locked Rotor

Current: 0.2 Amps @ 120 VAC

Range of Regulation (Btu/Hr)

Minimum: 30,000 Maximum: 150,000

Pressure Regulator Setting: Factory set to 3.5" or 4.0" W.C.
Adjustable 2.5" to 5.0" W.C.

1.0" Pressure Drop Capacity^a

100,000 Btu/Hr

^aBased on 1000 Btu/ft³, 0.64 specific gravity natural gas

Maximum Inlet Pressure: 1/2 PSI maximum

Ambient Temperature Rating:

32°F to 160°F (0°C to 70°C)

Automatic High Temperature Cutoff:

Single-Use Type, 185°F(82°C)

Prepurge Time: 5 Seconds

Ignitor Warm-up Time: 20 Seconds

Trial for Ignition Period: 4 Seconds

Inter-purge Time: 5 Seconds

Post-purge Time: 5 Seconds

Ignition Retries: 2 Retries; 3 Trials before lockout

Ignition Recycles: 2 Recycles, 3 Losses of flame before lockout

BODY CONFIGURATION:

Right angle with a 1/2" NPT inlet and a 1/2" inverted flare outlet

MOUNTING:

Limited Horizontal/Vertical

INSTALLATION

NOTE

1. This control must be installed or serviced only by a professional.
2. For your safety, this control is supplied with tamper resistant screws. Do not attempt to repair or adjust the control. If you experience problems, replace the control immediately. Continuing to use a damaged control could result in fire and/or explosion.
3. An odorant has been added to the gas to help you detect it. Before lighting, search for the odor of gas by sniffing at floor level around the water heater.
4. In some situations, the gas may lose its odor. To detect unodorized gas, you must have a gas detector, which can be purchased from your gas company. If you do not have a detector and have the slightest suspicion that gas may be present, get out of the house and call the gas company. **DO NOT RELY TOTALLY ON YOUR NOSE.**

REMOVING THE OLD CONTROL

1. Shut off the gas to the water heater
2. Turn off electrical power to the water heater.
3. Remove the two plastic wire connectors that plug into the bottom of the control. The connectors have latches which must be depressed. **DO NOT FORCE THE CONNECTORS, DAMAGE TO THE WIRING MAY RESULT.**
4. Shut off the water at the cold water inlet.
5. Connect a hose to the water heater drain cock. Drain the water to a nearby drain. Open a hot water faucet for faster draining.
6. Disconnect the gas line at the union (Figure 1). Remove the piping from the old control.
7. Remove the control by turning it counterclockwise (↺).

INSTALLING THE NEW CONTROL

All piping must comply with local and state ordinances or with the National Fuel Gas Code (ANSI Z223.1-NFPA 54), whichever applies.

Dirt or contamination in the gas line can block the control from operating creating a risk of explosion, injury, or death. To protect the control from dirt and contamination, a drip leg or sediment trap (see Figure 1) must be installed in the piping leading to the control.

1. Apply pipe compound to the male threads of the pipe that goes into the control, leaving the first two or three threads clean.
2. Install control in the tank. Turn clockwise (↻). Use a short piece of pipe to help in turning. Align the control so that the burner tube may be connected.
3. Make the main burner connection. Do not use pipe joint compound or Teflon tape.
4. Connect the gas line. Use new black iron pipe that has been properly reamed. If old pipe is used, be sure it is clean and free from rust and scale. Use pipe joint compound on male threads only. (Use pipe joint compound approved for natural and LP gas service.) Do not use TEFLON tape. Do not apply compound to the first two threads.
5. **DO NOT** use joint compound or tape on the union connection.
6. Make the electrical connections to the control. There are two plastic connectors that plug into the bottom of the control. The connectors are "keyed" so that they can only be inserted one way. Make sure that the connectors are properly aligned before attempting to insert. **DO NOT FORCE THE CONNECTORS; DAMAGE TO THE CONTROL WILL RESULT.**
7. To fill the water heater with water:
 - a. Close the water heater drain valve by turning the handle to the right (clockwise). The drain valve is on the lower front of the water heater.

NOTE

The cold water supply valve must be left open when the water heater is in use.

- a. Open the cold water supply valve to the water heater.
- b. To ensure complete filling of the tank, let air exit by opening the nearest hot water faucet. Allow water to run until a constant flow is obtained. This will let air out of the water heater and the piping.

CAUTION

Never use this water heater unless it is completely filled with water. To prevent damage to the tank, the tank must be filled with water. Water must flow from the hot water faucet before turning ON gas to the water heater.

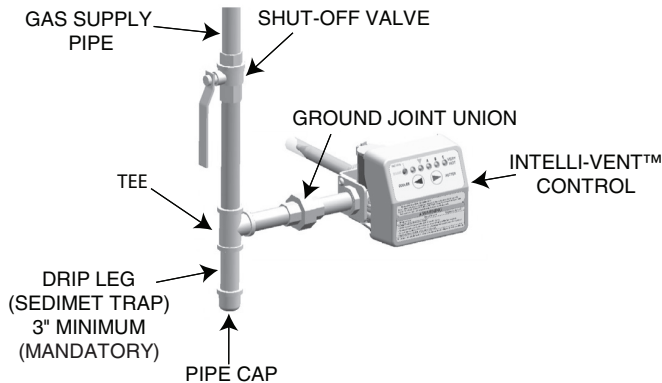

Figure 1. Typical gas connection

- d. Check all new water piping for leaks. Repair as needed.
8. Open the gas shutoff valve.
9. **BEFORE TURNING ON THE APPLIANCE, CHECK THE GAS LINES FOR LEAKS.**
 - a. Use a soapy water solution. DO NOT test for gas leaks using a match or open flame.
 - b. Brush the soapy water solution on all gas pipes, joints, and fittings. Use care that excess solution does not enter the control's plastic housing.
 - c. Check for bubbling soap. This means you have a leak. Turn OFF the gas and make the necessary repairs.
 - d. Turn on the gas and recheck for leaks. Repeat this process until you are sure the system is gas-tight. If repeated work on a part does not stop the leak, the part must be replaced.
 - e. Rinse off the soapy solution and wipe all the plumbing parts dry.

PRESSURE REGULATOR ADJUSTMENT

These controls are shipped from the factory with the regulator set as specified on the control label. Consult the appliance rating plate to ensure burner manifold pressure is as specified. If another outlet pressure is required, follow these steps.

NOTE

If a valve has been factory-adjusted for the 2.5 to 5 inches W.C. range, it cannot be field-adjusted outside that range.

1. Turn off all electrical power to the system
2. These models have 1/8 NPT threaded taps. The outlet pressure tap plug will need to be removed and a separate hose fitting installed.
3. Attached a hose and manometer to the separate hose fitting which has been installed in place of the 1/8 NPT threaded tap.
4. Turn on system power and energize valve.
5. Remove regulator cover screw and turn regulator adjust screw **clockwise** (↻) to **increase pressure**, or **counterclockwise** (↺) to **decrease pressure** (see

fig. 3). Always adjust regulator to provide the correct pressure according to the original equipment manufacturer's specifications listed on the appliance rating plate. Replace regulator cover screw.

6. Turn off all electrical power system to the system.
7. Remove manometer hose from outlet pressure tap.
8. Remove hose fitting and re-install the 1/8 NPT pressure tap plug. Tighten to 60 in-lb max.
9. Turn on electrical power to the system.
10. Turn on system power and energize valve.
11. Using a leak detection solution or soap suds, check for leaks at pressure boss screw or pressure tap plug. Bubbles forming indicate a leak. SHUT OFF GAS AND FIX ALL LEAKS IMMEDIATELY.

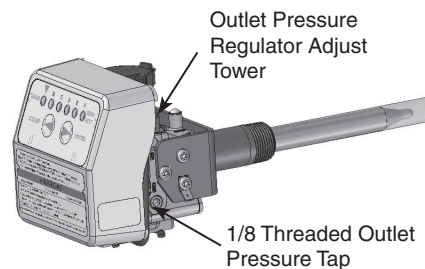

37E Intelli-Vent™ Control

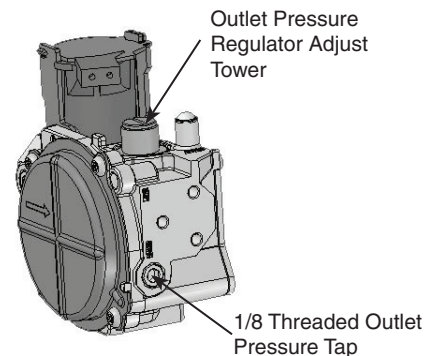

36G Valve

Figure 2. Pressure port and regulator adjust locations

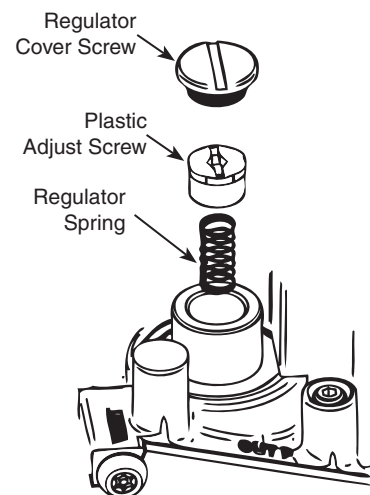

Figure 3

INSTALLATION

OPERATING INSTRUCTIONS

1. The control uses an automatic ignition system to light the burner. **DO NOT TRY TO MANUALLY LIGHT THE BURNER.**
2. Wait at least five (5) minutes to clear out any gas, and then smell around the appliance area near the floor. If you smell gas, **STOP!** Follow the instructions “What to do if you smell gas” on the first page of this instruction sheet. If you do not detect gas, continue with the next step.
3. Make sure that both the inner and outer doors are in place. These doors are located where the burner tube enters the water heater at the bottom. Both doors must be in place for safe operation.
4. Turn on power to the water heater. This can be done either by turning on the disconnect switch to the water heater, or plugging in the water heater to a nearby outlet. The installer should have made this provision for you, and it must meet local and state ordinances or the National Electric Code, whichever applies.
5. For a brief time (one to five seconds) all of the indicators on the front of the control should come on, and then turn off. This indicates that the control has completed the self-diagnostic test, and is ready for operation. If any combination of indicators remain illuminated, either refer to the troubleshooting section of this manual, or contact a qualified service person.
6. The water heater is now ready for operation, and will begin to heat the water to the factory default setting of approximately 70°F. If an alternate temperature setting is required, please refer to the following section “Temperature Regulation”.

TEMPERATURE REGULATION

After the gas and electrical connections are made and the water heater tank is full of water, the control will now start to heat the water to the factory default setting of approximately 70°F. If a higher setting is desired, start with the setting at the triangle (▼). This is approximately the 120°F setting, and the safest and most economical setting for the water heater.

To change the temperature setting for either cooler or warmer water, the following steps are necessary:

1. “Wake up” the temperature indicators by pressing the COOLER and HOTTER temperature adjustment buttons at the same time and releasing after one second (see Figure 4). One or two of the temperature indicators will light up. These indicators will only remain on for 30 seconds if no further buttons are pressed. After 30 seconds the control will go back to “Sleep” mode, and both buttons will again have to be pressed to see the water temperature setting.
2. If this is the first time that the control has been used, the leftmost green indicator will be illuminated indicating the water temperature setting of approximately 70°F. See Table 1 for an explanation of what each of the temperature indicators mean.
 - a. **To decrease the temperature** press and release the COOLER button once. The temperature indicators will now display the new temperature setting. Press and release the COOLER button until you have reached the desired setting. **HOLDING DOWN THE BUTTON WILL NOT CONTINUE TO LOWER THE SETTING.** The Button must be pressed and released for each temperature change desired.
 - b. **To increase the temperature** press and release the HOTTER button once. The temperature indicators will now display the new temperature setting.

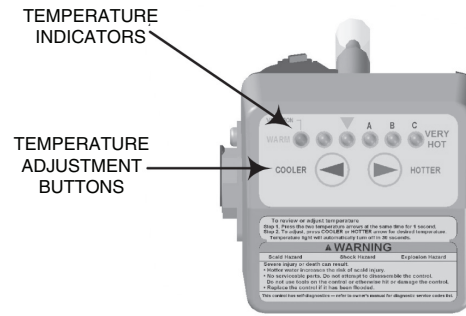

Figure 4. Temperature Indicators and Adjustment

Press and release the HOTTER button until you have reached the desired setting. **HOLDING DOWN THE BUTTON WILL NOT CONTINUE TO RAISE THE SETTING.** The Button must be pressed and released for each temperature change desired.

To avoid scald injury, set the control to the lowest setting which will deliver your needed hot water. Refer to **Table 1** to determine the approximate temperature setting, and the approximate time for scald injury at that temperature.

Table 1. Temperature Settings

Display	Approximate Temperature (±10°F)	Approximate Time to Cause Injury
▼ A B C		
● ○ ○ ○ ○ ○	70 (Vacation)	N/A
○ ● ○ ○ ○ ○	110	
○ ● ● ○ ○ ○	115	
○ ○ ● ○ ○ ○	120	5 minutes
○ ○ ● ● ○ ○	125	
○ ○ ○ ● ○ ○	130	30 seconds
○ ○ ○ ● ● ○	135	
○ ○ ○ ○ ● ○	140	5 seconds
○ ○ ○ ○ ● ●	145	
○ ○ ○ ○ ○ ●	150	1.5 seconds
○ ○ ○ ○ ○ ● Flashing → ↑	160	Under 1 second

3. When you have completed setting the control wait 30 seconds to see that the temperature indicators go off and the control enters “Sleep” mode. **ALL OF THE TEMPERATURE INDICATORS WILL BE OFF DURING NORMAL OPERATION.** If any time you see the indicators on, there may be a system error and you should consult the “Troubleshooting” section of this document, or contact a trained service professional.

If you use hot water frequently and in short spurts, water temperature can occasionally exceed the temperature setting by up to 30°F because of the dynamics of the appliance. Keep this in mind when you are selecting a temperature higher than the factory default setting.

Be sure to protect babies and the infirm or others with impaired mobility who cannot get out of the hot water quickly.

WARNING

Scald burns occur in under one second with 160°F water, which this thermostat will deliver if the temperature is set at “VERY HOT”. Lower settings of the temperature will reduce the risk of scald and will reduce your fuel bill.

They are the people most commonly hurt in scald injuries and in need of lower temperature and other protection like supervision, point-of-use temperature control equipment or a system mixing valve. A point-of-use valve or system mixing valve can be obtained from your local plumber.

Checking the temperature setpoint may be performed at any time by the procedure described on step 1 of “**Temperature Regulation**” on page 4. No other action is needed for checking temperature setpoint.

SHUTTING OFF THE APPLIANCE

Vacation Shutdown

WARNING

Never allow small children to use a hot water tap, or to draw their own bath water. Never leave a child or impaired person unattended in a bathtub or shower. Scald burns can result

1. “Wake up” the temperature indicators by holding down both the COOLER and HOTTER temperature adjustment buttons at the same time for one second (see **Figure 2**). One or two of the temperature indicators will light up. Make a note as to which indicators are illuminated so that you can reset the control to the same setting when you return from vacation.

2. Press and release the COOLER button as many times as needed until the green leftmost indicator is only lit. This temperature setting is approximately 70°F. Leave the gas turned on.
3. When returning from vacation reset the temperature to that you noted in step 1.

Complete Shutdown

1. Turn off the electrical disconnect on the appliance, or remove the plug from the receptacle, whichever applies. (Don’t worry; the Intelli-Vent™ control will remember your correct temperature setting.)
2. Turn off the gas supply to the water heater. The water heater is now completely shut down.
3. To restart the water heater, follow the instructions in the section “Operating Instructions”.

There are no user serviceable parts in this control. The control is supplied with tamper resistant screws. DO NOT attempt to repair or adjust the control. If you experience problems, discontinue use and replace the control immediately. **Continuing to use a damaged control could result in fire and/or explosion.**

Service

If you wish to verify that the water heater is operating properly:

1. Make sure there is power to the water heater.
2. Make sure that the gas is turned on to the water heater.
3. Initiate a call for heat by either drawing hot water from a nearby faucet or raising the temperature setting (see section “Temperature Regulation”).
4. Watch the ignition sequence and compare it to the “Sequence of Operation” chart on page 7.
5. Note any error codes that appear and proceed to the next section “Troubleshooting”.

WIRING DIAGRAM

A typical system wiring diagram is shown below. Use the water heater manufacturer's wiring diagram for details of the

installation. Always follow the instructions supplied with the water heater, and those of the water heater manufacturer.

Intelli-Vent™ Wiring Diagram Typical Installation

(Consult Appliance Manufacturer's Instructions For Details)

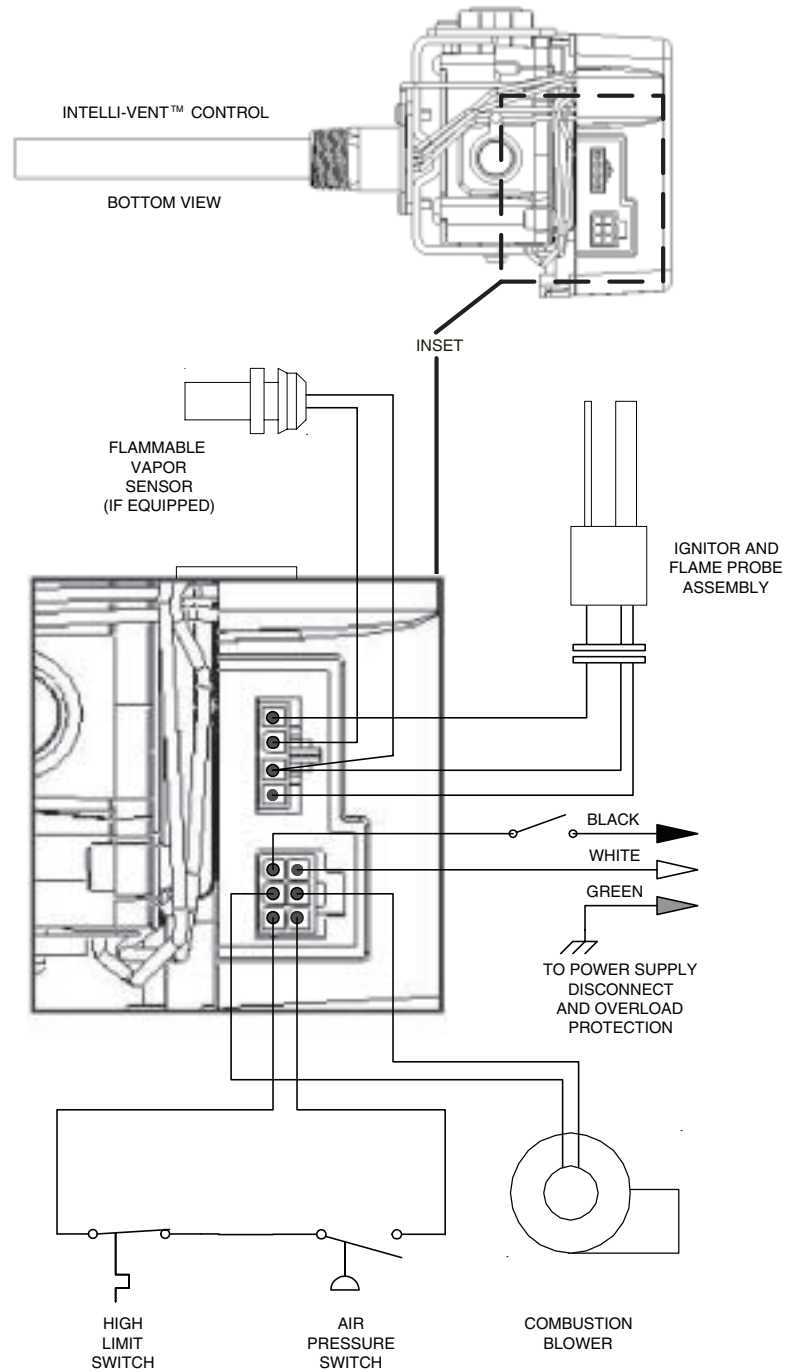

SEQUENCE OF OPERATIONS

Intelli-Vent™ Sequence of Operation

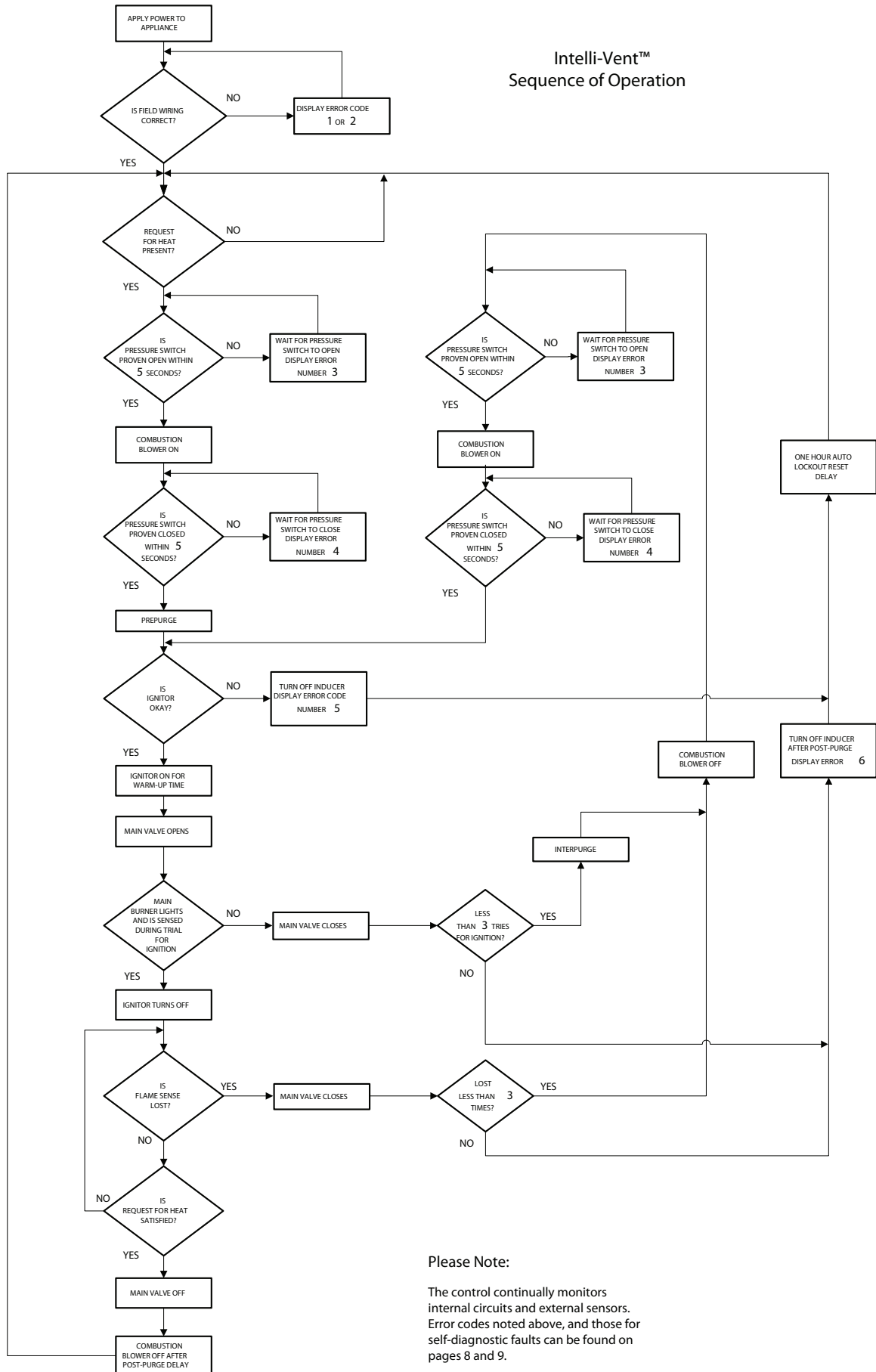

Please Note:

The control continually monitors internal circuits and external sensors. Error codes noted above, and those for self-diagnostic faults can be found on pages 8 and 9.

TROUBLESHOOTING

The troubleshooting charts cover the error codes that the Intelli-Vent™ control can recognize, the potential cause, and those actions that may help repair the problem. The water heater manufacturer's troubleshooting procedure should be consulted before attempting to repair the appliance. The water heater manufacturer's instructions take priority over the instructions here.





If for any reason you question your ability, or feel any doubt about your ability to perform any of the troubleshooting procedures or repairs recommended. **STOP! Contact a trained and qualified service professional to repair the water heater.**

To troubleshoot the system using the error code indicators:

1. Check that the system is currently active and calling for a request for heat. You can initiate a call for heat by either drawing hot water from a nearby faucet or raising the tem-

perature setting (see section "Temperature Regulation"). If you have noted an error code from a previous heating cycle, this step is not necessary, and you may proceed with the next step.

2. Refer to the troubleshooting charts on below to find the error code that is displayed. Check and repair those items recommended.
3. Once the repair is complete, again initiate a call for heat, and observe that the ignition sequence complies with that shown on page 7.
4. After the water heater repair is complete, return the water heater temperature setting to the original temperature. If for any reason you cannot remember the original setting, return the setting to the 120°F setpoint. See the section "Temperature Regulation" for assistance in setting the water temperature setting.

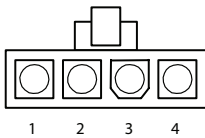
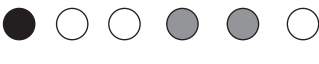
	Error	Indication	Check, Repair, or Replace
	1	An open earth ground circuit to the ignition system	<ol style="list-style-type: none"> 1. Check that the earth ground conductor is properly connected at the fuse box or breaker panel and the water heater. 2. Check that the grounding conductors on the water heater are properly connected and secure.
	2	The self diagnostic test detected a wiring error or a high resistance to earth ground	<ol style="list-style-type: none"> 1. Check for proper connection of the line neutral and line hot wires. 2. Check that the appliance is securely connected to earth ground.
	3	The pressure switch remained closed longer than 5 seconds after the call for heat began.	<ol style="list-style-type: none"> 1. The pressure switch wiring is incorrect. 2. The pressure switch is defective and must be replaced.
	4	The pressure switch remained open longer than 5 seconds after the combustion blower was energized	<ol style="list-style-type: none"> 1. The pressure switch wiring is incorrect. 2. The pressure switch tubing is not connected correctly. 3. Obstructions or restrictions in the water heater air intake or exhaust flue.
	5	<p>The self diagnostic test has detected an error in the Hot Surface Ignitor circuit.</p> 	<ol style="list-style-type: none"> 1. Check that all wiring is correct and secure. 2. Disconnect the ignitor and measure the ignitor resistance with an accurate ohmmeter between pins 1 and 2. Resistance should be between 11.5 and 18.8 ohms. If the reading is incorrect, replace the Hot Surface Ignitor. 3. If the above checks are good, replace the INTELLI-VENT™ control.
	6	The maximum number of ignition retries or recycle has been reached and the system is in lockout	<ol style="list-style-type: none"> 1. Check if the gas supply is off or too low to operate. 2. Check that the flame sense rod to see that it is located properly and free from contamination. Reposition the flame sense rod or lightly clean with an abrasive cloth. 3. The Hot Surface Ignitor may not be positioned correctly. Reposition as necessary. 4. The Hot Surface Ignitor and Flame Sense Rod wired correctly and in good working condition. Repair as required. 5. Low voltage to the water heater. Check and repair.

TROUBLESHOOTING

	7	The self diagnostic test found a problem with the gas valve driver circuit	<ol style="list-style-type: none"> 1. Cycle power to the water heater off for 10 seconds and then back on. 2. If the above step did not clear the error, the INTELLI-VENT™ control must be replaced
	8	The self diagnostic test has detected a problem with the internal microcomputer.	<ol style="list-style-type: none"> 1. Cycle the external power off for 10 seconds and then back on. 2. If the above step does not clear the error, the INTELLI-VENT™ control must be replaced.
	9	The self diagnostic test has detected a problem with the internal circuit	<ol style="list-style-type: none"> 1. Cycle the external power off for 10 seconds and then back on. 2. If the above step does not clear the error, the INTELLI-VENT™ control must be replaced.
	10	Flame signal sensed out of proper sequence.	<ol style="list-style-type: none"> 1. Replace the INTELLI-VENT™ control.
	11	The high temperature thermal cutoff is open	<ol style="list-style-type: none"> 1. Replace the INTELLI-VENT™ control.
	12	The diagnostic test has detected one of the temperature adjust buttons stuck closed	<ol style="list-style-type: none"> 1. Make sure that there are no objects leaning against the front of the control. 2. Lightly press and release each of the buttons once. 3. If the above actions do not clear the error, the control will continue to regulate water temperature at the last setting, but you not be able to change settings unless you replace the INTELLI-VENT™ control.
	13	The self diagnostic test has detected that the water temperature sensor is either open or short circuited.	<ol style="list-style-type: none"> 1. Check that all wiring is correct and that there are no open or shorted circuits. 2. If no wiring problems are found the INTELLI-VENT™ control must be replaced by a qualified service person.
	14	The self diagnostic test found a problem with the Flammable Vapor Sensor	<ol style="list-style-type: none"> 1. Check that all wiring is correct and that there are no open or shorted circuits. 2. If no wiring problems are found the flammable Vapor Sensor must be replaced.
	15	The control detected the presence of flammable vapors near the appliance and entered lockout.	<ol style="list-style-type: none"> 1. If you smell gas, STOP! Follow the instructions, "What to do if you smell gas" on page 1 of this instruction sheet. Otherwise call a qualified service person for replacement of the control.

NOTES

NOTES

White-Rodgers is a division
of Emerson Electric Co.

The Emerson logo is a
trademark and service mark
of Emerson Electric Co.

White
Rodgers™

www.white-rodgers.com
www.emersonclimate.com



Free Manuals Download Website

<http://myh66.com>

<http://usermanuals.us>

<http://www.somanuals.com>

<http://www.4manuals.cc>

<http://www.manual-lib.com>

<http://www.404manual.com>

<http://www.luxmanual.com>

<http://aubethermostatmanual.com>

Golf course search by state

<http://golfingnear.com>

Email search by domain

<http://emailbydomain.com>

Auto manuals search

<http://auto.somanuals.com>

TV manuals search

<http://tv.somanuals.com>