



Clear Picture

PURE | AV™  
by Belkin



Clean Sound

Home Theater Power Protection with PureFilter™ Technology  
Power Console PF60

## User Manual



# Table of Contents

	Page
Introduction .....	2
Safety Precautions .....	3
Package Contents .....	4
Power Console Features .....	5
<b>Hookup and Installation</b>	
<b>Step 1 (optional)</b> Mounting your Power Console .....	7
<b>Step 2</b> Program the Outlet Banks .....	8
<b>Step 3</b> Remote AC Operation .....	10
<b>Step 4</b> Remote DC Operation .....	11
<b>Step 5</b> Connect Digital Components to Digital Filter 1 and Digital Filter 2 (Bank 01 and Bank 02) .....	12
<b>Step 6</b> Connect Video Components to the Video Filter (Bank 03) .....	13
<b>Step 7</b> Connect Audio Components to Audio Filter 1 and Audio Filter 2 (Bank 04 and Bank 05) .....	14
<b>Step 8</b> Connect High-Current Audio Filter (Bank 06) .....	15
<b>Step 9</b> Connect your Pay-Per-View/Phone Line .....	16
<b>Step 10</b> Connect your Coaxial-Cable/DSS Lines .....	17
<b>Step 11</b> Connect your Broadband Ethernet Line .....	18
<b>Operation</b> .....	19
<b>Troubleshooting</b> .....	21
<b>Glossary of Power Terms</b> .....	23
<b>Belkin Connected Equipment Warranty</b> .....	24

# Introduction

Thank you for purchasing the PureAV Power Console PF60. The Power Console is designed to clean, protect, and efficiently distribute power to your valuable home theater system. The PureAV Power Console ensures that every movie you watch and every album you hear is as clean and clear as possible.

The Power Console is packed with innovative features to provide you with the best home theater experience. Ordinary household AC power that is delivered to your home is polluted with “noise” from many sources within your home, including digital components and household appliances. The Power Console’s advanced Phase 6 PureFilter Circuitry is optimized to remove electrical noise and provide clean and clear power to all of your valuable digital, audio, video, and high-current equipment. The multiphase PureFilter Circuitry also provides true isolation between audio, video, digital, and high-current components. This isolation prevents noise created by components that are already connected to the Power Console from contaminating other connected equipment. In addition, the Power Console contains Advanced Overvoltage Protection, which automatically disconnects power from your equipment when the input voltage reaches a dangerous level, and restores power automatically when the voltage returns to a safe level.

We also realize that the aesthetics of your system are very important. For this reason, we enlisted some of the top industrial designers in the country to design the housing for the PureAV Power Console. The minimalist styling of the Power Console combines function with a simplistic yet elegant design and is a great complement to any system. The integrated multifunction LCD combines all essential controls with a versatile voltage and current monitor.

As you may know, your AC power source is not the only threat to the safety of your equipment. This is why the PureAV Power Console has four sets of coaxial connections to protect your coaxial-cable lines. The Power Console also includes telephone jacks to protect Pay-Per-View lines and broadband Ethernet jacks to protect data lines that stream digital content to your home theater system.

Providing the ultimate home theater experience is the driving force behind the PureAV design, providing the clearest picture and cleanest sound from your components to you. Thank you again for purchasing the PureAV Power Console PF60.

**Clear Picture - Clean Sound. PureAV.**

# Safety Precautions

## **Warning – Grounding and Polarization**

This product must be plugged directly into a grounded AC power outlet (3-prong). Do not use a 3-to-2-prong adapter to defeat the grounding pin. Do not plug or “daisy-chain” this product into other electrical products such as surge protectors, power strips, or UPSes. Do not plug this product into an extension cord. Failure to plug this product directly into a grounded outlet may result in personal injury or damage to your equipment. Call a licensed electrician if you are unsure if your AC outlets are properly grounded.

## **Warning – Rooftop Antennas and Satellite Dishes**

If you use rooftop antennas, satellite dishes, or any other rooftop hardware that connects to your PureAV Power Console, make sure that all the wires leading from these components are properly grounded. This will protect against voltage surges from lightning strikes or static charges.

## **Warning – Lightning Storm Protection**

Although your PureAV Power Console is built to withstand large power surges, we cannot guarantee that it will protect all of your equipment in the event of a large lightning storm. In the event of a lightning storm, it is best to unplug your Power Console from the wall. Once you have done this, there is no need to unplug any of the equipment that is connected to the Power Console.

## **Warning – Water and other Liquids: Shock Hazard**

Do not use this product with aquariums or other water-related products. Use indoors and in dry locations only. Do not operate the Power Console if any liquid is spilled on or in the unit. Failure to follow these guidelines could result in serious bodily injury or death.

## **Warning – Cleaning**

Always unplug the Power Console before cleaning. It is only necessary to clean the Power Console with a clean, dry cloth or duster. Do not use any cleaning solutions, sprays, or water.

## **Warning – No User-Serviceable Parts Inside**

If for any reason your Power Console is malfunctioning, do not attempt to repair or dismantle the unit in any way. Unplug the unit and consult this User Manual for warranty and service contact information.

## **Warning – Power Cord Safety**

Do not route the Power Console's AC power cord near heat sources. This could damage the power cord and cause it to malfunction, creating a shock hazard.

Do not route the Power Console's AC power cord in heavy foot-traffic areas where it could create a trip hazard (hallways, doorways, across room).

If the power cord is frayed, ripped, cut, or damaged in any way, please discontinue use immediately and refer to the warranty section of this Manual for instructions.

## Package Contents

- User Manual
- PureAV Power Console PF60
- Remote AC Control Cable
- Remote DC Control Cable (1/8" mini-plug cable)
- RJ45 Ethernet Patch Cable - For broadband connectivity
- RJ11 Phone Cable
- PureAV Coaxial Video Cable
- One sheet of PureAV cable labels
- One pair of rack-mount brackets and bag of assembly screws
- Warranty registration card

# Power Console Features

1. **Switched button** - turns the power on and off to the Power Console's "switched" outlets
2. **Auxiliary outlet** - offers optimal connection for digital components and is ideal for temporary connection of equipment such as video/digital cameras, game consoles, or any device you wish to power
3. **Central LCD Control** - controls and monitors the Power Console's vital functions
4. **Digital Filter 1** - ensures optimum reduction of line noise and interference to your digital components
5. **Digital Filter 2** - ensures optimum reduction of line noise and interference to your digital components
6. **Video Filter** - ensures optimum reduction of line noise and interference to your video components
7. **Audio Filter 1** - ensures optimum reduction of line noise and interference to your audio components
8. **Audio Filter 2** - ensures optimum reduction of line noise and interference to your audio components
9. **HiCurrent™ Filter** - delivers high current to power-hungry amplifiers and receivers; optimized to filter out line noise to these components
10. **Programmable bank switches** - allows you to program each bank of outlets
11. **Trigger Out** - allows for remote operation of peripheral devices equipped with a low-voltage trigger
12. **Remote AC/DC trigger** - allows for remote turn on/off of switched outlets on the Power Console (equipped with both AC and DC inputs)
13. **Pay-Per-View/Phone Line Input/Output** - protects Pay-Per-View, phone, or DSL lines from dangerous power surges that can damage your equipment; built-in splitter turns one line into two

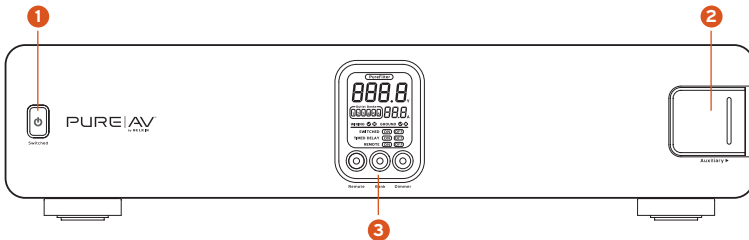

# Power Console Features

- 14. **Coaxial-Cable Line Input/Output** - protects coaxial cable lines from dangerous electrical disturbances that can travel down your coaxial cable lines
- 15. **Broadband Ethernet Input/Output** - protects broadband Ethernet lines used for digital media receivers, gaming, or broadband Internet access from dangerous power surges
- 16. **15-Amp Circuit Breaker** - offers safety of resettable circuit breaker
- 17. **Ground** - provides a grounding point for ungrounded components

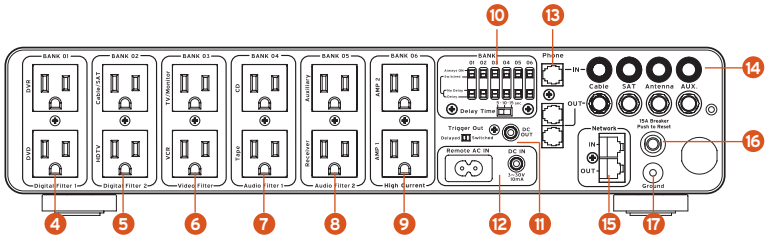

# Hookup and Installation

## Step 1 (optional)

### Mounting your Power Console

The PureAV Power Console can be mounted to a standard AV equipment rack or inside a cabinet equipped with an equipment rack.

- A. Remove the brackets and mounting screws from the box.
- B. Make sure that the Power Console is unplugged.
- C. Align the bracket with the front of the Power Console for flush installation in the rack.
- D. Attach the bracket to the side of the Power Console with the screws provided (Fig. 1). You must use a minimum of four screws to mount each bracket.
- E. Repeat steps 3 and 4 for installation of the bracket to the other side of the Power Console.
- F. Mount the Power Console to the equipment rack. Screws for mounting the Power Console to the equipment rack are not provided as they are made specifically for the particular equipment rack that you own. Contact the manufacturer of the rack if you do not have the correct mounting screws.

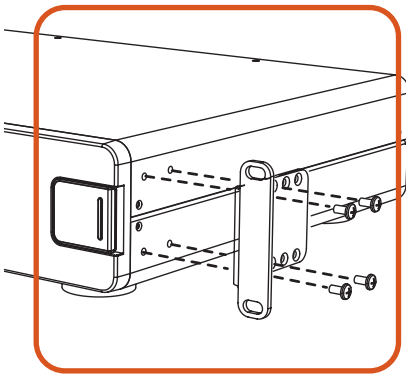

Figure 1



# Hookup and Installation

## Step 2

### Program the Outlet Banks

Each outlet bank on the rear panel of the Power Console is programmable. Using the slide switches on the rear panel, you can program the outlets for switched or unswitched, and for delay or always-on (no delay) (Fig. 2). You can also determine the length of the delay (5, 10, or 15 seconds).

- A. Outlet Banks Always-On (unswitched):** For components that need to retain memory or other settings (DVRs, satellite receivers, VCRs), set the top slide switch to “Always ON” (Fig. 2a). These outlet banks will always supply power when the Power Console is plugged into the wall.
- B. Outlet Banks Switched On (no delay):** Set the top slide switch to “Switched”. Make sure that the lower slide switch is set to “No Delay” (Fig. 2b). The outlet banks will be immediately powered-on when the Power Console is switched-on by pressing the “Switched” button on the front of the unit. Switched outlets can also be switched-on by external remote signal (see page 10-11). These outlets will remain powered-on for a short period of time after switching them off depending on the “Delay Time” setting (see “Delay Time Switch” below).
- C. Outlet Banks Switched On After Delay:** You may find it necessary to program your outlets to switch on after a delay. Once the delay is set, the outlets will be powered-on after the outlets that are set for “no delay” have powered-on. They will then power-off in reverse sequence: “delay” outlets will power-off first and “no delay” outlets will power-off last. This is useful to avoid the loud and occasionally damaging speaker “thump” created when the amplifier voltage is stabilizing.
  - a. Set the top slide switch to “Switched” and the bottom slide switch to “Delay” (Fig. 2c).
  - b. Repeat this for each bank that you want to be switched on after a delay.
  - c. Press the “Switched” button on the front of the Power Console to activate all of the switched outlets.

**Note:** The delay can only be set on “Switched” outlets.

- D. Delay Time Switch:** This switch sets the length of delay for all outlet banks that are programmed as “Switched” and “Delay”. Set the delay time by selecting 5, 10, or 15 seconds (Fig. 2d). 15 seconds is the recommended delay time for tube amplifiers.

# Hookup and Installation

**E. Trigger Out:** The trigger out function gives you the ability to control an external device equipped with a remote trigger such as a retractable movie screen when the Power Console is switched on. The 12-volt DC OUT port accepts a 1/8" mini plug cable. Set the "Trigger Out" switch to "Delayed" and the Trigger Out will power an external device after a delay set by the Delay Time Switch (Fig. 2e). If you do not want a delay then set the "Trigger Out" switch to "Switched".

**Note:** This feature also allows you to remotely control multiple power consoles using a Remote DC Control Cable. Simply connect the cable from the "DC OUT" to the "DC IN" on another Power Console.

Figure 2

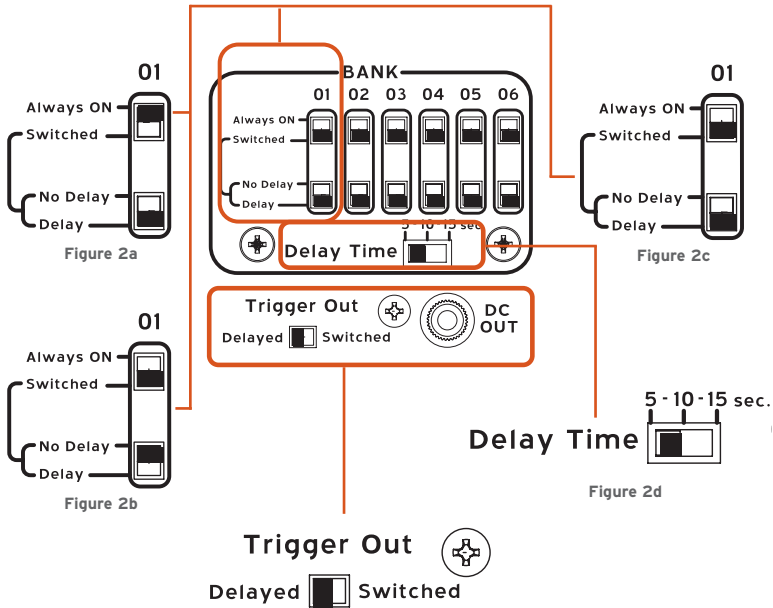

Figure 2e

# Hookup and Installation

## Step 3

### Remote AC Operation

This function allows you to turn your Power Console on and off via your preamplifier or receiver equipped with a switched AC power outlet.

**Note:** You cannot turn off the switched outlets on the Power Console with the switched button on the front of the unit when there is any external power signal supplied to either the AC or DC remote inputs.

To install the Remote AC Control Cable:

- A. Plug the female end of the included Remote AC Control Cable into the "Remote AC IN" outlet located on the back of the Power Console. (Fig. 3a)
- B. Press the "Remote" button on the front of the Power Console to turn on the remote function. The LCD display should read "REMOTE ON". (Fig. 3b)
- C. Press the "Switched" button on the front of the Power Console to turn off the switched outlets.
- D. Connect the 2-pronged male end of the Remote AC Control Cable into a switched power outlet on a preamplifier or receiver. When you turn on the receiver or preamplifier, the outlets on the Power Console that are programmed as "Switched" will be turned on immediately and the "Switched/ Delayed" outlets will come on after a delay set by the "Delay Time Switch".

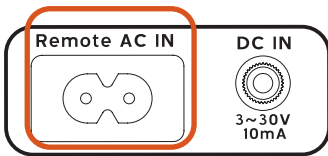

Figure 3a

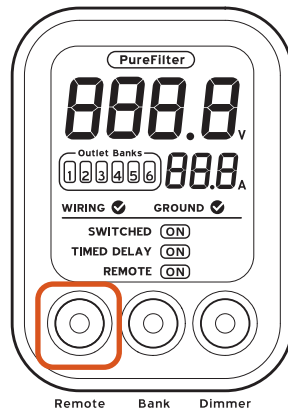

Figure 3b

# Hookup and Installation

## Step 4 Remote DC Operation

This function allows you to turn your Power Console on and off via any component that is equipped with a 3~30V DC output (low-voltage trigger out).

**Note:** You cannot turn off the switched outlets on the Power Console with the switched button on the front of the unit when there is any external power signal supplied to either the AC or DC remote inputs.

To install the Remote DC Control Cable:

- A. Connect the Remote DC Control Cable (included) into the outlet labeled "DC IN" on the rear panel of the Power Console. (Fig. 4a)
- B. Press the "Remote" button on the front of the Power Console to turn on the remote function. The LCD display should read "REMOTE ON". (Fig. 4b)
- C. Press the "Switched" button on the front of the Power Console to turn off the switched outlets.
- D. Connect the other end of the Remote DC Control Cable into the 3~30V output (low-voltage trigger out) on your component. When you turn on the component, the outlets on the Power Console that are programmed as "Switched" will be turned on immediately and the Switched/Delayed outlets will come on after a delay set by the "Delay Time Switch".

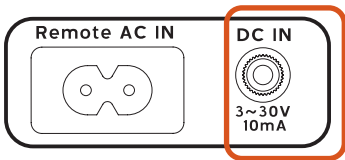

Figure 4a

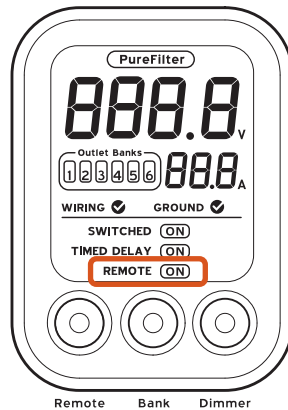

Figure 4b

# Hookup and Installation

## Step 5

### Connect Digital Components to Digital Filter 1 and Digital Filter 2 (Bank 01 and Bank 02)

The PureAV Power Console PF60 contains two isolated digital filters that are optimized to clean and condition the power to all of your digital components. The digital filters also filter out noise created by digital components such as DVD players and isolate your digital components from connected video, audio, and high-current audio components.

- A. Attach PureAV power cord labels to each component's power cord before you plug the cord into the corresponding outlet on the Power Console.
- B. **Cable/Satellite** - Connect your cable or satellite receiver power cord to the outlet labeled "Cable/SAT".
- C. **HDTV** - Connect your HDTV power cord to the outlet labeled "HDTV".
- D. **Digital Video Recorder** - Connect your digital video recorder power cord to the outlet labeled "DVR".
- E. **DVD** - Connect your DVD power cord to the outlet labeled "DVD".

**Note:** You can connect any type of digital component into any of the digital filter outlets. You are not limited to the components listed above.

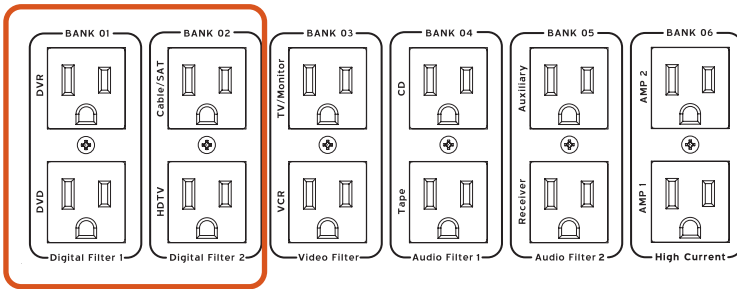

# Hookup and Installation

## Step 6

### Connect Video Components to the Video Filter (Bank 03)

The PureAV Power Console PF60 contains an isolated video filter that is optimized to clean and condition the power to all of your video components. The video filter also isolates your video components from connected digital, audio, and high-current audio components.

- A. Attach PureAV power cord labels to each component's power cord before you plug the cord into the corresponding outlet on the Power Console.
- B. **TV** - Connect your TV or monitor power cord to the outlet labeled "TV/Monitor".
- C. **VCR** - Connect your VCR power cord to the outlet labeled "VCR".

**Note:** You can connect any type of video component into any of the video filter outlets. You are not limited to the components listed above.

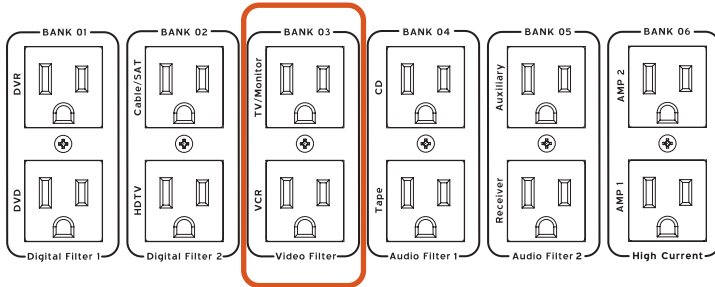

# Hookup and Installation

## Step 7

### Connect Audio Components to Audio Filter 1 and Audio Filter 2 (Bank 04 and Bank 05)

The PureAV Power Console PF60 contains two isolated audio filters that are optimized to clean and condition the power to all of your audio components. The audio filters also isolate your audio components from connected digital, video, and high-current audio components.

- A. Attach PureAV power cord labels to each component's power cord before you plug the cord into the corresponding outlet on the Power Console.
- B. **CD** - Connect your CD player power cord to the outlet labeled "CD".
- C. **Tape** - Connect your tape player power cord to the outlet labeled "Tape".
- D. **Auxiliary** - This outlet can be used to connect any other audio equipment you may have.
- E. **Receiver (Preamp)** - Connect your receiver or preamp power cord to the outlet labeled "Receiver".

**Note:** You can connect any type of audio component into any of the audio filter outlets. You are not limited to the components listed above.

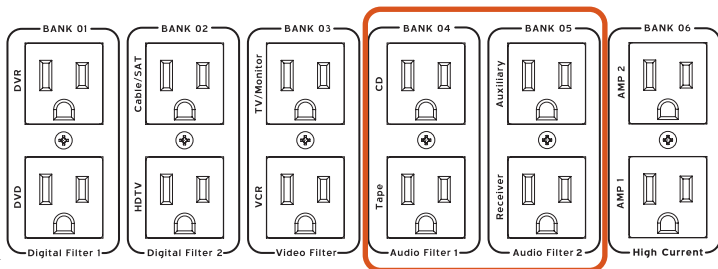

# Hookup and Installation

## Step 8

### Connect High-Current Audio Filter (Bank 06)

This outlet is specifically designed to filter out AC line noise while delivering maximum current to power-hungry amplifiers and other high-current audio components. These outlets should be programmed for "Delay". This allows your high-current amplifiers to turn on last and turn off first, avoiding that annoying, and potentially damaging "thump" from getting to your speakers.

- A. Attach PureAV power cord labels to each component's power cord before you plug the cord into the corresponding outlet on the Power Console.
- B. **AMP 1** - Connect your main amplifier power cord to the outlet labeled "AMP 1".
- C. **AMP 2** - Connect your secondary amplifier power cord to the outlet labeled "AMP 2".

**Note:** You can connect any type of high-current audio component into any of the high-current outlets. You are not limited to the components listed above.

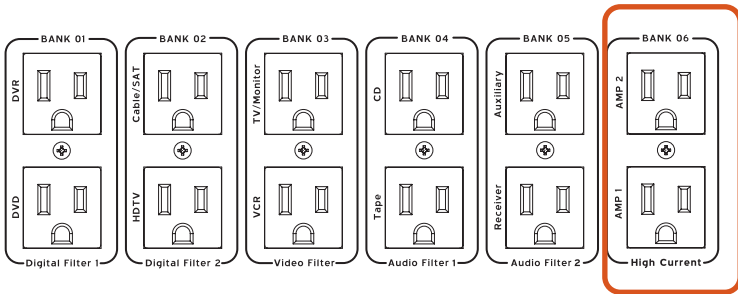



# Hookup and Installation

## Step 9

### Connect your Pay-Per-View/Phone Line

Your PureAV Power Console comes equipped with Pay-Per-View/phone-line protection with a built-in splitter. These are standard RJ11 phone jacks and are labeled "Phone".

- A. Connect one end of your telephone cable to the wall outlet to which you normally connect your phone line. Connect the other end of your telephone cable to the Power Console phone jack labeled "IN".
- B. Connect one end of the PureAV phone cable (included) to the Power Console phone jack labeled "OUT". Connect the other end of this cable to the Pay-Per-View phone jack on your DSS receiver.
- C. To connect a telephone - Connect one end of another phone cable to the other Power Console phone jack labeled "OUT". Connect the other end of this cable to the telephone you want to use.

**Note:** We have included labels for the Phone IN and Phone OUT lines if needed for better organization.

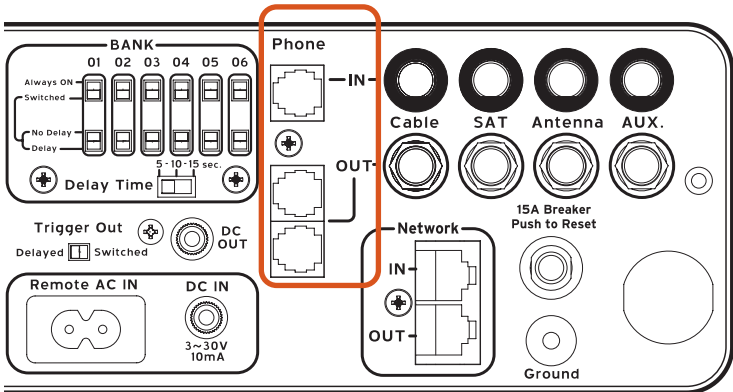

# Hookup and Installation

## Step 10 Connect your Coaxial-Cables/DSS Lines

Your PureAV Power Console comes with three pairs of coaxial-cable connections to protect your system from dangerous electrical disturbances that can travel down your coaxial-cables lines. You will need additional coaxial cables to connect the Power Console to your home theater components.

- A. Cable TV** - Connect the incoming cable television coaxial-cable line to the connector labeled "Cable IN". Connect one end of a second coaxial cable to the connector labeled "Cable OUT". Connect the other end of this cable to your cable TV tuner.
- B. Satellite (DSS) TV** - Connect the incoming satellite television coaxial-cable line to the connector labeled "SAT IN". Connect one end of a second coaxial cable to the connector labeled "SAT OUT". Connect the other end of this cable to your satellite TV tuner.
- C. Antenna** - Connect the incoming TV or radio antenna cable line to the connector labeled "Antenna IN". Connect one end of a second coaxial cable to the connector labeled "Antenna OUT". Connect the other end of this cable to your TV or radio equipment.
- D. HDTV, Broadband, or other Coaxial-Cable Lines** - Connect any other incoming cable lines you want to protect to the connector labeled "AUX IN". Connect one end of a second coaxial cable to the connector labeled "AUX OUT".

**Note:** We have included labels for the Coax IN and Coax OUT lines if needed for better organization.

**IMPORTANT WARNING** - To sufficiently safeguard all of your equipment from damage resulting from a power surge, all of your incoming coaxial-cable lines should be properly grounded. Contact a licensed electrician to verify that all of your cable lines are properly grounded to a cold water pipe or ground rod.

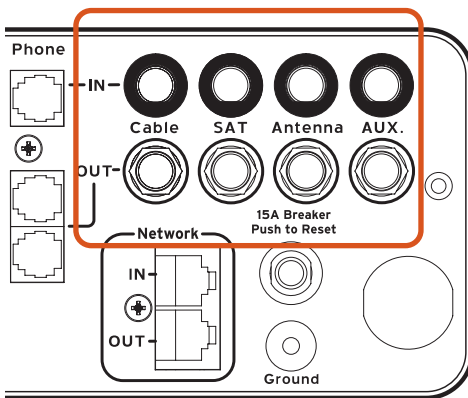

# Hookup and Installation

## Step 11

### Connect your Broadband Ethernet Line

Your PureAV Power Console comes equipped with broadband Ethernet line protection. These are standard RJ45 Ethernet jacks and they are labeled "Network".

- A. Connect one end of an RJ45 network patch cable to a network jack (either directly to a router or wired network wall jack). Connect the other end of the network patch cable to the network jack labeled "IN".
- B. Connect one end of the broadband Ethernet cable (included) to the network jack labeled "OUT". Connect the other end of this cable to the networked device (digital media receiver, gaming console, etc.)

**Note:** We have included labels for the Network IN and Network OUT lines if needed for better organization.

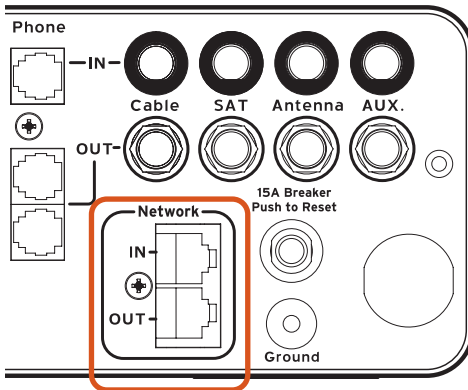

# Operation

## Central LCD Control Panel

The PureAV Power Console PF60 is equipped with an advanced LCD Control Panel. Most functions of the Power Console can be monitored from this display.

- A. PureFilter Indicator** - indicates that the multiphase PureFilter circuitry is functioning properly.
- B. Voltmeter** - displays the input voltage (the amount of voltage coming from the AC wall outlet to the Power Console).
- C. Current Meter** - displays the output current (the amount of current output [in Amps] from the Power Console's outlet banks). You can choose to see the current output from all of the banks at the same time or individual banks using the "Bank Selector" button.
- D. Outlet Banks** - displays the currently selected bank for monitoring output current (controlled with the "Bank" button).
- E. Wiring** - indicates whether the AC outlet to which the Power Console is connected is wired properly, or cross-wired.
  - ✔ Wiring ok.
  - ✘ Hot and neutral wires are reversed. See page 22 of the Troubleshooting section for more information.
- F. Ground** - Indicates if the Power Console is connected to a properly grounded AC outlet.
  - ✔ Ground ok. The AC wall outlet is properly grounded.
  - ✘ Ground Fault. This indicates that the AC wall outlet is NOT properly grounded. See page 22 of the Troubleshooting section for more information.
- G. Switched Indicator** - indicates whether the "Switched" outlets are switched ON or OFF.
- H. Timed Delay Indicator** - indicates that the delayed outlets are switched ON after a delay.
- I. Remote Indicator** - indicates whether the Remote function is ON or OFF (controlled with the "Remote" button).
- J. Remote Button** - switches the Power Console to Remote ON status when pressed. (When in Remote ON status, the Power Console outlets programmed as switched are turned ON/OFF via external remote signal [see page 10-11.]

# Operation

- K. Bank Selector Button** - lets you select which outlet banks you want to monitor; press the button repeatedly to choose either a single bank (Fig. 5a) or all banks (Fig. 5b).
- L. Dimmer Button** - adjusts the brightness of the LCD Control Panel; press it repeatedly to change the brightness level.

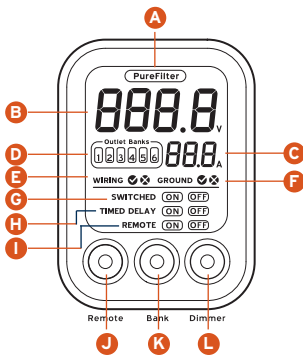

Figure 5a



Figure 5b

## Auxiliary Power Outlet

The Power Console is equipped with a front auxiliary power outlet. This outlet contains a digital noise filter and is a convenient place to connect digital video cameras, digital still cameras, MP3 players, or any other portable device in need of AC power. Simply remove the small door covering the outlet by sliding it to the right (Fig. 6) and plug in your device.

**Note:** The Auxiliary Power Outlet is controlled by the “Bank 01” slide switches on the rear panel of the Power Console. See page 8 for further instructions on programming the outlet banks.

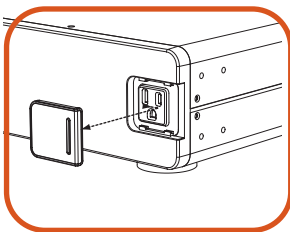

Figure 6

# Troubleshooting

## Power Console is not providing power

- Check to ensure that the Power Console is plugged into a properly grounded AC wall outlet. Some outlets require a wall switch to be turned on in order to deliver power to the outlet.
- Too many devices may be plugged into the Power Console, which are overloading the unit and tripping the overload circuit breaker. The Power Console is not designed to handle current loads larger than 15 Amps or 1800 watts. Try unplugging some devices and resetting the circuit breaker located on the end of the Power Console

To reset the circuit breaker: Wait at least 10 minutes after the circuit breaker was tripped before attempting to reset the breaker. Press in the button located next to the power cord on the end of the unit to reset. Power should be restored to the outlets on the Power Console.

- Your components may be plugged into a “Switched” outlet and the outlet is not switched on. Check to ensure that the “Switched ON” indicator on the Control Panel is illuminated. If the light is not illuminated, press the “Switched” button on the front of the Power Console unit until the “Switched ON” indicator is illuminated. You should now have power to all of the switched outlets.
- Your components may not be turned on. Power may be flowing from the Power Console, but if the power switch on your component is not turned on then your component cannot receive power. Turn on the power switch on your component.
- The surge protection components may be expired. The Power Console is designed to stop delivering power to all outlets when the surge-protection circuitry is not functioning properly or is expired. Call Belkin Customer Service for assistance.
- The Power Console may be defective. Call Belkin Customer Service for assistance.

# Troubleshooting

## Ground Fault indicator is lit

### GROUND ❌

- Check to make sure that the Power Console is plugged into a grounded AC wall outlet. (3-prong AC outlets only. Do not use 2-3-prong adapters.)
- If the “Ground Fault” indicator is still lit, you have a ground-wiring problem. Connecting the PureAV Power Console to an improperly grounded outlet is not safe and will void all Belkin Corporation warranties. Unplug the Power Console and consult an electrician to properly ground the outlet. If the outlet is properly grounded and the “Ground Fault” indicator is still lit, the Power Console may be malfunctioning. Please call Belkin Customer Service for assistance.

## Cross-Wired indicator is lit

### WIRING ❌

- Check to make sure that the Power Console is plugged into a grounded AC wall outlet. (3-prong AC outlets only. Do not use 2-3-prong adapters.)
- This indicates that the hot and neutral (L-N) wires are reversed. Unplug the Power Console and consult an electrician.

**For all other technical questions or troubleshooting issues, please contact Belkin Customer Service at 800-223-5546.**

# Glossary of Power Terms

**Alternating Current (AC):** The current that is commonly flowing through the electrical outlets in your home. It is an electrical current in the form of a sine wave that oscillates up and down continuously.

**Amp:** An abbreviation for Ampere. This is a unit of electrical current.

**Direct Current (DC):** An electrical current flowing in one direction only. DC current does not have a wave form.

**Electromagnetic Interference (EMI):** Electrical interference generated by appliances and many other electrical components that cause degradation of sound and picture quality in audio and video equipment.

**Ground:** A conducting object, such as a wire, that is connected to a position of zero-voltage potential. Common connecting points are ground rods or cold-water pipes that are connected to the Earth.

**Joule Rating:** A measure of electrical energy. The higher the joule rating, the more electrical surges a device can absorb before failing.

**Maximum Spike Current:** The maximum current (in Amps) that can be absorbed before failing. The higher the maximum spike current, the more current a device can absorb without failing.

**Radio Frequency Interference (RFI):** Electromagnetic radiation, which is emitted by electrical circuits carrying rapidly changing signals as a by-product of their normal operation, and which causes interference or noise to be induced in other circuits.

**Spike:** A very fast transient variation in voltage or current. Many small transients, over time, cause components to wear and fail.

**Surge:** An increase in voltage or current significantly above the designated level in a flow of electricity.



## Belkin Connected Equipment Warranty

Belkin Corporation warrants to the original purchaser of any PureAV Power Console for the life of the product, that the PureAV Power Console shall be free of defects in design, assembly, material, or workmanship, and will repair or replace, at its option, any defective product free of charge.

Belkin Corporation will repair or replace, at its option, any equipment which is damaged by a transient voltage surge/spike or lightning strike, (an "Occurrence"), while properly connected through a PureAV Power Console to a properly wired AC power line with protective ground. If you are using an AC PureAV Power Console that has phone, network, or coaxial protection, the telephone line, network line, and coaxial-cable line must be properly connected and installed, as determined by Belkin at its sole discretion.

This Connected Equipment Warranty is a Limited Warranty, subject to the limitations and exclusions set forth herein.

Belkin Corporation will spend, to repair or replace the damaged connected equipment, at Belkin's option, an amount equal to the fair market value of the damaged equipment or the original purchase price of the equipment, whichever is less, up to the maximum amount set forth below:

Model AP20800-10 up to a maximum of \$350,000.00

Models AP21100-12, AP21300-12, AP41300-12 up to a maximum of \$500,000.00

The fair market value of the equipment shall be the current value of the equipment specified in the most recent edition of the Orion Blue Book by Orion Research Corporation, Roger Rohrs Publisher.

Belkin Corporation reserves the right to review the damaged PureAV Power Console, the damaged equipment, and the site where the damage occurred. All costs of shipping the PureAV Power Console and the damaged equipment to Belkin Corporation for inspection shall be borne solely by the purchaser. Belkin reserves the right to negotiate the cost of repairs. If Belkin determines, in its sole discretion, that it is impractical to ship the damaged equipment to Belkin Corporation, Belkin may designate, in its sole discretion, an equipment repair facility to inspect and estimate the cost to repair such equipment. The cost, if any, of shipping the equipment to and from such repair facility and of such estimate shall be borne solely by the purchaser. Damaged equipment must remain available for inspection until the claim is finalized. Whenever claims are settled, Belkin Corporation reserves the right to be subrogated under any existing insurance policies the claimant may have.

All above warranties are null and void if: the PureAV Power Console in use during the Occurrence is not provided to Belkin Corporation for inspection upon Belkin's request at the sole expense of the purchaser, Belkin Corporation determines that the PureAV Power Console has been improperly installed, altered in any way or tampered with, Belkin Corporation determines that the damage did not result from the Occurrence or that no Occurrence in fact took place, the repair or

# Belkin Connected Equipment Warranty

replacement of the damaged equipment is covered under a manufacturer's warranty, or Belkin Corporation determines that the connected equipment was not used under normal operating conditions or in accordance with any labels or instructions. All PureAV Power Consoles must be plugged directly into the power source and must not be "daisy-chained" together in serial fashion with other power strips, UPSes, other surge protectors or extension cords. A 3-2-prong adapter may not be used. Any such installation voids the warranty. The Belkin Connected Equipment Warranty only protects against damage to properly connected equipment where Belkin Corporation has determined, in its sole discretion, that the damage resulted from an Occurrence, and does not protect against acts of God (other than lightning) such as flood, earthquake, war, vandalism, theft, normal-use wear and tear, erosion, depletion, obsolescence, abuse, damage due to low voltage disturbances (i.e. brownouts or sags), non-authorized program, or system equipment modification or alteration. \*Please note: This product is not for use with aquariums and all other water-related products. Use only indoors and in dry locations.

This warranty contains the sole warranty of Belkin Corporation, there are no other warranties, expressed or, except as required by law, implied, including the implied warranty or condition of quality, merchantability or fitness for a particular purpose, and such implied warranties, if any, are limited in duration to the term of this warranty. Some states do not allow limitations on how long an implied warranty lasts, so the above limitations may not apply to you.

In no event shall Belkin Corporation be liable for incidental, special, direct, indirect, consequential or multiple damages such as, but not limited to, lost business or profits arising out of the sale or use of any PureAV Power Console, even if advised of the possibility of such damages. This warranty gives you specific legal rights, and you may also have other rights, which may vary from state to state. Some states do not allow the exclusion or limitation of incidental or consequential damage, so the above limitations may not apply to you.

This warranty is valid only for the original purchaser of the product. All damage claims against the product must be made within 15 days from the date of the Occurrence and must be accompanied by a receipt for the damaged equipment or the warranty is void. Warranty is valid in USA, Canada, Puerto Rico, and Bermuda. To file a claim against the Belkin Connected Equipment Warranty, you must take the following steps: Contact Belkin online at [www.belkin.com](http://www.belkin.com) and print our claim form or write to us at:

**Belkin Corporation, 501 W. Walnut St., Compton CA 90220**

Attn: Technical Support, or call (310) 898-1100, extension 2263, within 15 days of the Occurrence. Be prepared to provide the following information:

## Belkin Connected Equipment Warranty

- a. The part number of the PureAV Power Console.
- b. The equipment that was connected to the PureAV Power Console at the time of the Occurrence.
- c. The equipment that was damaged during the Occurrence and the extent of the damage.
- d. The date of the Occurrence.
- e. Where you purchased the PureAV Power Console.
- f. When you purchased the PureAV Power Console.
- g. Copy of original receipt.
- h. Your Belkin Customer Service Representative will then instruct you on how to forward your equipment, receipt, PureAV Power Console in use during the "Occurrence" and how to proceed with your claim.

Please conveniently register your PureAV Power Console online on our website at [www.belkin.com](http://www.belkin.com).

**Belkin Corporation • 501 West Walnut Street • Compton • CA • 90220  
Tel: 310.898.1100 • Fax: 310.898.1111**



belkin.com  
pureav.com

Belkin Corporation  
501 West Walnut Street  
Compton • CA • 90220 • USA  
Tel: 310.898.1100  
Fax: 310.898.1111

Belkin Components, Ltd.  
Express Business Park • Shipton Way  
Rushden • NN10 6GL • United Kingdom  
Tel: +44 (0) 1933 35 2000  
Fax: +44 (0) 1933 31 2000

Belkin Components B.V.  
Starparc Building • Boeing Avenue 333  
1119 PH Schiphol-Rijk • The Netherlands  
Tel: +31 (0) 20 654 7300  
Fax: +31 (0) 20 654 7349

Belkin Ltd.  
7 Bowen Crescent • West Gosford  
NSW 2250 • Australia  
Tel: +61 (0) 2 4372 8600  
Fax: +61 (0) 2 4372 8603

© 2004 Belkin Corporation. All rights reserved. All trade names are registered trademarks of respective manufacturers listed.

P74522

## Free Manuals Download Website

<http://myh66.com>

<http://usermanuals.us>

<http://www.somanuals.com>

<http://www.4manuals.cc>

<http://www.manual-lib.com>

<http://www.404manual.com>

<http://www.luxmanual.com>

<http://aubethermostatmanual.com>

Golf course search by state

<http://golfingnear.com>

Email search by domain

<http://emailbydomain.com>

Auto manuals search

<http://auto.somanuals.com>

TV manuals search

<http://tv.somanuals.com>