

A large, stylized watermark of the word "COBY" is positioned vertically on the left side of the page. The letters are outlined and filled with a light gray color, set against a dark gray background that also features a halftone dot pattern.

COBY

DVD-925

DVD Home Theater Center Operating Instruction Manual

Unique laser head over-current protection system, doubles the service life of the equipment
Special DVD deck with anti-shock design, augmented error correction, and better stability
Full DVD operation system providing powerful functions and user friendly operation
Integrated DVD and built-in 5.1CH Hi-Fi power amplifier

Built-in Dolby AC-3 decoding.
Providing premium home theater enjoyment.

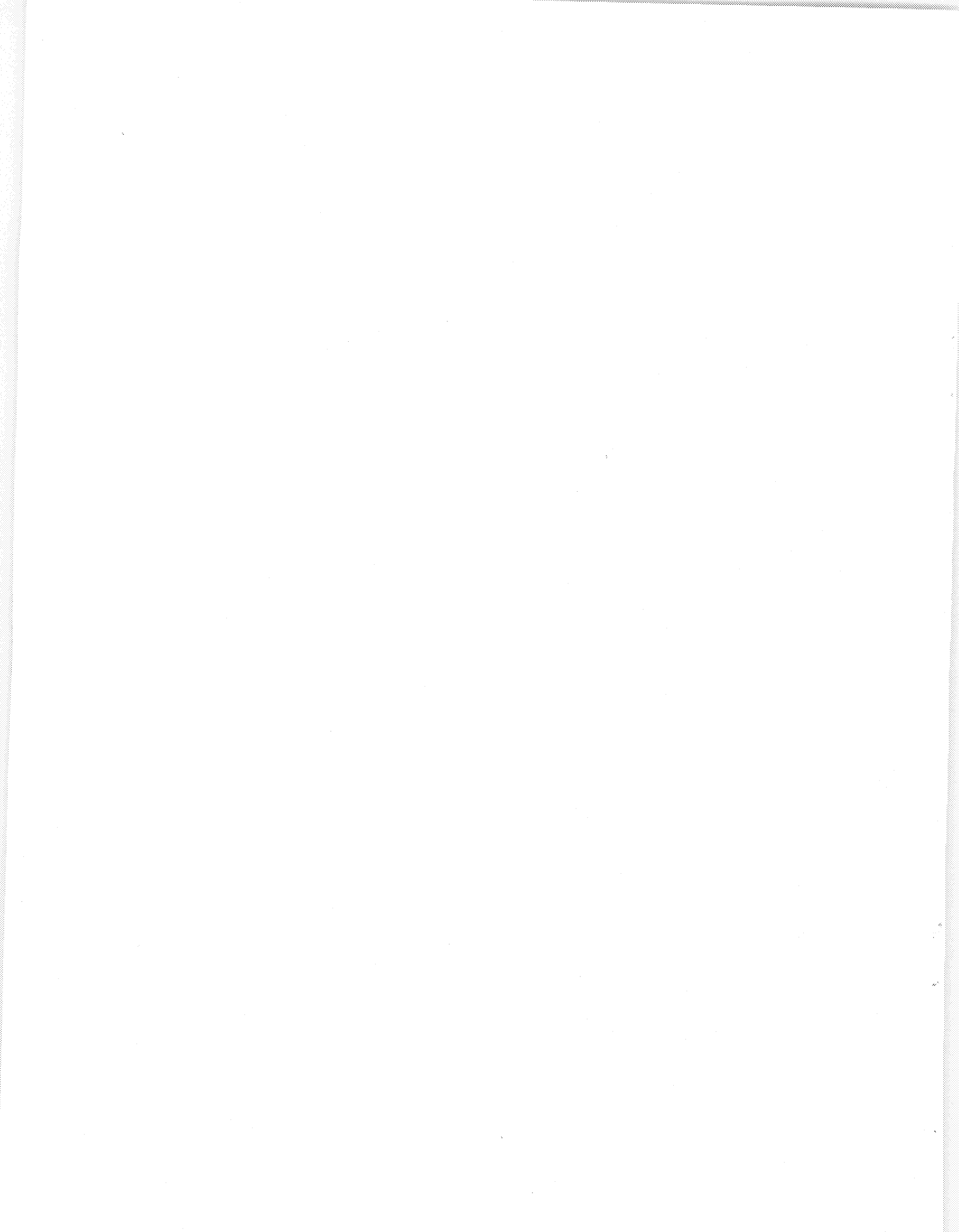

PRECAUTIONS

A lightning bolt with an arrowhead symbol within an equilateral triangle is intended to alert the user to the presence of uninsulated "dangerous voltage" within the product's enclosure that may be of sufficient magnitude to constitute a risk of electric shock to persons.



The exclamation point within an equilateral triangle is intended to alert the user to the presence of important operating and maintenance (servicing) instructions in the literature accompanying the appliance.



WARNING: TO AVOID THE DANGER OF FIRE OR ELECTRIC SHOCK, DO NOT EXPOSE THIS APPLIANCE TO RAIN OR MOISTURE. NEVER OPEN THE CABINET, AS DANGEROUS HIGH VOLTAGES ARE CONTAINED INSIDE. ONLY A QUALIFIED SERVICE TECHNICIAN SHOULD ATTEMPT TO OPEN THE CABINET.

CAUTION: TO PREVENT ELECTRIC SHOCK, MATCH WIDE BLADE OF PLUG TO WIDE SLOT, AND FULLY INSERT INTO ELECTRICAL SOCKET.

CAUTION: This DVD receiver unit employs a laser system. To prevent direct exposure to the laser beam, do not open the enclosure. Visible laser radiation is present when enclosure is open. **DO NOT STARE INTO BEAM.** Additionally, the use of controls or adjustments or performance of procedures other than those specified herein may result in hazardous radiation exposure.

To ensure proper use of this product, please read this owner's manual carefully and retain for future reference. Should the unit require maintenance, contact an authorized service centre.

PROTECT YOURSELF!

Record the model and serial numbers for this unit while it is easy to see them. These numbers are located on the back of the unit's cabinet. Retain this information for future reference.

Model Number DVD-925

Serial No. _____

Retain this information for future reference.

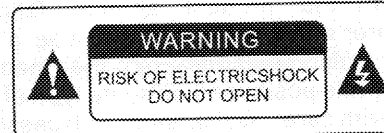

CAUTION

RISK OF ELECTRIC SHOCK DO NOT OPEN

CAUTION: TO REDUCE THE RISK OF ELECTRIC SHOCK, DO NOT REMOVE COVER (OR BACK). THERE IS NO USER SERVICEABLE PART INSIDE. REFER SERVICING TO QUALIFIED SERVICE PERSONNEL.

IMPORTANT SAFETY INFORMATION

CAUTION: It is important that you read and follow all the instructions in this booklet and any markings on the unit itself. Retain this booklet for future reference.

Accessories--- Never place this product on an unstable platform, stand, cart, wall mount, shelf, or table. The product may fall, causing serious personal injury to persons and pets, as well as seriously damaging the product. Use only with a stable platform, stand, cart, wall mount, shelf, or table that has been recommended by sold with the product. Any mounting of the product should follow the manufacturer's instructions, and use a mounting accessory recommended by the manufacturer. This unit while positioned on some type of cart must be moved with care. Quick stops, excessive force, and uneven surfaces may cause the product and cart combination to overturn.

Attachments--- Use only approved attachment as they may cause hazards.

Cleaning--- Always unplug this unit from the wall electrical outlet before cleaning. Do not use liquid or aerosol cleaners; use a damp cloth for cleaning.

Lightning--- For added product protection during a lightning storm or when it is left unattended and unused for long periods of time, unplug it from the wall outlet and/or disconnect the antenna or cable system. This will prevent damage to the product due to lightning and power-line surges.

Object and Liquid Entry--- Never push objects of any kind into this product through openings as they may touch dangerous voltage points or short-out parts that could result in a fire or electric shock. Never spill liquid of any kind on or into the product.

Outdoor Antenna Grounding--- If an outside antenna or cable system is connected to the product, be sure the antenna or cable system is grounded so as to provide protection against stvoltage surges and built-up static charges.

Overloading--- Do not overload wall outlets, extension cords, or integral convenience receptacles, as this may result in a fire or electric shock.

Power Cord Protection --- Power supply cords should be routed so that they are not likely to be walked on or pinched by items placed upon or against them, paying particular attention to cords at plugs, convenience receptacles, and the point where they exit from the product.

Power Lines--- An outside antenna system should not be located in the vicinity of overhead power lines or other electric light or power circuits, or where it can fall into such power lines or circuits. When installing an outside antenna system, extreme care should be taken to keep from touching such power lines or circuits as contact with them might be fatal.

Power Sources--- This product should be operated only from the type of power source indicated on the marking label. If you are not sure of the type of power supply to your home, consult your product dealer or local power company. For products intended to operate from battery power or other sources, refer to the operating instructions. This DVD home theater operates on AC 120V~60Hz. Do not turn off unit immediately after turning on; wait at least 10 seconds.

Replacement Parts--- If replacement parts are required, be sure the service technician has used approved replacement parts or have the same characteristics as the original part. Unauthorized substitutions may result in fire, electric shock, or other hazards.

Safety Check--- Upon completion of any service or repairs to this product, ask the service technician to perform safety checks to determine that the product is in proper operating condition.

Servicing--- Do not attempt to service this product yourself as opening or removing covers may expose you to dangerous voltage or other hazards. Refer all servicing to qualified service personnel.

TV System--- This unit is compatible with television sets featuring either the NTSC or PAL color system.

Ventilation--- Slots and openings in the cabinet are provided for ventilation and to ensure reliable operation and protection from overheating. These openings should never be blocked by placing the product on a bed, sofa, rug, or other similar surface. This product should not be placed in a built-in installation such as a bookcase or rack unless proper ventilation is provided. Never place this product near a heat source, such as heat registers, stoves, radiators, or any other product that produces heat.

Water and Moisture--- Do not use this product near sources of water and moisture, such as bath tub, wash bowl, kitchen sink, or wash machine; in a wet, damp basement; or near a swimming pool or similar locations. If moisture condensation occurs, remove any disc, connect the unit's power cord to a wall outlet, turn the unit on, and leave it on for two to three hours. By then, the unit will have warmed up and evaporated any moisture.

TABLE OF CONTENTS

| | |
|---|----|
| Precaution | 1 |
| Safety Information | 2 |
| Table of Contents | 3 |
| About Your DVD Player | 4 |
| Best Location..... | 4 |
| To Obtain a Clear Picture..... | 4 |
| Playable Discs..... | 4 |
| Digital Audio Output | 4 |
| Laser-Head Over-Current Protection System | 4 |
| Use of Disc | 5 |
| Handling..... | 5 |
| Cleaning..... | 5 |
| Storing..... | 5 |
| Front and Back panels | 6 |
| Front Panel..... | 6 |
| Back Panel..... | 6 |
| Remote Control..... | 7 |
| Operating the remote control..... | 8 |
| Connecting Devices..... | 9 |
| Speakers..... | 10 |
| Arrangement of speakers..... | 10 |
| Connecting speakers..... | 11 |
| Connecting antenna..... | 12 |
| Connecting power supply..... | 13 |
| Playing the radio..... | 14 |
| Basic DVD operation..... | 15 |
| Functions..... | 16 |

| | |
|--------------------------------|----|
| System Setup..... | 19 |
| Language Setup..... | 19 |
| Video Setup | 21 |
| Audio Setup | 22 |
| More Audio Setup..... | 23 |
| Rating Setup..... | 24 |
| MP3 function..... | 25 |
| JPEG files..... | 26 |
| Trouble shooting..... | 26 |
| Technical specifications | 27 |
| Warranty..... | 28 |

ABOUT YOUR DVD PLAYER

The following will help you get the most enjoyment from your DVD receiver system.

BEST LOCATION

The unit should be placed on a firm, flat surface, away from VCRs, stereos, radios, or large speakers, as the magnetic flux from these devices may cause distortion in the sound and a poor picture. If placed in a cabinet, be sure there is at least 1" of free space completely around the unit for proper ventilation.

TO OBTAIN A CLEAR PICTURE

A DVD receiver is a precision device. If the optical pick-up lens and disc drive parts become dirty or worn down, picture quality will become poor. Store DVD player in a clean dust free environment.

PLAYABLE DISCS

This DVD receiver system will play the following types of discs: DVD, MP3, CD, CD-R, and CD-RW with super-error correction ability. It is also capable of displaying picture CDs and digital photo albums. It supports eight languages, up to 32 subtitles, and multi-angle viewing. It features easy setup and operation with on-screen menus. It has full function CPU up grade able capability.

DIGITAL AUDIO

The unit's coaxial output capability enables you to connect an external six-channel AV amplifier and processor with built-in Dolby Digital code with just one cord. This enables you to conveniently enjoy different DVD, CD, and Mp3 discs.

ANALOG AUDIO OUTPUT

Speaker system plug-and-play convenience through the built-in six-channel power amplifier eliminates the use of an external power amplifier.

LASER-HEAD OVER-CURRENT PROTECTION SYSTEM

To extend the service life of the laser head, the unit includes a unique laser-head over-current protection system, ensuring a constant laser current.

USE OF DISCS

This page contains valuable information regarding the handling, cleaning, and storage of discs played in this unit.

Handling

- Do not touch the playback side of the disc.
- Do not attach paper or tape to discs.
- Do not stick or write anything on the surface. Protect against fingerprints.
- Always hold a disc by the center and edge portions.

Cleaning

- Fingerprints and dirt on the disc may cause picture and/or sound deterioration. Wipe the disc from the center outward with a soft cloth. Always keep the disc clean.
- If you can not wipe the dirt off, lightly use a slightly moistened soft cloth and finish with a dry cloth.
- Do not use any type of solvent such as: Paint thinner, benzene, commercially available cleaners or anti-static spray for vinyl LPs.

Storing

- Do not store discs in places subject to direct sunlight or near heat sources.
- Do not store discs in places subject to moisture and dust.
- Store discs vertically in a case. Stacking or placing objects on discs outside of their cases may cause warping.

NOTE: We are not responsible for damage that may occur to any disc that is operated in this unit or not handled, cleaned, or stored as suggested above.

FRONT AND BACK PANELS

Front Panel Functions

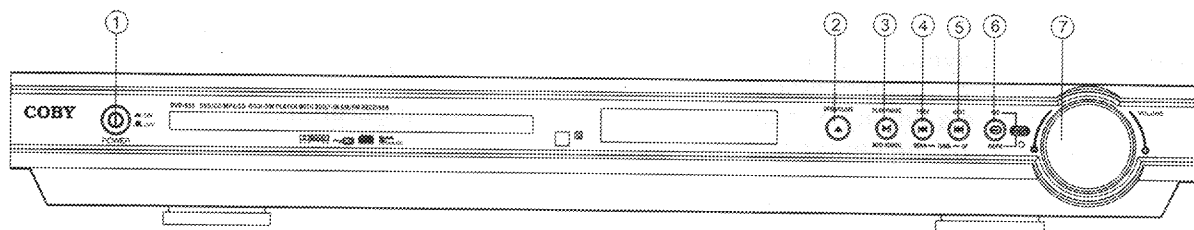

1. POWER

Before plugging the power cord into the AC outlet, check to make sure all of the connections have been properly completed. When they have been, carefully plug power cord into outlet.

Press the POWER button on the front panel to power the unit.

When the unit is initially powered, a brief surge of electricity may cause interference with other electronic equipment on the same circuit. If this occurs, connect the unit to an outlet on a different circuit.

2. ▲ OPEN/CLOSE

Use this button to open and close the disc tray while in DVD mode.

3. ▶⏸️ PLAY/PAUSE /AUTO

Use this button to begin play/pause function while in DVD mode.

When in the tuner mode, you may press this button for automatic search.

4. ⏮️ PREVIOUS/DOWN

While in the DVD status, you may press this button for previous track.

While in the tuner mode, you may press this button for radio down search.

5. ⏭️ NEXT/UP

While in the DVD status, you may press this button for next track.

While in the tuner mode, you may press this button for radio up search.

6. INPUT SIGNAL SOURCE

Use this button to select the proper input signal source. (Note: The selected input will correspond to the selected input terminal on the rear panel.)

7. VOLUME

Use this button to control the unit's volume. It controls all six channels simultaneously.

6

Back Panel Functions

1. ANTENNA

Use to connect the provided indoor FM and AM loop antennas.

2. AUX IN

Use to connect input for both auxiliary 1 and 2 music sources.

3. AUDIO OUT

Use to connect both the right and left channel line outputs as well as subwoofer output.

4. VIDEO OUTPUT

5. S-VIDEO OUTPUT

6. REAR

Use to connect the four terminals of the left and right surround sound speakers.

7. FRONT/MAIN

Use to connect the four terminals of the left and right front or main speakers.

8. CENTER/SUBWOOFER

Use to connect the four terminals of the center and subwoofer speakers.

9. COAXIAL DIGITAL AUDIO OUTPUT

10. 120V-60Hz

This unit comes with an AC power cord. Be sure its prongs are dry before plugging it into an electrical outlet. Take caution not to overextend the cord or walk on it.

11. Component Video Output for Progressive Scan

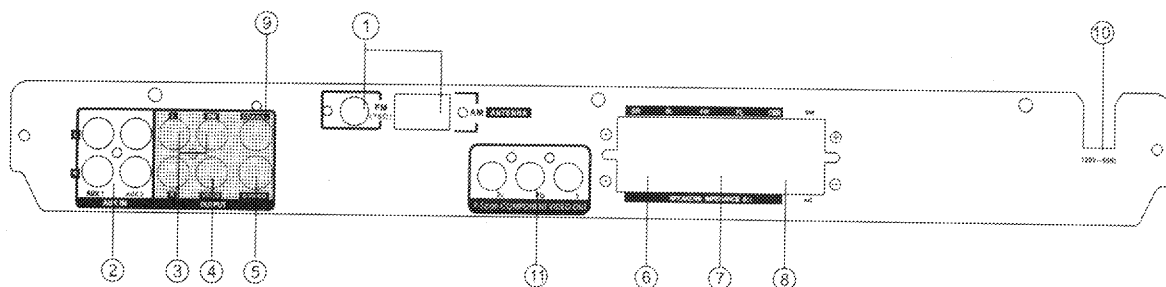

REMOTE CONTROLLER

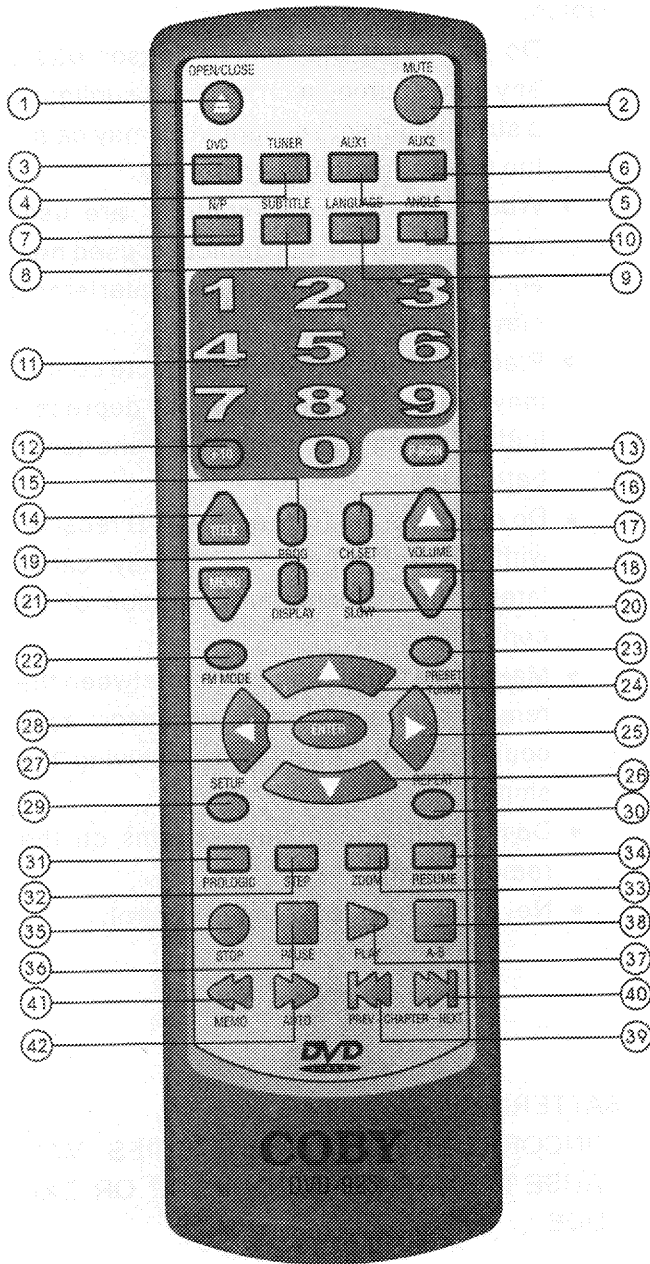

- ① OPEN/CLOSE
- ② MUTE
- ③ DVD SELECTOR
- ④ AM/FM TUNER
- ⑤ AUX1 SELECTOR
- ⑥ AUX2 SELECTOR
- ⑦ N/P TV MODE SELECTOR
- ⑧ SUBTITLE
- ⑨ LANGUAGE
- ⑩ ANGLE
- ⑪ 0-9 NUMBER KEYS
- ⑫ +10
- ⑬ P-SCAN
- ⑭ TITLE
- ⑮ PROG PROGRAM
- ⑯ CHANNEL SELECTOR
- ⑰ VOLUME INCREASE
- ⑱ VOLUME DECREASE
- ⑲ SCREEN DISPLAY
- ⑳ SLOW MOTION
- ㉑ MENU
- ㉒ FM STEREO / MONO MODE
- ㉓ PRESET/TUNING
- ㉔ SCROLL UP
- ㉕ SCROLL RIGHT
- ㉖ SCROLL DOWN
- ㉗ SCROLL LEFT
- ㉘ ENTER
- ㉙ SETUP
- ㉚ REPEAT
- ㉛ PRO LOGIC
- ㉜ STEP
- ㉝ ZOOM
- ㉞ RESUME PLAY
- ㉟ STOP
- ㊱ PAUSE
- ㊲ PLAY
- ㊳ A-B REPEAT
- ㊴ DOWN (search down for radio stations/ previous track)
- ㊵ UP (search up for radio stations/next track)
- ㊶ MEMO (memory/rewind skip)
- ㊷ AUTO (automatic search/forward skip)

OPERATING THE REMOTE CONTROL

Battery Installation

1. Push down and out on the battery Compartment cover to remove it.
2. Insert the two "AAA" batteries into the battery compartment of the remote control, making sure the + and - signs on the batteries and inside the battery compartment match up.
3. Replace the battery compartment cover.

Notes:

- Do not mix batteries from different manufacturers, nor old ones with new.
- If the remote control will not be used for an extended period of time, remove the batteries to prevent damage-causing corrosion.
- Remove dead batteries immediately to prevent damage-causing corrosion.
- If battery leakage occurs, wipe the battery liquid from the battery compartment, then replace both batteries.
- Always replace both batteries at the same time, using new, fully charged batteries.
- Life expectancy of batteries may vary depending on amount of use.

Using the Remote Control

Point the remote control at the remote sensor on the DVD receiver. When the signal is received from the remote control, the unit will function accordingly. The remote will operate to approximately 16' from the remote sensor at an angle of around 30° each direction.

Notes:

- Do not direct the remote sensor toward any light source, such as direct sunlight or a strong fluorescent light, as it may cause the unit to not operate correctly.
- When other remote controls are used nearby or when the remote is used near equipment using infrared rays, interference may occur.
- Placing an object on the remote control may cause it to inadvertently depress a button, changing a function and shortening battery life.
- Do not glaze the front of the DVD receiver with colored glass, as it may cause interference with normal operation of the controller.
- Make sure there is no barrier between the remote control and remote sensor, as it could prevent the unit from receiving the signal.
- Do not spill water or put wet items on the remote control.
- Never disassemble remote control.



BATTERIES

INCORRECT USE OF BATTERIES MAY CAUSE THEM TO LEAK, CORRODE OR EXPLODE.

CONNECTING DEVICES

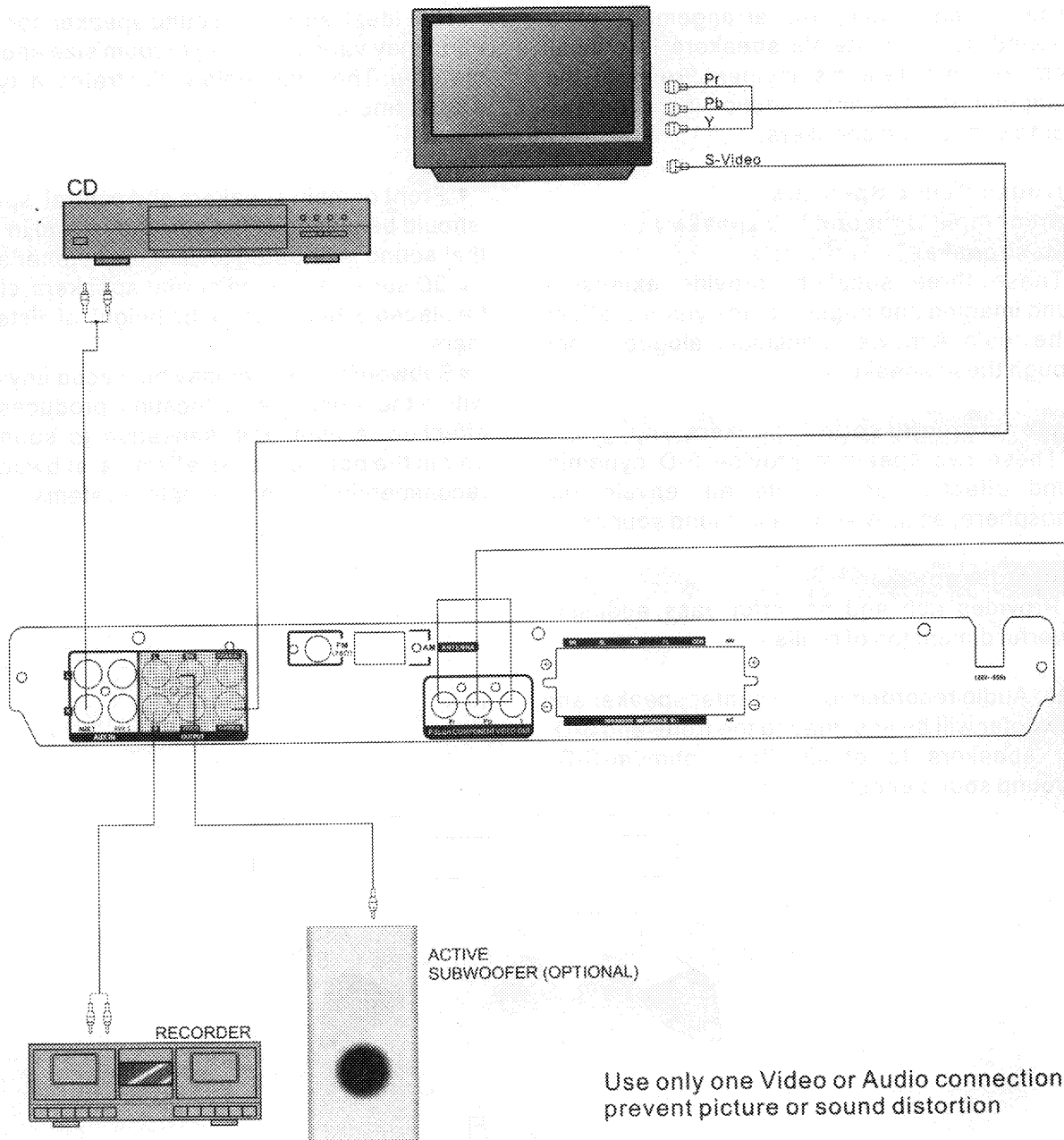

9

Use only one Video or Audio connections to prevent picture or sound distortion

- Connection terminals for this DVD receiver are found on the rear panel. Read carefully and follow the manufacturers' instructions of any video and audio device being connected to this unit.
- Do not connect the power until all connections have been properly completed.
- Red terminal (marked R) is for connecting the right channel. The white terminal (marked L) is for connecting the left channel. The yellow terminal is for video connection. Make sure all connections are securely made. Improper connections may cause noise, poor performance, or cause damage to the equipment.
- Do not tie the AV cord with any other cords, such as the power cord or speaker wires, as it may result in poor picture and/or sound quality.

SPEAKERS

The configuration and arrangement of a surround sound system's speakers is critical. For maximum listening enjoyment, refer to the Arrangement of Speakers section in this manual prior to connecting speakers.

Surround Sound Speakers

Front or main right and left speakers; center speaker

- These three speakers provide extensive sound imaging and augment the dynamic effect of the audio. A movie's principal dialogue comes through these speakers.

Rear or surround sound speakers

- These two speakers provide 3-D dynamic sound effects, and create an enveloping atmosphere, as they add background sounds.

Subwoofer speaker

- Provides rich and powerful bass, adding a powerful dimension of realism.

Note: Audio recorded for the center speaker and subwoofer will be assigned to the front and 3-D rear speakers to obtain the optimum 3-D surround sound effect.

ARRANGEMENT OF SPEAKERS

The ideal surround sound speaker configuration may vary according to room size and wall material. The figure below illustrates a typical arrangement.

Hints:

- Front or main speakers and central speaker should be placed at the same level and in a way that sound is oriented toward the listener's ears.
- 3D surround sound or rear speakers should be placed 3' higher than the height of listener's ears.
- Subwoofer speaker may be placed anywhere within the room, as its location produces little effect on a listener's sensation to sound. To obtain the optimum bass effect, a subwoofer is recommended in home theater systems.

10

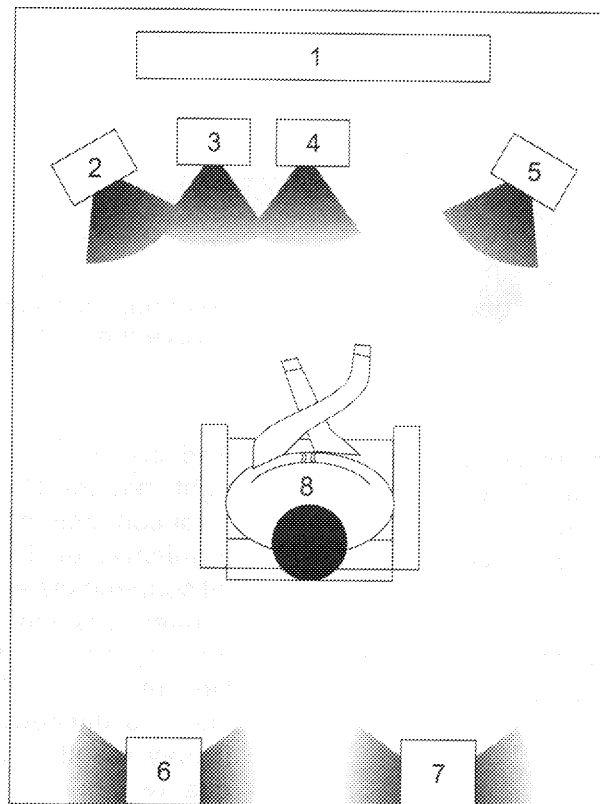

1. TV set or screen
2. Front or main left speaker
3. Subwoofer

6. 3-D surround sound left speaker
7. 3-D surround sound right speaker
8. Viewer's location

CONNECTING SPEAKERS

This well-designed DVD receiver provides optimum sound quality when the speakers used are within the range of their rated impedance.

Important

- The minimum impedance of the five speaker terminals is 6 ohm; for the subwoofer, it is 8 ohm.
- If you want to use only one speaker or listen to monophonic music, do not parallel connect individual speakers to the left and right channel terminals. See the figure on the left below.

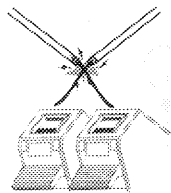
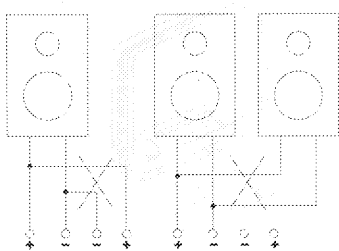

Connecting Speaker Cables

1. Peel off approximately 1/2" of cable insulation
2. Tighten the wire end (#2 below)
3. Open cable terminal by pressing back on tab
4. Insert wire end into terminal
5. Release tab; make sure wire is in terminal and secure

Note: To prevent damage to the circuit, care should be taken to prevent short circuiting from occurring at the positive and negative poles of the speaker cord.

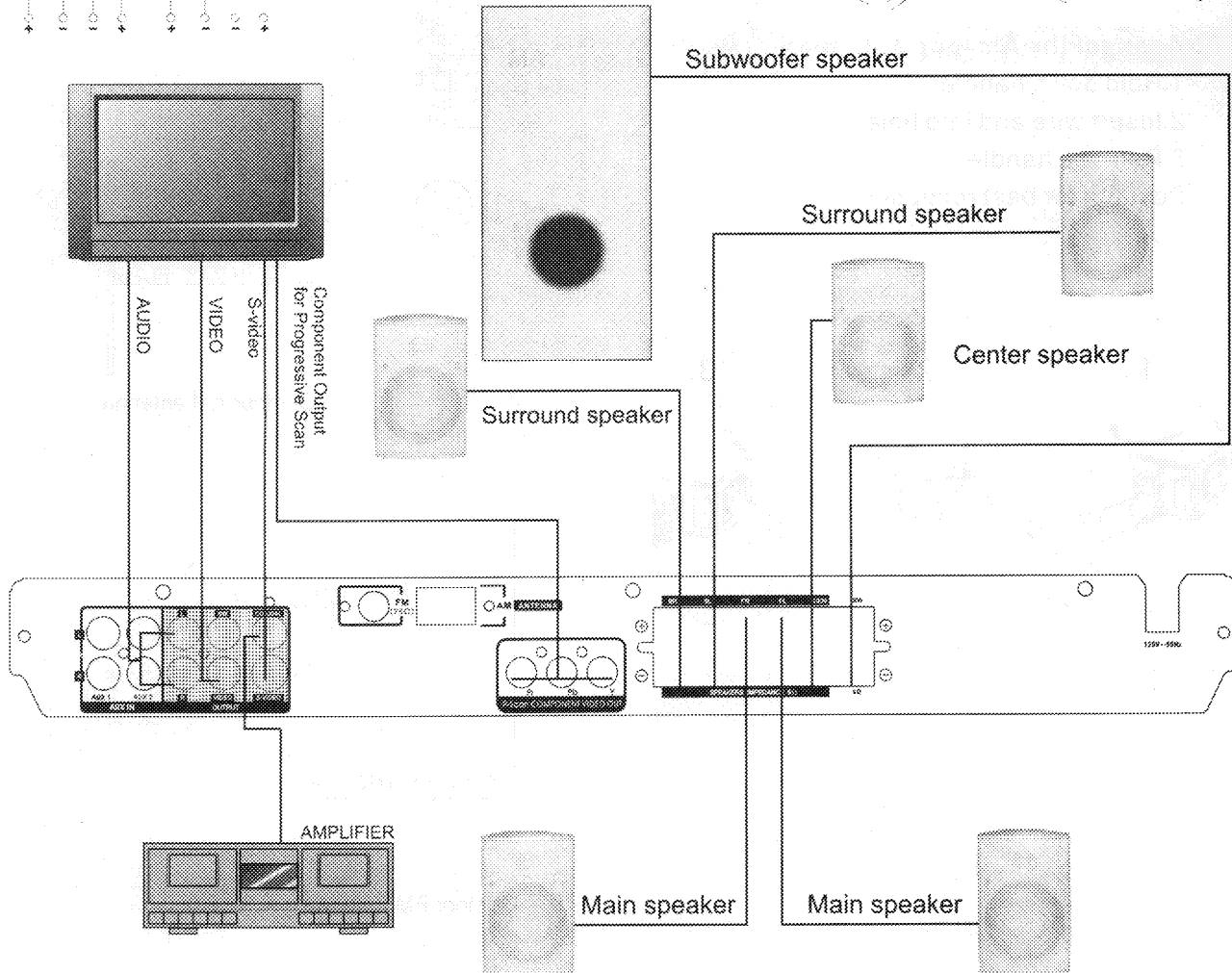
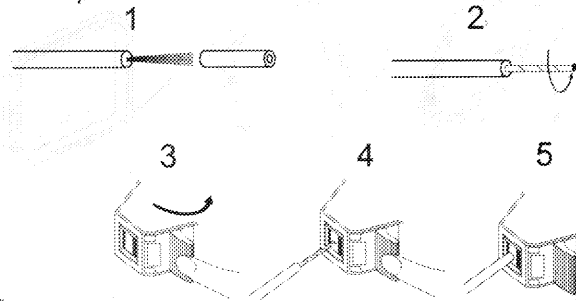

- Use only one Video or Audio connections to prevent picture or sound distortion

CONNECTING ANTENNA

Radio signals may be difficult to receive in some buildings and under certain conditions. The provided antennas will help in their reception. They are intended for indoor use only.

AM Loop Antenna

The placement of the AM loop antenna should be in a direction that provides the clearest reception. Keep as far as possible from DVD receiver, TV set, and speaker and power cords. If reception remains poor, an outdoor antenna may be necessary.

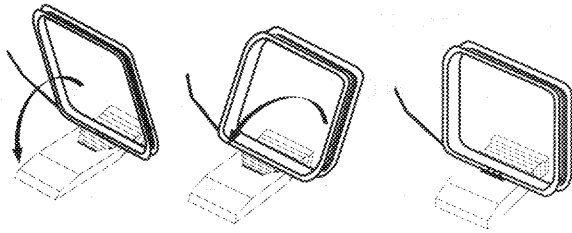

To connect the AM loop antenna:

1. Hold down handle
 2. Insert wire end into hole
 3. Release handle
- Position for best reception

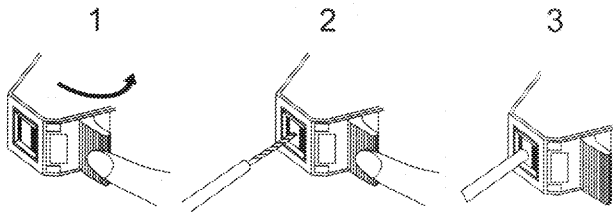

FM Indoor Antenna

The FM antenna should be fully extended and in a direction that provides the clearest signal. Secure the antenna ends in a location where distortion is a minimum. If reception remains poor, an outdoor antenna may be necessary.

To connect the FM antenna:

1. Open cable terminal by pressing back on tab
2. Insert wire end
3. Release tab; make sure wire is in terminal securely

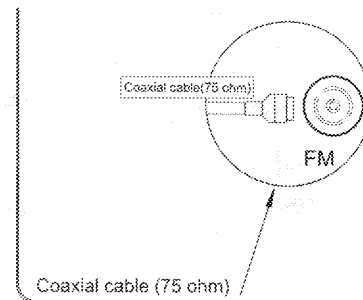
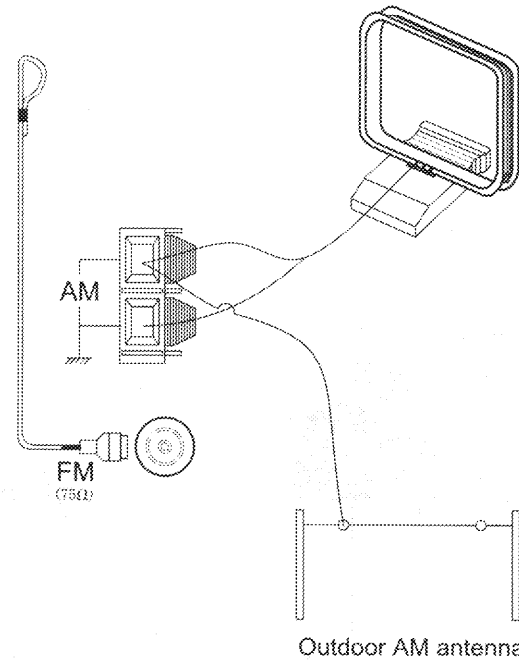

Outdoor FM antenna

CONNECTING POWER SUPPLY

POWER

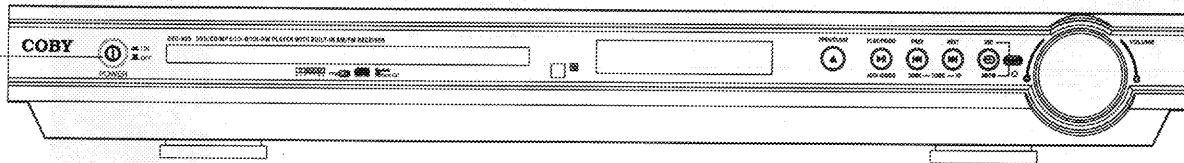

Before plugging the power cord into the AC outlet, check to make sure all of the connections have been properly completed. When they have been, carefully plug power cord into outlet.

Press the POWER button on the front panel to power the unit. The display panel will light.

When the unit is initially powered, a brief surge of electricity may cause interference with other electronic equipment on the same circuit. If this occurs, connect the unit to an outlet on a different circuit.

13

BASIC OPERATION

Selecting Sound Source

1. Press any function button (DVD, AM/FM, AUX1, AUX2) to select the desired sound source. The appropriate symbol will appear in the display.
2. When the AM/FM tuner button is pressed, the last station listened to will play.

Note: The desired program source will not play unless it and the selected signal button coincide with the active program source signal input.

Volume Control

The volume may be adjusted by either turning the large volume knob on the front panel or using the appropriate volume button on the remote control.

Mute

Pressing the MUTE button temporarily mutes every speaker. To resume audio, press MUTE button again.

PLAYING THE RADIO

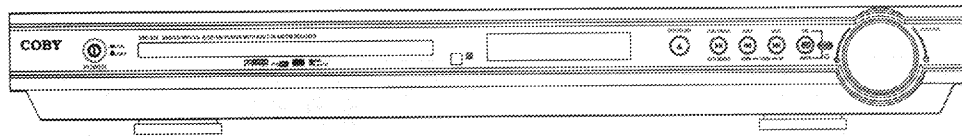

Tuner button

Number button

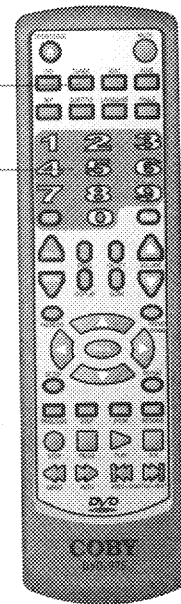

Positioning

1. Press TUNER button to select desired wave band (AM or FM).
2. Press UP or DOWN button to find a station. The frequency will change with each press. When a station's signal is received, it will appear in the display.
3. To lock on to a station quickly, hold the UP or DOWN button for two seconds. The unit will start automatic tuning. When a station is found, automatic tuning stops.
4. To add a station to memory, press the MEMO button. The memory storage number will blink for four seconds in the display. Press MEMO again to store the station.

Memory number

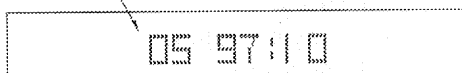

Wave band Station frequency

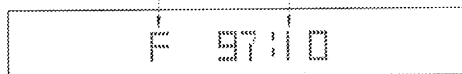

5. To reduce noise when an FM-stereo program has been received, press the FM button. The word STEREO will disappear from the display. The program is now heard in monographic form, reducing the noise. To resume stereo play, press the FM button again.

Automatic Tuning

This unit will store up to 50 individual AM or 50 individual FM radio stations in its memory.

1. Press the AUTO button. The word AUTO will appear in the display and the automatic tuning mode is activated.
2. Stations will be stored in ascending order until 50 stations of that particular wave band have been saved. When a station is stored, the memory storage number, as well as the station's frequency, will flash for four seconds in the display.
3. When the total number of stations reaches 50, in a particular wave's (AM or FM) memory, no further station in that wave band will be saved.

To Play Preset Stations

1. Press the TUNER button to select the desired wave band.
2. Press the PRE/TUN button.
3. Press any of the number buttons to select the desired station's memory number. For example, to play the station at memory #5, simply press the 5 button; for memory #17, press the 1 button followed by the 7 button.
4. Stations in the memory function may also be accessed by pressing the UP or DOWN button.

BASIC DVD OPERATION

Once the unit is connected to a television set and any other accessory equipment, you are ready to enjoy the excitement of DVD videos or your favorite CDs and MP3 files.

To play a DVD video disc:

Turn on the TV and select the A/V mode. If the set features an YUV connection, be sure the YUV mode is selected from the TV menu. Turn on amplifier, if connected. Select AC-3 or DVD mode.

To play an audio disc:

Turn on the audio system and choose the input source that is connected to the DVD player. Set the SPDIF OUTPUT to SPDIF OFF from the SETUP MENU display if you don't have the proper equipment for Dolby Digital surround sound.

1. Press the POWER key on front panel. DISC LOADING appears on screen.

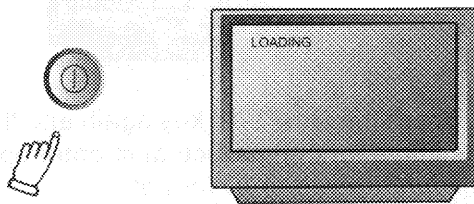

If there is no disc, NO DISC shown on screen:

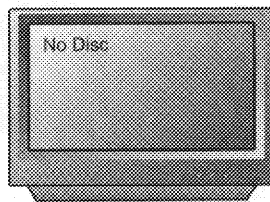

2. Press the OPEN/CLOSE key. The disc tray will open.

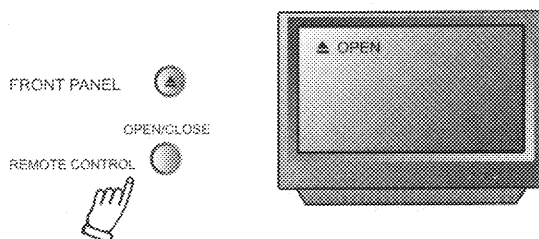

3. Place the disc on the disc tray. Be sure play side is face down on the tray.

4. Press OPEN/CLOSE key to close tray. The disc tray will close. The disc type will appear in the upper-left-hand corner of the screen.

Once it has read the disc, the unit automatically will begin playback. When playing a DVD, the DVD title or menu will appear. CD tracks are played in sequence.

Note:

- It is possible to damage a disc if it is not placed correctly on the guides in the disc tray. This may also cause the DVD player to malfunction. Do not force or place anything other than a 5" DVD or CD onto the disc tray.
- Never move the DVD player during playback, as this may cause damage to the disc as well as the player. To open and close the disc tray, only use the OPEN/CLOSE key found on both the remote control and on the unit's front panel.

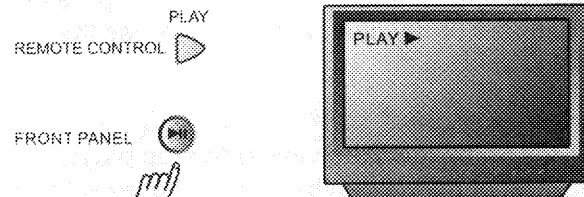

Press PAUSE key:

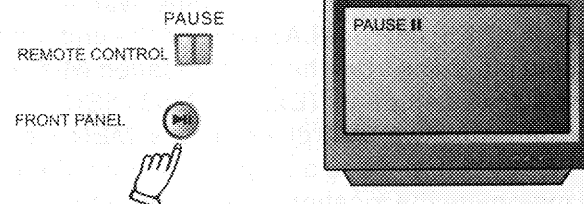

5. PREV/NEXT playback

Press |◀◀|key or |▶▶|key, play previous or next track. To resume normal playback, press PLAY key.

Press PREV key:

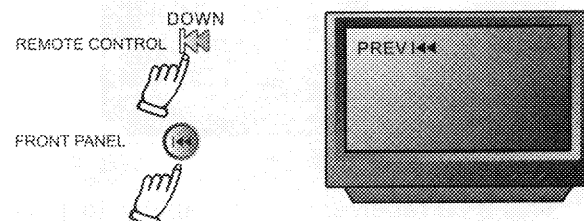

Press NEXT key:

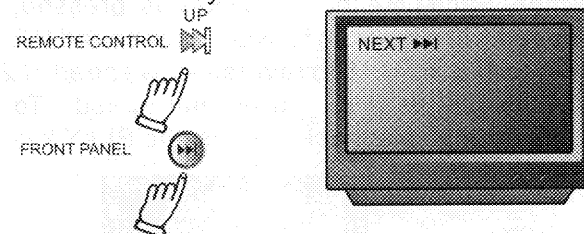

6. Fast Forward/Reverse Playback

The unit features both fast forward and fast reverse playback. Either mode will speed up: 2x 4x 8x 16x

BASIC DVD OPERATION

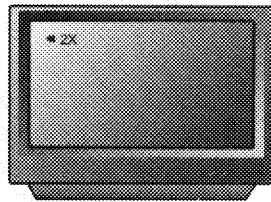
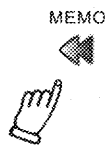
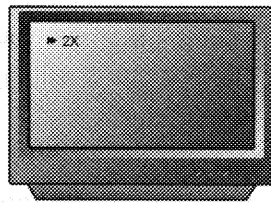

To activate either function, simply press the ► key or ◀ key on the remote control. The speed changes each time the key is pressed. To resume normal playback, when press the PLAY key.

Memory Playback

This unit allows the viewer to stop playback, then later continue playback from that exact disc location. Press the STOP key to halt playback. The unit then will memorize the location where playback was stopped. To resume watching, press the RESUME or PLAY key and the unit will resume playback from the exact location where playback was stopped. (Exclude Mp3 DISC)

When you play DVD discs, press MENU or TITLE key return menu and title, the unit then will memorize the location, To resume watching press the RESUME key and the unit will resume playback from the exact location.

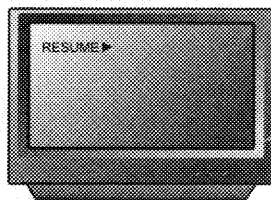

Slow Motion

This DVD receiver has the ability to play discs in slow motion in either forward or reverse direction. Each time the SLOW key is pressed, the speed will slow from forward slow speed 1/2, to 1/4, to 1/8, to 1/16 to reverse slow speed 1/2, to 1/4, to 1/8, to 1/16, to normal speed. To resume normal playback, press the PLAY key.

SLOW

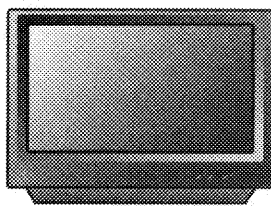

FUNCTIONS

Screen Display

While a disc is playing, the status of various functions may be checked, such as the title, track number, and several time categories.

1. Press the DISPLAY key once and the title appears along with the chapter and how much time has played.

DISPLAY

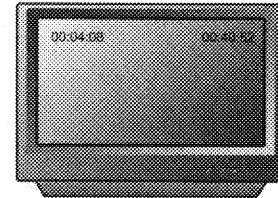

2. Press the DISPLAY key again and the remaining time for that particular title appears while soundtrack is CD format.

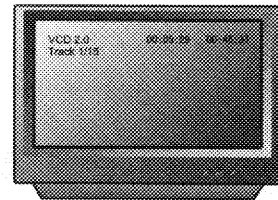

3. Press the DISPLAY key again and the total elapsed time for that particular chapter appears while soundtrack is DVD format.

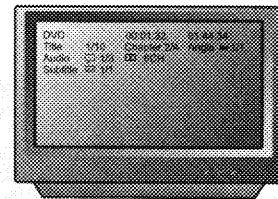

4. Press the DISPLAY key again and the display turns off.

FUNCTIONS

N/P

This DVD receiver supports video output of various systems, including auto, NTSC, and PAL. The picture will blink and become colourless when the wrong system is selected. If this occurs, press the N/P key on the remote control, then select the correct system (NTSC for North America, PAL for Europe). For more information on output format, refer to the TV set's manufacturer's instructions.

Subtitles

The unit has the capability to display subtitles in any of 32 different languages.

1. Press the SUBTITLE key. The subtitle menu will appear. Select the desired language by pressing the SUBTITLE key.

SUBTITLE

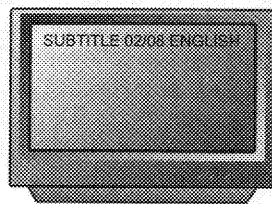
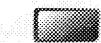

2. To remove the subtitles from view, press the SUBTITLE key until they disappear.

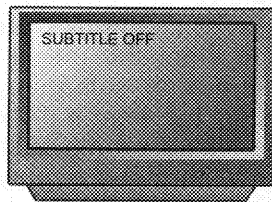

Note: The disc being played must be multi-subtitle encoded.

Camera Angle

The ability to change the camera angle allows viewer to play director and watch a movie from different perspectives.

1. Press the ANGLE key on the remote control. With each press, the camera angle changes.

2. The key may be pressed only when the flashing angle icon appears in the unit's display panel.

ANGLE

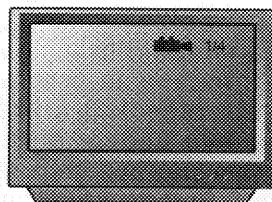

Note: Camera angle may be changed only in discs with multi-angle capability encoded

Language

The unit has the capability to show movies in one of eight languages.

1. Press the LANGUAGE key. The language menu will appear. Select the desired language by pressing the LANGUAGE key.

LANGUAGE



Note: The disc being played must be multi-language encoded.

LOCATING A TITLE

DVD discs are normally divided into titles, which are then sub-divided into chapters. A specific title can be easily found with this unit. Specific titles can be found using either the title menu function, if the DVD disc contains a title menu, or through its unique title number.

Title Menu Function

1. Press the TITLE key. The title menu will appear on the TV screen.

2. Press the appropriate scroll key to select the desired title. A title may also be located by pressing its assigned number with the number buttons.

3. Press the ENTER key. This will start playback from chapter 1 of the selected title.

Note:

Some discs do not respond to this function. If different instructions appear on the TV screen, follow those instructions. The instructions given here describe the basic procedure. Procedures may vary depending on the content of the DVD disc.

Pro Logic selector

When player DVD / CD disc, first press STOP key, then press Pro Logic key to select Pro Logic ON or OFF.

When player CD and at tuner state, press Pro Logic key to select stereo or 5.1 channel output.

FUNCTIONS

MENU: MENU/PBC

With the PBC function on, choosing a song on a CD can only be done when at the main menu. With the PBC function off, song selections can be made by entering the relevant number keys. The menu content of the disc will appear when the MENU button is pressed while a DVD disc is playing.

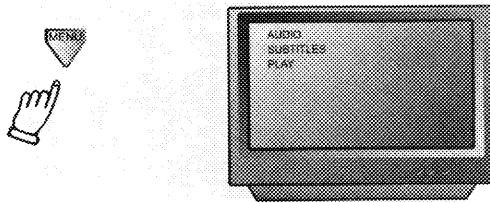

REPEAT

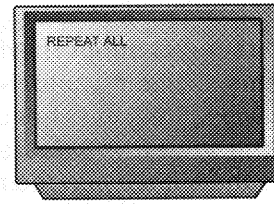

REPEAT

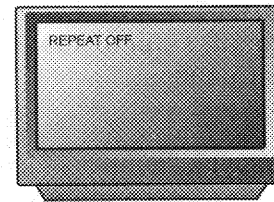

A-B Repeat

The A-B repeat function allows you to re-show sections between two specific points (A and B) on a disc.

1. Press the A-B button while the disc is playing to set point A, the beginning spot.

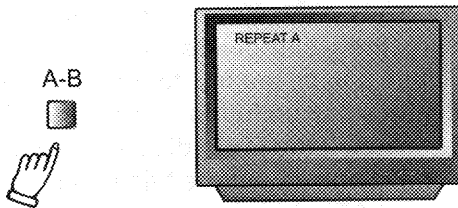

2. Press the A-B button again while the disc is playing to set point B, the ending spot. The section between A and B will replay.

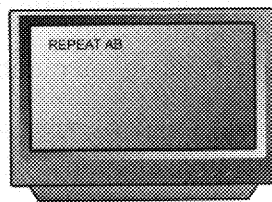

3. Press the A-B button a third time to cancel.

Repeat Play

This DVD receiver allows repeated playback of specific titles, chapters/tracks, or segment. It even allows switching between two items that are being repeated.

1. Select the item to repeat.
2. Press the REPEAT key.

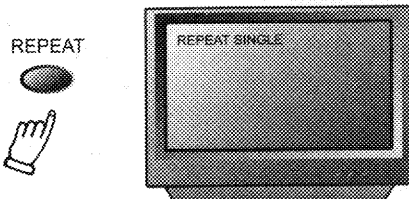

The repeat mode changes each time the REPEAT key is pressed (i.e., from title repeat to chapter repeat, all repeat, to repeat off.)

When playing CD or Mp3, press the REPEAT button to get the following display. Repeat Single, Repeat ALL and Repeat off.

When playing DVD, press REPEAT button to get the following play mode: Repeat Chapter, Repeat Title and Repeat Off.

Zoom

A picture may be enlarged up to four times during either playback or slow motion through the unit's zoom function. Press the ZOOM key once and it enlarges the image 2x; press a second time and the image enlarges 3x; A third pressing enlarges the image 4x. A fourth pressing enlarges the image 1/2x, a fifth pressing the image 1/3x, a sixth pressing the image 1/4x. To return to normal-size playback, press the ZOOM key a seventh time. Enlargement takes place in the center of the picture.

Vol set

When a DVD disc is played, press this key and Volume key to adjust channel level.

Volume and Mute

The volume on this DVD receiver is easily controlled with the remote control by pressing either the VOL ▲ key to raise the volume or the VOL ▼ key to lower it. By pressing the MUTE key, no audio will be heard. To reinstate the audio, press the MUTE key again.

Program

Allows you to program specific tracks in a desired order of play. Press PROG key program menu will appear on the screen, set up the program play in number key. The scroll to the START, Press ENTER key to program play. To exit the Programmed play mode, press the PROG button again.

SYSTEM SETUP

SETUP



In stop mode, press **SETUP**, and the TV screen will display the Setup Menu as follows:



Press ◀ ▶ to change items

Setup Menu

- A. Press **ENTER** to display each submenu
- B. Press **SETUP** to exit the Setup Menu

Language Setup

Select [Language] in the Setup Menu, and press **ENTER** to display the [Language] submenu:

Press ◀ ▶ to select the menu item



- A. Press **ENTER** or ▶ to set
- B. Press ◀ to go back one menu
- C. Press ◀ OR ▶ repeatedly to return to the Setup Menu

Select [OSD Menu], and press **ENTER** or ▶ to display the [OSD Menu] submenu:



Press ◀ ▶ to change your selection

- A. Press **ENTER** to confirm.
- B. Press **SETUP** to exit the Setup Menu.

SYSTEM SETUP

Language Setup

Select [Subtitle], and press ENTER or \square to display the [Subtitle] submenu:



Press \square \square to change your selection
Note: Subtitle languages vary by disc.

- A. Press **ENTER** to confirm
- B. Press **SETUP** to exit the Setup Menu

Select [Audio], and press ENTER or \square to display the [Audio] submenu:



Press \square \square to change your selection
Note: Audio languages vary by disc.

- A. Press **ENTER** to confirm
- B. Press **SETUP** to exit the Setup Menu

Select [DVD Menu], and press ENTER or \square to display the [DVD Menu] submenu:



Press \square \square to change your selection
Note: Menu languages vary by disc.

- A. Press **ENTER** to confirm
- B. Press **SETUP** to exit the Setup Menu

SYSTEM SETUP

Video Setup

Select [Video] in the Setup Menu, and press ENTER to display the [Video] submenu:

Press to select the menu item

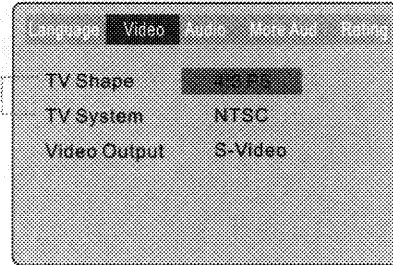

- A. Press ENTER or to set
- B. Press to return to the Setup Menu

Select [TV shape], and press ENTER or to display the [TV shape] submenu:

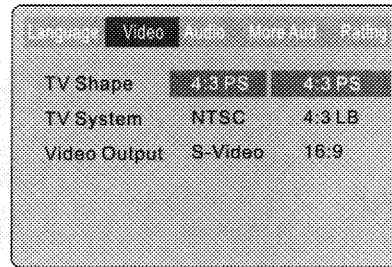

Press to change your selection

- A. Press ENTER to confirm
- B. Press SETUP to exit the Setup Menu

[4:3 PS] -Pan and scan refers to pictures where part of pictures is cut off so it fills the whole screen.

[4:3LB] -Letter Box refers to pictures where black bands appear at the top and bottom.

[16:9] -The picture fills the screen of a wide-screen (16:9) television.

Note: Not all DVDs offer movies in Full Screen format. If not, the disc will override your TV Display setting and the movie will be displayed in Letterbox format.

Select [TV system] and press ENTER or to display the [TV system] submenu:

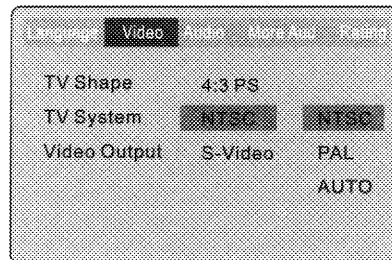

Press to change your selection

- A. Press ENTER to confirm
- B. Press SETUP to exit the Setup Menu.

[NTSC] -Select if you are using NTSC signal system to match your TV set.

[PAL] -Select if you are using PAL signal system to match your TV set.

[AUTO]- Select if you are using AUTO signal system to match your TV set.

NTSC is the broadcast system used in the US and PAL is used in Europe.

SYSTEM SETUP

Select [Video Output], and press ENTER or  to display the [Video Out] submenu:

- A. Press **ENTER** to confirm
- B. Press **SETUP** to exit the Setup Menu



Note: The Composite video and S-video output is always available.

[S-Video] - Select if you connected the DVD player to your TV using the composite Video output.

[YUV] - Select if you connected the DVD player to your TV using the YUV output.

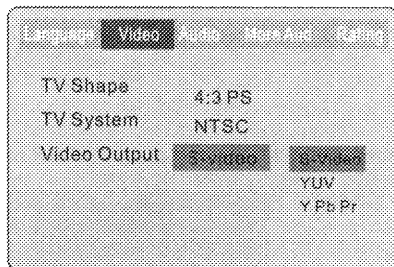
[Y Pb Pr] - Select if you connected the DVD player to your TV using progressive scan.



Press   to change your selection

Audio Setup

The Audio menu allows you to set the analog and digital audio outputs to correspond with the external components you have connected to the player. For example, if you connected the player to a TV using the Stereo Audio jacks, you should set Dolby Digital and others settings to 2 channel to enjoy downmixed stereo audio.

- You can set the audio format for each of the following sources: *Dolby Digital, MP3, CD and Others.*
- *DVD playback must be stopped in order to adjust the Audio setup.*

AC-3 Setting

Follow these steps to set the analog and digital audio formats of outgoing Dolby Digital 5.1 soundtracks:

- A. From Stop mode, press **SETUP**.
- B. Select **Audio** and press **ENTER**.
- C. Select **Dolby D** and press **ENTER**.
- D. Set Analog out to:

6 Channel (default) to output Dolby Digital 5.1 channel audio from the 5.1 channel analog audio outputs; e.g., to a 5.1 channel amplifier.

2 Channel to output downmixed 2 channel stereo from the stereo audio outputs; e.g., to a VCR or TV.

- E. Set Digital out to:

PCM (default) to output 2 channel digital from the optical/coaxial digital audio outputs; e.g., to a Minidisc recorder.

RAW to output the raw 5.1 channel digital bitstream from the optical/coaxial digital audio outputs; e.g., to an external amplifier with a Dolby Digital decoder.

Off to disable Dolby Digital decoder.

- F. Press **SETUP** to save and exit.

- *PCM stands for Pulse Code Modulation, and is the standard 2-channel stereo format used for audio CDs.*

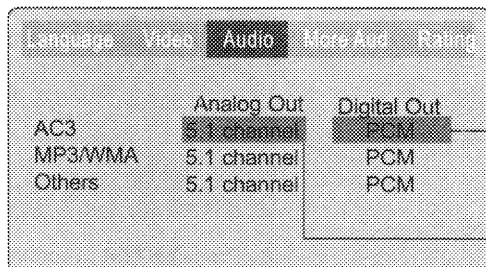

PCM
Raw
Off

5.1 channel
2 channel
Off

SYSTEM SETUP

MP3 Setting

Follow these steps to set the outgoing digital audio format of MP3 tracks (Note: The analog format is fixed to 2 channel):

- From Audio mode, press SETUP.
- Select Audio mode, press ENTER.
- Select MP3 and press ENTER.
- Set Digital out to:
 - PCM** (default) to output 2 channel digital from the optical/coaxial digital audio outputs; e.g., to a Minidisc recorder.
 - Off** to disable MP3 digital output.
- Press SETUP to save and exit.

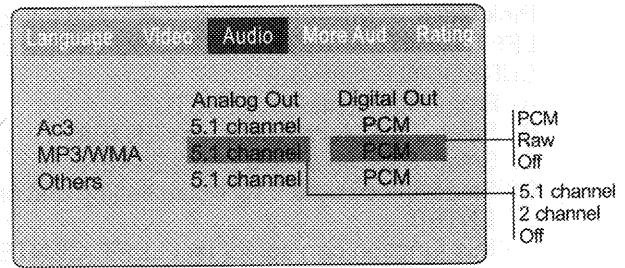

Others Setting

Follow these steps to set the outgoing analog and digital audio format of others tracks:

- From Stop mode, press SETUP.
- Select Audio and press ENTER.
- Select Dolby D and press ENTER.
- Set Analog out to:
 - 2 Channel** (default) to output 2 channel stereo audio from the stereo audio output; e.g., to a VCR or TV.
- Set Digital out (from Optical out) to:
 - PCM** (default) to output 2 channel digital audio from the optical/coaxial digital audio outputs; e.g., to a Minidisc recorder.
 - Raw** to output the raw 2 channel digital bitstream from the optical/coaxial digital audio outputs; e.g., to an external amplifier.
 - Off** to disable CD others audio output.
- Press SETUP to save and exit.

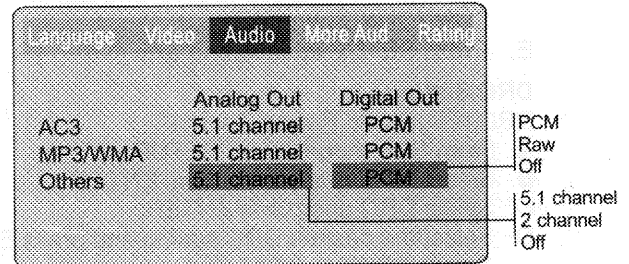

More Audio Setup

The More Audio menu includes Prologic and Subwoofer settings.

Prologic Setting

The DVD player has a built-in Dolby Prologic decoder to provide virtual surround sound for PCM (stereo) source material from the 5.1 channel analog audio outputs.

- From Stop mode, press SETUP.
- Select More Audio and press ENTER.
- Select Prologic and press ENTER.
- Select the desired Prologic setting and press ENTER:
 - Auto** stereo audio soundtracks will be output in Dolby Prologic mode.
 - On** all audio soundtracks will be output in Dolby Prologic mode.
 - Off** (default) Dolby Prologic decoding will always be inactive.
- Press SETUP to save and exit.

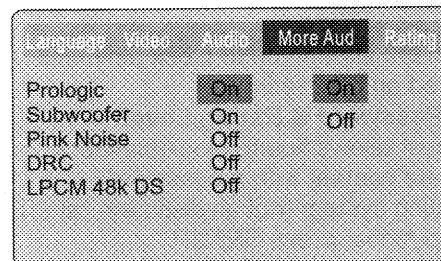

Subwoofer Setting

You must indicate in the menu system whether or not your audio setup includes a Subwoofer (the 1 in 5.1 surround sound).

- From Stop mode, press SETUP.
- Select More Audio and press ENTER.
- Select Subwoofer and press ENTER.
- Select the desired Subwoofer setting and press ENTER.
 - On** (default) indicates that you are using a Subwoofer for LFE (low frequency effects) signals.
- Press SETUP to save and exit.

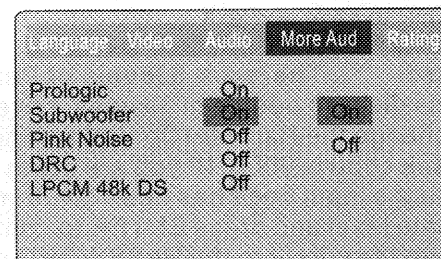

SYSTEM SETUP

Pink Noise Setting

Pink Noise is test tone set to "Off" and select test LEFT, CENTER, RIGHT, RIGHT SURROUND and LEFT SURROUND channel.

- From Stop mode, press SETUP.
- Select More Audio and press ENTER.
- Select Pink Noise and press ENTER.
- Select the desired Pink Noise setting and press ENTER.

this function can select test LEFT, CENTER, RIGHT, RIGHT SURROUND and LEFT SURROUND channel.

- Press SETUP to save and exit.

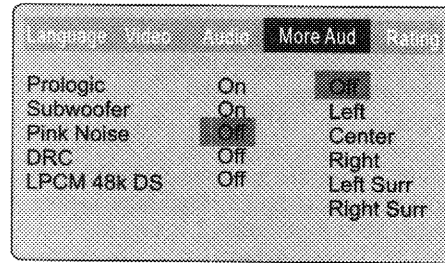

DRC Setting

DRC is Dynamic Range Control.

- From Stop mode, press SETUP.
- Select More Audio and press ENTER.
- Select DRC and press ENTER.
- Select the desired DRC setting and press ENTER.
Select "Off" or "On" state.

- Press SETUP to save and exit.

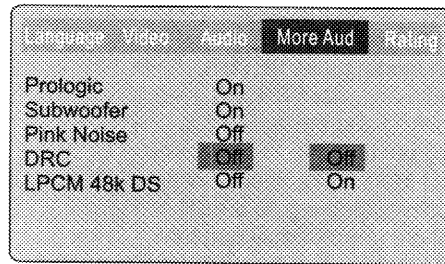

LPCM 48k DS Setting

- From Stop mode, press SETUP.
- Select More Audio and press ENTER.
- Select LPCM 48k DS and press ENTER.
- Select the desired LPCM 48k DS setting and press ENTER.

Select "Off" is LPCM 48k.

Select "On" is LPCM 96k.

- Press SETUP to save and exit.

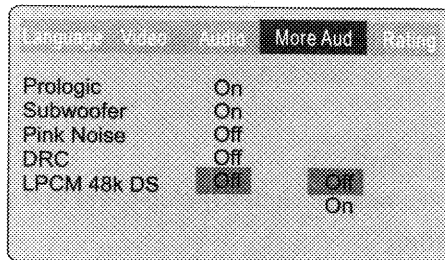

Rating Setup

The Rating menu allows you to block playback of DVDs based on their ratings.

Setting the Password & Rating Level

The DVD player allows you to block playback of inappropriate content with a password-protected Rating system (not all discs are rated).

- From Stop mode, press SETUP.
- Select Rating and press ENTER.
- Select Rating and press ENTER repeatedly to set the rating from 1 (most restrictive) to 8 (least restrictive).
If a password has already been set, the lock icon will be closed. You will not be able to select Rating until you SELECT the correct password using the 0-9 keys.
- Select Password.
- Use the 0-9 keys to SELECT a 4-digit password and press ENTER. The lock icon will close to indicate that the rating and password are set.
- Press SETUP to save and exit.

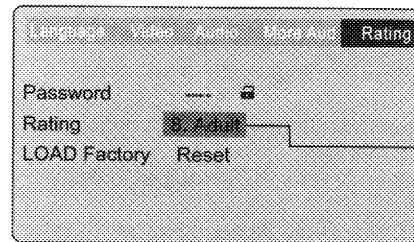

- Kid Safe
- G
- PG
- PG-13
- PG-R
- R
- NC-17
- Adult

Parental Control There are 8 levels of Parental Control, as follows:

Level one opens discs to people of all ages. Level eight is suitable only for adults.

If you want to change the Parental Control setting, enter the level number and then the four digit pass code. The default code is 0000. (If you are using the player for the first time, there is the code that is needed.) When the input code has been confirmed, the level setting menu will appear. Move the cursor to the appropriate level and press ENTER to confirm. Press Set Up to exit the Menu.

Password Move the cursor to the PASSWORD prompt and press ENTER. Input the password 0000 if this is your first use. After confirmation, you will be required to input a new 4 digit pass code. After entering your new pass code, press ENTER to confirm.

WARNING: Please keep a copy of the new pass code in a safe place. If you forget your password, please enter 0000 to clear the memory.

OPERATION OF MP3 FUNCTION

Mp3 is an audio compression mode using Level 3 of the international standard MPEG, whereby sound signal is compressed at a rate of 12:1. A Mp3 disc can record music for playing over 600 minutes or recording over 170 songs, rivaling CDs in sound quality.

To play a MP3 disc

Files Menu of Mp3 play

When playing a Mp3 disc, 2 files menus can be selected by pressing PROG key: File list, Folder.

1. FILE LIST

It may select the files to be played by pressing UP DOWN, arrow key combining with ENTER key, or using number keys and ENTER key to select directly. If the number input is out of the music number, "CURRENT TRACK NUMBER" will display on screen.

2. Folder

Display menu first then press UP DOWN, LEFT RIGHT arrow and ENTER key to select subdirectory and music.

JPEG FILES

JPEG adopts the most efficient compression and is widely used as flattened picture format. Even if pictures are compressed 15-20 times they still retain a good effect.

Supported by most picture software for storage, it contains small data and is easy to use. This machine can read JPEG formatted picture CDs.

Press relevant number key to select picture display.

1. Put in disc correctly, the machine begins to search disc information.
2. Press number key to select picture.

Select to play by menu

1. Put in disc, machine searches disc information and main menu displays on screen. Press number key from 1 to select picture. Press play key to make sure.
2. Press direction key to select picture then press play key.
3. In condition of stop, press direction key to select other pictures.
4. In condition of stop, select the first line file item on the right. Then press play key, to return to upper menu.

26

TROUBLE SHOOTING

This handy trouble-shooting your guide is provided to save your time in case you experience any inconvenience with this DVD player. If the problem is not listed or if the provided solution does not correct the problem, please return to point of sales within 12 months of purchase.

Problem Possible Solution

No power

1. Check to ensure that the power plug is securely in the wall outlet.

No sound

1. Check the connection between the DVD player and the TV set, amplifier, or any other unit it is connected to.
2. Check to ensure the TV and amplifier are in the correct mode.

No picture

1. Check the connection between the DVD player and the TV set or any other unit it is connected to.
2. Check to make sure TV is turned on.

Disc does not play

1. Check to make sure the disc is loaded correctly label side facing up on disc tray.
2. Check that disc is clean from dirt, dust, fingerprints, and smudges.
3. Check to ensure disc is within the guides on the tray.
4. Check if parental lock function is on.
5. Make sure disc is for use in region.

Remote does not work.

1. Check batteries; possibly replace.
2. Check to ensure there isn't any obstacles between the remote sensor on the unit's front panel and the remote control.
3. Be sure the remote is aimed at the remote sensor.

Divided picture

1. Check that disc is clean and has no scratches.
2. The unit is controlled by a micro computer, which may need to be reset. Turn off the unit's power, wait several seconds, then turn back on.

No color picture

1. Check to see if the S connector is damaged (bent pin).

Mp3 discs don't play

1. Use another software edition to re-burn disc, as the edition used may not be compatible with the player.
2. Use new editions of software such as Audio station 4, "Easy CD Creator", To ast Titanium, etc.
3. Make sure MP3 file is not encoded with a variable bit rate, such as provided by Real Networks.

TECHNICAL SPECIFICATIONS

DVD Player

| | |
|-------------------------------------|--|
| TV System | NTSC/PAL |
| Compatible Discs | DVD, CD, MP3, CD-R, CD-RW |
| Resolution Ratio | Greater Than 500 lines |
| Video S/N Ratio | 65dB |
| Frequency Response | fs (96KHz/24bit) 4Hz - 44KHz: +/-2dB |
| Audio S/N Ratio | 95dB |
| Degree of Distortion | <0.01% |
| D/A Converter | 192KHz/24bit |
| Video Out | 1Vp-p |
| S-Video Out | Y: 1Vp-p(75Ω) C: 0.3Vp-p(75Ω); 2.0V/±9V |
| Audio Out | 5.1 Channel, |
| Digital Audio Output Connections | Coaxial YUV, CVBS S-Video, 2 Channel Output |

FM Tuner

| | |
|--------------------|-----------------------------------|
| Tuning Range | 87.5-108MHz |
| S/N Ratio | >46dB |
| Monophonic | >46dB |
| Stereo | >50dB (DIN) |
| Selectance | 50dB |
| THD | |
| Monophonic | 2% |
| Stereo | 3% |
| Frequency Response | 30Hz-10kHz +/- 1dB |
| Stereo Resolution | 35dB (1kHz) 30dB (100Hz-10kHz) |

AM Tuner

| | |
|--------------|-------------|
| Tuning Range | 530-1710KHz |
| S/N Ratio | 35dB |
| THD | 3% |

Amplifier

| | |
|-------------------|--------------|
| Output Power: | |
| Main Speakers | 10W+10W (6Ω) |
| Surround Speakers | 10W+10W (6Ω) |
| Center Speaker | 10W (6Ω) |
| Subwoofer | 20W (8Ω) |

Frequency Response:

| | |
|-------------------|---------------------|
| Main Speakers | 200Hz-20kHz +/- 3dB |
| Surround Speakers | 200Hz-20kHz +/- 3dB |
| Center Speaker | 200Hz-20kHz +/- 3dB |
| Subwoofer | 20Hz-200Hz +/- 3dB |

| | |
|--------------------|-----------------|
| S/N Ratio | > 76dB |
| Input Sensitivity | 350mv, 47k |
| Channel Resolution | > 30dB (Normal) |

Remote Control

| | |
|--------------|-------------------|
| Transmitter | Infrared Ray |
| Signal Range | Approximately 15' |
| Power Source | 2 "AAA" Batteries |

General

| | |
|----------------|--------------|
| Power Supply | AC 120V-60Hz |
| Consumed Power | 90W |

Because its products are subject to continuous improvement, we reserves the right to modify product design and/or specifications without notice and without incurring any obligations.

WARRANTY

COBY®

90 DAY LIMITED WARRANTY

COBY ELECTRONICS CORP. (COBY) warrants this product to the original purchaser to be free from defects in material or workmanship under normal use for 90 DAYS from the date of original purchase. COBY agrees at our option under this warranty, to repair or replace it with a new or reconditioned product at no additional charge. Our warranty, of course, does not cover any product, which has been subject to neglect, unreasonable use, accident, violation of operating instructions, or any product that has been repaired or modified by an unauthorized service agent.

To obtain factory service, return this unit freight-prepaid to the address shown below within the duration of this warranty. Enclose \$6.00 for each item in the form of a money order made payable to COBY ELECTRONICS CORP. to cover the cost of shipping and handling. A copy of the sales receipt, a detailed description of the problem and all parts or accessories must be included. The unit(s) must be packaged in such a way as to reasonably protect it from possible shipping damage. For further information contact us at www.cobyusa.com or write to:

COBY ELECTRONICS CORP.
Customer Service Dept.
56-65 Rust Street
MASPETH, NY 11378

COBY's liability under any legal theory for any loss or damage in any way related to this product shall not exceed the sales price of this product. In no event shall COBY be liable for any incidental or consequential damages resulting from the use of this product, or inability to use this product. Repair or replacement as provided under this warranty is the exclusive remedy of the consumer.

Except to the extent prohibited by law, no express or implied warranty of merchant ability or fitness for a particular purpose on this product shall not be extended beyond the period of this warranty. Some states prohibit the exclusion of limitation of incidental or consequential damages, so that the above limitations or exclusion may not apply to you. This warranty gives you specific rights, and you may also have other rights that may vary from state to state.

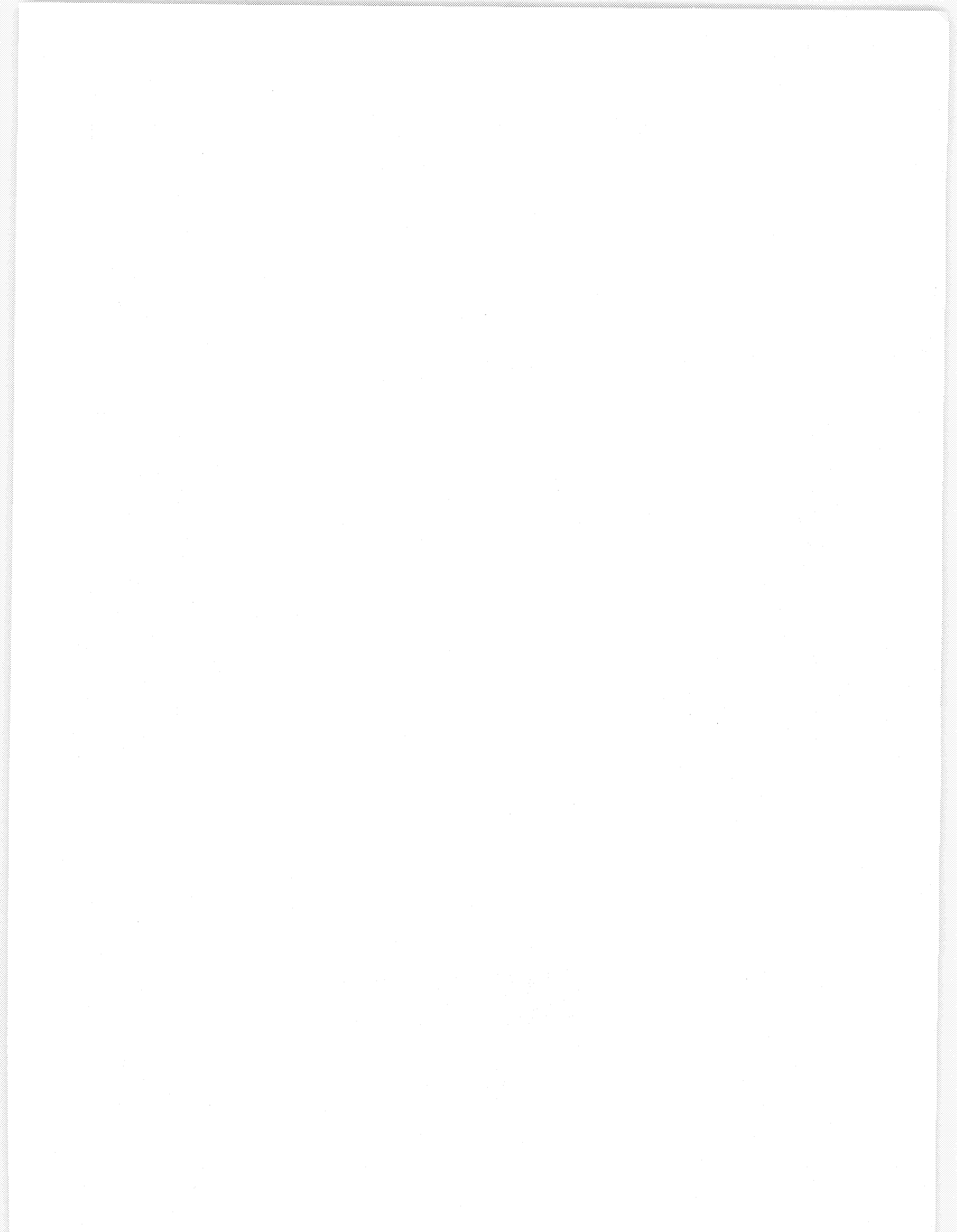



Manufactured under license from Dolby Laboratories. "Dolby",
"Pro Logic" and the double-D symbol are trademarks of Dolby
Laboratories. Confidential Unpublished Works. © 1992-1997
Dolby Laboratories, Inc. all rights reserved.

Free Manuals Download Website

<http://myh66.com>

<http://usermanuals.us>

<http://www.somanuals.com>

<http://www.4manuals.cc>

<http://www.manual-lib.com>

<http://www.404manual.com>

<http://www.luxmanual.com>

<http://aubethermostatmanual.com>

Golf course search by state

<http://golfingnear.com>

Email search by domain

<http://emailbydomain.com>

Auto manuals search

<http://auto.somanuals.com>

TV manuals search

<http://tv.somanuals.com>