

ADCOM

we have the power

GFA-555se

OWNER'S MANUAL



High-Current Power Amplifier

Congratulations

Congratulations on your purchase of the Adcom GFA-555se

You have made a wise choice that will reward you with exceptionally accurate musical sound reproduction for years to come. To realize the full potential of your new amplifier, please read these operating and installation instructions thoroughly before attempting to make any connections to it.

The GFA-555se is not only designed to reproduce the highest quality sound but also to deliver the greatest possible value. It is our engineers' passion for perfection that has enabled our components to be judged the equivalent of others costing two, three, or even five times as much. Our engineering team consistently strives to develop and design products that will exceed your expectations. Our goal at Adcom is to let more consumers hear high-end quality sound without paying high-end prices.

All Adcom components are the result of a long-standing dedication to innovation, quality, simplicity, and value. Adcom: We have the power – and now, so do you!

Thank you from the Adcom Team



CAUTION
RISK OF ELECTRIC SHOCK
DO NOT OPEN



WARNING: TO REDUCE THE RISK OF ELECTRIC SHOCK, DO NOT REMOVE COVER (OR BACK); NO USER-SERVICEABLE PARTS INSIDE; REFER SERVICING TO QUALIFIED SERVICE PERSONNEL.



The lightning flash with arrowhead symbol, within an equilateral triangle, is intended to alert the user to the presence of uninsulated "dangerous voltage" within the product's enclosure that may be of sufficient magnitude to constitute a risk of electric shock.



The exclamation point within an equilateral triangle is intended to alert the user to the presence of important operating and maintenance (servicing) instructions in the literature accompanying the appliance.



PORTABLE CART WARNING
(Symbol provided by RETAC)

Do not place this unit on an unstable cart, stand, tripod, bracket, or table. The unit may fall, causing serious injury to a child or adult, and serious damage to the unit. Use only with a cart, stand, tripod, bracket, or table recommended by the manufacturer or sold with the unit. Any mounting of the device should follow the manufacturer's instructions, and should use a mounting accessory recommended by the manufacturer.



AVERTISSEMENT
DANGER D'ÉLECTROCUTION
NE PAS OUVRIR



AVERTISSEMENT: POUR ÉLIMINER TOUT RISQUE D'ÉLECTROCUTION, NE PAS OUVRIR LE COUVERCLE (OU LA PARTIE ARRIÈRE). AUCUNE PIÈCE RÉPARABLE PAR L'UTILISATEUR NE SE TROUVE À L'INTÉRIEUR. POUR TOUTE INTERVENTION D'ENTRETIEN OU DE RÉPARATION SE CONFIER AUX TECHNICIENS QUALIFIÉS.



La flèche symbolisant l'éclair dans un triangle équilatéral a pour objet de tirer l'attention de l'utilisateur sur le fait, qu'il y a des "tensions dangereuses" non isolées à l'intérieur de l'enceinte du produit qui peuvent être suffisamment importantes pour conduire au risque d'électrocution.



Le point d'exclamation au sein d'un triangle équilatéral a pour objet de tirer l'attention de l'utilisateur sur le fait qu'il y a des instructions de mise en service et d'entretien (de réparation) dans les fiches descriptives de l'appareil qui doivent obligatoirement être respectées.

TABLE OF CONTENTS

LETTER FROM THE ADCOM TEAM.....	2
SAFETY INFORMATION	4
DESCRIPTION OF UNIT	
GFA-555se FEATURES	5
WARRANTY INFORMATION	5
INSTALLATION & HOOKUP	
UNPACKING THE GFA-555se	6
INSTALLING THE GFA-555se	6
CONNECTING THE GFA-555se	7
STEREO/BRIDGED MONO INPUT/OUTPUT.....	7-8
OPERATION	
FRONT AND REAR PANEL DIAGRAMS	9
DESCRIPTION OF UNIT: REAR PANEL	10-11
DESCRIPTION OF UNIT: FRONT PANEL	11
TROUBLESHOOTING	
RESOLVING PROBLEMS	12
CARING FOR YOUR GFA-555se	13
SERVICE INFORMATION	13
GFA-555se SPECIFICATIONS	14-15

THE FOLLOWING PRECAUTIONS AND SAFETY INSTRUCTIONS ARE REQUIREMENTS OF ETL AND ETL_C SAFETY REGULATIONS

- Read all the safety and operating instructions before connecting or using this unit.
- Retain this notice and the owner's manual for future reference.
- All warnings on the unit and in its operating instructions should be adhered to.
- All operating and use instructions should be followed.
- Do not use this unit near water. For example, near a bathtub, washbowl, kitchen sink, laundry tub, in a wet basement, or near a swimming pool.
- The unit should be installed so that its location or position does not interfere with its proper ventilation. For example, it should not be situated on a bed, sofa, rug, or similar surface that may block the ventilation openings; or placed in a built-in installation, such as bookcase or cabinet, that may impede the flow of air around its heatsinks or through its ventilation openings.
- The unit should be situated away from heat sources such as radiators, heat registers, stoves, or other devices (including other amplifiers) that produce heat.
- The unit should be connected to a power supply outlet only of the voltage and frequency marked on its rear panel.
- The power supply cord should be routed so that it is not likely to be walked on or pinched, especially near the plug, convenience receptacles, or where the cord exits from the unit.
- Clean unit only as recommended in its instruction manual.
- The power supply cord of the unit should be unplugged from the wall outlet when it is to be unused for a long period of time and during electrical storms.
- Care should be taken so that objects do not fall, and liquids are not spilled, into the enclosure through any openings.
- This unit should be serviced by qualified service personnel when:
 - a. The power cord or the plug has been damaged; or
 - b. Objects have fallen, or liquid has been spilled, into the unit; or
 - c. The unit has been exposed to rain, or liquids of any kind; or
 - d. The unit does not appear to operate normally, or exhibits a marked change in performance; or
 - e. The device has been dropped, or the enclosure damaged.

WARNING

TO REDUCE THE RISK OF FIRE OR ELECTRIC SHOCK, DO NOT EXPOSE THIS UNIT TO RAIN OR MOISTURE.

AVERTISSEMENT

AFIN D'ÉVITER TOUT RISQUE D'INCENDIE OU D'ÉLECTROCUTION, NE PAS EXPOSER CET APPAREIL À LA PLUIE NI À L'HUMIDITÉ.

CAUTION

TO PREVENT ELECTRIC SHOCK DO NOT USE THIS POLARIZED PLUG WITH AN EXTENSION CORD, RECEPTACLE OR OTHER OUTLET UNLESS THE BLADES CAN BE FULLY INSERTED TO PREVENT BLADE EXPOSURE.

ATTENTION

POUR PRÉVENIR LES CHOCS ÉLECTRIQUES NE PAS UTILISER CETTE FICHE POLARISÉE AVEC UN PROLONGATEUR, UNE PRISE DE COURANT OU UNE AUTRE SORTIE DE COURANT, SAUF SI LES LAMES PEUVENT ÊTRE INSÉRÉES À FOND SANS EN LAISSER AUCUNE PARTIE À DÉCOUVERT.

THERE ARE NO USER SERVICEABLE PARTS IN THIS PRODUCT. DO NOT ATTEMPT SERVICING OF THIS UNIT YOURSELF. REFER SERVICING TO QUALIFIED SERVICE PERSONNEL.

CAUTION POWER LINES

Any outdoor antenna must be located away from all power lines.

OUTDOOR ANTENNA GROUNDING

If an outside antenna is connected to your tuner or tuner/pre-amplifier, be sure the antenna system is grounded so as to provide some protection against voltage surges and built-up static charges. Section 810 of the National Electrical Code, ANSI/NFPA No. 701984, provides information with respect to proper grounding of the mast and supporting structure, grounding of the lead-in wire to an antenna discharge unit, size of grounding conductors, location of antenna discharge unit, connection to grounding electrodes, and requirements for the grounding electrode.

- a. Use No.10 AWG (5.3 mm²) copper, No.8 AWG (8.4 mm²) aluminum, No.17 AWG (1.0 mm²) copper clad steel or bronze wire, or larger, as a ground wire.
- b. Secure antenna lead-in and ground wires to house with stand-off insulators spaced from 46 feet (1.221.83 m) apart.
- c. Mount antenna discharge unit as close as possible to where lead-in enters house.
- d. Use jumper wire not smaller than No.6 AWG (13.3 mm²) copper, or the equivalent, when a separate antenna grounding electrode is used. See NEC Section 810-21 (j).

EXAMPLE OF ANTENNA GROUNDING AS PER NATIONAL ELECTRICAL CODE INSTRUCTIONS CONTAINED IN ARTICLE 810. RADIO AND TELEVISION EQUIPMENT.

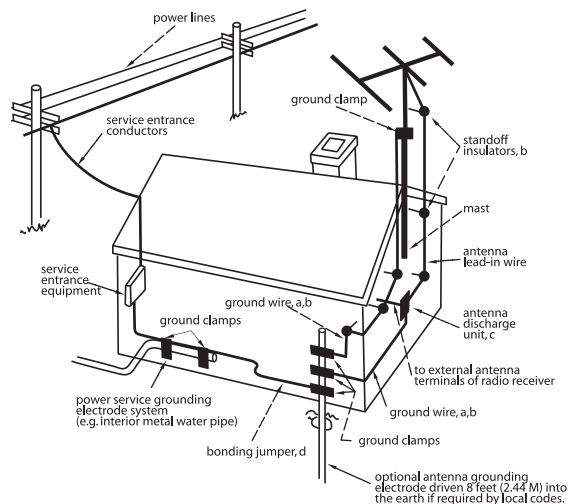

NOTE TO CATV SYSTEM INSTALLER

This reminder is provided to call the CATV system installer's attention to Article 82022 of the National Electrical Code that provides guidelines for proper grounding and, in particular, specifies that the cable ground shall be connected to the grounding system of the building, as close to the point of cable entry as practical.

NOTE TO AUDIO SYSTEM INSTALLER

WHENEVER CONNECTIONS TO OR FROM THE GFA-555SE ARE BEING MADE, BE CERTAIN THAT THE AC ON/OFF SWITCH OF THE AMPLIFIER IS IN THE OFF POSITION, THE AC CORD OF THE AMPLIFIER IS DISCONNECTED FROM THE AC WALL OUTLET AND THAT ALL ASSOCIATED COMPONENTS ARE OFF. Always make certain that the amplifier is disconnected from the AC outlet for at least five minutes to ensure its filter capacitors are discharged before making connections to and from the amplifier. Failure to heed this precaution may result in damage to the loudspeaker(s) and/or the amplifier which is not covered by the Warranty.

GFA-555se FEATURES

- Precision-matched devices used throughout the signal path.
- 60,000 μF of power supply-filter capacitance for greater reserve capacity.
- Independent power supplies for each channel.
- Fewer gain stages improve signal reproduction accuracy.
- Custom toroidal power transformer provides better regulation and greater peak current capability.
- Independent distortion LED for each channel.
- High quality, gold-plated 5-way binding posts.
- High quality, gold-plated RCA jacks.
- High quality, balanced XLR jacks.
- Large independent heatsinks for greater cooling capability of output devices.
- Heavy gauge, anodized aluminum front panel.
- Powder-coated, baked chassis and top cover for greater durability.
- Cooling vents for greater efficiency and cooler operation while driving low impedance loads.

ADCOM Protection Plan (USA Only)

ADCOM offers the enclosed valuable Limited Warranty. Please read the details on the Warranty Card carefully to understand the extent of the protection offered by the Warranty, its reasonable limitations, and what you should do in order to obtain its benefits. Be sure to verify that the serial number printed on the rear panel matches the serial number on the outer carton. If any number is altered or missing, or if the ADCOM Warranty Card is not included in the carton, you should notify us immediately in order to ensure that you have received a genuine ADCOM product which has not been opened, mishandled, or tampered with in any way. Always retain your original sales receipt as a proof of purchase. A proof of purchase is required for all warranty service.

INTRODUCTION

Congratulations on your decision to purchase the GFA-555se power amplifier. By use of updated components in the classic ADCOM GFA-555 design, we have reestablished our heritage of high performance and audiophile quality at the greatest possible value. You have made a wise choice that will reward you for years to come with exceptionally accurate and musical sound reproduction. To realize the full potential of your new amplifier, and before making any connections to it, please read these operating and installation instructions thoroughly.

UNPACKING THE GFA-555se

Before your new ADCOM amplifier left our factory, it was carefully inspected for physical imperfections and tested for all electrical parameters as a routine part of ADCOM's systematic quality control. This, along with full operational and mechanical testing, should ensure a product flawless in both appearance and performance. After you have unpacked the GFA-555se, inspect it for physical damage. Save the shipping carton and all packing material as they are intended to reduce the possibility of transportation damage, should the amplifier ever need to be shipped again. In the unlikely event damage has occurred, notify your dealer immediately and request the name of the carrier so a written claim to cover shipping damages can be initiated. **THE RIGHT TO A CLAIM AGAINST A PUBLIC CARRIER CAN BE FORFEITED IF THE CARRIER IS NOT NOTIFIED PROMPTLY IN WRITING AND IF THE SHIPPING CARTON AND PACKING MATERIALS ARE NOT AVAILABLE FOR INSPECTION BY THE CARRIER. SAVE ALL PACKING MATERIALS UNTIL THE CLAIM HAS BEEN SETTLED.**

INSTALLING THE GFA-555se

During normal home operation the internal heatsinks of the GFA-555se may become warm. However, there are instances during high-level playback into low impedances when the heatsinks will become much warmer than usual. To ensure the amplifier's long-term, trouble-free operation it is necessary to provide adequate ventilation for the heatsinks. Therefore, the GFA-555se should be kept away from external sources of heat such as radiators and hot-air ducts. The GFA-555se should never be placed with other heat-producing components in a cabinet or enclosure lacking free air flow. The top and bottom panel of the amplifier's chassis have been provided with vents to allow the necessary cooling of the internal components. It is imperative that these vents are not obstructed in any way.

We recommend that you do not stack other components on top of the GFA-555se. This is particularly important if your system includes low-impedance loudspeakers which are difficult to drive, or if you will consistently demand high volume levels from the amplifier and speaker system. Not only will heat generated by the amplifier affect the performance of equipment stacked on top of the GFA-555se, but the free flow of air through the ventilating slots in the amplifier may be partially obstructed.

If you observe these recommendations, the GFA-555se will perform reliably in any reasonable environment. You should also pay attention to such normal considerations as protection from excessive dust and moisture. Occasional vacuuming of accumulated dust on the chassis, panels and around the ventilating slots should be all that is required. The optimal performance of your new GFA-555se will ultimately depend on the care with which you make the connections between the amplifier, preamplifier and the loudspeakers. All input and output signal connections should be made only with high quality, low-loss, low capacitance cables following the recommendations in the Inputs and Outputs section of **CONNECTING THE GFA-555se**.

CONNECTING THE GFA-555se

When connecting the amplifier to the loudspeaker, it is vital to maintain proper polarity (positive to positive, negative to negative). On the GFA-555se, the positive terminal is color coded RED and labeled "+", and the negative is color coded BLACK and labeled "-". The positive terminal on the speaker will be color coded RED, or will be labeled "+", "pos", "positive", "8 ohms" or "4 ohms". The negative terminal on the speaker will be color coded BLACK, or will be labeled "-", "neg", "negative", "C", "Common", "G", or "ground".

It is recommended that your speaker cables be terminated with "U" type spade connectors. These will give the most contact area insuring long-term reliability. The spade connector should have a maximum width of 0.57 inches and an opening width of no less than 0.25".

To properly connect the speaker cable to the binding posts, turn the insulated head of the binding post clockwise until the wire or connector is firmly secured. Finger pressure is sufficient and you should not use pliers or other tools which could damage or over-tighten the binding-post assembly. The binding posts have been designed in such a way that finger pressure is all that is required to cause a "pinching" action among the different metal surfaces to ensure proper connection.

It is very important to use the correct size of wire in order to avoid unnecessary loss of amplifier power in the cable, reduction of amplifier damping factor and other undesirable conditions. Sound audio engineering practice suggests the use of at least AWG16, stranded, copper cable. Recommended capacitance of the speaker wire should not exceed 50pF per foot. This insures high frequencies will not be rolled-off.

All loudspeakers having a nominal impedance down to 4 ohms can be connected to and driven by the GFA-555se. The amplifier can drive these low-impedance speakers at more than adequate power levels with no difficulty. It should be noted that many loudspeaker systems which are nominally rated at 4 ohms drop in impedance, in some parts of their frequency range, to as low as 2 ohms (and sometimes less). You will not experience difficulties even with these very low impedance loads unless you demand excessively high volumes levels from your system.

It is suggested to follow this chart for speaker lengths and wire gauges. If longer runs are needed, it is best to consult with your ADCOM Dealer to maximize the performance of your system with your exact conditions.

up to 24 feet	AWG16	up to 36 feet	AWG14	up to 58 feet	AWG12
---------------	-------	---------------	-------	---------------	-------

STEREO/BRIDGED MONO INPUT/OUTPUT

The GFA-555se can be used as a very powerful mono amplifier to drive 8-ohm impedance loudspeakers when in its "bridged" mode. No modification to the amplifier is necessary for operation in the bridged mode, nor are any additional accessories required. However, you will need two GFA-555ses for stereophonic reproduction, if you are using them in the bridged mono mode.

To set the amplifier in bridged mono operation, flip the STEREO/BRIDGED input switch into the BRIDGED position. When in the bridged mono mode, input to the amplifier is made only through the LEFT input jack. The connection to the RIGHT input jack should be removed since the right-channel input portion of the amplifier is inoperative.

Only a single loudspeaker is to be connected to the GFA-555se when in the bridged mono mode. Please note that connections made to the loudspeaker from the GFA-555se, when used in the bridged mono mode, are different from those made when the amplifier is used in the stereo mode. The LEFT RED output binding-post terminal (labeled BRIDGED MONO OUTPUT "+") should be connected to the loudspeaker input terminal color-coded RED (or labeled POSITIVE, "+", POS, 8 OHMS or 4 OHMS). The RIGHT RED output binding post terminal on the amplifier (labeled BRIDGED MONO OUTPUT "-") should be connected to the BLACK loudspeaker terminal (or labeled NEG, "-", C, COM, COMMON, G, or GROUND). Please note that if you want to insure correct stereo phasing with optimal bass response, you must observe these connections precisely.

Although the GFA-555se can generate a substantially greater amount of power in the bridged mono mode than when it is in its normal stereo mode, it requires the use of loudspeakers whose nominal impedance does not drop below 4 ohms. It is not recommended that the GFA-555se be used in the bridged mono mode into loudspeakers, or multiple loudspeaker loads, which drop in value substantially below 4 ohms. Otherwise, you may trigger the THERMAL PROTECTION or blow one of the DC RAIL FUSES. A little known fact is that when any amplifier is operated in the bridged mode, the load is "split" between the two amplifiers in the bridged configuration. Therefore, an 8-ohm loudspeaker will be seen by the amplifier as if it were a 4-ohm load; a 4-ohm loudspeaker load will be seen by the amplifier as a 2-ohm load.

NOTES:

- a) If the connections described above are followed exactly, the GFA-555se will be polarity correct, that is, it will not invert "phase". Any positive-going signal at its input will appear as a positive-going signal at the loudspeaker.
- b) For use in professional installations, the GFA-555se may be mounted in a standard 19-inch rack using the optional RM-7 rack-mount adaptors available through ADCOM dealers. If the GFA-555se is to be mounted on a rack, along with other components which are interconnected to the GFA-555se, the amplifier's chassis must be insulated from the metal-rack rails to prevent ground loops, especially if the rack is grounded to "earth", and to avoid defeating the audio grounding scheme of the power amplifier (the audio-input grounds are isolated from and above the chassis ground). Please consult the instruction sheet packed with the optional rack-mount adaptors for more information.
- c) The DC RAIL FUSES provide protection for the output stages and power supply in the event of excessive current demands from the amplifier, either long-term or short-term. If the amplifier ceases to operate, either on one or both channels, particularly during high-level passages, or long-term high-volume playback, and the POWER LED glows while the THERMAL PROTECTION LED is out, the chances are that one or both of the DC RAIL FUSES on that channel, or both channels, are blown. In the event that the DC RAIL FUSES need to be replaced, refer servicing to qualified service personnel. **DO NOT USE ANY SUBSTITUTE FUSES WITH DIFFERENT RATINGS, TIME-CURRENT CURVES OR VALUES.** Failure to observe this precaution may cause serious damage to the amplifier circuits, **MAY CREATE A FIRE HAZARD, AND MAY VOID YOUR WARRANTY.**

REAR PANEL

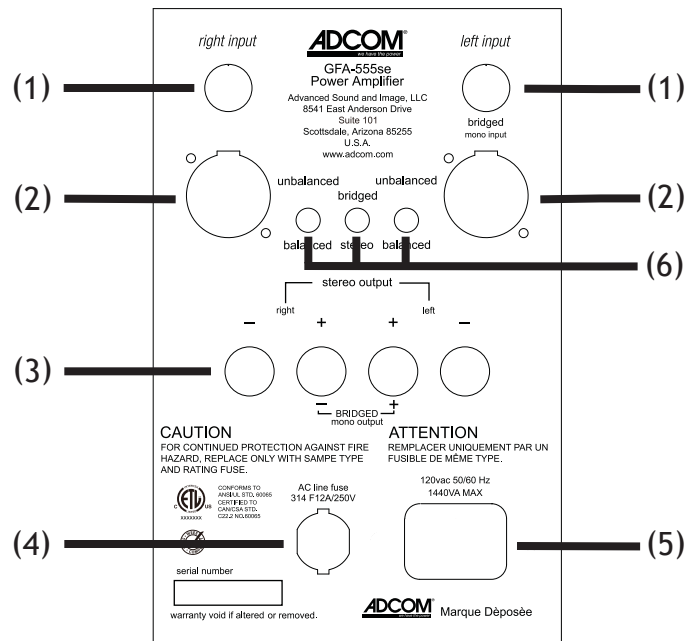

FRONT PANEL



(1) Inputs (unbalanced)

(6) Mode Switches

(2) Inputs (balanced)

(7) On/Off Switch

(3) Output Binding Posts

(8) Power LED

(4) AC Fuse

(9) Thermal Protection LED

(5) AC Power Cord

(10) Distortion Alert LEDs

DESCRIPTION OF UNIT: REAR PANEL

(1) Inputs (unbalanced)

The audio inputs for the GFA-555se are through high-quality, gold-plated RCA jacks to minimize high-frequency losses, noise, etc. They will accept standard RCA-type plugs, one for each channel; Left and Right. To insure that the performance designed into the amp is preserved, you should use the highest quality audio cables possible. There are many cables which are color-coded and specifically designed for this application. Your ADCOM dealer can help select the best cable for your needs. (See CONNECTING THE GFA-555se for more information).

(2) Inputs (balanced)

The audio inputs for the GFA-555se are through high-quality, Balanced XLR jacks to minimize high-frequency losses, noise, etc. They will accept standard XLR-type plugs, one for each channel; Left and Right. To insure that the performance designed into the amp is preserved, you should use the highest quality audio cables possible. There are many cables specifically designed for this application. Your ADCOM dealer can help select the best cable for your needs. (See CONNECTING THE GFA-555se for more information).

(3) Outputs

The GFA-555se connections to the loudspeakers are made through high-grade, 5-way, gold-plated binding post terminals. There are two terminals for each speaker, which are colored RED for the positive (+) output and BLACK for the negative (-) output.

The binding posts will accept a variety of connector types; the most secure and prevalent of these is the "U"-type spade connectors (at least 0.25" wide and maximum width of 0.57"),. The terminal will also accept bare wire (up to AWG10) and "banana" type plugs (single or dual). (Refer to your User Manual for your speakers for additional information).

(4) AC Fuse

The AC Fuse protects the electronic circuits of the GFA-555se. This fuse, normally, will fail only if there is an overload within the GFA-555se. It may, however, fail if the amplifier attempts to deliver very high power into very

low-impedance loudspeakers. In either case, BE SURE TO REPLACE THE AC Fuse ONLY WITH AN EXACT REPLACEMENT FUSE. The proper fuse values are:

GFA-555se for 115 volt operation

Fuse Rating	BUSS®	Littelfuse®
12 Amp 250 Volt ...	AGC-12/250V	(3AB) 314012/250V

GFA-555se for 230 volt operation

Fuse Rating	BUSS®	Littelfuse®
6 Amp 250 Volt	AGC-6/250V	(3AG) 314006/250V

Before attempting to replace a failed fuse, be certain to unplug the AC Power Cord from the AC wall outlet to prevent possible electrical shock. Replace the AC Fuse only with one identical in type and rating as printed on the rear panel. DO NOT USE ANY SUBSTITUTE FUSES WITH DIFFERENT RATINGS OR VALUES. Failure to observe this precaution may cause serious damage to the amplifier circuits, may create a hazard fire, and may void the warranty. If the Power LED (8) does not glow, it may be an indication that the AC fuse has blown. If you are not sure, or the amplifier displays other symptoms, please consult the RESOLVING PROBLEMS section on page 12.

Fuse replacement

To remove the fuse-holder cap, you will need a #2 standard Phillips screwdriver. Place the screwdriver in the recessed "crosshead" in the cap. Turn the cap counter-clockwise, until the cap releases out towards you. Grasp the cap with your fingers and pull it completely out. The fuse is inserted in the back of the cap; gently pull it free.

Since the fuse has a ceramic body, you cannot visually examine the fuse element, it is therefore suggested that you replace it with an identical substitute or bring the fuse to your ADCOM dealer so they may check its integrity. To replace the fuse, insert it in the back of the fuse-holder cap. Place the cap into the fuse-holder. Place the screwdriver in the recessed slot, gently press in and turn 1/8-turn clockwise.

(5) AC Power Cord

The AC cord provides power to operate all the GFA-555se's circuits. Its plug can be connected to a standard wall outlet provided the outlet supplies a voltage compatible with the power requirements printed on the rear panel of the GFA-555se.

(6) Mode Switches

For normal stereophonic mode of operation, the STEREO/BRIDGED input switch should be set to STEREO. Otherwise, the amplifier will operate in the bridged mono input mode by which you will amplify only the left channel through both outputs of the amplifier. The BALANCED/UNBALANCED selector switches should be set to accommodate the type of input connectors that you are using. The upper connectors (RCA-jacks) are used for unbalanced input signals and the lower connectors (XLR-jacks) are used for balanced input signals.

DESCRIPTION OF UNIT: FRONT PANEL

(7) On/Off Switch

The On/Off Switch controls AC power to the power transformer and circuits of the GFA-555se. Whenever the GFA-555se is energized the Power LED (8) will glow red. To turn the GFA-555se on, press the button up. It will remain in the “engaged” position while the unit is energized. To turn the GFA-555se off, press the button down and it will move to the “disengaged” position.

(8) Power LED

This LED will glow whenever the On/Off Switch (7) is turned on and the GFA-555se is energized. The Power LED indicates that there is AC voltage being fed to the amplifier, but it does not signify that all the amplifier’s circuits are in operation. If, for example, the Thermal Protection LED (9) glows, that amplifier will not produce sound even though the Power LED may still glow. When the GFA-555se is turned off, the Power LED will take some time to fade out completely. It may take up to 30 seconds to fully extinguish.

Additionally, the internal power transformer is provided with a thermostat which will interrupt power into the transformer if its temperature exceeds 125°C. This high temperature will seldom, if ever, be encountered unless the amplifier is subjected to abnormal conditions, such as operation into loads of less than 3 ohms at very high listening levels, etc. If the AC Fuse (4) has not failed, the Power LED (8) is out, and the Thermal Protection LED (9) does not glow, this would indicate that the thermostat within the transformer has opened.

Once the temperature within the transformer decreases to a normal level, the thermostat will reset itself

automatically and normal operation will resume. If you are to avoid tripping the thermostat in the transformer continually, you must reduce the sound level demands, correct the load impedance of the loudspeakers, or both.

(9) Thermal Protection LED

The GFA-555se is provided with a thermal protection circuit which will shut down the amplifier if its heatsink temperature reaches 75°C. The Thermal Protection LED will light whenever the thermal protection circuit has been triggered and the amplifier is inoperative. The thermal protection circuitry will typically be triggered by very high power demands into impedances much lower than the amplifier is capable of driving at those levels. If any amplifier channel’s output through the loudspeaker(s) ceases abruptly, and its Thermal Protection LED glows, you will know that its heatsink temperature has become unacceptably high and the circuitry is protecting the amplification devices. Please note that the Power LED (8) will remain on and the amplifier will still be energized. Once the temperature of the heatsink(s) drops to a safe operating level, that amplifier will automatically resume operation.

(10) Distortion Alert LEDs

The Distortion Alert circuit is a unique ADCOM distortion detection system which reads all forms of non-linear distortion such as THD, IM, slew-induced, “clipping”, etc. The Distortion Alert LEDs will light when distortion reaches approximately 1% regardless of impedance, voltage/current phase angle or the reactance of the loudspeakers which the amplifier is driving. Sometimes, when the amplifier is in use, the LEDs may occasionally flicker during high volume listening, particularly if you are driving low impedances. This flickering is no cause for concern. The LEDs are simply warning you that the amplifier is approaching its maximum power output into the particular loudspeakers you are using. If, however, the Distortion Alert LEDs glow brightly or are illuminated most of the time during playback, you are over driving the amplifier and should turn down your volume control to reduce the listening level, otherwise it may cause the Thermal Protection to be activated or, in extreme cases, damage your loudspeakers.

RESOLVING PROBLEMS

Use the chart below to solve common situations that don't require professional attention. If the steps stated in POSSIBLE SOLUTION do not resolve your problem, then please contact your ADCOM Dealer or call the ADCOM Customer Service Department. Any problems not covered here should be brought to the attention of your ADCOM Dealer or ADCOM Customer Service Department.

SYMPTOM	POSSIBLE REASON	POSSIBLE SOLUTION
Power LED does not glow.	AC Power Cord(s) not plugged in. Power switch not (pressed) on.	Plug in AC Power Cord(s). Press the Power switch.
No sound.	AC Fuse(s) failed. Transformer thermal protection engaged.	Replace AC Fuse(s). Wait until unit cools down. It will reset.
Power LED glows, but no sound. One channel not producing sound.	Preamp or source unit is not on. Connections in rear of amp are loose. INPUT(s) or OUTPUT(s) connector disconnected or loose. Speaker disconnected. Internal protection engaged.	Make sure whole system is on. Verify all connections on rear of amp. Verify both connections on that channel. Verify connection at speaker. Bring to Dealer or Service Center.
Hum from all speakers at any volume.	Ground loop (difference in ground voltages between components).	If Cable TV is present (see Note 1). If Cable TV is not present (see Note 2).
Hum from all speakers (hum goes up or down with volume).	Problem with source unit (CD, tape, etc.), or RCA cable connecting that source unit to the preamp.	Try different source (tuner, tape, etc.) and/or different RCA cable.
Hum from the amplifier itself.	Some major appliance, dimmer, halogen or fluorescent light is creating interference.	Make sure all appliances, dimmers and suspect lights are off.

A special note on "hum" When there is a low-volume "hum" audible throughout your speakers, even with the main volume turned all the way down, you have a common phenomenon known as a "ground loop". A ground loop is basically a difference in ground voltages between two or more components which are connected electrically and which creates multiple current paths where there must only be one. This difference in potentials creates a 60Hz low-level sound (approximately a low A#), that seems to "hum", hence the name.

It can be caused by adding new components to your system, but that does not imply there is anything electrically wrong with any new component. With the advent of audio/video and home theater systems, the problem has become commonplace. Generally, the cause is the Cable-TV incoming signal line. This new incoming line may add an additional ground at a different potential to the AC line ground of your other equipment (refer to Note 1 and 2 below to troubleshoot a hum problem).

Note 1 Cable TV systems can sometimes contribute to ground loop problems which cause "hum". To determine if your cable system is the contributing factor, disconnect the Cable-TV incoming signal line (round coax, 75Ω) at the wall, or the first component the cable is connected to (i.e. the cable box, or VCR). If the hum is no longer present, you must insert a "75Ω Ground Loop Isolator" before reconnecting the line. You should check with your ADCOM Dealer to obtain one. If the "75Ω Ground Loop Isolator" works only partially or not at all, then please read Note 2 to complete the troubleshooting procedure.

Note 2 Make sure that the power amplifier is at least 6" from the Preamp and/or Processor. Usually putting another component between them is sufficient to minimize the hum. If this does not reduce the hum, turn the system off and disconnect all Inputs from the amplifier. Turn the amplifier on, if the hum still persists, then your Dealer or Service Center must examine the amplifier. If the hum disappears, try a different set of RCA cables. Connect one RCA cable at a time to see if one specific cable is responsible. If any or all cables cause the hum to appear, then the preamp or processor should be evaluated for proper operation by your Dealer or Authorized Service Center.

CARING FOR YOUR GFA-555se

Great care has been taken by ADCOM to ensure that your amplifier is as flawless in appearance as it is electronically. The front panel is a heavy-gauge, high-grade aluminum extrusion carefully finished and anodized for durability. The chassis, top cover and rear panel are heavy-gauge steel that has been powder coated and baked to ensure a lasting finish. If the front panel, top or sides become dusty or fingerprinted, they can be cleaned with a soft lint-free cloth, slightly dampened with a very mild detergent solution or glass cleaner.

Do not spray or pour liquids of any kind directly onto the GFA-555se.

SERVICING

ADCOM has a Technical Service Department to answer questions pertinent to the installation and operation of your unit. In the event of difficulty, please contact us for prompt advice. If your problem cannot be resolved through our combined efforts, we may refer you to an authorized repair agency, or authorize return of the unit to our warehouse. To aid us in directing you to a convenient service center, it would be helpful if you indicate which major city is accessible to your home.

Please address mail inquires to:

ADCOM Service
8541 East Anderson Drive, Suite 101
Scottsdale, Arizona 85255 USA

Phone, Fax or e-mail inquires to:

Voice: (480) 607-2277
Fax: (480) 348-9876
Monday through Friday
9:00 AM to 5:00 PM MST
E-mail: service@asi-pro.com

For Fax inquires, please include a return Fax number for the reply.

When calling or writing about your GFA-555se, be sure to note and refer to its serial number as well as the date of purchase and the dealer from whom it was purchased. In any communications to us, please include a daytime phone number where we may reach you. In the event the unit must be returned to our factory for service, you will be instructed on the proper procedure when you call or write for a Return Authorization. **UNDER NO CIRCUMSTANCES SHOULD YOUR UNIT BE SHIPPED TO OUR FACTORY WITHOUT PRIOR AUTHORIZATION, OR PACKED IN OTHER THAN ITS ORIGINAL CARTON AND FILLERS.**

If the original shipping carton and its fillers have been lost, discarded, or damaged, a duplicate carton may be obtained from our Service Department for a nominal charge.

Always ship PREPAID VIA UNITED PARCEL SERVICE (UPS) OR OTHER APPROVED CARRIER. DO NOT SHIP VIA PARCEL POST, since the packing was not designed to withstand rough Parcel Post handling.

**FREIGHT COLLECT SHIPMENTS WILL NOT BE ACCEPTED
UNDER ANY CIRCUMSTANCES.**

GFA-555se SPECIFICATIONS

Power Rating (To FTC Requirements)

200 Watts continuous average power into 8 ohms at any frequency between 20Hz and 20kHz with both channels driven at less than 0.04% THD.

300 Watts continuous average power into 4 ohms at any frequency between 20Hz and 20kHz with both channels driven at less than 0.04% THD. *

600 Watts continuous average power into 8 ohms at any frequency between 20Hz and 20kHz at less than 0.09% THD, bridged. *

IM Distortion (SMPTE)

1 watt to 200 watts into 8 ohms. ≤ 0.009%
 1 watt to 300 watts into 4 ohms. ≤ 0.009%

IM Distortion (CCIF, Any Combination from 4kHz to 20kHz)

200 watts into 8 ohms. ≤ 0.002%
 300 watts into 4 ohms. ≤ 0.003%

THD + Noise at 200 watts into 8 Ohms (Typical)

20Hz. 0.004%
 1kHz. 0.003%
 10kHz. 0.006%
 20kHz. 0.010%

THD + Noise at 300 watts into 4 Ohms (Typical)

20Hz. 0.005%
 1 kHz. 0.004%
 10kHz. 0.015%
 20kHz. 0.025%

IM Distortion, Bridged (SMPTE)

1 watt to 600 watts into 8 ohms. ≤ 0.05%
 1 watt to 850 watts into 4 ohms. ≤ 0.05%

IM Distortion (CCIF, Any Combination from 4kHz to 20kHz)

600 watts into 8 ohms. ≤ 0.005%
 850 watts into 4 ohms. ≤ 0.005%

THD + Noise at 600 watts into 8 Ohms, Bridged (Typical)

20Hz. 0.004%
 1kHz. 0.004%
 10kHz. 0.02%
 20kHz. 0.04%

Frequency Response @ 1 Watt into 8 Ohms

10Hz to 20kHz. +0, -0.25dB

Power Bandwidth (-3dB). 10Hz to 100kHz

Dynamic Headroom Into 4 Ohms (1.7dB typical).. 2.5dB*

Signal to Noise Ratio, "A" Weighted

200 watts into 8 ohms. ≥ 110dB

Gain. 27dB

Input impedance. 10k ohms balanced; 100k ohms unbalanced

* With supplemental cooling system.

Input Sensitivity	
200 watts into 8 ohms.	1.75V rms
1 watt into 8 ohms.	130mV rms
Damping Factor	
20Hz to 20kHz.	≥ 900
Rise Time	
5kHz, 120V peak-to-peak square wave, 20% to 80%.	2.3μS
Power Consumption (Continuous, Both Channels Driven)	
Quiescent.	72VA
Maximum.	1500VA
200 watts into 8 ohms.	675VA
325 watts into 4 ohms.	1180VA
600 watts into 8 ohms, bridged.	1320VA

General

Power (available in 230V by special order).	120VAC—50/60Hz
Chassis Dimension.	6-15/16" (176mm) x 12-1/8" (308mm) x 16-15/16" (430mm)
Maximum Dimensions.	7-1/2" (191mm) x 12-1/2" (318mm) x 17" (432mm)
Weight.	36 lbs. (16.3kg)
Weight, Packed.	40 lbs. (18.1kg)

Specifications subject to change without notice.

Copyrights/Trademarks

Published by Advanced Sound and Image | Copyright © 2008 Advanced Sound and Image, LLC | All rights reserved

Adcom and the Adcom logo are registered trademarks of Advanced Sound and Image, LLC

No part of this manual may be reproduced or electronically transmitted without the express written consent of Advanced Sound and Image, LLC. Advanced Sound and Image, LLC shall not be liable for any errors contained herein or for any damages arising out of or related to this document or the information contained herein, even if Advanced Sound and Image, LLC has been advised of the possibility of such damages. This document is intended for informational and instructional purposes only. Advanced Sound and Image, LLC reserves the right to make changes in the specifications and other information contained in this document without prior notification. Advanced Sound and Image, LLC disclaims any obligation to update the information contained herein.



8541 East Anderson Drive, Suite 101
Scottsdale, Arizona 85255
Voice: 480.607.2277
Fax: 480.348.9876
www.adcom.com

Free Manuals Download Website

<http://myh66.com>

<http://usermanuals.us>

<http://www.somanuals.com>

<http://www.4manuals.cc>

<http://www.manual-lib.com>

<http://www.404manual.com>

<http://www.luxmanual.com>

<http://aubethermostatmanual.com>

Golf course search by state

<http://golfingnear.com>

Email search by domain

<http://emailbydomain.com>

Auto manuals search

<http://auto.somanuals.com>

TV manuals search

<http://tv.somanuals.com>