

APH 9190
19" wide screen high brightness LCD
Industrial panel mount monitor

User Manual

APH9190: 19" wide screen industrial panel mount LCD Panel

Table of Contents

CHAPTER 1 Introduction

1-1	Important Safeguards.....	1
1-2	Before Installation.....	2
1-3	Unpacking.....	2
1-4	Optional Accessories.....	2

CHAPTER 2 Front Aluminum LCD Panel

2-1	Package Contents.....	3
2-2	Structure Diagram.....	4
2-3	Mounting Method.....	5

CHAPTER 3 Connection

3-1	On-Screen Display Operation.....	7
3-2	On-Screen Menu.....	9

CHAPTER 4 Operation

4-1	LCD Specifications.....	11
-----	-------------------------	----

CHAPTER 5 AV/BNC Options

5-1	AV/BNC Options.....	12
-----	---------------------	----

CHAPTER 6 Touchscreen Options

6-1	Touchscreen Options.....	13
6-2	Touchscreen Quick User Guidelines.....	15

CHAPTER 7 DC Power Options.....18

CHAPTER 8 TV Turner Options

8-1	How to Use Remote controller.....	19
-----	-----------------------------------	----

CHAPTER 9 Audio Input Options.....21

CHAPTER 10 Quad Display Options

9-1	Specifications.....	22
-----	---------------------	----

CHAPTER 11 Troubleshooting.....24

CHAPTER 12 Cleaning the LCD Display.....25



APH 9190

19" wide screen high brightness LCD
Industrial panel mount monitor

CHAPTER 1 INTRODUCTION

1-1 Important Safeguards

Please read all of these instructions carefully before you use the device. Save this manual for future reference.

What the warranty does not cover:

- Any product, on which the serial number has been defaced, modified or removed.
- Damage, deterioration or malfunction resulting from:
 - Accident, misuse, neglect, fire, water, lightning, or other acts of nature, unauthorized product modification, or failure to follow instructions supplied with the product.
 - Repair or attempted repair by anyone not authorized by us.
 - Any damage of the product due to shipment.
 - Removal or installation of the product.
 - Causes external to the product, such as electric power fluctuation or failure.
 - Use of supplies or parts not meeting our specifications.
 - Normal wear and tear.
 - Any other causes which does not relate to a product defect.
- Removal, installation, and set-up service charges.



APH 9190
19" wide screen high brightness LCD
Industrial panel mount monitor

1-2 Before Installation

- It is very important to locate the LCD Display in a suitable environment.
- The surface for placing and fixing the LCD Display should be stable.
- Make sure the place has good ventilation, is out of direct sunlight, away from sources of excessive dust, dirt, heat, water, moisture and vibration.
- Convenience for connecting the LCD Display to the related facilities should be well considers too.

1-3 Unpacking

The LCD Display comes with the standard parts shown on the package contents. Check and make sure they are included and in good condition. If anything is missing, or damage, contact the supplier immediately.

1-4 Optional Accessories

1. Power Cord

1.1 IEC power cord

1.2 NEMA 5-15 power cord (US)

1.3 BS 1363 power cord (UK)

1.4 CEE 7/4 power cord (German)

1.5 AS 3112 power cord (Australia)



APH 9190

19" wide screen high brightness LCD
Industrial panel mount monitor

CHAPTER 2 FRONT ALUMINUM LCD PANEL

2-1 Package Contents

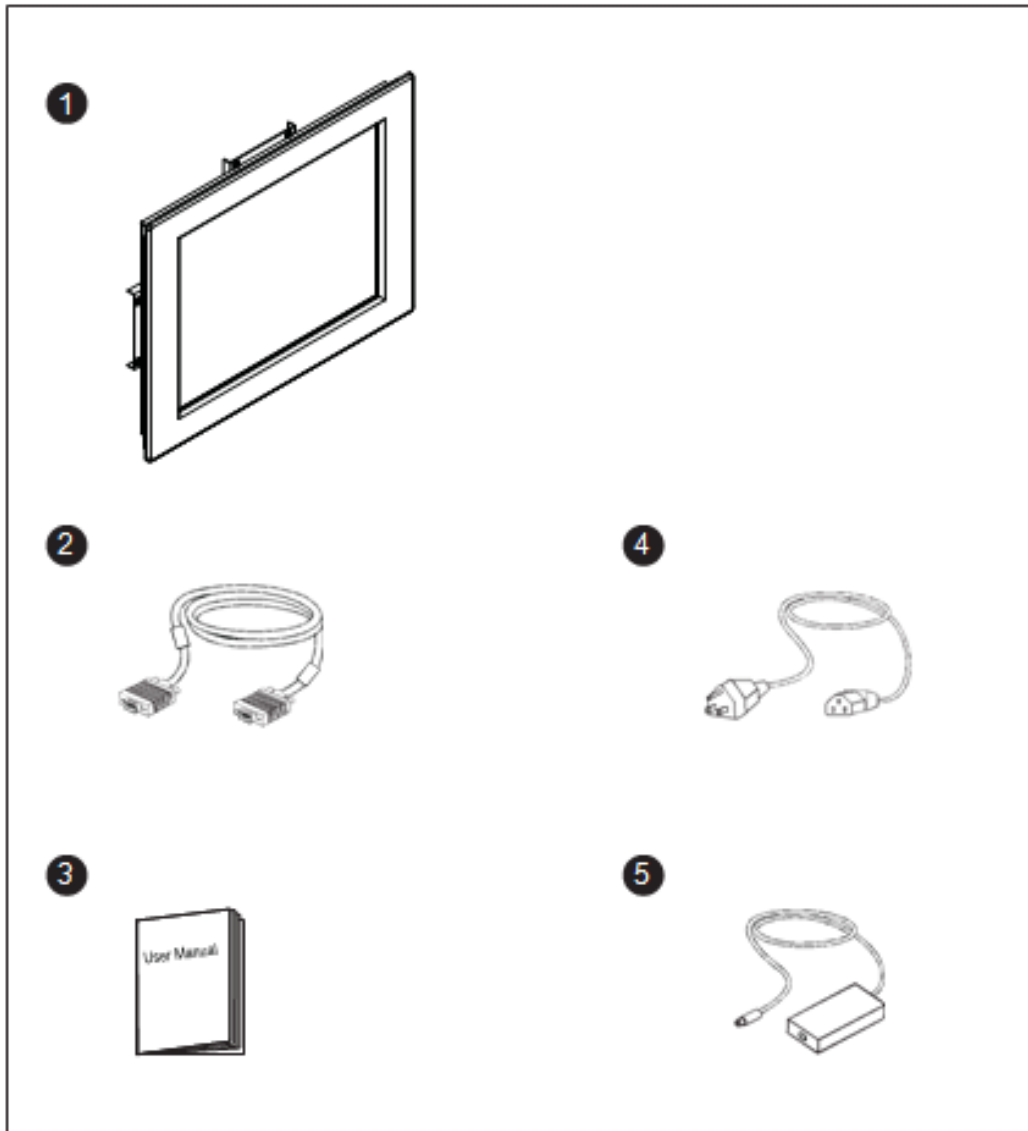

1. LCD Display x 1 pc
2. 6" VGA Cable (male to male) x 1 pc
3. User Manual x 1 pc
4. Power Cord x 1 pc
5. Auto switch Power Adapter x 1 pc

** Remarks: Bracket mounting set is already installed on the back of the LCD panel.

APH 9190
19" wide screen high brightness LCD
Industrial panel mount monitor

2-2 Structure Diagram

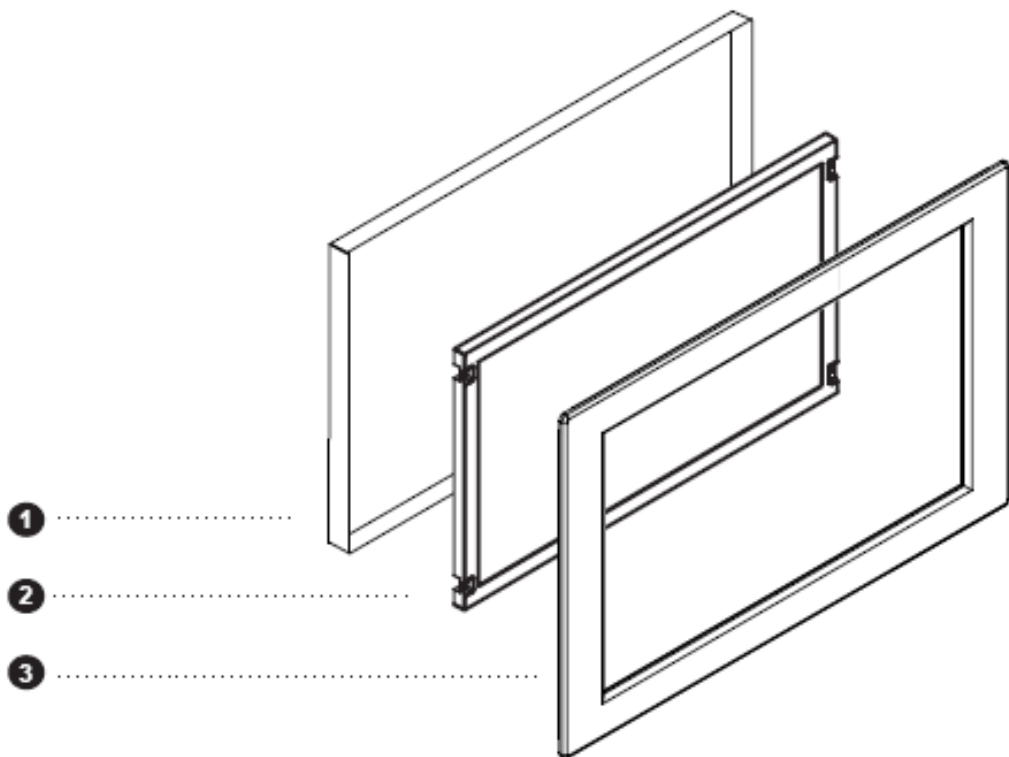

Front View

Rear View

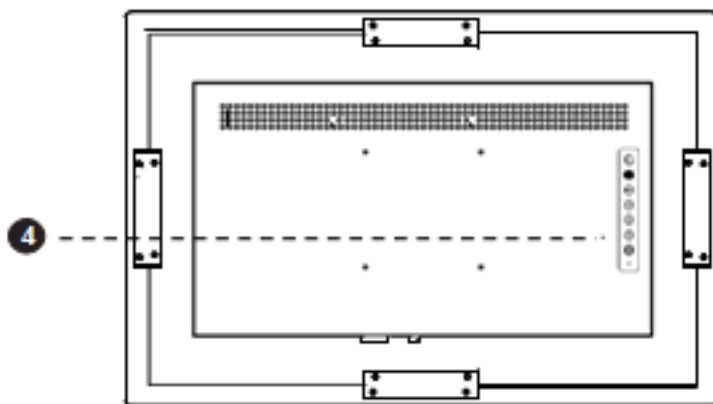
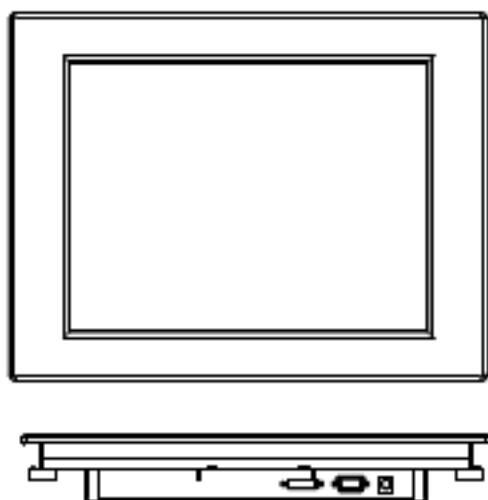

1. Rear Case
2. SAMSUGN class A TFT LCD Panel
3. 6mm Aluminum front Bezel
4. LCD Membrane

APH 9190

19" wide screen high brightness LCD
Industrial panel mount monitor

2-3 Mounting Method

Bracket Mounting

1



x 4 pcs

Mounting bracket

2



x 8 pcs

M4*6mm screw

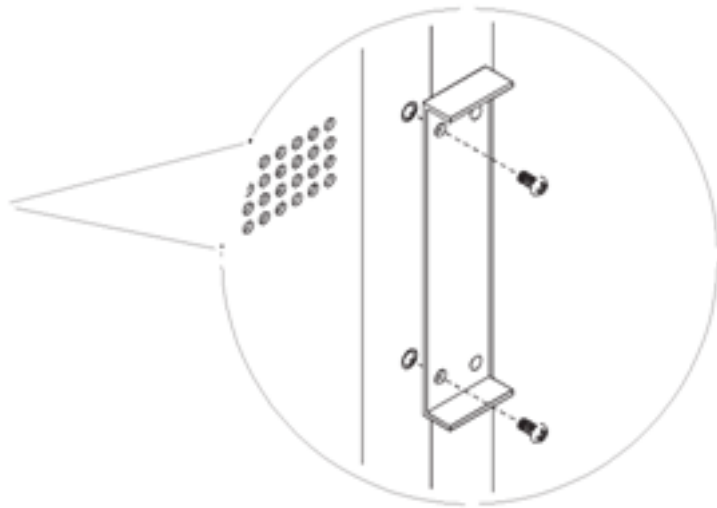
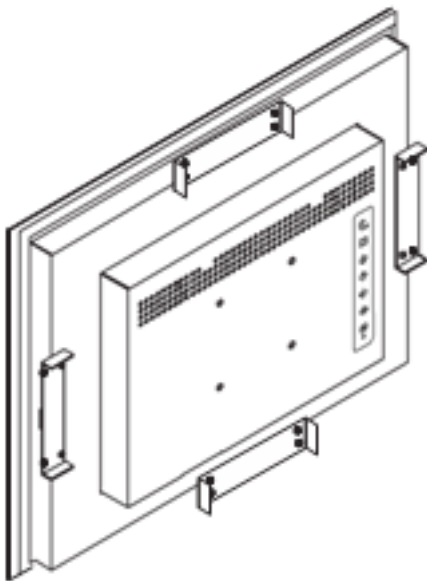

** Remarks: Bracket mounting set is already installed on the back of the LCD panel.

ACNODES

661 Brea Canyon Rd., Suite 3
Walnut, CA 91789
tel: 909.598.7388, fax: 909.598.0218

© Copyright 2011 Acnodes, Inc.
All rights reserved. Product description and product specifications
are subject to change without notice. For latest product information,
please visit Acnodes' web site at www.acnodes.com.

APH 9190
19" wide screen high brightness LCD
Industrial panel mount monitor

100mm VESA Standard:

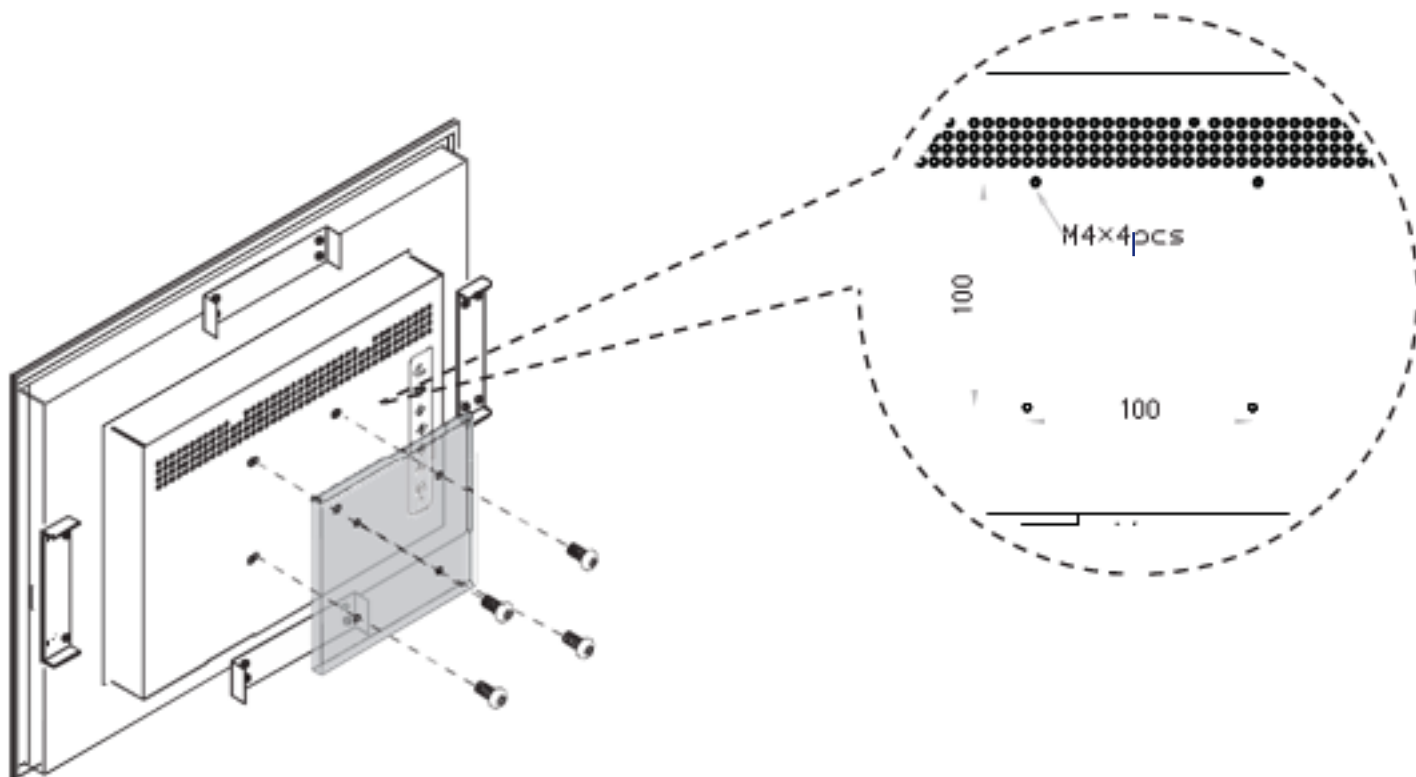

** Remarks:

- Hardware and M4*4 pcs for VESA mounting is not provided
- To avoid damage of internal components, when mounting the VESA bracket, do not use screws that exceed the depth (6mm) of the display mounting holes. Using screws that are too long may cause damage to your display.

APH 9190

19" wide screen high brightness LCD
Industrial panel mount monitor

CHAPTER 3 CONNECTION

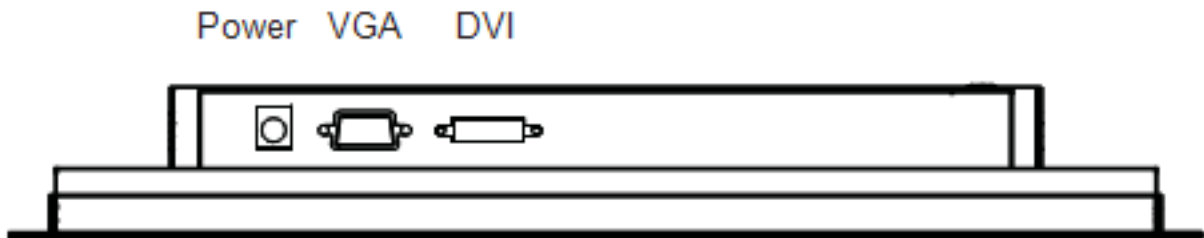





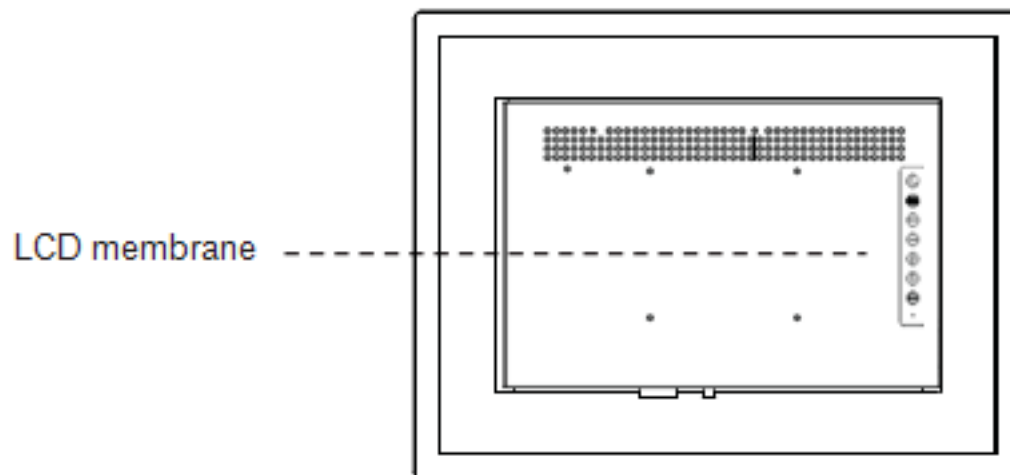

Caution: The LCD Display is hot-pluggable, but components of connected devices may not be hot-pluggable. Plugging and unplugging cables while connected devices are powered on may cause irreversible damage of the devices and LCD Display. Before attempting to connect anything to the LCD Display, we suggest that turn off power to all devices before connecting them. Apply power to connected devices again only after the LCD Display receiving power. The company is not responsible for damage caused in this way.

3-1 On-Screen Display Operation



APH 9190
19" wide screen high brightness LCD
Industrial panel mount monitor

Membrane Switch	Function
	Power light Green = On Orange = Power saving
	Power on / off LCD
	Display the OSD menu
	Scrolls through menu options and adjusts the displayed control (To auto adjustment by pressing the button  for 5 seconds)
	Exit the OSD screen Toggle analog, digital & video connection (DVI-D and video options only)

3-2 On-Screen Menu

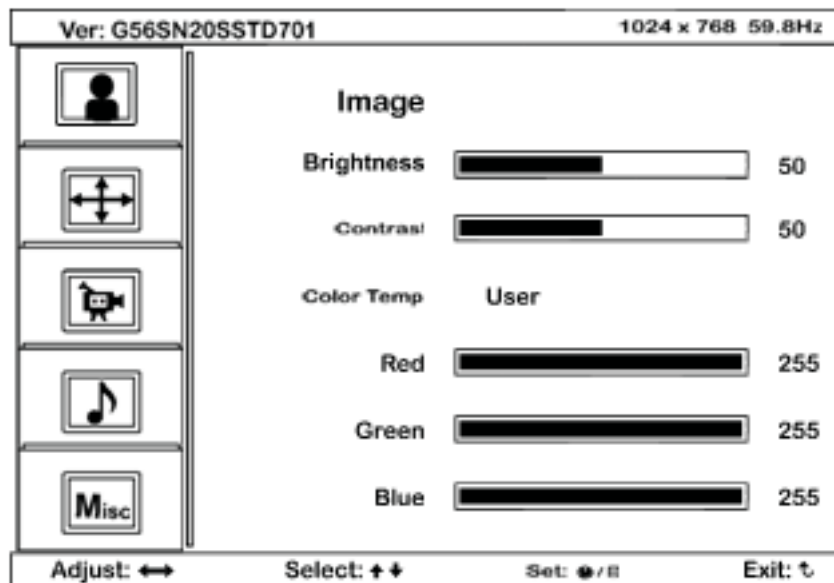



APH 9190

19" wide screen high brightness LCD
Industrial panel mount monitor



Image:

To enter into the brightness, contrast, color temp, red, green, and blue

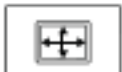

Geometry:

To enter into the auto adjust, H position, V position, phase and clock



Video:

To enter into the colour, tint, sharpness, noise reduction, DCDi and TV Setup



Audio:

To enter into volume, bass, treble, balance, AVL and mute



Misc:

To enter into the language, OSD position, graphic mode, ratio, reset and timer

APH 9190
19" wide screen high brightness LCD
Industrial panel mount monitor

CHAPTER 4 OPERATION

4-1 LCD Specifications

Item	Description
LCD Manufacturer	
Diagonal Size	Wide 19" TFT
Max. Resolution	1440 x 900
Brightness (cd/m ²)	800
Color Support	16.7M
Contrast Ratio (typ.)	900:1
Viewing Angle (H/V)	160° x 160°
Display Area (mm)	408 x 225
Tr Response Time (ms)	1.3
LCD Panel MTBF (hrs)	70,000
Display Input Signal	Analog RGB
Connector	DB-15 connector
Power Input	Auto-sensing 100 to 240VAC, 50 / 60Hz
Power Consumption	Max. 84 Watt, Standby 5 Watt
Compatibility	Multi-platform - Mix PCs, SUNs, IBMs, HPs & DELLs.

Options

Graphic Input	S-Video & BNC input
DC Power	DC power input with 12V, 24V, 48V selection
Touchscreen	Resistive and capacitive

Environmental

Operation	0° to 50°C Degree
Storage	-5° to 60°C Degree
Relative Humidity	5~90%, non-condensing
Shock	10G acceleration (11ms duration)
Vibration	5~500Hz 1G RMS random vibration

APH 9190

19" wide screen high brightness LCD
Industrial panel mount monitor

CHAPTER 5 AV/ BNC OPTIONS

5-1 AV/BNC Options

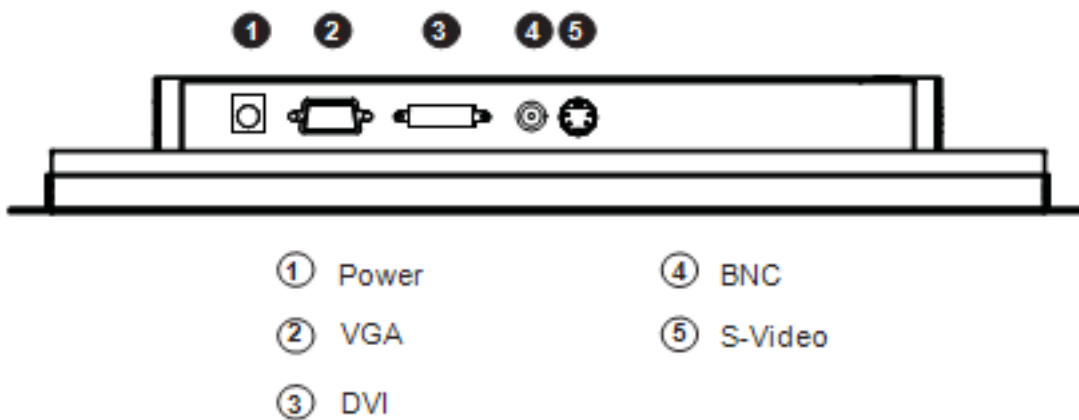

** Remarks: Package includes 1x 6ft S-Video cable

The image shows a 19-inch wide screen high brightness LCD industrial panel mount monitor. The background is a blue gradient with a faint image of a circuit board on the left side.

APH 9190

19" wide screen high brightness LCD
Industrial panel mount monitor

e-Resistive:

Model	-19WTRB / -19WTRS
Screen size	19" wide
Interface	USB / serial
Optical transmittance	80% ± 3%
Surface hardness	≥3H (JIS K5400)
Operating system	Windows 98 / 2000 / ME / XP / NT / CE, DOS, Linux

e-Capacitive:

Model	-19WTCB / -19WTCS
Screen size	19" wide
Interface	USB / serial
Optical transmittance	93% ± 2%
Surface hardness	>9H Surface hardness, withstand over 300 million touches
Operating system	Windows 98 / 2000 / ME / XP / NT / CE, DOS, Linux

** Remarks:

- USB touchscreen package includes 1 x 6ft USB cable, quick reference guideline and CD disc
- Serial touchscreen package includes 1 x 6ft serial cable, quick reference guideline and CD disc
- For detailed information, please refer to the attached CD disc
- As the touchscreen unit is not made of toughened glass, please handle it carefully

APH 9190
19" wide screen high brightness LCD
Industrial panel mount monitor

6-2 Touchscreen Quick User Guidelines

Calibration:

Tool property page- Calibration, draw test tools and the linearity curve of the touchscreen were list in this property page shown as below for user to do touchscreen calibration and touch position test.

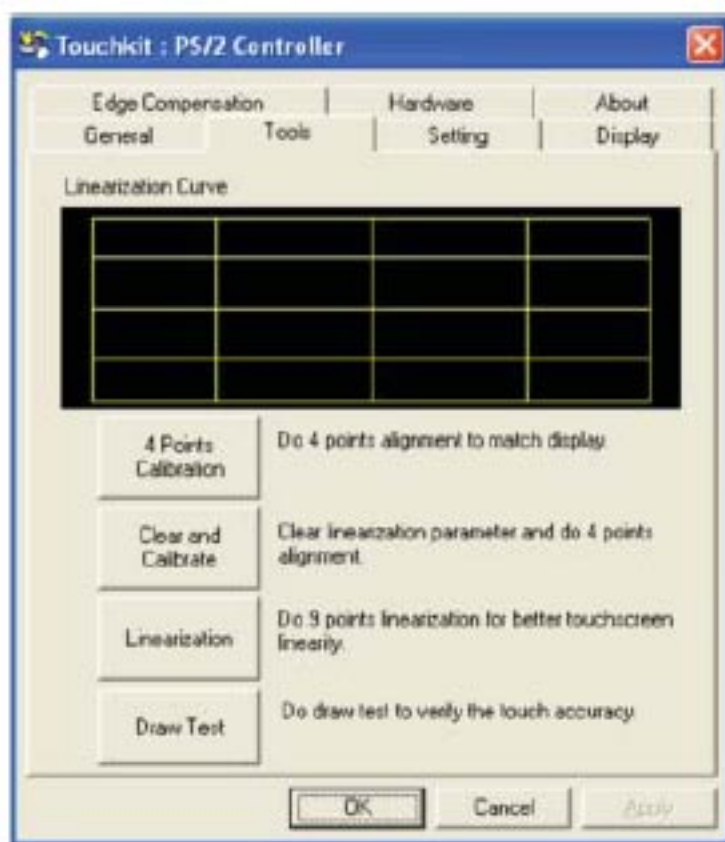

User can do calibration or draw test by pressing the function push buttons.

1. Linearization Curve

Linearization curve of the touchscreen is list in this page for reference and trouble shooting purpose.

APH 9190

19" wide screen high brightness LCD
Industrial panel mount monitor

2. 4 points calibration

It needs calibration before the touchscreen can work accurately. Whenever the user feel the accuracy lost, user can do calibration again to get a more accuracy touch function.

Pressing this button, a new window will be popped-up at the location when the touchscreen was mapped to area for this touch system to guide the user do 4 points calibration.

User should follows the guide to touch and hold the blinking X symbol in the calibration window until it does not blink to make sure that the utility can gather enough data for computation. In addition, a time line bar is shown in the bottom of the window to indicate time elapsed. If the touchscreen was not touched before the time line bar going to right end, the calibration task will be terminated automatically.

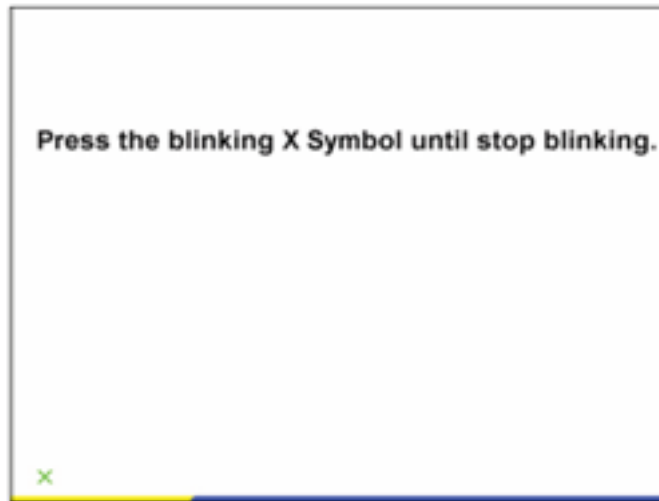

3. Clear and Calibration

Press this button to erase the 25 points calibration/linearization parameters and force user to do 4 points calibration again. After 25 points calibration data was clear, the 4 points calibration data will be invalid. It needs to do 4 points calibration.

4. Linearization

Linearization (25 or 9 points calibration) function is used to compensate the touchscreen linearity. After linearization completed, the linearity of the touchscreen will be shown in the Linearity curve window.



APH 9190
19" wide screen high brightness LCD
Industrial panel mount monitor

Pressing this button, a new window will be popped-up at the location when the touchscreen was mapped to area for this touch system to guide the user do 25 points calibration. User should follows the guide to touch and hold the blinking X symbol in the calibration window until it does not blink to make sure that the utility can gather enough data for computation. In addition, a time line bar is shown in the bottom of the window to indicate time elapsed. If the touchscreen was not touched before the time line bar going to right end, the calibration task will be terminated automatically.

5. Draw Test

This function is used for accuracy and performance check. Press this button and a new pop up window will be popped up in the location where the touchscreen was mapped to the touch system as below,

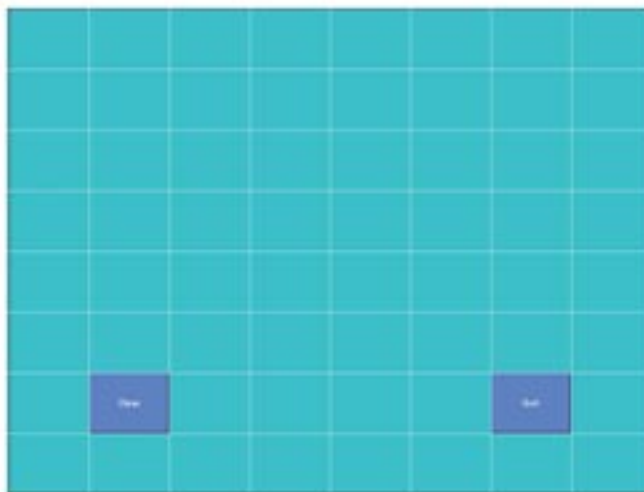

User can press the Clear button to clear the window. Press Quit button to terminate this draw test.



Caution :

- At the first assembly of touch screen, we suggest applying 25 points calibration.
- For a more accurate calibration of touch screen, please apply 25 points calibration.

APH 9190

19" wide screen high brightness LCD
Industrial panel mount monitor

CHAPTER 7 DC POWER OPTIONS

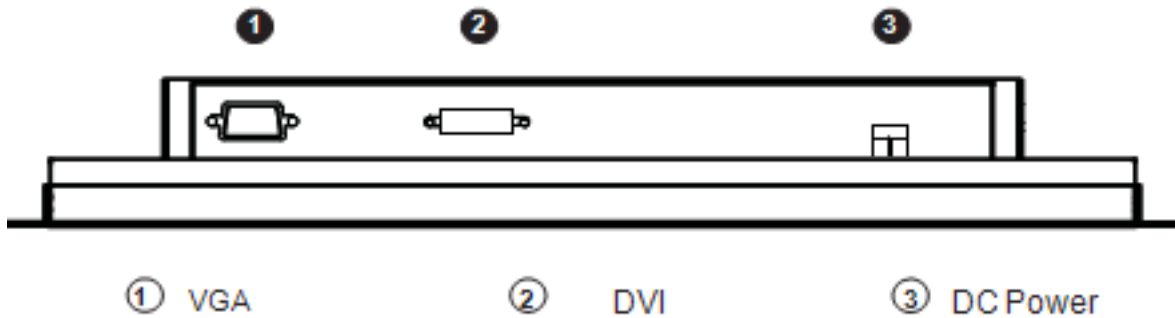

Model	12V	24V	48V
Input rating			
Input voltage:	12-Volt	24-Volt	48-Volt
Input range:	9 ~ 18V	18 ~ 36V	36 ~ 75V
Input current			
- No load	50 mA	50 mA	50 mA
- Full load	4950 mA	2450 mA	1220 mA
Output rating			
Output voltage:	12-Volt	12-Volt	12-Volt
Output current:	4.16A	4.16A	4.16A
Efficiency	84%	85%	85%

** Remarks: Package does not include power cord and AC power adapter

APH 9190
 19" wide screen high brightness LCD
 Industrial panel mount monitor

CHAPTER 8 TV TURNER OPTIONS



- | | | |
|-------------|-----------|---------|
| ① TV | ⑤ Audio-R | ⑨ VGA |
| ② Audio out | ⑥ Video | ⑩ Power |
| ③ Audio in | ⑦ S-Video | |
| ④ Audio-L | ⑧ DVI | |

** Remarks: Package includes 1 x remote controller

8-1 How to use Remote Controller

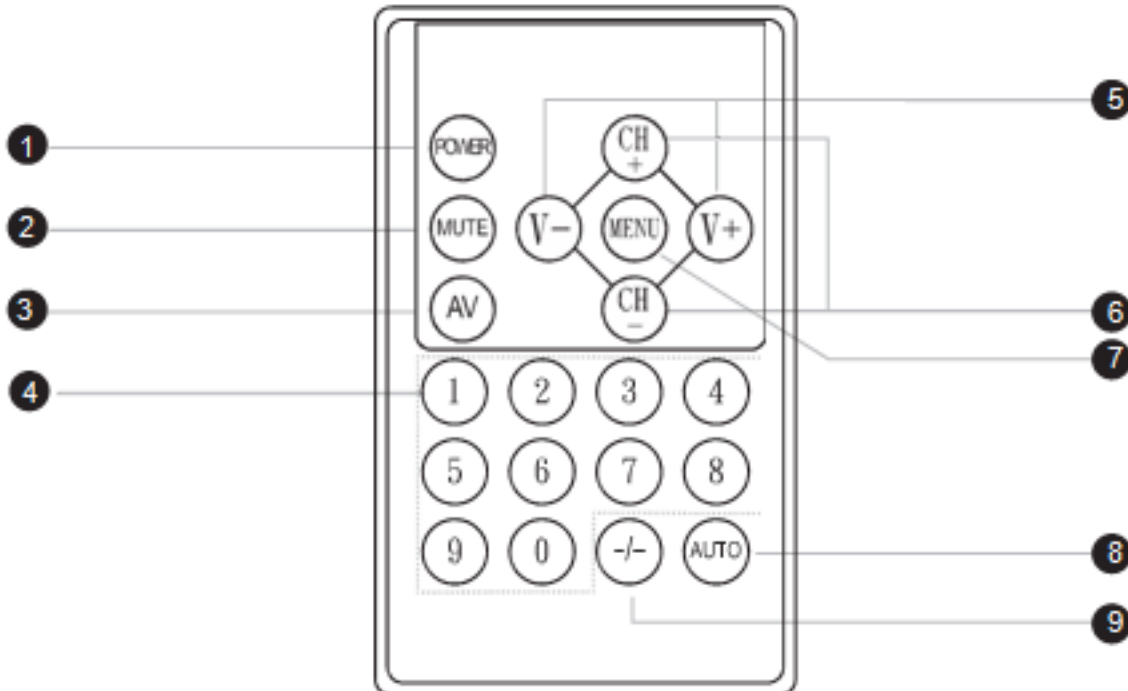



APH 9190

19" wide screen high brightness LCD
Industrial panel mount monitor

①	POWER	Switches on or off the TV
②	MUTE	Turn on or off the speaker
③	AV	Switch to AV mode
④	0-9	Select channels. For channel numbers 10 and above, enter the second digit within two seconds.
⑤	V + / -	Increase or decrease the speaker volume
⑥	CH + / -	Increase or decrease the channel number
⑦	MENU	Display the menu on the screen or go to the previous menu
⑧	AUTO	For auto searching
⑨	- / -	For setting one or two input digit



Caution: ■ The Company reserves the right to modify product specifications without prior notice and assumes no responsibility for any error which may appear in this web page.

APH 9190
19" wide screen high brightness LCD
Industrial panel mount monitor

CHAPTER 9 AUDIO INPUT OPTIONS

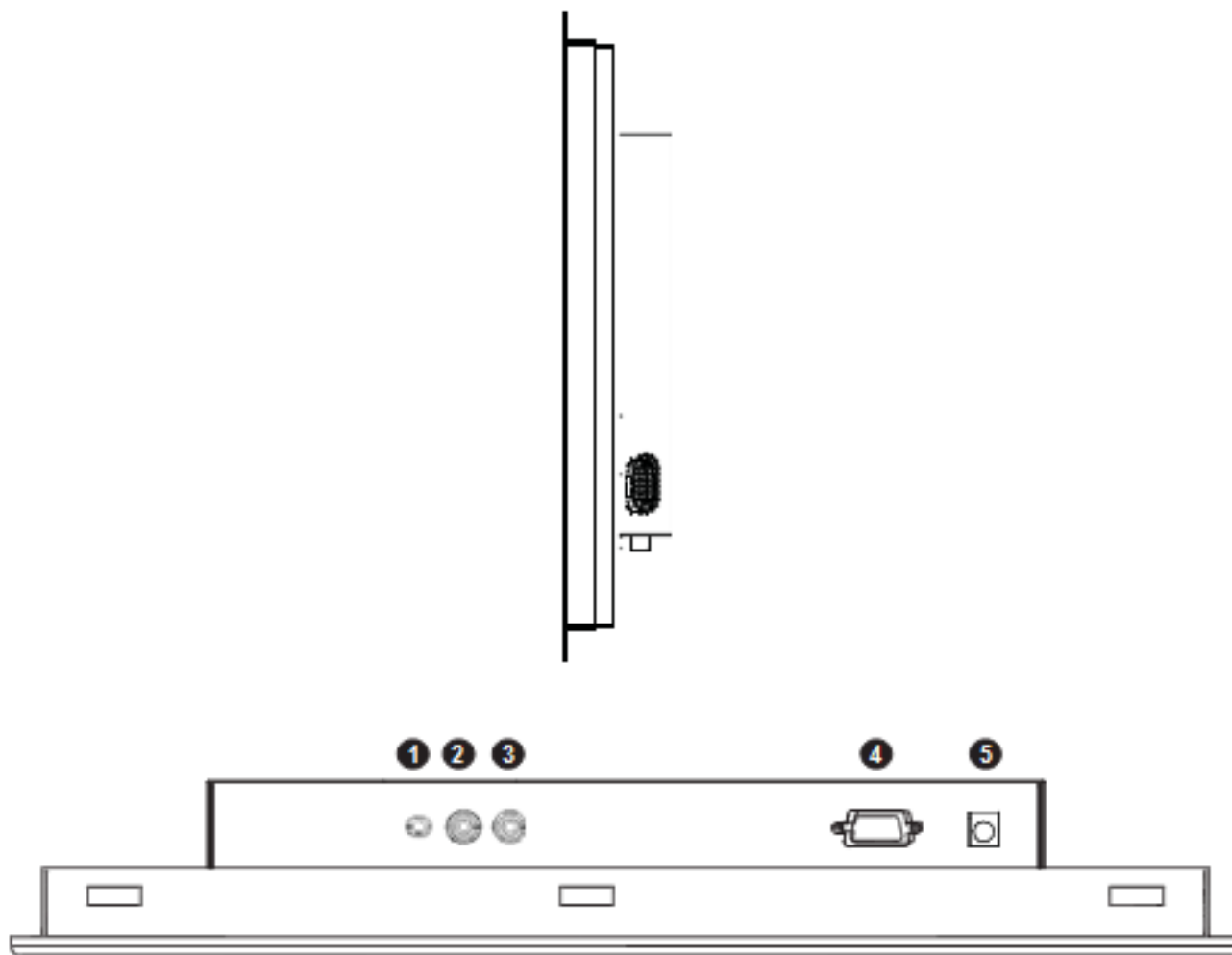

① Audio in

② Audio-L

③ Audio-R

④ VGA

⑤ Power

ACNODES

661 Brea Canyon Rd., Suite 3
Walnut, CA 91789
tel: 909.598.7388, fax: 909.598.0218

© Copyright 2011 Acnodes, Inc.
All rights reserved. Product description and product specifications
are subject to change without notice. For latest product information,
please visit Acnodes' web site at www.acnodes.com.

APH 9190

19" wide screen high brightness LCD
Industrial panel mount monitor

CHAPTER 10 QUAD DISPLAY OPTIONS

10-1 Specifications

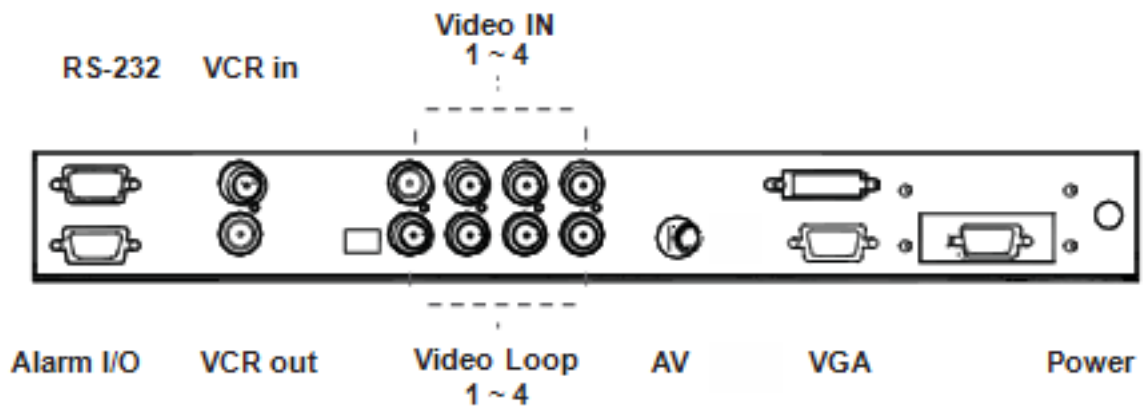

APH 9190
19" wide screen high brightness LCD
Industrial panel mount monitor

Item		Description
Model Number		QD (NTSC) QD (PAL)
Number of Color		16.7 M 16.7 M
Imaging System		NTSC PAL
Resolution		1024 x 525 1024 x 625
Refresh Rate		60 50
Video Input	Camera Input	1.0 Vpp, 75 Ohm x 4
	VCR Input	1.0 Vpp, 75 Ohm x 1
Video Output	Live Monitor	1.0 Vpp, 75 Ohm x 1
	Loop Through Out	1.0 Vpp, 75 Ohm x 4
	VCR Output	1.0 Vpp, 75 Ohm x 1
Auto Gain Control		Yes
Time / Date		Yes
On Screen Display		Yes
Camera Title		8 Character Title
Display Format	2 x Zoom On Playback	Yes
	QUAD	Yes
	FULL	Yes
	SEQUENCY	Yes
Dwell Time		0 to 99 Sec Adjustable
Built-in Buzzer		Yes
Key Lock		Yes

** Remarks:

- For more details, please refer to Quad Display User Manual



APH 9190

19" wide screen high brightness LCD
Industrial panel mount monitor

CHAPTER 11 TROUBLESHOOTING

1. How do I adjust the resolution?

To change monitor resolution, click Start -> Control Panel -> Display. Select Setting tab to adjust the monitor resolution in Desktop Area. The available resolutions, "640 x 480", "800 x 600", "1024 x 768", "1152 x 864", "1280 x 1024", are determined by the display card in your computer.

2. Is interference signal appeared on LCD normal when shutting down the computer ?

In rare cases, interference may appear on the monitor. This may be caused by signal rate of VGA card and is considered normal. The image quality can be improved by adjusting the phase or pixel rate automatically or manually.

3. The membrane power light is not ON

Press the power On / Off on LCD membrane to check if the monitor is in the ON mode. Check the power cord is properly connected to the LCD keyboard drawer and power outlet.

4. Screen image is not centered or sized properly

Press the  button for two seconds to automatically adjust the image. Adjust the H-position and V-position settings via On-screen menu.

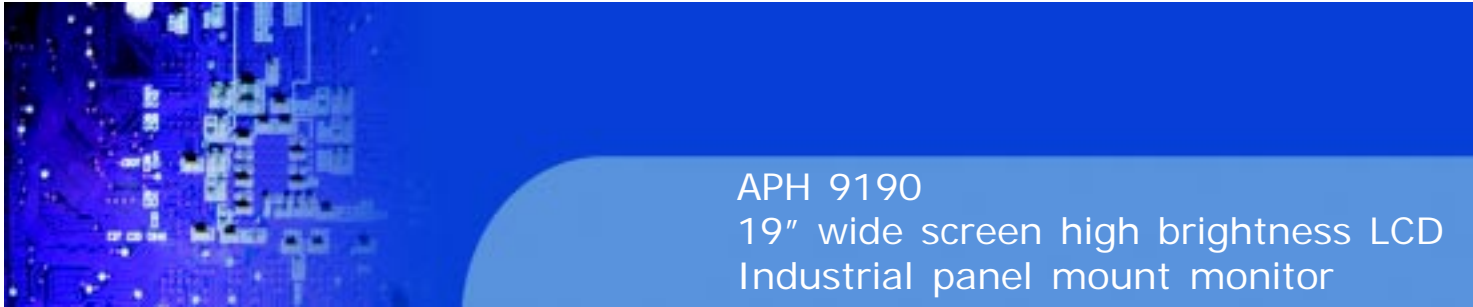

APH 9190
19" wide screen high brightness LCD
Industrial panel mount monitor

CHAPTER 12 CLEANING THE LCD DISPLAY

You may need the following precautions before you begin to clean the LCD display, please read and understand the details below fully.

1. Make sure the monitor is turned off
2. Never spray or pour any liquid onto the screen directly
3. To remove dust and other particles, wipe the screen with a clean, soft, lint-free cloth.
4. Be cautious of all kinds of cleaning solvents or chemicals, some individuals may be harmful to the LCD display.
5. If the LCD display is still not clean enough, apply a small amount of non-ammonia, non-alcohol based glass cleaner onto a clean, soft, lint-free cloth, and wipe the screen.
6. Don't use water or oil on the monitor directly.

Free Manuals Download Website

<http://myh66.com>

<http://usermanuals.us>

<http://www.somanuals.com>

<http://www.4manuals.cc>

<http://www.manual-lib.com>

<http://www.404manual.com>

<http://www.luxmanual.com>

<http://aubethermostatmanual.com>

Golf course search by state

<http://golfingnear.com>

Email search by domain

<http://emailbydomain.com>

Auto manuals search

<http://auto.somanuals.com>

TV manuals search

<http://tv.somanuals.com>