

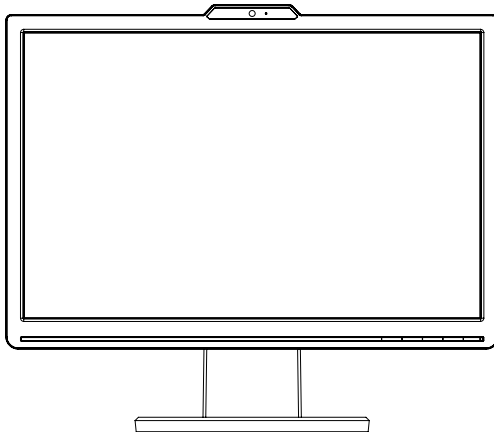

VK191 Series LCD Monitor

User Guide



E3572

First Edition V1
December 2007

Copyright © 2007 ASUSTeK COMPUTER INC. All Rights Reserved.

No part of this manual, including the products and software described in it, may be reproduced, transmitted, transcribed, stored in a retrieval system, or translated into any language in any form or by any means, except documentation kept by the purchaser for backup purposes, without the express written permission of ASUSTeK COMPUTER INC. ("ASUS").

Product warranty or service will not be extended if: (1) the product is repaired, modified or altered, unless such repair, modification or alteration is authorized in writing by ASUS; or (2) the serial number of the product is defaced or missing.

ASUS PROVIDES THIS MANUAL "AS IS" WITHOUT WARRANTY OF ANY KIND, EITHER EXPRESS OR IMPLIED, INCLUDING BUT NOT LIMITED TO THE IMPLIED WARRANTIES OR CONDITIONS OF MERCHANTABILITY OR FITNESS FOR A PARTICULAR PURPOSE. IN NO EVENT SHALL ASUS, ITS DIRECTORS, OFFICERS, EMPLOYEES OR AGENTS BE LIABLE FOR ANY INDIRECT, SPECIAL, INCIDENTAL, OR CONSEQUENTIAL DAMAGES (INCLUDING DAMAGES FOR LOSS OF PROFITS, LOSS OF BUSINESS, LOSS OF USE OR DATA, INTERRUPTION OF BUSINESS AND THE LIKE), EVEN IF ASUS HAS BEEN ADVISED OF THE POSSIBILITY OF SUCH DAMAGES ARISING FROM ANY DEFECT OR ERROR IN THIS MANUAL OR PRODUCT.

SPECIFICATIONS AND INFORMATION CONTAINED IN THIS MANUAL ARE FURNISHED FOR INFORMATIONAL USE ONLY, AND ARE SUBJECT TO CHANGE AT ANY TIME WITHOUT NOTICE, AND SHOULD NOT BE CONSTRUED AS A COMMITMENT BY ASUS. ASUS ASSUMES NO RESPONSIBILITY OR LIABILITY FOR ANY ERRORS OR INACCURACIES THAT MAY APPEAR IN THIS MANUAL, INCLUDING THE PRODUCTS AND SOFTWARE DESCRIBED IN IT.

Products and corporate names appearing in this manual may or may not be registered trademarks or copyrights of their respective companies, and are used only for identification or explanation and to the owners' benefit, without intent to infringe.

Contents

Contents	iii
Notices	iv
Safety information	v
Care & Cleaning	vi
Chapter 1: Product introduction	
1.1 Welcome!	1-1
1.2 Package contents	1-1
1.3 Monitor introduction	1-2
1.3.1 Front view	1-2
1.3.2 Back view	1-3
Chapter 2: Setup	
2.1 Assembling the monitor base	2-1
2.2 Adjusting the monitor	2-1
2.3 Detaching the arm/base (for VESA wall mount)	2-2
2.4 Connecting the cables	2-3
2.5 Turning on the monitor	2-3
2.6 LifeFrame 2 software	2-4
Chapter 3: General instruction	
3.1 OSD (On-Screen Display) menu	3-1
3.1.1 How to reconfigure	3-1
3.1.2 OSD Function Introduction	3-1
3.2 Specifications summary	3-4
3.3 Troubleshooting (FAQ)	3-5
3.4 Supported operating modes	3-6

Notices

Federal Communications Commission Statement

This device complies with Part 15 of the FCC Rules. Operation is subject to the following two conditions:

- This device may not cause harmful interference, and
- This device must accept any interference received including interference that may cause undesired operation.

This equipment has been tested and found to comply with the limits for a Class B digital device, pursuant to Part 15 of the FCC Rules. These limits are designed to provide reasonable protection against harmful interference in a residential installation. This equipment generates, uses and can radiate radio frequency energy and, if not installed and used in accordance with manufacturer's instructions, may cause harmful interference to radio communications. However, there is no guarantee that interference will not occur in a particular installation. If this equipment does cause harmful interference to radio or television reception, which can be determined by turning the equipment off and on, the user is encouraged to try to correct the interference by one or more of the following measures:

- Reorient or relocate the receiving antenna.
- Increase the separation between the equipment and receiver.
- Connect the equipment to an outlet on a circuit different from that to which the receiver is connected.
- Consult the dealer or an experienced radio/TV technician for help.



The use of shielded cables for connection of the monitor to the graphics card is required to assure compliance with FCC regulations. Changes or modifications to this unit not expressly approved by the party responsible for compliance could void the user's authority to operate this equipment.

As an Energy Star® Partner, our company has determined that this product meets the Energy Star® guidelines for energy efficiency.

Canadian Department of Communications Statement

This digital apparatus does not exceed the Class B limits for radio noise emissions from digital apparatus set out in the Radio Interference Regulations of the Canadian Department of Communications.

This class B digital apparatus complies with Canadian ICES-003.

Safety information

- Before setting up the monitor, carefully read all the documentation that came with the package.
- To prevent fire or shock hazard, never expose the monitor to rain or moisture.
- Never try to open the monitor cabinet. The dangerous high voltages inside the monitor may result in serious physical injury.
- If the power supply is broken, do not try to fix it by yourself. Contact a qualified service technician or your retailer.
- Before using the product, make sure all cables are correctly connected and the power cables are not damaged. If you detect any damage, contact your dealer immediately.
- Slots and openings on the back or top of the cabinet are provided for ventilation. Do not block these slots. Never place this product near or over a radiator or heat source unless proper ventilation is provided.
- The monitor should be operated only from the type of power source indicated on the label. If you are not sure of the type of power supply to your home, consult your dealer or local power company.
- Use the appropriate power plug which complies with your local power standard.
- Do not overload power strips and extension cords. Overloading can result in fire or electric shock.
- Avoid dust, humidity, and temperature extremes. Do not place the monitor in any area where it may become wet. Place the monitor on a stable surface.
- Unplug the unit during a lightning storm or if it will not be used for a long period of time. This will protect the monitor from damage due to power surges.
- Never push objects or spill liquid of any kind into the slots on the monitor cabinet.
- To ensure satisfactory operation, use the monitor only with UL listed computers which have appropriate configured receptacles marked between 100-240V AC.
- If you encounter technical problems with the monitor, contact a qualified service technician or your retailer.



This symbol of the crossed out wheeled bin indicates that the product (electrical, electronic equipment, and mercury-containing button cell battery) should not be placed in municipal waste. Please check local regulations for disposal of electronic products.

Care & Cleaning

- Before you lift or reposition your monitor, it is better to disconnect the cables and power cord. Follow the correct lifting techniques when positioning the monitor. When lifting or carrying the monitor, grasp the edges of the monitor. Do not lift the display by the stand or the cord.
- Cleaning. Turn your monitor off and unplug the power cord. Clean the monitor surface with a lint-free, non-abrasive cloth. Stubborn stains may be removed with a cloth dampened with mild cleaner.
- Avoid using a cleaner containing alcohol or acetone. Use a cleaner intended for use with the LCD. Never spray cleaner directly on the screen, as it may drip inside the monitor and cause an electric shock.

The following symptoms are normal with the monitor:

- The screen may flicker during the initial use due to the nature of the fluorescent light. Turn off the Power Switch and turn it on again to make sure that the flicker disappears.
- You may find slightly uneven brightness on the screen depending on the desktop pattern you use.
- When the same image is displayed for hours, an afterimage of the previous screen may remain after switching the image. The screen will recover slowly or you can turn off the Power Switch for hours.
- When the screen becomes black or flashes, or cannot work anymore, contact your dealer or service center to fix it. Do not repair the screen by yourself!

Conventions used in this guide



WARNING: Information to prevent injury to yourself when trying to complete a task.



CAUTION: Information to prevent damage to the components when trying to complete a task.



IMPORTANT: Information that you **MUST** follow to complete a task.



NOTE: Tips and additional information to aid in completing a task.

Where to find more information

Refer to the following sources for additional information and for product and software updates.

1. ASUS websites

The ASUS websites worldwide provide updated information on ASUS hardware and software products. Refer to <http://www.asus.com>

2. Optional documentation

Your product package may include optional documentation that may have been added by your dealer. These documents are not part of the standard package.

1.1 Welcome!

Thank you for purchasing the ASUS® VK191 Series LCD monitor!

The latest widescreen LCD monitor from ASUS provides a crisper, broader, and brighter display, plus a host of features that enhance your viewing experience. Besides, the built-in 1.3 mega-pixel webcam enhances image quality. No need for installing additional communication tools while having a video conference with friends online!

With these features, you can enjoy the convenience and delightful audio-visual experience that the VK191 Series brings you!

1.2 Package contents

Check your VK191 Series LCD monitor package for the following items:

- LCD monitor
- Support CD
- Quick start guide
- Power cord x1
- VGA cable x1
- DVI cable x1 (For some models)
- USB cable x1
- Audio cable x1 (For some models)



If any of the above items is damaged or missing, contact your retailer immediately.

1.3 Monitor introduction

1.3.1 Front view

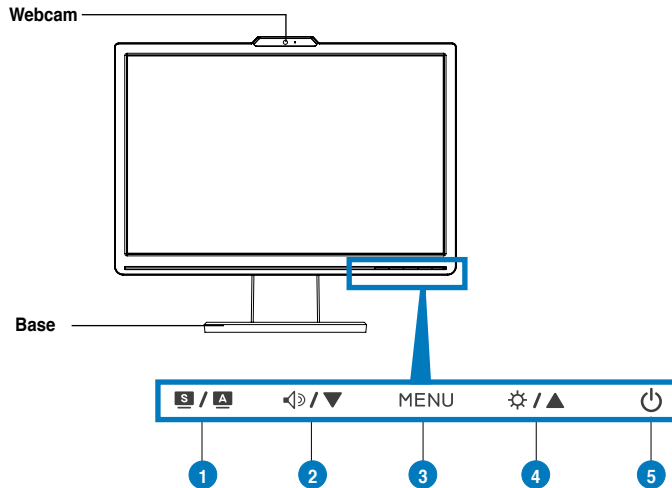

- S / A Button:**
 - Use this hotkey to switch from five video preset modes (Game Mode, Night View Mode, Scenery Mode, Standard Mode, Theater Mode) with SPLENDID™ Video Enhancement Technology.
 - Exit the OSD menu or go back to the previous menu as the OSD menu is active.
 - Automatically adjust the image to its optimized position, clock, and phase by pressing this button for 2-4 seconds (for VGA mode only).
- Left/Down Arrow Button (For those models with speakers):**
 - Press this button to decrease the value of the function selected or move left/down to the next function.
 - This is also a hotkey for Volume adjustment.
- Circle/Down Arrow Button (For those models without speakers):**
 - Press this button to decrease the value of the function selected or move left/down to the previous function.
 - This is also a hotkey for Contrast adjustment.
- MENU Button:**
 - Press this button to enter/select the icon (function) highlighted while the OSD is activated.
- Right/Up Arrow Button:**
 - Press this button to increase the value of the function selected or move right/up to the previous function.
 - This is also a hotkey for Brightness adjustment.

5.  Power button/power indicator
 - Press this button to turn the monitor on/off
 - The color definition of the power indicator is as the below table.

Status	Description
Blue	ON
Amber	Standby mode
OFF	OFF

1.3.2 Back view

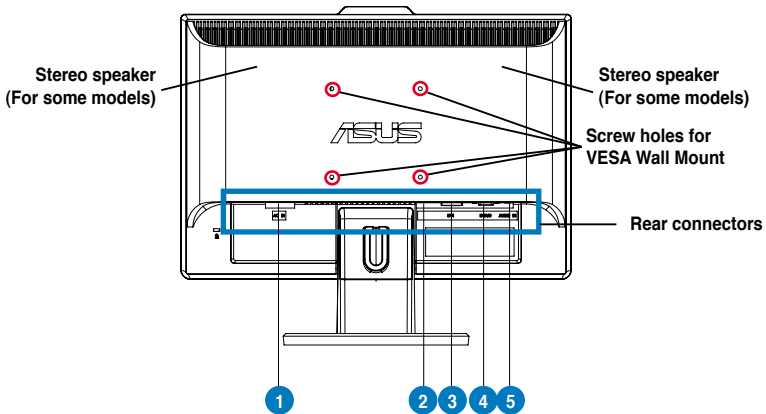

Rear connectors

1. **AC-IN port.** This port connects the power connector from the bundled power cord.
2. **USB 2.0 port.** This port is for the built-in webcam connection.
3. **DVI port (For some models).** This 24-pin port is for PC (Personal Computer) DVI-D digital signal connection.
4. **VGA port.** This 15-pin port is for PC VGA connection.
5. **Audio-in port (For those models with speakers).** This port connects PC audio source by the bundled audio cable.



The VESA wall mount kit (100 mm x 100 mm) is purchased separately.

2.1 Assembling the monitor base

To assemble the monitor base:

1. Have the front of the monitor face down on a table.
2. Connect the base with the arm according to the below drawing. A click shows that the base has been connected successfully.



We recommend that you cover the table surface with soft cloth to prevent damage to the monitor.

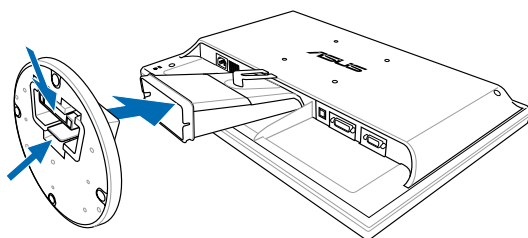

2.2 Adjusting the monitor

- For optimal viewing, we recommend that you look at the full face of the monitor, then adjust the monitor to the angle that is most comfortable for you.
- Hold the stand to prevent the monitor from falling when you change its angle.
- You can adjust the monitor's angle from -5° to 20° .

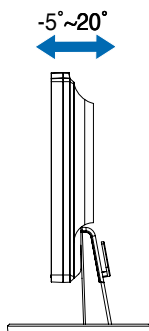

It is normal that the monitor slightly shakes while you adjust the the viewing angle.

2.3 Detaching the arm/base (for VESA wall mount)

The detachable arm/base of the VK191 Series LCD monitor is specially designed for VESA wall mount.

To detach the arm/base:

1. Have the front of the monitor face down on a table.
2. Remove the rubbers in the four screw holes (Figure 1).
3. Follow the direction to remove the back lid (Figure 1). Use a screwdriver to remove the four screws on the arm, then slide out the arm/base to detach it from the monitor (Figure 2).

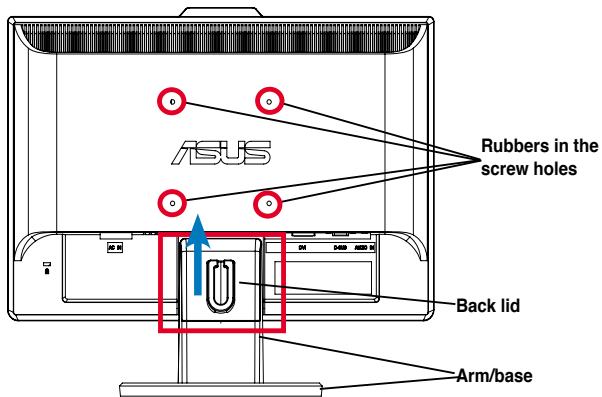

Figure 1

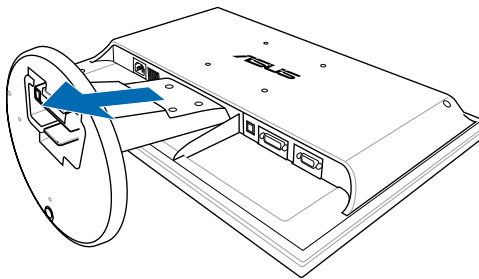

Figure 2



We recommend that you cover the table surface with soft cloth to prevent damage to the monitor.

2.4 Connecting the cables

1. Connect the cables as the following instructions:

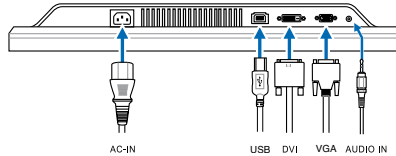

- **To connect the power cord:** connect one end of the power cord securely to the monitor's AC input port, and the other end to a power outlet.
- **To connect the USB cable:** connect one end of the USB cable (upstream) to the monitor's USB port, and the other end to the computer's USB 2.0 port.
- **To connect the VGA/DVI cable:**
 - a. Plug the VGA/DVI connector to the LCD monitor's VGA/DVI port.
 - b. Connect the other end of the VGA/ DVI cable to your computer's VGA/ DVI port.
 - c. Tighten the two screws to secure the VGA/DVI connector.
- **To connect the audio cable (For those models with speakers):** connect one end of the audio cable to the monitor's Audio-in port, and the other end to the computer's audio-out port.



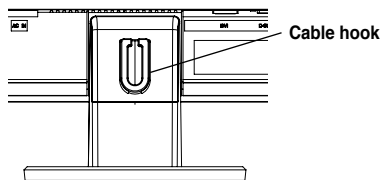

When both the VGA and the DVI cables are connected, you can choose either VGA mode or DVI mode from the Input Select item of the OSD functions.

2. Gather all the cables with the cable hook.



2.5 Turning on the monitor

Gently press the power button . See page 1-2 for the location of the power button. The power indicator  lights up in blue to show that the monitor is ON.

2.6 LifeFrame 2 software

ASUS VK191 provides the easy-to-use LifeFrame 2 software that can work with the webcam, allowing users to create their own photos or video clips.



- LifeFrame 2 only supports Microsoft® Windows® Vista / XP Service Pack 2 operating systems.
- The LifeFrame 2 software is bundled in the support CD.

Installation instructions

1. Close all other applications.
2. Insert the support CD into the optical drive and run the LifeFrame 2 program.
3. Follow the on-screen instructions to complete the installation

3.1 OSD (On-Screen Display) menu

3.1.1 How to reconfigure

1. Press the MENU button to activate the OSD menu.
2. Press ▼ and ▲ to navigate through the functions. Highlight and activate the desired function by pressing the MENU button. If the function selected has a sub-menu, press ▼ and ▲ again to navigate through the sub-menu functions. Highlight and activate the desired sub-menu function by pressing the MENU button.
3. Press ▼ and ▲ to change the settings of the selected function.
4. To exit the OSD menu, press the **S** / **A** button. Repeat step 2 and step 3 to adjust any other function.



3.1.2 OSD Function Introduction

1. Splendid

This function contains five sub-functions you can select for your preference. Each mode has the Reset selection, allowing you to maintain your setting or return to the preset mode.

- **Scenery Mode:** best choice for scenery photo display with SILENDID™ Video Intelligence Technology.
- **Standard Mode:** best choice for document editing with SILENDID™ Video Intelligence Technology.
- **Theater Mode:** best choice for movie with SILENDID™ Video Intelligence Technology.
- **Game Mode:** best choice for game playing with SILENDID™ Video Intelligence Technology.
- **Night View Mode:** best choice for dark-scene game or movie with SILENDID™ Video Intelligence Technology.





- In the Standard Mode, the **Saturation** and **Sharpness** functions are not user-configurable.
- In the other modes, the **sRGB** function is not user-configurable.

2. Image

You can adjust brightness, contrast, sharpness, saturation, position (VGA only), ASCR, and focus (VGA only) from this main function.



- **Brightness:** the adjusting range is from 0 to 100.  is a hotkey to activate this function.
- **Contrast:** the adjusting range is from 0 to 100.  is a hotkey to activate this function (For those models without speakers).
- **ASCR:** turns on/off the ASCR(ASUS Smart Contrast Ratio) function.
- **Sharpness:** the adjusting range is from 0 to 100.
- **Saturation:** the adjusting range is from 0 to 100.
- **Position:** adjusts the horizontal position (H-Position) and the vertical position (V-Position) of the image. The adjusting range is from 0 to 100.
- **Focus:** reduces Horizontal-line noise and Vertical-line noise of the image by adjusting (Phase) and (Clock) separately. The adjusting range is from 0 to 100.



- Phase adjusts the phase of the pixel clock signal. With a wrong phase adjustment, the screen shows horizontal disturbances.
- Clock (pixel frequency) controls the number of pixels scanned by one horizontal sweep. If the frequency is not correct, the screen shows vertical stripes and the image is not proportional.

3. Color

Select the image color you like from this function.



- **Color Temp.:** contains five color modes including Cool, Normal, Warm, sRGB, and User mode.
- **Skin Tone:** contains three color modes including Reddish, Natural, and Yellowish.



In the User mode, colors of R (Red), G (Green), and B (Blue) are user-configurable; the adjusting range is from 0-100.

4. Input Select

In this function, you can select either VGA or DVI input source.

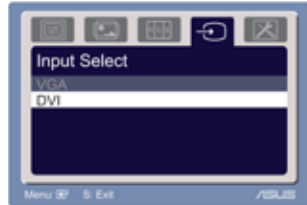

5. System Setup

Allow you to adjust the system.

- **Volume:** the adjusting range is from 0 to 100. ⏪ / ▼ is a hotkey to activate this function (For those models with speakers.).
- **OSD Setup:**

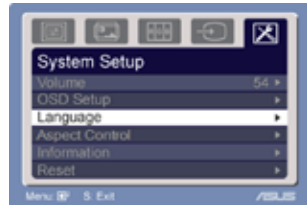





- *Adjusts the horizontal position (H-Position)/ the vertical position (V-Position) of the OSD from 0 to 100.
- *Adjusts the OSD timeout from 10 to 120.
- *Enables or disables the DDC/CI function.
- **Language:** there are ten languages for your selection, including English, German, Italian, French, Dutch, Spanish, Russian, Traditional Chinese, Simplified Chinese, and Japanese.
- **Aspect Control:** adjusts the aspect ratio to "Full" or "4:3".
- **Information:** shows the monitor information.
- **Reset:** "Yes" allows you to restore the default setting.

3.2 Specifications summary

Panel Type	TFT LCD
Panel size	19" wide screen
Max. Resolution	WXGA+ 1440 x 900
Brightness	300cd/m ²
Contrast Ratio (Typ.) / (Max.)	1000:1 / 3000:1 (with ASCR ON)
Viewing angle(H/V) CR>10	160°/160°
Display colors	16.7M
Response time	5ms
Webcam	1.3 Mega pixel / VGA (VK191D only)
SPLENDID™ Video Intelligence Technology	Yes
SPLENDID™ selection	5 video preset modes (by hotkey)
Auto adjustment	Yes (by hotkey)
Color temperature selection	5 color temperatures
Skin-Tone selection	3 skin-tones
Digital input	DVI-D with HDCP (VK191T / VK191N)
Analog input	D-Sub
Audio-in port	3.5 mm Mini-jack (VK191T / VK191S)
Color	Black
Speaker (Built-in)	1W x 2 Stereo, RMS (VK191T / VK191S)
Power LED	Blue (On)/ Amber (Standby)
VESA wall mount	100 x 100mm (purchased separately)
Tilt	-5° ~+20°
Kensington lock	Yes
Voltage rating	AC: 100~240V

*Specifications are subject to change without notice.

3.3 Troubleshooting (FAQ)

Problem	Possible Solution
Power LED is not ON	<ul style="list-style-type: none"> Press the  button to check if the monitor is in the ON mode. Check if the power cord is properly connected to the monitor and the power outlet.
The power LED lights amber and there is no screen image	<ul style="list-style-type: none"> Check if the monitor and the computer are in the ON mode. Make sure the signal cable is properly connected to the monitor and the computer. Inspect the signal cable and make sure none of the pins are bent. Connect the computer with another available monitor to check if the computer is properly working.
Screen image is too light or dark	<ul style="list-style-type: none"> Adjust the Contrast and Brightness settings via OSD.
Screen image is not centered or sized properly	<ul style="list-style-type: none"> Press the  /  button for 2–3 seconds to automatically adjust the image (VGA input only). Adjust the H-Position or V-Position settings via OSD (VGA input only).
Screen image bounces or a wave pattern is present in the image	<ul style="list-style-type: none"> Make sure the signal cable is properly connected to the monitor and the computer. Move away electrical devices that may cause electrical interference.
Screen image has color defects (white does not look white)	<ul style="list-style-type: none"> Inspect the signal cable and make sure that none of the pins are bent. Perform All Reset via OSD. Adjust the R/G/B color settings or select the Color Temperature via OSD.
Screen image is blurry or fuzzy	<ul style="list-style-type: none"> Press the  /  button for 2–3 seconds to automatically adjust the image (VGA input only). Adjust the Phase and Clock settings via OSD (VGA input only).
No sound or sound is low	<ul style="list-style-type: none"> Ensure that the audio cable is properly connected to the monitor and the computer. Adjust the volume settings of both your monitor and computer. Ensure that the computer sound card driver is properly installed and activated.
Webcam is not working	<ul style="list-style-type: none"> Make sure that you have connected the USB cable securely to both the LCD monitor and your computer. Make sure that you use the Microsoft® Windows® Vista / XP Service Pack 2 operating systems.

3.4 Supported operating modes

Resolution	Refresh Rate	Horizontal Frequency
640 x 480	60 Hz	31.5 kHz
640 x 480	72 Hz	37.9 kHz
640 x 480	75 Hz	37.5 kHz
800 x 600	56 Hz	35.1 kHz
800 x 600	60 Hz	37.9 kHz
800 x 600	75 Hz	46.9 kHz
1024 x 768	60 Hz	48.4 kHz
1024 x 768	70 Hz	56.5 kHz
1152 x 864	75 Hz	60.0 kHz
1280 x 720	60 Hz	44.7 kHz
1280 x 768	60 Hz	47.4 kHz
1280 x 768	60 Hz	47.8 kHz
1280 x 768	75 Hz	60.3 kHz
1280 x 800	60 Hz	49.6 kHz
1280 x 960	60 Hz	60.0 kHz
1280 x 1024	60 Hz	64.0 kHz
1360 x 768	60 Hz	47.7 kHz
1440 x 900	60 Hz	55.5 kHz
1440 x 900	60 Hz	59.9 kHz

* Modes not listed in the table may not be supported. For optimal resolution, we recommend that you choose a mode listed in the table above.

Free Manuals Download Website

<http://myh66.com>

<http://usermanuals.us>

<http://www.somanuals.com>

<http://www.4manuals.cc>

<http://www.manual-lib.com>

<http://www.404manual.com>

<http://www.luxmanual.com>

<http://aubethermostatmanual.com>

Golf course search by state

<http://golfingnear.com>

Email search by domain

<http://emailbydomain.com>

Auto manuals search

<http://auto.somanuals.com>

TV manuals search

<http://tv.somanuals.com>