

AEG

ADVANCED ENGINEERING FROM GERMANY

MCD_274

Microwave oven

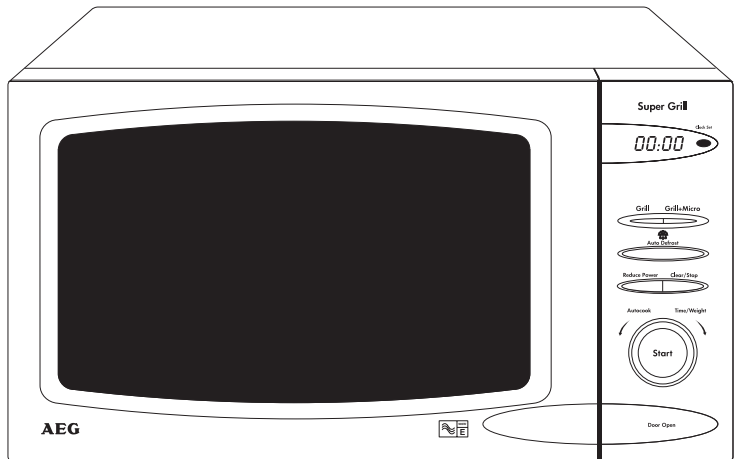





Operating instructions

Dear customer,

Thank you for buying an AEG microwave oven and putting your trust in the AEG brand name.

Before using your AEG microwave for the first time, please read the instruction book thoroughly. This will enable you to take advantage of all the features that the appliance offers. It will also ensure trouble-free operation and minimize unnecessary service calls.

-  Important information concerning your safety or the operation of your appliance is noted by this symbol and/or mentions such as «Warning», «Take care». Be sure to follow all instructions carefully.
-  Throughout the manual, this symbol assists you in the proper use of your appliance.
-  This symbol indicates further information concerning the use of the appliance.
-  The clover indicates energy-saving tips and hints for environmentally friendly use of your appliance.

In the event of malfunctioning, please follow the instructions given in the section «What do do if...»

Contents

Important information	
Ecologically responsible disposal of packaging and old appliances	5
Safety Instructions	
General	6
For trouble free and safe operation	6
Microwaves	7
Grill	9
General operating instructions	
Suitable ovenware	10
What else to look out for..	11
Installation and Connection	
Installation..	11
Connecting to the mains	12
Electrical Connections	13
Product Description	
The Appliance	14
Control panel	15
Accessories	16
Before using the appliance	
Cleaning	16
Setting the clock	17
“At a glance” operating instructions	18
Modes of operation	20
Kitchen Timer	21
Microwave Power cooking	21
Microwave Power setting Guide	22
Grill cooking	23
Microwave and Grill cooking	23
Autodefrost	24
Autocook programmes	25
Child Safety Lock	28
Defrosting instructions using 180W	29

Cooking charts and Tips

Grill cooking	30
Microwave and Grill cooking	31
Auto Defrost	32
Practical tips for use	36
Tips on microwaving	37

Cleaning and Care	38
-------------------------	----

What to do if... ..	39
---------------------	----

Service Information	40
---------------------------	----

Technical Data	41
----------------------	----

Comet

After Sales Service	Back Cover
---------------------------	------------

Important information

Ecologically responsible disposal of packaging materials and old appliances

Packaging materials

AEG microwave ovens require effective packaging to protect them during transportation. Only the minimum packaging necessary is used.



Packaging materials (e.g. foil or styrofoam) can place children at risk. **Danger of suffocation. Keep packaging material away from children.**



All packaging materials used are environment friendly and recyclable. The cardboard is made from recycled paper and the wooden parts are untreated. Plastic items are marked as follows :

«PE» polyethylene eg packaging film

«PS» polystyrene eg packaging (CFC-free)

«PP» polypropylene eg packaging straps

By using and re-using the packaging, raw materials are saved and waste volume is reduced.

Packaging should be taken to your nearest recycling centre. Contact your local council for information.

Disposal of old appliances



Old appliances should be made safe before disposal by removing the plug, and cutting off and disposing of the power cable.

It should then be taken to the nearest recycling centre or returned to your electrical retailer, who may dispose of it for a small charge.

Safety instructions



General

- The appliance should only be operated with the turntable and turntable support inserted.
 - Only suitable microwave ovenware should be used.
 - To protect the appliance against corrosion from moisture (condensation) in the cavity or on the door, wipe these areas dry after each use.
 - Do not leave the appliance unattended when warming or cooking food in disposable containers made of plastic, paper, or other flammable materials.
 - If smoke is observed, keep the oven door closed and disconnect the power supply. Never use the microwave oven if it is no longer functioning properly.
 - This appliance complies with all relevant safety instructions. In order to maintain the safety of the appliance, repairs should only be carried out by a fully qualified electrician, trained by the manufacturer. Repairs carried out by unqualified electricians can place the user in severe danger. In the case of any defect or breakdown, please therefore contact your local electrical dealer or the Comet Service Department directly.
 - Should the door seals and/or door seal surfaces be damaged, the appliance should not be operated until it has been repaired by the Comet Service Centre or by an AEG-trained electrician.
 - Damaged appliance parts can only be replaced by exactly the same make of parts. Special tools are required for this operation.
-  **WARNING** : Do not allow children to use the microwave oven without supervision unless they have been thoroughly instructed in the proper use and the dangers of improper operation.

For trouble free and safe operation

- Never jam anything between the door and the door frame.
- Always keep the door seals and their surfaces clean.
- Do not keep any flammable items in the microwave. They could ignite when the unit is switched on.
- Switch the appliance on only when the food has been placed inside the cooking space, as it could overload if there is no food present.

Microwaves



- When heating liquids, e.g. soups, sauces and beverages in your microwave oven, overheating the liquid beyond boiling point can occur without evidence of bubbling. This could result in a sudden boil over of the hot liquid - **with the risk of scalding the user.** To prevent this possibility the following steps should be taken:
 1. Avoid using straight-sided containers with narrow necks.
 2. Do not overheat.
 3. Stir the liquid before placing the container in the oven and again halfway through the heating time.
 4. After heating, allow to stand in the oven for a short time, stirring again before carefully removing the container.
- Food with «skin» or «peel», such as potatoes, tomatoes, sausages, and the like, should be pierced with a fork so that any steam present can escape and the food will not burst.
- Make sure that a minimum temperature of 70°C is attained for the cooking/heating of food. Never use a mercury or liquid thermometer for measuring the temperature of the food.
- Baby food in jars or bottles should always be heated without a lid or top, and well stirred or shaken after heating, to ensure uniform distribution of the heat. **Always check the temperature before feeding your child.**
- The hot food in a microwave oven will heat up the ovenware. For this reason always **use oven gloves** for handling hot dishes.
- Never cook your food for too long or at too high a power setting. Some areas of the food can dry out or even ignite.



Do not use your microwave oven for the following :

- to boil eggs or escargots in their shells, as they will burst. Eggs can be poached or «fried» in a microwave oven as long as the yolks are pricked.
- to heat large quantities of cooking oil (fondue or deep frying) and drinks containing a high percentage of alcohol - **there is danger of spontaneous combustion!**
- to heat unopened cans, bottles, etc.
- to dry animals, textiles or paper.
- for crockery like porcelain, ceramics, or porous earthenware (e.g. on the handles or unglazed bases) that can fill up with water. This can cause vapour pressure to build up during cooking which could shatter the dish.

Grill

- The viewing window heats up during grilling (and combination grilling and microwave cooking), so keep small children away from the appliance.
- To close the door when the viewing window is hot, press the on the lower right-hand side of the door.
- The cooking area, the grill heating elements, the shelf racks, the turntable and the anti-splash glass plate become very hot during all modes. You should therefore take care before touching anything. **Take care not to be burned!**



General operating instructions

Suitable ovenware

Ovenware material	Mode of operation		
	Micro-wave	Grill	Combination
Ovenproof glass and ceramic dishes (without any metal parts, e.g. Pyrex, Oven-to-tableware)	X	X	X
Non ovenproof glass and porcelain (e.g. table crockery ¹⁾)	X	-	-
Glass ceramic and vitro-ceramic made of fire/frost proof material (e.g. Arcoflam)	X	X	X
Ovenproof earthenware ²⁾	X	-	X
Plastic, heat-resistant up to 200°C ³⁾	X	-	X
Paper, cardboard	X	-	-
Cling film	X	-	-
Microwave cling film	X	-	-
Black-lacquered or silicone-coated baking tins	-	-	-
Roasting bag ⁴⁾	-	X	X

X suitable - non suitable

1) excluding silver, gold, platinum or metal decoration

2) does not include glaze containing metal

3) please note the maximum temperature stated by the manufacturer

4) do not use the grill shelf together with metal recipients.



What else to note...

- Food comes in all shapes, sizes and textures. The quantities also vary. For these reasons the time and amount of energy needed to defrost, heat or cook will also vary. As a general rule :

Double the power = nearly half the time

Please refer to the cooking charts. To be on the safe side, always select the shorter cooking time. Then extend the time as necessary.

- Microwaves work by making the food heat itself up. Because of this, not all areas of the food will be heated at the same time. When heating larger quantities of food, it is particularly important to stir or turn them over.
- “Standing time” is referred to in the cooking charts. This is the time you should leave the food to stand without power (either inside or outside the appliance). This ensures even distribution of heat throughout the food.

Installation and Connection

Installation

A gap all around the oven is necessary in order to ensure perfect ventilation: 200 mm above the oven and any objects, 50mm on the sides and behind the oven.

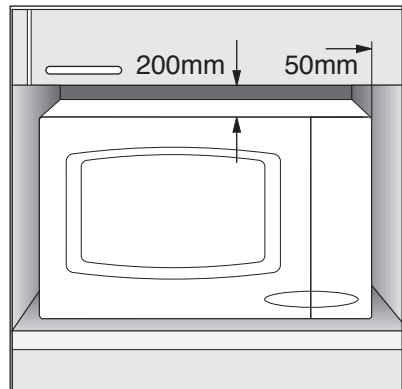

This appliance complies with the following EC Directives :
 EMC Directive 89/336/EEC, Low Voltage Directive 73/23/EEC with amendment 90/683/EEC and the CE marking Directive 93/68/EEC.

Installation

1. Remove any promotion label from the door.
2. Install the oven on a flat, level surface. The surface must be strong enough to safely bear the weight (22 kg) of the oven, and the contents. To avoid the possibility of causing vibration or noise the oven must be in a stable position.
3. Keep the oven away from heat and water. Exposure to heat and water can lower oven efficiency and lead to malfunctioning, so be sure to install the oven away from heat and water sources.
4. Do not block air vents on the top and the sides of the cabinet and also do not place any articles on the top of the oven. If air vents are blocked during operation, the oven may overheat, and this may lead to malfunctioning. Hot air escapes from the vents, so be sure not to obstruct it or let curtains come between the oven and the rear wall.
5. Place the oven as far away from radios and TV's as possible. This oven does conform to EEC requirements* of radio interference suppression, but some interference may occur if it is placed too close to a radio or TV, so keep them as far apart as possible.
 - *This appliance conforms to the requirements of EEC Radio Interference Directive 87/308/EEC.*

Connecting to the mains

- The oven is delivered with the power cord and a plug for 230–240 V, 50Hz, earthed socket outlet.
- Earth protection minimizes the risks should a short circuit occur. Check to ensure the voltage of the oven matches the supply.

N.B. If the oven is connected to the socket via an extension cord, make sure the cord is earthed.



WARNING! This appliance must not be used on a nonearth protected power supply.

- Contact an electrician if you are uncertain regarding electrical connection of the oven or provision of earth protection of the supply.
- This appliance must be earthed. If this appliance is fitted with a non-rewirable plug for which your socket is unsuitable, the plug should be cut off and the appropriate plug fitted. If it is necessary to change the fuse in a nonrewirable plug, the fuse cover must be refitted. If the fuse cover is lost or damaged, the plug must not be used until a replacement is obtained.

Electrical connections



- **WARNING! THIS APPLIANCE MUST BE EARTHED.**
The manufacturer declines any liability should this safety measure not be observed.
- If the plug that is fitted to your appliance is not suitable for your socket outlet, it must be cut off and the appropriate plug fitted.
- Remove the fuse from the cut off plug. The cut off plug should then be disposed of to prevent the hazard of shocks in case it should be plugged into a 13 Amp socket in another part of your home.

IMPORTANT

The wires in the mains lead are coloured in accordance with the following code:

GREEN AND YELLOW	EARTH
BLUE	NEUTRAL
BROWN	LIVE

If you fit your own plug, the colours of the wires in the mains lead of your appliance may not correspond with the markings identifying the terminals in your plug, proceed as follows:

- Connect the green and yellow (earth) wire to the terminal in the plug which is marked with the letter "E" or the earth symbol () or coloured green and yellow.
- Connect the blue (neutral) wire to the terminal in the plug which is marked with the letter "N" or coloured black.
- Connect the brown (live) wire to the terminal in the plug which is marked with the letter "L" or coloured red.

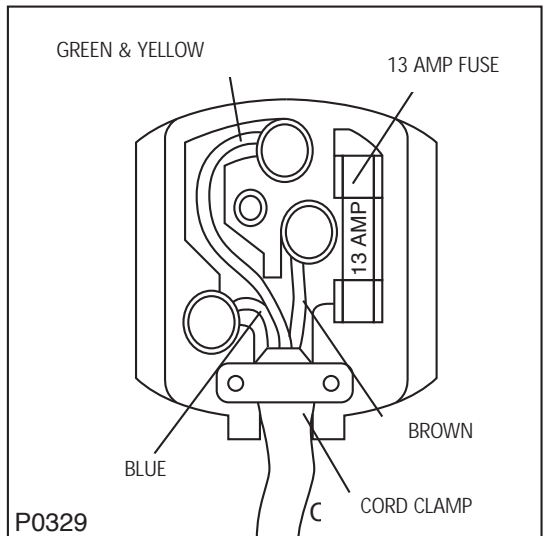

Product Description

The appliance

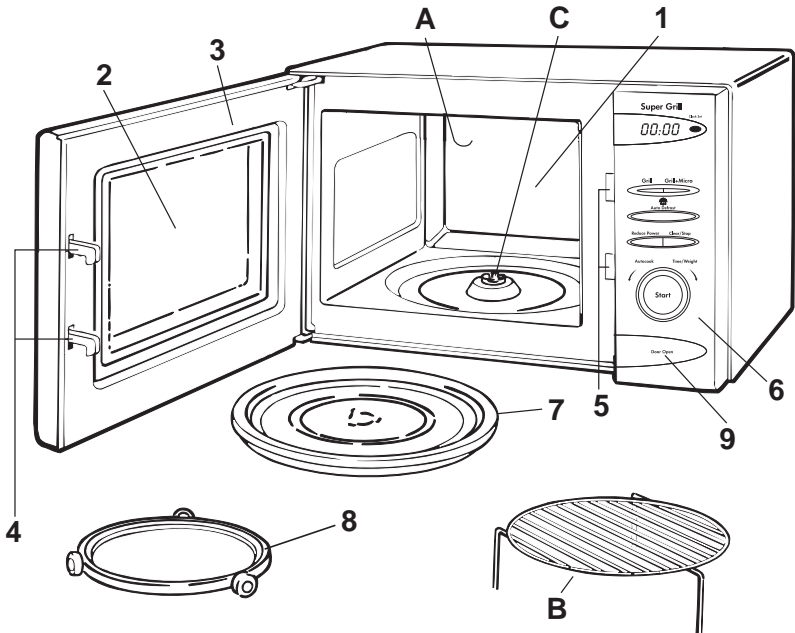

- 1 Cooking compartment. Wipe the compartment clean after using the oven.
 - 2 Viewing window. Food can be checked while the microwave oven is in operation.
 - 3 Oven door. The door must always be firmly closed while cooking.
 - 4 Latch hook.
 - 5 Safety interlock system.
 - 6 Control panel.
 - 7 Turntable. Made of special heat-resistant glass. Food in a suitable container is placed on this tray for cooking. Do not use the oven without the turntable.
 - 8 Turntable support. Place the support on the floor of the cooking chamber to support the turntable.
 - 9 Door open.
- A Browner/Grill element.
B Grill rack used for most cooking and browning/grilling.
C Drive shaft for turntable

The control panel

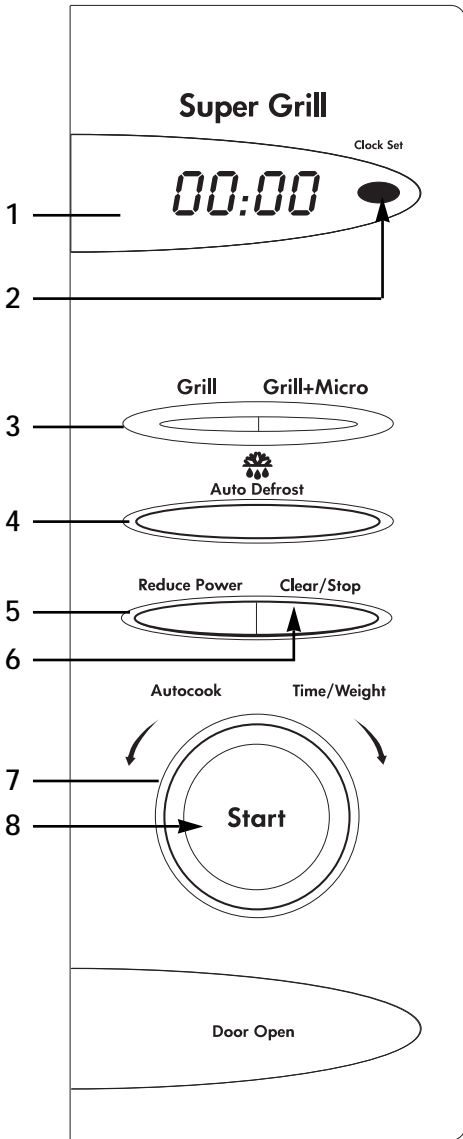

1. **Display window** – showing time of day and cooking time.
2. **Quick Set** – Clock, for setting the clock.
3. **Grill** – 1300W.
4. **Grill + Micro** – 150W or 450W Micro + Grill.
5. **Auto Defrost** – Auto Defrost by weight.
6. **Reduce Power** – To reduce power to desired microwave power level.
7. **Clear/Stop** – Stop. For interrupting or cancelling a cooking programme.
8. **Rotary Knob** for setting time, weight and AutoCook programmes.
9. **Start** – Start, to start desired programme.

Accessories

Turntable Installation

1. Place the turntable support on the cavity bottom.
 2. Place the turntable on top of the turntable support as shown in the diagram. Make sure that turntable hub is securely locked in the turntable shaft. **Never place the turntable upside down.**
- Both turntable and turntable support must always be used during cooking.
 - All food and containers of food are always placed on this turntable for cooking.
 - This turntable rotates clockwise and anticlockwise; this is normal.

Turntable

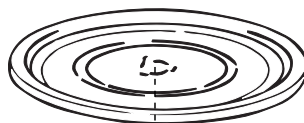

Turntable support

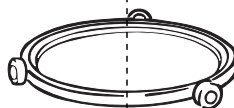

Turntable shaft



Before using the appliance

Cleaning

Wipe over the front of the appliance with a damp cloth. Do not use abrasive cleaning agents (these can damage the surface).

Before you first use the appliance, remove the turntable from the cooking area. Wash the turntable in warm water and washing up liquid. Wipe clean the cooking space with a soft, damp cloth. Replace the turntable.



Setting the clock

Example: 4:30 hrs

When your oven is plugged in for the first time or when power resumes after a power interruption, the numbers in the display reset to "00:00".

This 12 hour digital clock allows you to set it from "01:00" to 12:59"

To set: 4:30 hrs

-
- | | | |
|---|---|--|
| 1. Touch Clock pad |  | "0:00" will flash in the display |
| 2. Turn the Rotary knob to the right until 4:30 is indicated in the display |  | "4:30" will flash in the display |
| 3. Touch Clock pad |  | "4:30" will be indicated in the display. Time of day is now set. |
-

«At a glance» operating instructions

Action	Comments
1. Press door open.	The door opens.
2. Place food on the turntable.	
3. Shut the door.	The door will click audibly when it is properly shut. If the door is not shut properly, the appliance will not function.
4. Select according to the instructions given in the following pages.	Turn the rotary knob clockwise to increase and anti-clockwise to decrease time/weight 1)
5. Press the START button	2)The appliance starts. The display shows the selected cooking time, counting down backwards in seconds.
6. End of cooking sequence	The end of the cooking sequence is indicated by an audible tone. The appliance and the interior light will switch off.
<ul style="list-style-type: none">• Press the clear/stop button once. AND/OR Open the door by pressing the door, e.g. for stirring	The appliance switches off. In the display the two dots between the digits flash. The selected settings remain.
<ul style="list-style-type: none">• Shut the door and press the START button.	The remaining time counts down automatically.
<ul style="list-style-type: none">• Press the Clear/Stop button twice	The running process is cancelled. The appliance and the interior light will switch off. Time of day is displayed.



- 1) If the maximum cooking time setting "60:00" is exceeded the display shows "00:00"
- 2) If the oven is not started within 4 minutes, the settings are automatically cancelled; time of day appears in the display.

Action	Comments
<ul style="list-style-type: none"> Modify the selected cooking time/weight: turn the rotary knob clockwise or anticlockwise 	<p>The cooking time/weight in the display changes when turning the rotary knob¹⁾</p>
<ul style="list-style-type: none"> Modify the selected microwave power. Press the REDUCE POWER button. Operation of the grill by pressing the GRILL button. 	<p>The new power setting is displayed for 5 seconds. The cooking process continues with the new power setting.</p> <p>The selected grill power level is displayed. (Also see Microwave and Grill cooking)</p>
<ul style="list-style-type: none"> Auto Defrost and Autocook programmes. 	<p>The display will change as described in the Auto Defrost and Autocook sections of these instructions.</p>



- 1) If the new selection reaches "00:00" in the display, the cooking time is over and an audible signal is heard. The appliance and the interior light will switch off. During a cooking process the cooking time can be increased to a maximum of 60 minutes.

Modes of operation

The appliance features the following functions:

Kitchen timer

The kitchen timer can also be used as a general purpose reminder. For example you could use it to set the time it takes to boil the egg that you are cooking on the hob.

Microwave only

In this mode, microwaves generate heat directly in the food. This mode is highly suitable for warming, for example, ready cooked food and drinks, the defrosting of meat or vegetables, and for cooking food like fish and vegetables.

Grilling

Heat is generated by a grilling element set in the roof of the oven. This is particularly suitable for toasting and grilling e.g. steaks and sausages.

Microwave and Grill cooking

The microwave mode can be used together with grilling. Dishes will be cooked more quickly, whilst being crisp and brown at the same time.

Auto Defrost and Autocook programmes

Automatic programmes for defrosting and cooking a range of popular foods are available. Select the programme (enter the weight for autodefrost programmes) and the rest of the programming is done automatically.

Child Safety Lock

This appliance has a safety feature which prevents the accidental running of the oven by a child.

Manual Defrosting using 180W

For manual defrosting (without using Autodefrost features) use 180W. To speed up the defrosting of dense foods over 450g (1lb), the appliance may start on full power for 1 - 3 minutes, then be reduced to 180W until defrosting is complete.

Kitchen Timer

Example: To set the kitchen timer for 7 minutes

-
- | | | |
|---|---|---|
| 11 times | Reduce Power | indicated in the display |
| 2. Turn the Rotary knob to the right until 7:00 is indicated in the display |  | "7:00" will be indicated in the display |
| 3. Touch Start pad | Start | "4:30" will be indicated in the display.
Time of day is now set. |
-

Microwave Power cooking



- This basic microwave cooking method allows you to cook food for a desired time. In addition to the maximum power level, you can select different microwave power from 10 levels, 90W to 900W for the foods that require slower cooking.
- Foods with high moisture content should be cooked on maximum power, as this is the fastest cooking method and best maintains the natural flavour and texture of the foods.

Example: To cook at highest power level, 900W for 2 minutes

-
- | | | |
|---|---|--|
| 1. Turn the Rotary knob to the right until 2:00 is indicated in the display |  | "2:00" will be indicated in the display
The microwave is preset for cooking at highest power level. |
| 2. Touch Start pad | Start | The microwave commences cooking, cooking time will count down. |
-

Microwave power cooking

Example: To cook at 630W, power level 7, for 5 minutes

1. Touch Reduce Power pad  "P630" will be indicated in the display
4 times
2. Turn the Rotary knob to the right until 5:00 is indicated in the display  "5:00" will be indicated in the display
3. Touch Start pad  The microwave commences cooking, cooking time will count down.

Microwave Power setting Guide

Notes on microwave power levels

The following list shows you the power settings and what they can be used for during microwave operation :

900 Watt	High, Max. power - boiling liquids - baking fish or vegetables - preheating a browning dish
810 Watt	Reheat - baking cakes - reheating precooked foods
450 Watt	Simmer - completing the cooking cycle of pot roasts. - completing the cooking cycle of some casseroles and stews - baked custards or cheese cakes
360 Watt	Med. low - completing the cooking cycle of some casseroles and stews
180 Watt	Defrost - thawing foods
90 Watt	Keeping Warm - keeping foods warm

Grill cooking

- This method is ideal for toasting bread or muffins.
- Remember the oven will be hot. Place all food on the grilling rack.
- Grill cooking can be set to a maximum of 35 minutes

Example: To set the microwave to Grill for 15 minutes

- | | | |
|--|---|--|
| 1. Touch Grill pad | Grill | "Grill" will be indicated in the display |
| 2. Turn the Rotary knob to the right until 15:00 is indicated in the display |  | "15:00" will be indicated in the display |
| 3. Touch Start pad | Start | The microwave commences cooking, cooking time will count down. |

Microwave and Grill cooking

- This appliance offers a choice of two Grill and Micro settings
 Grill with micro 150W, touch **Grill+Micro** twice
 Grill with micro 450W, touch **Grill+Micro** once
- This function allows you to combine the advantages of the speed and convenience of a Microwave with the browning and crisping benefits of a Grill

Example: To set Microwave and Grill cooking, 450W for 10 minutes



- | | | |
|--|---|--|
| 1. Touch Grill+Micro pad once. | Grill+Micro | "G450" will be indicated in the display |
| 2. Turn the Rotary knob to the right until 10:00 is indicated in the display |  | "10:00" will be indicated in the display |
| 3. Touch Start pad | Start | Cooking time will count down. |

 **NB:** Check food frequently when grilling, especially when using the high grill rack.

Autodefrost

- The Autodefrost by weight feature is an accurate defrosting method for frozen meat, poultry or fish.

Example: To defrost 400g of minced meat:

-
- | | | |
|--|---|---|
| 1. Touch Autodefrost pad |  | "dEF3" will be indicated in the display |
| 2. Turn the Rotary knob to the right until 0.4 is indicated in the display |  | "0.4" will be indicated in the display |
| 3. Touch Start pad | Start | Defrost time will count down. |
-

Defrosting Tips

- | | |
|---|--|
| <ol style="list-style-type: none"> It is better to underestimate defrosting time if you are unsure. Food will continue to defrost during the standing time. Separate food as soon as possible. Turn large items, e.g. joints, halfway through the defrosting time. Remove any thawed food as soon as possible. Remove or open any packaging before defrosting. | <ol style="list-style-type: none"> Place food in a larger container than that which it was frozen in, this will allow for easy stirring. Begin thawing poultry, breast side down and turn over halfway through defrosting time. Delicate areas such as wing tips can be shielded with small pieces of smooth foil. Standing time is very important, particularly for large, dense foods which cannot be stirred to ensure that the centre is completely defrosted before cooking. |
|---|--|

Programme	Min. weight	Max. weight
Fish, def 1	0,1 kg	2,0 kg
Poultry, def 2	0,1 kg	3,0 kg
Meat, def 3	0,1 kg	2,0 kg

Autocook programmes

- The Autocook programmes allow you to simply and automatically cook a range of popular foods.
- Operation is very easy. Simply touch the appropriate key the correct amount of times (see directions below) and touch START.
- **VERY IMPORTANT!**
For best results, please follow the guidelines below:-

POPCORN, 100g:

1. Turn the Rotary knob to the left until "Popcorn" flashes in the display. 
 2. Touch Start pad. **Start**
Cooking time will count down.
-

IMPORTANT

- Use prepacked room-temperature microwave popcorn.
- Place bag in the microwave according to the manufacturers directions.
- Pop only one bag at a time.
- After popping, open bag carefully, popcorn and steam are extremely hot.
- Do not reheat unpopped kernels or bag.
- Do not leave the microwave unattended while popping popcorn.
- Always follow the manufacturers instructions.

If pre-packaged popcorn is of a different weight than the recommended weight, do not use the popcorn setting, or inadequate popping or a fire may occur.

LIQUID, to reheat 250ml cups of liquid:

1. For one cup of liquid, turn the Rotary knob to the left until "CUP1" lights up in the display 
For two cups of liquid, turn the Rotary knob to the left until "CUP2" lights up in the display
 2. Touch Start pad **Start**
Cooking time will count down.
-

Autocook programmes

SOUP, to reheat 250ml from fridge temperature:

SOUP, to reheat 250ml from fridge temperature:

1. Pour the soup into a suitable bowl.
2. Turn the Rotary knob to the left until "SOUP" lights up in the display
3. Touch Start pad
Cooking time will count down.



Start

PLATE OF FOOD, to reheat 225g - 400g "ready meal" or left overs:

1. To reheat a plate of food or pre-cooked "ready meal", 225g - 300 G from fridge temperature, turn the Rotary knob to the left. "PLA1" will light up in the display



To reheat a plate of food or pre-cooked "ready meal", 300g - 400 G from fridge temperature, turn the Rotary knob to the left. "PLA2" will light up in the display

To reheat a plate of food or pre-cooked "ready meal", 300g - 400 G from frozen, turn the Rotary knob to the left. "PLA3" will light up in the display

2. Touch Start pad
Cooking time will count down.

Start

Autocook programmes

Example: To cook a "ready meal", 350g from fridge temperature

1. Place the plate with food on the turntable.
 2. Turn the Rotary knob to the left until "PLA2" lights up in the display 
 3. Touch Start pad **Start**
Cooking time will count down.
-

BAKED POTATOES, To bake 1 - 3 potatoes, 215g - 240g

1. To bake one potato, turn the Rotary knob to the left until "P01" lights up in the display 

To bake two potatoes, turn the Rotary knob to the left until "P02" lights up in the display

To bake three potatoes, turn the Rotary knob to the left until "P03" lights up in the display
 2. Touch Start pad **Start**
Cooking time will count down.
-

PIZZA, To cook a 300g pizza, frozen or from fridge temperature

1. To cook a 300g pizza from frozen, turn the Rotary knob to the left until "Pi.F" (Pizza-Frozen) lights up in the display 

To cook a 300g pizza from fridge temperature turn the Rotary knob to the left until "Pi.C" (Pizza-Chilled) lights up in the display.
 2. Touch Start pad **Start**
Cooking time will count down.
-

Autocook programmes

CHICKEN PIECES, To cook chicken pieces 300g - 350g from fridge temperature

1. Place the chicken pieces on the low rack provided

2. Turn the Rotary knob to the left until
"CHIC" lights up in the display



3. Touch Start pad
Cooking time will count down.

Start

NB: There is a pause in the middle of the Autocook programme for Chicken pieces. The display flashes "CHIC" and an audible tone will be heard. Simply open the door, and turn the chicken pieces over to brown the other side. Then close the door and touch "START". If you don't open the door, the microwave proceeds automatically after a few minutes.

Child Safety Lock

- This appliance has a safety feature which prevents the accidental running of the oven by a child.

Example: To lock the microwave for unauthorised use.

1. Touch "GRILL+MICRO" pad once
"G+M" will be indicated in the display

Grill+Micro

2. Touch CLEAR/STOP pad 5 times
"LOC" will be indicated in the display.
The microwave is now locked

Clear/Stop

To cancel Child Lock, simply repeat setting procedure, indicator "LOC" disappears and time of day reappears.

Defrosting instructions using 180W

Some foods such as bread and fruit, can successfully be thawed manually by using the "180W" power setting.

Food	(180W)	Standing time (mins)	Preparation
Bread			
Small loaf	8 - 10 min	10 - 15	Place on microwave proof rack or kitchen paper. Turn over halfway through defrosting time.
Sliced large loaf	10 - 13 min	10	Place on microwave proof rack or kitchen paper. Turn over halfway through defrosting time.
2 slices	45 - 60 sec	5	Place on kitchen paper.
1 bread roll	45 - 60 sec	5	Place on kitchen paper.
2 bread rolls	1 - 1 ¹ / ₂ min	5	Place on kitchen paper.
Cakes and Pastry			
Gateau 450g/1 lb	9 - 10 min	15 - 30	Remove from packaging, place on plate.
Cheesecake 450g/1 lb	9 - 10 min	15 - 30	Remove from packaging, place on plate.
Pie (cooked) 450g/1 lb	7 - 9 min	15 - 30	Remove from packaging, place on plate.
Butter			
250g/8.8oz (1 packet)	3 - 4 min	5 - 10	If foil wrapped, remove from wrapper and place on plate.
Fruit			
225g/8oz Soft berry fruits	5 - 6 min	5 - 10	Place in a single layer in a shallow dish.
450g/1 lb Soft berry fruits	7 - 8 min	5 - 10	Place in a single layer in a shallow dish.
Plated meal			
400g/14oz	7 - 8 min	5 - 10	Cover with a plate or non P.V.C. cling film. To reheat, microwave on HIGH for 3 - 4 minutes.
Vegetables	-	-	It is not necessary to defrost vegetables before cooking. All vegetables can be thawed and cooked on HIGH.

Cooking charts and tips

Grill cooking

Food	QTY (Weight)	Cooking time (mins)	Special notes
Toast	2 Slices	6 – 8	
Cheese with Toast	4 slices	10 – 12	6 – 8 min. to toast. 3 – 5 min. with top
Bacon	4 (120 g)	10 – 12	
Pizza with Topping		5 – 8	
Pork Chops Beef Steaks	2 (400 g) 2 (400 g)	30 – 35 15 – 20	Brush with oil. Season with salt, pepper and paprika
Sausages	6 (300 g)	14 – 16	

NOTE: Turn all foods except pizza, halfway through cooking time. Place dish on turntable under the grill rack to catch any liquid.



NB: Check food frequently when grilling, especially when using the high grill rack.

Microwave and grill cooking

Food	QTY (Weight)	Power Selector position	Cooking time (mins)	Special notes
Bacon	4 (120 g)	150W	8 – 10	
Roast Beef (Boned)	1000 g	450W	30 – 35	Brush with oil. Season with salt and pepper. Allow 15 – 20 minutes standing time after cooking
Roast Pork (Loin)	1000 g	450W	30 – 35	
Pork Chops	2 (300 g)	150W	15 min then turn over. Then 12 min. grill only	Brush with oil. Season with salt, pepper and paprika.
Chicken, Halved lengthwise	1000 g	150W	30 – 35	Brush with oil. Season with salt, pepper and paprika.
Legs	4 (500 g)	150W	22 – 25	
Hamburger Frozen	4 (200 g)	150W	12 – 15	Turn over after 7 – 8 min.
Fresh	4 (400 g)	150W	12 – 15	
Sausages	12 (650 g)	150W	14 – 15	
Fish Steak	2 (350 g)	150W	18 – 20 m	Brush with oil, Season with salt and pepper
Potato, Hash Brown Frozen	2 (150 g)	150W	12 – 14	
Ready Meal, Lasagne	400 g	450W	7 – 9	
Potato Gratin	350 g	450W	6 – 9 min	

NOTE: Use roasting rack on turntable for roast beef and pork. Shield thin parts and edges. Place dish on turntable under grill rack to catch any liquid. Turn halfway during cooking time, except for ready meal.

Auto Defrost

FOOD	PREPARATION	PAUSE DIRECTIONS	STANDING TIME
Beef Cubed		Remove any thawed cubes and stir, ensuring that the frozen cubes are around the edge of the dish.	10–15 min
Minced		Remove any thawed portions and turn over.	5–10 min.
Beef Joint	Place on an upturned saucer on a plate or on a microwaveproof rack. Shield thin areas and outer edges with smooth pieces of foil.	Remove foil from outer edges but leave on thin areas. Turn over.	30–40 min.
Steak	If frozen in a block, separate as soon as possible. Shield outer edges with smooth pieces of foil.	Remove foil and turn over.	10–15 min.
Lamb Cubed	Place in an even layer in a shallow dish.	Remove any thawed cubes and stir. Ensure that the frozen cubes are around the edge of the dish.	10–15 min.
Chops/ Cutlets	If frozen in a block separate as soon as possible. Arrange chops so the thinner ends are towards the centre of the turntable. Shield outer edges with smooth pieces of foil.	Remove foil and turn over.	10–15 min.

Auto Defrost

FOOD	PREPARATION	PAUSE DIRECTIONS	STANDING TIME
Lamb Lamb Joint	Place on an upturned saucer on a plate or on a microwaveproof rack. Shield thin areas and outer edges with smooth pieces of foil.	Remove foil and turn over.	30–40 min.
Pork Chops	If frozen in a block, separate as soon as possible. Arrange chops so the thinner ends are towards the centre of the turntable. Shield thin areas and outer edges with smooth pieces of foil.	Turn over, shield outer edges and thin ends with foil	10–15 min
Sausages	If frozen in a block, separate as soon as possible. Shield both ends of the sausages with smooth pieces of foil.	Rearrange and remove any sausages that have thawed.	10–15 min.
Bacon	Separate as soon as possible. Shield both ends of bacon with smooth pieces of foil.	Separate. Remove any thawed slices, arrange remaining slices in a single layer and shield both ends with smooth pieces of foil.	5–10 min.

Auto Defrost

FOOD	PREPARATION	PAUSE DIRECTIONS	STANDING TIME
Spareribs	If frozen in a block, separate as soon as possible. Shield both ends with smooth pieces of foil.	Remove foil. Turn over, rearrange and remove any thawed pieces.	10–15 min
Pork Joint	Place on an upturned saucer on a plate or on a microwaveproof rack. Shield thin areas and outer edges with smooth pieces of foil.	Remove foil and turn over.	30–40 min.
Chicken Whole	Use an upturned saucer on a plate or a microwaveproof rack. Place chicken breast side down. Shield wings, legs and neck with smooth pieces of foil.	Remove foil from outer edges Turn over and shield warm edges with foil.	30–40 min.
Pieces	Shield thin parts such as tips with smooth pieces of foil. Arrange so thicker parts are towards the outside of the dish	Remove foil Turn over arrange so thicker parts are towards the outside of the dish.	10–15 min.

Auto Defrost

FOOD	PREPARATION	PAUSE DIRECTIONS	STANDING TIME
Turkey Pieces	Use a microwaveproof rack or shallow dish. Shield thin parts with smooth pieces of foil. Arrange so thicker parts are towards the outside of the dish	Remove foil. Turn over and shield any warm areas with foil.	10–15 min.
Fish Fillets	Use a shallow dish or microwaveproof rack. Arrange fillets in an even layer. If frozen in a block, separate as soon as possible. Shield tail and thin ends with smooth pieces of foil	Remove foil, turn over, rearrange and arrange. tail ends under thicker parts of fish	5–10 min.
Steaks	Use a shallow dish or microwaveproof rack. Arrange steaks in an even layer. If frozen in a block separate as soon as possible. Shield outer edges of steaks with smooth pieces of foil	Remove foil, turn over and rearrange	5–10 min.
Whole fish	Use a shallow dish or microwaveproof rack. If more than one fish, arrange head to tail. Shield ends with smooth pieces of foil.	Remove foil, turn over and rearrange	5–10 min.

Practical tips for use

General

- After switching off your appliance, let food stand inside for a few minutes to allow even heat distribution (**standing time**).
- Remove any aluminium foil or packaging containing metal before preparing the food.
- Metal objects must be placed at least 2cm away from the cooking space walls and door. Otherwise arcing can occur, resulting in damage to the appliance.
- Check food frequently when grilling, **especially when using the high grill rack.**

Cooking

- Whenever possible cook covered. Only pastry dishes with crust should be cooked uncovered.
- Refrigerated or frozen food require longer cooking times.
- Foods containing sauces should be stirred from time to time.
- Cook soft vegetables such as carrots, peas and cauliflower with a little water.
- Cook soft vegetables such as mushrooms, peppers and tomatoes without liquid.
- Increase cooking time by approximately 50% for larger pieces. Whenever possible, cut vegetables into equal-sized pieces.

Defrosting of meat, poultry and fish

- Place frozen, unpacked meat on an inverted plate in a glass or porcelain container, or use a sieve, so that the meat juice can drain.
- Halfway through defrosting, turn the food, dividing it where possible and removing the pieces that have defrosted.

**Defrosting of butter, pieces of layer cake and cottage cheese**

- Do not fully defrost in the appliance, but leave to adjust outside. This will give a more even result.
- Remove any metal or aluminium foil packaging and/or accessories before defrosting

Defrosting of fruit and vegetables

- Fruit and vegetables that are to be used raw later should not be fully defrosted in the appliance, but left to complete defrosting at room temperature outside.
- Fruit and vegetables that are to be cooked immediately afterwards can be cooked straight from frozen using a higher power level.

Ready made meals

- Ready made meals in metal packages or plastic containers with metal lids should be heated or defrosted in your microwave oven only if they are explicitly marked as being suitable for microwave use. Please follow the operating instructions printed on the packages (e.g. remove the metal lid and prick the plastic foil).

**Tips on microwaving**

You can't find cooking details for a specific quantity of food.

Base programming on a similar type of food. Lengthen or shorten the cooking time accordingly:

Double quantity = almost double time

Half quantity = half time

The food is too dry.

Set a shorter cooking time or reduce the microwave power output.

The food is not yet defrosted, heated through or cooked on completion of programme time.

Select a longer programme time or a higher microwave power setting. Note that larger food will require a longer time.

The food is overcooked on the outside and undercooked in the middle on completion of cooking time.

Next time, try a lower power setting for a longer time. Stir liquids, such as soup, periodically.



Cleaning and care

The Appliance Exterior

Wipe the front of the appliance using a soft cloth and a mild, warm detergent solution.

Do not use abrasive cleaning substances, strong detergents or coarse abrasive cleaning materials.

Cooking area

The interior will remain in good condition for a long time so long as you don't use scouring pads or rough abrasive materials. Use mild dishwashing liquid to clean the interior.

The grill heating element is built into the appliance and cannot be removed. The element may be stained with spattered fat or oil while the oven is in use. Wait until the cavity cools down and wipe off the spattered oil before the oven is used again. Stained grills may cause unpleasant odours and smoke.

You can neutralise odours inside the cooking area by boiling a cup of water with a little lemon juice for a few minutes in your oven.

Through normal operation, liquid may evaporate and condensation may occur. This is normal and is especially noticeable when the room temperature is high and the humidity of the air is low. After operation, be sure and wipe off the condensation with a soft cloth.

Turntable and Turntable support

Clean the turntable using washing-up liquid, or put it in the dishwasher.

Clean the turntable support with washing-up liquid.

This should be removed straight after each use and cleaned using washing-up liquid or in the dishwasher.

Other accessories

The grill racks should be removed immediately after use and soaked in an appropriate cleaning fluid. Food remains can then be removed quite easily using a brush and ordinary washing up liquid.

What to do if...



...the microwave appliance is not working properly ?

Check that

- the fuses in the fuse box are working,
- there has not been a power outage.
- If the fuses continue to blow, please contact a qualified electrician.



...the microwave mode is not working ?

Check that

- the door is properly closed,
- the door seals and their surfaces are clean,
- the START-button has been pressed



...the turntable is not turning ?

Check that

- the turntable support is correctly connected to the drive,
- the ovenware does not extend beyond the turntable,
- food does not extend beyond the edge of the turntable preventing it from rotating.
- there is nothing in the well beneath the turntable.



...the microwave will not switch off ?

- Isolate the appliance from the fuse box.
- Contact your local Comet Service Centre.



...the interior light is not working ?

- Call your local Comet Service Centre. The interior light bulb can be exchanged only by trained AEG technicians.



...the food is taking longer to heat through and cook than before ?

- Set a longer cooking time (double quantity = nearly double time) or
- if the food is colder than usual, rotate or turn from time to time or
- set a higher power setting.

Service Information

You can perform certain maintenance on your own; these operations are listed in section «What to do if...». First verify the problem, then look it up in the section. If you do not find the solution therein, then please contact your local Comet Service Centre.

Technical Data

Overall dimension	Width	520 mm
	Depth	407 mm
	Height	292 mm

Cavity dimension	Width	349 mm
	Depth	350 mm
	Height	198 mm
	Volume	24 litre

Power source	230 - 240 V, 50 Hz
Fuse	13A
Power consumption	2750W
Power output	900W
Browner/Grill	1300W
Weight	22kg

Comet After Sales Service

Thank you for purchasing this A.E.G. microwave oven.

We are sure that this product will provide many years of trouble free service to you, however, should you experience any faults with this appliance please contact your local Comet Service Centre for help or advice.

Our number can be found in your local telephone directory.

Metric/Imperial Weight Conversion Chart

Imperial to Metric	Metric to Imperial
1 oz = 28.35 g	1 g = 0.0353 oz
1 lb = 454 g	1 kg = 2.20 lb

AEG
Cornwall House
55 - 57 High Street
SLOUGH
SL1 1BQ

Telephone: 08705 350350

©Copyright by AEG

8221911-86
Revision 2 /21.09.1999

Free Manuals Download Website

<http://myh66.com>

<http://usermanuals.us>

<http://www.somanuals.com>

<http://www.4manuals.cc>

<http://www.manual-lib.com>

<http://www.404manual.com>

<http://www.luxmanual.com>

<http://aubethermostatmanual.com>

Golf course search by state

<http://golfingnear.com>

Email search by domain

<http://emailbydomain.com>

Auto manuals search

<http://auto.somanuals.com>

TV manuals search

<http://tv.somanuals.com>