

AEG

LAVAMAT 3085

Ekolojik Otomatik amařır Makinesi
The environmentally friendly washing-machine

Kullanım kılavuzu
Instruction booklet

AUS ERFAHRUNG GUT

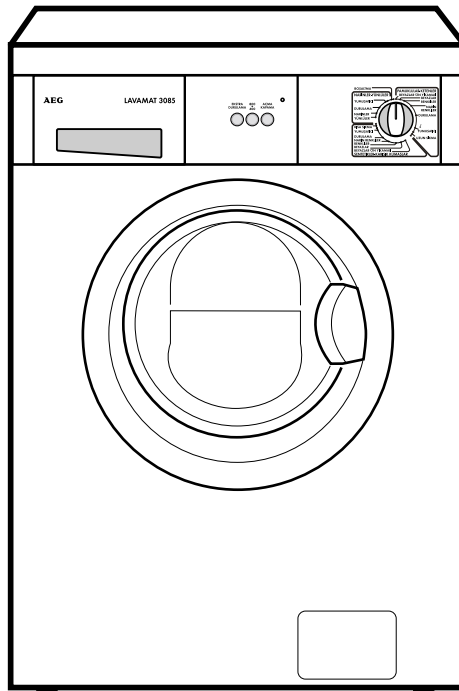

35.292.805/0

Dear customer,

Please read these operating instructions carefully and pay particular attention to the safety notes indicated in the first pages. We recommend that you keep this instruction booklet for future reference and pass it on to any future owners.



The warning triangle and/or the key words (Warning!, Caution!) emphasize information that is particularly important for your safety or correct functioning of the appliance.



This symbol guides you, step by step, in the operation of the appliance.



The information marked with this symbol provides additional instructions and practical tips on the use of the appliance.



Tips and information about economical and ecological use of the machine are marked with the clover symbol.

Should any problems arise, this booklet provides instructions on how to solve them by yourself; see section "Something not working?".

If this information is not sufficient, please contact our nearest Service centre (address and telephone numbers are indicated on the enclosed leaflet).

Printed on recycled paper.
People who think ecologically, act accordingly...

Contents

Safety instructions	42
Discarding	44
Tips for environmental protection	45
Main features of your washing machine	46
Description of the appliance	47
Control panel	48
Programme selector dial.....	48
Mains-on light	48
ON/OFF (AÇMA KAPAMA) button.....	48
Spin reduction button (800/400).....	49
Extra rinse button (EKSTRA DURULAMA).....	49
Detergent and additive dispenser drawer	50
Before the first wash	50
Preparing the wash cycle	51
Sorting out and preparing the laundry	51
Weight of laundry	52
Types of fabric and care labels	52
Detergents and additives.....	54
Which detergent and additive?	54
How much detergent?	54
Liquid detergent	54
Adding a water softener	54
Information on water hardness.....	54
How to wash	55
Load the laundry	55
Add detergent and additive.....	55
Select the wash programme and temperature	55
Select the required option.....	56
Start the programme.....	56
End of the programme.....	56
Programme charts	57-58
Consumption data and duration of main programmes	59

Contents

Cleaning and maintenance	60
After each use	60
Periodical cleaning	60
Bodywork	60
Detergent dispenser drawer	60
Drain filter	61
Water inlet filter	61
Emergency emptying out	62
Frost precautions	63
Something not working?	64
Troubleshooting	65
Unsatisfactory washing results	68
Technical data	69
Service	70
Instructions for installation and electrical connection	71
Safety instructions	71
Dimensions of the appliance	72
Front view and side view	72
Rear view	72
Installation	73
Unpacking	73
Positioning	74
Levelling	74
Water inlet	75
Water drainage	75
Electrical connection	76
Permanent connection	76

Safety instructions

The safety of AEG appliances complies with the industry standards and with legal requirements on the safety of appliances. However, as manufacturers, we feel it is our duty to provide the following safety notes.

General notes

- Repairs to the machine must be carried out only by qualified personnel. Repairs carried out by inexperienced persons could cause serious danger. Contact our Service Centre or your AEG dealer.
- Never start the machine if the electrical supply cable is damaged or the control panel or worktop are so damaged that inner components can be reached.
- Unplug the appliance before carrying out any cleaning or maintenance operations.
- Never pull the power supply cable to remove the plug from the socket; always take hold of the plug itself.
- Never spray the washing machine with a jet of water. Danger of electrocution!
- During high temperature wash programmes the door glass may get hot. Do not touch it!
- Let the water cool down before carrying out emergency emptying or before opening the door in an emergency.
- Small animals can gnaw electric wires and water hoses causing electrocution hazard and damage due to water leaks.

Positioning, connection, starting up

- Follow the **instructions for positioning and connection**.
- Carry out a first wash without laundry (COTTONS 60, with half the amount of detergent) in order to remove any manufacturing residue from the tub and the drum.
- Should the machine be purchased in winter, when temperatures can be below 0°, leave the appliance for 24 hours at ambient temperature before starting it.

Safety instructions

Child safety

- Children are often not aware of how dangerous electrical appliances can be. When the machine is working, they should be carefully supervised and not be allowed to play with the appliance - there is a risk that they could become trapped inside.
- The packaging components (e.g. plastic film, polystyrene) can be dangerous to children - danger of suffocation! Keep them out of children's reach.
- Make sure that children or pets do not climb into the drum.
- When the appliance is disposed of, pull the plug out of the socket, cut off the electrical supply cable and destroy the plug with the remaining cable. Disable the door catch in order to prevent children from becoming trapped inside while playing.

Proper use

- This appliance is designed for domestic use only. If the machine is used for any other purposes or is not used correctly, the manufacturer accepts no responsibility for any possible damage that might occur.
- For safety reasons, the appliance must not be modified.
- Use only detergents suitable for washing machines and follow the manufacturer's instructions.
- Laundry must not have any trace of inflammable solvents; be particularly careful when washing items that have been previously dry cleaned.
- Dyes and bleaching agents may only be used if specifically permitted by the manufacturer of these products. We cannot be held responsible for any damage.
- Use only water supplied from the rising mains. Rainwater or industrial water may only be used if the requirements of standards DIN 1986 and DIN 1988 are complied with.



Discarding

Packaging materials

The materials marked with the symbol  are recyclable.

This means that they can be recycled by disposing of them properly in appropriate collection containers.

For information regarding waste collection points, please contact your local authorities.

>PE<=polyethylene

>PS<=polystyrene

>PP<=polypropylene

Machine

To dispose of the appliance correctly, contact the local body responsible for collection.



Tips for environmental protection

- Lightly soiled laundry may be washed without prewashing in order to save detergent, water and time (the environment is protected too!).
- The machine works more economically if it is fully loaded.
- When small loads are washed, use only half to two thirds of the recommended amount of detergent.
- With adequate pre-treatment, stains and limited soiling can be removed; the laundry can then be washed at a lower temperature.
- Try not to use fabric softeners. If the laundry is machine dried, it will remain soft even without using fabric softeners.
- If the water has a medium or high degree of hardness (starting from degree of hardness II, see "Detergents and additives") water softeners must be added.
- The amount of detergent can then be adjusted to degree of hardness I (= soft).

Main features of your washing machine

- The speed of the final spin can be reduced both with cottons and with synthetics, delicates and woollens.
- Because of its gentle washing action, the **special wool cycle** washes your garments with extreme care, without felting them.
- **3-compartment drawer** for detergent and fabric softener.
- **Unbalance detection device:** secure position and silent operation of the appliance.

Description of the appliance

Front view

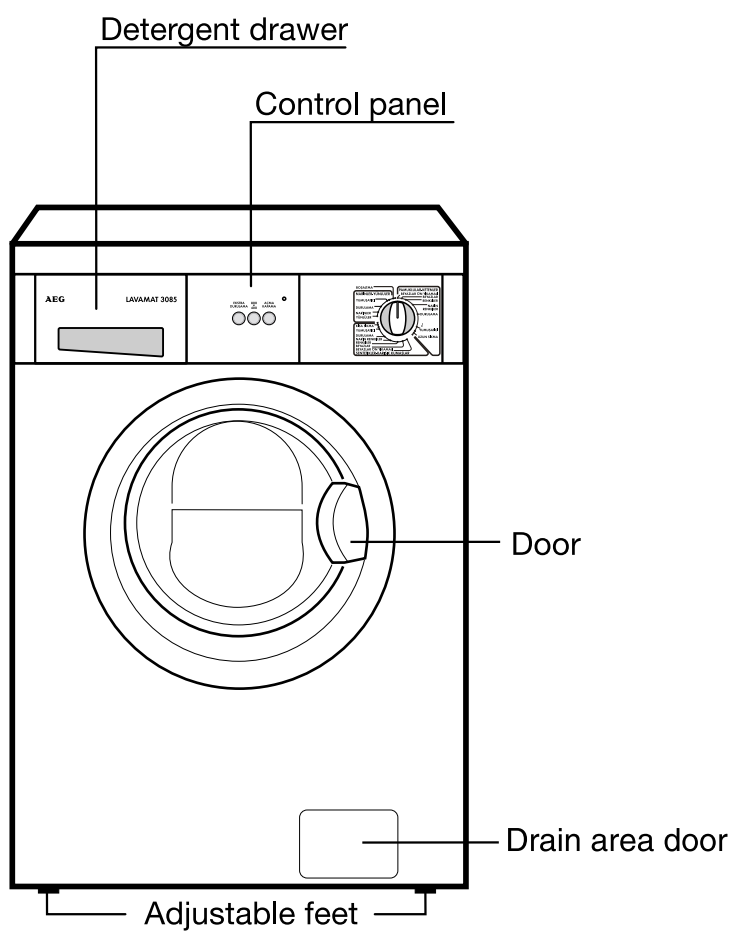

Description of the appliance

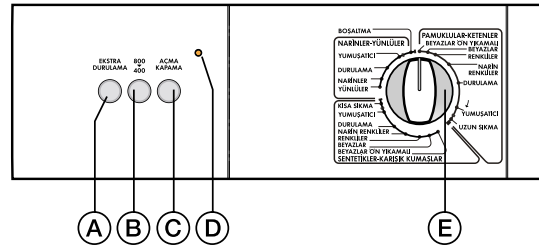
Control panel

- A = Extra rinse button (EKSTRA DURULAMA)
- B = Spin reduction button (800/400)
- C = ON/OFF (AÇMA KAPAMA) button
- D = Mains-on light
- E = Programme selector dial

Programme selector dial

The programme selector determines the type of washing cycle (e.g. water level, drum movement, number of rinses, spin speed) according to the type of laundry.

Warning! It must only be turned clockwise.

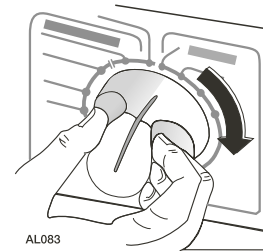

AL083

ON/OFF button (AÇMA KAPAMA)

Press this button to start the programme. Press it again to interrupt the programme and to switch the machine off at the end of the programme.

Warning!

Before selecting a programme or modifying a programme already started, the machine must be switched off by pressing the ON/OFF button.

Description of the appliance

Mains-on light

This light comes on when the ON/OFF (AÇMA KAPAMA) button, and goes out at the end of the cycle.

Spin reduction button 800/400



When this button is pressed, the spin speed will be reduced from 800 to 400 rpm.

Extra rinse button (EKSTRA DURULAMA)

When this button is pressed with cotton programmes one rinse is added.

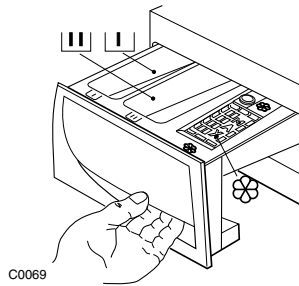
Detergent and additive dispenser drawer



-  Compartment for prewash detergent. It is emptied at the beginning of the wash programme.
-  Compartment for powder or liquid detergent used for main wash. It is emptied at the beginning of the wash cycle.
-  Compartment for liquid additives (fabric softener, starch). It is emptied at the last rinse.

The quantity of additives must not exceed the «MAX» mark in the drawer.

Before the first wash

Before your first wash, we recommend that you run a cotton cycle at 60°C, **without any laundry in the machine**, to remove any manufacturing residue from the drum and tub.

Pour 1/2 a measure of detergent into the dispenser drawer and start the machine.

Preparing the wash cycle

Sorting out and preparing the laundry

- Sort out the laundry according to type of fabrics and care labels (see "Types of fabric and care labels").
- Empty pockets.
- Remove any metal parts (safety pins, clips, etc.).
- To prevent the laundry from getting damaged and forming bundles, it is advisable to close zips, button up pillowcases and quilt covers and tie up loose straps such as those of aprons.
- Turn double faced items inside out (sleeping bags, anoraks, etc.)
- Turn coloured knitted fabrics, woollens and fabrics with trim inside out.
- Wash small and delicate items (baby socks, tights) inside a laundry net or in a pillow case closed with a zip, or in larger socks.
- Treat curtains with special care. Remove all metal or plastic hooks or put them in a net or a bag. We decline any responsibility in case of damage.
- Whites and coloureds must be washed separately: white items can lose their whiteness.
- New coloured fabrics often have excess dyes; it is advisable to wash them separately for the first time.
- Wash small and large items together; this improves the washing result and the laundry is better distributed during spinning.
- Shake out garments before putting them into the machine.
- Insert each garment separately.

Weight of laundry

Sort of laundry	Approximate dry weights
Bathrobes	1200 g
Work shirts	300-600 g
Quilt covers	700 g
Sheets	500 g
Blouses	100 g
Hand towels	200 g
Tea towels	100 g
Shirts	200 g
Pillowcases	200 g
Night-gowns/Pyjamas	200-250 g
Tablecloths	200-300 g
Underwear	250 g

Types of fabric and care labels

The labels on garments help you to select the most suitable wash programme. The laundry should be sorted out according to the type of fabric and the instructions indicated on care labels.

Temperatures indicated on labels are always maximum temperatures.

Whites

Linen and cottons marked with this symbol can be washed at high temperatures.

Coloureds

Linen and cottons marked with this symbol are colourfast and can be washed at 60°C.

Coloureds

Garments marked with these symbols have delicate colours, therefore the washing temperature must not exceed these values.

Synthetics

Mixed and synthetic fabrics marked with these symbols require a delicate wash programme and they must therefore be washed using the specific programme.

Preparing the wash cycle

Delicates

Microfibres, synthetics or curtains marked with these symbols require a particularly delicate treatment.



The DELICATES programme (HASSAS ÇAMAŞIRLAR) is suitable for this type of fabric.

Woollens and particularly delicate items

Fabrics such as wool, wool mix or silk marked with this symbol are particularly sensitive to machine washing.

The WOOLLENS programme (YÜNLÜLER) is suitable for this type of fabric.

Fabrics marked with the  symbol (wool) can be machine washed only if the label indicates "does not felt" or "machine washable".

If the label has the symbol  (hand wash) or  (do not wash), garments must not be machine washed!

Detergents and additives

Which detergent and additive?

Use only detergents and additives for washing machines. Follow the manufacturer's instructions.

How much detergent?

The quantity depends on:

- the load:
if the manufacturer does not provide any indications on the amount of detergent for small loads, use about one third less than the suggested amount for half loads and half the amount for very small loads;
- the degree of soil:
use a small amount of detergent for lightly soiled garments. Judge the amount according to the detergent manufacturer's instructions and size of the load;
- the water hardness:
the harder the water, the more detergent required. Instructions according to water hardness are given on the detergent pack.

Liquid detergent

Liquid detergent can be poured directly into the main wash compartment of the dispenser drawer **immediately** before starting the programme, or a special dispenser can be used that is placed directly in the drum. Measure the detergent according to the manufacturer's instructions.

Adding a water softener

A water softener must be added when water has a medium-high degree of hardness (from degree of hardness II). Follow the manufacturer's instructions. The quantity of detergent can then always be adjusted to degree of hardness I (= soft). Information on water hardness can be obtained from your local water supply authority.

Information on water hardness



Degree of hardness	German degrees °dH	French degrees °TH
I=Soft	0-7	0-15
II=Medium	7-14	16-25
III=Hard	14-21	26-37
IV=Very hard	more than 21	more than 37

i How to wash

Load the laundry

- ☞ Open the door.
- ☞ Place the laundry in the drum, one item at a time. Distribute laundry as evenly as possible. Close the door.

Add detergent and additive

- ☞ Pull the drawer out till it stops.
- ☞ Measure out the amount of detergent required and pour it into the main wash compartment .
- If you wish to perform a prewash, pour detergent also into compartment .

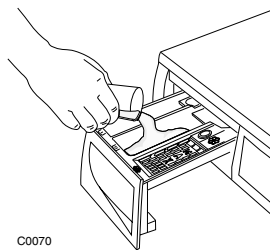

- ☞ Pour the fabric softener into compartment  without exceeding the "MAX" mark.
- ☞ Close the drawer, pushing it fully in.

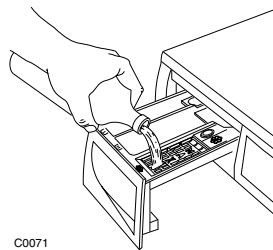

Select the wash programme

- ☞ Turn the programme selector dial **to the right** to the required programme.

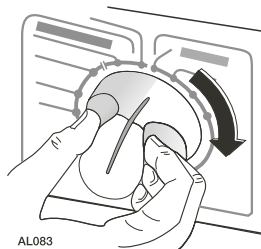

Select the required option

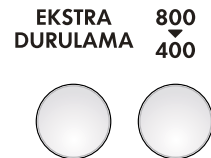

Start the programme

- ☞ Press the ON/OFF (AÇMA KAPAMA) button: the mains-on light comes on and the programme starts.



End of the programme

The machine stops automatically.

The mains-on light goes out.

- ☞ If you have selected a programme that ends with water in the drum before opening the door:
 - Select the drain programme (BOŞALTMA) or a Spin programme (SIKMA).
- ☞ Press the ON/OFF (AÇMA KAPAMA) button again to switch the machine off.
- ☞ Release any buttons which have been pressed.
- ☞ Open the door.
 - Wait two minutes before opening the door to give the safety locking device time to release.
- ☞ Remove the laundry.
- ☞ Check that the drum is completely empty, by rotating it manually, in order to avoid any garments left in the drum being damaged (for example shrunk) during a subsequent wash, or their colour running into a subsequent load of laundry.
- ☞ Close the water tap(s) and unplug the appliance. Leave the door ajar to let air circulate in the drum.

Programme chart

Energetic programmes for cottons and linen

Maximum load: 5 kg

Progr.	Temp.	Type of laundry	Cycle description	Possible option
Beyazlar n yıkamalı	90°	Whites with prewash Beyazlar n yıkamalı	Prewash Wash at 90°C 3 rinses Long spin	EKSTRA DURULAMA 800 400
Beyazlar ve renkliler	90°	Whites Beyazlar ve renkliler	Wash at 90°C 3 rinses Long spin	EKSTRA DURULAMA 800 400
Renkliler (*)	60°	Colour- fast coloureds	Wash at 60°C 3 rinses Long spin	EKSTRA DURULAMA 800 400
Narin renkliler	40°	Delicates coloureds	Wash at 40°C 3 rinses Long spin	EKSTRA DURULAMA 800 400
Durulama		Rinses Durulama	4 rinses with additive Long spin	800 400
Yumuřatıcı		Rinse with softener Yumuřatıcı	1 Rinse with additive Long spin	800 400
Uzun Sıkma		Long spin Uzun Sıkma	Empty and long spin	800 400

The temperatures indicated are the most suitable for each programme and depend on the type of laundry and the degree of soil.

(*) Wash programme at 60°C is the reference programme for the Energy Label data, in compliance with standard EEC 92/75.

Programme chart

Delicate programmes for synthetics, mixed fabrics, delicates, woollens

Maximum load: 2 kg - wool 1 kg.

Progr.	Temp.	Type of laundry	Cycle description	Options
Beyazlar n yıkamalı	60°	Synthetics with prewash Beyazlar n yıkamalı	Prewash Wash at 60° C 3 rinses Water in the drum	800 400
Beyazlar	60°	Whites	Wash at 60°C 3 rinses Water in the drum	800 400
Renkliler	40°	Coloureds	Wash at 40°C 3 rinses Water in the drum	800 400
Narin Renkliler	30°	Worn once (short cycle)	Wash at 30°C 3 rinses Water in the drum	800 400
Durulama		Rinses Durulama	3 rinses with additive Water in the drum	800 400
Yumuřatıcı		Rinse with softener Kolalama yumuřatıcı	1 Rinse with additive Water in the drum	800 400
Kısa Sıkma		Short spin Kısa Sıkma	Empty and short spin	800 400
Ynller	40°	Wool Ynller	Wash at 40°C 3 rinses Water in the drum	800 400
Narinler	40°	Delicate program. Narinler	Wash at 40°C 3 rinses Water in the drum	800 400
Durulama		Rinses Durulama	3 rinses with additive Water in the drum	800 400
Yumuřatıcı		Rinse with softener Kolalama yumuřatıcı	1 Rinse with additive Water in the drum	800 400
Bořaltma		Drain Bořaltma		

The temperatures indicated are the most suitable for each programme and depend on the type of laundry and the degree of soil

Consumption data and duration of main programmes

The values shown in the chart have been obtained in laboratory tests and have been estimated at a water supply temperature of 15°C. They may vary when the appliance is used at home, but they can be used as indicative values.

Programme/ Temperature	Maximum quantity	Water litres	Energy kWh	Duration minutes
Whites at 90°C	5 kg	56	2,2	135
Whites at 60°C (*)	4,5 kg	56	0,85	135
Non fast coloureds at 40°C	5 kg	56	0,8	110
Synthetics at 60°C	2 kg	52	0,7	75
Delicates at 40°C	2 kg	52	0,5	55
Wool at 40°C	1 kg	52	0,5	50

(*) Wash programme at 60°C is the reference programme for the Energy Label data, in compliance with standard EEC 92/75.

Cleaning and maintenance

After each wash

- ☞ At the end of the wash programme, pull the dispenser drawer out a little to let it dry.
- ☞ Leave the door ajar to allow air to circulate.

If the machine is not used for a prolonged period:

- ☞ Close the water tap and unplug the appliance.

Periodical cleaning

Bodywork

Clean the outside of the machine with warm water and a neutral, non-abrasive household detergent. Rinse with clean water and dry with a soft cloth.

Important: do not use methylated spirits, solvents or similar products to clean the bodywork.

Detergent dispenser drawer

The washing powder and additive dispenser drawer should be cleaned regularly. Remove the drawer by pressing the catch downwards and by pulling it out. Flush it out under a tap, to remove any traces of accumulated powder.

To aid cleaning, the top part of the additive compartment should be removed.

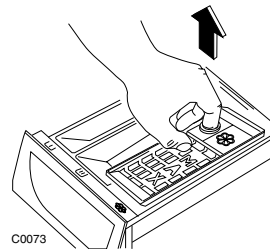
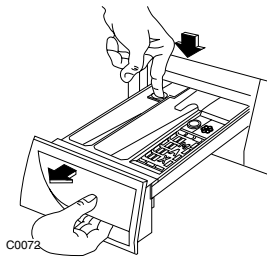

Cleaning and maintenance

Detergent can also accumulate inside the drawer recess: clean it with an old toothbrush. Refit the drawer after cleaning.

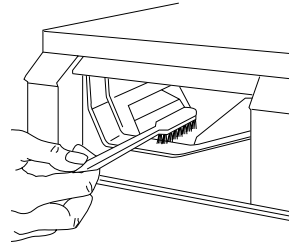

Cleaning the pump

The pump should be inspected regularly and particularly if

- the machine does not empty and/or spin
- the machine makes an unusual noise during draining due to objects such as safety pins, coins etc. blocking the pump.

Proceed as follows:

- Disconnect the appliance.
- If necessary wait until the water has cooled down.
- Open the pump door.
- Place a container close to the pump to collect any spillage.
- Pull out the emergency emptying hose, place it in the container and remove its cap.
- When no more water comes out, unscrew the pump cover and remove it. Always keep a rag nearby to dry up spillage of water when removing the cover.
- Remove any objects from the pump impeller by rotating it.

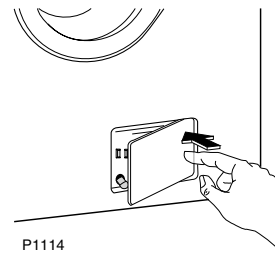

P1114

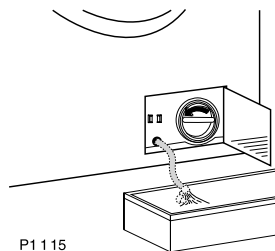

P1115

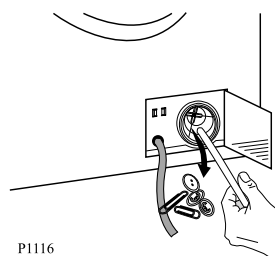

P1116

Cleaning and maintenance

- Put the cap back on the emergency emptying hose and place the latter back in its seat.
- Screw the pump cover fully in.
- Close the pump door.

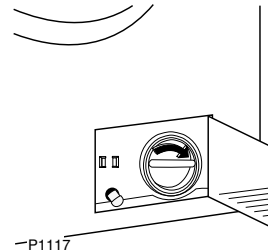

Warning

When the appliance is in use and depending on the programme selected there can be hot water in the pump circuit. Never remove the pump cover during a wash cycle, always wait until the appliance has finished the cycle, and is empty. When replacing the pump cover, after a cleaning inspection, ensure it is securely retightened so as to stop leaks and young children being able to remove it.

Cleaning the water inlet filter(s)

If your water is very hard or contains traces of lime deposit, the water inlet filter(s) may become clogged.

It is therefore a good idea to clean them from time to time.

Turn off the water tap(s). Unscrew the water inlet hose(s). Clean the filter(s) using a hard bristle brush.

Tighten up the inlet hose(s).

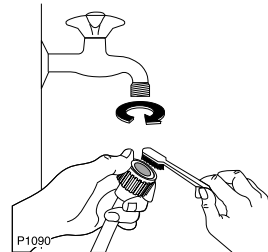

Emergency emptying out

If the water is not discharged, proceed as follows to empty out the machine:

- pull out the plug from the power socket;
- close the water tap(s);
- if necessary, wait until the water has cooled down;
- open the pump door;
- place a bowl on the floor and place the end of the emergency emptying hose into the bowl. Remove its cap. The water should drain by gravity into the bowl. When the bowl is full, put the cap back on the hose. Empty the bowl. Repeat the procedure until water stops flowing out;
- clean the pump if necessary as previously described;
- replace the emergency emptying hose in its seat after having plugged it;
- screw the pump cover again and close the door.

The dangers of freezing

If the machine is exposed to temperatures below 0°C, certain precautions should be taken.

- Turn off the water tap(s).
- Unscrew the inlet hose(s).
- Place the end of the emergency emptying hose and that of the inlet hoses in a bowl placed on the floor and let water drain out.
- Screw the water inlet hose(s) back on and reposition the emergency emptying hose after having put the cap on again.
- When you intend to start the machine up again, make sure that the room temperature is above 0°C.

Something not working?

- i** If, during the spin cycle, the machine makes an unusual whistling noise, different from the noise made by traditional washing machines, this is due to a new type of motor.

If water is not visible in the drum, this is due to the modern technology of new washing machines that use less water than traditional machines.



Troubleshooting

If a problem arises, you can try to solve it yourself following the instructions below. If you call out an engineer when one of the following problems arises, or to repair a fault due to incorrect use, the call-out will be charged even if requested within the guarantee period.

Problem	Possible cause	Solution
The machine does not work	The plug is not connected.	Insert the plug.
	The main electrical fuse has blown.	Replace the fuse.
	The door is not properly closed.	Close the door; the click of the lock should be heard.
	The ON/OFF button has not been pressed.	Press the button.
	The programme selector dial has not been set correctly.	Set the selector dial to the chosen programme.
The machine does not fill	The water tap(s) is closed.	Open the water tap(s).
	The water inlet hose(s) is squashed or kinked.	Check the whole length of the hose(s) and remove the kink.
	The small filter(s) of the water inlet hose(s) is clogged.	Clean the filter(s).
	The door is not properly closed.	Close the door.
The machine fills then empties immediately	The end of the drain hose is too low.	Place the hose at the right height (see Installation section).

Something not working?

Problem	Possible cause	Solution
The machine does not empty and/or does not spin	The drain hose is squashed or kinked.	Check the whole length of the hose and remove the kink.
	The drain filter or the drain hose are clogged.	Clean the filter or check the hose.
	You have selected a programme that ends with water in the drum.	Empty out the water by selecting a short spin programme or selecting the drain programme (Boşaltma).
	The laundry is not evenly distributed inside the drum.	Redistribute the laundry manually in the drum.
There is water on the floor	Too much detergent has been used.	Measure detergent according to the manufacturer's instructions.
	An unsuitable detergent has been used that creates too much foam.	Use a suitable washing machine detergent.
	One of the connectors on the water inlet hose(s) is leaking.	Check that the hose(s) is firmly screwed on at both ends.
	The drain filter has not been properly screwed on after cleaning.	Fully screw the filter into place.
The machine vibrates or is noisy	The transit bolts have not been removed.	Check that the machine has been unpacked as described in the Installation section.
	The feet have not been adjusted.	Carefully level the machine.
	There is little laundry in the drum.	Correct operation of the machine is not affected.
	The machine is in contact with the wall or furniture.	Move the machine slightly away from the wall or furniture.

Something not working?

Problem	Possible cause	Solution
The door will not open	The programme is still running.	Wait until the end of the programme before opening the door.
	The door lock has not yet released.	Wait about 2 minutes for the door lock to release.
	You have selected a programme that ends with water in the drum.	Empty out water in order to be able to open the door.
Spinning starts late or the machine does not spin	The unbalance detection device that prevents excessive vibration during spinning and ensures a stable position has cut in.	<p>If the laundry is not evenly distributed inside the drum at the beginning of the spin cycle, the machine detects this and tries to redistribute it more evenly by means of a few drum rotations.</p> <p>Only when the laundry is more evenly distributed, the spin cycle will be performed.</p> <p>If, after about 6 minutes, the laundry is still tangled, the machine will not spin. Therefore, if the laundry is still wet at the end of the cycle, it is advisable to redistribute it manually inside the drum and to select the spin programme again.</p>

Something not working?

Unsatisfactory washing results

If the laundry looks grey and lime scale is found in the drum

- Too little detergent has been used.
- An unsuitable detergent has been used.
- Stubborn stains have not been treated prior to washing.
- The programme or the temperature have not been correctly selected.

If grey stains remain on the laundry

- Laundry stained with ointments, grease or oil has been washed with an insufficient amount of detergent.
- The temperature selected for the wash programme was too low.
- Fabric softener - especially the concentrated type - has come into direct contact with the laundry. Wash these stains immediately and pour fabric softener carefully.

Foam is still visible even after the last rinse

- Modern detergents often produce foam, even in the last rinse. However the laundry has been completely rinsed.

White residue is left on the laundry

- This is due to insoluble components in modern detergents and is therefore not the result of insufficient rinsing. Shake or brush the laundry. In future, it may be better to turn garments inside out before washing them. Check the choice of detergent; try using liquid detergents.

Technical data

Height x Width x Depth	85x60x60 cm
Depth with door opened	100 cm
Height adjustment	± 10 mm approx.
Net weight	63 kg approx.
Load (depending on programme)	5 kg max.
Use	domestic
Drum speed during washing	max. 55 rpm
Drum speed during spinning	800 rpm max.
Water pressure (Cold)	1 - 10 bar (=10-100N/cm ² = 0.1-1.0Mpa)
Water pressure (Hot)	0,3 - 10 bar (=3-100N/cm ² = 0,03-1.0Mpa)

Consumption data for washing 4.5 kg normally soiled cotton items at 60°C

Energy	0,85 kWh
Water	56 litres

- CE** This appliance complies with the following EC directives:
- 73/23/EEC of 19.2.1973 "Low voltage directive", including directive 93 / 68 / EEC
 - 89/336/EEC of 3.5.1989 "Electromagnetic Compatibility Directive".

Service

In the section "Something not working?" some problems that can be solved by yourself are listed. Read this section in the event of problems. If you are not able to find a solution, contact the Service centre. (Addresses and telephone numbers are given on the enclosed leaflet).

In all cases, set your speech before calling, in order to facilitate troubleshooting: the engineer will be able to decide whether a service call is necessary.

Take note of the serial number (Ser. N.) and the product number (Pr. N.) indicated on the rating plate.

Ser. N.

Pr. N.

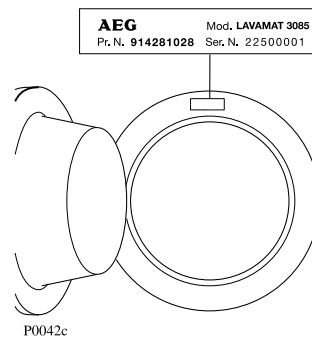

Furthermore, try to specify, as precisely as possible:

- The symptoms of the fault
- When the fault occurs

When can a service visit be charged during the guarantee period?

- when it should have been possible to solve the problem by yourself, with the help of the troubleshooting chart (see section "Something not working?")
- when the engineer has to come out several times because he has not been given all the relevant information he needs and so, for example, has to fetch spare parts. Repeated trips can be avoided if you prepare your call to the Service centre as described above.

Instructions for installation and electrical connection



Safety instructions

- When unpacking the appliance, check that it is not damaged. If in doubt, do not use it and contact the retailer.
- All internal packing must be removed before using the appliance. Serious damage may be caused to the machine or adjacent furniture if the protective transit devices are not removed or are not completely removed. Refer to the relevant paragraph.
- Any electrical work required to install this appliance must be carried out by a qualified electrician.
- Any plumbing work required to install this appliance must be carried out by a qualified plumber.
- After having installed the machine, check that it is not standing on its electrical supply cable.
- If the appliance is placed on a carpeted floor, ensure that air can circulate freely between the adjustable feet and the floor.
- The power supply cable must be replaced only by our Service Centre.

Dimensions of the appliance

Front view and side view

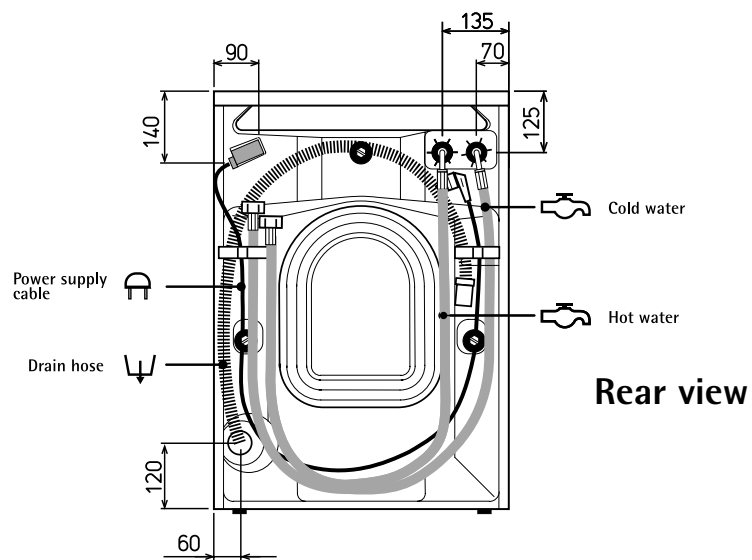
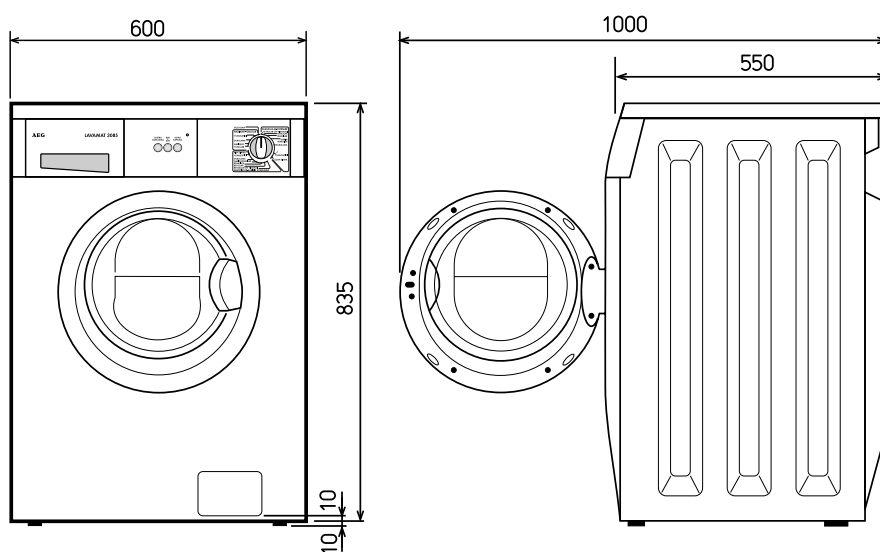

Installation

Unpacking

- ⚠ All transit bolts and packing must be removed before using the appliance.
- 👉 Using a spanner, unscrew and remove the rear right-hand bolt and lay the machine on its back, taking care not to squash the hoses. This can be avoided by placing one of the corner packing pieces between the machine and the floor.

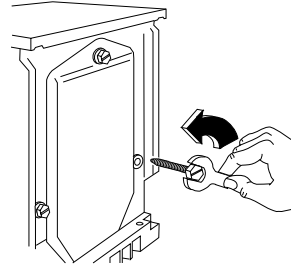

- 👉 Remove the polystyrene block from the bottom of the machine and release the two plastic bags by removing the adhesive strip.

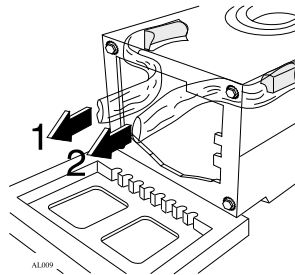

- 👉 Carefully remove the left-hand bag (1) then the right-hand bag (2) by pulling them towards the centre of the machine.

- 👉 Set the machine upright and remove the two remaining bolts from the back.

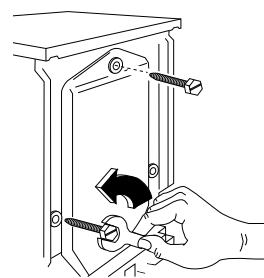

- 👉 Pull out the three plastic spacers from the holes into which the bolts were fitted.

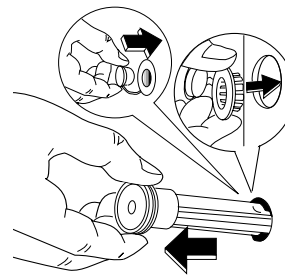

- 👉 Plug the open holes with the plugs which you will find in the envelope containing the booklet.

You are advised to keep all transit devices so that they can be refitted if the machine ever has to be transported again.

Positioning

Install the machine on a flat hard floor.

Make sure that air circulation around the machine is not impeded by carpets, rugs etc. Check that the machine does not touch the wall or other kitchen units.

- The floor surface must be clean and dry, without any wax or polish residue to avoid any possibility of sliding. Do not use viscous substances to move the appliance into place by sliding it across the floor.
- It is inadvisable to place the machine on long-haired rugs or carpet or on layers of foam-rubber as this would affect its stability.
- Before placing it on small tiles, apply a rubber coating.
- If the appliance is positioned on flexible floors, especially wooden beams with flexible floorboards, use a 15 mm thick, water resistant panel of wood, screwed to at least two of the floor beams. If possible, position the machine in a corner of the room, where the beams are more solidly fixed and tend to be more stable.
- Never try to correct any unevenness in the floor by putting pieces of wood, cardboard or similar materials under the machine.
- If it is impossible to avoid positioning the machine next to a gas cooker or coal-burning stove, an insulating panel (85x57 cm) covered with aluminium foil on the side facing the cooker or stove, must be inserted between the two appliances;
- The machine must not be installed in rooms where the temperature can drop below 0.
- The water inlet hose and the drain hose must not be kinked.

Levelling

Level the appliance by loosening or tightening the feet.

Once in the right position fix the feet by pushing the nuts against the base of the case.

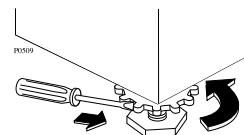
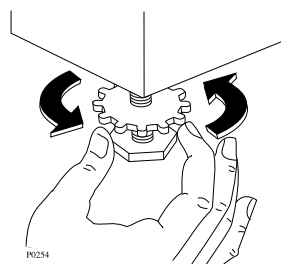

Never place cardboards, wood or similar material under the machine to compensate for any unevenness in the floor.

Installation

Water inlet

The inlets on the back of the appliance are colour coded, blue for cold and red for hot.

Before connecting the hoses, be sure to fit the filters "A" supplied as per diagram. If only a cold water supply is available, connect the two hoses to a cold water outlet by means of a 'Y' connection piece.

The other end of the inlet hose(s) which connects to the machine can be turned in any direction. Simply loosen the fitting, rotate the hose and retighten the fitting, making sure there are no water leaks.

The inlet hose(s) must not be lengthened. If it is too short and you do not wish to move the tap, you will have to purchase a new, longer hose specially designed for this type of use.

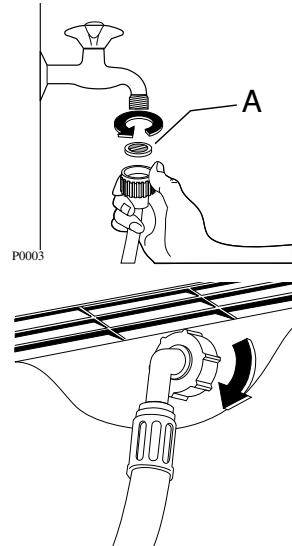
**Water drainage**

The end of the drain hose can be positioned in three ways:

Hooked over the edge of a sink using the plastic hose guide supplied with the machine. In this case, make sure the end cannot come unhooked when the machine is emptying.

This could be done by tying it to the tap with a piece of string or attaching it to the wall.

In a sink drain pipe branch. This branch must be above the trap so that the bend is at least 60 cm above the ground.

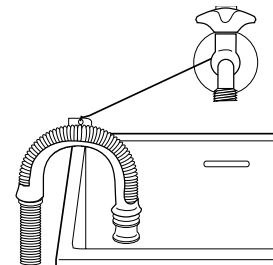

Directly into a drain pipe at a height of not less than 60 cm and not more than 90 cm.

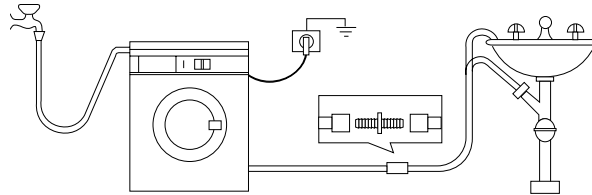

The end of the drain hose must always be **ventilated**, i.e. the inside diameter of the drain pipe must be larger than the outside diameter of the drain hose. The drain hose must not be kinked. Run it along the floor; only the part near the drainage point must be raised.

Electrical connection

This machine is designed to operate on a 230 V, single-phase, 50 Hz supply.

Check that your domestic electrical installation can take the maximum load required (2.100 kW), also taking into account any other appliances in use.

Connect the machine to an earthed socket.



The manufacturer declines any responsibility for damage or injury through failure to comply with the above safety precaution.

Permanent connection

In the case of a permanent connection it is necessary that you install a double pole switch between the appliance and the electricity supply (mains), with a minimum gap of 3 mm between the switch contacts and of a type suitable for the required load in compliance with the current electrical regulations.

The switch must not break the yellow and green earth cable at any point.

This operation has only to be performed by a qualified electrician.

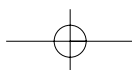
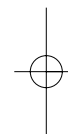
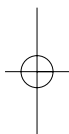

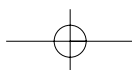
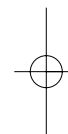
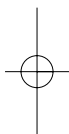

Electrolux A.Ş.'nin Electrolux ve AEG Markalı mamulleri için verdiđi garanti, ařađıda yazılı hususları kapsamaz.

- Kullanma Kılavuzunda belirtilen talimatların dıřındaki kullanımlar,
- Tüketiciye teslimden sonra oluřabilecek kırık, çizik ve hasarlar (tařıma, çarpma, dıřürme, vs)
- Mamulü; uygun olmayan elektrik tesisatında veya kullanılması öngörülen voltaj dıřında kullanma,
- Gereken onarım için Yetkili Servise bařvurmadan önce Electrolux Yetkili Servis Personeli dıřında bir kimsenin cihazın onarımına, bakımına veya tadiline kalkıřmış olması durumlarında,
- Yukarıda belirtilen maddeler kapsamında olan arızalar ücret karřılıđı yapılır.
- İşçilik ve üretim hatalarına karřı cihaz 3 (ÜÇ) YIL SÜRE İLE GARANTİ EDİLMİŐTİR.
- Arızaların giderilmesi konusunda uygulanacak teknik yöntemlerin tesbiti ve deđiřtirilecek parçaların saptanması tamamen firmamıza aittir.
- Garanti Belgesi üzerinde tahrifat yapıldığı mamul üzerindeki orijinal seri numarası kaldırıldıđı veya tahrip edildiđi takdirde bu belge hükümden dıřer.

MALIN

Cinsi : ÇAMASIR MAKINASI

Markası :

Modeli :

Bandrol ve Seri No. :

Teslim Tarihi ve Yeri :

Garanti Süresi :

Azami Tamir Süresi :

SATICI FİRMANIN

Ünvanı :

Adresi :

Telefonu :

Telefaksı :

Fatura Tarihi ve No :

Tarih-Kaře-İmza :

GD 3

GD 2

GD 1

GARANTİ ŞARTLARI

1. Garanti süresi, malın teslim tarihinden itibaren başlar ve 3 (ÜÇ) yıldır.
2. Malın bütün parçaları dahil olmak üzere tamamı Firmamızın garantisine kapsamındadır.
3. Malın garanti süresi içerisinde arızalanması durumunda, tamirde geçen süre garanti süresine eklenir. Malın tamir süresi en fazla 30 iş günüdür. Bu süre, mala ilişkin arızanın servis istasyonuna, servis istasyonunun olmaması durumunda, malın satıcısı, bayii, acentası, temsilciliği, ithalatçısı veya imalatçısından birisine bildirim tarihinden itibaren başlar. Sanayi malının arzmasının 15 iş günü içerisinde giderilmemesi halinde, imalatçı veya ithalatçı, malın tamiri tamamlanıncaya kadar, benzer özelliklere sahip başka bir sanayi malını tüketicinin kullanımına tahsis etmek zorundadır.
4. Malın garanti süresi içerisinde, gerek malzeme ve işçilik, gerekse montaj hatalarından dolayı arızalanması halinde, işçilik masrafları, değiştirilen parça bedeli yada başka herhangi bir ad altında hiçbir ücret talep etmeksizin tamiri yapılacaktır.
5. Malın :
 - Teslim tarihinden itibaren garanti süresi içinde kalmak kaydıyla bir yıl içerisinde, aynı arızayı ikiden fazla tekrarlaması veya farklı arızaların dörtten fazla ortaya çıkması sonucu maldan yararlanamamanın süreklilik kazanması,
 - Tamiri için gereken azami sürenin aşılması,
 - Servis istasyonunun mevcut olmaması halinde sırasıyla satıcısı, bayii, acentası, temsilciliği, ithalatçısı veya imalatçısından birisinin düzenleyeceği raporda arızanın tamirinin mümkün bulunmadığının belirlenmesi, durumlarında ücretsiz olarak değiştirme işlemi yapılacaktır.
6. Malın kullanma kılavuzunda yer alan hususlara aykırı kullanılmasından kaynaklanan arızalar garanti kapsamı dışındadır.
7. Garanti Belgesi ile ilgili olarak çıkabilecek sorunlar için Sanayi ve Ticaret Bakanlığı Tüketicinin ve Rekabetinin Korunması Genel Müdürlüğü'ne başvurulabilir.

VİZE

..... Yılı Vizesi Yılı Vizesi
-------------------	-------------------

İmalatçı/İthalatçı Firma
Electrolux Dayanıklı Tüketim
Mamulleri Sanayi ve Ticaret A.Ş.

Tarlabası Caddesi No. 35 80080 Taksim - İstanbul
Tel: (0212) 293 10 20 pbx Telefaks: (0212) 251 60 94
Ücretsiz Tüketici Danışma Servisi 0800 211 60 32

Garanti Belgesinin geçerlilik süresi 3 yıldır ve onay tarihi esas alınarak her yıl vize edilir. Geçerlilik süresinin dolmasına müteakip 3 ay içerisinde vizesi yapılmayan belgeler geçersiz sayılır. Belgesi iptal edilen veya geçersiz sayılan imalatçı ve/veya ithalatçılara aynı ürün için 6 ay süre ile yeni belge tanzim edilemez.

Belgenin Onay Tarihi ve Sayısı

12.02.2002 2390

ÇAMASIR MAKINASI

Bu belgenin kullanılmasına 4077 sayılı Tüketicinin Korunması Hakkında Kanun ve bu Kanun'a dayanılarak yürürlüğe konulan Garanti Belgesi Uygulama Esaslarına Dair Tebliğ uyarınca, T.C. Sanayi ve Ticaret Bakanlığı Tüketicinin ve Rekabetinin Korunması Genel Müdürlüğü tarafından izin verilmiştir.

FİRMA YETKİLİSİ

Yönetim Kurulu Üyesi - Murahhas Aza
Nevio Pollesel
İmza

Bölüm Genel Müdürü
Birgül Küçükönder
İmza

MONTAJ ANINDA YETKİLİ SERVİS TARAFINDAN DOLDURULACAKTIR.**ÇİHAZA AİT BİLGİLER****MÜŞTERİNİN**

CİNSİ :

ADI, SOYADI :

MODEL :

ADRESİ :

SERİ NO :

MONTAJ TARİHİ :

RAPOR NO :

TEL NO :

Free Manuals Download Website

<http://myh66.com>

<http://usermanuals.us>

<http://www.somanuals.com>

<http://www.4manuals.cc>

<http://www.manual-lib.com>

<http://www.404manual.com>

<http://www.luxmanual.com>

<http://aubethermostatmanual.com>

Golf course search by state

<http://golfingnear.com>

Email search by domain

<http://emailbydomain.com>

Auto manuals search

<http://auto.somanuals.com>

TV manuals search

<http://tv.somanuals.com>