

LAVAMAT 40810
LAVAMAT 40820

The environmentally friendly washing machine

User information

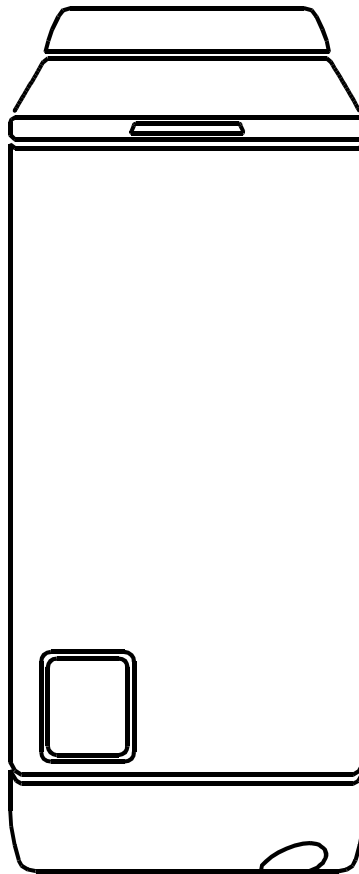

PERFEKT IN FORM UND FUNKTION

SUMMARY

Warnings	3
Usage	3
Precautions against frost	4
Scrapping	4
Protection of the environment	5
Washing machine description	6
The detergents dispenser	6
Control panel	7
Programme selector	7
Additional programme pushbuttons	9
Consumptions and programme durations	11
Washing guide	12
How to do a wash	15
Programmes tables	17
Care and cleaning	19
Operating problems	22
Installation and connection instructions	25
Warnings	25
Washing machine dimensions	26
Installation	27
Technical characteristics	31
Garantee conditions and After Sales Service	31

1. Warnings

Keep this user's manual with your washing machine. If you sell your washing machine or give it away, make sure that it is accompanied by its user's manual. The new user can then be informed of how the washing machine operates and read relevant warnings.

These warnings have been written for your safety and for the safety of others. Please read these comments carefully before installing and using your washing machine. Thank you for your attention.

1.1. Usage

- When you receive your washing machine, unpack it or have it unpacked immediately. Check its general appearance. Make any reserves in writing on the delivery form and keep a copy.
- Your washing machine was designed for use by adults. Make sure that children do not touch it or use it as a toy.
- Do not modify or attempt to modify the characteristics of this washing machine. This could be dangerous for you.
- Your washing machine is intended for normal domestic use. Do not use it for commercial or industrial purposes or for any purpose other than that for which it was designed : to wash, to rinse and to spin.
- Unplug the power supply plug and close the water supply tap every time after using your washing machine.
- Only wash articles that can resist machine washing. Refer to the instructions on the label for each article.
- Do not wash underwear with bones, or any material without hems, or torn materials in your washing machine.
- Remember to remove all coins, safety pins, boraches, screws, etc.,

before each wash. They can cause serious damage if they are left in your washing.

- Do not put articles in your washing machine if you have used a solvent, alcohol, trichloroethylene, etc., to remove stains from them. If you must use these stain removers, wait until the product has evaporated before putting the articles in the drum.
- Collect all small articles such as socks, belts, etc., in a small cloth bag or pillow case.
- Use the quantity of detergent indicated in the «proportioning of detergents» section.
- Always unplug the washing machine before cleaning it and doing any maintenance.

1.2. Precautions against frost

If your washing machine is exposed to temperatures below 0°C, take the following precautions :

- Close the tap and disconnect the water supply pipe.
- Put the end of this pipe and the drain pipe into a bowl on the floor.
- Select the «Drain» programme and make sure it works until it is complete.
- Switch the washing machine off by putting the program selector to the «Off»^{*} position or pressing on the «On/Off»^{*} key.
- Unplug the washing machine.
- Screw in the water inlet pipe and install the drain pipe.

Water that remained in the pipes will then be evacuated, thus preven-

*depending on model

ting the formation of frost or ice that can damage your washing machine.

The next time you want to use your washing machine, make sure that it is installed in a room in which the temperature is above 0°C.

1.3. Scrapping

All materials marked with the  symbol can be recycled. Put them in a waste tip (ask for information from your municipal offices) so that they can be recovered and recycled.

When you take your washing machine to the tip, make sure that everything that could be dangerous is out of service ; cut the power supply cable flush with the surface of your washing machine.

The symbol  on the product or on its packaging indicates that this product may not be treated as household waste. Instead it shall be handed over to the applicable collection point for the recycling of electrical and electronic equipment. By ensuring this product is disposed of correctly, you will help prevent potential negative consequences for the environment and human health, which could otherwise be caused by inappropriate waste handling of this product. For more detailed information about recycling of this product, please contact your local city office, your household waste disposal service or the shop where you purchased the product.

1.4. Protection of the environment

We recommend that the following instructions should be followed to achieve savings in water and energy and therefore to contribute to protection of the environment:

- If possible, use the washing machine at full capacity rather than with partial loads (however, do not overload the drum).
- Only use the Prewash or Soak function for very dirty washing.
- Use a detergent dose adapted to the water hardness (see «proportioning of detergents» section) and to the amount of washing and how dirty it is.

2. Washing machine description

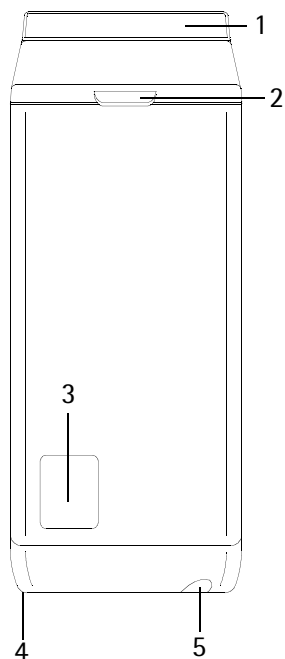



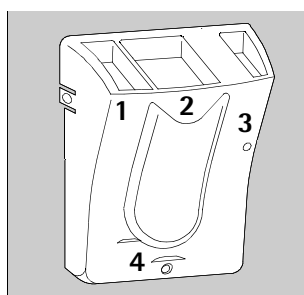

- 1 - Control panel
- 2 - Lid opening handle
- 3 - Filter door
- 4 - Leveling screws
- 5 - Lever for moving the washing machine

2.1. The detergents dispenser



Symbols

- 1 - prewash 
 - 2 - wash 
 - 3 - softener 
- (do not exceed the MAX mark)
- 4 - softener overflow 
(if overfilled).

3. Control panel

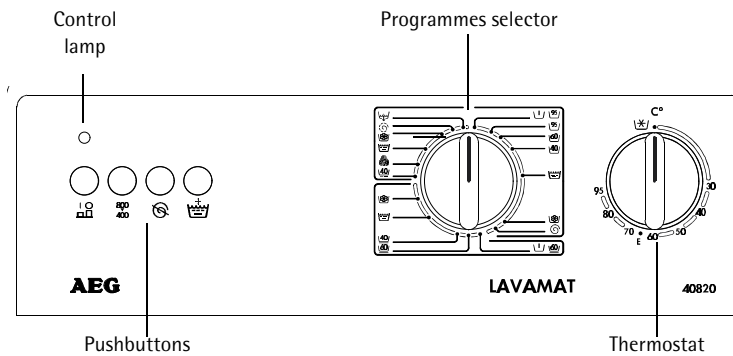

3.1. Programmes selector

It is used to select the most suitable programme to the type and soiling of your laundry.

Warning : never turn the programme selector in the anticlockwise direction.

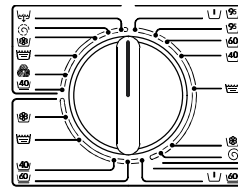

1 95 - COTTON / LINEN WITH PREWASH

Prewash at 40°C - Main washing for cotton / linen to be boiled from 30°C to 95°C.

95 - COTTON / LINEN

Main washing for cotton / linen to be boiled from 30°C to 95°C.

60 - COTTON / COLOREDS

Main washing for cotton or coloreds from 30°C to 60°C.

40 - COLOREDS

Main washing for coloreds from 30°C to 40°C.

 - SYNTHETICS WITH PREWASH

Prewash at 40°C - Main washing for synthetics from 30°C to 60°C.

 - SYNTHETICS

Main washing for synthetics from 30°C to 60°C.

 - SYNTHETICS

Main washing for synthetics from 30°C to 40°C.

 - DELICATES

Main washing for delicates from 30°C to 40°C.

 - WOOL

Main washing for machine washable wool at 40°C.

 - RINSES

3 separate rinses which can, for instance, be used to rinse and spin handwash garments.

 - SOFTENER

1 separate rinse which can, for instance, be used to rinse and spin handwash garments.

 - SPINNING

Separate spin for cotton and coloureds programmes.

 - SHORT SPINNING

Separate short spin for synthetics, delicates and wool programmes.

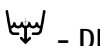
 - DRAIN

Drain water without spin afterwards.

3.2. Additional programme pushbuttons

These pushbuttons can adapt the washing programme to the degree of dirtiness of the laundry. But it is not necessary to select them in case of garments normally soiled.

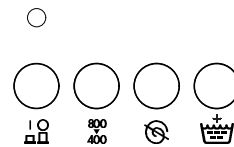

Depending on the selected programme, different functions can be combined.

800 400 - SPINNING SPEED REDUCTION PUSHBUTTON 800/400

The pushbutton 800/400 allows to realize a spinning to 400 rpm (pressed pushbutton) or to 800 rpm (released pushbutton) on the cotton programmes.

If you wish end the synthetics, delicates and wool programmes by a short spinning, the spinning speed will be either 600 rpm (released pushbutton) either 400 rpm (pressed pushbutton).

- SPINNING SUPPRESSION

This pushbutton eliminates spin drying on all programmes. They terminate then with a drain.

- RINSE PLUS

This option adds more water in rinses on Cotton programmes. It is advised for allergic people to detergent products and in areas with fresh water.

3.3. Thermostat

Use the thermostat to choose the temperature of the washing water. You can choose any temperature between cold «» and 95°C. You can use the «E» position if you want to realize an economical programme.

The temperatures given in the programmes table are provided as a guide. You can vary them using the thermostat knob on your washing machine. Always scrupulously respect the temperature shown on the label on each item of washing.

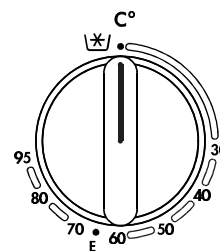

3.4. Progress within the programme

The programme selector turns gradually and shows you how far the programme has advanced.

4. Consumptions and programme durations

Timer / Temperature	Washing load in kg	Water consumption in liters	Energy consumption in kWh	Duration in minutes
WHITE/COLOURED 95	4,5	63	2,00	130
WHITE/COLOURED 60*	4,5	59	1,20	130
WHITE/COLOURED 40	4,5	59	0,70	85
SYNTHETICS 60	2,0	47	1,00	80
DELICATES 30	2,5	47	0,40	55
WOOL 30	1,0	45	0,50	50

*Programme setting for testing in accordance with standard EN 60456.

Values given in the above table are provided as a guide and may vary depending on the water supply temperature and pressure, and your electricity power supply mains voltage.

5. Washing guide

5.1. Sorting and preparing your washing

- Sort the washing by type and care symbol (see chapter 5.4: International symbols for care of textiles): normal wash for strong washing that can resist energetic wash and spin; delicate wash for delicate washing that should be treated more carefully. For mixed loads composed of articles of different types of fibers, choose a program and temperature suitable for the most fragile fiber.
- Wash white washing and color washing separately. Otherwise, the white washing may be colored or look gray.
- New clothes very often have too much color. Preferably wash new clothes separately for the first time. Respect "wash separately" and "wash several times separately" care instructions.
- Empty pockets and spread out the washing.
- Take off all loose buttons, pins and hooks and eyes. Close zip fasteners, tie knots in laces and straps.
- Turn clothes made of several layers of textiles (sleeping bags, anoraks, etc.), colored hosiery and wool and textiles with add-on decorations, inside out.
- Wash small delicate items (socks, tights, bras, etc) in a washing net.
- Treat curtains with special care. Remove curtain hooks and put net curtains in a net bag or a sachet.

5.2. Washing load depending on the nature of the material

The quantity of washing that you put in your drum must not exceed the maximum capacity of your washing machine. This capacity may vary depending on the nature of your textiles. Reduce the quantity of washing if it is very dirty or if you have terry cloth type materials.

Not all textiles have the same volume and the same water retention capacity. This is why in general the drum should be filled:

- completely, but without excessive pressure for cotton and linen, and for mixed washe,
- half full for treated cottons and synthetic fibers,

- about one third full for very delicate articles such as net curtains and wool.

For a mixed wash, fill the drum as required for the most delicate material.

5.3. Detergents and additives

Only use detergents and additives suitable for use in a washing machine. Read the manufacturer's instructions and respect sections 2.1 and 3.2.

Powder detergents can be used without restriction; liquid detergents should be poured either in the proportioning bowl directly in the drum, or in the wash compartment provided that the washing machine is started immediately; detergents in tablets or doses must be put into the wash compartment of the detergents dispenser in your washing machine.

The quantity of detergent to be used depends on the amount of washing to be washed, the hardness of the water and how dirty the washing is.

If the water is soft, you can reduce the doses slightly. Increase the doses slightly if the water is hard (it is recommended to use a water softener) or if the washing is very dirty or stained.

You can ask the water distribution company in your region or any other competent authority to find out the degree of hardness of your water.

5.4. International symbols

NORMAL WASH						
	Wash at 95°C	Wash at 60°C	Wash at 40°C	Wash at 30°C		
DELICATE WASH					Delicate wash by hand	Do not wash

JAVEL WATER	Bleaching with chlorine (Javel water) allowed (only cold and with a dilute solution)	Do not bleach with chlorine (Javel water)

IRONING	High temperature (max 200°C)	Average temperature (max 150°C)	Low temperature (max 100°C)	Do not iron

DRY CLEANING	Dry cleaning (all usual solvents)	Dry cleaning (all solvents except trichloroethylene)	Dry cleaning (only oil solvents and R113)	Do not dry clean

DRYING	Dry washing spread out	Dry washing hung up	Dry washing on hanger	Drying in drum allowed	Do not dry in drum

6. How to do a wash ?

Before the first wash in your washing machine, we recommend that you should do a preliminary wash at 95°C with detergent but without any washing to clean the tub.

6.1. Loading the washing

- Lift the machine cover.
- Open the drum by pressing on the locking button A; the two flaps automatically separate.
- Insert the washing, close the drum and the cover of your washing machine.

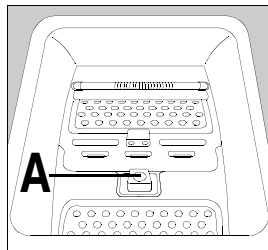

Warning : before you close the cover of your washing machine, make sure that the drum door is properly closed:

- the two flaps latched together,
- the locking button A extended.

6.2. Detergents

Your washing machine has been produced in order to reduce water and detergents consumptions, so you can reduce the doses recommended by detergent manufacturers. Pour the powder detergent dose into the wash compartment [L] and into the prewash compartment [M] if you chose the «prewash» option. Pour in the softener into the [N] compartment. If you are using a different type of detergent, refer to the «detergents and additives» section in the washing guide.

6.3. Press the pushbutton(s) if you wish.

6.4. Select the desired temperature

Choose a temperature that is appropriate for the programme that you have chosen, with reference to the information given on the programmes table.

6.5. Select the desired washing programme

Choose the programme depending on the nature and dirtiness of your washing. Turn the knob in the clockwise direction until you find the chosen programme.

6.6. Start the washing programme

Check that the water tap is open.

Press the ON/OFF pushbutton  to start your washing machine : the relevant light illuminates and the programme starts.

6.7. End of programme

The washing machine stops automatically and the programme selector stops on a stop position.

The programmes end :

- by a spinning for the cotton and coloured programmes.
- by a short spinning for the synthetics, delicates and wool programmes

Release the ON/OFF pushbutton  at the end of the cycle to switch your washing machine off. The control lamp lights off. Release any other pushbuttons.

Warning :

You can not open the lid until about 2 minutes after the appliance has stopped.

Remove the laundry. Unplug the appliance and switch off the water inlet tap. Check that the drum is empty : any garments left in the appliance may be damaged during the next wash (shrinkage) or their colour may run onto other garments.

Note : we recommend you to leave the lid and the drum opened after use in order to air the tub.

7. Programmes tables

7.1. Washing

This table does not include all possibilities, simply the best and most usual adjustments in practice.

Washing type	Max. washing quantity	Timer Temperature	Other possible options
Washing to be boiled	5 kg	Cotton / linen with prewash 30-95	800 / 400 NO SPINNING
		Cotton / Linen without prewash 30-95	
Cotton / Coloureds	5,0 kg	Resistant coloureds 30-60	RINSE PLUS
		Delicate coloureds 30-60	
Easy care washing	2,5 kg	Resistant synthetics with prewash 30 - 60	800 / 400 NO SPINNING
		Resistant synthetics 30 - 60	
		Delicate synthetics 30 - 40	
Delicate washing	2,5 kg	Delicates 30 - 40	
Wool	1,0 kg	Wool 40	

7.2. Separate softener / starch

Washing type	Max. washing quantity (dry weight)	Timer
Washing to be boiled Coloureds	5,0 kg	SOFTENER
Easy care washing	2,5 kg	
Delicate washing	2,5 kg	
Wool	1,0 kg	

7.3. Separate rinse

Washing type	Max. washing quantity (dry weight)	Timer
Washing to be boiled Coloureds	5,0 kg	RINSES
Easy care washing	2,5 kg	
Delicate washing	2,5 kg	
Wool	1,0 kg	

7.4. Separate spinning

Washing type	Max. washing quantity (dry weight)	Timer
Washing to be boiled Coloureds	5,0 kg	SPINNING
Easy care washing	2,5 kg	SHORT SPINNING
Delicate washing /	2,5 kg	
Wool	1,0 kg	

8. Care and cleaning

Do not do any cleaning operation until you have unplugged the washing machine.

8.1. Descaling the washing machine

Normally there is no need to descale the washing machine if the detergent was correctly proportioned.

If descaling is necessary, use a special non-corrosive product specially designed for washing machines that you can find in the shops. Respect the proportion and frequency of descaling shown on your packaging.

8.2. The surface

Clean the surface of your washing machine using lukewarm water and a mild detergent. Never use alcohol, solvents or similar products.

8.3. The detergents dispenser

Disassembly:

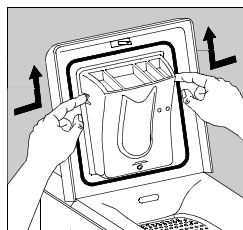

Press the clips on each side of the detergents dispenser and pull it upwards.

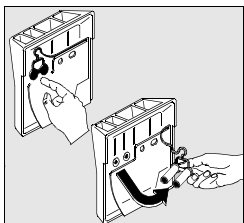

You can thus clean it using running water and a brush or a twisted cloth. Check that the siphons at the back of the detergents dispenser are not blocked.

Reassembly :

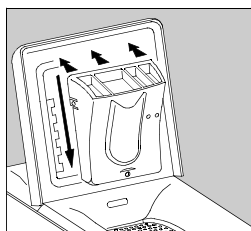

Put the detergents dispenser in the notches until they lock.

8.4. The drain filter

Clean the filter at the bottom of the washing machine regularly. The "filter" light comes on if the filter is blocked. In this case clean it immediately. If you wash washing that is very fluffy, clean it after each wash.

Open the door, with a screwdriver for example:

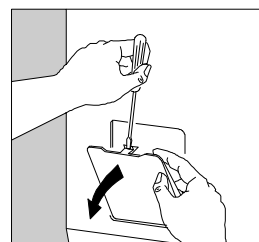
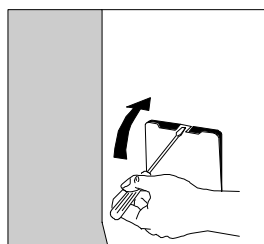

*depending on model

Drain residual water:

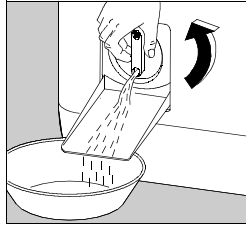

Put a receptacle under the drain. Turn the cap in the anti-clockwise direction until it is vertical to release residual water.

Remove the filter:

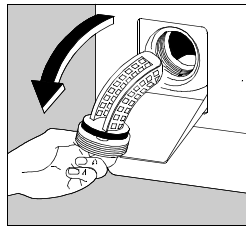

Unscrew the cap all the way and take it off. Clean it thoroughly with running water. Put the assembly back and screw it in the clockwise direction.

After cleaning the filter, you are required to closed the door. In fact, for reasons of safety, the door must be closed when the appliance is working.

9. Operating problems

Many checks have been carried out during the manufacture of your washing machine. However, if you face a problem with its operation, please read the following sections before calling the After Sales service.

Symptom	Cause
The washing machine will not start or will not fill:	<ul style="list-style-type: none"> • the washing machine is not correctly connected, the electrical installation is not working, • the lid of your washing machine and the drum flaps are not correctly closed, • you did not control the program start correctly, • there is a power failure, • the water supply is closed off, • the water tap is closed, • the water inlet is blocked.
The washing machine fills up but empties again immediately:	<ul style="list-style-type: none"> • the drain siphon is attached too low (see installation section).
The washing machine fills, then the programme knob advances quickly to the end of the cycle and the machine drains or the wash does not take place:	<ul style="list-style-type: none"> • the drum doors are not closed correctly.
The washing machine will not spin or will not empty:	<ul style="list-style-type: none"> • the drain pipe is blocked or kinked, • the drain filter is blocked, • the «Drain» program or the «Rinse hold»* option is selected, • the height of the drain siphon is wrong.

Symptom	Cause
The cover does not open during the cycle :	<ul style="list-style-type: none"> the lid cannot open until 1 to 2 minutes after the washing machine has stopped.
The washing machine stops during a washing cycle :	<ul style="list-style-type: none"> the water or electricity supply is defective, a rinse hold* was programmed.
There is water on the floor around the washing machine:	<ul style="list-style-type: none"> excess detergent has made too much foam that overflowed, the detergent is not suitable for washing machine, the drain siphon is not hooked on properly, the drain filter was not put back into place, the water inlet pipe is leaking.
Washing results are not satisfactory:	<ul style="list-style-type: none"> the detergent is not suitable for machine washing, there is too much washing in the drum, the washing program is not appropriate, there is not enough detergent.
The machine is vibrating or noisy:	<ul style="list-style-type: none"> not all the packing was removed from the machine (see unpacking section), the washing machine is not leveled and properly packed, the washing machine is too close to the wall or furniture, the washing is not well distributed in the drum, the load is not sufficient.

Symptom	Cause
The washing cycle is much too long :	<ul style="list-style-type: none">• the water inlet is blocked,• there was a power supply failure or the water was cut off,• the motor temperature safety device tripped,• the water inlet temperature is lower than normal.
Softener or Javel* water flows through the overflow orifice when filling :	<ul style="list-style-type: none">• you did not put in the right amount,• the siphons at the back of the detergents dispenser are blocked.

*Depending on the model

10. Installation and connection instructions

10.1. Warnings

- This washing machine is heavy. Take care when moving it.
- You must remove the packing on the washing machine before use. Failure to remove all transport protection devices can cause damage to the washing machine or nearby furniture. The washing machine must be unplugged while packing is being removed.
- Do not allow any one other than a qualified plumber to make the hydraulic connections necessary to install your washing machine.
- The washing machine must be plugged in to a power outlet with a conform earth.
- Call a qualified electrician if the electrical installation in your residence is such that you have to modify it before you can connect your washing machine.
- Please read the instructions in the "electrical connections" chapter carefully before connecting your washing machine.
- After installing your washing machine, make sure that it is not standing on its electrical power supply cable.
- When your machine is installed on a carpeted floor, make sure that the carpet does not close off the ventilation openings near the bottom of the machine.
- The power supply cable may be only replaced by the After Sales Service.
- Your manufacturer cannot be held responsible for any damage resulting from a nonconform installation.

10.2. Washing machine dimensions

Front and side views

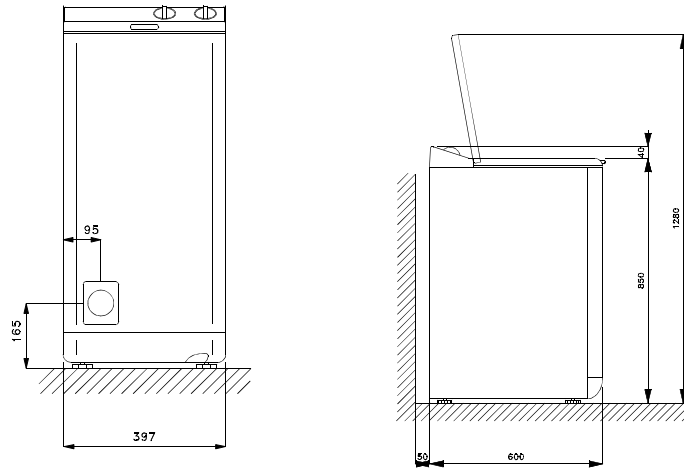

Back view

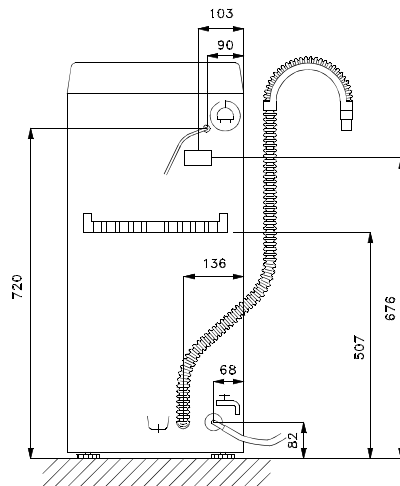

10.3. Installation

10.3.1. Unpacking



Packing used to protect internal parts of the washing machine during transport must be removed before the washing machine is put into service for the first time.

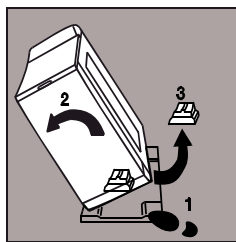

Remove all packing from the washing machine. Tilt the washing machine sideways and then remove the packing under the motor, and straighten the washing machine.

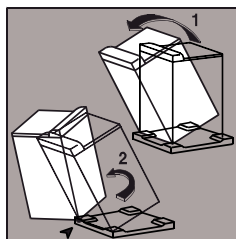

Tilt the washing machine back-wards, rotate it by a quarter of a turn on one of its corner to remove the transport base.

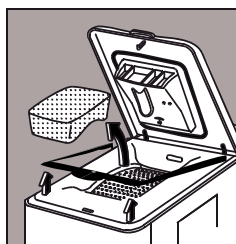

Open the washing machine lid and remove the immobilization packing and plastic films. Close the lid.

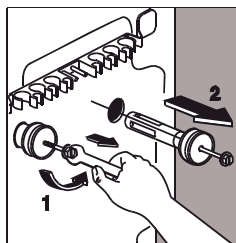

Use a 10 mm spanner to remove the two screws and spacers at the back.

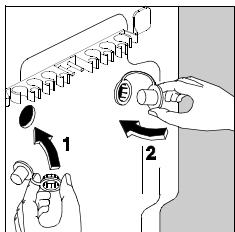

You can now see the openings that must be closed with the caches in the pack attached to the washing machine; do not forget to fold down the central capsule.

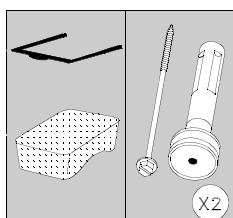

Make sure that you have removed all these parts from your washing machine and keep them so that you can use them again if you need them for future transport.

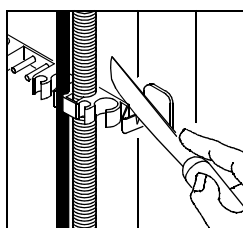

If you want to keep your washing machine aligned with the adjacent furniture, you can cut the pipe support strip at the back of your washing machine. Leave the two side closers in place.

10.3.2. Position

Put the washing machine on a flat hard floor in a well ventilated room. Make sure that your washing machine does not touch the wall or any other furniture in the room.

10.3.3. Moving your washing machine

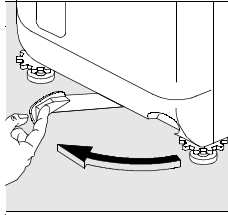

If you want to move your washing machine, lift it onto its rollers by pulling the lever at the bottom of the washing machine all the way to the left. When you have put your washing machine into the required location, put the lever back into its initial position.

10.3.4. Leveling

Precise leveling will prevent vibrations, noise and movements of the washing machine during operation.

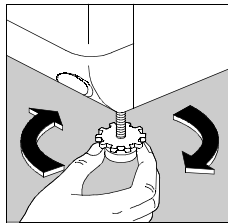

Make the washing machine level by adjusting the leveling screw that is too short. Unscrew the stand and locking collar assembly (lift the washing machine if necessary).

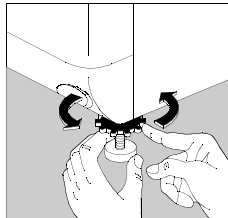

When the washing machine is stable, maintain the stand on the ground and turn the locking collar as far as possible.

10.3.5. Water inlet

Please install the water inlet hose onto the back of your washing machine :

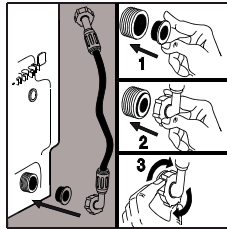

- Insert the seal in the hole at the bottom of the back panel (fig. 1).

- Screw on the bottom fitting of the water inlet hose as shown in fig. 2 and fig. 3.

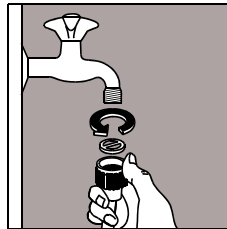

- Connect the feed hose connector onto the water inlet tap, taking care to position the gasket correctly.

- Turn on the water inlet tap.

The water inlet hose cannot be extended. If it is too short, please contact the After Sales Department.

10.3.6. Drain

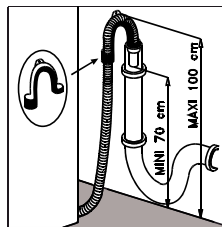

- Assemble the hose holder onto the drain hose.

- Place the assembly in a drainage pipe (or in a sink) at a height between 70 and 100 cm. Make sure that it will not fall out.

You must provide an air intake at the end of the drainage hose, to avoid any water being siphoned.

Important: the drainage hose must not be extended, on any account. If it is too short, contact a qualified engineer.

10.3.7. Electrical connection

You can only connect this washing machine to 230 V single phase power supply.

Check rating of the fuse line: 10 A at 230V.

The washing machine must not be connected through an extension cable or a power bar. Check that the earthing connection is conform with the regulations in force.

11. Technical characteristics

DIMENSIONS	Height	850 mm
	Width	397 mm
	Depth	600 mm
VOLTAGE / FREQUENCY		230 V / 50 Hz
TOTAL POWER		2300 W
WATER PRESSURE	Minimum	0,05 MPa (0,5 bar)
	Maximum	0,8 MPa (8 bars)
Connection to the water network		Type 20x27

CE This washing machine complies with CEE directive 89-336 about the limitation of radioelectric disturbances and directive CEE 73-23 for electrical safety.

12. Garantee conditions and After Sales Service

Please contact our AEG agents' of the country directly.

AEG Hausgeräte GmbH
Postfach 1036
D-90327 Nürnberg

<http://www.aeg.hausgeraete.de>

©Copyright by AEG

146 5959 01 - 05/06

 **From the Electrolux Group. The world's No.1 choice.**

The Electrolux Group is the world's largest producer of powered appliances for kitchen, cleaning and outdoor use. More than 55 million Electrolux Group products (such as refrigerators, cookers, washing machines, vacuum cleaners, chain saws and lawn mowers) are sold each year to a value of approx. USD 14 billion in more than 150 countries around the world.

Free Manuals Download Website

<http://myh66.com>

<http://usermanuals.us>

<http://www.somanuals.com>

<http://www.4manuals.cc>

<http://www.manual-lib.com>

<http://www.404manual.com>

<http://www.luxmanual.com>

<http://aubethermostatmanual.com>

Golf course search by state

<http://golfingnear.com>

Email search by domain

<http://emailbydomain.com>

Auto manuals search

<http://auto.somanuals.com>

TV manuals search

<http://tv.somanuals.com>