

# ÖKO-LAVAMAT 76730 update

The environmentally friendly washing machine

## User information



## Dear Customer,

Please read this user information carefully.

Pay particular attention to the section "Safety" on the first Info pages.

Please keep this user information in a safe place for later reference.

Pass it on to any future owners of the unit.



The warning triangle and /or signal words (**Warning!**, **Caution!**, **Important!**) emphasise information which is important for your safety or for the unit's functional reliability. It is imperative that this information is observed.



**1.** This symbol guides you step by step through the operation of the appliance.

**2.** ...



Next to this symbol you will find additional information and practical tips on using the appliance.



Tips and information on economical and environmentally responsible use of the unit are identified with the clover leaf.

For any faults which occur, this user information contains information on how to remedy these faults yourself. See the section "What to do if ..."

Printed on recycled paper.

Thinking ecologically means acting ecologically.

# Contents

<b>Operating Instructions</b> .....	6
<b>Safety</b> .....	6
<b>Disposal</b> .....	8
<b>Environmental tips</b> .....	9
<b>Unit description</b> .....	10
Front view .....	10
Drawer for detergent and care agent .....	10
Control panel .....	11
Program Selector .....	11
Additional Program Buttons .....	13
<b>Consumption Values</b> .....	14
<b>What does "UPDATE" mean?</b> .....	14
<b>Water Protection Aqua Control</b> .....	14
<b>Before the First Wash</b> .....	15
<b>Prepare washing cycle</b> .....	15
Sort washing and prepare .....	15
Washing Types and Care Codes .....	16
Washing Detergents and Care Agents .....	17
Which washing detergent and care agent? .....	17
How much washing detergent and care agent? .....	17
Water softener .....	17
<b>Run a Washing Cycle</b> .....	18
Brief Instructions .....	18
Setting the Washing Program .....	19
Changing the spin speed/Selecting the rinse hold function .....	20
Set the Delay Timer/Soaking Duration .....	21
Opening and Closing the Filling Door .....	22
Add the washing .....	22
Add Washing Detergent/Care Agent .....	23
Start the Washing Program .....	24
Completion of the Washing Program .....	25
Changing a Washing Program .....	26
Washing Cycle Ended/Remove Washing .....	27

<b>Program Tables</b> .....	28
Washing .....	28
Separate Conditioning/Starching/Impregnating .....	29
Separate Rinse .....	29
Separate Spin .....	29
<b>Cleaning and Care</b> .....	30
Control panel .....	30
Detergent Drawer .....	30
Washing Drum .....	31
Main door .....	31
<b>What to do if ...</b> .....	32
Remedying Faults .....	32
If the washing results are not satisfactory .....	36
Carrying out emergency drainage .....	37
Drain pump .....	38
Additional Rinse (RINSE+) .....	39
<b>Child Safety Feature</b> .....	40
<b>Installation and connection instructions</b> .....	41
<b>Installation Safety Precautions</b> .....	41
<b>Installation of the appliance</b> .....	42
Transporting the appliance .....	42
Remove transport packaging .....	42
Prepare the installation place .....	44
Installation on a concrete base .....	44
Installation on vibrating floors .....	44
Compensate for floor unevenness .....	45

---

<b>Electrical connection</b> .....	46
<b>Water connection</b> .....	46
Permissible water pressure .....	46
Water inflow .....	47
Water drain .....	48
Delivery heads over 1m .....	48
<b>Technical data</b> .....	49
<b>Dimensions</b> .....	49
<b>Warranty conditions / Customer service centres</b> .....	50
<b>Index</b> .....	54
<b>Service</b> .....	55

# Operating Instructions



## Safety

The safety aspects of AEG electrical appliances comply with accepted technical standards and the German Appliance Safety Law. However, as manufacturers we regard it as our responsibility to inform you about the following safety instructions.

### Before Using for the First Time

- Refer to the "Installation and Connection Instructions" further on in this user information.
- If units are delivered in the winter months at minus temperatures: Store the washing machine at room temperature for a few hours before putting it into operation.

### Correct Use

- The washing machine is only intended for washing normal domestic washing. If the appliance is used for a wrong purpose or wrongly operated, the manufacturer cannot assume any liability for any damages.
- Additions or modifications to the washing machine are strictly forbidden due to safety reasons.
- Use only detergent which is suitable for washing machines. Refer to the detergent manufacturer's instructions.
- The washing must not contain any flammable solvents. Also bear this in mind when washing pre-cleaned washing.
- Do not use the washing machine for dry-cleaning.
- Dyes /dye-removing agents may only be used in the washing machine if the manufacturer expressly permits use of these products. We cannot accept liability for any damage.
- Use only water from the water mains. Use rain water or service water only if it meets the requirements defined in DIN 1986 and DIN 1988.
- Frost damage is not covered by the warranty! If the washing machine is in a room subject to possible frost hazards, emergency emptying must be carried out if there is a risk of frost (see the Section "Carrying out emergency emptying").

## Safety of Children and Infirm Persons

- Packaging materials (e.g. films, polystyrene) can be dangerous for children. Risk of suffocation! Keep packaging away from children.
- The appliance is not intended for use by young children or infirm persons without supervision.
- Children frequently cannot recognise hazards involved in handling electrical appliances. Therefore, ensure that they are properly supervised during operation and never allow children to play with the washing machine – there is a risk that they can lock themselves inside it.
- Ensure that children or small animals do not climb into the washing machine's drum.
- When disposing of washing machines pull out the mains plug, destroy the door lock, cut off the electrical supply lead and dispose of the plug and remaining cable. This means that playing children cannot shut themselves in and cannot encounter a potentially lethal hazard.

## General Safety

- Repairs to the washing machine may only be carried out by qualified specialists. Incorrect repairs may result in significant risk to the user. If repairs are necessary, consult our customer service or your specialist dealer.
- Never use the washing machine if the mains cable is damaged or the control panel, work surface or base panel area are so badly damaged that the interior of the unit is openly accessible.
- Switch off the washing machine before carrying out cleaning, care and maintenance work. Also pull the mains plug out of the socket or, – if it is permanently connected, – switch off the circuit breaker at the household power distribution box or completely remove the screw-in fuse.
- If operation is stopped, disconnect the appliance from the mains supply and shut off the tap.
- Never pull the cable to remove the plug from the socket. Always pull the plug itself.
- Multiple connectors, couplings and extension cables must not be used. **There is a risk of fire with overheating!**
- Do not spray down the washing machine with a water jet. Risk of electric shock!

- The glass in the door becomes hot in the case of wash programmes with high temperatures. Do not touch!
- Allow the washing solution to cool before carrying out an emergency emptying operation or cleaning the drain pump.
- Small animals can chew the power cables and water hoses. Risk of electric shock and danger of water damage! Keep small animals away from the washing machine.



## Disposal

### **Disposing of the Packaging Material!**

Dispose of the packaging of your washing machine correctly. All packaging materials used are environmentally-compatible and recyclable.

- Plastic parts are identified with internationally standardised abbreviations:
  - >PE< for polyethylene, e.g. packing films.
  - >PS< for polystyrene, e.g. cushion parts (always CFC-free)
  - >POM< for polyoxymethylene, e.g. plastic clips.
- Cardboard packaging is manufactured from recycled paper and should be deposited in the waste paper collection for recycling.

### **Disposing of your old appliance!**

When you put your unit out of operation one day, please bring it to your nearest recycling centre or to your dealer.





## Environmental tips

- A pre-wash cycle is not necessary in the case of washing which is not excessively dirt. This saves detergent, water and time (and is gentle on the environment.)
- If the indicated load capacities are taken full advantage of, the washing machine is especially efficient.
- For small loads, use only one half to one third of the recommended detergent quantity.
- Suitable pre-treatment enables marks and limited amounts of dirt to be removed. You can then wash at a lower temperature.
- Wash slightly to normally dirty cottons with the energy-saving program.
- There is often no need for the softener. Try it once! If you use a drier, your washing will become soft and fluffy even without a softener.
- In the case of medium to high water hardness (hardness range runs to upwards, see "Detergent and care agents"), you should use a water softener. The detergent can then always be metered for hardness range I (= soft).

# Unit description

## Front view

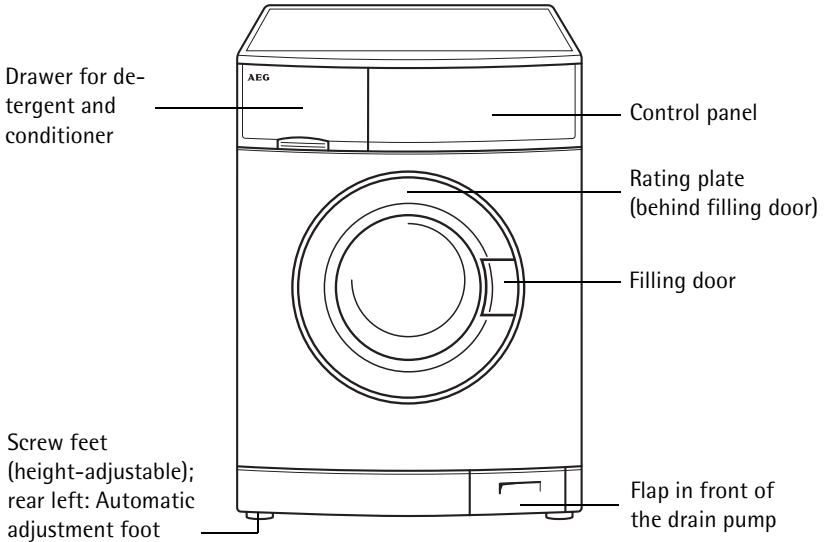

## Drawer for detergent and care agent

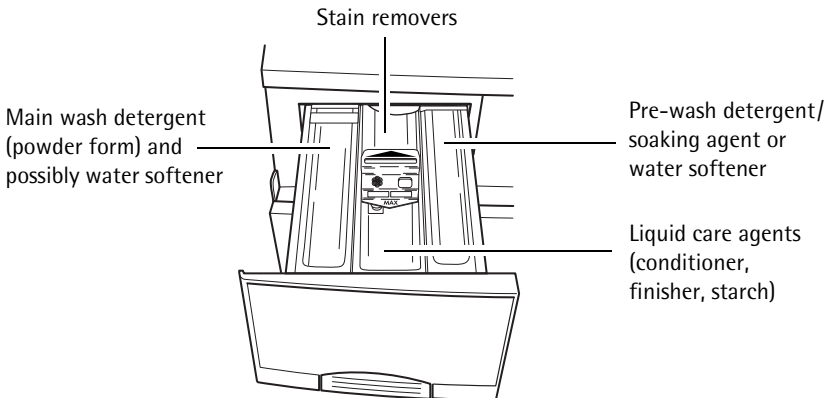

## Control panel

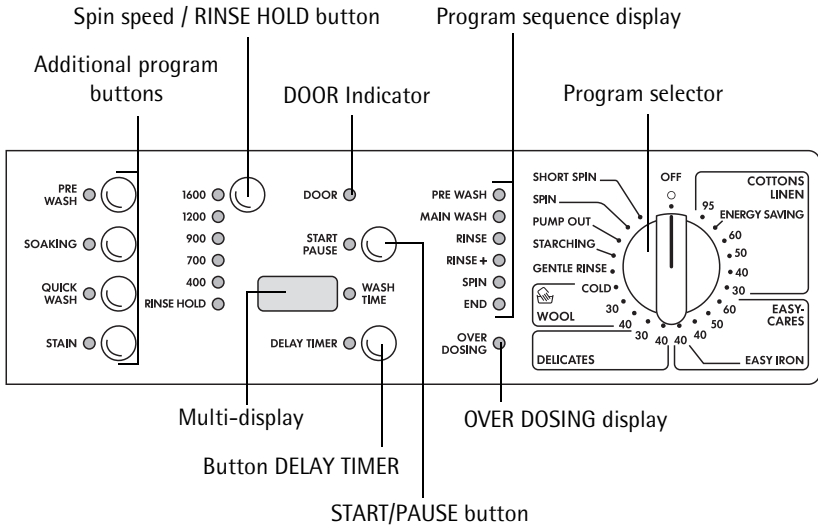

## Program Selector

The program selector determines the type of washing cycle (e.g. water level, drum movement, number of rinses, spin speed) according to the type of garments being washed, and also the washing solution.

### OFF

Switches off the washing machine. All other positions are "switched on".

### COTTONS/LINEN

Main washing cycle Cottons/Linen at 30 °C to 95 °C.



**ENERGY SAVING** position: Energy-saving program at approx. 67 °C for slightly to normally dirty cottons, extended washing time (cannot be combined with QUICK WASH).

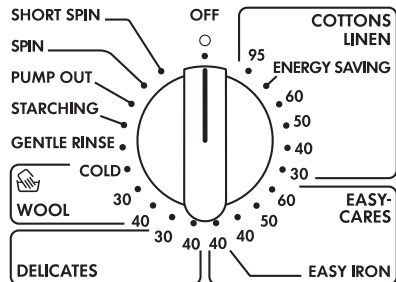

### **EASY-CARES**

Main washing cycle for easy-care textiles (mixed fabrics) at 40 °C to 60 °C.

EASY IRON position: Main washing cycle at 40 °C for easy-care textiles which, with the aid of this program, only have to be either gently ironed or not ironed at all.

### **DELICATES**

Main washing cycle for delicates at 30 °C or 40 °C.

### **WOOL/ (Handwash)**

Main washing cycle (cold up to 40 °C) for machine-washable woollens and for hand-washable wool textile and silk with the care symbol  (handwash).

### **GENTLE RINSE**

Separate gentle rinse e.g. for rinsing hand-washed textiles (2 rinses, liquid care agent from rinsing compartment  is added, short spin).

### **STARCHING**

Separate starching, separate conditioner, separate impregnation of damp washing (1 rinse, liquid care agent from the rinsing compartment  is added, spin).

### **PUMP OUT**

Pumping off the water after a rinse hold (without spin).



RINSE HOLD means: The washing remains lying in the last rinsing water. It is not spun.

### **SPIN**

Pumping off the water after a rinse hold and spin, or separate spin of hand-washed cottons/linen.

### **SHORT SPIN**

Pumping off the water after a rinse hold and short spin or separate short spin of sensitive textiles (easy-care washing, delicates, woollens).

## Additional Program Buttons

The additional program buttons are for adapting the washing program to the dirtiness of the washing. Additional programs are not required for washing which is not excessively dirty.

Various functions can be combined with each other, depending on the program.

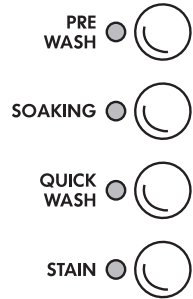

### PRE WASH

Warm pre wash before the main washing cycle which follows on automatically; with intermediate spin for COTTONS/LINEN and EASY-CARES, without intermediate spin for DELICATES.

If RINSE HOLD has been selected, no spinning will take place at all.

### SOAKING

Approximately 50 minutes at 30°C water temperature. Extendable with the button DELAY TIMER to max. 10 hours and approx. 20 minutes. This is followed automatically by the main wash.

### QUICK WASH

Shorter washing cycle for slightly dirty washing.

### STAIN

For treating very dirty washing or stained washing. In-wash stain treatment is added during the program on a time-optimized basis. May only be used for wash temperatures from 40°C as stain removers only become effective at higher temperatures.



With the program WOOL/ (handwash), it is not possible to select the additional programs (any pressed buttons have no effect).

## Consumption Values

The values for selected programs in the following tables were determined under normal conditions. However, there is a helpful orientation aid for domestic operation.

Program Selector/Temperature	Filling Quantity in kg	Water in Litres	Energy in kWh
COTTONS/LINEN 95	5	45	1.70
COTTONS/LINEN 60 <sup>1)</sup>	5	42	0.94
COTTONS/LINEN 40	5	49	0.60
EASY-CARES 40	2.5	54	0.50
DELICATES 30	2.5	50	0.30
WOOL/  (Handwash) 30	2	48	0.20

1) **Note:** Program setting for a test in accordance with EN 60 456. The consumption values can deviate from the stated values depending on the water pressure, hardness, inlet temperature, room temperature, type and quantity of washing, the washing powder/liquid used, fluctuations in the mains voltage and selected additional functions.

## What does "UPDATE" mean?

Your washing machine's washing programs are controlled by software. New types of textiles or new detergents may require new washing programs in the future. In most cases, the software can be adapted to this. For further information on the "update", please consult the Customer Service. You can also enquire about the costs for an "update" with your Customer Service.

## Water Protection Aqua Control

In the event of damage to the supply hose, the system blocks the further supply of water to the unit directly at the water tap. If water escapes elsewhere, the drainage pump automatically pumps off – even if the unit is switched off. The washing machine merely has to be connected to the electricity mains.

## Before the First Wash

- ☞ Carry out a washing operation without washing (COTTONS 95 °C, with half the quantity of washing powder/liquid). This removes residues left over from production on the drum and solution container.

## Prepare washing cycle

### Sort washing and prepare

- Sort the washing according to the care symbol and type (see "Washing types and care codes").
- Empty all pockets.
- Remove metal objects (paper clips, safety pins etc.).
- To prevent damage to the washing and tangled washing: Close zip fasteners, button bed and pillow covers closed, tie up loose strings e.g. of aprons.
- Turn articles with double layered textiles inside out (sleeping bags, anoraks etc.).
- In the case of knitted coloured textiles and also with wool and textiles with jewelry attached: turn inside out.
- Wash small and sensitive items (e.g. baby socks, tights and stockings, bras etc.) in a washing net, a cushion with a zip fastener or in larger socks.
- Handle curtains with particular care. Metal rollers or burred, plastic rollers must be removed or tied into a net or bag. We cannot accept liability for damage.
- Coloureds and white items must not be washed together in a washing cycle. This could discolour white washing or turn it grey.
- There is often excess dye in new, coloured items. It is best to wash such items separately the first time.
- Mix small and large items. This improves the washing effect and the washing is more favourably distributed during spinning.
- Fluff washing before placing into the washing machine.
- Do not place folded washing into the drum.
- Pay attention to the care instruction "wash separately" and "wash separately several times".

## Washing Types and Care Codes

The care codes help you choose the correct washing program. The washing should be sorted according to type and care code. The temperatures stated in the care codes are all maximum values.

### Cottons

Textiles made of cotton and linen with this care code are insensitive to mechanical stress and high temperatures. The program COTTONS/LINEN is suitable for this type of washing.

### Linen

Textiles made of cotton and linen with this care code are insensitive to mechanical stresses. The program COTTONS/LINEN is suitable for this type of washing.

### Easy-Care Garments

Textiles such as finished cottons, cotton mixtures, viscose and synthetics with this care code require mechanically more mild treatment. The program EASY-CARES/EASY IRON is suitable for this type of washing.

### Delicates

Textiles such as layered fibres, microfibres, viscose, synthetics and curtains with this care code require very gentle treatment. The program DELICATES is suitable for this type of washing.

### Wool and Very Sensitive Washing

Textiles such as wool, wool mixtures and silk with this care code are especially sensitive to mechanical stresses. The program WOOL/ (Handwash) is suitable for this type of textiles.

**Attention!** Textiles with the care code  (Do not wash!) must not be washed in the washing machine!



## Washing Detergents and Care Agents

### Which washing detergent and care agent?

Use only washing detergents and care agents which are suitable for use in washing machines. Always follow the manufacturer's instructions.

### How much washing detergent and care agent?

The amount to be used depends on:

- the dirtiness of the washing
- the hardness category of the mains water supply
- the filling quantity



If the detergent manufacturer gives no details of the dosing quantities for minimum loads, add one third less for half loads and, in the case of very small loads and for EASY IRON, only half the amount of detergent recommended for a full load.

Refer to the detergent/care agent manufacturer's instructions on use and dosage.

## Water softener

For medium to high water hardness (hardness class II upwards), you should use softener. Refer to the manufacturer's instructions. Then always add the appropriate amount of detergent for hardness class I (= soft). The responsible water works will provide information on the local water hardness.



Since the water softener is rinsed in before the main detergent (water pre-softening), 80% of the stated quantity of softener shown on the package is sufficient.

### Water hardness details

Hardness class	Water hardness in °dH (German hardness scale)	Water hardness in mmol (millimol per litre)
I - soft	0 - 7	to 1.3
II - medium hard	7 - 14	1.3 - 2.5
III - hard	14 - 21	2.5 - 3.8
IV - very hard	greater than 21	greater than 3.8

# Run a Washing Cycle

## Brief Instructions

A washing cycle is run in the following steps:

- ☞ 1. Set the correct washing program:
  - Set the program and temperature with the program selector
  - Set any additional program(s)
2. Change the spin speed if necessary / select RINSE HOLD.
3. Set DELAY TIMER if necessary.
4. Open the filling door and fill with washing.
5. Close the filling door.
6. Add washing detergent/care agent.
7. Start the washing program.

### **After the Washing Program Ends:**

**Attention!** If the washing cycle ended with Rinse Hold, before opening the filling door carry out PUMP, SPIN or SHORT SPIN.

8. Open the filling door and remove the washing.
9. Switch off the washing machine: Set the program selector to OFF.

## Setting the Washing Program

**i** For the suitable program, the correct temperature and possible additional programs for the particular washing type, refer to the "Program tables".

- 1.** Set the program selector to the required washing program with the required temperature.

The probable duration of the set program in minutes is shown in the multi display.

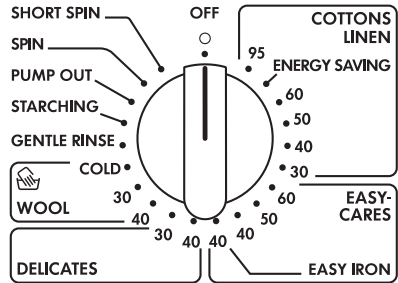

- 2.** If necessary, select additional program(s):  
The display of the selected auxiliary program lights up.

- To change the selection, press another button.
- To deselect, press the button again.



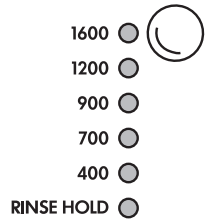

## Changing the spin speed/Selecting the rinse hold function

If required, change the spin speed for the final spin/select rinse hold:



### Changing the spin speed

 Continue pressing the spin speed/RINSE HOLD button until the indicator for the desired spin speed is illuminated.

 If you do not change the spin speed, the final spin will be adjusted automatically depending on the type of wash cycle:

- COTTONS/LINEN 1600 revolutions per minute
- EASY-CARES/EASY IRON 900 revolutions per minute
- DELICATES 700 revolutions per minute
- WOOL/ (Handwash) 900 revolutions per minute

The speed for the intermediate spin cycle is dependent on the wash cycle selected and cannot be altered.

### Selecting the rinse hold function

 Continue pressing the spin speed/RINSE HOLD button until the RINSE HOLD indicator is illuminated.

 If RINSE HOLD is selected, the washing will remain in the final rinse water and will not be spun.

The washing will not be spun throughout the entire wash cycle. As a result the cycle is a very quiet one. RINSE HOLD is therefore especially suitable for washing at night.

**Note:** The laundry remains lying in the water until you drain or spin (see section "Ending a wash cycle"). After 18 hours however, it is automatically drained and pumped.

## Set the Delay Timer/Soaking Duration

### Delay Timer

The button DELAY TIMER allows the start of a washing program to be advanced by 1 to a maximum of 19 hours.



To do this, press the button DELAY TIMER as often as necessary until the required start delay is shown in the multidisplay, e.g. **12h** in the form for a program start delay of 12 hours.

If **19h** is shown and you press again, **0h** and afterwards the run time of the set washing program appears (display in minutes, e.g. **126**). In this state, the delay timer is not set.

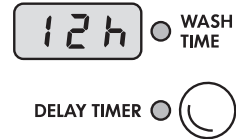

Once the delay timer has been set, it will only be activated after pressing the START/PAUSE button.

### Soaking Duration

With the SOAKING button pressed, you can extend the soaking duration with the button DELAY TIMER (maximum 10 hours and approx. 20 min.).



Without delay timer, the soaking duration is approx. 30 minutes, plus a pre-wash time of approx. 20 minutes.



To set, press the button DELAY TIMER as often as necessary until the required soaking duration is shown in the multidisplay, e.g. **1h** (= 1 hour).

After approx. 2 seconds, the multidisplay shows the run time in minutes.

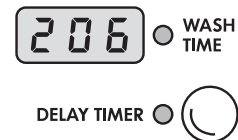



This run time is comprised as follows:

selected soaking period	e.g. –	<b>1h</b> = 60 minutes
+ heating up/prewash period	e.g.	approx. 20 minutes
+ run time of the selected washing program	e.g.	approx. 126 minutes
= displayed value	e.g.	approx. 206 minutes



While SOAKING is running, PRE WASH lights up on the program sequence display.

## Opening and Closing the Filling Door

-  Open: Pull on the handle of the filling door.
-  Close: Press the filling door firmly closed.

DOOR 

The displays DOOR and START/PAUSE show whether the door can be opened while the appliance is switched on:

START/PAUSE 

Display DOOR	Display START/PAUSE	Opening door possible?
Glows green	Flashes red	Yes
Glows green	Glows red	Yes, after pressing button START/PAUSE
Is off	Flashes or glows red	No <sup>1)</sup>

1) The main door is locked because of a high water level or a high temperature.

-  If
  - the display DOOR flashes red
  - then the error code **E40** flashes in the multidisplay
  - and the display MAIN WASH flashes
 you tried to start a washing program without first closing the main door properly. In this case push the door shut firmly and restart the washing program.

## Add the washing

-  For the maximum filling quantities, see the "Program tables". See "Sort and prepare washing" for information on correctly preparing the washing.

-  **1.** Sort and prepare the washing according to type.
- 2.** Open the filling door: Pull on the handle of the filling door.
- 3.** Fill with washing.

Important! When closing the door, make sure no items of washing get stuck! This could damage textiles and the unit.

- 4.** Close the filling door securely.

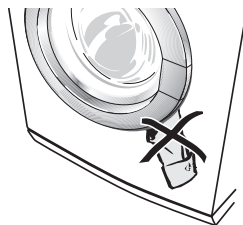

## Add Washing Detergent/Care Agent

**i** Refer to the information on washing detergents and care agents, see section "Washing Detergents and Care Agents".

- 1.** Open the washing detergent drawer: grip inside the flap on the drawer at the bottom (1) and pull out the drawer as far as it will go (2).

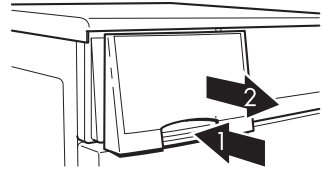

- 2.** Fill with washing detergent/ care agent

**Compartment for in-wash stain treatment**

**Compartment for main washing powder**

(If you use water softener and need the right compartment for the pre-wash/soaking agent, add the water softener to the main washing detergent in the left compartment.)

**Compartment for liquid care agent**  
(Conditioner, finisher, starch)

**Attention!** Do not fill the compartment above the MAX mark. If necessary, dilute viscous agent up to the MAX mark, and dissolve powder starch.

**Note:** It is normal for a small amount of water to be left in the compartment for liquid care agent; this will not affect the wash results.

**Compartment for pre-wash agent/soaking agent**  
(only for additional programs PRE WASH and SOAKING or for water softener)

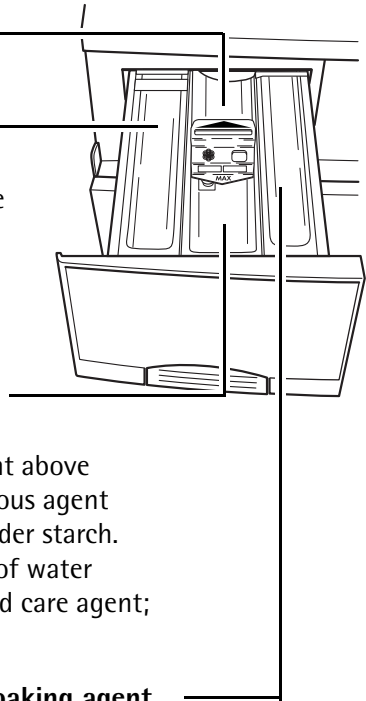

- 3.** Push the drawer fully in.

**i** **If using liquid detergent / tablets**

Add liquid detergent / tablets in the quantity recommended by the washing detergent manufacturer. Add liquid detergent with dosage containers provided by the detergent manufacturer.

## Start the Washing Program

1. Check that the water valve is open.
2. Start the washing program: Press the button START/PAUSE. The washing program is started or it starts after the set time expires.



**i** The filling door is not correctly closed if, when the button START/PAUSE is pressed,

- the indicator DOOR flashes red
- the fault code **E40** in the multidisplay flashes
- and the indicator MAIN WASH flashes.

In this case, press the filling door firmly closed and again press the button START/PAUSE.

### If the time preselection is set:

A set time preselection runs and the remaining time until the program start is displayed (in each case in full hours, e.g. **5h**). During this time you can load washing or change/abort the time preselection.

- Load washing: Press the button START/PAUSE. The filling door can be opened. Next, close the door and again press the button START/PAUSE.
- Change or abort time preselection: Press the button DELAY TIMER as often as necessary until the required time is displayed; when the program run time is displayed (display in minutes, e.g. **125**), the washing program starts without delay.



## Completion of the Washing Program

### Program sequence display

Before the start, the program steps to be carried out are indicated by the Program sequence display. The current program step is displayed during the washing program.

PRE WASH ●  
 MAIN WASH ●  
 RINSE ●  
 RINSE + ●  
 SPIN ●  
 END ●

### Multi-display

The expected remaining run time (in minutes) is displayed in the multi display until the end of the program.

 126 ● WASH TIME



With automatic program adaptation by the controller of the washing machine, (quantity of washing, type of washing, imbalance recognition, special rinse etc.) it is possible to stop or correct the counting of the remaining run time.

## Changing a Washing Program

### Changing or aborting a program

-  1. Press button START/PAUSE.
2. Turn programme knob to OFF. The washing program is aborted.
3. If required, set a new washing program. Otherwise turn the programme knob to PUMP OUT and then press the button START/PAUSE.



The washing program can be interrupted at any time with the button START/PAUSE and continued by pressing the button again. Changing the washing program is possible only after the programme knob was turned to OFF.

### Select the Additional Program

The additional programs QUICK WASH or STAIN can also be selected after the program start.

-  1. Press the button START/PAUSE.
2. Press the button QUICK WASH or the button STAIN.
3. Press the button START/PAUSE again.  
The washing program is continued.

### Change the Spin Speed

During the washing program, the spin speed can still be changed or RINSE HOLD can be set.

-  1. Press the button START/PAUSE.
2. Change the speed with the button Spin/RINSE HOLD.
3. Press the button START/PAUSE again.  
The washing program is continued.

## Washing Cycle Ended/Remove Washing

After a washing program has ended, END lights up on the program sequence display.

If you selected RINSE HOLD, the indicator next to the button START/PAUSE flashes.

-  **1.** After a rinse hold, it is first necessary to pump off the water:
- Press either the button START/PAUSE (water is pumped off and the washing is spun according to the program which has just run; after pressing the button START/PAUSE again, the spin speed can also still be changed during spinning),
  - or
  - turn the program selector to OFF and then to PUMP and press the button START/PAUSE (water is pumped off without spinning)
  - or
  - turn the program selector to OFF and then to SPIN or SHORT SPIN and press the button START/ PAUSE (water is pumped off and the washing is spun or gently spun).

After the end of this program step, the indicator END lights up.

**2.** Open the filling door.

As soon as the indicator DOOR lights up green, the filling door can be opened.

**3.** Remove the washing.

**4.** Turn the program selector to OFF.

**5.** After washing, pull out the washing detergent drawer slightly so that it can dry out. Only lean the door against the washing machine so that the latter can air out.



If the display OVER DOSING lights up, too much washing detergent was used in the washing program just ended. During the next wash, pay attention to the dosing information of the washing detergent manufacturer and pay attention to the filling quantity!



**Attention!** If the washing machine is not used for a long time: Close the water tap and disconnect the washing machine from the electricity mains. (The Aqua Control water protection does not function if the power supply is interrupted).

# Program Tables

## Washing

Not all possible settings are listed below - only the ones most commonly used in everyday operation and the most appropriate ones.

Type of Washing, Care Codes	Max. Filling Quantity <sup>1)</sup> (dry weight) <sup>2)</sup>	Program Selector Temperature	Possible Additional Programs
Cottons 	5 kg	COTTONS/LINEN 95	PRE WASH SOAKING QUICK WASH STAIN
<b>Energy-Saving Program:</b> Cottons 	5 kg	COTTONS/LINEN ENERGY SAVING	PRE WASH SOAKING STAIN
Linen  	5 kg	COTTONS/LINEN 30 to 60	PRE WASH SOAKING QUICK WASH <sup>3)</sup> STAIN <sup>4)</sup>
Easy-Cares  	2.5 kg	EASY-CARES 40 to 60	PRE WASH SOAKING QUICK WASH STAIN
	1 kg	EASY IRON <sup>5)</sup> 40	
Delicates 	2.5 kg (or 15-20m <sup>2</sup> curtains)	DELICATES 30, 40	PRE WASH SOAKING QUICK WASH STAIN <sup>4)</sup>
Woolens/Handwash   	2 kg	 WOOL COLD to 40	

- 1) The load amount inquiry operates in accordance with the EN 60456 standard load.
- 2) A 10-litre bucket holds approx. 2.5kg of dry washing (cottons).
- 3) QUICK WASH cannot be selected if washing at 50°C.
- 4) In the case of the STAINS, a minimum temperature of 40°C is required for the stain remover to become effective.
- 5) Only if a filling quantity of 1 kg is observed are creases in the washing largely avoided.  
5 to 7 easy-care men's shirts are equivalent to about 1 kg of dry washing.

## Separate Conditioning/Starching/Impregnating

Type of Washing	Max. Filling Quantity (dry weight)	Program Selector
Cottons/Linen	5 kg	STARCHING

## Separate Rinse

Type of Washing	Max. Filling Quantity (dry weight)	Program Selector
Cottons/Linen	5 kg	GENTLE RINSE
Easy-Cares	2.5 kg	
Delicates	2.5 kg	
Woollens/Handwash	2 kg	

## Separate Spin

Type of Washing	Max. Filling Quantity (dry weight)	Program Selector
Cottons/Linen	5 kg	SPIN
Easy-Cares	2.5 kg	SHORT SPIN
Delicates	2.5 kg	
Woollens/Handwash	2 kg	

# Cleaning and Care

## Control panel

Important! Do not use any furniture cleaning agents or aggressive cleaning agents in order to clean panel and control parts.

- ☞ Wipe control panels with a damp cloth. When doing so, use warm water.

## Detergent Drawer

The detergent drawer should be cleaned from time to time.

- ☞ 1. Pull the detergent drawer out as far as it will go.
- 2. Remove the detergent drawer by pulling sharply.
- 3. Take the conditioner insert out of the middle compartment.
- 4. Clean the conditioner insert under running water.

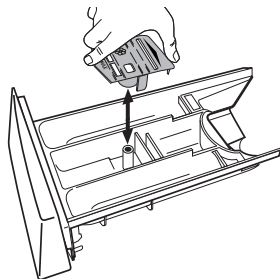

- 5. Clean the compartments with warm water from the rear side. It is best to use a flat brush.

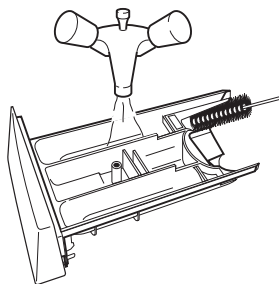

- 6. Push on the conditioner insert as far as it will go so that it is securely in place.

7. Use a brush to clean the entire rinsing-in section of the washing machine, particularly also the nozzles on the top side of the rinsing-in chamber.

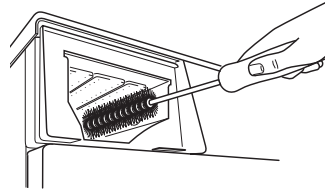

8. Set the detergent drawer into the guide tracks and push in.

## Washing Drum

The washing drum is made of stainless steel. Rusting foreign bodies in the washing can cause rust deposits on the drum.

**Important!** Do not clean the stainless steel drum with decalcifying agents containing acids, scouring agents containing chlorine or iron, or steel wool. Our Customer Service can provide suitable agents.

- ☞ Remove any rust deposits on the drum using a stainless steel cleaning agent.

## Main door

- ☞ Check on a regular basis to see if deposits or foreign objects are present in or at the rubber sleeve behind the door, and remove.

# What to do if ...

## Remedying Faults

In the event of a fault, try to solve the problem yourself with the aid of the information provided here. If you call Customer Service to deal with one of the faults listed here or to remedy an operating fault, the customer service technician's visit will not be free of charge, even during the warranty period.

- If the fault code **E 10**, **E20** or **E40** is shown in the multidisplay, you may be able to remedy the fault yourself (see Faults Table below). When you have remedied the fault, press the **START/PAUSE** button.



- With all other displayed faults (**E** plus number or letter): switch appliance off and on again. Reset the wash programme and press the **START/PAUSE** button.

If the fault code is displayed again, please contact the Customer Service department quoting the fault code.

Problem	Possible Cause	Remedy
The washing machine does not work.	The mains plug is not plugged in.	Plug in the mains plug.
	The fuse of the building's wiring is not in order.	Replace the fuse.
	The filling door is not correctly closed.	Close the filling door; the lock must engage audibly.
	The button <b>START/PAUSE</b> was not pressed for long enough.	Press the button <b>START/PAUSE</b> until the program begins.
The filling door cannot be closed.	The child safety feature is set.	Cancel the child safety feature (see section "Child Safety Feature").
Fault code <b>E40</b> appears. The indicator <b>MAIN WASH</b> flashes.	The filling door is not correctly closed.	Close the filling door correctly. Restart the program.



Problem	Possible Cause	Remedy
No water runs in. Fault code <b>E 10</b> appears. The indicator RINSE+ flashes.	Water tap is closed.	Open the water tap.
	Filter in screw connection of the intake hose is blocked.	Close the water tap. Unscrew the hose from the water tap, remove the filter and clean it under running water.
	Water tap is blocked with limescale or is faulty.	Check water tap and have it repaired if necessary.
The washing machine vibrates during operation or it is on an uneven surface.	The transport packaging has not been removed.	Remove transport packaging according to the installation and connection instructions.
	The height-adjustable screw feet are not correctly set.	Adjust in accordance with the installation and connection instructions.
	There is not much washing in the drum (e.g. only one dressing gown).	This does not impair the operation of the machine.
	The water could not be completely pumped off before spinning because the drainage hose is bent or the solution pump is blocked.	Check the laying of the drainage hose and eliminate the bend if necessary, or clean the solution pump and, if required, remove foreign bodies from the pump housing.
The washing solution of the main wash froths up a lot.	Too much detergent was probably used.	Meter the detergent exactly in accordance with the manufacturer's information.

Problem	Possible Cause	Remedy
Water runs out under the washing machine.	The screw connection on the intake hose is leaky.	Tighten the intake hose screw connection.
	The drainage hose is leaky.	Check the drainage hose and replace it if necessary.
	The washing solution pump cover is not correctly closed.	Close cover correctly.
	Washing stuck in the filling door.	Stop the program, remove washing from the filling door, start a new program.
	The emergency drain hose is not properly shut off or it is not water-tight.	Shut the emergency drain hose off properly (see section "Performing an Emergency Drain"). Call your after-sales service if the emergency drain hose is not water-tight.
Fault code <b>EFD</b> appears.	The Aqua Control anti-flood system has been activated.	Turn off the water tap, then remove the plug from the mains and inform Customer Service.
The drain pump for the washing machine runs constantly - even when the appliance is switched off.		
Conditioner not added, compartment  for care agent full of water.	Softener insert in the compartment for care agent not correctly attached or is blocked.	Clean the detergent drawer and firmly attach the softener insert.
Washing heavily creased.	Too much washing probably put in.	Pay attention to the maximum filling quantity (see Program Tables). For easy-care textiles, select the program EASY IRON.
The washing has not been spun as dry as usual.	The washing was not able to be distributed evenly in the drum prior to spinning.	Always load the drum as full as possible with a combination of large and small items.

Problem	Possible Cause	Remedy
<p>Washing not well spun. Residual water still visible in the drum. Fault code <b>E20</b> appears. The indicator RINSE flashes.</p>	Drainage hose bent.	Remove the bend.
	Maximum pump head (outlet head 1 m from unit's floor surface) exceeded.	Consult Customer Service. They can supply a retrofit kit as a special accessory for delivery heads of more than 1 m.
	Solution pump blocked.	Switch off the unit and pull out the mains plug. Clean the solution pump.
	If a siphon is connected: Siphon blocked.	Clean the siphon.
<p>The main door cannot be opened while the appliance is turned on.</p>	<p>The main door is locked because of a high water level or a high temperature. The display DOOR is not lit.</p>	<p>Wait until the display DOOR lights up green.</p> <p>Should it nevertheless be necessary to open the main door: Turn the programme knob to OFF; turn the programme knob to PUMP OUT. Press button START/PAUSE. The main door can be opened after the water has been pumped out.</p>
		<p>Power failure! (All displays have gone off.) For safety reasons the door remains locked for 4 to 5 minutes.</p>
<p>Washing detergent residues form in the washing detergent drawer.</p>	Water tap not fully opened.	Open the water tap fully.
	Filter in the screw connection of the intake hose on the water tap or on the unit is blocked.	Close the water tap. Unscrew the intake hose from the water tap and from the unit. Clean the filter.

Problem	Possible Cause	Remedy
The rinsing water is murky.	The cause is probably a detergent with a high silicate content.	No negative influence on the rinsing result, use liquid detergent if necessary.
The corresponding display does not light up when one of the additional program buttons is pressed.	The selected additional program cannot be combined with the set program.	Make another selection.

## If the washing results are not satisfactory

### If the washing has turned grey and if limescale is deposited in the drum, then

- Too little detergent was used.
- The wrong detergent was used.
- Special soiling was not pre-treated.
- Program or temperature not set correctly.
- If multi-component detergents are used, the individual components were not used in the correct ratio.

### If there are still grey spots on the washing,

- Washing soiled with ointments, grease or oils was washed with too little detergent.
- Too lower temperature was used for washing.
- A frequent cause is that softener - particularly that in concentrated form - has reached the washing. Wash out such spots quickly and use the softener concerned carefully.

### If at the end of the last rinse foam is still visible

- Modern detergents can also cause foam in the last rinse. However, the washing is still sufficiently rinsed.

### If there are white remnants on the washing

- These are insoluble components of modern detergents. They are not the result of an insufficient rinsing effect. Shake or brush out the washing. In future, perhaps you should turn the washing inside out before washing it. Examine your choice of detergent and if necessary use liquid detergent.

## Carrying out emergency drainage

- If the washing machine no longer pumps off the washing solution, emergency drainage must be performed.
- If the washing machine is in a room where there is a risk of frost, emergency drainage must be performed if there is a possibility of frost.

In addition: unscrew the inlet hose from the water tap and place it on the floor. Empty the drainage hose.



**Warning!** Switch off the washing machine before performing emergency drainage and pull out the mains plug.

**Caution!** The washing solution escaping from the emergency drainage hose may be hot. There is a risk of scalding! Allow the washing solution to cool down before performing emergency drainage.

1. Place a flat collecting vessel in order to collect the washing solution which is draining off.
2. Fold open the flap in the right section of the base outwards and pull it off.

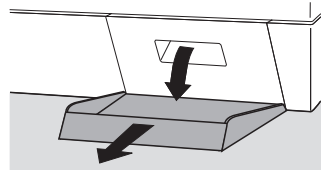

3. Remove the emergency drainage hose from its holder.

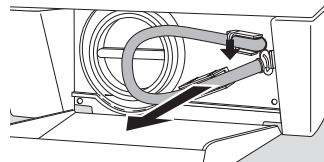

4. Place the container under the hose.
5. Detach the plug of the emergency drainage hose by turning it anticlockwise and pull it out.

The washing solution runs out. Depending on the amount of solution, it may be necessary to empty the collecting vessel several times. To do this, close the emergency drainage hose temporarily with the plug.

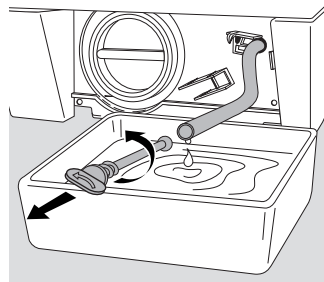

**When the water is completely drained:**

6. Push the plug securely into the emergency drainage hose and turn it clockwise to secure it.
7. Replace the emergency drainage hose in its holder.
8. Put on the flap and close.

## Drain pump

The drain pump is maintenance free. The cover of the drain pump must only be opened in the event of a malfunction when no more water is being pumped out, e.g. if the pump is blocked.

Before loading the machine, please always ensure that there are no foreign objects left in the pockets or in between the items to be washed. Paper clips, nails etc. which may find their way into the washing machine along with the washing will remain in the drain pump housing.

To restart the drain pump when it is blocked, please proceed as follows:



**Warning!** Switch off the washing machine and remove the mains plug before cleaning the drain pump!

1. First carry out an emergency emptying procedure (see section "Carrying out emergency emptying").
2. Place a cloth on the floor in front of the cover of the drain pump. Residual water may run out.
3. Unscrew the drain pump cover in an anti-clockwise direction and pull it out.

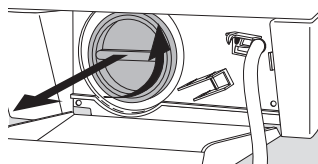

4. Remove any foreign objects and fabric lint from the pump housing.

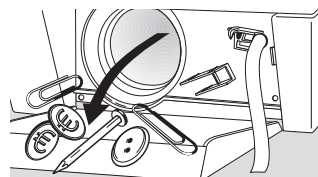

5. Replace the pump cover. Laterally insert the webs on the cover into the guide slots and screw on the cover in a clockwise direction.

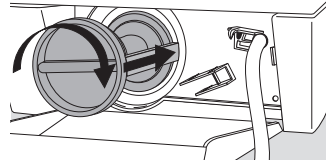

6. Close the emergency emptying hose and place it in the holder.

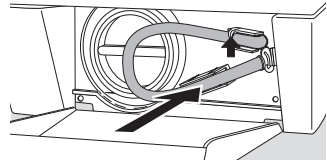

7. Close the flap.

## Additional Rinse (RINSE+)

The washing machine is set for extremely economical water consumption. However, for persons who suffer from allergies, it can be helpful to rinse with more water.



If RINSE+ is set, an additional rinse is performed in the case of the programs COTTONS/LINEN, EASY-CARES/EASY IRON and DELICATES. No additional rinse is set when the unit is delivered.

### Set Additional Rinse:

1. Turn the program selector to COTTONS/LINEN, EASY-CARES/EASY IRON or DELICATES with any temperature.
2. Simultaneously keep the button PRE WASH and the button QUICK WASH pressed for at least 2 seconds. RINSE+ lights up on the program run indicator. The additional rinse is set. It remains saved until you cancel it again.



Water consumption is increased due to the additional wash cycle.

### Cancel Additional Rinse:

1. Again turn the program selector to COTTONS/LINEN, EASY-CARES/EASY IRON or DELICATES.
2. Simultaneously keep the button PRE WASH and the button QUICK WASH pressed for at least 2 seconds. RINSE+ goes out in the program run indicator. The additional rinse is cancelled.

## Child Safety Feature

If the child safety feature is set, the filling door can no longer be closed and no washing program can be started.

### Setting the child safety feature

 Use a coin to turn the rotary knob on the inside of the filling door clockwise as far as it will go.



**Warning!** The rotary knob must not be in a vertical position after adjustment, otherwise the child safety feature is not active. The rotary knob must project as shown in the diagram

### Cancelling the child safety feature

 Turn the rotary knob anticlockwise as far as it will go.

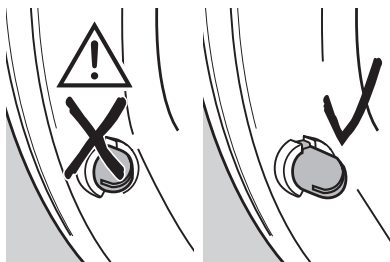
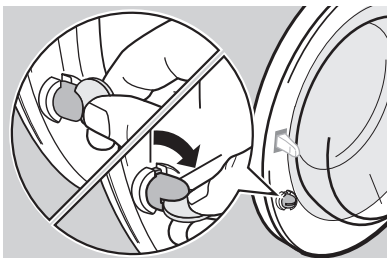



# Installation and connection instructions

## Installation Safety Precautions

- Do not tilt the washing machine onto its front or onto its right side (viewed from the front). Electronic components can get wet.
- Check the washing machine for transport damages. A damaged unit must never be put into operation under any circumstances. In the event of damage, please contact your supplier.
- Ensure that all parts of the transport safeguard are removed and that the unit is splash protected, see "Removing transport safeguard". Otherwise, the units or neighbouring furniture can be damaged when spinning.
- Always insert the plug into a correctly installed earthed socket.
- In the case of permanent connection: A permanent connection may only be made by an authorised specialist.
- Before putting the machine into operation, ensure that the mains voltage and current type shown on the unit's rating plate correspond with those at the place where the machine is being installed. The fuse rating is also found on the rating plate.
- Should work be carried out on the water supply installations in order to allow the machine to be connected properly to the water supply, this work must be carried out by an authorised installer.
- Should work be carried out on the mains supply in order to allow the machine to be connected properly to the electricity supply, this work must be carried out by an authorised electrician.
- The mains lead may only be replaced by the customer service or by an authorised electrician.

## Installation of the appliance

**i** Washing machines with curved panels are not suitable for installing under units.

### Transporting the appliance

- Do not place the washing machine on its front or on its right side (viewed from the front). Otherwise, electrical components can get wet.
- Never transport the unit without the transport safeguard. Do not remove the transport safeguard until the appliance is at the installation location. Transporting the unit without the transport safeguard can damage it.
- Lift the appliance neither by an open filling door nor by the base.

#### When transporting the unit with a sack trolley:

- Attach the sack trolley only at the side. The sack trolley shovel must not be longer than 24 cm, otherwise the float switch can be destroyed.

### Remove transport packaging

**Important!** It is essential to remove the transport packaging before putting the appliance into operation. Keep all parts of the transport packaging in a safe place for future use.

- 1.** Open both hose holders on the appliance's rear side and remove the hoses and mains cable.

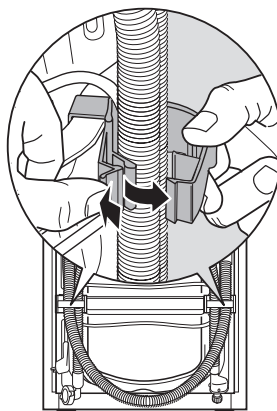

2. Pull both hose holders off the appliance with a strong pull.

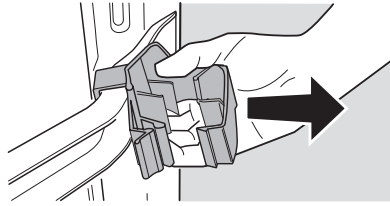

**i** The special spanner (A) and the caps (B) (2 each) and (C) (1 each) are supplied with it.

3. Remove the screw D, including the compression spring with the special spanner A.

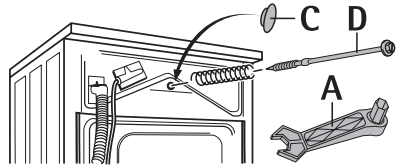

4. Cover the hole with the cap C.

**Important!** When fitting the plastic caps, press until they snap into the rear panel securely.

5. Remove the two screws (E) with the special spanner (A).

6. Remove the 4 screws (F).

7. Remove the transit bar (G).

8. Screw the 4 screws (F) back in for safe keeping.

9. Close the 2 large holes with the caps (B).

**Important!** When fitting the plastic caps, press until they snap into the rear panel securely.

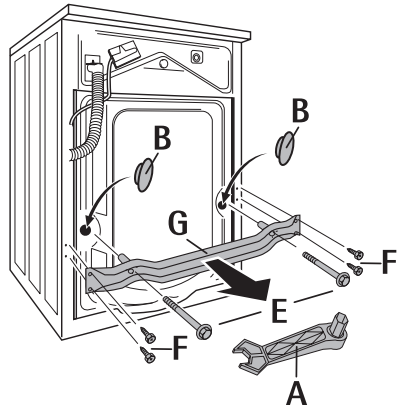

## Prepare the installation place

- The installation surface must be clean and dry, free of floor polish residues and other greasy coatings so that the unit does not slip away. Do not use lubricants as a sliding aid.
- Installation on a high-veil carpet or floor tiles with soft sponge backs is not recommended because the standing safety of the appliance is then no longer ensured.
- By installation surfaces with small-format tiles, lay a conventional rubber mat underneath.
- Minor unevenness of the floor surface should never be levelled out by laying pieces of wood, card or similar materials, but rather should always be compensated for by adjusting the screw feet.
- If, for space reasons, it is not possible to avoid setting up the unit directly next to a gas or coal-fired cooker: install a thermal insulation panel between the cooker and washing machine (85 x 57cm) which must have an aluminium film on the side against the cooker.
- The washing machine must not be set up in a room where there is a danger of frost. Frost hazard!
- Flexible feed and drain tubings may not be crinkled or squeezed.

## Installation on a concrete base

If the unit is set up on a concrete base, for safety reasons it is essential to fit stand plates in which the washing machine is adjusted. The stand plates are available from Customer Service under the spare parts number 645 425 058.

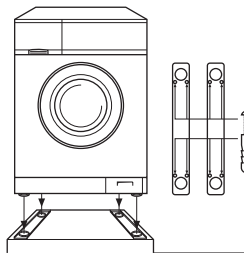

## Installation on vibrating floors

Where the floor vibrates, particularly in the case of wooden beam floors with pliable boards, securely screw a water-resistant wooden panel at least 15mm thick onto at least 2 floor planks. If possible, set up the unit in the corner of a room, as the wooden floor is optimally restrained there and is therefore least likely to be subject to resonance vibrations.

## Compensate for floor unevenness

**i** **Automatic adjustment foot:** The rear left foot of your washing machine is designed as a spring leg. This means that it guarantees that your unit will stand securely even at high spin speeds.

If, nevertheless, the washing machine is unstable during spinning, please proceed as follows:

- 1.** Set the three adjusted feet at the nominal value of 10 mm. To do this, use the supplied special spanner to remove the transport safeguard.

If the automatically adjusting foot does not reach the floor:

- 2.** Automatic adjustment foot (rear left) manually for extending the required dimension.
- 3.** If necessary, check the setting with a spirit level.

**Caution!** Never use wood, card or similar underlays to level out minor floor unevenness. Instead, always adjust the adjustment foot.

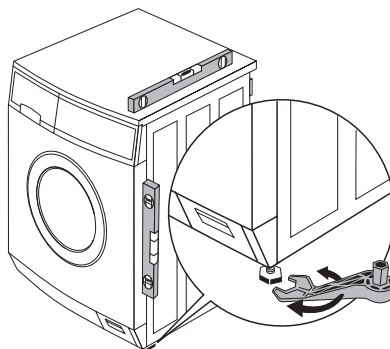

## Electrical connection

Details of the mains voltage, current type and required fuses can be found on the rating plate. The rating plate is located at the top above the filling door.

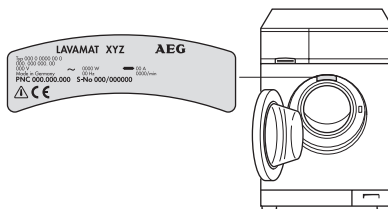

For permanent electrical connection within the electrical circuit, provisions must be made which allow for electrical disconnection of the appliance from the mains with a contact opening of at least 3 mm at all poles. Suitable devices include circuit breakers, fuses (threaded fuses must be entirely removed from the socket), ground fault circuit interrupters and contactors. Permanent connection may only be carried out by an authorised electrician.

- CE** This appliance complies with the following EC directives:
- The "Low Voltage Directive" 72/23/EU with changes
  - The "EMC Directive" 89/336/EU with changes

## Water connection

**i** The washing machine has safety features which prevent back-contamination of the drinking water and which conform to the national regulations of the water authorities (e.g. for Germany: DVGW guidelines). This means that additional protective measures in the installation are not necessary.

### Important!

- Units for connecting to cold water must not be connected to hot water.
- Use only new hose sets for the connection.

## Permissible water pressure

The water pressure must be at least 1 bar (= 10 N/cm<sup>2</sup> = 0.1 Mpa), maximum 10 bar = 100 N/cm<sup>2</sup> = 1 Mpa).

- If more than 10 bar: Connect a pressure-reduction valve upstream.
- If less than 1 bar: Unscrew the inlet hose on the unit side at the solenoid intake valve and remove the flow regulator (to do this, remove the filter with pointed pliers and take out the rubber washer behind). Replace the filter.

## Water inflow

A pressure hose 1.5m in length is supplied.

If a longer inflow hose is required, only a VDE-approved, complete set of hoses with fitted hose screw connections offered by our Customer Service is permissible.

- Hose sets in lengths of 2.2m, 3.5m and 5m are available for washing machines without Aqua-Control.
- Hose sets in lengths of 2.0m, 2.9m and 3.9m are available for washing machines with Aqua-Control.

**Caution!** Never cut into pieces in order to extend the hoses!



Sealing rings are supplied either in the plastic nuts of the hose screw connection or in the enclosed pack. Do not use other seals!



1. Connect the hose with the angled connection to the machine.

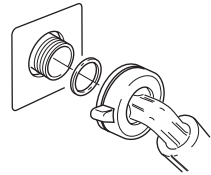

### Caution!

- Do not lay the infeed hose vertically downwards. Instead, turn it to the right or left as shown in the diagram.
- Tighten the hose connection only by hand.

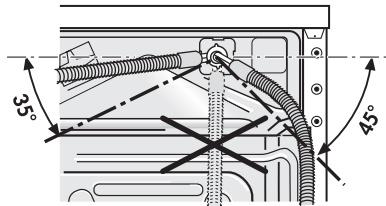

2. Connect the hose with the straight connection to a water tap with a R 3/4 (inch) screw thread.

**Caution!** Only tighten the screw connection manually.

3. By slowly opening the water tap before putting the washing machine into operation, check that the connection is free of leaks.

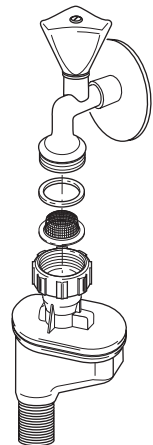

## Water drain

The drainage hose can either be connected to a siphon or hung in a wash basin or discharge basin or a bath tub.

Only original hoses may be used for extensions (max. 3m laid on the floor and then up to 80cm high). Customer Service stocks drainage hoses in lengths of 2.7 and 4m.

**Important!** It is essential to lay the drainage hose without kinks.

### Water drain-off inside a siphon

The grommet on the hose end fits all standard siphon types.



Secure the connection between the grommet and siphon with a hose clamp.

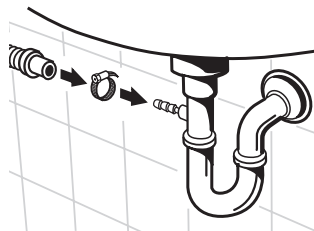

### Water drain-off inside a basin

#### Important!

- Small basins are not suitable for drainage. Water could overflow!
- The end of the drainage hose must not be submerged in the pumped-out water. Otherwise, the water could be sucked back into the unit.
- When hanging in a wash basin or a bath tub, the drainage hose must be secured with the supplied attachable bend to prevent it slipping. The back-surge force of the escaping water could otherwise force the hose out of the basin.

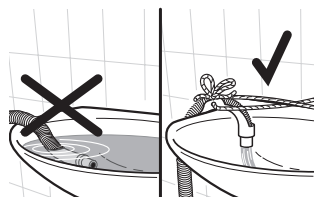

Tie the bend to the tap or the wall using a piece of string.

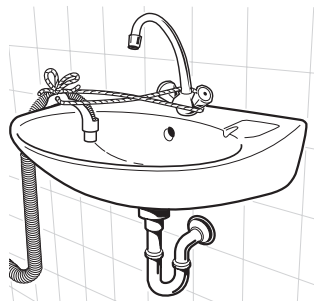

## Delivery heads over 1m

To pump off the washing / rinsing solution, every washing machine has a drain pump which carries liquids up to a height of 1m via the drainage hose, calculated from the machine's standing surface.

Please contact Customer Service for delivery heads of over 1m.



## Technical data

Adjustment possibility  
 Filling quantity (program-dependent)  
 Area of use  
 Drum speed, spinning  
 Water pressure

Approx. +10 / -5mm  
 max. 5kg  
 Domestic  
 See rating plate  
 1-10 bar (= 10 - 100 N/cm<sup>2</sup>  
 = 0.1 - 1.0 Mpa)

## Dimensions

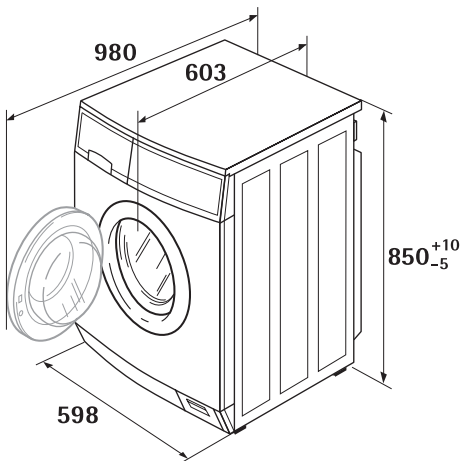

(dimensions in mm)

## Warranty conditions / Customer service centres

### **Weitere Kundendienststellen im Ausland**

In diesen Ländern gelten die Garantiebedingungen der örtlichen Partner. Diese können dort eingesehen werden.

### **Further after-sales service agencies overseas**

In these countries our AEG agents' own guarantee conditions are applicable. Please obtain further details direct.

### **Autres agences étrangères assurant le service après-vente**

Dans ces pays, les conditions de garantie des concessionnaires de la région sont valables. Vous pouvez les consulter sur place.

### **Otros puntos de Postventa en el extranjero**

En estos países rigen las condiciones de nuestros representantes locales, las cuales pueden ser consultadas allí mismo.

### **Ulteriori uffici del servizio tecnico assistenza clienti all'estero**

In questi paesi sono valide le condizioni di garanzia dei partner locali. Queste condizioni possono essere esaminate sul luogo.

### **Serviços de assistência técnica no estrangeiro**

Nestes países são válidas as condições de garantia dos concessionários locais, podendo aí ser consultadas.

### **További vevőszolgálati irodák külföldön**

Ezekben az országokban a mi AEG vevőszolgálatainknál saját jótállási feltételek alkalmazhatók. A további adatokat kérjük közvetlenül szerezzék be.

#### **U.A.E. Abu Dhabi**

Universal Trading Company  
P.O. Box 43 99  
Tel.: 335331

#### **Jordan**

Jordan Household  
Supply Co. Ltd.  
P.O. Box 3/68  
Amman/Tel.: 69 70 50

#### **Malta**

ITC  
International Trading Company  
White House Building  
Mountbatte Street  
Blata L-Bajda/Tel.: 220644

#### **Egypt**

Middle East Commercial  
Center  
P.O. Box 19  
Kairo-Heliopolis  
Tel.: 29917/31634

#### **Kanada**

EURO-LINE Appliances  
2150 Winston PARK Drive 20  
Oakville, Ontario L6H 5V1  
Tel.: 905 829 3980  
Fax: 905 829 3985

#### **Mauritius**

Happy World Centre Ltd.  
P.O. 7 54  
1 Chausee Street  
Port Louis  
Tel.: 25355

**Australia**

ANDI-Co Pty. Ltd  
9 Kingston Town Close  
Oakleigh VIC 3166  
Tel.: (03) 9569 1235  
Fax: (03) 9569 1450

**Bahrain/Arabian Gulf**

A.A. Zayani & Sons  
P.O. Box 9 32  
Bahrain  
Tel.: 261060

**Bulgaria**

Electrolux Bulgaria E.O.O.D.  
91 Levski Blvd.  
1000 Sofia  
Tel.: 2 806676  
Fax. 2 980 5276

**Cyprus**

Hadjikyrlakos & Sons Ltd.  
Prodromou 121  
P.O. Box 21587  
Nicosia 1511  
Service Telephones:  
Nicosia 02 481226  
Limassol 05 562182  
Larnaca 04 633929  
Paphos 06 932 699

**Estonia**

Electrolux Estonia Ltd.  
Mustamäe tee 24  
EE0006 Tallinn  
Tel.: (372) 6 650 090  
Fax: (372) 6 650 092

**Hongkong**

Wo Kee Services Ltd.  
585-609 Castle Peak Road  
Kwai Chung N.T.  
Hongkong  
Tel.: 2494 4000

**Korea (South)**

Core Incorp.  
3/F Chewoo Bldg.  
200 Nonhyun-Dong  
Kangnam-Ku  
Seoul  
Telefon 82 2 549 89 61

**Croatia**

Electrolux D.O.O.  
Suplova 7  
10000 Zagreb  
Tel.: 1 61 19512  
Fax: 1 61 19513

**Kuwait/Arabian Gulf**

Ali Al-Ghanim Est.  
P.O. Box 10 83  
Tel.: 5322463  
Fax: 5242114

**Lebanon**

Adib & Assaferi  
P.O. Box 539  
Tripoli

**Latavia**

Electrolux Latavia Ltd.  
Terlaton Street 42/44  
1011 Riga  
Tel.: 371 2 297821  
Fax: 371 2 821286

**Lthuania**

Electrolux Lthuania  
Verkui 29  
2600 Vilnius  
Tel.: 372 272 3326  
Fax: 372 272 3366

**Namibia**

AEG NAMIBIA (PTY) LIM-  
ITED-Jeppe Street  
Northern Industrial Area  
Windhoek  
Tel.: (061) 21-6082/4  
Fax: (061) 217838

**New Zealand**

Euro-Life New Zealand Ltd.  
Privat Bag  
58 Symonds Street  
Auckland  
Tel.: (09) 525 2222

**Nouvelle Caledonie**

Socometra N.C.  
B.P. 483  
Nouman  
Tel.: 275444

**Oman**

Moshin Haider Darwish  
P.O. Box 1 35  
Muscat  
Tel.: 703743

**Poland**

Electrolux Poland Sp. zo.o.  
ul. Domaniewska 41  
02-034 Warszawa  
tel.: 022 874 33 33  
fax: 022 874 33 00

**Russia**

Electrolux Russia Ltd.  
16 Olympiysky prospekt  
129090 Moscow  
Tel.: (095) 937 7837  
Fax: (095) 926 5513

**Israel**

Electricity & Electronic  
Services-Evis LTD.  
19 Hataasia st.  
Raanana,  
Industrial area 43654  
Tel: 972-9-7448118  
Fax: 972-9-7603618  
e-mail: [evis@evis.co.il](mailto:evis@evis.co.il)

**Malaysia**

Arzbergh Engineering  
No. 49A/B, Jalan Petaling  
Utama 7  
4600 Petaling Jaya  
Tel.: 3 795 1084  
Fax: 3 795 1082

**Saudi Arabia**

Alia Trading Corporation  
P.O. Box 4101  
King Abdul Aziz Street  
Riyadh  
Tel.: 4645977  
Al Nahas Est.  
Musaidia Market I  
P.O. Box 1 15 29  
Jeddah  
Tel.: 6606852

**Japan**

Electrolux Japan Ltd.  
Domestic Appliances Depart-  
ment  
Maruzen Showa Warehouse  
Building  
Tookai 4-5-12, Ota-ku  
143-006 Tokyo  
Tel.: 0120-13-7117  
Fax: 03-3790-5257

**Singapore**

Arzbergh Engineering  
19 Tanglin Road 06-07  
Singapore 247909  
Tel.: 65 7356572  
Fax: 7351124

**Slovenia**

Electrolux Slovenia D.O.O.  
Traska Ul. 132  
1000 Ljubljana  
Tel.: 61 1234 137  
Fax: 61 1234 238

**Thailand**

OLYMPIA Thai Ltd.  
44 Ratchadapisek Road  
10320 Bangkok  
Tel.: 2 513 6111  
Fax: 2 513 2574

**Slovakia Rep.**

Electrolux Slovakia S.R.O.  
Seberiniho 1  
821 03 Bratislava  
Tel.: 02 4333 4322, 4355  
Fax: 02 4333 6976

**South Africa**

AEG (Pty) Ltd.  
55, 12th Road  
P.O. Box 1 02 64  
Kew/Johannesburg 2000  
Tel.: 8069111

**Hungary**

Electrolux Lehel KFT  
(AEG Div)  
Erzsébet Királyné útja 87.  
1142 Budapest  
Tel.: 00361/467-3200

**USA**

ANDI Co. Appl. Inc. East  
65 Campus Plaza  
Edison, New Jersey 0837  
USA/Tel.: (201) 2258839

**Syria**

Masri & Shami  
P.O. Box 24 96  
Damascus  
Tel.: 214080



# INDEX

## A

Aqua Control ..... 14, 27, 34  
Automatic adjustment foot ..... 10, 45

## C

Care agent ..... 10, 17, 18, 23  
Child safety feature ..... 32, 40  
Conditioner ..... 10, 12, 23, 29  
Cottons ..... 11, 16, 28, 29  
Curtains ..... 15, 28  
Customer Service ..... 14, 31, 32, 55

## D

Delay timer ..... 11, 13, 21, 24  
Delicates ..... 12, 16, 28  
Detergent ..... 10, 17, 23  
Detergent drawer ..... 10, 23  
Door opening ..... 22, 27, 35  
Drain pump ..... 10, 38

## E

Easy iron ..... 12, 16, 28, 34  
Easy-cares ..... 12, 16, 28  
Emergency drainage ..... 37  
Energy saving ..... 11, 28

## F

Filling quantity ..... 14, 28

## G

Gentle rinse ..... 12, 29

## H

Handwash ..... 12, 28, 29

## I

In-wash stain treatment ..... 10, 23

## L

Linen ..... 11, 16, 28, 29

## M

Multi-display ..... 11, 21, 24, 25, 32, 55

## O

Over-dosed ..... 27

## P

Pre wash ..... 13, 19, 23, 28  
Pre-wash detergent ..... 10, 23  
Program aborting ..... 26

Program changing ..... 26

Program sequence display ..... 11, 25

Pump out ..... 12, 27

## Q

Quick wash ..... 13, 19, 26, 28

## R

Rating plate ..... 10, 46, 55

Rinse hold ..... 12, 20, 27

Risk of frost ..... 6, 37

Run time ..... 21, 25

## S

Silk ..... 12, 16

Soaking ..... 13, 19, 21, 23, 28

Soaking agent ..... 23

Spin ..... 12, 26, 29

Spinning ..... 20

Stain ..... 9, 10, 13, 19, 26, 28, 36

Starching ..... 12, 29

## U

Update ..... 14

## W

Warranty ..... 6, 32, 50

### Washing

coloureds ..... 15

lightly soiled ..... 9, 13

normally dirty ..... 9

sensitive ..... 16

Washing powder ..... 10, 17, 18

### Water

hardness ..... 9, 17

pump off ..... 12, 27

softener ..... 9, 10, 17, 23

Woollens ..... 12, 16, 28, 29

hand-washable ..... 12, 28



 **From the Electrolux Group. The world's No. 1 choice.**

*The Electrolux Group is the world's largest producer of powered appliances for kitchen, cleaning and outdoor use. More than 55 million Electrolux Group products (such as refrigerators, cookers, washing machines, vacuum cleaners, chain saws and lawn mowers) are sold each year to a value of approx. USD 14 billion in more than 150 countries around the world.*

AEG Hausgeräte GmbH  
Postfach 1036  
D-90327 Nürnberg

<http://www.aeg.hausgeraete.de>

© Copyright by AEG

822 942 800-01-220403-06

Subject to change without notice



## Free Manuals Download Website

<http://myh66.com>

<http://usermanuals.us>

<http://www.somanuals.com>

<http://www.4manuals.cc>

<http://www.manual-lib.com>

<http://www.404manual.com>

<http://www.luxmanual.com>

<http://aubethermostatmanual.com>

Golf course search by state

<http://golfingnear.com>

Email search by domain

<http://emailbydomain.com>

Auto manuals search

<http://auto.somanuals.com>

TV manuals search

<http://tv.somanuals.com>