



Operation/Reference Guide

Delta Series

Distributed Audio Controllers

DAS-D(I)0404 4 Source, 4 Zone Controller

DAS-D(I)0406 4 Source, 6 Zone Controller



AMX Limited Warranty and Disclaimer

All products returned to AMX require a Return Material Authorization (RMA) number. The RMA number is obtained from the AMX RMA Department. The RMA number must be clearly marked on the outside of each box. The RMA is valid for a 30-day period. After the 30-day period the RMA will be cancelled. Any shipments received not consistent with the RMA, or after the RMA is cancelled, will be refused. AMX is not responsible for products returned without a valid RMA number.

Warranty Repair Policy

- AMX will repair any defect due to material or workmanship issues during the applicable warranty period at no cost to the AMX Authorized Partner., provided that the AMX Authorized Partner is responsible for in-bound freight and AMX is responsible for out-bound ground freight expenses.
- The AMX Authorized Partner must contact AMX Technical Support to validate the failure before pursuing this service.
- AMX will complete the repair and ship the product within five (5) business days after receipt of the product by AMX. The AMX Authorized Partner will be notified if repair cannot be completed within five (5) business days.
- Products repaired will carry a ninety (90) day warranty or the balance of the remaining warranty, whichever is greater.
- Products that are returned and exhibit signs of damage or unauthorized use will be processed under the Non-Warranty Repair Policy.
- AMX will continue to provide Warranty Repair Services for products discontinued or replaced by a Product Discontinuance Notice.

Non-Warranty Repair Policy

- Products that do not qualify to be repaired under the Warranty Repair Policy due to age of the product or Condition of the product may be repaired utilizing this service.
- The AMX Authorized Partner must contact AMX Technical Support to validate the failure before pursuing this service.
- Non-warranty repair is a billable service.
- Products repaired under this policy will carry a ninety (90) day warranty on material and labor.
- AMX will notify the AMX Authorized Partner with the cost of repair, if cost is greater than the Standard Repair Fee, within five (5) days of receipt.
- The AMX Authorized Partner must provide a Purchase Order or credit card number within five (5) days of notification, or the product will be returned to the AMX Authorized Partner.
- The AMX Authorized Partner will be responsible for in-bound and out-bound freight expenses.
- Products will be repaired within ten (10) business days after AMX Authorized Partner approval is obtained.
- Non-repairable products will be returned to the AMX Authorized Partner with an explanation.
- See AMX Non-Warranty Repair Price List for minimum and Standard Repair Fees and policies.

IMPORTANT SAFETY INSTRUCTIONS



1. Read instructions.
2. Keep these instructions.
3. Heed all warnings.
4. Follow all instructions.
5. Do not use this apparatus near water.
6. Clean only with dry cloth.
7. Do not block any ventilation openings. Install in accordance with the manufacturer's instructions.
8. Do not install near any heat sources such as radiators, heat registers, stoves, or other apparatus (including amplifiers) that produce heat.
9. Do not defeat the safety purpose of the grounding-type plug. The grounding plug has two blades and a third grounding prong. The third prong is provided for your safety. If the provided plug does not fit into your outlet, consult an electrician for replacement of the obsolete outlet.
10. Protect the power cord from being walked on or pinched particularly at plugs, convenience receptacles, and the point where they exit from the apparatus.
11. Only use attachments/accessories specified by the manufacturer.
12. Use only with cart, stand, tripod, bracket, or table specified by the manufacturer, or sold with the apparatus. When a cart is used, use caution when moving the cart/apparatus combination to avoid injury from tip-over.
13. Unplug this apparatus during lightning storms or when unused for long periods of time.
14. Refer all servicing to qualified personnel. Servicing is required when the apparatus has been damaged in any way, such as power supply cord or plug is damaged, liquid has been spilled or objects have fallen into the apparatus, the apparatus has been exposed to rain or moisture, does not operate normally, or has been dropped.



Warning: Shock Hazard - *The lightning flash within an equilateral triangle, intended to alert the user to the presence of un-insulated "Dangerous voltage" within the products enclosure that may be of significant magnitude to constitute a risk of electric shock to persons*



Read Accompanying Documentation – *The exclamation point within an equilateral triangle is intended to alert the user to the presence of important operating and maintenance (servicing) instructions in the literature accompanying the product.*

15. The fuse should only be replaced with the same type fuse as listed on rear of apparatus.
16. The RCA, RJ11 and RJ45 Jacks shall only be used for their intended use. Refer to accompanying documentation to insure that they are being used as intended.
17. The spring clip terminals and F-connector on the tuner module should only be used to connect an AM and FM antenna.
18. Use only an indoor antenna or grounded outdoor antenna.
19. A grounded power outlet is required for safe operation.
20. The grounded 3 prong power cable will be the mains disconnect and it should remain readily available.
21. To completely disconnect the unit from the AC mains, disconnect the power supply cord plug from the AC receptacle.
22. The mains voltage for the AC mains is listed on the back of the apparatus.

Warning – *To reduce the risk of fire or electric shock, do not expose this apparatus to rain or moisture. Do not expose this equipment to dripping or splashing and ensure that no objects filled with liquids are placed on the equipment.*

Caution: *to prevent electric shock, match wide blade of plug to wide slot, fully insert.*

Table of Contents

IMPORTANT SAFETY INSTRUCTIONS	a
Delta Series Audio Controllers	1
Overview	1
Product Specifications	1
Tuner Antenna Details.....	2
Delta Installation - Quick Start Steps	3
1. Connect the Source Units to Delta	3
Source Inputs (up to 4).....	3
2. Connect the Keypads to Delta.....	4
3. Connect the Speakers to the Keypads.....	4
4. Power Up and Test the Basic System Operation.....	5
Turning a Zone ON.....	5
Volume Control	5
Tone Control	6
5. Basic Programming	6
IR Learning Techniques	6
Program Panel.....	6
Wiring and Connections	7
Pre-Installation Precautions and Recommendations	7
Note to Professional Installers	7
Installing Source Equipment.....	7
Cabling Installation Instructions	7
Cable Type	8
RF Interference.....	8
Distribution Wiring.....	8
Considerations for New Construction Installations	8
Securing the Cables	8
Keypad "Rough In" Locations	8
Considerations for Existing Construction.....	9
Running Wires in Existing Construction.....	9
Marking the Cables	9
Existing Electrical Boxes for Keypads	9
Considerations for Outdoor Zones	10
Outdoor Wiring.....	10
Outdoor Keypads.....	10
Controller Connections	10

Source Unit to Controller Connections.....	10
AM/FM Tuner Connections.....	11
Standard 4 Wire Keypad Connections.....	13
2 Wire Keypad Connections (Control Only).....	14
Multiple Keypads in a Zone.....	15
Matrix Keypad plus Analog Volume Controls.....	16
Auxiliary Amplifier Configuration (Zone 1).....	17
Auxiliary Amplifier Configuration (Zones 2-6).....	18
Remote Amplifier Configuration.....	18
Connecting the RS-232 Serial Port.....	19
RS-232 Cable.....	19
Connecting Matrix Keypads.....	19
Tools Required for Installation.....	19
Orientation of Connectors.....	19
Preparing the Wires.....	20
Wire Color Schemes.....	20
Installation into the Wall Cavity.....	21
Connecting Matrix In-Ceiling Speakers.....	22
Overview - Speaker Wire Technology (SWT).....	22
Overview - Matrix Speakers.....	22
Wiring Method A.....	22
Method B (Retrofit).....	23
Programming the Delta System.....	27
Overview.....	27
Preparation for Programming.....	27
Programming Worksheets.....	27
Accommodating Multiple Device Programming.....	29
Program Panel.....	29
Enter the Program Mode.....	29
Program Menu Selections.....	30
Setup Program Menu.....	30
Controller Sub Menu.....	31
Programming Source Components.....	31
Keypad Functions By Profile.....	33
Learning IR Commands.....	35
Labeling IR Commands.....	37
Adding Delay to IR Commands.....	39
Labeling a Source.....	39
Labeling a Room.....	40

Check Room Status	42
Setting Source Levels	43
Tuner Sub Menu	44
Setting a Station Preset	44
Clock Sub Menu	45
Preferences Program Menu	45
Backlight Sub Menu	45
Display Options Sub Menu	46
About Program Menu	48
Firmware Version	48
Using Matrix Keypads	49
Using the Matrix KP-4e Keypad	49
Source Selection	49
Activating or Deactivating a Zone	49
All Zones ON or OFF	50
Navigation Command Keys	50
Volume Control	51
Muting the Volume	51
Tone Control	51
Bass (and Balance) Adjustment	52
Treble (and Balance) Adjustment	52
Using the Matrix KP-NUM Keypad	53
Direct Access Control	53
Direct Numeric Access - On Board AM/FM Tuner	53
Direct Numeric Access - CD Player or Changer	54
Direct Numeric Access - Satellite Radio or DSS/DBS Tuner	54
Setting Individual Source Component Presets	55
Create a Preset	55
Recall a Preset	55
Clear All Presets	55
Using the Matrix Touch Panel Keypad	57
Labeling the Keypad Grids	57
Customizing LCD Keypad Labels	58
Customizing SOURCE Labels	58
Customizing SOURCE COMMAND Labels	59
Using the Matrix D-RC Remote	61
Overview	61
RS-232 Control Commands / Messages	63
RS-232 Controller Command Messages	63

Delta Audio Controller Status Messages	67
Source Command Codes.....	70
Troubleshooting	71
Overview	71
Power Connections	71
Source Unit Connections.....	71
Zone Connection Problems.....	72
No Keypad Activity (At All).....	72
Keypad Lights, No Sound	72
Troubleshooting Quick Reference	73

Delta Series Audio Controllers

Overview

The Delta Series Audio Controller is an affordable, feature-rich multi-zone audio distribution system that allows control and distribution of audio from 4 sources and to 4 or 6 zones.

- The DAS-D0404 controls up to 4 sources and distributes audio to 4 rooms/zones.
- The DAS-D0406 controls up to 4 sources and distributes audio to 6 rooms/zones.
- Delta Series Audio Controllers are available in 120V (**DAS-D0404** & **DAS-D0406**), or 240V versions (**DAS-DI0404** & **DAS-DI0406**).

FIG. 1 indicates the front and rear panel components on the Delta Controllers.

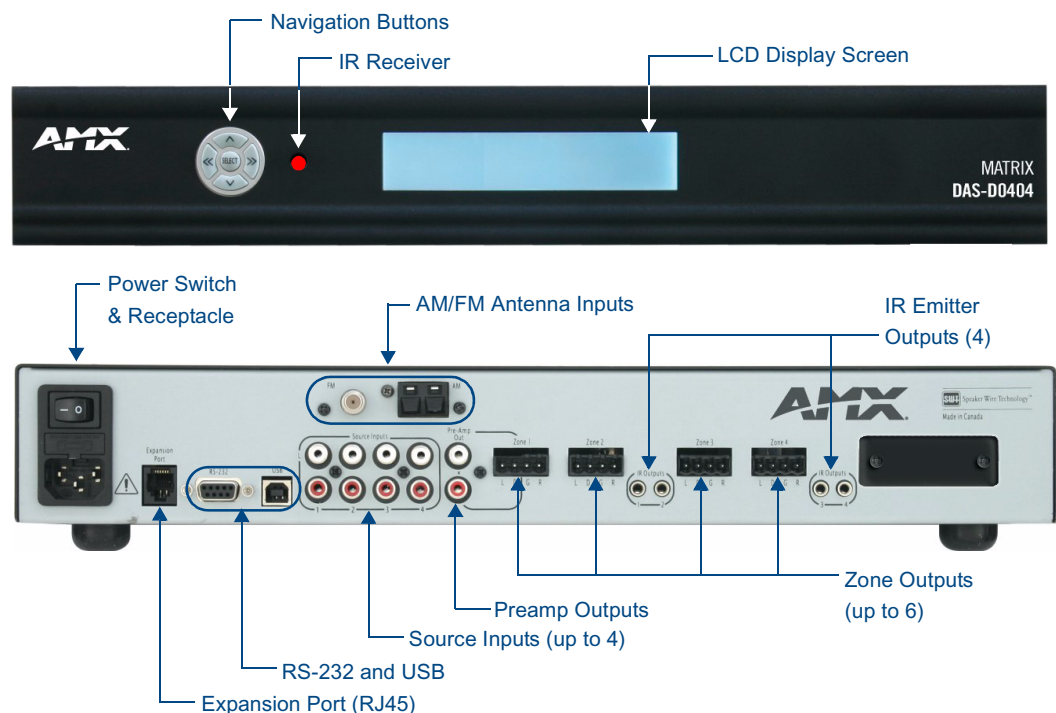

FIG. 1 Delta Controller Layout - Front and Rear Panel Details (DAS-D0404 shown)

Product Specifications

Delta Series Product Specifications	
Models Available:	<ul style="list-style-type: none"> • DAS-D(I)0404 4 Source, 4 Zone Controller (120V or 240V) • DAS-D(I)0406 4 Source, 4 Zone Controller (120V or 240V)
Stereo Output:	25 Watts/CH stereo (20Hz to 20Khz @ .1% THD)
Power:	287W max (Actual average usage = 120W)
Front Panel Components:	
• Navigation Array Buttons	Allow for front panel programming, selection of sources, and tuning AM/FM radio stations (when Delta is fitted with the optional tuner board). The same array appears on the Matrix KP-4e navigational keypad.
• IR Receiver	For the IR receiver. This is where you must aim the remotes from your audio source components so the Delta can learn and emulate those commands.

Delta Series Product Specifications (Cont.)	
• LCD Display Screen	Displays information necessary during the programming steps and afterward is the display to indicate information about the source input and zone activity.
Rear Panel Components:	
• Power Switch & Receptacle	The master power switch will remain in the ON position normally.
• AM/FM Antenna Inputs	Connections for the AM and FM Antennas.
• IR Outputs (4)	Four 3.5mm IR Emitter Output Jacks. <i>Note: Be sure to connect the emitter to the same numbered port as the corresponding source input.</i>
• Zone Outputs (up to 6)	Connections for zone outputs that connect to the keypads.
• RJ 45 Port	Ethernet Port for future expansion
• RS-232 and USB Ports	For firmware upgrades and interface with NetLinx control systems.
• Source Inputs (up to 4)	RCA connections for 2-channel audio input from up to 4 external sources (unless an AM/FM tuner board is present, which internally takes up the Source #1 location - then it's 3 additional sources).
• Preamp Outputs	RCA outputs to run an external amplifier. This is only available for Zone output #1.
Dimensions (HWD) - including feet and rear connectors:	<ul style="list-style-type: none"> • 3 1/16" x 17" x 13 1/2" • 7.68cm x 43.18cm x 33.52cm
Weight:	24.05 lbs (10.91 kg)

Tuner Antenna Details

- The TA-MOD tuner automatically becomes source #1 when installed into the Delta Controller
- The TA-MOD tuner requires a 75 Ohm F-Type connection to receive FM stations.
- The TA-MOD tuner requires an AM antenna loop to receive AM stations.

Delta Installation - Quick Start Steps

1. Connect the Source Units to Delta

Plug RCA audio cables from each source device into the labeled RCA jacks at the back of the Delta Controller. Ensure that right and left are connected correctly. Then connect the IR emitter leads for each audio source into the appropriate connector on the back of the Delta Controller and run the optical end of the emitter lead to the source device's IR receiver window.

Attach the emitter by peeling and sticking the supplied adhesive patch on the emitter. If an on-board tuner is pre-installed into Delta, you must also connect AM and FM antennas as shown in FIG. 1.

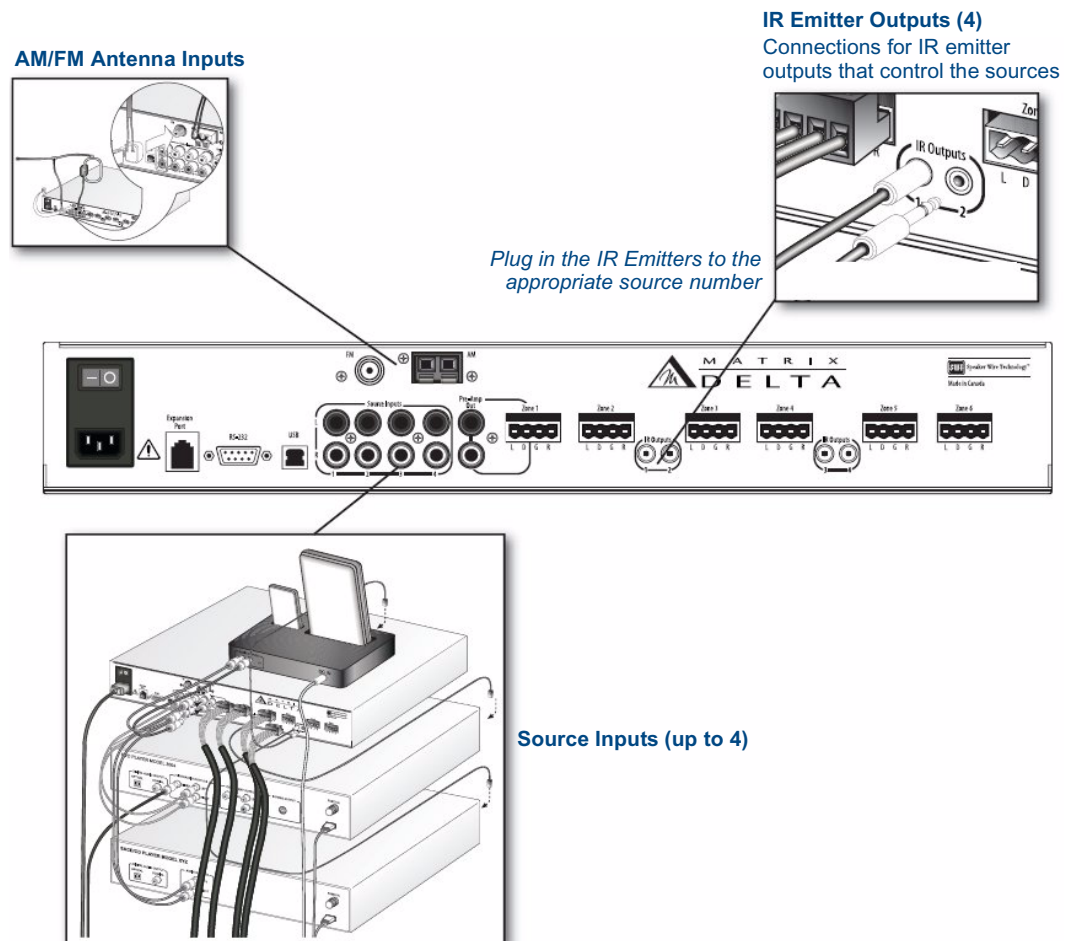

FIG. 1 Connect the Source Units to Delta

Source Inputs (up to 4)

RCA connections for 2-channel audio input from up to 4 external sources (unless an AM/FM tuner board is present, which internally takes up the Source #1 location - then it's 3 additional sources). The illustration at left shows an example of a DVD player, CD player, and iPod docking device all connected to Delta. The fourth source is the internal AM/FM tuner.

2. Connect the Keypads to Delta

Looking at the rear of the keypad with the connectors at the bottom, you will see (2) plug type 4 pin receptacles. The connector on the right side terminates the 4 conductor wire from the Delta Controller and the connector on the left side passes the audio to the speakers in the zone (FIG. 2).

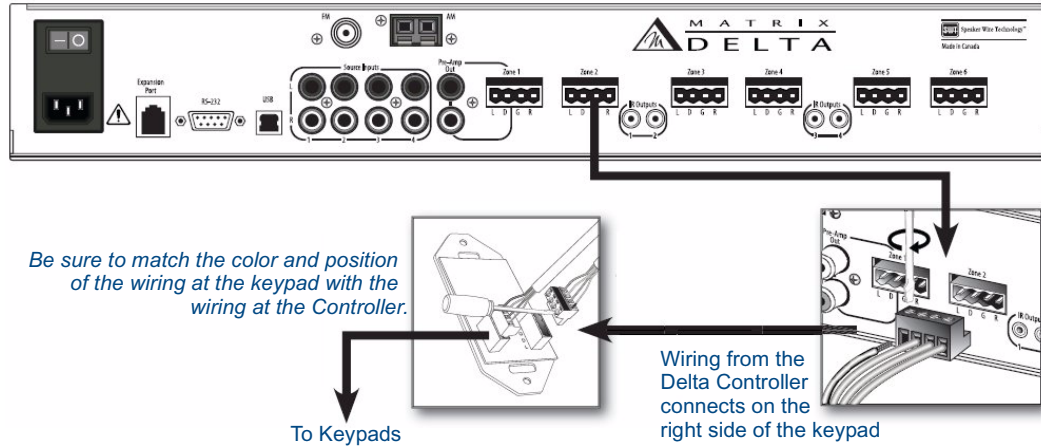

FIG. 2 Connect the Keypads to Delta

Although speaker wire is commonly used, you can also use CAT-5 or other paired wiring. Please see the complete Delta Installation Manual for details.

3. Connect the Speakers to the Keypads

Speakers will be wired according to their positive and negative terminals, which are usually Red and Black for each speaker. Once installed in their locations, the speaker wiring is typically run to the keypad location and is connected into the connector on the left side of the keypad. Repeat this for each zone in the system (up to six). There are alternative connection schemes for speakers directly to Delta or via external amplifier.

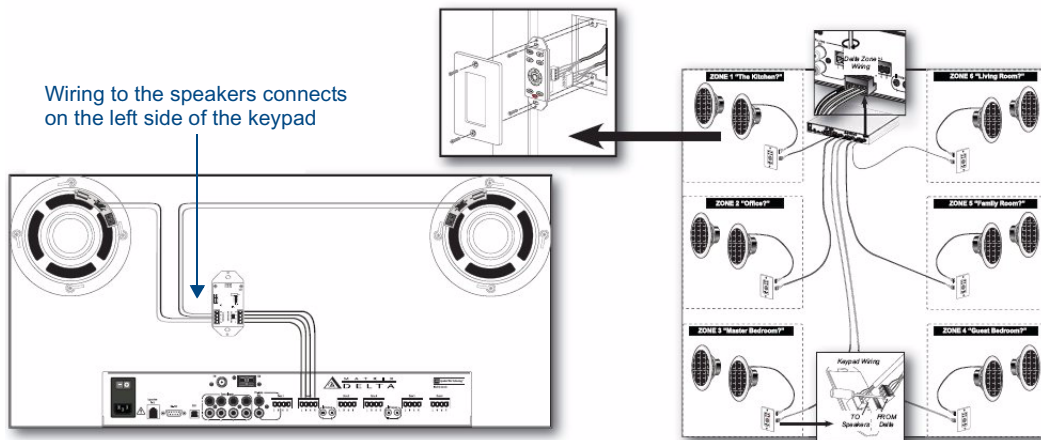

FIG. 3 Connect the Keypads to Delta

Please see the complete Delta Installation Manual for details.

4. Power Up and Test the Basic System Operation

Make sure the Delta Controller is plugged into the wall and the power switch on the back panel is in the ON position. The Delta system should now be ready for initial testing.

To test the system connections, activate one source from a keypad. Begin by manually activating one of the available audio sources such as the tuner and move through each zone and test that keypads respond to the on/off, volume, and tone control commands and that the source can be heard in all zones on both speakers.



NOTE

We assume the programming has not yet taken place

The basic functionality of the Delta Controller (which means turning Delta on/off, volume up/down and treble/bass/balance) are functions that can be performed without programming (FIG. 4).

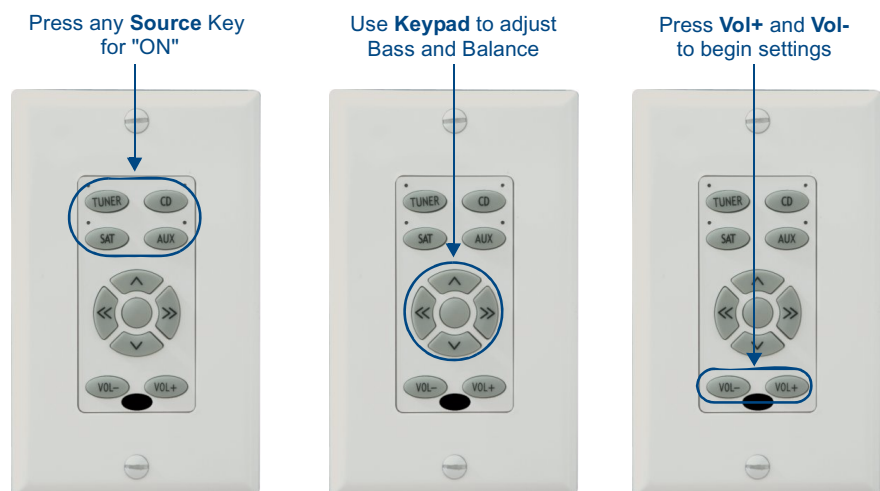

FIG. 4 Power Up and Test the Basic System Operation

If a tuner module has been installed, all of the basic tuner operations will also be able to function without any programming so you will have sound for a test signal right away. The IR repeaters must be installed and basic source component commands must be programmed to select and/or control any external sources however. Until then, you will have to manually turn on and start the external source component if used as a test source!

Turning a Zone ON

Pressing the Source key turns the system on in the room you are in and also turns that source on if it has not been previously selected in another zone. The indicator next to the source will light Red. Through Matrix's own Dynamic Macro process, sources that are muted or paused will be turned off after they are idle (not selected in any zone) for ten minutes. Press the active source button again to turn the zone off.

Volume Control

Control of the system volume is very intuitive because of discrete buttons for the Volume UP and Volume DOWN command. When increasing or decreasing volume, the progression is in 3dB steps when the volume is half (of maximum) or below. Above the halfway point, the progression drops to 1dB steps so you can fine tune the adjustment without worry of overdriving speakers by surprise.

Tone Control

The tone control mode allows the user to adjust Bass, Treble, and Balance on a “per zone” basis. To enter tone control mode, press VOL UP & VOL DOWN buttons simultaneously until LED’s begin to cycle in a counter-clockwise motion.

This will enable the BASS and BALANCE settings first. At any time during adjustments, If you want to return the settings to default, press and hold the centre keypad navigation button. When you are satisfied with your adjustment, press (but not hold) the centre keypad navigation button to save the bass and balance adjustment. This will take you to the treble and balance adjustment mode. Once again, once adjustments are complete, press (but not hold) the centre keypad navigation button to return to normal operation mode.

5. Basic Programming

The key to successful programming is to understand how each of the source components operates.

Programming and IR Capture take place on the front panel of the Delta Controller. Settings such as Bass, Treble, and Balance functions are programmed from within any zone using the keypad. We suggest you read this section carefully in its entirety BEFORE starting to program the Delta Controller. This will allow you to obtain a general understanding of what you will see and what to expect when you go through the programming exercise.

IR Learning Techniques

Programming techniques may need to be modified on a remote-by-remote basis. Some remotes may need to be closer to or further away from the Delta Controller. Some may program better with quick key presses and some with long key presses. Generally speaking, the audio source remote should be located about 6-12 inches away from the IR receiver on the Delta Controller.

The path between the devices should be unobstructed with a clear line of sight.

Fluorescent light fixtures and bright sunlight may interfere with the learning process, so you may choose to shade the IR receiver with a sheet of paper or other practical means. When possible use only incandescent lighting during the programming session. During programming, distance between the remote and the Delta Controller is also important. If the remote is too close to the unit the IR signal will overload the learner. If it’s too far away, it might not learn due to weak signals strength. A bit of trial and error will quickly get you to the correct distance.

Program Panel

The programming controls (also called the “navigational array”) and the IR receiver are located on the front of the Delta Controller. The four directional buttons allow you to navigate through the menu screens. The centre button is used to make selections (as if to press OK or ENTER).

Refer to the *Programming the Delta System* section on page 27 for detailed programming instructions.

Wiring and Connections

Pre-Installation Precautions and Recommendations

The Matrix Delta system is extremely flexible. It can be installed in a number of configurations depending on your audio needs. The capacity of a single unit is 6 independent zones and is typically wired with at least one keypad located in each zone. In some cases it is desirable to operate a second set of speakers within the same zone controlled by the same keypad. The Delta Controller will power 2 sets of speakers as long as the impedance does not drop below 4 ohms. If you have two common zones such as the Master Bedroom and Master Bathroom you can use the a single keypad and multiple analog volume controls for independent control of the two areas while sharing the same source control capability. Up to 2 Matrix keypads can also be connected in a zone as a with a single pair of speakers.



NOTE

Each zone can be configured with either 2 pushbutton keypads (Numeric or Source), or 1 LCD Keypad and 1 pushbutton Keypad, but not 2 LCD keypads.

See the *Multiple Keypads in a Zone* section on page 26 for details.

Note to Professional Installers

AMX always recommends professional installation for our products. As with any entertainment product in a home or commercial application, a Delta system installation will go much faster and more smoothly if job plans are completed **prior to the actual installation**.

Accurate record keeping will assist not only in the installation, but also in training the client in the operation of the system. This will also be a great tool for any future servicing issues that may arise.

We recommend that you make copies of the records and leave them behind with your client as well as putting a duplicate copy in your client's file. For the professional installer's convenience, programming worksheets are available at www.amx.com.

Installing Source Equipment

To meet airflow and cooling requirements, place each audio source on an individual shelf and allow a minimum of 3" clearance on the sides and top of the unit. Stacking equipment is not recommended as this presents situations in which airflow is restricted or component cooling may be impaired. The audio source equipment and the Controller will generate small amounts of heat that must be dissipated to extend component life and maintain performance.

Equipment should have adequate room in the rear for the cables to reside. If rear access, or a rack a mounted structure has been provided then cable installation will be much easier.

Cabling Installation Instructions

Please be sure to check for any wiring restrictions required by the electrical code in your area.

This installation uses low voltage cabling similar to telephone and alarm wiring, and as such does not commonly have very many restrictions on their installation. However rules may vary in different regions. Please check with your local code enforcement official to determine if any specific conditions must be met to comply with local electrical codes.

Cable Type

The Delta Controller is cabled using standard 4-conductor speaker cable originating at the Delta control unit passing through the keypad and terminating at the speaker location. Matrix Audio Designs generally recommends using a bundled 4 conductor 16 gauge stranded copper wire in a single continuous run. The keypads also function with Cat 5 or basically any 2 conductor wire configuration that is not used for other devices.

RF Interference

Shielded cable is generally not required for audio installations. Although the Delta Controller does generate very low radio frequency emissions, it uses a digital signaling path during command entry. There are normally no ongoing data communications in the circuit path. Communications only occur at the time a command is issued from a zone. However many other systems do use microprocessor systems where the cabling may be in close proximity such as telephone and security systems, and it is possible for different systems to interfere with each other. If you face an installation where your cable runs are in parallel to these types of systems you may consider shielded cable to the keypads. In this case ground the drain wire by connecting it to the chassis of the Delta Controller.

Distribution Wiring

In general, wiring is installed in a single continuous run between the Delta Controller, the keypad and the speaker location. Other cable routing options such as a home run to a common wiring distribution point, integration with home automation systems, or split zone applications can be significantly different than the general information presented here. These applications are left to the installer's discretion and experience, which is why Matrix Audio recommends installation by a professional. Examples of common wiring options can be found in the "Controller Connections" section of this manual.

Considerations for New Construction Installations

It's generally accepted to run the 2 and 4 conductor speaker cables inside walls, in the attic and between the joists in the basement or crawl space. When installing cables within walls, *drill the holes in the middle of the studs* to avoid having them damaged by screws or nails that could penetrate the cable. Use metal nail guard plates where necessary to protect the cable from future construction damage or from something like nails/screws that are installed to hang future pictures or shelving. When running cables in the attic or crawl space, run them in such a way that they will be out of harm, where they will not be stepped on, snagged, punctured, or could pose a safety hazard.

Do not run cable thru the return air path that utilizes the wall or ceiling space as the plenum.

Securing the Cables

We recommend using electrical cable straps to keep the installation neat and secure. **We do not recommend stapling the cables** as a single misplaced staple can cause a short that causes trouble during operations and set-up. Do not leave the wires lying in the dirt under the crawl space.

Neatness counts in a professional installation.

Keypad "Rough In" Locations

The keypad device itself will fit in a standard electrical box or new construction plate and you should install 1 or 2 gang (as required) standard electrical boxes to accommodate them before the drywall has been put into place. Keep in mind that because these are low voltage applications, plastic electrical boxes are generally adequate for the keypad, but check local building code requirements to be sure. The high voltage electricians on the job site will know which electrical box is appropriate and within code. These emissions have been accommodated for in design and conform to RF emission standards.

Considerations for Existing Construction

For existing construction, successful implementation can be achieved by using retrofit electrical boxes that do not require stud mounting or metal electrical frames which are commonly used for telephone and cable installations. These “afterthought” low voltage electrical boxes can be placed in a standard opening in the wall. Care must be taken when using these frames that they must not come in contact with the back of the unit, or provide a shorting path at the cable connections.

When installing near other switches, make sure the boxes are dead level and lined up with existing electrical boxes.

Running Wires in Existing Construction

A neat and careful installation in an existing construction application will increase the customer satisfaction level as well as reduce the chance of service calls in the future. Run cables inside the walls (wherever possible) to the attic, basement, or crawl space. Some installers cut the long straight section from a coat hanger and chuck it into a drill to help establish a reference marker through ceilings and floors up against the edge of a wall. The coat hanger wire is tough enough to drill through most materials without snagging the carpet fibers. The wire is fairly unobtrusive and the length makes it easy to spot on the other side. The small hole left behind is usually hidden by the carpet, or easily repaired. Holes in the stud wall for the wiring can then be made by taking into account the width of the baseboard, drywall, and half the stud (usually $1/2'' + 1/2'' + 1 - 1/2''$ or $2 - 1/2''$ from the pilot hole.)

If you must run wires in a room that is carpeted, you can carefully place the cables under the baseboard or you can lift the edge of the carpet and place the wiring between the carpet's tack strip and the wall. Be careful going past doorways or across a walking path. A cable doesn't seem too big until it's tripped over or causes an unsightly lump in the carpet, so please consider cable diameter where necessary. In some cases when running wire under carpet or a threshold, you may discover that multiple 2 conductor speaker wiring will sit flatter than a single bundled 4 conductor wire.

Marking the Cables

When running each cable, carry a fine tip permanent marker with you and mark both ends of the cable. When you get to the keypad location, mark a couple of arrows on the cable to show you in which direction the speakers are and in which direction the Delta Controller is. This will save you time, eliminating the need to “Ohm-out” the cables later to find the one you're looking for. A few additional seconds spent during the wiring stage will save you hours of cable chasing later.

Existing Electrical Boxes for Keypads

Due to the varying manufactured sizes of electrical plates and boxes carefully mark a level and plumb outline of the switch box using the box itself as a template and make a hole in the existing wall with a drywall or reciprocating saw. Please be careful to ensure that the space you're cutting into does not hide any plumbing, electrical or heating fixtures that could be damaged or cause personal injury. Care must also be taken when dealing with outside walls. The vapor barrier should be repaired if damaged.

Considerations for Outdoor Zones

Outdoor listening zone locations present some unique challenges, both for the wiring and for the control keypad placement.

Outdoor Wiring

Special care should be taken when cables transit outside the structure. External cabling should run through conduit (plastic electrical conduit works well) to protect it from the elements and small animals that may wish to chew on the cable. You may wish to consider a qualified electrical contractor to install electrical conduit for external applications. Cable and installation accessories to complete your installation are not part of the system package but can be obtained at your local electrical supply house, national home improvement centres, and even at most neighborhood hardware stores. These places may also have a selection of cable that's geared just for specific outdoor applications (such as "buried" speaker cables).

Outdoor Keypads

Choosing the location of the keypad control device is perhaps the most important decision. It is not recommended that keypads be installed in environments subject to extreme temperatures, or moisture. Typically keypads are installed inside the home and beside the door adjacent to the outside music zone, but this may not always be possible or practical.

Keypads that must be installed outside are installed at your own risk and should be installed in weatherproof electrical boxes.

Keypads used outdoors should be safely mounted inside a weatherproof electrical box with a door covering the keypad and adequate water barrier seals to protect the unit. Once again, the appropriate weather proof enclosures can be obtained at your local electrical supply house, national home improvement centres, and even at most neighborhood hardware stores. Be sure to check what is available and plan your installation *before* doing the work with an outdoor zone because the materials you have (or do not) have available could easily influence the choices you make to execute the installation.



Keypads installed outside must be inside a weatherproof box with a cover that seals out moisture. Keypads returned to AMX for repair that are found to be corroded will not be covered under the AMX Warranty.

Controller Connections

Source Unit to Controller Connections

Plug RCA audio cables from each source device into the RCA jacks provided on the back of the Delta Controller. Ensure that right and left are connected correctly. The balance will be backward on that source and the audio will not image properly if right and left are reversed. Then connect the IR emitter leads for each audio source into the appropriate connector on the back of the Delta Controller and run the optical end of the emitter lead to the source device's IR receiver window.

- Attach the emitter by peeling and sticking the supplied adhesive patch on the emitter.
- Plug in the IR Emitters to the appropriate source number.
- Strip and attach wiring to keypads on the appropriate zone output.

FIG. 5 shows multiple sources connected to Delta including a DVD Player, CD Player, and an iPod docking station with IR control and RCA outputs.

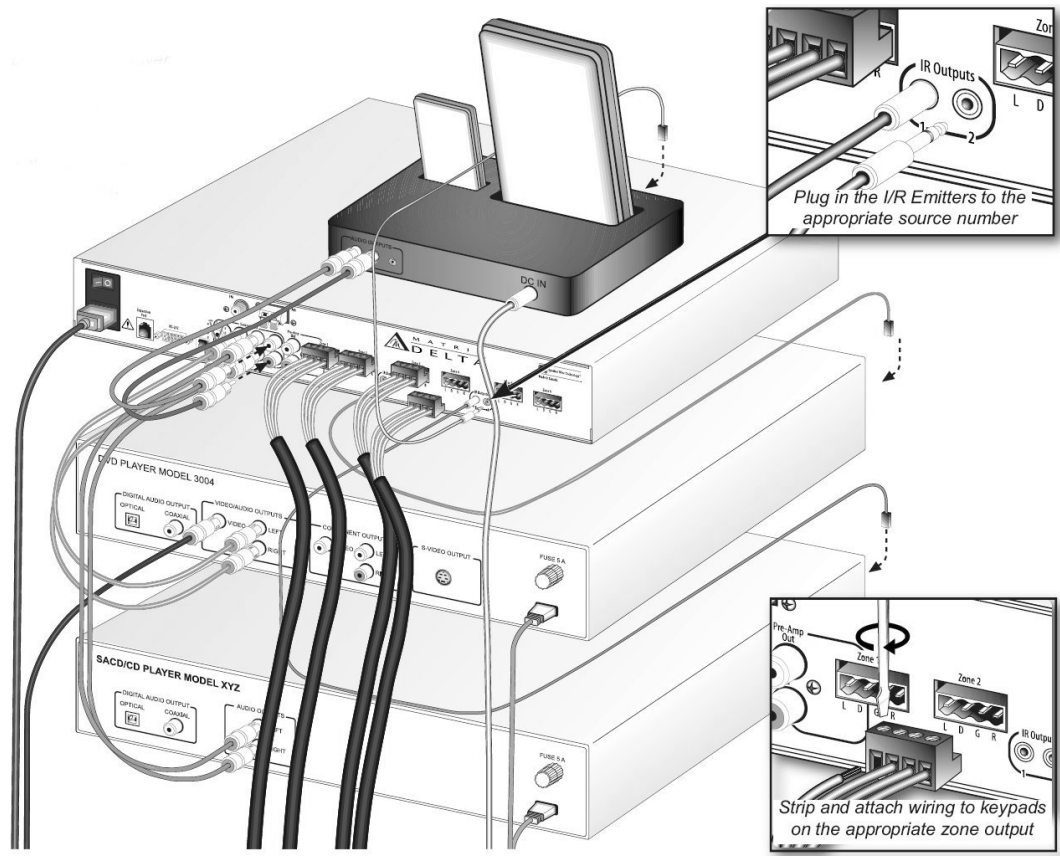

FIG. 5 Source Unit to Controller Connections



NOTE

Source Input #1 is left open because the default is the internal AM/FM tuner.

The Delta Controller learns the IR commands for power on/off during the programming setup. Source components are turned on when they are selected on the keypad. The source remains on until it has been idle in all zones for a duration of 10 minutes, then Delta will automatically turn it off until it is selected again.



NOTE

Make sure that the IR emitter output is plugged into the same numbered IR port as the source component input RCA jacks.

AM/FM Tuner Connections

The internal AM/FM tuner does not require any special programming or setup other than presets.

1. Connect a 75 Ohm adaptor and antenna to the FM coaxial plug.
2. Connect the two leads of an AM loop antenna to the AM spring clips.
3. Position both antennas as high as possible to allow for optimal station reception.



NOTE

Depending on the installation location, it may be necessary to use a powered FM antenna to receive clear FM stations.

When an AM/FM tuner has been installed, input #1 will default to the internal tuner and the RCA input jacks will not be active for source #1. If no internal tuner is installed, the source #1 inputs will be active. Either way, **Source #1** is activated by the top-left button on the keypads.

- **Source #2** is activated by the top-right button on the keypads.
- **Source #3** is activated by the button directly below source #1
- **Source #4** is activated by the button directly below source #2.

See “Using the Matrix Keypads” for more details on how to use the keypads.

4. Connect the 75 Ohm FM antenna by pushing the “F Connector” on to the terminal at the back of the Delta Controller.
5. Connect the AM loop antenna by inserting the stripped wire ends into the spring loaded jacks at the back of the Delta Controller.

Since this a “loop” antenna, the position of the wires in the jacks does not matter (FIG. 6).

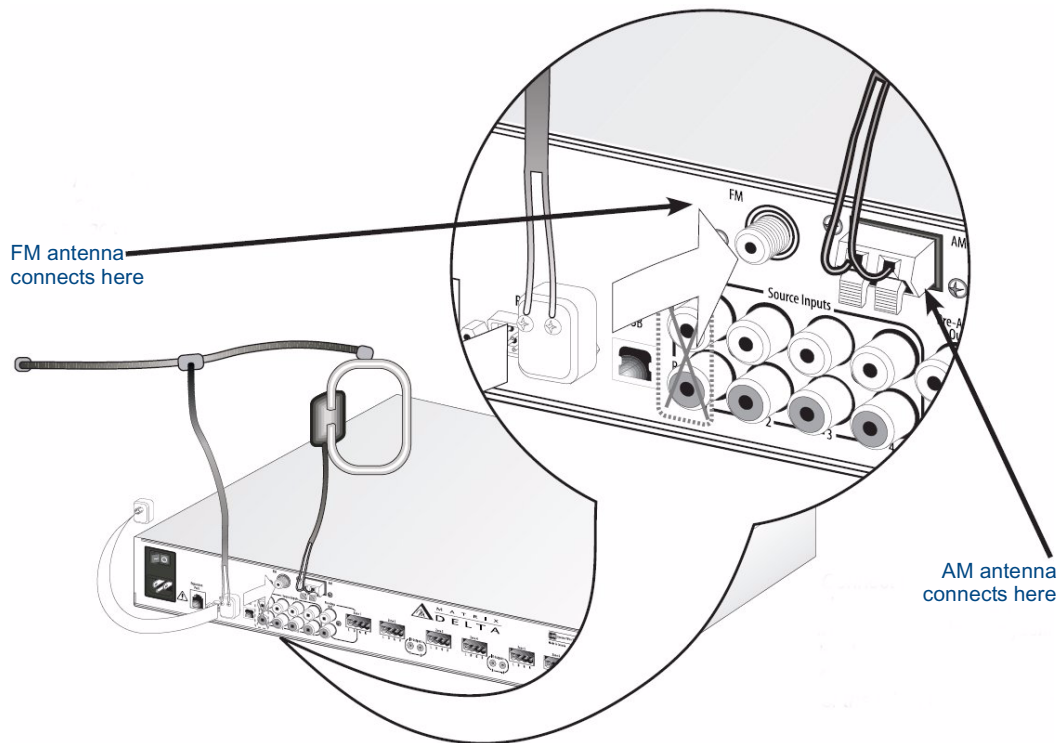

FIG. 6 AM/FM Tuner Connections

Standard 4 Wire Keypad Connections

The standard installation of keypads to the Delta Controller is with 4 wires directly between the Controller's zone output and the keypad's input (right side connector of the keypad), as shown in FIG. 7.

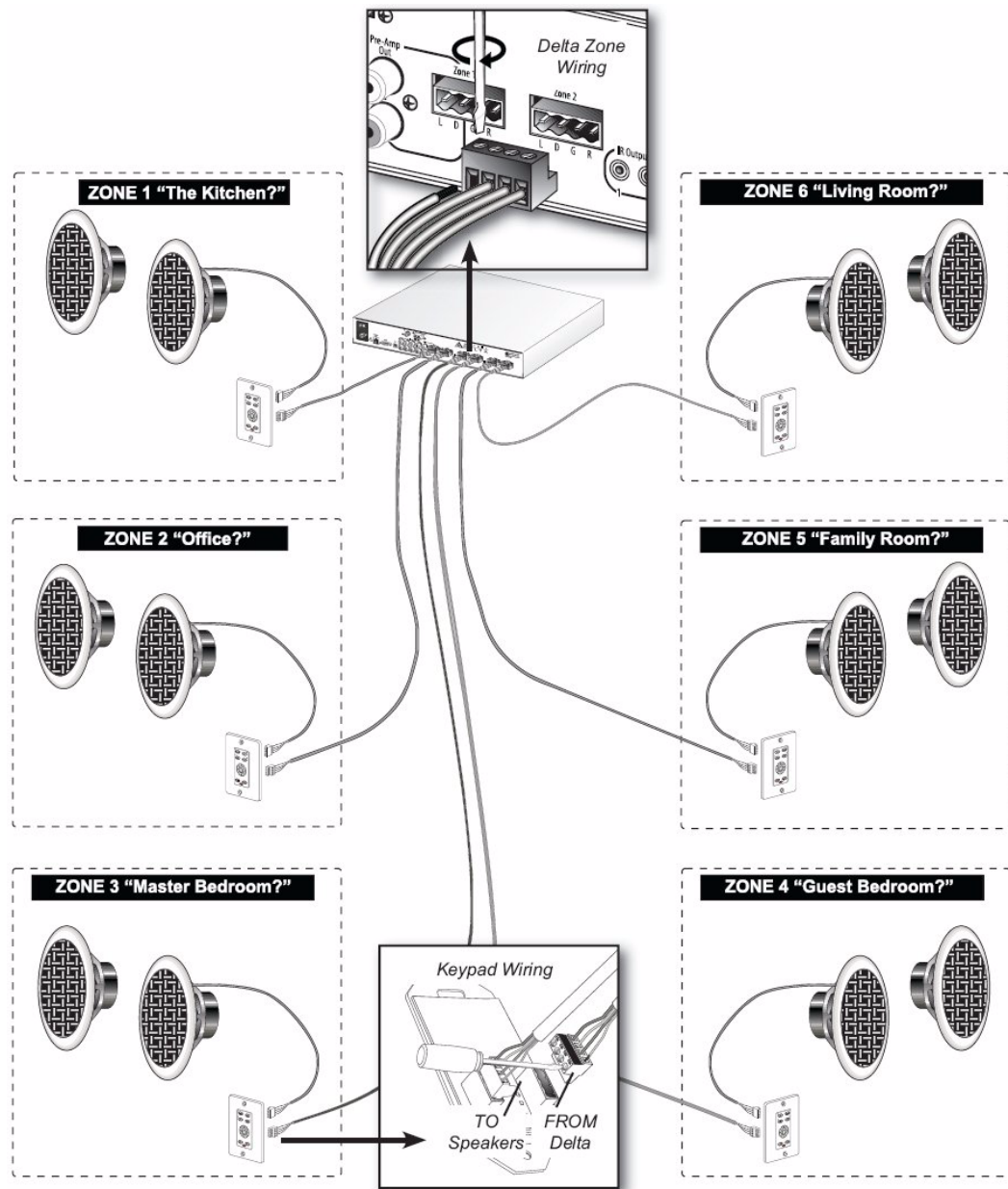

FIG. 7 Standard 4 Wire Keypad Connections

If the building was “pre-wired” for standard audio, this is the configuration they most likely intended. If you wired (or will wire) the keypad locations yourself, this is the most common configuration.

When stripping cable for use with the Molex connector, only strip away about 1/4” (6mm) of the insulation from each wire. The complete assembly should not have any bare wire exposed from the bottom of the connector if possible. This is the safest, most reliable approach.

2 Wire Keypad Connections (Control Only)

In some retrofit configurations it is not feasible or possible to re-route the speaker cable through the keypad. In cases such as this, it is possible to run a separate cable pair (CAT- 3 / CAT- 5 / CAT- 6 / Twisted Pair / Other 2 conductor wiring) cable from the Delta Controller to the keypad device for control purposes. This diagram shows the connections of the control signal path to the keypad and the speaker connections directly to the Delta Controller (FIG. 8).

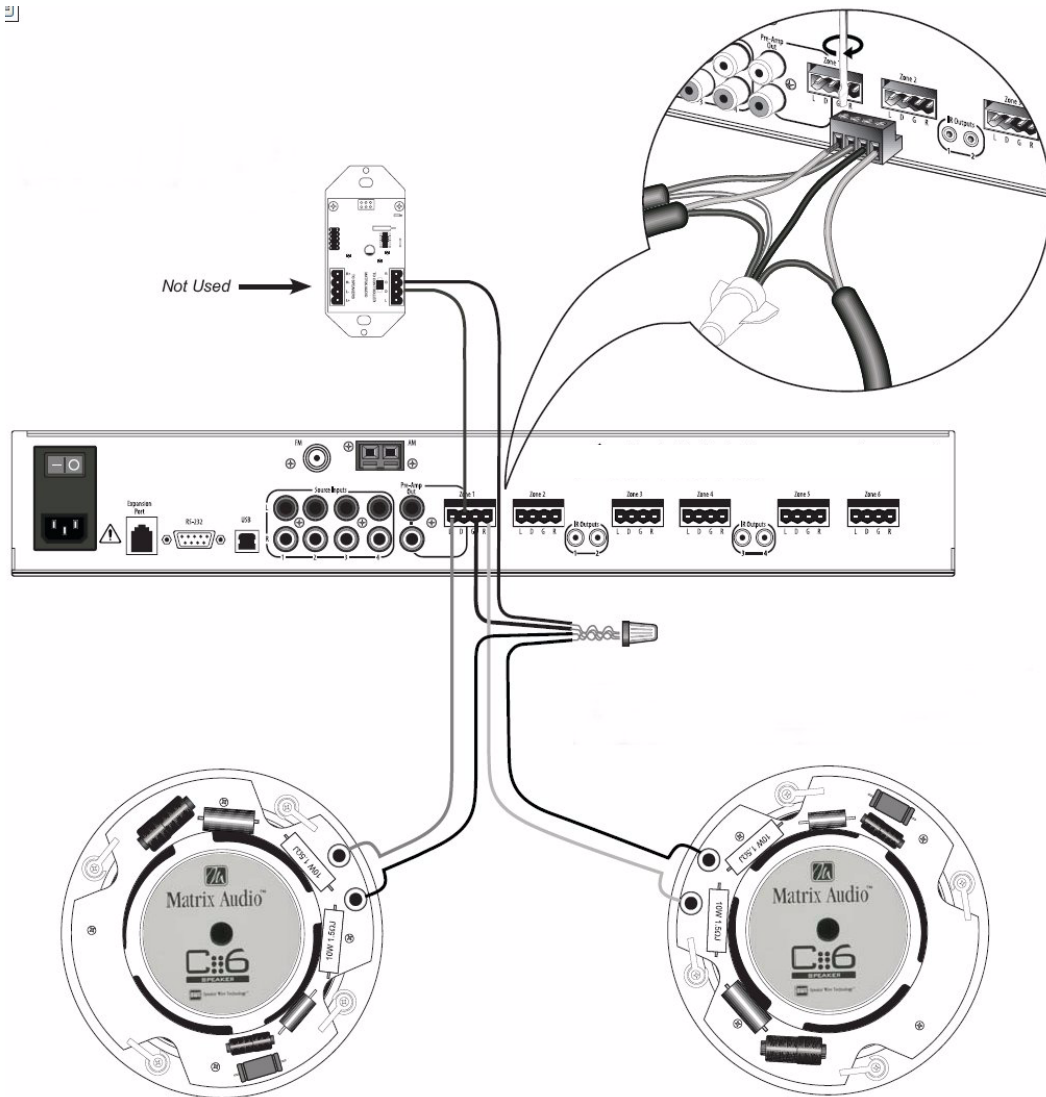

FIG. 8 2 Wire Keypad Connections

Keypad wiring uses just two conductors. These could easily be Cat 3/5/6 or generic 2 conductor wiring. Use only the D (DATA) and G (GROUND) terminals for the output of this connection. Speakers connect directly to the Delta Controller as shown in FIG. 8.

Speaker wiring connects directly to the Delta zone output. Left and Right speaker positives connect to the L and R terminals respectively. Both speaker negatives connect to the G terminal (which will share a connection with the G wiring to the keypad).

Multiple Keypads in a Zone

Certain situations such as large rooms or rooms with more than one common entrance may require more than one keypad control to conveniently manage the zone. This configuration allows for 2 Matrix keypads to be placed on the control circuit. Make sure that the second (AUX) keypad has the wire loop cut so that it's addressed to the Delta Controller as an auxiliary keypad, rather than a "MAIN" keypad (FIG. 9).

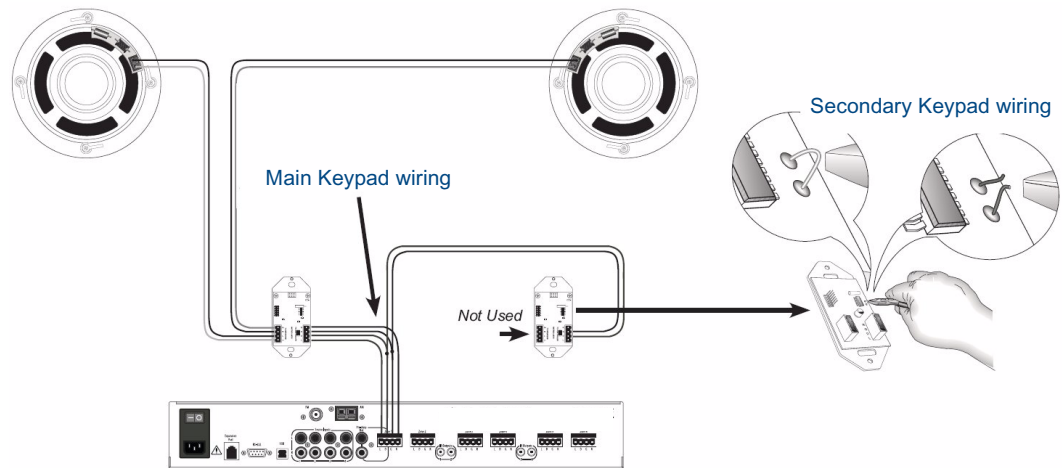

FIG. 9 Multiple Keypads in a Zone

- The main keypad wiring uses all four conductors and connects to speakers as normal. The secondary keypad “taps off” of the D and G terminals of the main keypad input for a secondary control point.
- The secondary keypad must have the loop cut to configure it as the secondary (AUX) keypad.

Matrix Keypad plus Analog Volume Controls

In cases of split zones where more than one set of speakers are driven from the same zone output (such as a master bath off of the master bedroom) it is sometimes desirable to place independent volume controls in the split zones while retaining the Delta Keypad for source control and ON/OFF functions.

FIG. 10 shows the connections to a remote zone and “Autoformer” volume control devices.

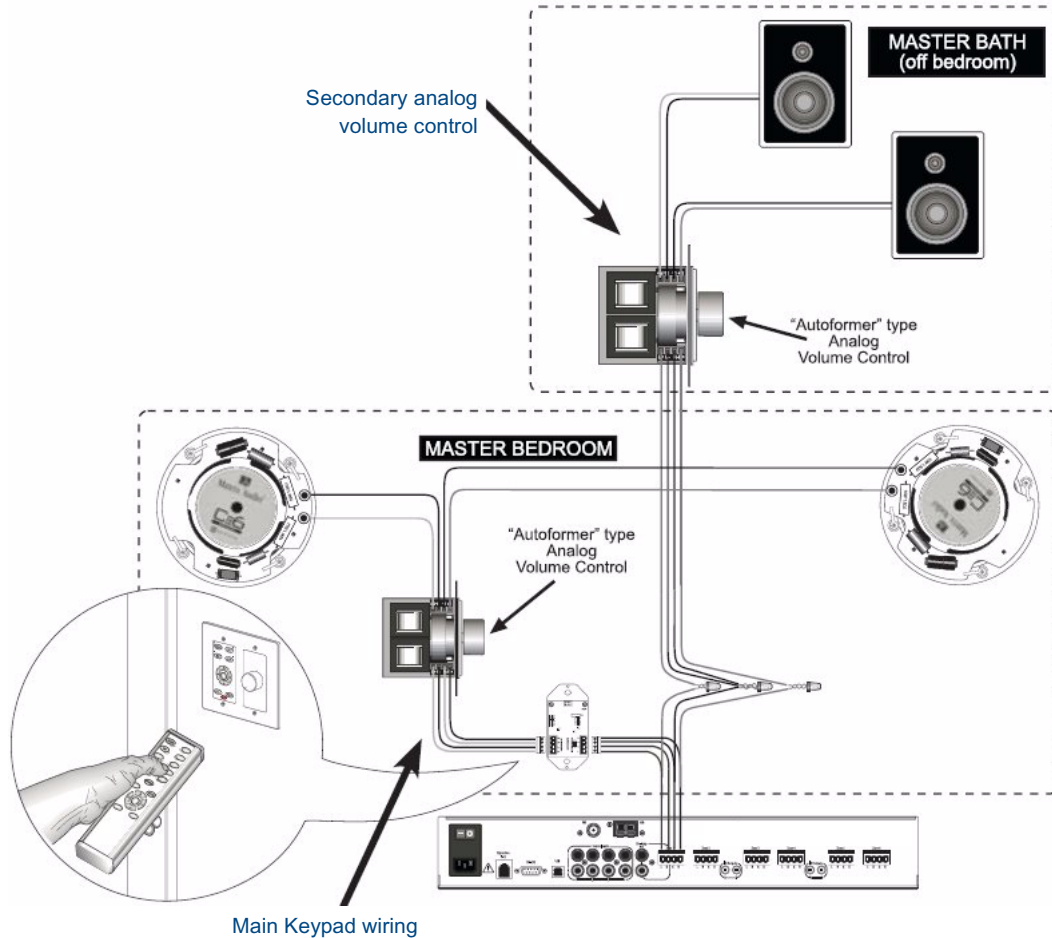

FIG. 10 Matrix Keypad plus Analog Volume Controls



Total impedance on the zone MUST NOT be below 4 Ohms!

- The secondary analog volume control “taps off” of the L+, G and R+ terminals of the DELTA CONTROLLER OUTPUT. The G terminal connects to both L- and R as shown. This allows independent volume in each “sub zone” with the Delta Keypad being the source control and ON/OFF switch.
- The main keypad wiring uses all four conductors and then a secondary analog volume control “taps off” of the L+, L-, R- and R+ terminals of the SPEAKER OUTPUT for the main zone.

Auxiliary Amplifier Configuration (Zone 1)

In some cases you may require more power for a given zone than the Delta Controller can provide.

FIG. 11 shows how to utilize the preamp RCA outputs on the Delta Controller for an external amplifier. This may be useful when outdoor or large rooms make up the zone, or in situations where the number of speakers will require a multi-channel amplifier to safely power them all.

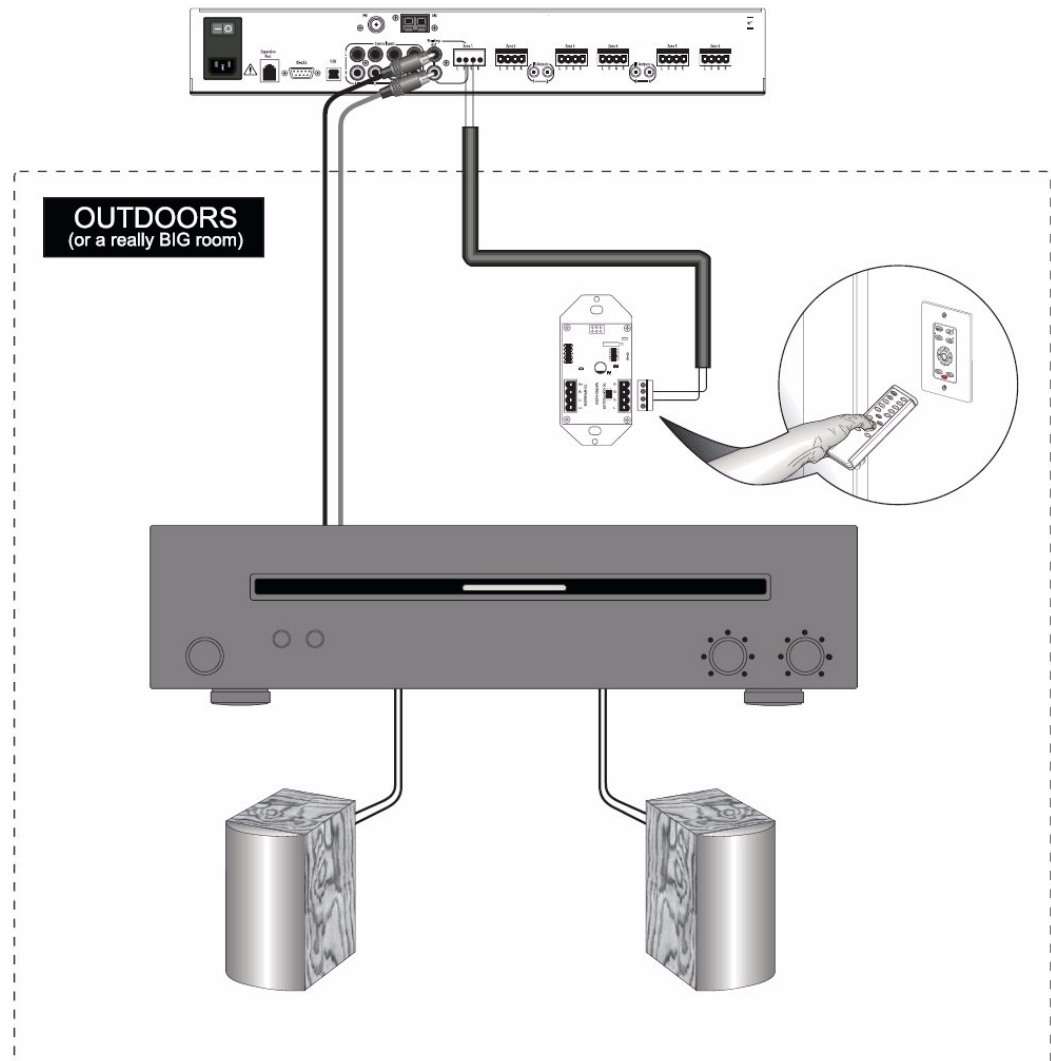

FIG. 11 Auxiliary Amplifier Configuration

This configuration shows an external power amplifier connected to the “LINE OUT” connections on the back of the Delta Controller. These connections are only available on Zone 1. The corresponding Zone 1 keypad would connect to the Delta Controller with only the D and G connections. The power amplifier will handle the individual speaker connections which means the amplifier and the speakers can be placed at distances from the Delta Controller not usually practical. It also allows an easy solution when you simply need more power in the zone than the Delta Controller provides

Auxiliary Amplifier Configuration (Zones 2-6)

In cases where you require more power for a given zone than the Delta Controller can provide and it is other than in Zone 1, use this diagram. It shows use of a Matrix LLC device designed to reduce the “speaker level” output of the Delta Controller to “line level” so that it can drive an auxiliary amplifier. This amplifier would typically be installed at the equipment rack (source end).

Remote Amplifier Configuration

In some cases, especially where the distance between the Delta Controller and the zone is unusually long, such as another building on the property i.e. cottage-to-boathouse for example, it is sometimes desirable to have a remote amplifier at the zone end. This diagram could also represent the Matrix LLC device implemented so that there is a preamp level output available for a remotely mounted amplifier elsewhere on the property. The main difference is the run of 4 conductor wire between Delta and the Matrix LLC device (FIG. 12).

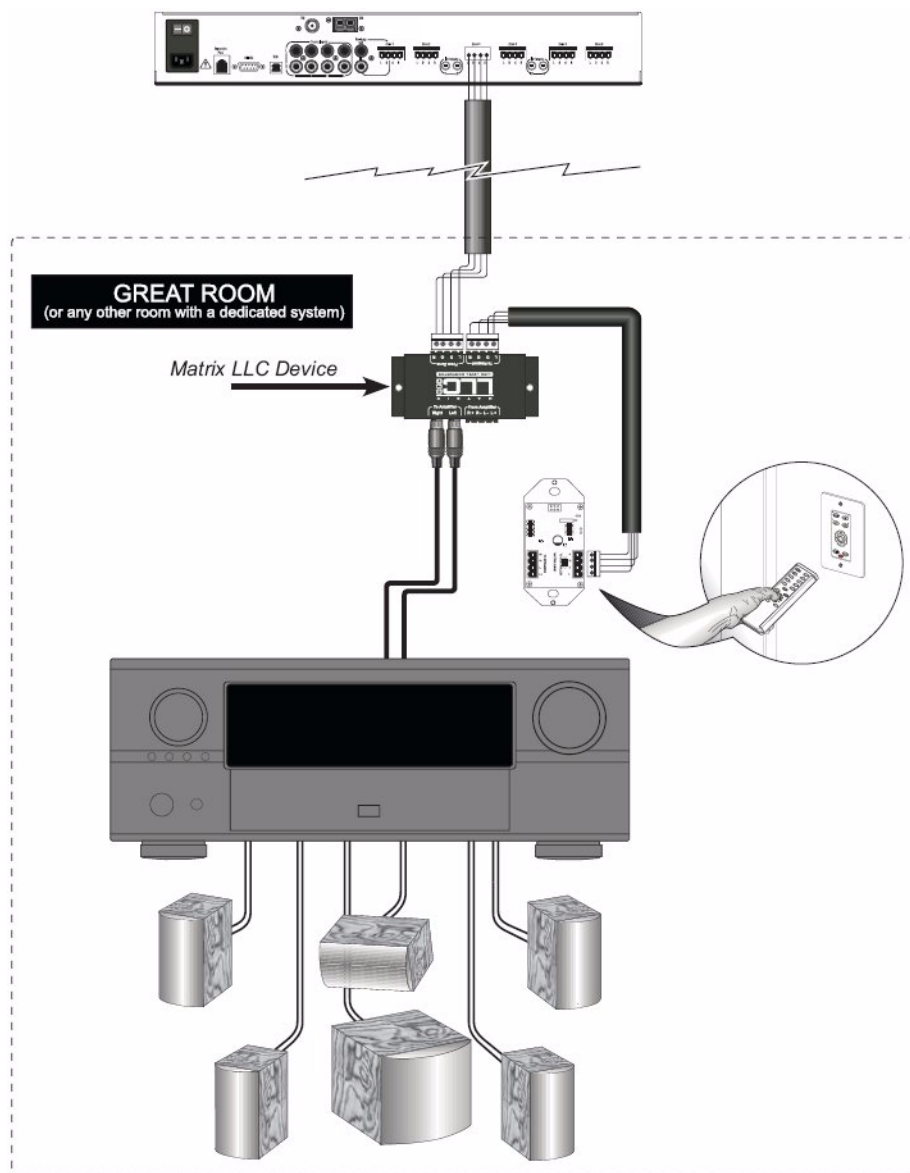

FIG. 12 Remote Amplifier Configuration

Connecting the RS-232 Serial Port

Delta Audio Controllers provide an RS-232 (DB9) port for receiving RS-232 Controller Commands. Refer to the *RS-232 Controller Command Messages* section on page 55 for a complete listing of supported commands.

- Connector: DB9 Male
- Communications: 4800 Baud, 8 data bits, 1 stop bit, no parity

The Matrix Distributed Audio, multi-room audio control systems can be externally controlled by sending ASCII text command strings to the Bi-Directional RS-232 serial interface. Every command must be terminated with a line feed (0x0A). All messages are case-sensitive.

The MRC will respond to command messages with a status response message once the command has been executed.

RS-232 Cable

When connecting to the RS-232 port located on the back of the Delta Controller, it is necessary to use a DB9 cable. Delta Controllers utilize DCE protocol therefore no NULL modem adapter is necessary. You may also use a USB to DB9 adapter.

Connecting Matrix Keypads

Tools Required for Installation

Tools you'll need to complete this part of the installation are wire strippers, small standard slotted screwdriver and a permanent marker. An optional tool is an ohmmeter to determine which side of the wire you are working with if they were not marked. If the wires are not secured to an electrical box use masking tape to help secure the cable while you are working on it. There is nothing more frustrating than having the cable fall back behind the wall. It's also recommended to have a Speaker Impedance Meter (not just a DMM) so that you can accurately read speaker impedance.

Orientation of Connectors

Looking at the rear of the keypad with the connectors at the bottom, you will see (2) plug type 4 pin receptacles. Generally the mating connector parts shipped in a separate hardware bag that is packaged with the Delta Controller.

The connector on the right side terminates the 4 conductor wire from the Delta Controller and the connector on the left side passes the audio to the speakers in the zone. The Matrix keypad is distinctively marked on the back, and the connector on the right side is labeled vertically indicating the line from the Delta Controller and the connector on the left side is labeled vertically indicating the line leading to the speakers, so this should make installation less of a guessing game.

Be sure to match the color and position of the wiring at the keypad with the wiring at the Controller (FIG. 13).

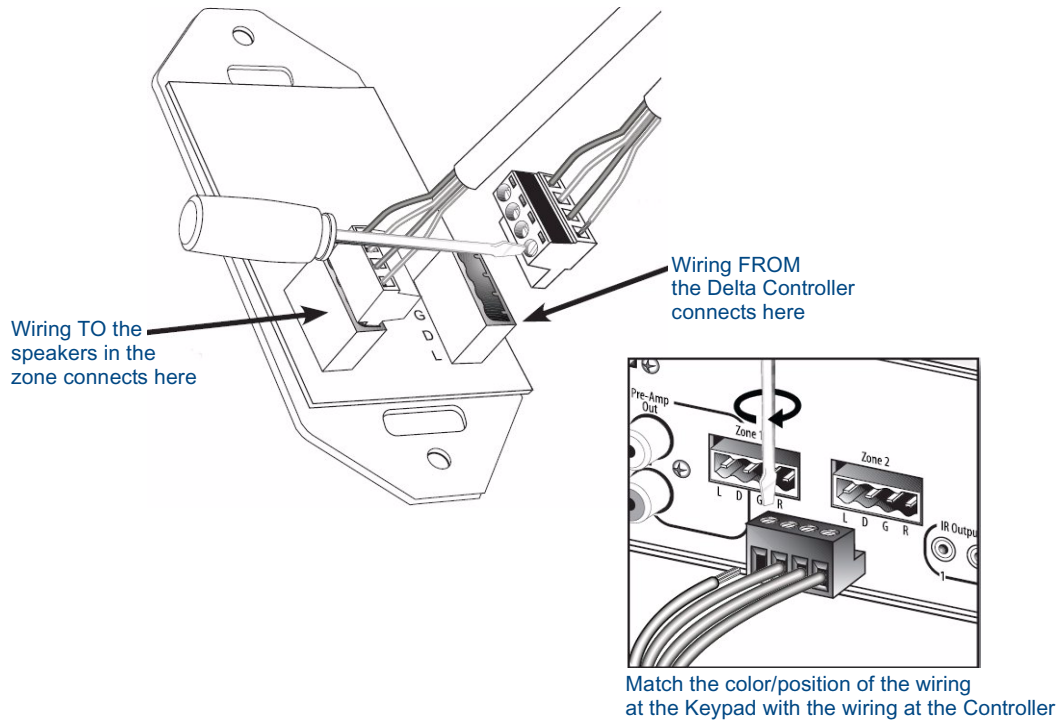

FIG. 13 Orientation of Connectors

Preparing the Wires

When working with the SWT connector, only strip away about 1/4" inch (about 6mm) of the insulation from each wire. Most common electrical problems occur when the wire is stripped too long, and they short out against neighboring wires behind the wall.

- The complete assembly should not have any bare wire visibly exposed from the bottom of the connector. A quick twist of the copper strands will ensure easy installation into the connector. Tighten the fastening screw securely.
- Ensure that wire strands do not touch neighboring wires on the connectors, as this could result in malfunction or impede system performance.

Wire Color Schemes

It's not particularly important to denote any one color as any one particular conductor. What is, however, of critical importance is consistency in your wiring scheme with respect to which color goes into which position.

For example, if you always start left to right and use Red on Pin #1, Black on Pin #2, Green on Pin #3 and White on Pin #4, then it will always be wired correctly between the Delta Controller and the keypad input. This configuration also places Green as the ground wire - which is consistent with most home wiring standards. Although the actual colors in the example are not absolute, it's important that those colors follow the same left to right position in each connector location at both the right side of the keypad and the Delta Controller. The most common installation errors are caused from not following a consistent wire color and pin location format.

Speakers are wired according to their positive and negative terminals, which are usually Red and Black for each speaker, and those will be connected into the connector on the left side of the keypad. See the *Connecting Matrix In-Ceiling Speakers* section on page 22 for details.

Installation into the Wall Cavity

1. After wiring is complete, simply push the wiring back into the wall cavity and make sure there is enough room for the Matrix keypad to comfortably fit into the opening.



Do not force the keypad up against wiring or other obstructions if it cannot fit flush to the mounting holes because damage can occur to the circuit board of the keypad.

2. Once the keypad had been set into the wall opening, line up the mounting holes with the receiving threaded holes in the wall plate (or electrical box).
3. Begin threading the top and bottom screws by hand and finish with a screwdriver.
4. Once the installation is complete, snap on the cosmetic trim panel and install any additional remaining keypads.
5. Once the keypad wiring is connected and correctly plugged in, install the keypad into the wall cavity with the supplied screws. Make sure there is no binding of the wiring and that the keypad fits without forcing it into the opening.
6. After the keypad is secure, proceed with the installation of the decorative trim panel (FIG. 14).

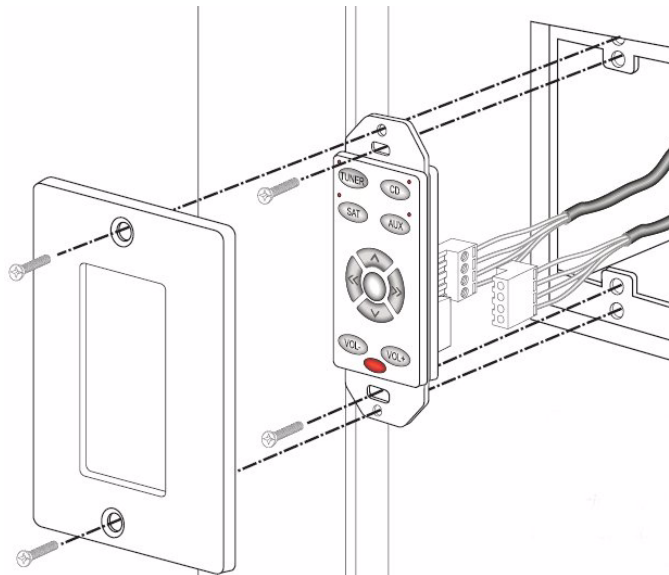

FIG. 14 Installation into the Wall Cavity

Connecting Matrix In-Ceiling Speakers

Overview - Speaker Wire Technology (SWT)

Speaker Wire Technology (SWT) allows both data and audio signals to travel over the same four conductor wire. This is the same four conductors that you would run (or is run) in your home wiring installation for a standard speaker and volume control installation. This remarkable technology removes the need for control wire since the control and audio signals are shared on the same wire. The reliability and simplicity of this system has been proven for years in both existing homes as well as brand new multi-room installations.

SWT simply replaces standard “rotary” or “slide” volume controls with Matrix Audio keypads and a Controller like Delta, giving full control over the sources. Additionally, the versatility of SWT also allows Matrix Audio products to be connected where the control wire has been run separately from the speaker cable, so installations are easier than ever before.

Overview - Matrix Speakers

Matrix in-ceiling speakers provide exceptional acoustical performance using superior components and crossover design. Matrix speaker enclosures incorporate a floating bridge, which houses a unique pivoting tweeter assembly that creates directionality for the user.

The Delta system can be used with the Matrix Audio Active Speaker system. This speaker system is an active design that connects directly to the Matrix Controller and has an IR receiver so there is no need for a keypad in the zone. The remote control can handle all of the zone functions simply by pointing at the speaker.

FIG. 15 shows the three main types of Matrix speakers (C Series, C-DT Series and EL Series):



FIG. 15 Matrix In-Ceiling Speakers

Wiring Method A

In the configuration illustrated in FIG. 16, all four wires are run to the active speaker (shown Left) and then the second speaker (shown Right) connects to the first with 2 wires (+ and -).

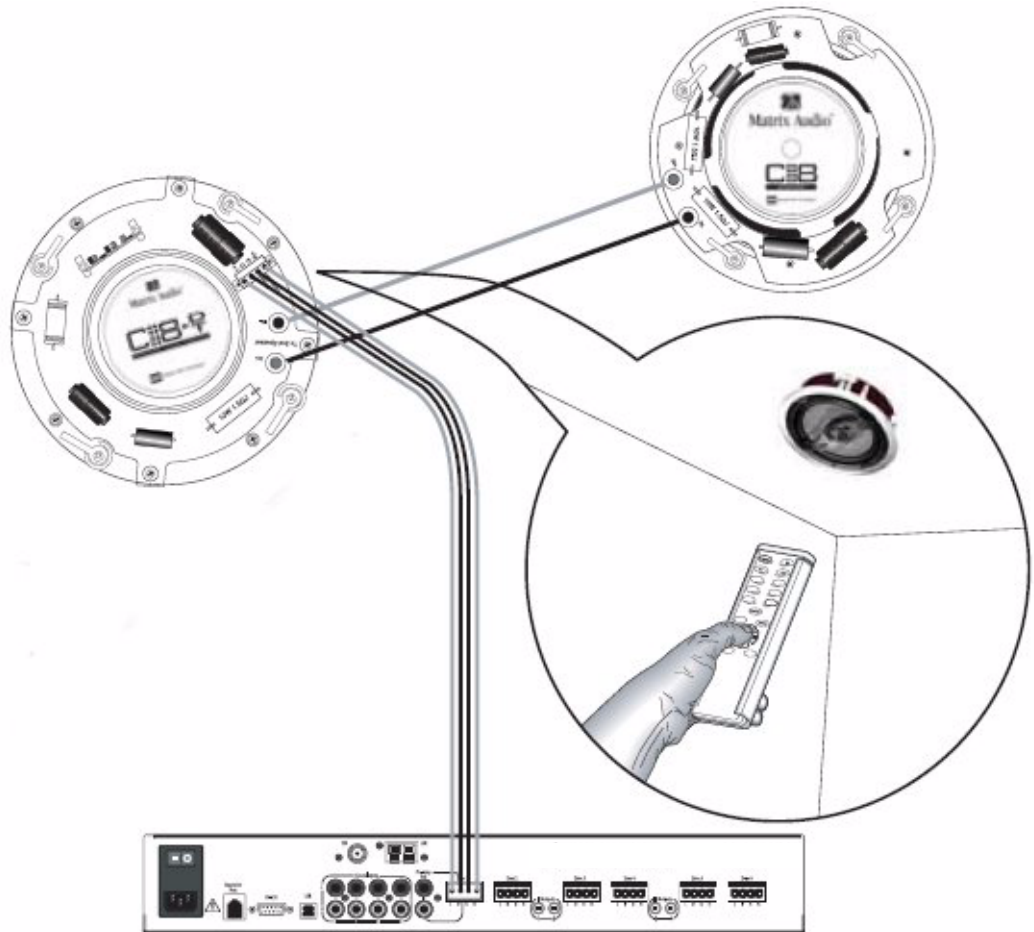

FIG. 16 Wiring Matrix Active Speakers - Method A

Method B (Retrofit)

In the configuration illustrated in FIG. 17 (typical in retrofit applications where wiring is in place), each speaker has a 2 wire feed and a “4 wire bridge” connection must be installed between the two so that the active (4 terminal) speaker can receive a full 4 wire input (using 2 of the 4 wires) and then bring audio back to the second speaker through the remaining 2 wires.

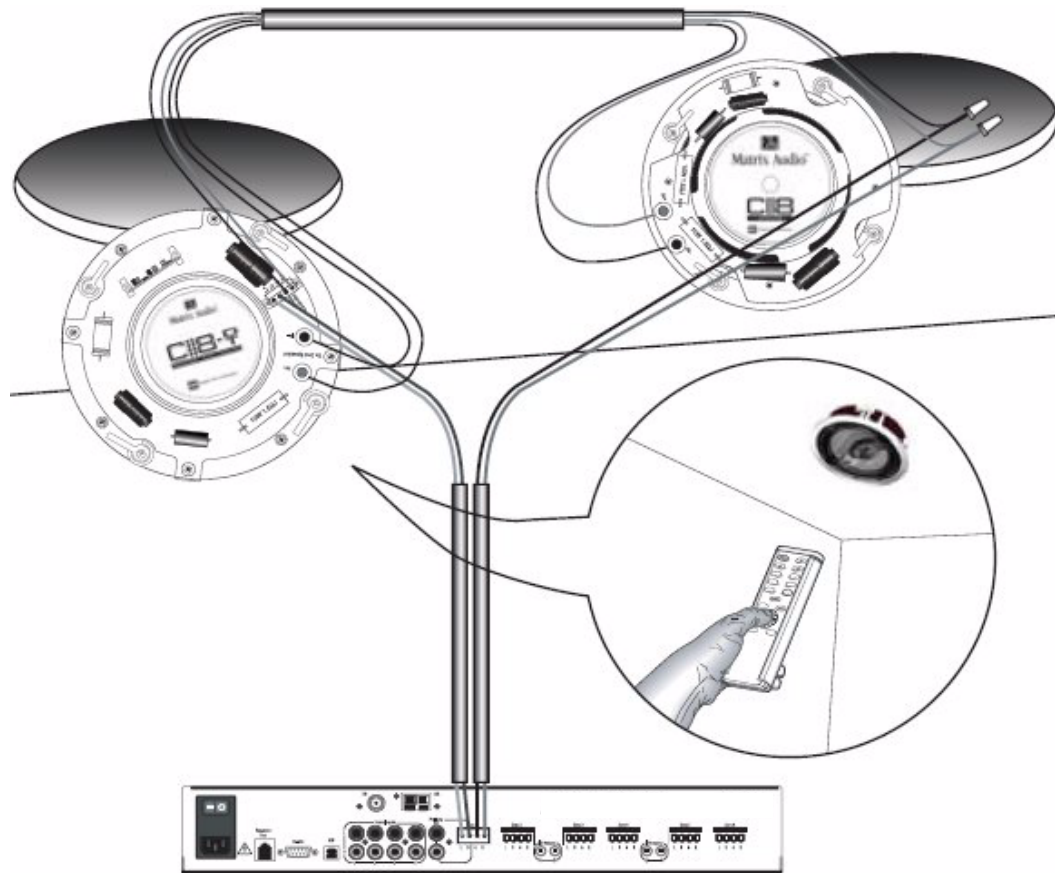

FIG. 17 Wiring Matrix Active Speakers - Method B

Programming the Delta System

Overview

Programming and IR Capture take place on the front panel of the Delta Controller. Settings such as Bass, Treble, and Balance functions are programmed from within any zone using the keypad. We suggest you read this section carefully in its entirety BEFORE starting to program the Delta Controller. This will allow you to obtain a general understanding of what you will see and what to expect when you go through the programming exercise.

Careful planning, documentation and experimentation on your part with the sources prior to taking the programming on will allow you to experience an easy and painless installation.



NOTE

Programming is EASY and only seems complicated if you are trying to solve all operating issues at the same time! Please take the time to read this section carefully.

Preparation for Programming

Make certain you have all the documentation and accessories for each source component (the operator's manuals, the remote controls with working batteries). You may need to reference their manuals to learn the operation of the equipment and you will certainly need to use the remotes to "teach" Delta what commands it must emulate. Since new equipment is rarely shipped with the batteries installed, make sure the batteries are installed or, in the case of an existing source component, make sure the batteries in the remote are functional.

The key to successful programming is to understand how each of the source components operates. By determining how you would like the components to function as part of the home audio system you will be able to spend less time on the programming phase of the installation. You should take some time to familiarize yourself with the basic operation of the source component's remote control to better understand the operating characteristics of the device and which functions you wish to program into the Delta Controller. If you can operate and manage the audio device as a stand alone unit, it will aid you in determining which functions you want to program into the Delta Controller.

Programming Worksheets

Before getting started, please outline how the system is intended to operate using Matrix Audio's "Programming Worksheets". This outline will assist you in setting up the remote training session as well as the other Delta functions. You will find this worksheet will not only help you plan in advance how the keypad buttons will perform each function, but they will also assist in the event that IR codes, Presets, or other settings need to be re-learned or changed down the road. This will reduce the time needed to program/reprogram the Controller and keypads. It will also be your guide should any of the audio devices need to be changed out or upgraded in the future. You will know what the original device's configuration looked like so the keypads can be labeled in the same configuration.

Consistency in the keypad programming and clear documentation will reduce frustration and shorten the operational learning curve for your client. Remember that even though an experienced user will find Delta operation easy, the first time user will do best when a "pattern of operation" is established through consistent, thoughtful programming. A copy of the programming worksheet is available on the following page (FIG. 18).

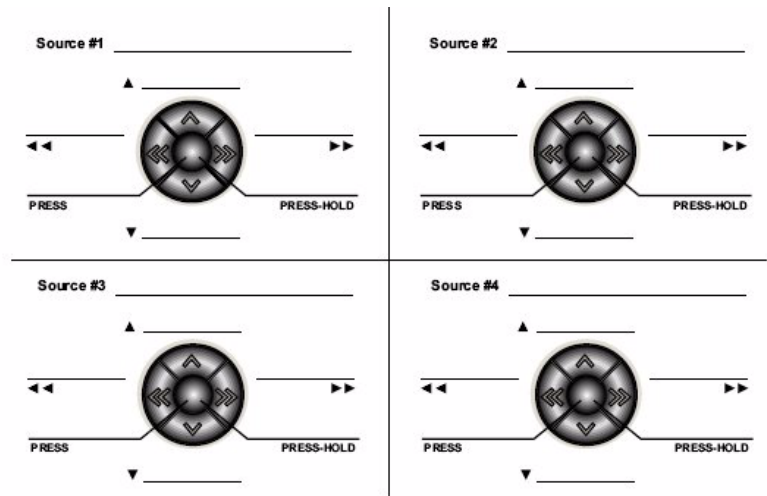

Source #	Name	Source Type	Input Attenuation or Gain (-12, -9, -6, -3, 0, +3, +6, +9, +12, +15, +18)
1			
2			
3			
4			

Source #	Preset 1	Preset 2	Preset 3	Preset 4	Preset 5
1					
2					
3					
4					

Source #	Preset 6	Preset 7	Preset 8	Preset 9	Preset 10
1					
2					
3					
4					

Zone #	Name	Bass +/-	Treble +/-	Balance Left / Right	Other
1					
2					
3					
4					
5					
6					

FIG. 18 Programming Worksheet

Accommodating Multiple Device Programming

Programming is an interactive exercise between you, the Delta Controller and the audio source remote control, which may vary from unit to unit. You will learn the techniques to best train the Delta Controller through some trial and error and observation. The audio source remote should be located about 6-12 inches away from the IR receiver on the Delta Controller. The path between the devices should be unobstructed with a clear line of sight. Fluorescent light fixtures and bright sunlight may interfere with the learning process, so you may choose to shade the IR receiver with a sheet of paper or other practical means. When possible use only incandescent lighting during the programming session. During programming, distance between the remote and the Delta Controller is also important. If the remote is too close to the unit the IR signal will overload the learner. If it's too far away, it might not learn due to weak signals strength. A bit of trial and error will quickly get you to the correct distance.

Your programming technique may need to be modified on a remote-by-remote basis. Some remotes may need to be closer to or further away from the Delta Controller. Some may program better with quick key presses and some with long key presses. Some may require a change in distance and angle between the remote and the Delta Controller. If a particular method doesn't seem to be working for you, try to modify your approach to understand the characteristic behavior of the source component remote so that it can "speak" to the Delta Controller correctly.

Program Panel

The programming controls (also called the "navigational array") and the IR receiver are located on the front of the Delta Controller. The four directional buttons allow you to navigate through the menu screens. The center button is used to make selections (as if to press OK or ENTER).

Enter the Program Mode

Press the center button on the front panel to enter the Main Menu. This will display four options, **Setup**, **Preferences**, **About** and **Exit** (FIG. 19).

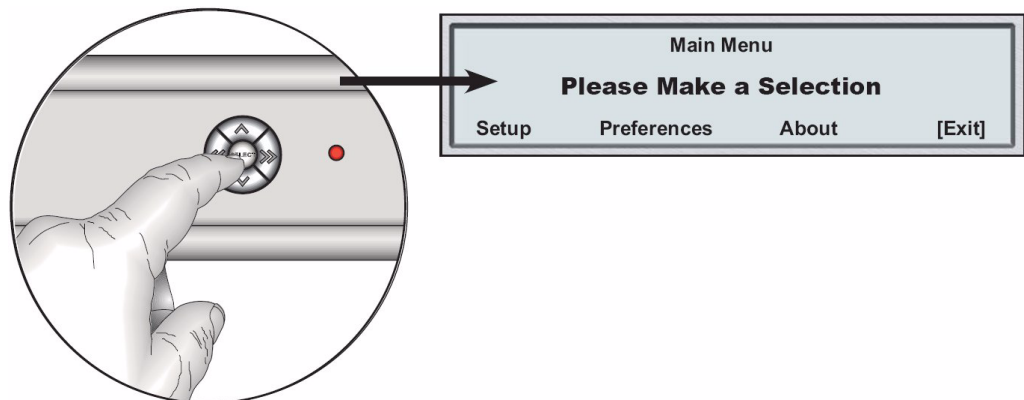

FIG. 19 Enter the Program Mode

The menu selection immediately defaults to the Exit selection in the first screen. Navigational buttons (Left/Right/Up/Down) allow user to navigate through menu item.

- **Nav UP & Nav <<** both move the cursor UP or "back". Nav.
- **DOWN & Nav >>** both move the cursor DOWN or "forward"
- The **center button** allows user to select menu items.
- **"Exit"** takes user back to previous screen. In the first program menu screen, this would then take you back to "default" screen (with the "M").

Program Menu Selections

- **Setup** is where the user will program *Sources*, access *Tuner* and *Clock* information.
- **Preferences** allow user to set up preferences for *Backlight* and *Display Options*.
- **About** displays the *Version #* for the Controller firmware.

Each of these program menu selections is detailed in the subsequent pages of this section.

In screens with multiple lines of selections, an arrow is used to indicate which line of information is currently active (FIG. 20).



FIG. 20 Arrow Indicates Which Line of Information Is Currently Active

- **Nav UP/DOWN** moves the arrow focus between the active and inactive lines of information.
- Once the programming selections the user wants are “active”, **Nav LEFT/RIGHT** will move from option to option.
- **Nav CENTER** is used to make a selection as if to be an **ENTER** or **OK** command.

Setup Program Menu

The menu selection immediately defaults to the *Exit* selection in the first screen of the Program Menu. The other menu choices are **Controller**, **Tuner** and **Clock**.

Selecting **Controller**(FIG. 21) will lead the user through:

- Program Sources.
- View the Room Info for each zone.
- Adjust the Source Leveling for each source.



FIG. 21 Setup Menu - Controller

Selecting “**Tuner**” (FIG. 22) will lead the user through setting the presets.

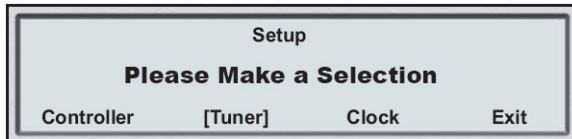

FIG. 22 Setup Menu - Tuner



NOTE

“*Tuner*” will only be displayed if a Tuner is detected on board the Delta Controller. If a tuner board is not installed, there will be no “*Tuner*” selection displayed.

Selecting **Clock** (FIG. 23) will allow the user to set the *Clock Time/Date/Day* for the System.



FIG. 23 Setup Menu - Clock

Selecting **Exit** exits to the Main Menu (FIG. 24).



FIG. 24 Setup Menu - Exit

Controller Sub Menu

Programming Source Components

1. From the Setup screen, select **Controller**. The *Controller Setup* screen will be displayed.
The menu selection immediately defaults to the Exit selection in the first screen of the Controller Set Up Menu.
2. Using the navigation button, select **Program** and the *Program Sources* screen will be displayed.
3. Select a **Source** to program.



NOTE

If an on-board tuner is present, Source #1 will not be displayed since the Tuner takes up the Source #1 location

4. Once a source has been selected, the *Select Source Type* screen will be displayed. The menu selection immediately defaults to the **Learn IR** selection in the first screen of the *Select Source Type* screen (FIG. 25). The source number is displayed at the top of the screen.

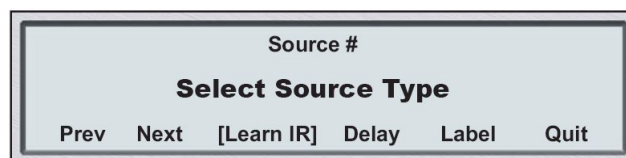

FIG. 25 Select Source Type - Learn IR

- **Learn IR** will allow user to learn IR commands for the selected source
- **Delay** allows user to add a delay to all IR commands learned for the selected source type
- **Label** allows customization of the label for each Source Type
- **Quit** returns user to *Please Select a Source* screen.



NOTE

*If the Source Type has not been previously selected, **Select Source Type** will be displayed, otherwise it will display the named source(s) from prior programming sessions.*

5. Press **Next /Prev** to scroll through the following available source names and profiles:

- Select Source Type (default)
- Tuner
- CD
- DVD
- Satellite
- Aud Server
- Other
- Delphi XM



NOTE

See the keypad functions of each “Profile” in the Keypad Functions By Profile table on page 33. This will help you understand what it will be like to operate the source component through Delta.

The sample sequence illustrated in FIG. 26 shows how assigning a source “profile” works. The example is for Source #2 (which could be a CD or DVD player). When the “Select Source Type” screen appears, you need to choose a profile that allows Delta to emulate IR commands which correctly control the source component. The profile of the device tells you which navigator keypad and (where applicable numeric keypad) buttons operate the various functions of the source component.

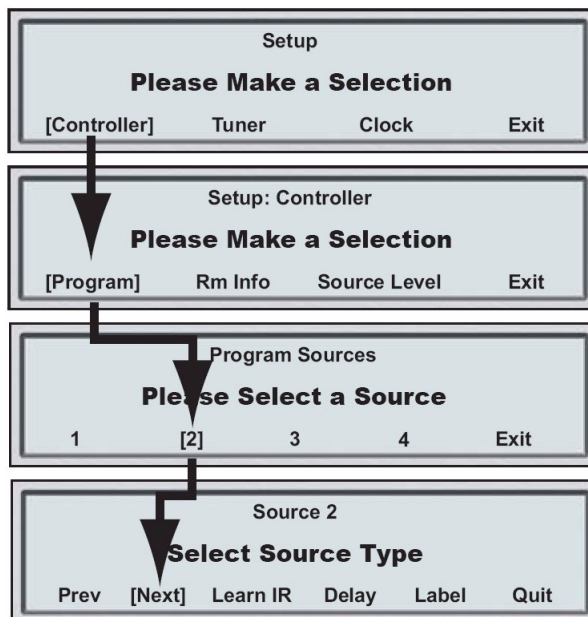

FIG. 26 Assigning a Source - Sample Sequence

Keypad Functions By Profile

Keypad Functions By Profile			
Source Type	IR Commands Learn...	Nav. Button Functions and Result	
Tuner <i>Please note that this selection is intended for an external AM/FM tuner.</i> <i>If you have an internal Matrix tuner module, Delta will have already assigned it to Source #1</i>	POWER ON POWER OFF SEEK + (kp UP) SEEK - (kp DOWN) BAND (kp DOWN) MO/ST (kp CENTER hold) Direct Access: DIRECT entry start seq. DIRECT entry end seq. 0-9	Nav. UP = Nav. DOWN = Nav. LEFT = Nav. RIGHT = Nav. CENTER = Press/hold CENTER =	Next Channel Previous Channel Guide Down Guide Up Select Guide
CD	POWER ON POWER OFF PLAY PAUSE TRACK + (kp UP) TRACK - (kp DOWN) DISC - (kp LEFT) DISC + (kp RIGHT) UDEF1 (kp CENTER) UDEF2 (kp CENTER hold) Direct Access: Direct DISC start seq. Direct DISC end seq. Direct TRACK start seq. Direct TRACK end seq. 0-9, (10+)	Nav. UP = Nav. DOWN = Nav. LEFT = Nav. RIGHT = Nav. CENTER = Press/hold CENTER =	Next Track Previous Track Previous DISC Next DISC User Defined 1 User Defined 2
DVD	POWER ON POWER OFF PLAY PAUSE UP (kp UP) DOWN (kp DOWN) LEFT - (kp LEFT) RIGHT + (kp RIGHT) SELECT (kp CENTER) MENU (kp CENTER hold) Direct Access: Direct DISC start seq. Direct DISC end seq. Direct TRACK start seq. Direct TRACK end seq. 0-9	Nav. UP = Nav. DOWN = Nav. LEFT = Nav. RIGHT = Nav. CENTER = Press/hold CENTER =	UP DOWN LEFT RIGHT SELECT MENU
SATELLITE	POWER ON POWER OFF CH+ (kp UP) CH- (kp DOWN) GUIDE - (kp LEFT) GUIDE + (kp RIGHT) SELECT (kp CENTER) GUIDE (kp CENTER hold) Direct Access: DIRECT entry start seq. DIRECT entry end seq. 0-9	Nav. UP = Nav. DOWN = Nav. LEFT = Nav. RIGHT = Nav. CENTER = Press/hold CENTER =	Next Channel Previous Channel Guide Down Guide Up Select Guide

Keypad Functions By Profile (Cont.)			
Source Type	IR Commands Learn...	Nav. Button Functions and Result	
AUDIO SERVER	POWER ON POWER OFF PLAY PAUSE NEXT (kp UP) PREV (kp DOWN) PAGE - (kp LEFT) PAGE + (kp RIGHT) SELECT (kp CENTER) UDEF1 (kp CENTER hold) Direct Access: Direct PAGE start seq. Direct PAGE end seq. Direct TRACK start seq. Direct TRACK end seq. 0-9	Nav. UP = Nav. DOWN = Nav. LEFT = Nav. RIGHT = Nav. CENTER = Press/hold CENTER =	Next Previous Previous Page Next Page Select User Defined 1
OTHER	POWER ON POWER OFF PLAY PAUSE UP (kp UP) DOWN (kp DOWN) LEFT - (kp LEFT) RIGHT + (kp RIGHT) CENTER (kp CENTER) HOLD C (kp CENTER hold) Direct Access: Direct DISC start seq. Direct DISC end seq. Direct TRACK start seq. Direct TRACK end seq. 0-9	Nav. UP = Nav. DOWN = Nav. LEFT = Nav. RIGHT = Nav. CENTER = Press/hold CENTER =	User Defined UP User Defined DOWN User Defined LEFT User Defined RIGHT User Defined CENTER User Defined HOLD CENTER
DELPHI XM	POWER ON POWER OFF CH+ (kp UP) CH- (kp DOWN) CAT - (kp LEFT) CAT + (kp RIGHT) XM (kp CENTER) HOLD C (kp CENTER hold) Direct Access: 0-9	Nav. UP = Nav. DOWN = Nav. LEFT = Nav. RIGHT = Nav. CENTER = Press/hold CENTER =	User Defined UP User Defined DOWN User Defined LEFT User Defined RIGHT User Defined CENTER User Defined HOLD CENTER
MATRIX ON-BOARD TUNER	<i>The Tuner is already pre-programmed</i>	Nav. UP = Nav. DOWN = Nav. LEFT = Nav. RIGHT = Nav. CENTER = Press/hold CENTER =	SEEK UP SEEK DOWN Previous PRESET Next PRESET AM/FM (toggle) Stereo/Mono (toggle)

Learning IR Commands



NOTE

Before programming any remote commands into Delta, make sure you understand the button labels that Delta assigns a source component's IR commands based on the "source type" as shown on the previous pages.

When the "Learn IR" screen asks for a command, use the exact command from the remote. Use the exact sequence that you normally would to turn on the source component. As Delta learns this command, it will be exactly what it then emulates to the IR emitter that will command the source component through Delta. Take your time!!!

After selecting the profile of the source type, it's time to teach the Delta Controller the IR commands from the source component's remote control. The **Learn IR** selection is your next programming choice.

Depending on your profile selection, most of the buttons on the Delta Controller and Matrix keypads will already be intuitively assigned. There will be instances where something is labeled *User Defined* and it will indicate the button/action sequence that is assigned to that user defined command. The actual command from the source component's remote could be anything you want, but the way Delta activates that command will be described in that user defined command sequence (usually press or press hold a specific button).

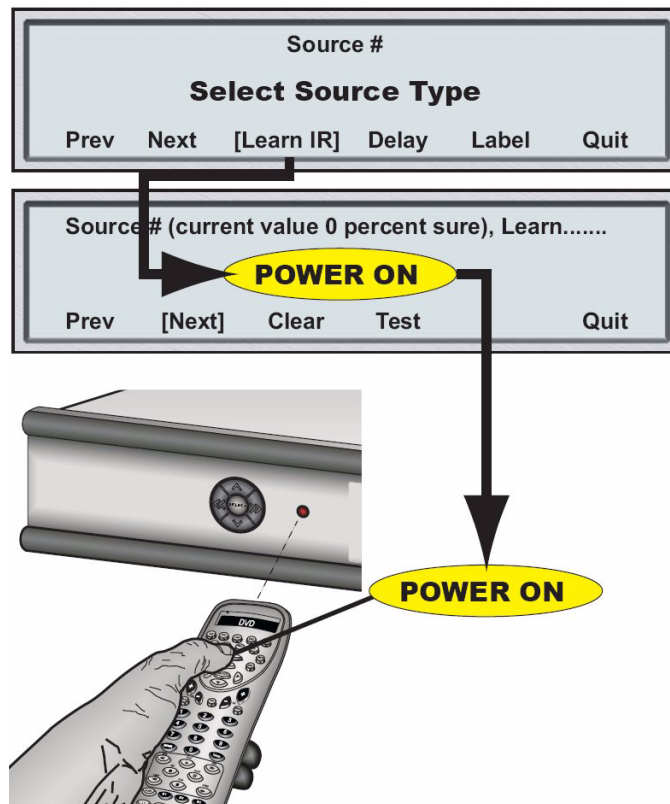

FIG. 27 Assigning a Source - Sample Sequence

- **Previous** returns user to previous IR code that was learned.
- **Next** scrolls through IR commands for the Source type.
- **Clear** clears the IR code that was learned for the IR code displayed.
- **Test** sends the IR code that was learned to the applicable source. If no command learned, no command will be sent.

- **Label** allows customization of the labels for the IR commands that relate to the keypad navigation buttons: *UP/DOWN/LEFT/RIGHT/ CENTER (USER DEF1) / CENTER HOLD (USER DEF2)*. Some commands cannot be relabeled.
- **Quit** returns user to *Select Source for Programming* screen.

When an IR command is taught to Delta, there is an indication that appears on the Controller screen with an option to test the command. This message indicates the success (or failure) of the command learning. *Please take the time to understand what Delta is telling you!*

One of the following messages will appear:

- **IR not taught – Error Code #** - This means that the command was not received, was incomplete or could not be learned. Pressing **[OK]** returns the user to the same IR command to be re-learned (FIG. 28).

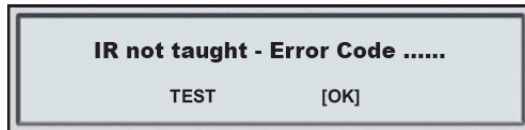

FIG. 28 IR not taught – Error Code #

- **IR OK – 99 percent sure** - This means that more than 2 commands were received. That’s more or less the ideal response you’d like to see from Delta. Pressing **[OK]** takes user to next IR command to be learned (FIG. 29).

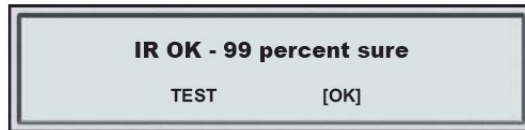

FIG. 29 IR OK – 99 percent sure

- **IR OK – 75 percent sure** - (2 commands were received). Pressing **[OK]** takes user to next IR command to be learned (FIG. 30).

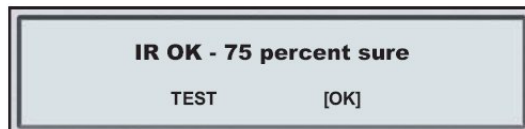

FIG. 30 IR OK – 75 percent sure

- **IR OK – 50 percent sure** - (1 command was received). Pressing **[OK]** takes user to next IR command to be learned (FIG. 31).



If the screen displays “99 Percent Sure” it does not mean that it’s going to be twice as reliable as a command that returned a “50 Percent Sure” screen. The command learn screen simply tells you what type of command Delta learned, not how reliable the command will re-transmit.

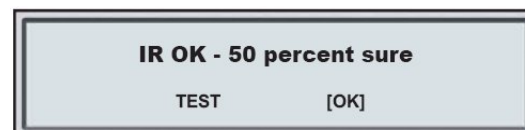

FIG. 31 IR OK – 50 percent sure

- **IR FULL (All memory for storing IR codes has been used).** Pressing [OK] returns the user to the same IR command to be re-learned (FIG. 32).



FIG. 32 IR FULL

- If a command is NOT learned, i.e. *IR FULL, IR not taught...*, *IR 0 percent sure*, clicking **OK** will return the user to the same IR command so that it can be re-learned.
- Once all IR codes have been learned for the Source type, the user will be returned to the *Select Source for Programming* screen where they can either select another source to program, or Exit the screen.

If the command is learned sufficiently or you want to test it out to be sure, select **TEST** from the menu and determine if Delta correctly emulates the command. If so, the source component should perform the same function as what you entered from the remote for that command in the previous step. The default command is YES (FIG. 33).



FIG. 33 IR Tested OK? (default = YES)

- Pressing [YES] takes user to next IR command to be learned.
- Pressing [NO] returns user to same IR command to be relearned.

Labeling IR Commands

At any time during the programming sequence you will have the opportunity to label that command. If the selection **Label** is displayed then you have that option, but if it is not displayed, it is a common command name that does not require labeling. The **Label** selection will appear and function if it is one of the following commands (FIG. 34):

- (kp UP)
- (kp DOWN)
- (kp LEFT)
- (kp RIGHT)
- (kp CENTER)
- (kp CENTER hold)

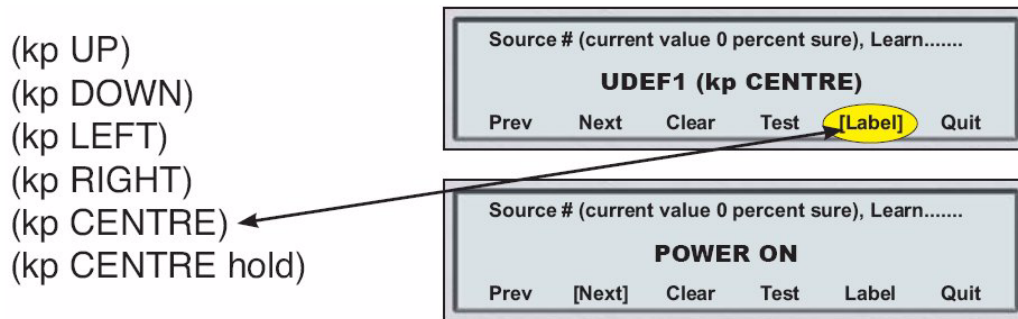

FIG. 34 Label Selection

When **Label** is selected, the first letter in the IR command label will begin flashing (FIG. 35):

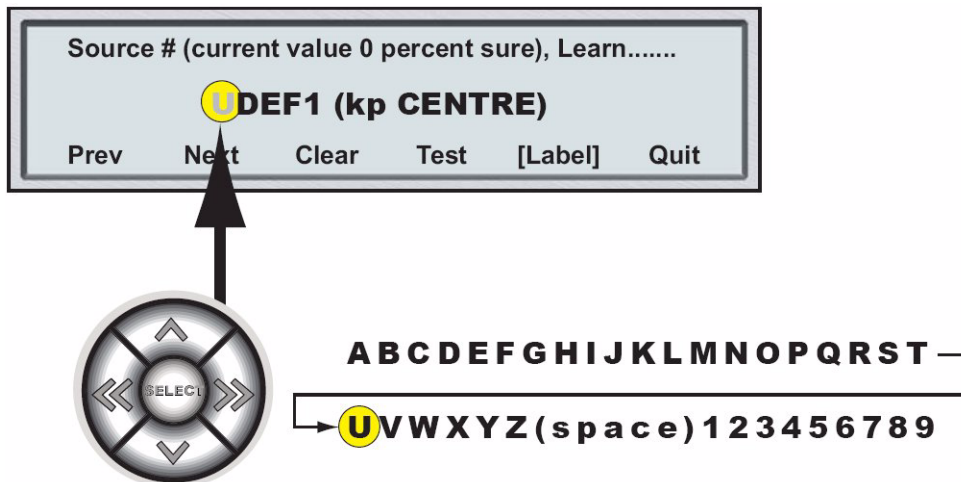

FIG. 35 Labeling IR Commands

- Nav **UP** will display the next letter in the alphabet
- Nav **DOWN** will display the previous letter in the alphabet
- Nav **RIGHT** will move to the next character in the command label (you can only scroll forward, you cannot scroll backward)
- Nav **LEFT** will DELETE the character currently in focus, in the command label
- Nav **CENTER** will save the room label and stop the characters from flashing



Nav. **LEFT** will replace the character with a “space”. The next character = “1”, while the previous character = Z

- The characters are all upper case or numeric.
- There is also a “space” character.
- There are no “special” characters such as !@#%&*(){}-+?.
- Also, there are no options to input lower case characters.

Adding Delay to IR Commands

On the **Select Source Type** screen, users have the option to add a “delay” to each IR command learned for the specified source (FIG. 36). A delay is sometimes necessary when the preceding remote command has an extended string or if it takes a small amount of time to “process” the command before the next one is recognized.

When **Delay** is selected, the *Delay Programming* screen is displayed, with **.2 sec** as the default delay. A delay of 0 – 2 seconds can be added in 1/10 increments.

In the example shown in FIG. 36, the DVD player is assigned as Source #2. The source number and the profile assignment could be any of your chosen sources when using this feature.

The timing increments for the delay are adjusted from the navigation button array on the front of the Delta Controller. Once the delay entry is complete, press the center button to return to the Select Source Type screen.

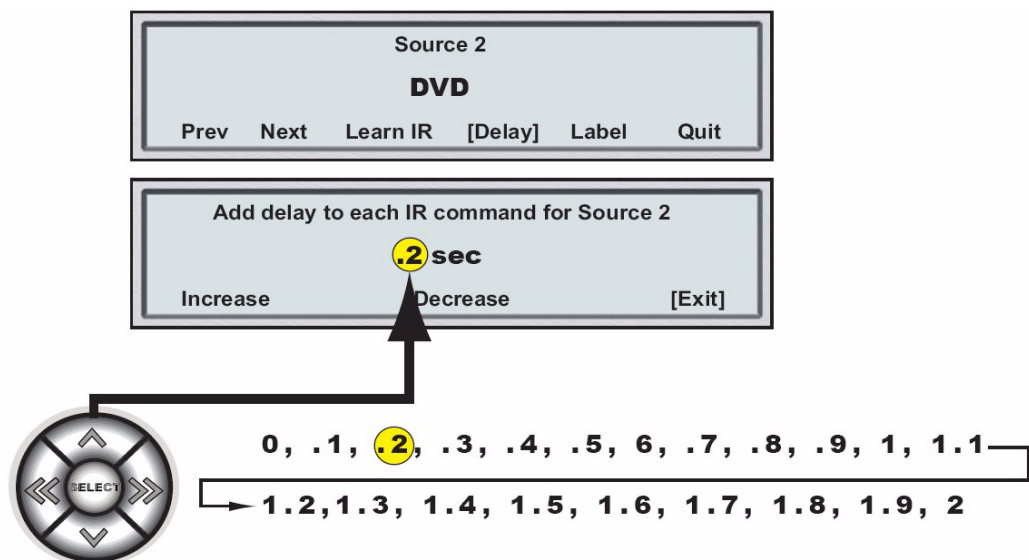

FIG. 36 Adding Delay to IR Commands

The delay will be sent with each IR command as it is issued from keypads, LCD keypads, remotes, i-Control, etc. The delay can be changed as many times as necessary, without having to re-learn any of the IR commands.

Labeling a Source

On the **Select Source Type** screen, users have the option to add change the Source Type Label for each Source Type (FIG. 37). When **Label** is selected, the 1st letter in the *Source Type* label will begin flashing and then you enter the label you want for the source component one character at a time. This operates just as the labeling custom commands did on the previous page.

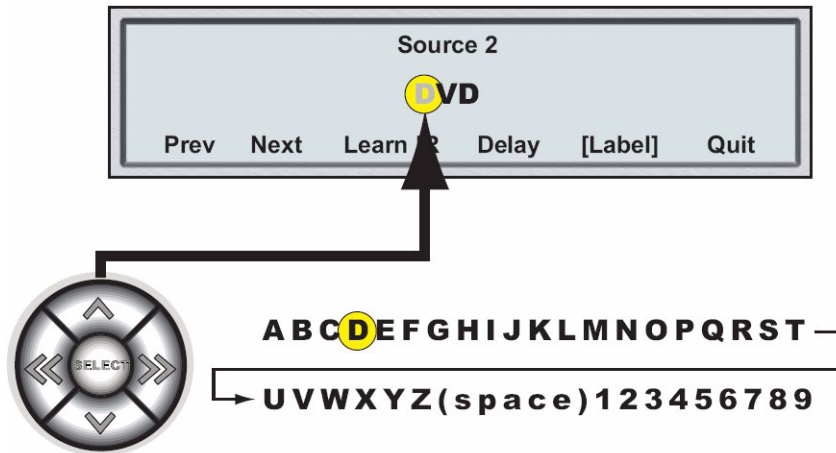

FIG. 37 Labeling a Source

Labeling a Room

Any room can be named whatever the user wants (within the character selections) but is limited to 6 characters per zone.

To label a room, select **Room Label** and which of the rooms you want to label. The first letter will begin flashing.



NOTE

If you choose not to label a room and delete all the characters so only blank spaces appear, when the room is activated there will be no text label shown on the Delta Controller front panel. Default labeling is RM1-RM6.

1. From the Setup screen, select **Controller**. The *Controller Setup* screen will be displayed. The menu selection immediately defaults to the *Exit* selection in the first screen of the Controller Setup Menu.
2. Using the navigation button, select **Rm Info** and the *Room Information* screen will be displayed (FIG. 38).
 - Default = **Exit**.
 - **Room Label** will allow user to define names for each of the rooms/zones.
 - **Status** will display the status for each of the rooms/zones.

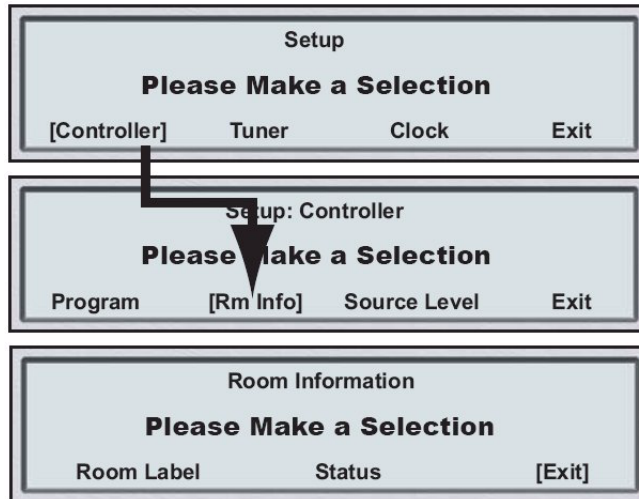

FIG. 38 Labeling a Room

To label a room, select “**Room Label**” and which of the rooms you want to label. Since the screen defaults to “**Exit**”, use the navigation buttons to navigate the rooms on the menu and when you want to select one to label, press the center navigation button. The first letter will begin flashing.

In the example shown in FIG. 39, the label for **Zone #1** is being selected for labeling. Since there are only 6 characters allowed for the label, you can abbreviate or use creative acronyms that make it easy for you or other users to recognize.

Select the character you want by pressing the center button of the navigation array and the next character position will flash. Repeat this process until the zone is labeled.

Once labeling is complete (after the last character is completed or passed), the navigation brackets will allow movement to a different room selection for labeling.

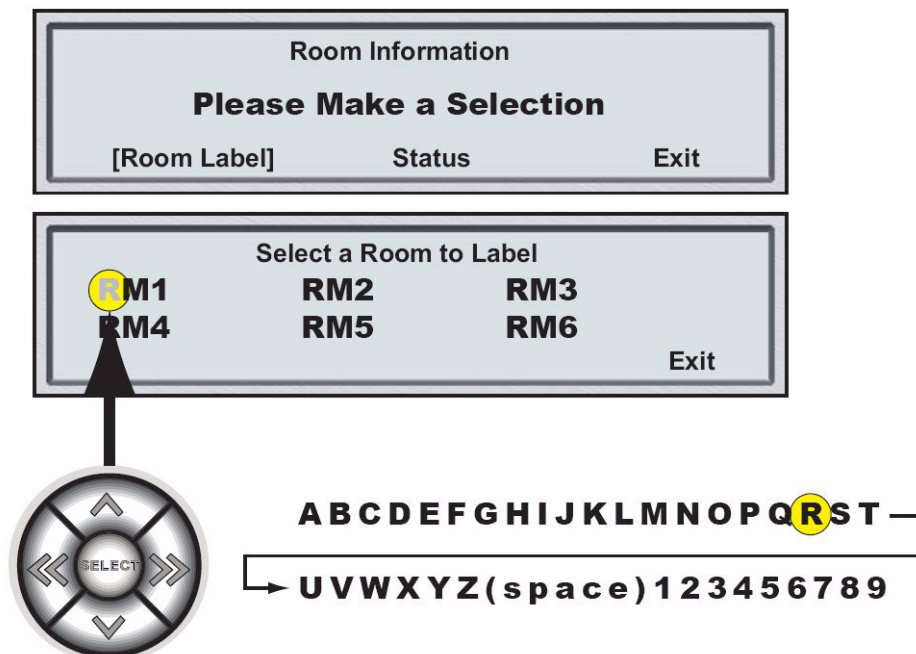

FIG. 39 Select a Room to Label

Begin labeling the room using the same method as the IR command and source programming from previous pages, selecting the center button to move to the next character. If the room has not already been labeled or defined, RM1-RM6 will be displayed for each zone. Any room can be named whatever the user wants (within the character selections) but is limited to 6 characters per zone. Once the characters have stopped flashing, the user can select another room to label by using the navigation buttons.



NOTE

If you choose not to label a room and delete all the characters so only blank spaces appear, when the room is activated there will be no text label shown on the Delta Controller front panel. This will not affect the room operation in any other way, it just may be confusing for some users if there is no text displayed for the room in question.

Check Room Status

To see the status of a room, select “Status” from the “Room Information” screen. The resulting screen will show each zone with a status next to it (FIG. 40).

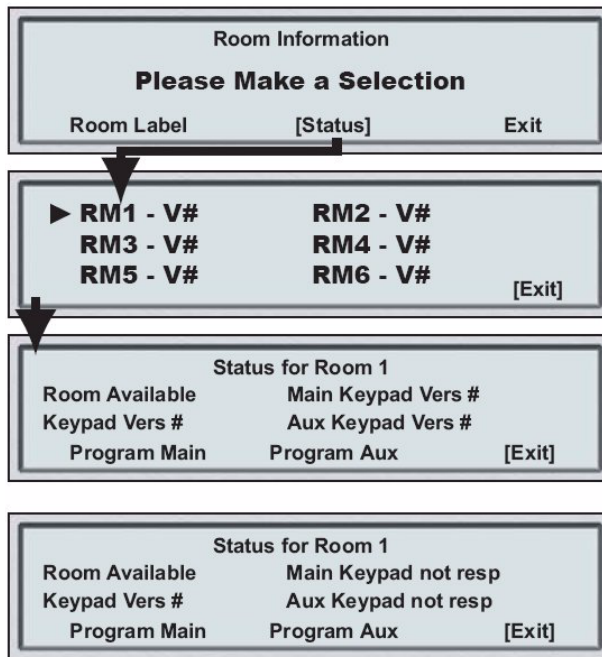

FIG. 40 Check Room Status

If a keypad has been connected to a zone and everything is okay, the software/firmware version number will be displayed to the right of the room name. If the status of the room is other than normal, the version # will be replaced with a status message (up to 8 characters) of the problem:

Status Values	
Status Values	Message Displayed
Version #	V#
Not Responding	NOT RESP
Corrupt	CORRUPT
Bad	BAD
Room Available	RM AVAIL

The user can select a room by using **Nav RIGHT/LEFT** and **Nav. CENTER** to select a room. Selecting a room will take the user to the *Status Screen* for that room. The default is **Room 1**.

If there is no Main keypad or Aux keypad, **Keypad not Resp.** will be displayed instead of **Main keypad Vers #** or **Aux Keypad Vers #**.

Setting Source Levels

With the Delta system, you *must* do some level matching for source components so that changing from source to source does not have drastic changes in the overall system volume. In some cases, carry in peripherals (such as an MP3 player) may need to have levels set because they will need to be able to reach their own maximum volume without overdriving the signal into the Delta unit.

The on-board AM/FM Tuner level is the reference level to which the other sources much level match. The range is between +18 and -12dB in 3dB steps

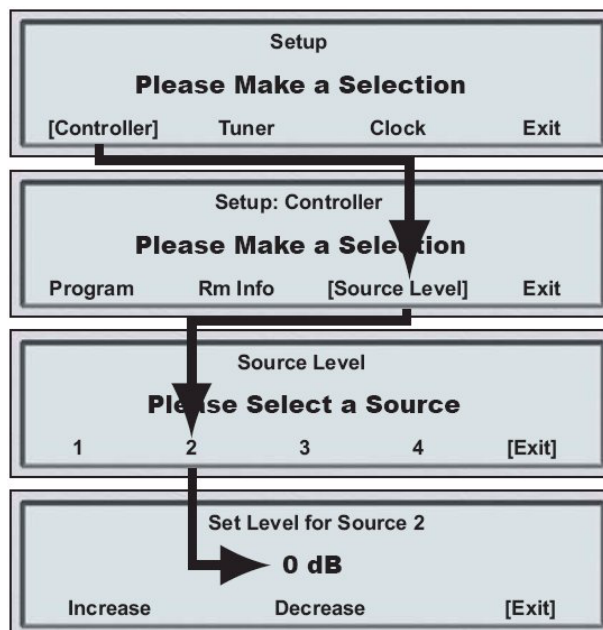

FIG. 41 Setting Source Levels

1. From the Setup screen, select “**Controller**”. The “*Controller Setup*” screen will be displayed. The menu selection immediately defaults to the Exit selection in the first screen of the Controller Set Up Menu.
2. Using the navigation button, select “**Source Level**” and the “*Source Level*” screen will be displayed. Choose between Source numbers 1-4. (The example in FIG. 41 shows Source #2 because Source #1 defaults to the on-board AM/FM Tuner if it is installed).
3. Set the levels by increasing or decreasing. The range is between +18dB and -12dB with **0dB** as the default setting.
4. After setting the appropriate level, select “**Exit**” to set the levels of the next source component.

Tuner Sub Menu

From the *Setup* screen, select **Tuner** (FIG. 42). If there are no tuner modules installed in the Delta Controller, the *Tuner* selection will simply not appear.

You can select the band (**AM/FM**) - The AM/FM selection works like a toggle.

- Select **AM** and press **Nav. Centre**, it will change to FM.
- Press **Nav. Centre** again, and it changes back to AM.

You can select **Stereo/Mono** - The Stereo/Mono selection works like a toggle.

- Select **Mono** and press **Nav. Centre**, it will change to Stereo.
- Press **Nav. Centre** again, and it changes back to Mono.

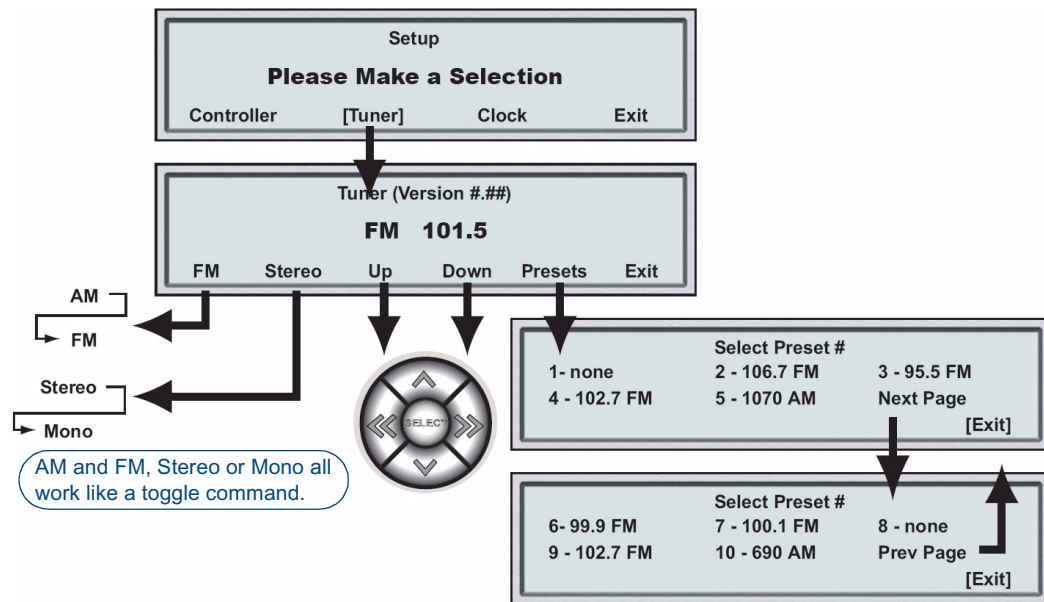

FIG. 42 Tuner Sub Menu

Setting a Station Preset

1. Press **UP** or **DOWN** to seek to desired station.
2. Once station is found, select **Preset**.

The Delta programming screen will be displayed showing presets 1-5 and a *Next Page* selection. There are two screens (the **Next Page** selection takes you to presets 6-10 and offers a *Previous Page* command).

3. Select the preset number you want and press **Nav. Centre**. The station selected will be saved to that preset location along with the band (*AM/FM*) and *Stereo* or *Mono* setting.

After saving a preset, the Tuner Preset screen remains displayed with the current preset as the selected item.

Clock Sub Menu

From the Setup screen, select **Clock** (FIG. 43).

- To set *Hour, Minute, & Second*, press **Nav UP/DOWN** button to scroll up & down.
- To set *Month, Date & Year*, press **Nav UP/DOWN** button to scroll up & down.
- To set *Day*, press **Nav. UP/DOWN** to scroll through the days of the week.

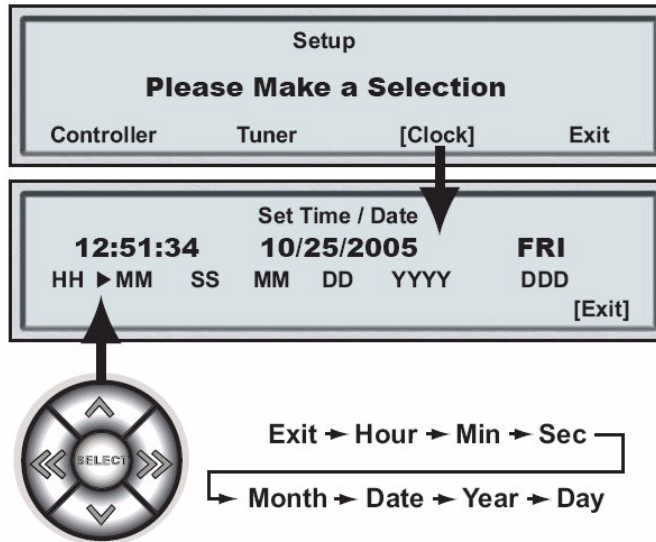

FIG. 43 Clock Sub Menu

Preferences Program Menu

Backlight Sub Menu

This menu allows the user to set default options for Backlight as well as what they would like displayed on the Controller LCD screen (FIG. 44).

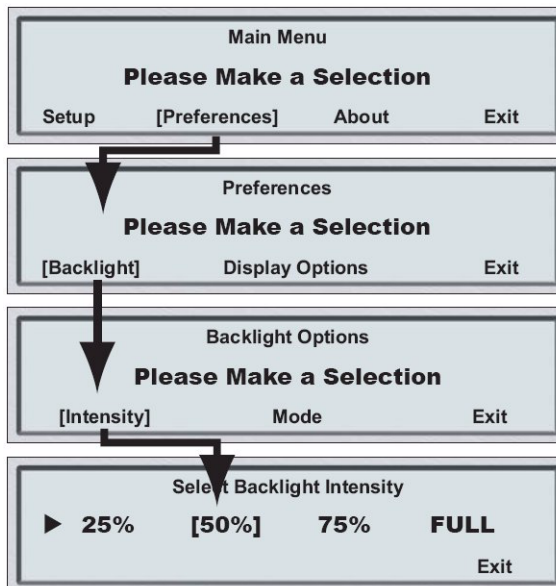

FIG. 44 Preferences Program Menu - Backlight Sub Menu

1. From the Setup screen, select **Preferences**. Then from the Preferences screen, select **Backlight**. The Backlight screen will default to **Exit**.
2. In the Backlight menu, there are 2 options, *Intensity* and *Mode*. Upon initial setup of preferences, begin by selecting **Intensity**. This sets the control of the backlighting intensity.
 - **25%** = backlight intensity will be 25% of FULL
 - **50%** = backlight intensity will be 50% of FULL
 - **75%** = backlight intensity will be 75% of FULL
 - **FULL** = backlight intensity will be 100%

An arrow is used to indicate which line of information is currently active (FIG. 45). Nav UP/DOWN moves the arrow focus between the intensity selections and the Exit command. Once the intensity selections are “active”, Nav LEFT/RIGHT will move from option to option. Nav CENTER is used to make a selection.



FIG. 45 Arrow Indicates Which Line of Information Is Currently Active

3. After selecting **Exit** from the *Intensity* menu, Delta will return the user to the *Backlight* menu. From this menu, choose **Mode**. This menu allows the user to choose when the backlighting will be ON and OFF (FIG. 46).



FIG. 46 Backlight Menu

- If **Auto ON** is selected - Backlight is ON during Programming. Once the user exits programming, and none of the Nav. buttons are selected for (30) seconds, the backlight turns OFF. This is the initial default setting.
- If **Always ON** is selected - Regardless of whether in Program mode or not, the backlight remains ON at all times.
- If **Always OFF** is selected - Regardless of whether in Program mode or not, the backlight remains OFF at all times.

Display Options Sub Menu

Display Options allows the user to select what information they would like to see displayed on the Controller Front LCD when not in “Programming Mode” (FIG. 47).

1. From the Setup screen, select **Preferences**. Then From the Preferences screen, select **Display Options**. The Display Options screen will default to *Room*.
2. In the Display Options menu, there are 4 options, *Room*, *Clock*, *Tuner*, and *Room Detail*.

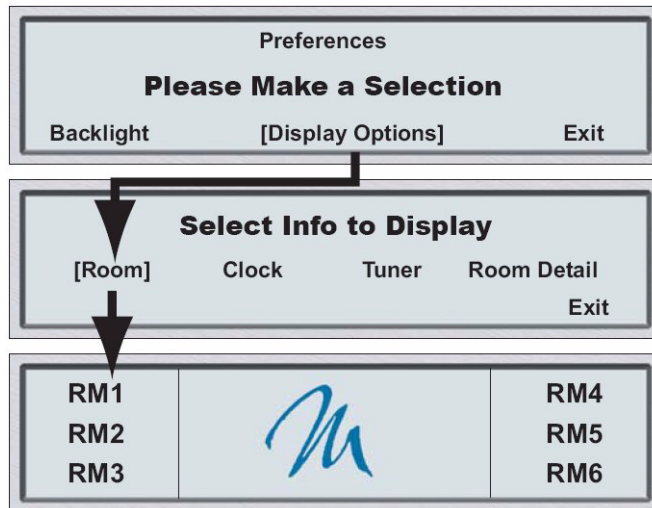

FIG. 47 Display Menu

- If **Room** is selected (this is the default), the “M” will be displayed, along with any zones that are turned ON. It will only show active zones and, if the zone has been customized with a label, it will display that label. When all zones are off, it simply defaults to the “M” screen.
- If **Clock** is selected, the current time, date, and day will be displayed (the “M” will not be displayed - FIG. 48).

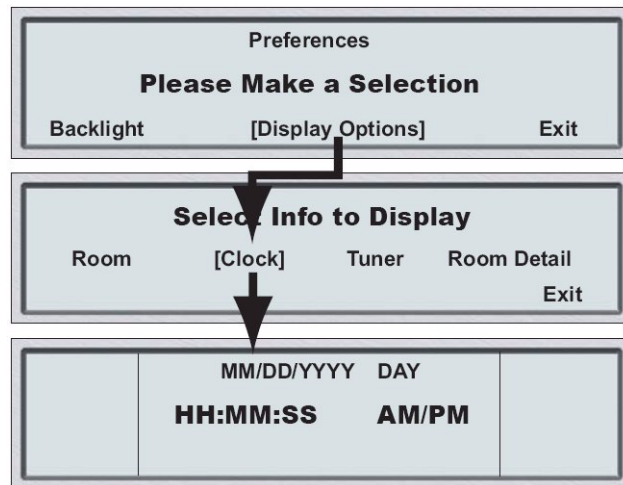

FIG. 48 Clock Menu

- If **Tuner** is selected, when the Tuner source is selected in ANY room/zone, the Tuner Information will be displayed on the Controller LCD default screen (FIG. 49).



FIG. 49 Tuner Menu

If the Tuner is currently ON in one of the zones, and the Tuner information is currently being displayed, pressing the CENTER Navigation button on the front of the Controller will take the

user to the “Main Menu”. When exiting the Main menu, the Tuner Information will be displayed once again.

If none of the zones/rooms are ON, then the “M” will be displayed. When a zone is turned on to the tuner, the Tuner information will be displayed. The Tuner information consists of the *Preset Number* (if applicable), the *station frequency*, *AM* or *FM*, and *Stereo* or *Mono*.

- If **Room Detail** is selected, the room/zone Name, and the following zone status information will be displayed (the “M” will not be displayed):
 - If there is no zone board, **RM#: NoZo** will be displayed
 - If there is no keypad, **RM#: NoKP** will be displayed
 - When there is a zone board installed and keypad connected:
 - If the room is muted, **RM#: Off** will be displayed.
 - If source is on, **RM#: src#** will be displayed.

About Program Menu

From the Main menu screen, select “**About**”. The Controller firmware version number is displayed (FIG. 50).

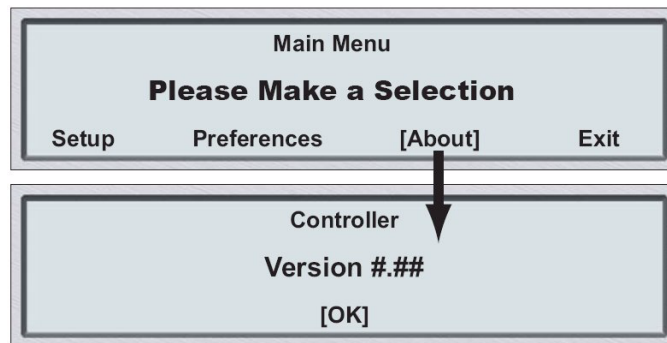

FIG. 50 About Program Menu

Firmware Version

This simply ensures you are aware if you have the latest update or not. In some cases if you report problems to the Matrix Audio technical support team, they may ask you which firmware version your Delta Controller currently has. This often assists them in pinpointing your problem if it is related to the Delta firmware and not to the installation or external wiring.

Once you press **OK**, you will return to the Main menu screen.

Using Matrix Keypads

Using the Matrix KP-4e Keypad

Source Selection

The Source Selection Key is different than the other function keys. It provides control of the Source On/Off, System On/Off and Play/Pause.

When a source button is selected, the following occurs:

- The SOURCE is turned ON & begins playing.
- If source = on-board TUNER, the last station listened to will begin playing.
- If source = external TUNER, the last station listened to will begin playing.
- If source = CD, then the 1st CD, 1st Track will begin playing automatically.
- If source = SATELLITE, then the last (or current) channel viewed will begin playing.

Activating or Deactivating a Zone

Pressing the Source key turns the system on in the room you are in and also turns that source on if it has not been previously selected in another zone (FIG. 51).

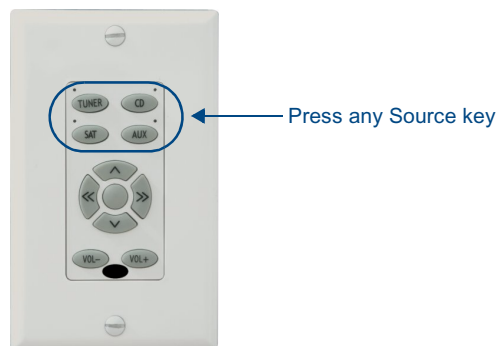

FIG. 51 Activating or Deactivating a Zone

The indicator next to the source will light Red. Through Matrix's own Dynamic Macro process, sources that are muted or paused will be turned off after they are idle (not selected in any zone) for ten minutes. Press the active source button again to turn the zone off.



NOTE

Solid RED = Only User, 3 RED Flashes = Multiple Users. This is important to know because changing a source attribute (such as disc, track, preset, etc.) will affect all connected zones.

All Zones ON or OFF

To turn ALL zones ON to the same source, press and hold the source button for 4 seconds. To turn that source back OFF in all zones, repeat the process by pressing and holding the active source button for 4 seconds (FIG. 52).

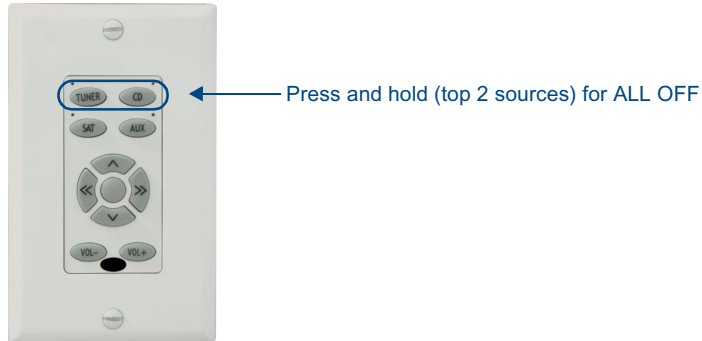

FIG. 52 All Zones ON or OFF

To turn ALL zones OFF and shut the whole Delta system down, press and hold Source button 1 & 2 (top 2 buttons) simultaneously for 4 seconds. All zones will be turned off, and no sources will play.

- One minute after an ALL OFF has been performed, all sources will be powered down.
- Status LED on keypads will simultaneously flash to signal this command has taken place.

Navigation Command Keys

The navigation button array is a five way switch with a total of 6 possible functions (FIG. 53).



FIG. 53 Navigation Command Keys (KP-4e)

The buttons move up / down / left / right and by pressing the center position straight in (“Press” and “Press/Hold” are two distinct commands). As an example these functions provide you with track, disc, channel, station and preset up and down. The center position provides you with function like Enter, Select, or OK.

Please read the command sequences carefully.

Volume Control

Control of the system volume is very intuitive because of discrete buttons for the Volume UP and Volume DOWN command (FIG. 54).

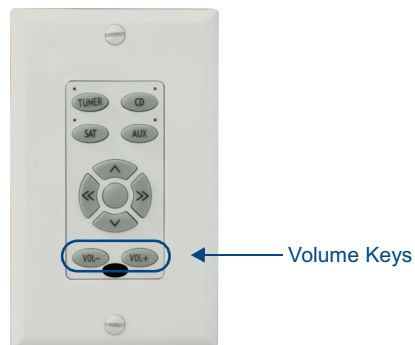

FIG. 54 Volume Control

When increasing or decreasing volume, the progression is in 3dB steps when the volume is half (of maximum) or below. Above the halfway point, the progression drops to 1dB steps so you can fine tune the adjustment without worry of overdriving speakers by surprise.

- **Stepped Volume UP** = Press & release VOL UP button
- **Stepped Volume DOWN** = Press & release VOL DOWN button
- **Rolling Volume UP** = Press & hold VOL UP button
- **Rolling Volume DOWN** = Press & hold VOL DOWN button

Muting the Volume

The keypads offer Dynamic Macro control for the sources used in the system. For example the pause command: If a single zone is accessing the CD player and you decide to mute the zone or turn it off, selecting the source button for CD will pause the CD player and turn the zone off. If there are multiple zones accessing the CD player, selecting the source button for CD issues a mute command for that specific zone and it is turned off while other zones using CD continue to play. The system acts like a client server, distributing control on a “fair” basis. This makes it easy for the system to share the sources and stay in sync.

Tone Control

The tone control mode allows the user to adjust Bass, Treble, and Balance on a “per zone” basis.

To enter tone control mode, press VOL UP & VOL DOWN buttons simultaneously until LED’s begin to cycle in a counter-clockwise motion. This will enable the BASS and BALANCE settings first.



NOTE

At any time during adjustments, if you want to return the settings to default, press and hold the center keypad navigation button.

Bass (and Balance) Adjustment

Bass and Balance Adjustment Mode is the first action taken during the setup sequence. The source indicator lights will rotate in a counter-clockwise direction indicating Bass Adjust Mode. Click the navigation button in the up direction to increase the Bass and down to decrease the Bass (FIG. 55).

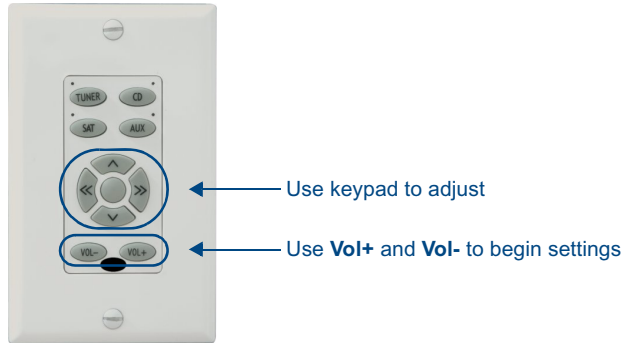

FIG. 55 Bass/Treble (and Balance) Adjustment

- Bass adjustments are +/- 10 dB, moving in 1dB steps. Clicking the navigation button to the left or right will operate the balance function.
- When you are satisfied with your adjustment, press (but not hold) the center keypad navigation button to save the Bass and Balance settings. This will take you into the Treble Adjustment Mode.

Treble (and Balance) Adjustment

Adjustment of Treble is the second action in the setup sequence. The source indicator lights will now rotate in a clockwise direction indicating Treble Setup Mode. Treble Mode operates in the same manner as the bass mode (see FIG. 55).

- Treble adjustments are +/- 10 dB, moving in 1dB steps.
- Balance adjustments can still be made while in the Treble Setup Mode.
- When you are satisfied with your adjustment, press (but not hold) the center keypad navigation button to save the Treble and Balance settings. This will take you back to the normal operation mode.

Using the Matrix KP-NUM Keypad

There are several “advanced” functions that are associated with the KP-NUM keypad (FIG. 56). These functions use the “0 through 9” plus the “Star” or “Dot” and “Enter” buttons.



FIG. 56 KP-NUM keypad

This numeric keypad allows for the use or programming of presets as well as Direct Numeric Access for AM/FM stations, Multi Disc Changers, or other source components that have a numeric keypad on the original remote control.

Direct Access Control

The user can enter commands via the numeric keypad to directly select favorite discs, tracks, stations and channels. This provides an easy way in which to select material directly from the source component that you know (such as the station ID or the disc/track number).

Direct Numeric Access - On Board AM/FM Tuner

Using the Numeric keypad, enter the station identification and press **ENTER** (FIG. 57).

- Strings of 3 to 4 numbers are recognized.
 - If an * (asterisk) or • (dot) is part of the command string, then an FM station is assumed, otherwise an AM station is assumed.
1. First enter the station (include the dot where applicable).
 2. Press **ENTER** to execute the command.

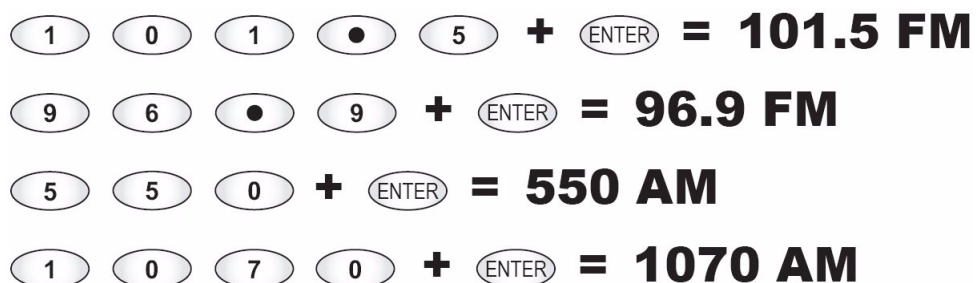

FIG. 57 Direct Numeric Access - On Board AM/FM Tuner

Direct Numeric Access - CD Player or Changer

When selecting direct numeric access for a single disc CD player, the format is ONLY to choose the track (since there is only a single disc from which to choose). When selecting just a track the Delta Controller will recognize a selection of up to 3 characters (1-999). When the source component is a multi-disc changer however, there is the option to select either the track on the current disc OR directly select the disc and track number you want to play. The Delta Controller recognizes up to 3 characters for a disc command (separated by the • (dot) command) and then 3 additional characters for the track command. If there is no dot in the command string, Delta assumes it's just a track only entry.

To select a specific Track on the disc currently playing, press **TTT + ENTER (TTT=Track)** - FIG. 58.

$$\begin{aligned} & \text{(5)} + \text{(ENTER)} = \text{Track 5} \\ & \text{(1)} \text{(7)} + \text{(ENTER)} = \text{Track 17} \\ & \text{(1)} \text{(2)} \text{(0)} + \text{(ENTER)} = \text{Track 120} \end{aligned}$$

FIG. 58 Select A Specific Track On The Disc Currently Playing



NOTE

Remember that direct TRACK ONLY selection will select from the disc that is currently in play.

To select a specific Disc & Track, the format is **DDD•TTT + ENTER (DDD=Disc & TTT=Track)** - FIG. 59.

$$\begin{aligned} & \text{(4)} \text{(•)} \text{(7)} + \text{(ENTER)} = \text{Disc 4, Track 7} \\ & \text{(1)} \text{(0)} \text{(•)} \text{(2)} \text{(1)} + \text{(ENTER)} = \text{Disc 10, Track 21} \\ & \text{(1)} \text{(6)} \text{(3)} \text{(•)} \text{(2)} + \text{(ENTER)} = \text{Disc 163, Track 2} \end{aligned}$$

FIG. 59 Select A Specific Disc & Track

Please note that if you want to go to a disc in a multi disc changer, but you want it to begin playing from the beginning (in other words you don't plan to enter a specific song) you must either tell Delta to just start playing the disc (such as 4 + • + ENTER) or tell it to start on track number 1 (4 + • + 1 + ENTER). Without entering the "dot" after the disc number, Delta assumes the command is a track number. All disc numbers MUST be followed by the "dot" command.

Direct Numeric Access - Satellite Radio or DSS/DBS Tuner

Using the Numeric keypad, enter the station number and press **ENTER**. Strings of 2 to 4 numbers are recognized (FIG. 60).

1. First enter the satellite channel (up to 4 digits)
2. Press **ENTER** to execute the command.

$$\begin{aligned} & \textcircled{6} + \textcircled{\text{ENTER}} = \textbf{Channel 6} \\ & \textcircled{4} \textcircled{4} + \textcircled{\text{ENTER}} = \textbf{Channel 44} \\ & \textcircled{2} \textcircled{0} \textcircled{2} + \textcircled{\text{ENTER}} = \textbf{Channel 202} \\ & \textcircled{1} \textcircled{0} \textcircled{3} \textcircled{6} + \textcircled{\text{ENTER}} = \textbf{Channel 1036} \end{aligned}$$

FIG. 60 Direct Numeric Access - Satellite Radio or DSS/DBS Tuner

Setting Individual Source Component Presets

The numbers on the numeric keypad (1-0) can be used to store presets for each source. Each source has 10 possible presets. The presets are source specific and NOT room specific. Any source that utilizes Direct Access can have presets programmed:

- Matrix on-board AM/FM Tuners
- External Tuners (such as satellite radio or DSS/DBS)
- Satellite Radio/Video
- CD Players/Changers
- Audio Servers

Both creating and recalling presets ask for the “dot” command to begin recognition of the sequence. Creating a preset requires the ENTER button to be pressed and HELD to store. When a preset number is selected, the press and hold command for the ENTER button tells Delta you want to store a preset instead of just recall a preset as simply pressing (but not holding) ENTER will do.

Please distinguish the different procedures for the most effective use.

Create a Preset

1. Select the source
2. Direct Tune to the station of choice (enter **station ID + ENTER**)
3. Select the “**dot/preset**” key
4. Key in the **preset number** (1 – 10)
5. Press & Hold **ENTER**

Recall a Preset

1. Select the source
2. Select the “**dot/preset**” key
3. Key in the **preset #** (1 – 10)
4. Press **ENTER**

Clear All Presets

1. Select the source
2. Select the “**dot/preset**” key
3. Key in “**00**”
4. Press & Hold **ENTER**

In the examples shown in FIG. 61, the source is first selected, then the channel, station, or track number is entered for bring up the preset you would like to save.

Once the selection is playing, press the “**dot/preset**” button and the numbered position you want and Delta stores the preset when you press and hold **ENTER**.

To recall that same preset on the same source, simply press the “**dot/ preset**” button and the numbered position you want then **ENTER**.

Example 1

- 1) **XM**
- 2) **2** + **1** + **ENTER** = **Channel 21**
- 3) **.** + **1** + **HOLD ENTER** = **Store as Preset #1**
- 4) **.** + **1** + **ENTER** = **Recall Preset #1**

Example 2

- 1) **DSS**
- 2) **2** + **0** + **6** + **ENTER** = **Channel 206**
- 3) **.** + **5** + **HOLD ENTER** = **Store as Preset #5**
- 4) **.** + **5** + **ENTER** = **Recall Preset #5**

FIG. 61 Setting Individual Source Component Presets - Examples

Using the Matrix Touch Panel Keypad

The Matrix touch panel keypads (FIG. 62) have a unique, touch sensitive LCD panel that has 12 individual “grids” (also called “touch fields”) that become different command buttons depending on what source and previous command was selected. It’s really the best of a KP-4e and numeric keypad all in a single unit, yet with even more customizable features as well as visual user feedback.



FIG. 62 Matrix Touch Panel Keypad

While this section of the Delta manual has some information about the user functions, full programming information can be found in the manual that is included with the Matrix Touch Panel Keypad.

Labeling the Keypad Grids

The Matrix touch panel keypads provide the ability to customize the following labels in the grids (also called “touch fields 1-12” - see FIG. 63):

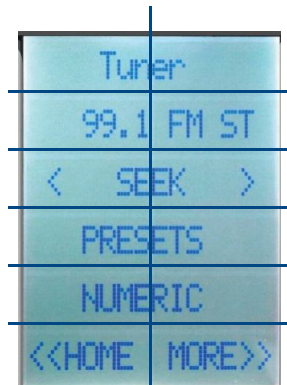

FIG. 63 Touch Panel Keypad - 12 Touch Fields

- Source Names (from the Controller)
- IR command labels (from the Controller)

The above customized field labels are stored on the Delta Controller so that it can be shared with other LCD keypads, the Network Interface application, or anyone using RS-232 commands to control the Delta Controller.

Customizing LCD Keypad Labels

Customization of labels displayed on the LCD keypad is done via the *Setup* menu on the front of the Controller. Both *Source* labels and *Source Control* labels can be customized (FIG. 64).

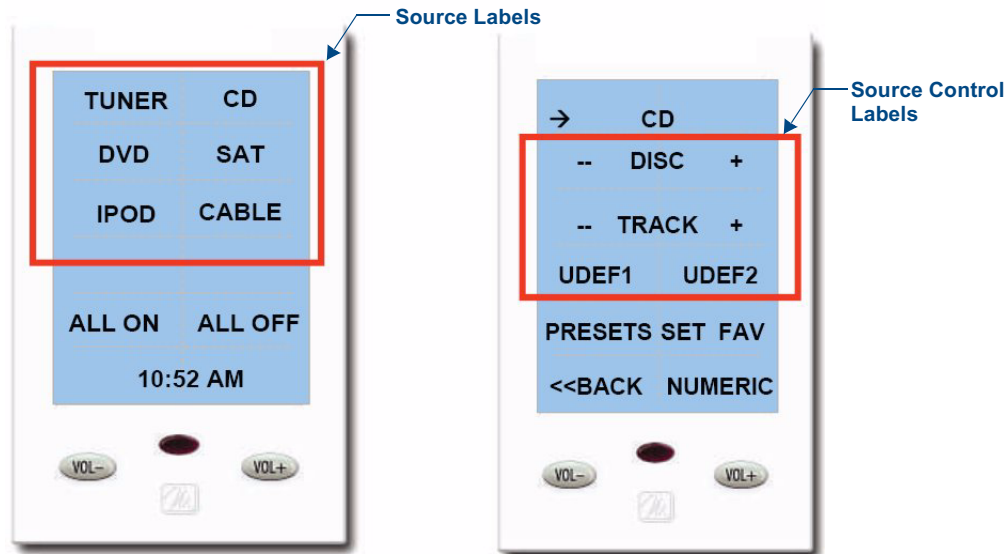

FIG. 64 Source Labels and Source Control labels

Customizing SOURCE Labels

1. Enter the *Setup* menu from the front of the Matrix Controller, by pressing the **SELECT** button (FIG. 65).

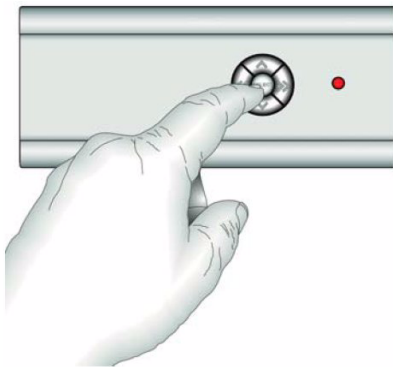

FIG. 65 Press the SELECT button on the front of the Matrix Controller

2. From the menu displayed, select **SETUP / MRC / PROGRAM**.
3. Select the **source #** of which you wish to customize the source name. The default Source name will be displayed.
4. Select "**Label**". The first letter of the *Source Name* will be highlighted. Use the **UP/DOWN** buttons to change the letters in the source name.
 - To move from letter to letter, use the **FORWARD >>** button.

- To delete a letter, use the << **BACK** button.
- Press the **CENTER** button to save the label.



Source Names are limited to 6 characters.

Customizing SOURCE COMMAND Labels

1. Enter the *Setup* menu from the front of the Matrix Controller, by pressing the **SELECT** button.
2. From the menu displayed, select **SETUP / MRC / PROGRAM**.
3. Select the **source #** of which you wish to customize the source command name.
4. Select "**Learn IR**". The first IR command for the source will be displayed.
5. Select "**Next**" until the IR command you wish to customize is displayed.
6. Select "**Label**". The first letter of the *IR Command Name* will be highlighted. Use the **UP/DOWN** buttons to change the letters in the IR command name.
 - To move from letter to letter, use the **FORWARD** button.
 - To delete a letter, use the **BACK** button.
 - Press the **CENTER** button to save the label.



Source Command Names are limited to 6 characters.

Using the Matrix D-RC Remote

Overview

The IR remote controls that are supplied by the manufacturer of each audio source component are used for programming the Delta Controller. Each keypad has an integrated IR receiver to detect and process IR commands from the Matrix Remote as if the keypad had been accessed directly. However, the IR receiver on the keypads will not “pass” IR commands issued by the audio source component remotes. It is intended to receive the remote IR signals generated by the Matrix remote or by learning-remotes that have stored the Matrix remote codes.

If you would like to use a universal type “learning” remote instead of the Matrix D-RC, teach the learning remote all of the Matrix D-RC command buttons. The universal remote then emulates all of the commands transmitted to the keypad as if it were a Matrix D-RC remote. If you teach the learning remote (or use) the source component’s original remote commands, it will not work with the keypad IR receivers in the zone. Essentially, the keypad IR receiver must “think” that the command is coming from the Matrix D-RC remote. If you have successfully programmed the Delta Controller, teaching a learning remote the Matrix buttons should be quick and easy.

When aimed at an IR receiving Matrix keypad, the remote will emulate all the same functions that any Matrix keypad can issue (FIG. 66).

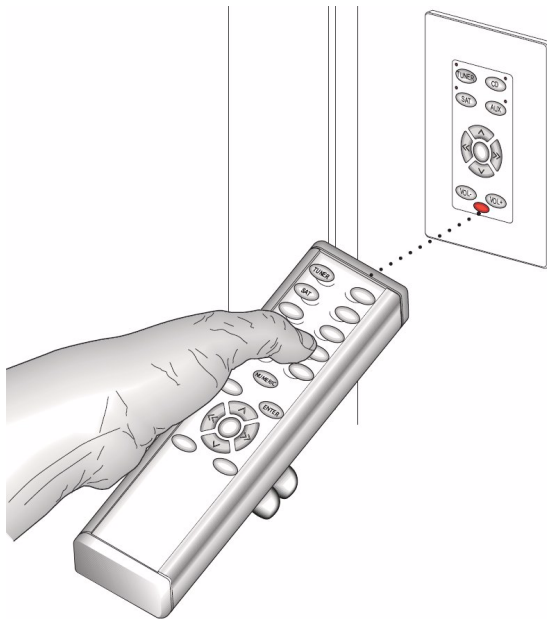

FIG. 66 Using the Matrix D-RC Remote

It is important to note that if you want to use any type of “universal learning” remote control device to operate through the Delta system, you must teach this device the Matrix remote commands (instead of directly using the source component remote commands).

The Matrix keypad’s IR receiver is calibrated only for the narrow bandwidth of the Matrix remote and will not work directly with other source component remotes. Any “learning” remote will essentially emulate Matrix remote commands that (depending on the source selection) have already been programmed into Delta through the initial device programming process.

RS-232 Control Commands / Messages

Delta Audio Controllers provide an RS-232 (DB9) port for receiving RS-232 Controller Commands. Refer to the *RS-232 Controller Command Messages* section on page 55 for a complete listing of supported commands.

- Connector: DB9 Male
- Communications: 4800 Baud, 8 data bits, 1 stop bit, no parity

The Matrix Distributed Audio, multi-room audio control systems can be externally controlled by sending ASCII text command strings to the Bi-Directional RS-232 serial interface. Every command must be terminated with a line feed (0x0A). All messages are case-sensitive.

The MRC will respond to command messages with a status response message once the command has been executed.

This section provides reference information for the following:

- *RS-232 Controller Command Messages* - These commands can be sent directly to the Delta Audio Controller via the RS-232 (DB9) port on the rear panel. See the *Connecting the RS-232 Serial Port* section on page 19 for connection and DB9 cabling information.
- *Delta Audio Controller Status Messages* (page 67) - These messages are received via the RS-232 port, and are used primarily for troubleshooting purposes.
- *Source Command Codes* (page 70) - Source Command Codes, received from the SWT keypads are referenced here by Source Type and Command Index.

RS-232 Controller Command Messages

RS-232 Controller Command Messages		
MVER	Get Firmware Version	Firmware Status Version - or - ERR
MGCF	Get Configuration	Configuration Status - or - ERR
FNIC	Get Number of IIC devices	Num IIC Devices Status - or - ERR
FGICx	Get IIC Device Status, where: 'x' is the IIC device index, valid values range from 1 to the number of available IIC devices as reported in the 'Num IIC Devices Status'	IIC Device Status - or - ERR
MSVLR,v	Set Volume, where: • 'r' is the desired room, (1-64) • 'v' is the desired volume level, valid values are: 101: Mute 0....70: 0....-70 dB	Volume Status - or - ERR
MGVLR	Get Volume, where: 'r' is the desired room, (1-64)	Volume Status - or - ERR

RS-232 Controller Command Messages (Cont.)		
MSBSr,b	Set Bass, where: <ul style="list-style-type: none"> • 'r' is the desired room, (1-64) • 'b' is the desired bass level, valid values are: 0: level 1....10: -10....-1 dB 11....20: 1....10 dB 	Bass Status - or - ERR
MGBSr	Get Bass, where: 'r' is the desired room, (1-64)	Bass Status - or - ERR
MSTRr,t	Set Treble, where: <ul style="list-style-type: none"> • 'r' is the desired room, (1-64) • 't' is the desired treble level, valid values are: 0: level 1....10: -10....-1 dB 11....20: 1....10 dB 	Treble Status - or - ERR
MGTRr	Get Treble, where: 'r' is the desired room, (1-64)	Treble Status - or - ERR
MSSCr,s	Select Source, where: <ul style="list-style-type: none"> • 'r' is the desired room, (1-64) • 's' is the desired source, valid values are: 0: no source selected 1-8: for sources 1 to 8 	Source Status - or - ERR
MGSCr	Get Source, where: 'r' is the desired room, (1-64)	Source Status - or - ERR
MSGLs,i,o	Set Gain Level, where: <ul style="list-style-type: none"> • 's' is the desired source • 'i' is the desired input gain, (0-4): "0 : 0 dB "1 : -3 dB "2 : -6 dB "3 : -9 dB "4 : -12 dB • 'o' is the desired output gain, (0-6): "0 : 0 dB "1 : +3 dB "2 : +6 dB "3 : +9 dB "4 : + 12 dB "5 : + 15 dB "6 : + 18 dB 	Gain Status - or - ERR

RS-232 Controller Command Messages (Cont.)		
MSGLs,i,o	Set Gain Level, where: <ul style="list-style-type: none"> • 's' is the desired source • 'i' is the desired input gain, valid values are: <ul style="list-style-type: none"> 0: 0 dB 1: -3 dB 2: -6 dB 3: -9 dB 4: -12 dB • 'o' is the desired output gain, valid values are: <ul style="list-style-type: none"> 0: 0 dB 1: +3 dB 2: +6 dB 3: +9 dB 4: + 12 dB 5: + 15 dB 6: + 18 dB 	Gain Status - or - ERR
MGSTr	Get General Status, where: 'r' is the desired room, (1-64)	General Status - or - ERR
MSSTs,x	Set Source State, where: <ul style="list-style-type: none"> • 's' is the desired source, (1-8) • 'x' is the desired state, valid values are: <ul style="list-style-type: none"> 2: Pause 1: On 0: Off 	Source State Status - or - ERR
MCMDs,x	Send Source Command, where: <ul style="list-style-type: none"> • 's' is the desired source, (1-8) • 'x' is the desired command index, valid values depend on the source type. • 'y' is the play option for the Sirius internal tuner only. Other source types will ignore. (1=play, 0=browse) 	ACK - or - Sirius Channel Number (Sirius Type Only) - or - ERR
MSBLr,x	Set Room Balance, where: <ul style="list-style-type: none"> • 'r' is the desired room, (1-64) • 'x' is the balance value, valid values are: <ul style="list-style-type: none"> 0: balanced evenly 1...10: Full Left...10% Left 11...20: 10% Right... Full Right 	Balance Status - or - ERR
MGBLr	Get Room Balance, where: 'r' is the desired room, (1-64)	Balance Status - or - ERR
MDRG	Dissolve all Room Groupings	ACK - or - ERR
MGRSs	Get the Rooms currently listening to a source, where: 's' is the desired source, (1-8)	Source Grouping Status - or - ERR
MSPSs,n,p	Set the preset, where: <ul style="list-style-type: none"> • 's' is the desired source, (1-8) • 'n' is the desired preset, (1-10) • 'p' is the direct tuning string; it can be from 0 to 7 characters long and is translated as specified in the 'Send Source Direct Data' command: Zero length data will clear the preset 	Preset Status - or - ERR

RS-232 Controller Command Messages (Cont.)		
MGPSs,n	Get the preset, where: <ul style="list-style-type: none"> • 's' is the desired source, (1-8) • 'n' is the desired preset, (1-10) 	Preset Status - or - ERR
MSTPs	Get the source type, where: 's' is the desired source, valid values are 1-8	Source Type Status - or - ERR
MSSDs,d	Send Source Direct Data, where: <ul style="list-style-type: none"> • 's' is the desired source, valid values are 1-8 • 'd' is the direct tuning string, the meaning of the data depends on the source type: 0: undefined – direct data is not processed 1: AM/FM Tuner – station frequency; if FM then there will be a '.' in the frequency string 2: CD Changer – disk and track, in the format 'ddd.ttt' where 'ddd' is the disk and 'ttt' is the track 3: DVD Player – disk and track, in the format 'ddd.ttt' where 'ddd' is the disk and 'ttt' is the track 4: Satellite Receiver – 'ssss' where 'ssss' is the station number 5: Audio Server - disk and track, in the format 'ddd.ttt' where 'ddd' is the album and 'ttt' is the title 6: Other – direct data sent as received 7: Custom XM – 'sss' for channel 20: Internal AM/FM Tuner– station frequency; if FM then there will be a '.' in the frequency string 	Source Status - or - Sirius Radio Channel Number Status (Sirius Type Only) - or - ERR
MGSSs	Get Source Status, where: 's' is the desired source, (1-8)	Source Status - or - ERR
CSETh,m,s,M,D,Y,x	Set the Clock Time, where: <ul style="list-style-type: none"> • 'h' is the desired hour, (0-23) • 'm' is the desired minute, (0-59) • 's' is the desired second, (0-59) • 'M' is the Month, (01-12) • 'D' is the Date, (01-31) • 'Y' is the Year, (2000-2099) • 'x' is the day of the week, (MON-SUN) 	Clock Status - or - ERR
CGST	Get the Clock Time	Clock Status - or - ERR
MV++r	Increment Volume, where: 'rr' is the desired room, (1-64)	Volume Status - or - ERR
MV--r	Decrement Volume, where: 'r' is the desired room, (1-64)	Volume Status - or - ERR

Delta Audio Controller Status Messages

Controller Status Messages	
ERR	Error
ACK	Acknowledge Status
MVERx	Firmware Version Status, where 'x' is the current firmware version (4 digits)
MCFr,s,z	Configuration Status, where: <ul style="list-style-type: none"> • 'r' is the number of rooms connected, (2-6) • 's' is the number of sources connected, (4) • 'z' is the number of groups available, (r/2)
FNICxx	Num IIC Devices Status, where 'xx' denotes the number of IIC devices available in the MRC
FSICx,a,v,p,d	IIC Device Status, where: <p>'x' is the IIC device index, valid values range from 1 to the number of IIC devices as denoted in the 'Num IIC Devices Status'</p> <ul style="list-style-type: none"> • 'a' is the device ID (3 digits) • 'v' is the version (4 digits) • 'p' is the product ID (4 digits) • 'd' is a descriptive string for the device, the string is of variable length
MVLr,v	Volume Status, where: <ul style="list-style-type: none"> • 'r' denotes the room, (1-64) • 'v' denotes the volume setting, valid values are: <ul style="list-style-type: none"> 101: Mute 0...100: 0...-100 dB
MBSr,b	Bass Status, where: <ul style="list-style-type: none"> • 'r' denotes the room, (1-64) • 'b' denotes the bass level, valid values are: <ul style="list-style-type: none"> 0: level 1...10: -10...-1 dB 11...20: 1...10 dB
MTRr,t	Treble Status, where: <ul style="list-style-type: none"> • 'r' denotes the room, (1-64) • 't' denotes the bass level, valid values are: <ul style="list-style-type: none"> 0: level 1...10: -10...-1 dB 11...20: 1...10 dB
MSCr,s	Source Status, where: <ul style="list-style-type: none"> • 'r' denotes the room, (1-64) • 's' denotes the source, valid values are: <ul style="list-style-type: none"> 0: no source selected 1-8: for sources 1 to 8 selected

Controller Status Messages (Cont.)	
MGLs,i,o	<p>Gain Status, where:</p> <ul style="list-style-type: none"> • 's' denotes the source • 'i' denotes the input gain, valid values are: <ul style="list-style-type: none"> 0: 0 dB 1: -3 dB 2: -6 dB 3: -9 dB 4: -12 dB • 'o' denotes the output gain, valid values are: <ul style="list-style-type: none"> 0: 0 dB 1: +3 dB 2: +6 dB 3: +9 dB 4: + 12 dB 5: + 15 dB 6: + 18 dB
MBALr,x	<p>Balance Status, where:</p> <ul style="list-style-type: none"> • 'r' denotes the room, (1-64) • 'x' denotes the balance, valid values are: <ul style="list-style-type: none"> 0: balanced evenly 1...10: 100%... 10% Left 11...20: 10%... 100% Right
MGSTr,v,bb,t,s,r,z,l,p	<p>General Status, where:</p> <ul style="list-style-type: none"> • 'r' denotes the room, (1-64) • 'v' denotes the volume setting, valid values are: <ul style="list-style-type: none"> 101: Mute 100...0: -100...0 dB • 'b' denotes the bass level, valid values are: <ul style="list-style-type: none"> 0: level 1...10: -10...-1 dB 11...20: 1...10 dB • 't' denotes the treble level, valid values are: <ul style="list-style-type: none"> 0: level 1...10: -10...-1 dB 11...20: 1...10 dB • 's' denotes the source, valid values are 1-8 • 'r' denotes the SRS state, valid values are: <ul style="list-style-type: none"> 0: Off 1: Bass Boost 2: SRS 3D 3: Focus 4: WOW 5: SRS not available for this room • 'z' denotes the zone, valid values are: <ul style="list-style-type: none"> 0: not connected to a zone 1...32: zone ID • 'l' denotes the balance, valid values are: <ul style="list-style-type: none"> 0: balanced equally 1...10: 100% ... 10% Left 11...20: 10% ... 100% Right • 'p' denotes the privacy status, valid values are: <ul style="list-style-type: none"> 0: Off 1: On

Controller Status Messages (Cont.)	
MPRSs,n,p	<p>Preset Status, where:</p> <ul style="list-style-type: none"> • 's' is the source, valid values are 1-8 • 'n' is the preset, valid values are 1-10 • 'p' is the direct tuning string; it can be from 0 to 7 characters long and is translated as specified in the 'Send Source Direct Data' command: Zero length data is returned if no preset is set
MSTPs,t	<p>Source Type Status, where:</p> <ul style="list-style-type: none"> • 's' is the source, valid values are 1-8 • 't' is the source type, valid values are: <ul style="list-style-type: none"> 0: undefined 1: AM/FM Tuner 2: CD Changer 3: DVD Player 4: Satellite Receiver 5: Audio Server 6: Other 1 20: Internal AM/FM Tuner
MSSTs,p,x	<p>Source Status, where:</p> <ul style="list-style-type: none"> • 's' is the source, valid values are 1-8 • 'p' is the source state, valid values are: <ul style="list-style-type: none"> 0: Off 1: On 2: Paused 3: Mute off (Sirius module only) 4: Mute on (Sirius module only) 5: Sleep on (Sirius module only) • 'x' is a variable length data string that varies with the type of source: <ul style="list-style-type: none"> 0: undefined – p where: <ul style="list-style-type: none"> 1: AM/FM Tuner – b,m,f where: <ul style="list-style-type: none"> 'b' is the band: 1 = AM, 2 = FM 'm' is the mono/stereo status: 1 = mono, 0 = stereo 'f' is the currently tuned frequency (if it is known) (5 digits max) 2: CD Changer - none 3: DVD Player - none 4: Satellite Receiver - none 5: Audio Server - none 6: Other 1 – none 7: Custom XM – none 8: Internal Sirius Tuner - none 20: Internal AM/FM Tuner– b,m,s,ffff where: <ul style="list-style-type: none"> 'b' is the band: 1 = AM, 2 = FM 'm' is the mono/stereo status: 1 = mono, 0 = stereo 's' is the seek/tune status: '1' = seek, '0' = tune 'f' is the currently tuned frequency (5 digits max)
CSTh,m,s,M,D,Y,x	<p>Clock Status, where:</p> <ul style="list-style-type: none"> • 'h' is the desired hour, (0-23) • 'm' is the desired minute, (0-59) • 's' is the desired second, (0-59) • 'M' is the Month, (01-12) • 'D' is the Date, (01-31) • 'Y' is the Year, (2000-2099) • 'x' is the day of the week, (MON-SUN)

Source Command Codes

Source Command Codes referenced by Source Type and Command Index:

Source Command Codes								
Source Type	1	2	3	4	5	6	7	8
Internal Tuner	Seek Down	Seek Up	Stop Seek	Seek/Tune Toggle (only for Mi-Series)	Band	Mono/Stereo Toggle	Prev Preset	Next Preset
AM/FM Tuner	Seek Down	Seek Up			Band	Mono/Stereo Toggle	Prev Preset	Next Preset
CD Changer	Prev Track	Next Track	Prev Disc	Next Disc	Play		Prev Preset	Next Preset
DVD Player	Nav Down	Nav Up	Nav Left	Nav Right	Select	Menu	Prev Preset	Next Preset
Satellite	Channel Down	Channel Up			Select	Guide	Prev Preset	Next Preset
Audio Server	Previous	Next	Previous Page	Next Page	Play		Prev Preset	Next Preset
Other	Previous	Next	Left	Right	SEL	SEL+Hold	Prev Preset	Next Preset
Custom XM	UP	Down	Left	Right Preset	SEL Preset	SEL+Hold	Prev	Next

Troubleshooting

Overview

If you are reading this section, it's likely that something has gone wrong. You have installed the Delta system and tried to program but something just doesn't seem to be working right, or it's not working at all. Try working your way through this troubleshooting section to help isolate the problem.

Before Delta units leave the factory they are "burned in" and extensively tested to ensure proper operation. They should be in working condition when they arrive on site. Test all zones to collect enough information to localize your problem. Make note of similarities in issues across multiple zones. For instance, if you can power on each zone except #1, then you have a localized problem.

However, if the CD player doesn't work in any zone, then the issue is likely at the source component connections or with programming.

Troubleshooting is just a series of eliminating possibilities. If you discover that a problem exists, try eliminating the possibilities associated with it beginning with the most obvious like the power and audio connections. Then, individual connections (usually within the zone(s)) will be next.

Power Connections

Tracking down problems that are power related are somewhat easy because the unit either powers up or it doesn't. If it does not, there are several things to check.

1. Check to make sure you are attached to a functioning live electrical circuit. If the branch circuit is dead check the breaker or there may be a light switch controlling the power to the outlet. If it's on a switched circuit try to obtain power elsewhere.
2. Ensure that both ends of each power cord are firmly seated in all of the source components.
3. If you're plugged into power strips, check them for operation as well. Be aware these often have mini-breakers on them and you should check to ensure that power is functioning in EACH outlet.

It is not uncommon for the inexpensive power strips to fail at one plug-in but not the others.

4. There is a power switch located at the rear of the Delta Controller, check to see that it is in the ON or (I) position.
5. There is a fuse beside the power switch at the back of the Delta Controller. Remove the fuse and inspect it to see that it is intact. If you have an ohm meter, test for continuity across the fuse (sometimes they look good, but they're really broken near one of the ends). The fuse in the rear of the unit is a 5A 250V Slo Blo.

Source Unit Connections

Problems in source cabling can often be traced to symptoms where the source cannot be heard in any zone and/or when the source doesn't seem to respond to keypad commands.

1. Ensure that the source component's LINE OUT connections are connected to the Delta Controller's LINE IN connections for the correct device. These can sometimes be mismatched.
2. Take a look at the source component to ensure that MUTE functions have not accidentally been activated.
3. Check to see that the IR emitter lead is securely fastened to the IR receiver on the source component and that you have the lead plugged into the appropriate IR output jack. These can sometimes be mismatched. When a keypad command is received and communicated to the source device, there is a LED that lights on the front of the Delta Controller indicating the processing of the command. If

the LED does not light with a keypad press, then it is possible that the device has not been programmed. If the LED does light, there may be a problem with the IR emitter lead.

When testing IR problems, it is helpful to carry a blinking emitter or a test emitter to ensure that the commands are being sent to the source. Techniques you can use to help isolate a source's problem include swapping the source with another on the Delta Controller to see if the problem stays with the Controller or follows the movement of the source. Also try swapping IR emitter leads.

Zone Connection Problems

If there is wall power and both the source components and the Delta Controller seem to be powering up OK, but one or more of the zones are not working, there may be a problem at the individual zone or with the cabling connecting to the zone. Begin by checking each zone keypad for functionality by pressing the desired source button. The LED should light red next to the source on the KP-4e keypads or should “wake up” with a screen menu on the touch panel keypad.

No Keypad Activity (At All)

You are not getting power and command connectivity to the zone. Some of the possible causes are:

1. Zone connectors at the Delta Controller are not secure.
2. Connector in the wall at keypad to Delta Controller is not secure.
3. Wiring and connection directions not followed. Make certain the center two wires (DATA and GROUND) are in the same orientation at the Delta Controller and the keypad.
4. Connectors on keypad from Controller and speakers are reversed.
5. Keypad not recognized by system. Restart system.

Keypad Lights, No Sound

Power and command connectivity are getting to the zone. Check other zones and select each source to determine if this is specific to the source or the room in general. If the problem is in a particular room then there may be an issue with cabling to the speakers or it may be the keypad itself. If you get similar results for a particular source in multiple zones then there may be an issue with the source equipment and you should check to see that the selected source is ‘playing’. If every other zone is OK, check to make sure cables to the speakers are secure and that you have tried to increase the volume level in the zone.

Troubleshooting Quick Reference

Troubleshooting Quick Reference		
Symptom	Possible Causes	Refer to Section
Everything is dead, nothing works	No power to Delta Controller	Power
All keypads are dead	Cabling between Delta Controller and keypads is incorrect	Keypad Cabling
No lights on the keypad	Keypad connections reversed	Keypad Cabling
Some keypads OK, others are dead	<ul style="list-style-type: none"> • Cabling between Delta Controller and non working keypads is incorrect • Defective keypad • Defective cabling to keypad 	Keypad Cabling
Sources don't work manually OR automatically	No power to the source component(s)	Power
Sources and keypads work but no sound in zone	<ul style="list-style-type: none"> • Speakers not connected • Problem between keypad and speakers • Problem with speakers • Volume too low 	Keypad Cabling
Keypads work but no sound in zone	RCA cables from source either defective or not connected	Source Cabling
Sources work manually but keypads don't control device(s)	Device programming incomplete IR emitter lead missing IR emitter lead connected to the wrong device	Programming Source Cabling Restart System
Sources power OFF when selected	Program error in ON/OFF function	Programming
Sources don't start playing when selected	Program error in device power or control functions	Programming



It's Your World - Take Control™

3000 RESEARCH DRIVE, RICHARDSON, TX 75082 USA • 800.222.0193 • 469.624.8000 • 469-624-7153 fax • 800.932.6993 technical support • www.amx.com

7/08 ©2008 AMX. All rights reserved. AMX and the AMX logo are registered trademarks of AMX. AMX reserves the right to alter specifications without notice at any time.

Free Manuals Download Website

<http://myh66.com>

<http://usermanuals.us>

<http://www.somanuals.com>

<http://www.4manuals.cc>

<http://www.manual-lib.com>

<http://www.404manual.com>

<http://www.luxmanual.com>

<http://aubethermostatmanual.com>

Golf course search by state

<http://golfingnear.com>

Email search by domain

<http://emailbydomain.com>

Auto manuals search

<http://auto.somanuals.com>

TV manuals search

<http://tv.somanuals.com>