



1609 Industrial Uninterruptible Power Supply User Manual



Installation and Operation

Mount the UPS

This unit is designed to mount on a heavy duty DIN rail or on the back panel of an enclosure. For details on DIN rail installation refer to the DIN rail installation guide included in the DIN rail package. The DIN rail kit is not included.

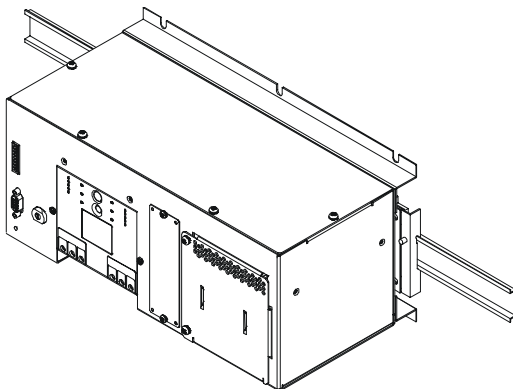

When mounting on the back panel of an enclosure, select screws that are appropriate for the weight of this unit and the mounting surface material.

Six screws must be used when mounting this unit in an enclosure. Three screws in the top of the bracket and three screws in the bottom of the bracket. Failure to follow these instructions may result in damage to the unit.

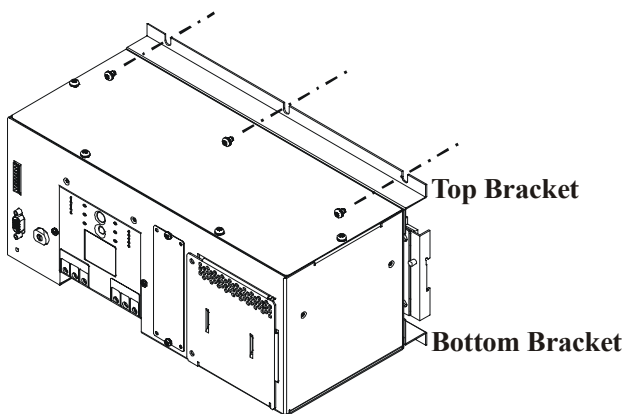

Battery Installation

The UPS battery is shipped in a separate carton.

Refer to the installation guide included with the replacement battery for installation instructions.

Front Panel

120 V model depicted.

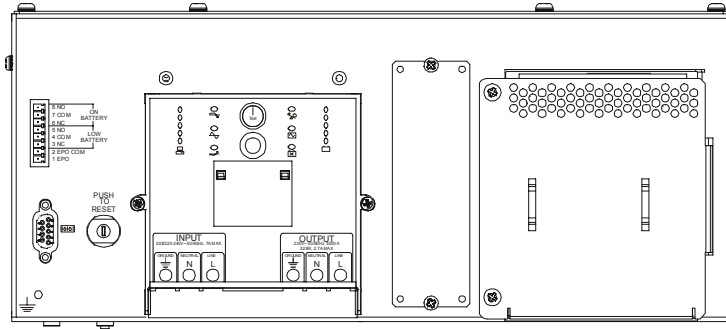

Connect Power and Equipment to the UPS

Hardwiring should be performed by a qualified electrician. Use appropriate size wires.

1. The UPS features a transient voltage surge-suppression (TVSS) screw  located on the front panel. The TVSS screw is used for connecting the ground lead on surge suppression devices such as telephone and network line protectors.

Prior to connecting the grounding cable, ensure that the UPS is NOT connected to utility or battery power.

2. Hardwire the UPS.
 - In 230 V applications the UPS must be protected with a circuit breaker that complies with European standards for branch rated protection per the country of installation.
 - In 208 V applications, the 1609-U500E must be protected by a dual pole, 10 A branch rated circuit breaker with UL489 rating.
 - The 120 V 1609-U500N has supplementary circuit breaker protection. The unit should be protected by a single pole, 15 A branch rated circuit breaker with a UL489 rating. Allen-Bradley part number 1492-MCAA115 is suggested. **Ensure that the branch circuit breaker is off prior to wiring the unit.**

120 V
models

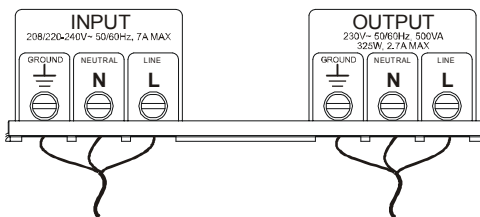

208/230 V
models

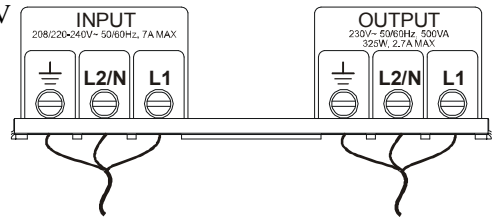

3. Connect equipment to the UPS.
4. Add optional accessories to the SmartSlot located on the front panel.
5. Turn on all connected equipment. To use the UPS as a master on/off switch, be sure all connected equipment is switched on.
6. Press the  button on the front panel to start the UPS.
 - The battery charges to 90% capacity during the first four hours of normal operation.
 - *Do not* expect full battery run capability during this initial charge period.
7. For optimal computer system security, install PowerChute® monitoring software included with the UPS.

Connectors

Communication Port

SERIAL PORT



A standard serial interface cable is incompatible with the UPS. Use the cable supplied with the unit.

Contact Closure Port

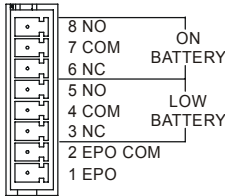

The relays are connected from the common (COM) to the normally closed (NC) pins. When the unit enters a low battery or on battery state, the appropriate relay will transition and connect the common (COM) to the normally open (NO) pin.

The Contact Closure Port connection will automatically disable when a Network Management Card or the Serial Port connection are used.

Output Contact Ratings:

Parameter	Value
nominal switching capacity	1 A @ 30 VDC
maximum switching power	30 W
maximum switching voltage	60 VDC
maximum switching current	2 ADC
maximum carrying current	2 ADC
surge ratings	2 kV per Bellcore TA-NWT-001089 1.5 kV per FCC part 68

Emergency Power Off

The emergency power off (EPO) feature is user configurable. EPO provides immediate de-energizing of connected equipment from a remote location, without switching to battery operation.

Use a normally-open contact to connect the EPO COM terminal to the EPO terminal.

The EPO interface is a Safety Extra Low Voltage (SELV) circuit. Connect it only to other SELV circuits. The EPO interface monitors circuits that have no determined voltage potential. Such closure circuits may be provided by a switch or relay properly isolated from the utility. To avoid damage to the UPS, do not connect the EPO interface to any circuit other than a closure type circuit.

Use one of the following cable types to connect the UPS to the EPO switch.

- CL2: Class 2 cable for general use.
- CL2P: Plenum cable for use in ducts, plenums, and other spaces used for environmental air.
- CL2R: Riser cable for use in a vertical run in a floor-to-floor shaft.
- CLEX: Limited use cable for use in dwellings and for use in raceways.
- For installation in Canada: Use only CSA certified, type ELC (extra-low voltage control cable).
- For installation in other countries: Use standard low-voltage cable in accordance with national and local regulations.

Operation

UPS Display Panel

120 V
models

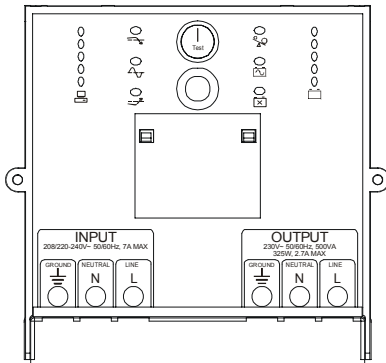



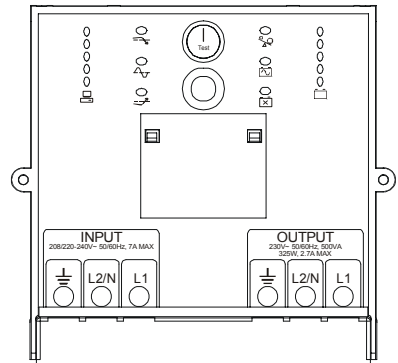





208/230 V
models



Display Panel Indicators and Function Buttons

Indicator LED	Indicator Title	Description
	On-Line	The UPS is supplying utility power to the connected equipment (see <i>Troubleshooting</i>).
	AVR Trim	The UPS is compensating for a high utility voltage (see <i>Troubleshooting</i>).
	AVR Boost	The UPS is compensating for a low utility voltage (see <i>Troubleshooting</i>).
	On Battery	The UPS is supplying battery power to the connected equipment.
	Overload	The connected equipment is drawing more than the UPS power rating allows (see <i>Troubleshooting</i>).
	Replace Battery/Battery Disconnected	The battery is disconnected or must be replaced (see <i>Troubleshooting</i>).

<p>120V 230V</p> <p>○ 133 ○ 266</p> <p>○ 123 ○ 248</p> <p>○ 114 ○ 229</p> <p>○ 105 ○ 210</p> <p>○ 96 ○ 191</p> <p>Battery Charge </p>	<p>Diagnostic Utility Voltage</p>	<p>The UPS has a diagnostic feature that indicates the utility voltage. The UPS starts a self-test as part of this procedure. The self-test does not affect the voltage display.</p> <p>Press and hold the  button to view the utility voltage bar graph indicator.</p> <p>After a few seconds, this five-LED <i>Battery Charge</i>  indicator on the right of the display panel will show the utility input voltage.</p> <p>Refer to the figure on the left for the voltage reading (values are not listed on the UPS).</p> <p>The indicator on the UPS shows the voltage is between the displayed value on the list and the next higher value (see <i>Troubleshooting</i>).</p>
---	-----------------------------------	---

Feature Button	Feature Title	Function
	Power On	Press this button to turn on the UPS. Continue reading for additional capabilities.
	Power Off	Press this button to turn off the UPS.
	Self-Test	<p>Automatic: The UPS performs a self-test automatically when tuned on, and every two weeks thereafter (by default). During the self-test, the UPS briefly operates the connected equipment on battery.</p> <p>Manual: Press and hold the  button for a few seconds to initiate the self-test.</p>
	Cold Start	When there is no utility power and the UPS is off, the cold start feature will switch the UPS and connected equipment onto battery power (see <i>Troubleshooting</i>).

User Configurable Items

UPS settings

Settings are adjusted through PowerChute® software or optional Network Management Card.

Function	Factory Default	User Selectable Choices	Description
Automatic Self-Test	Every 14 days (336 hours)	<ul style="list-style-type: none"> • Every 7 days (168 hours) • On start up only • No self-test 	Set the interval at which the UPS will execute a self-test.
UPS ID	UPS_IDEN	Up to eight characters (alphanumeric)	Uniquely identify the UPS (i.e. server name or location) for network management purposes.
Date of Last Battery Replacement	Manufacture Date	mm/dd/yy	Reset this date when you replace the battery module.
Minimum Capacity Before Return from Shutdown	0 percent	<ul style="list-style-type: none"> <li style="width: 50%;">• 0% <li style="width: 50%;">• 60% <li style="width: 50%;">• 15% <li style="width: 50%;">• 75% <li style="width: 50%;">• 30% <li style="width: 50%;">• 90% <li style="width: 50%;">• 45% 	Specify the percentage to which batteries will be charged following a low battery shutdown before powering connected equipment.
Voltage Sensitivity	High sensitivity	High sensitivity Medium sensitivity Low sensitivity	<p>The UPS detects and reacts to line voltage distortions by transferring to battery operation to protect the connected equipment.</p> <p>In situations of poor power quality, the UPS may frequently transfer to battery operation. If the connected equipment can operate normally under such conditions, reduce the sensitivity setting to conserve battery capacity and service life.</p>
Alarm Delay Control	Enable	<ul style="list-style-type: none"> • Enable • Mute • Disable 	Mute ongoing alarms or disable all alarms permanently.
Shutdown Delay	90 seconds	<ul style="list-style-type: none"> <li style="width: 50%;">• 0 s <li style="width: 50%;">• 360 s <li style="width: 50%;">• 90 s <li style="width: 50%;">• 450 s <li style="width: 50%;">• 180 s <li style="width: 50%;">• 540 s <li style="width: 50%;">• 270 s <li style="width: 50%;">• 630 s 	Set the interval between the time when the UPS receives a shutdown command and actual shutdown.

Function	Factory Default	User Selectable Choices	Description
Low Battery Warning	2 minutes	2, 5, 8, 11, 14, 17, 20, 23 minutes	PowerChute software interface provides automatic, unattended shutdown when approximately two minutes of battery operated run time remains. The low-battery warning beeps are continuous when two minutes of run time remain. Change the low battery warning interval setting to the time that the operating system or system software requires to safely shut down.
Synchronized Turn-on Delay	0 seconds	<ul style="list-style-type: none"> • 0 s • 60 s • 120 s • 180 s <ul style="list-style-type: none"> • 240 s • 300 s • 360 s • 420 s 	Specify the time the UPS will wait after the return of utility power before start up (to avoid branch circuit overload).
High Transfer Point	<p><i>120 V models:</i> 127 VAC</p> <p><i>230 V models:</i> 253 VAC</p>	<ul style="list-style-type: none"> • 127 VAC • 130 VAC • 253 VAC • 257 VAC <ul style="list-style-type: none"> • 133 VAC • 136 VAC • 261 VAC • 265 VAC 	To avoid unnecessary use of the battery where utility voltage is chronically high, set the high transfer point higher if the connected equipment can tolerate this condition.
Low Transfer Point	<p><i>120 V models:</i> 106 VAC</p> <p><i>230 V models:</i> 208 VAC</p>	<ul style="list-style-type: none"> • 97 VAC • 100 VAC • 196 VAC • 200 VAC <ul style="list-style-type: none"> • 103 VAC • 106 VAC • 204 VAC • 208 VAC 	<p>To avoid unnecessary use of the battery where utility voltage is chronically low, set the low transfer point lower if the connected equipment can tolerate this condition.</p> <p>The 1609-U500E ships ready for 230 V sources. When operating the UPS in 208 V applications, the UPS low transfer voltage settings are adjusted through PowerChute software or the Network Management Card. The proper setting for low transfer voltage is 196 V.</p> <p>Refer to the PowerChute user guide or the Network Management Card instructions for setting adjustment details.</p>
Output Voltage 230 V models	230 VAC	<ul style="list-style-type: none"> • 220 VAC • 230 VAC <ul style="list-style-type: none"> • 240 VAC 	<i>230 V models only:</i> Sets the output voltage of the UPS while operating on battery.

Storage, Maintenance, Transport

Storage

Store the UPS covered in a cool, dry location with the batteries fully charged.

At 5° to 86° F (–15° to 30° C), charge the UPS battery every six months.

At 86° to 113° F (30° to 45° C), charge the UPS battery every three months.

Replacing the Battery Module

This UPS has an easy-to-replace, hot-swappable battery module. Replacement is a safe procedure, isolated from electrical hazards. You may leave the UPS and connected equipment on during the replacement procedure.

Ensure battery replacement every 2-4 years.

Standard (40C) battery; Allen-Bradley catalog number: 1609-500SBAT.

High Temperature (50C) battery; Allen-Bradley catalog number: 1609-500HBAT.

Once the batteries are disconnected the connected equipment is not protected from power outages.



Refer to the appropriate replacement battery installation guide for battery module installation instructions. See your dealer or contact Rockwell Automation at 440-646-5800 for information on replacement battery modules.



Be sure to deliver the spent battery(s) to a recycling facility or ship it to the address specified in the replacement battery literature.

Troubleshooting

Use this chart to solve minor installation and operation problems. Refer to Rockwell Automation Tech Support at 440-646-5800 for further support.

Problem and/or Possible Cause	Solution
UPS will not turn on	
The battery is not connected properly.	Check that the battery connector is fully engaged.
 button not pushed.	Press the  button once to power-up the UPS and connected equipment.
The UPS is not connected to utility power supply.	Check that the UPS is properly connected to utility power.
UPS will not turn off	
The UPS is experiencing an internal fault	Do not attempt to use the UPS. Unplug the UPS and have it serviced immediately.
UPS beeps occasionally	
Normal UPS operation when running on battery.	None: The UPS is protecting the connected equipment. Press the  button to silence this alarm.
UPS is not providing expected backup time	
The UPS battery(s) are weak due to a recent power outage or battery(s) are near the end of their service life.	Charge the battery(s). Batteries require recharging after extended outages. Batteries can wear faster when put into service often or when operated at elevated temperatures. If the battery(s) are near the end of their service life, consider replacing the battery(s) even if the <i>replace battery</i> LED is not yet illuminated.
Left half, Right half, or Center section of front panel is flashing	
The UPS is experiencing an internal fault.	Do not attempt to use the UPS. Unplug the UPS and have it serviced immediately.
All LEDs are illuminated and the UPS emits a constant beeping	
The UPS is experiencing an internal fault.	Do not attempt to use the UPS. Unplug the UPS and have it serviced immediately.
Front panel LEDs flash sequentially	
The UPS has been shut down remotely through software or an optional accessory card.	None: The UPS will restart automatically when utility power returns.

Problem and/or Possible Cause	Solution
All LEDs are off and the UPS is wired to input utility power	
The UPS is shut down or the battery is discharged from an extended outage.	None: The UPS will restart automatically when utility power is restored and the battery has a sufficient charge.
The Overload LED is illuminated and the UPS emits a sustained alarm tone	
The UPS is overloaded.	<p>The connected equipment exceeds the specified “maximum load” as defined in <i>Specifications</i> listed on the rating label located on the UPS.</p> <p>The alarm remains on until the overload is removed. Disconnect nonessential equipment from the UPS to eliminate the overload condition.</p> <p>The UPS continues to supply power as long as it is online and the circuit breaker does not trip; the UPS will not provide power from batteries in the event of a utility voltage interruption.</p>
The Replace Battery/Battery Disconnected LED is illuminated	
The <i>Replace Battery/Battery Disconnected</i> LED flashes and a short beep is emitted every two seconds to indicate the battery is disconnected.	Check that the battery connectors are fully engaged.
Weak battery	Allow the battery to recharge for 24 hours and perform a self-test. If the problem persists after recharging, replace the battery.
Failure of a battery self-test: <i>Replace Battery/Battery Disconnected</i> LED illuminates and the UPS emits short beeps for one minute. The UPS repeats the alarm every five hours.	<p>Allow the battery to recharge for 24 hours. Perform the self-test procedure to confirm the replace battery condition. The alarm stops and the LED clears if the battery passes the self-test.</p> <p>If the battery fails again, it must be replaced. The connected equipment is unaffected.</p>
The input circuit breaker trips	
The connected equipment exceeds the specified “maximum load” as defined in <i>Specifications</i> listed on the rating label located on the UPS.	<p>Unplug all nonessential equipment from the UPS.</p> <p>Reset the circuit breaker.</p>
The AVR Boost or AVR Trim LEDs are illuminated	
The system is experiencing very high or low utility voltage.	Have a qualified service personnel check your facility for electrical problems. If the problem persists, contact the utility company for further assistance.

Problem and/or Possible Cause	Solution
There is no utility power	
There is no utility power and the UPS is off	<p>Use the cold start feature to supply power to the connected equipment from the UPS battery(s).</p> <p>Press and hold the  button. The unit will emit two beeps, one short beep and one long beep. Release the button during the second beep.</p>
UPS operates on battery although line voltage exists	
The UPS input circuit breaker trips.	<p>Unplug all nonessential equipment from the UPS.</p> <p>Reset the circuit breaker.</p>
Your system is experiencing very high, low or distorted line voltage.	<p>Move the UPS to a different outlet on a different circuit: Inexpensive fuel powered generators may distort the voltage. Test the input voltage with the utility voltage display, (see <i>Operation</i>). If acceptable to the connected equipment, reduce the UPS sensitivity.</p>
Battery Charge and Load LEDs flash simultaneously	
<p>The UPS has shut down</p> <p>The internal temperature of the UPS has exceeded the allowable threshold for safe operation.</p>	<p>Check that the room temperature is within the specified limits for operation.</p> <p>Check that the UPS is properly installed, allowing for adequate ventilation.</p> <p>Allow the UPS to cool down. Restart the UPS. If the problem persists, contact Rockwell Automation at 440-646-5800.</p>
Diagnostic utility voltage	
All five LEDs are illuminated.	The line voltage is extremely high and should be checked by an electrician.
There is no LED illumination.	If the UPS is plugged into a properly functioning utility power outlet, the line voltage is extremely low and should be checked by an electrician.
On-Line LED	
There is no LED illumination.	The UPS is running on battery, or it must be turned on.
The LED is blinking.	The UPS is running an internal self-test.
Software/Network integration problems	
Network Management Card difficulties.	Refer to the Network Management Card user guide on the CD shipped with the Network Management Card.
Communication problems between the UPS and PowerChute software.	<p>Ensure the correct communication cable (940-1524C) is being used.</p> <p>Refer to the PowerChute user manual on the CD shipped with the software.</p>

Service and Contact Information

Service

If the UPS requires service do not return it to the dealer. Follow these steps:

1. Review the problems discussed in *Troubleshooting* to eliminate common problems.
2. If the problem persists, contact Rockwell Automation Customer Support.
 - If the product is determined to be defective, contact the distributor for typical return procedures.
 - Retain the battery and the Network Management Card (when available).
3. Pack the UPS in its original packaging.
 - Pack the UPS properly to avoid damage in transit. Never use Styrofoam beads for packaging. Damage sustained in transit is not covered under warranty.
 - **Always DISCONNECT THE BATTERY before shipping in compliance with U.S. Department of Transportation (DOT) and IATA regulations.** The battery may remain in the UPS.

Contact Rockwell Automation

Refer to Rockwell Automation at 440-646-5800.

Safety Information - SAVE THIS GUIDE

This Safety Guide contains important instructions that should be followed during installation and maintenance of the equipment and batteries. It is intended for customers who setup, install, relocate, or maintain equipment.

Changes and modifications to this unit not expressly approved could void the warranty.

Handling Safety



<18 kg (<40 lb)



32–55 kg (70–120 lb)



18–32 kg (40–70 lb)



>55 kg (>120 lb)



>10°

CAUTION! Electrical Safety

- Do not work alone under hazardous conditions.
- High current through conductive materials could cause severe burns.
- Check that the power cord(s), plug(s), and sockets are in good condition.
- Use qualified service personnel to change the plug on the UPS and to install permanently wired equipment.
- When grounding cannot be verified, disconnect the equipment from the utility power outlet before installing or connecting to other equipment. Reconnect the power cord only after all connections are made.
- Do not handle any metallic connector before the power has been disconnected.
- Connect the equipment to a three wire utility outlet (two poles plus ground). The receptacle must be connected to appropriate branch circuit/mains protection (fuse or circuit breaker). Connection to any other type of receptacle may result in risk of electrical shock.
- *230V models only:* In order to maintain compliance with the Electro Magnetic Compliance directive for products sold in Europe, output cords attached to the UPS should not exceed 10 meters in length.
- *230V models only:* Total leakage current from connected equipment and the UPS must not exceed 3.5 mA for a pluggable A Type UPS.

CAUTION! Deenergizing Safety

- If the UPS has an internal energy source (battery), the output may be energized when the unit is not connected to a utility power outlet.
- To deenergize a **pluggable UPS**, press the OFF button or switch to shut the equipment off. Unplug the UPS from the utility power outlet. Disconnect the external batteries where applicable and disconnect the internal battery (see User Manual). Push the ON button to deenergize the capacitors.
To deenergize a **permanently wired UPS**, press the OFF button or switch to shut the equipment off. Switch off the utility circuit breaker that supplies power to the UPS. Disconnect the external batteries where applicable and disconnect the internal battery (see User Manual).

WARNING! Battery Safety

- **This equipment contains potentially hazardous voltages.** Do not attempt to disassemble the unit. The **only exception** is for a UPS containing batteries. Refer to the battery replacement procedures detailed in the User's Manual. Except for the battery, the unit contains no user serviceable parts. **Repairs are to be performed only by qualified service personnel.**
- Do not dispose of batteries in a fire. The batteries may explode.
- Do not open or mutilate batteries. They contain an electrolyte that is toxic and harmful to the skin and eyes.
- To avoid personal injury due to energy hazard, remove wrist watches and jewelry such as rings when replacing the batteries. Use tools with insulated handles.
- Replace batteries with the same number and type of batteries as originally installed in the equipment.

Replacement and Recycling of Batteries

See your dealer or contact Rockwell Automation at 440-646-5800, for information on replacement battery kits and battery recycling.



Be sure to deliver the spent battery to a recycling facility in the replacement battery packing material.

Free Manuals Download Website

<http://myh66.com>

<http://usermanuals.us>

<http://www.somanuals.com>

<http://www.4manuals.cc>

<http://www.manual-lib.com>

<http://www.404manual.com>

<http://www.luxmanual.com>

<http://aubethermostatmanual.com>

Golf course search by state

<http://golfingnear.com>

Email search by domain

<http://emailbydomain.com>

Auto manuals search

<http://auto.somanuals.com>

TV manuals search

<http://tv.somanuals.com>