

TABLE OF CONTENTS

TYPICAL INSTALLATION	2
INSTALLATION	3-5
Local Codes	3
Temperature-Pressure Relief Valve	3
Closed System	3
Locating the Solar Water Heater	3-4
Water Piping	4-5
Filling the Solar Water Heater	5
Wiring of Elements	5
Thermostat	5
OPERATION	6-7
Temperature Regulation	7
Temperature Settings	6
Temperature Adjusting	6
Resetting High Limit (Temperature) Shut Off System	6-7
MAINTENANCE	7-8
Draining	7
Element	7
Element Replacement	7
Anode	7-8
Water Heater Sounds	8
Repair Parts Illustration and Schedule	8

TYPICAL INSTALLATION

Check all connections for leaks. Consult the local utility company to examine installation for propriety and safety.

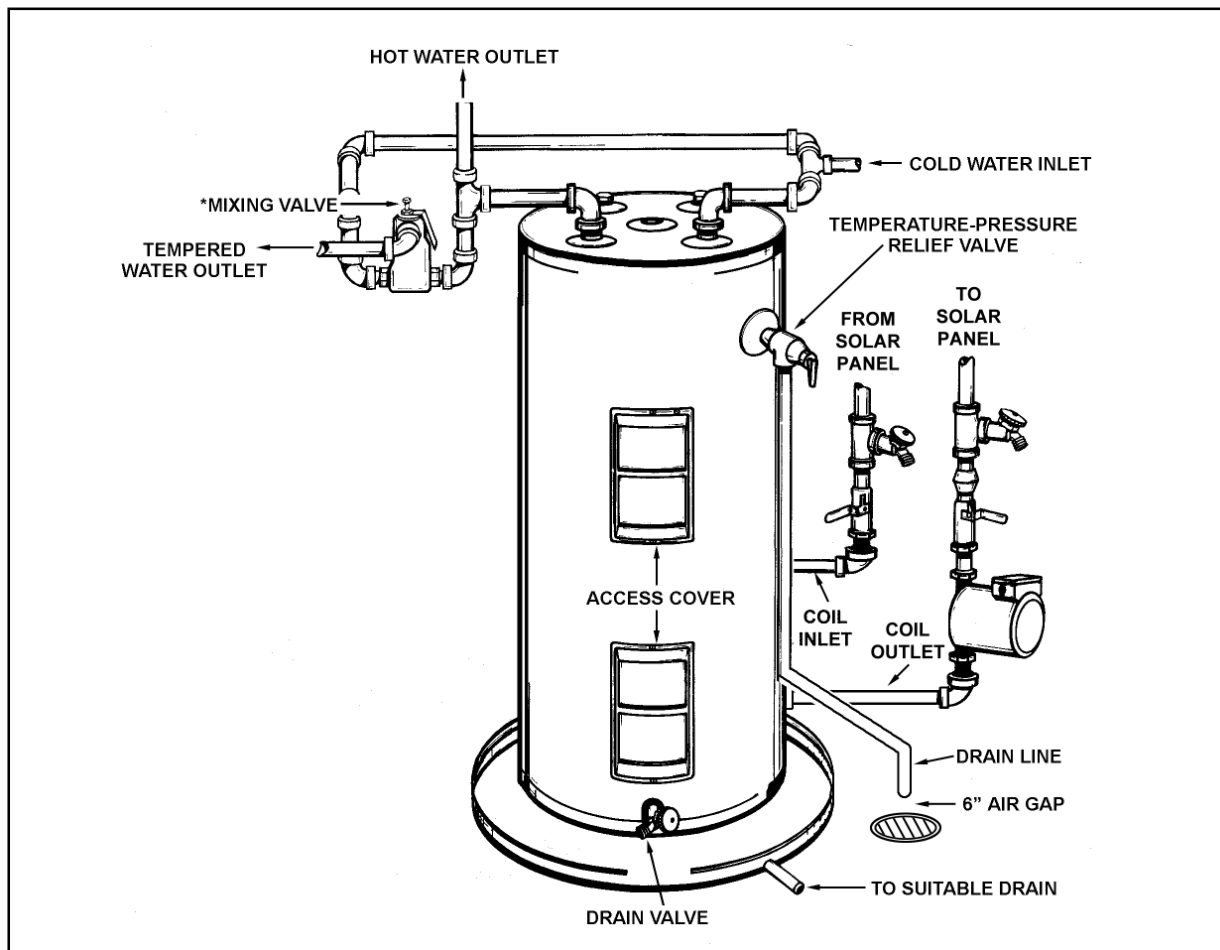

FIGURE 1

INSTALLATION

WARNING

Never operate the electrical heating element without being certain the solar water heater is completely filled with water. If any air is left in the top of the tank, the heating element will burn out.

LOCAL CODES

The installation of solar water heater must be in accordance with these instructions and all applicable local codes and electric utility requirements. In the absence of local codes, install in accordance with the latest edition of the National Electrical Code (NFPA-70).

TEMPERATURE-PRESSURE RELIEF VALVE

WARNING

For protection against excessive pressures and temperatures in this water heater, install temperature-pressure protective equipment required by local codes, but not less than a combination temperature-pressure relief valve certified by a nationally recognized testing laboratory that maintains periodic inspection of production of listed equipment or materials, as meeting the requirements for Relief Valves for Hot Water Supply Systems, the latest edition of ANSI Z21.22. This valve must be marked with a maximum set pressure not to exceed the marked hydrostatic working pressure of the water heater (150 lbs./sq. in.).

Install the temperature-pressure relief valve directly into the fitting of the water heater. Position the valve downward and provide tubing so that any discharge will exit only within 6 inches above, or at any distance below the structural floor. Be certain that no contact is made with any live electrical part. The discharge opening must not be blocked or reduced in size under any circumstances. Excessive length, over 15 feet, or use of more than two elbows can cause restriction and reduce the discharge capacity of the valve.

No valve or other obstruction is to be placed between the temperature-pressure relief valve and the tank. Do not connect tubing directly to discharge drain unless a 6" air gap is provided. To prevent bodily injury, hazard to life or damage to property, the temperature-pressure relief valve must be allowed to discharge water in quantities should circumstances demand. If the discharge pipe is not connected to a drain or other suitable means, the water flow may cause property damage.

The Discharge Pipe:

- Shall not be smaller in size than the outlet pipe size of the temperature-pressure relief valve, or have any reducing couplings or other restrictions.
- Shall not be plugged or blocked.
- Shall be of material listed for hot water distribution.
- Shall be installed so as to allow complete drainage of both the temperature-pressure relief valve, and the discharge pipe.
- Must terminate a maximum of six inches above a floor drain or external to the building. In cold climates, it is recommended that the discharge pipe be terminated at an adequate drain inside the building.
- Shall not have any valve between the relief valve and tank.

When installing the temperature-pressure relief valve, use two or three turns of teflon tape or other suitable thread sealer around the threaded end of the valve.

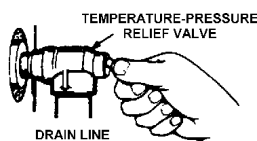

FIGURE 2

WARNING

The temperature-pressure relief valve should be manually opened once a year. Caution should be taken to ensure that (1) no one is in front of or around the outlet of the temperature-pressure relief valve discharge line, and (2) the water manually discharged will not cause any bodily injury or property damage because the water may be extremely hot.

If after manually operating the valve, it fails to completely reset and continues to release water, immediately close the cold water inlet to the water heater, follow the draining instructions, and replace the temperature-pressure relief valve with a new one.

WARNING

If the temperature-pressure relief valve on the appliance weeps this may be due to thermal expansion. The water supply serving this solar water heater may have a check valve installed. Contact the water supplier or local plumbing contractor on how to control this situation. Do not plug the temperature-pressure relief valve.

CLOSED SYSTEM

CAUTION

A closed system will exist if a check valve (without bypass), pressure reducing valve (without bypass), or a water meter (without bypass) is installed in the cold water line between the water heater and street main (or well).

Excessive pressure may develop causing premature tank failure or intermittent relief valve operation. This type of failure is not covered by the limited warranty. An expansion tank or a similar device may be required in the inlet supply line between the appliance and the meter or valve to compensate for the thermal expansion of water under supply pressure.

If a water heater is installed in a closed water system, check local codes or contact the water supplier or local plumbing inspector on how to control this situation.

LOCATING THE SOLAR WATER HEATER

If you have a choice of where to install the solar water heater, these ideas may help you decide.

1. Put the solar water heater indoors as close as possible to where you use the most hot water. This water heater is not intended for outdoor installation.
2. It is handy to have a floor drain, tub or sink nearby. That will make it easy to drain water from the water heater. It is also a good place to end the drain line of the temperature-pressure relief (T & P) valve.
3. The solar water heater or the pipes and the connections may, in time, leak. Put the solar water heater in a place where a water leak will not damage anything.
4. You must not put the water heater in an area where it might freeze. You must turn off the electricity to the water heater before you drain it, to protect the heating elements.
5. Make sure that you are able to reach the drain valve and all access panels when the water heater is in place. This will make it easy to service the water heater.
6. The water heater must be level before you begin the piping.

CAUTION

WATER HEATERS EVENTUALLY LEAK. The installation of the water heater must be accomplished in such a manner that if the tank or any connections should leak, the flow of water will not cause

damage to the area adjoining the water heater or to lower floors of the structure. When such locations can't be avoided, a suitable drain pan should be installed under the water heater. Such a pan should be no greater than 1 1/2 inches deep, have a minimum length and width of at least two inches greater than the heater dimensions and must be piped to an adequate drain.

⚠ CAUTION

This solar water heater, as all water heaters, will eventually leak. Do not install without adequate drainage provisions where water flow will cause damage. Note: normal condensation from a solar water heater may appear to be a leaking tank.

WATER PIPING

This solar water heater is design certified to be used with a potable water system. When connecting water piping with solder joints use only lead free solder.

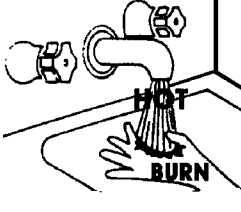
<p>⚠ DANGER</p> 	<p>Untempered hot water can cause severe burns instantly resulting in severe injury or death.</p> <p>Children, elderly, and the physically or mentally disabled are at highest risk for scald injury.</p> <p>Feel water before bathing or showering.</p> <p>Temperature limiting valves are available.</p>
---	--

⚠ WARNING

The indirect coil in this unit is a single wall and may only be used in a closed loop - fill only with a mixture of propylene glycol containing corrosion inhibitors (such as Dowfrost™ HD) (50% by volume maximum) and distilled or de-mineralized water. Never fill with a toxic liquid. Use of any heat transfer fluid other than that specified or failure to operate the heat exchanger in a closed loop will void the warranty, and may result in poor performance, equipment damage, or risk to health and safety.

⚠ WARNING

This solar water heater shall not be connected to any heating systems or component(s) previously used with a non-potable water heating appliance.

If this solar water heater is also used for space heating applications, all piping and components connected to the solar water heater shall be suitable for use with potable water.

This appliance has been design certified as a solar water heater complying with Standards for Safety - UL174 for the U.S. and can/csa-c22.2 No 110 F379.1 and F379.2 FOR Canada. The particular application of this appliance described (above paragraph) may be subject to review and approval by local code officials.

⚠ WARNING

Toxic chemicals such as used for treatment of boilers or non-potable water heating appliances shall never be introduced into a potable water space heating system.

⚠ WARNING

When the system requires water at temperatures higher than required for other uses, a means such as a mixing valve shall be installed to temper the water for those uses in order to reduce scald hazard potential. Mixing valves are available at plumbing supply or hardware stores. Follow manufacturer's instructions for installation of these valves.

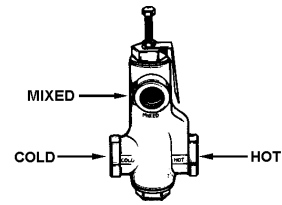

FIGURE 3

The solar water heater will work better if you keep the hot water runs short. You will also get hot water faster and with less heat loss.

The illustration shows the correct valves and fittings that you will need to install the solar water heater. Threaded (3/4") water connections are supplied through the tank top.

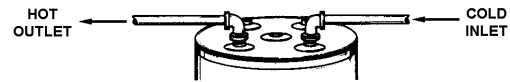

FIGURE 4

1. Buy the fittings that you need to connect the pipes. Remember that you have to connect both the hot and cold water pipes.
2. Apply a light covering of pipe joint compound to each outside thread before making connection.
3. Connect the cold water supply pipe to the cold water inlet of your solar water heater as follows:
 - a. Look at the top cover of the solar water heater. The hot and cold connections are marked there.
 - b. A non-metallic dip tube is supplied to carry cold water from the tank top to the bottom. Be sure that it is in the cold water inlet.
 - c. If using copper tubing, solder tubing to an adapter BEFORE you attach the adapter to the cold water inlet. DO NOT solder the cold water supply pipe directly to the cold water inlet connection. It might harm the dip tube.
 - d. The cold water supply line must have a shut-off valve and union.
4. Use a union to connect the hot water supply pipe to the solar water heater's hot water outlet.

⚠ CAUTION

Operating an empty or partially filled solar water heater will result in damage to the tank.

If a solar water heater is installed in a closed water system; such as one having a back flow preventer, check valve or water meter with check valve in the cold water supply line, means shall be provided to control thermal expansion. Contact the water supplier or local plumbing contractor on how to control this situation.

⚠ WARNING
INSTALLATION IN RESIDENTIAL GARAGES: The solar water heater must be located and/or protected so it is not subject to physical damage by a moving vehicle.

FILLING THE SOLAR WATER HEATER WITH WATER

1. Close the solar water heater drain valve. The drain valve is on the lower front of the solar water heater.
2. Open the cold water supply to the solar water heater. NOTE: THIS VALVE MUST BE LEFT OPEN WHEN THE SOLAR WATER HEATER IS IN USE.
3. Fill the solar water heater until water runs out an opened hot water faucet. This will let out air in the solar water heater and the piping. Close the faucet after the water comes out. You must not turn the electricity on until the solar water heater is full of water. IF ANY AIR IS LEFT IN THE TOP OF THE SOLAR WATER HEATER, THE TOP HEATING ELEMENT WILL BURN OUT RIGHTAWAY.
4. Check all the new water piping for leaks. Fix as needed.

WIRING OF ELEMENT

Determine voltage and wattage from the rating plate attached to the solar water heater. All external wiring, connection, and overcurrent protective devices must be provided and installed in accordance with the latest edition of the National Electrical Code, local codes, and local utility requirements. The solar water heater must be electrically "grounded" by the installer. A green ground screw has been provided on the solar water heater's junction box.

The grounding electrode conductor shall be of copper, aluminum, or copperclad aluminum. The material shall be resistant to corrosion, and shall be of one continuous length without a splice or joint.

Rigid metal conduit, intermediate metal conduit, or electrical metallic tubing may be used for the grounding means if conduit or tubing is terminated in fittings approved for grounding.

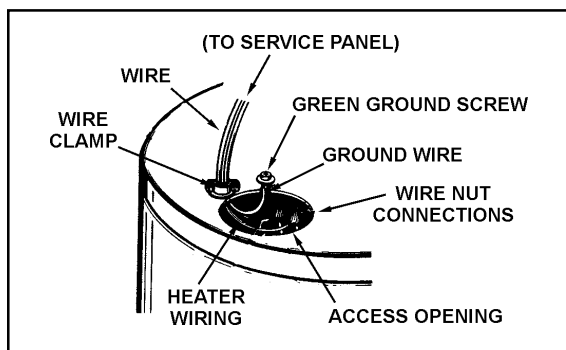

FIGURE 5

Flexible metal conduit or flexible metallic tubing shall be permitted for grounding if all the following conditions are met:

1. The length in any ground return path does not exceed 6 feet.
2. The circuit conductors contained therein are protected by overcurrent devices rated at 20 amperes or less.

3. The conduit or tubing is terminated in fittings approved for grounding.

⚠ WARNING

Never use this solar water heater unless it is completely full of water.

⚠ WARNING

SOLAR WATER HEATERS EQUIPPED FOR ONE TYPE VOLTAGE ONLY. This solar water heater is equipped for one type of voltage only. Check the rating plate near the bottom access panel for the correct voltage. DO NOT USE THIS SOLAR WATER HEATER WITH ANY VOLTAGE OTHER THAN THE ONE SHOWN ON THE MODEL RATING PLATE. Failure to use the correct voltage can cause problems which can result in DEATH, SERIOUS BODILY INJURY OR PROPERTY DAMAGE. If you have any questions or doubts consult your electric company.

⚠ CAUTION

If wiring from the fuse box or circuit breaker box was aluminum for the old tank, replace it with copper wire. If you wish to reuse the existing aluminum wire, have the connection at the solar water heater made by a competent electrician. Contact your local utility to arrange for a professional electrician.

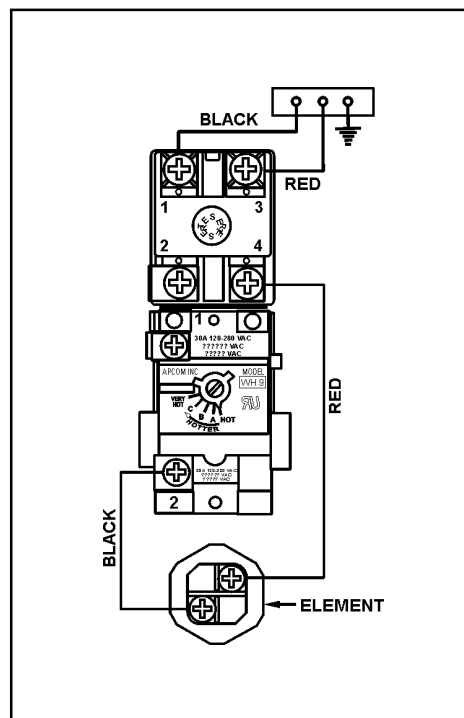

FIGURE 6

THERMOSTAT

Each thermostat is factory preset at 120°F to reduce the risk of scald injury. This setting has proven by experience to be most satisfactory from the standpoint of operational costs and household needs.

Solar water heaters installed in Florida require the thermostat(s) to be set at 125°F. If you wish to adjust the settings, see the "Temperature Adjustment" section of this installation manual on page 6.

OPERATION

TEMPERATURE REGULATION

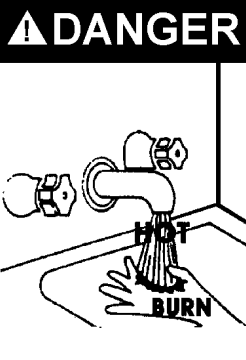

⚠ DANGER Untempered hot water can cause severe burns instantly resulting in severe injury or death.

Children, elderly, and the physically or mentally disabled are at highest risk for scald injury.

Feel water before bathing or showering.

Temperature limiting valves are available.

⚠ WARNING

HOTTER WATER CAN SCALD: Solar water heaters are intended to produce hot water. Water heated to a temperature which will satisfy clothes washing, dish washing, and other sanitizing needs can cause scalds resulting in serious personal injury and/or death. Some people are more likely to be permanently injured by hot water than others. These include the elderly, children, the infirmed, or physically handicapped. If anyone using hot water in your home fits into one of these groups or if there is a local code or state law requiring a certain temperature water at the hot water tap, then you must take special precautions. Please see Figure 7. In addition to using the lowest possible temperature setting that satisfies your hot water needs, some type of tempering device, such as a mixing valve, should be used at the hot water taps used by these people or at the solar water heater. Mixing valves are available at plumbing supply or hardware stores. Follow manufacturers instructions for installation of the valves. Before changing the factory setting of the thermostat, read the Temperature Adjustment section.

⚠ WARNING

KEEPING THE THERMOSTAT SETTING AT 120°F WILL REDUCE THE RISK OF SCALDS. Never allow small children to use a hot water tap, or to draw their own bath water. Never leave a child or handicapped person unattended in a bathtub or shower.

TEMPERATURE SETTINGS

NOTE: This residential solar water heater will not supply sanitizing hot water for dishwashers.

The thermostat is factory set at its lowest position which approximates 120°F (Hot) and is adjustable if a different water temperature is desired. Read all warnings in this manual and on the solar water heater before proceeding.

TEMPERATURE SETTINGS

HOT - is a thermostat setting of approximately 120°F, which will supply hot water at the most economical temperatures.

A - is a thermostat setting of approximately 130°F.

B - is a thermostat setting approximately 140°F.

C - is a thermostat setting approximately 150°F.

VERY HOT - is a thermostat setting of approximately 160°F. It is recommended that the dial be set lower whenever possible.

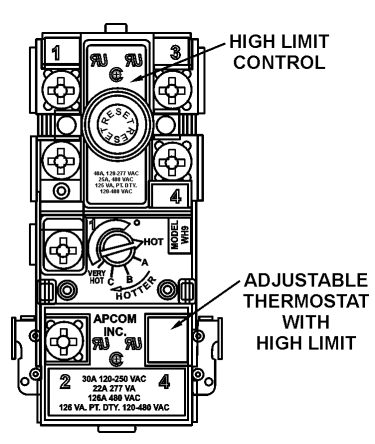

Water Temperature	Time to Produce 2nd & 3rd Degree Burns on Adult Skin
170°F	Nearly instantaneous
160°F	About 1/2 second
150°F	About 1-1/2 seconds
140°F	Less than 5 seconds
130°F	About 30 seconds
125°F	About 2 minutes
120°F	More than 5 minutes

FIGURE 7

TEMPERATURE ADJUSTMENT

To adjust the temperature setting:

1. Turn "OFF" the electrical power to the water heater, at the junction box.

⚠ WARNING

HAZARD OF ELECTRICAL SHOCK! Failure to turn "OFF" electric power to the solar water heater will result in the possibility of **DEATH, SERIOUS BODILY INJURY OR PROPERTY DAMAGE.**

2. Take off the access panel and fold away the insulation.
3. Turn the water temperature dial clockwise (↻) to increase the temperature, or counterclockwise (↺) to decrease the temperature.
4. Fold the insulation back in place and replace the access panel.
5. Turn "ON" the power supply.

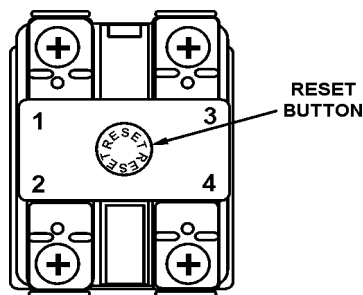

FIGURE 8

A non-adjustable high temperature limit control operates before steam temperatures are reached. The high limit is in the same area as the upper thermostat and must be reset manually when it operates. BECAUSE THE HIGH LIMIT OPERATES ONLY

WHEN ABNORMALLY HIGH WATER TEMPERATURES ARE PRESENT, IT IS IMPORTANT THAT A QUALIFIED SERVICE AGENT BE CONTACTED TO DETERMINE THE REASON FOR OPERATION BEFORE RESETTING.

MAINTENANCE

DRAINING

If the solar water heater is to be shut off and exposed to freezing temperatures, it must be drained. Water, if left in the tank and allowed to freeze, will expand and damage the solar water heater.

1. Turn "OFF" the electrical supply to the solar water heater.

WARNING

Make sure the electrical supply to the solar water heater is turned OFF. Failure to heed this will result in the possibility of DEATH, SERIOUS BODILY INJURY OR PROPERTY DAMAGE.

2. Open a nearby hot water faucet until the water is no longer hot, then turn off the cold water supply and open the drain valve, leaving the hot water faucet open.
3. The drain valve must be left open during the shut-down period. Once the solar water heater is drained close the hot water faucet.

ELEMENT

In some water areas, scale or mineral deposits will build up on heating elements. This build up will cause a rumbling noise. Follow the element replacement directions to remove the elements from the tank. Soaking in vinegar and scraping will remove the mineral deposit. Be careful not to bend the element.

ELEMENT REPLACEMENT

WARNING

Replacement elements must (1) be the same voltage and (2) no greater wattage than listed on the model and rating plate affixed to the solar water heater.

1. Turn OFF the electrical supply to the solar water heater.

WARNING

Make sure the electrical supply to the solar water heater is turned OFF. Failure to heed this will result in the possibility of DEATH, SERIOUS BODILY INJURY OR PROPERTY DAMAGE.

2. Drain the solar water heater. Follow the directions for draining.
3. Take off the access panel and turn back the insulation. Disconnect the wires from the heating element terminals.
4. Remove the element and gasket. You should always use a new gasket when you replace the element.
5. Install new element.

6. Reconnect the wires as they were.

7. Fill the tank, following the filling directions on page 5. Fill the tank with water, BEFORE you turn on the electric supply.

ANODE

The anode rod is used to protect the tank from corrosion. Most hot water tanks are equipped with an anode rod. The submerged rod sacrifices itself to protect the tank. Instead of corroding the tank, water ions attack and eat away the anode rod. This does not affect the water's taste or color. The rod must be maintained to keep the tank in operating condition.

Anode deterioration depends on water conductivity, not necessarily water condition. A corroded or pitted anode rod indicates high water conductivity and should be checked and/or replaced more often than an anode rod that appears to be intact. Replacement of a depleted anode rod can extend the life of your water heater. Inspection should be conducted by a qualified technician, and at a minimum should be checked annually after the warranty period

Sometimes bacteria and mineral action on the anode will make the water smell. Chlorination of water supply will get rid of the odor. Equipment for treating problem water is available at your local hardware store.

WARNING

Hydrogen gas can be produced in a hot water system that has not been used for a long period of time (generally two weeks or more). Hydrogen gas is extremely flammable and explosive. To prevent the possibility of bodily injury under these conditions, open the hot water faucet for several minutes at the kitchen sink before any electrical appliances which are connected to the hot water system are used (such as a dishwasher or washing machine). If hydrogen gas is present, there will probably be an unusual sound similar to air escaping through the pipe as the hot water faucet is opened. There must be no smoking or open flame near the faucet at the time it is opened.

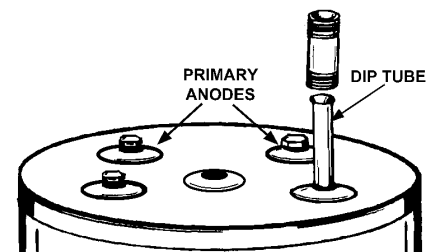

FIGURE 9

WATER HEATER SOUNDS

safety hazard.

1. The solar water heater is equipped with an immersion heating element for fastest recovery. If the solar water heater occasionally makes noises this is not a defect or a

2. Lime or scale has accumulated on the heating element causing a hissing sound. Element scale removal can be accomplished by using vinegar or by scraping.

REPAIR PARTS

REPAIR PARTS SCHEDULE

ORDERING REPAIR PARTS

The following parts may be ordered through the store you purchased the solar water heater from, or direct from the factory listed on the model & rating plate located on the lower front of the solar water heater and by phone at 1-800-433-2545. Selling prices will be furnished on request or parts will be shipped at prevailing prices and you will be billed accordingly. When ordering repair parts always give the following information: (1) Part description, (2) Model serial number, (3) Element wattage, (4) Voltage, (5) Part number. Call

ITEM NO.	PART DESCRIPTION	80 MODEL	120 MODEL
1	Primary Anode	9006914005	9006914005
2	Element Gasket	9000308005	9000308005
3	Element	9000095005	9000095005
4	Thermostat Bracket	9000309015	9000309105
5	Thermostat w/Hi Limit	9000509015	9000509015
6	Terminal Cover	9002438015	9002438015
7	Access Panel	9003620005	9003620005
8	Sensor Mounting Plug	9007309005	9007309005
9	Dip Tube with Diffuser	9002549005	9002549005
10	T & P Valve	9000728015	9000728015
11	Heat Trap Nipple	9003915015	9003915015
12	Indicator Light	9000325015	9000325015
13	Drain Valve	9003906015	9003906015
14	Access Panel	9000383005	9000383005
15	2" NPT Plug	195197-001	195197-001

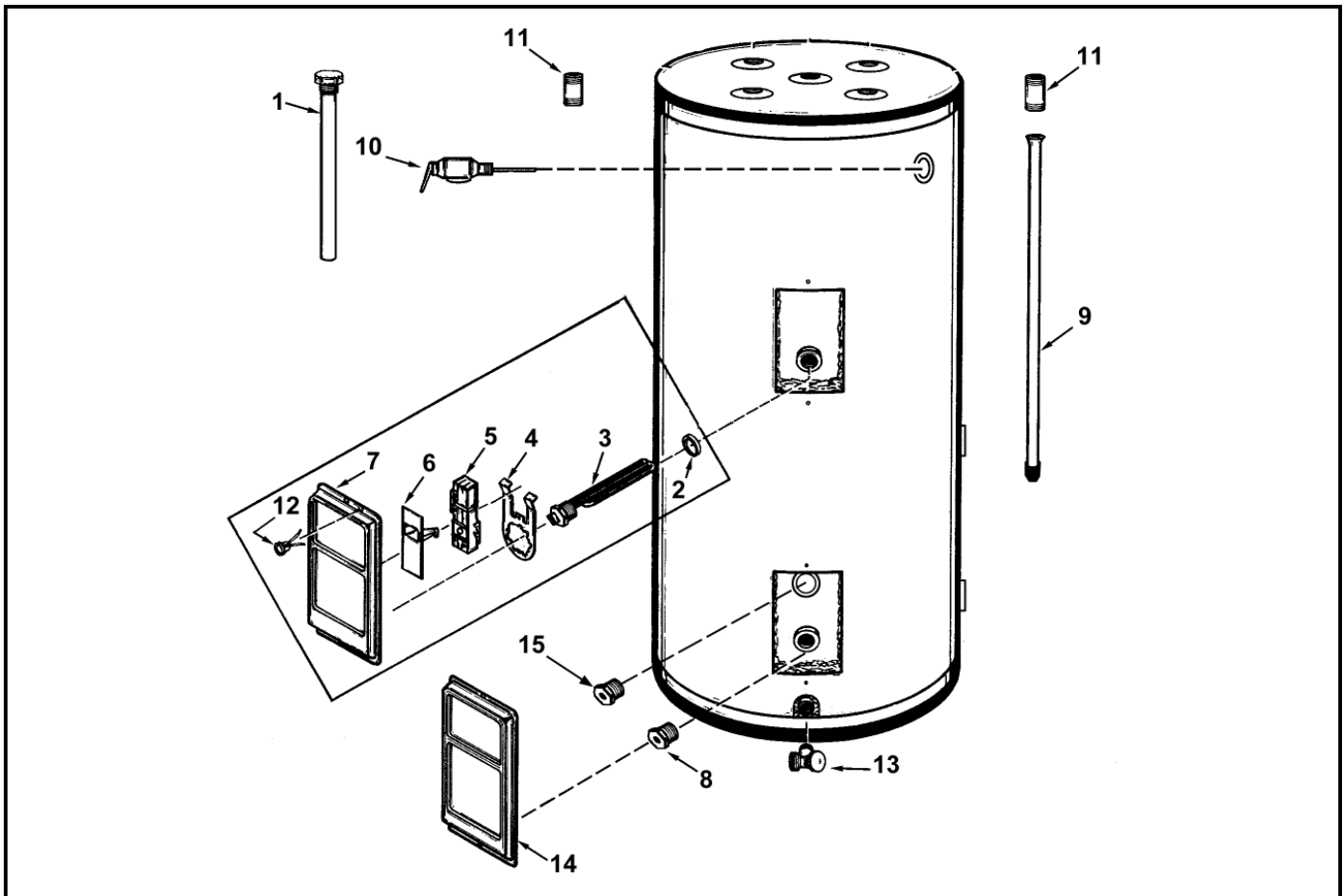

Free Manuals Download Website

<http://myh66.com>

<http://usermanuals.us>

<http://www.somanuals.com>

<http://www.4manuals.cc>

<http://www.manual-lib.com>

<http://www.404manual.com>

<http://www.luxmanual.com>

<http://aubethermostatmanual.com>

Golf course search by state

<http://golfingnear.com>

Email search by domain

<http://emailbydomain.com>

Auto manuals search

<http://auto.somanuals.com>

TV manuals search

<http://tv.somanuals.com>