

## COMMERCIAL GAS WATER HEATERS



P.O. Box 1597  
Johnson City, TN 37605



**MODELS (A)BCG3 85T500-8N &  
(A)BCG3 85T500-8P  
SERIES 120/121  
INSTALLATION - OPERATION - SERVICE  
- MAINTENANCE - LIMITED WARRANTY**



**WARNING:** If the information in these instructions is not followed exactly, a fire or explosion may result causing property damage, personal injury or death.

- Do not store or use gasoline or other flammable vapors and liquids in the vicinity of this or any other appliance.
- **WHAT TO DO IF YOU SMELL GAS:**
  - Do not try to light any appliance.
  - Do not touch any electrical switch; do not use any phone in your building.
  - Immediately call your gas supplier from a neighbor's phone. Follow the gas supplier's instructions.
  - If you cannot reach your gas supplier, call the fire department.
- Installation and service must be performed by a qualified installer, service agency or the gas supplier.

Thank you for buying this energy efficient water heater.  
We appreciate your confidence in our products.



### **WARNING**

Read and understand this instruction manual and the safety messages herein before installing, operating or servicing this water heater.

Failure to follow these instructions and safety messages could result in death or serious injury.

This manual must remain with the water heater.

**PLACE THESE INSTRUCTIONS ADJACENT TO HEATER AND NOTIFY OWNER TO KEEP FOR FUTURE REFERENCE.**

# TABLE OF CONTENTS





SAFE INSTALLATION, USE AND SERVICE.....	3	Outdoor Air Through Two Vertical Ducts.....	17
APPROVALS.....	3	Air From Other Indoor Spaces.....	17
GENERAL SAFETY INFORMATION.....	4	Technical Data Venting.....	18
Precautions.....	5	WATER HEATER INSTALLATION.....	19
Grounding Instructions.....	5	Water Line Connections.....	19
Hydrogen Gas Flammable.....	5	T&P Valve Discharge Pipe.....	19
INTRODUCTION.....	6	Installation Diagrams - Top Inlet/Outlet Usage.....	20
Abbreviations Used.....	6	Code Restrictions.....	20
Qualifications.....	6	Heater Wiring.....	21
FEATURES AND COMPONENTS.....	7	Gas Piping.....	22
The Eliminator (self-cleaning system).....	7	Purging.....	22
High Limit Switch.....	7	Gas Pressure Regulator.....	22
Electronic Ignition Control.....	7	OPERATION.....	23
Exhaust Inducer (blower assy.).....	7	General.....	23
Uncrating.....	7	Filling.....	23
INSTALLATION CONSIDERATIONS.....	8	SEQUENCE OF OPERATION.....	23
Rough In Dimensions.....	8	Lighting & Operation Label.....	24
Recovery Capacities.....	8	Check Venting.....	25
Gas and Electrical Characteristics.....	8	Check the Igniter Assembly.....	25
Locating the Water Heater.....	9	Igniter Assembly.....	25
Clearances.....	9	Main Burner.....	25
Installation On Combustible Flooring.....	10	Gas Valves.....	25
Insulation Blanket.....	10	Checking the Input.....	26
Hard Water.....	10	MAINTENANCE.....	26
Circulation Pumps.....	10	Venting System.....	26
High Altitude Installations.....	11	Remote Storage Tank Temperature Control.....	26
Propane Installations.....	11	Temperature-Pressure Relief Valve Test.....	26
Natural Gas Installations.....	11	Hot Water Odor.....	27
INSTALLATION REQUIREMENTS.....	12	Anode Rod Inspection.....	27
Gas Pressure Requirements.....	12	Draining and Flushing.....	27
Supply Gas Regulator.....	12	Recommended Procedure for Periodic Removal of Lime Deposits from Tank Type Commercial Water Heaters.....	28
Power Supply.....	12	Deliming Solvents.....	28
Water Temperature Control and Mixing Valves.....	12	Tank Cleanout Procedure.....	28
Dishwashing Machines.....	13	Deliming Using Flo-Jug Method.....	28
Closed Water Systems.....	13	Ignition Module System.....	30
Thermal Expansion.....	13	System Diagnostics.....	30
Temperature-Pressure Relief Valve.....	13	SERVICE.....	30
Contaminated Air.....	14	Electrical Servicing.....	30
Air Requirements.....	14	FOR YOUR INFORMATION.....	30
Unconfined Space.....	15	Start Up Conditions.....	30
Confined Space.....	15	Operational Conditions.....	30
Vent Adapter.....	15	Sequence of Operation Flow Chart.....	32
VENTING INSTALLATION.....	15	OPERATIONAL CHECKLIST.....	33
Venting.....	15	WATER PIPING DIAGRAMS.....	34
Multiple Heater Manifold.....	16	MANIFOLD KITS.....	49
Fresh Air Openings For Confined Spaces.....	16	COMMERCIAL STORAGE TANK WARRANTY.....	50
Outdoor Air Through Two Openings.....	16	NOTES.....	51
Outdoor Air Through One Opening.....	16		
Outdoor Air Through Two Horizontal Ducts.....	16		

# SAFE INSTALLATION, USE AND SERVICE

The proper installation, use and servicing of this water heater is extremely important to your safety and the safety of others.

Many safety-related messages and instructions have been provided in this manual and on your own water heater to warn you and others of a potential injury hazard. Read and obey all safety messages and instructions throughout this manual. It is very important that the meaning of each safety message is understood by you and others who install, use, or service this water heater.

	<p>This is the safety alert symbol. It is used to alert you to potential personal injury hazards. Obey all safety messages that follow this symbol to avoid possible injury or death.</p>
---	---

	<p>DANGER indicates an imminently hazardous situation which, if not avoided, will result in injury or death.</p>
	<p>WARNING indicates a potentially hazardous situation which, if not avoided, could result in injury or death.</p>
	<p>CAUTION indicates a potentially hazardous situation which, if not avoided, could result in minor or moderate injury.</p>
	<p>CAUTION used without the safety alert symbol indicates a potentially hazardous situation which, if not avoided, could result in property damage.</p>

All safety messages will generally tell you about the type of hazard, what can happen if you do not follow the safety message, and how to avoid the risk of injury.

The California Safe Drinking Water and Toxic Enforcement Act requires the Governor of California to publish a list of substances known to the State of California to cause cancer, birth defects, or other reproductive harm, and requires businesses to warn of potential exposure to such substances.

This product contains a chemical known to the State of California to cause cancer, birth defects, or other reproductive harm. This appliance can cause low level exposure to some of the substances listed in the Act.

## APPROVALS



# GENERAL SAFETY INFORMATION

## ⚠️ WARNING

### Fire or Explosion Hazard

- Do not store or use gasoline or other flammable vapors and liquids in the vicinity of this or any other appliance.
- Avoid all ignition sources if you smell gas.
- Do not expose water heater controls to excessive gas pressure.
- Use only the gas shown on the water heater rating label.
- Maintain required clearances to combustibles.
- Keep ignition sources away from faucets after extended periods of non-use.



Read instruction manual before installing, using or servicing water heater.



## ⚠️ WARNING

### Breathing Hazard - Carbon Monoxide Gas

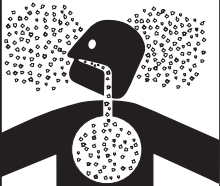

- Do not obstruct water heater air intake with insulating blanket.
- Gas and carbon monoxide detectors are available.
- Install water heater in accordance with the instruction manual.

Breathing carbon monoxide can cause brain damage or death. Always read and understand instruction manual.

## CAUTION

### Property Damage Hazard

- All water heaters eventually leak.
- Do not install without adequate drainage.

## ⚠️ WARNING

### Electrical Shock Hazard



- Turn off power to the water heater before performing any service.
- Label all wires prior to disconnecting when performing service. Wiring errors can cause improper and dangerous operation.
- Verify proper operation after servicing.
- Failure to follow these instructions can result in personal injury or death.

## ⚠️ WARNING

### Fire Hazard



For continued protection against risk of fire:

- Do not install water heater on carpeted floor.
- Do not operate water heater if flood damaged.

## ⚠️ WARNING

### Fire and Explosion Hazard



- Use joint compound or Teflon tape compatible with propane gas.
- Leak test before placing the water heater in operation.
- Disconnect gas piping and main gas shutoff valve before leak testing.
- Install sediment trap in accordance with NFPA 54.

## ⚠️ WARNING

### Fire and Explosion Hazard



- Do not use water heater with any gas other than the gas shown on the rating label.
- Excessive gas pressure to gas valve can cause serious injury or death.
- Turn off gas lines during installation.
- Contact a qualified installer or service agency for installation and service.

## ⚠️ WARNING

**Jumping out control circuits or components can result in property damage, personal injury or death.**

- Service should only be performed by a qualified service agent using proper test equipment.
- Altering the water heater controls and/or wiring in any way could result in permanent damage to the controls or water heater and is not covered under the limited warranty.
- Altering the water heater controls and/or wiring in any way could result in altering the ignition sequence allowing gas to flow to the main burner before the hot surface igniter is at ignition temperature causing delayed ignition which can cause a fire or explosion.



Any bypass or alteration of the water heater controls and/or wiring will result in voiding the appliance warranty.



## GENERAL SAFETY INFORMATION



### **⚠️ WARNING**

Read and understand this instruction manual and the safety messages herein before installing, operating or servicing this water heater.

Failure to follow these instructions and safety messages could result in death or serious injury.

This manual must remain with the water heater.

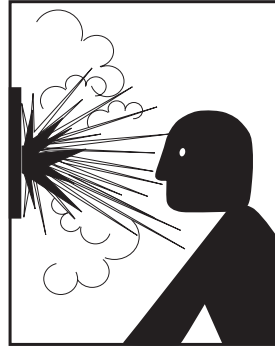

### **⚠️ WARNING**

#### **Explosion Hazard**

- Overheated water can cause water tank explosion.
- Properly sized temperature and pressure relief valve must be installed in the opening provided.

### **⚠️ DANGER**

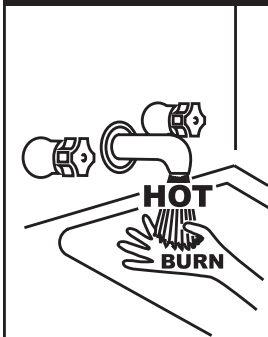

Water temperature over 125°F (52°C) can cause severe burns instantly resulting in severe injury or death.

Children, the elderly and the physically or mentally disabled are at highest risk for scald injury.

Feel water before bathing or showering.

Temperature limiting devices such as mixing valves must be installed when required by codes and to ensure safe temperatures at fixtures.

## CAUTION

**Improper installation, use and service may result in property damage.**

- Do not operate water heater if flood damaged.
- Inspect and anode rods regularly, replace if damaged.
- Install in location with drainage.
- Fill tank with water before operation.
- Properly sized thermal expansion tanks are required on all closed water systems.

Refer to this manual for installation and service.

**Verify the power to the water heater is turned off before performing any service procedures.**

## GENERAL SAFETY INFORMATION

### **PRECAUTIONS**

DO NOT USE THIS APPLIANCE IF ANY PART HAS BEEN UNDER WATER. Immediately call a qualified service agency to inspect the appliance and to make a determination on what steps should be taken next.

If the unit is exposed to the following, do not operate heater until all corrective steps have been made by a qualified service agency.

1. External fire.
2. Damage.
3. Firing without water.

### **GROUNDING INSTRUCTIONS**

This water heater must be grounded in accordance with the National Electrical Code and/or local codes. These must be followed in all cases.

This water heater must be connected to a grounded metal, permanent wiring system; or an equipment grounding conductor must be run with the circuit conductors and connected to the equipment grounding terminal or lead on the water heater, see Figure 20.

### **HYDROGEN GAS FLAMMABLE**

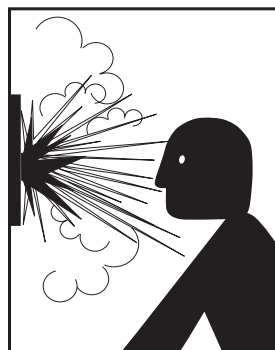

### **⚠️ WARNING**

#### **Explosion Hazard**

- Flammable hydrogen gases may be present.
- Keep all ignition sources away from faucet when turning on hot water.

Hydrogen gas can be produced in a hot water system served by this appliance that has not been used for a long period of time (generally two weeks or more). Hydrogen gas is extremely flammable. To reduce the risk of injury under these conditions, it is recommended that a hot water faucet served by this appliance be opened for several minutes before using any electrical appliance connected to the hot water system. If hydrogen is present there will probably be an unusual sound such as air escaping through the pipe as the water begins to flow. THERE SHOULD BE NO SMOKING OR OPEN FLAME NEAR THE FAUCET AT THE TIME IT IS OPEN.

# INTRODUCTION

Thank You for purchasing this water heater. Properly installed and maintained, it should give you years of trouble free service.

## **ABBREVIATIONS USED**

---

Abbreviations found in this Instruction Manual include :

- ANSI - American National Standards Institute
- ASME - American Society of Mechanical Engineers
- GAMA - Gas Appliance Manufacturer's Association
- NEC - National Electrical Code
- NFPA - National Fire Protection Association
- UL - Underwriters Laboratory
- CSA - Canadian Standards Association

## **QUALIFICATIONS**

---

### **QUALIFIED INSTALLER OR SERVICE AGENCY**

Installation and service of this water heater requires ability equivalent to that of a Qualified Agency (as defined by ANSI

below) in the field involved. Installation skills such as plumbing, air supply, venting, gas supply and electrical supply are required in addition to electrical testing skills when performing service.

**ANSI Z223.1 2006 Sec. 3.3.83:** "Qualified Agency" - "Any individual, firm, corporation or company that either in person or through a representative is engaged in and is responsible for (a) the installation, testing or replacement of gas piping or (b) the connection, installation, testing, repair or servicing of appliances and equipment; that is experienced in such work; that is familiar with all precautions required; and that has complied with all the requirements of the authority having jurisdiction."

If you are not qualified (as defined by ANSI above) and licensed or certified as required by the authority having jurisdiction to perform a given task do not attempt to perform any of the procedures described in this manual. If you do not understand the instructions given in this manual do not attempt to perform any procedures outlined in this manual.

# FEATURES AND COMPONENTS

## THE ELIMINATOR (SELF-CLEANING SYSTEM)

These units include The Eliminator (Self-Cleaning System) installed in the front water inlet, See Figure 1. The Eliminator inlet tube can only be used in the front water inlet connection. Do not install the Eliminator inlet tube in either the top or back inlet water connection. The Eliminator must be oriented correctly for proper function. There is a marked range on the pipe nipple portion of the Eliminator, that must be aligned with the top of the inlet spud. A label above the jacket hole has an arrow that will point to the marked portion of the pipe nipple if the orientation is correct. If the arrow does not point within the marked range on the pipe nipple, adjust the pipe nipple to correct. A pipe union is supplied with the Eliminator to reduce the probability of misaligning the Eliminator accidentally while tightening the connection to the inlet water supply line. Improper orientation of the Eliminator can cause poor performance of the heater and can significantly reduce outlet water temperatures during heavy draws.



**Note:** The Eliminator may have 1, 3 or 7 cross tubes.

FIGURE 1

## HIGH LIMIT SWITCH

The digital thermostat (Figure 2) contains the high limit (energy cutoff) switch. The high limit switch interrupts main burner gas flow should the water temperature reach 203°F (95°C).

In the event of high limit switch operation, the appliance cannot be restarted unless the water temperature is reduced to approximately 120°F (49°C). The high limit reset button on the front of the control then needs to be depressed.

Continued manual resetting of high limit control, preceded by higher than usual water temperature is evidence of high limit switch operation. The following is a possible reason for high limit switch operation:

- A malfunction in the thermostatic controls would allow the gas valve to remain open causing water temperature to exceed the thermostat setting. The water temperature would continue to rise until high limit switch operation.

Contact your dealer or service agent if continued high limit switch operation occurs.

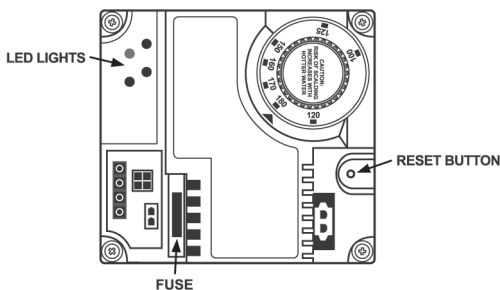

DIGITAL THERMOSTAT  
FIGURE 2

## ELECTRONIC IGNITION CONTROL

Each heater is equipped with an ignition module. The solid state ignition control (Figure 3), ignites the main burner by utilizing a silicon nitride igniter. The silicon nitride igniter shuts off during the heating cycle and the main burner flame is sensed through a remote flame sensor integral to the silicon nitride igniter assembly.

The ignition control will try to ignite the main burner three times before lockout. Then it waits one hour before trying again to ignite the main burners. This is a continuous cycle.

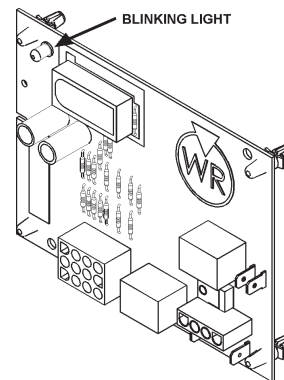

IGNITION CONTROL BOARD  
FIGURE 3

## EXHAUST INDUCER (BLOWER ASSY.)

All models are equipped with an exhaust inducer. The inducer assists in drawing in fresh air to the unit for combustion and then assists in dispensing the combustion by-products into the venting leading outside.

The exhaust inducer is equipped with a gravity controlled damper to reduce the amount of heat loss through the flue, improving efficiency.

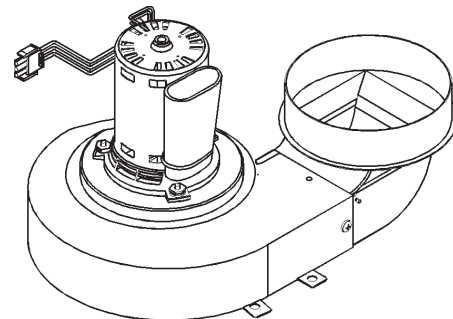

EXHAUST INDUCER  
FIGURE 4

## UNCRATING

The heater is shipped with the inducer already installed. The wiring conduit runs from the thermostat to the inducer. Before turning unit on, check to make sure the wiring conduit is securely plugged into the inducer.

# INSTALLATION CONSIDERATIONS

## ROUGH IN DIMENSIONS

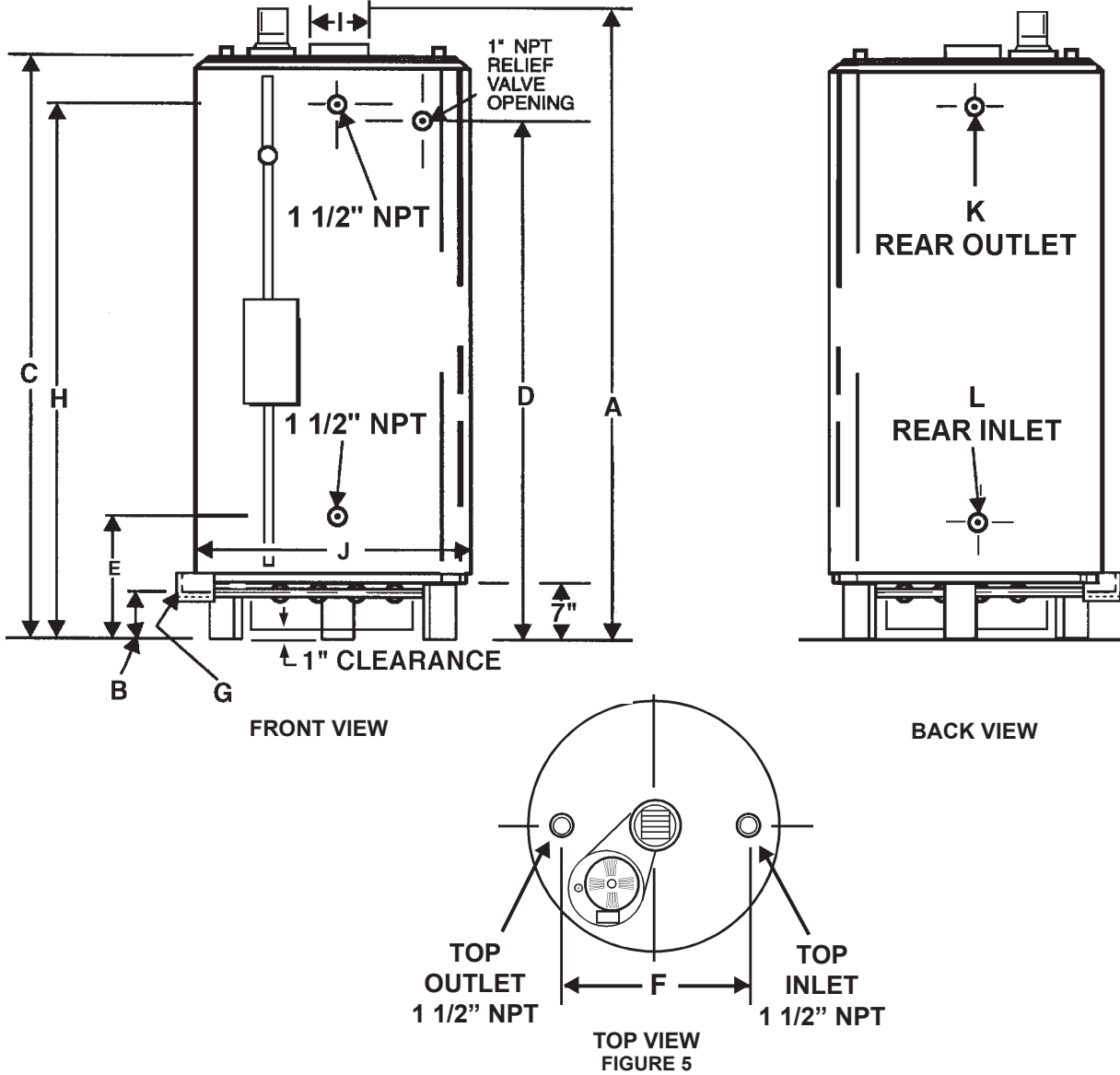

**TABLE 1. ROUGH-IN-DIMENSIONS**

Model	Input Rate Btu/Hr Kw/Hr	Approximate Tank Cap G/L	Dimensions in Inches/cm										Connections						Approx. Ship Weight	
			A	B	C	D	E	F	Gas Inlet G	H	Vent Dia I	J	Inlet (NPT)			Outlet (NPT)			Std. Lbs/ Kgs.	ASME Lbs/ Kgs.
													Top	Front	Back	Top	Front	Back		
(A)BCG385T500-8N/ (A)BCG385T500-8P	500,000	85	81.50	17.50	77.25	67.50	27.13	21.00	1.00	67.50	8.00	27.75	1.50	1.50	1.50	1.50	1.50	1.50	812	857
(A)BCG385T500-8N/ (A)BCG385T500-8P	147	322	207	44	196	171	69	53	3	171	20	70	1.50	1.50	1.50	1.50	1.50	1.50	368	389

**TABLE 2. RECOVERY CAPACITIES, based on 80% efficiency**

Model	Input Rate Btu/Hr Kw/Hr	Approximate Tank Cap G/L	Recovery Rating Capacities (GPH and LPH) at temperature rise indicated													
			30°F	40°F	50°F	60°F	70°F	80°F	90°F	100°F	110°F	120°F	130°F	140°F		
			17°C	22°C	28°C	33°C	39°C	44°C	50°C	56°C	61°C	67°C	72°C	78°C		
(A)BCG385T500-8N/ (A)BCG385T500-8P	500,000	85	1616	1212	970	808	693	606	539	485	441	404	373	346		
(A)BCG385T500-8N/ (A)BCG385T500-8P	147	322	6118	4588	3671	3059	2622	2294	2039	1835	1668	1529	1412	1311		

**TABLE 3. GAS AND ELECTRICAL CHARACTERISTICS**

Model	Gas Type	Gas Supply Pressure		Gas Manifold Pressure	Volts / Hz	Amperes
		Minimum	Maximum			
(A)BCG385T500-8N/ (A)BCG385T500-8P	Natural	4.5" W.C. (1.12 kPa)	14" W.C. (3.48 kPa)	3.5" W.C. (0.87 kPa)	120/60	<5
(A)BCG385T500-8N/ (A)BCG385T500-8P	Propane	11" W.C. (2.74 kPa)	14" W.C. (3.48 kPa)	10" W.C. (2.49 kPa)	120/60	<5



# INSTALLATION CONSIDERATIONS

## LOCATING THE WATER HEATER

### CAUTION

#### Property Damage Hazard

- All water heaters eventually leak.
- Do not install without adequate drainage.

When installing the heater, consideration must be given to proper location. Location selected should be as close to the stack or chimney as practicable, with adequate air supply and as centralized with the piping system as possible.

### WARNING

#### Fire or Explosion Hazard

- Do not store or use gasoline or other flammable vapors and liquids in the vicinity of this or any other appliance.
- Avoid all ignition sources if you smell gas.
- Do not expose water heater controls to excessive gas pressure.
- Use only the gas shown on the water heater rating label.
- Maintain required clearances to combustibles.
- Keep ignition sources away from faucets after extended periods of non-use.



Read instruction manual before installing, using or servicing water heater.



THERE IS A RISK IN USING FUEL BURNING APPLIANCES SUCH AS GAS WATER HEATERS IN ROOMS, GARAGES OR OTHER AREAS WHERE GASOLINE, OTHER FLAMMABLE LIQUIDS OR ENGINE DRIVEN EQUIPMENT OR VEHICLES ARE STORED, OPERATED OR REPAIRED. FLAMMABLE VAPORS ARE HEAVY AND TRAVEL ALONG THE FLOOR AND MAY BE IGNITED BY THE HEATER'S PILOT OR MAIN BURNER FLAMES CAUSING FIRE OR EXPLOSION. SOME LOCAL CODES PERMIT OPERATION OF GAS APPLIANCES IN SUCH AREAS IF THEY ARE INSTALLED 18" OR MORE ABOVE THE FLOOR. THIS MAY REDUCE THE RISK IF LOCATION IN SUCH AN AREA CANNOT BE AVOIDED.

DO NOT INSTALL THIS WATER HEATER DIRECTLY ON A CARPETED FLOOR. A FIRE HAZARD MAY RESULT. Instead the water heater must be placed on a metal or wood panel extending beyond the full width and depth by at least 3 inches in any direction. If the heater is installed in a carpeted alcove, the entire floor shall be covered by the panel. Also, see the DRAINING requirements in MAINTENANCE Section.

THE HEATER SHALL BE LOCATED OR PROTECTED SO IT

IS NOT SUBJECT TO PHYSICAL DAMAGE BY A MOVING VEHICLE.

**FLAMMABLE ITEMS**, PRESSURIZED CONTAINERS OR ANY OTHER POTENTIAL FIRE HAZARDOUS ARTICLES MUST NEVER BE PLACED ON OR ADJACENT TO THE HEATER. OPEN CONTAINERS OR FLAMMABLE MATERIAL SHOULD NOT BE STORED OR USED IN THE SAME ROOM WITH THE HEATER.

THE HEATER MUST NOT BE LOCATED IN AN AREA WHERE IT WILL BE SUBJECT TO FREEZING.

LOCATE IT NEAR A FLOOR DRAIN. THE HEATER SHOULD BE LOCATED IN AN AREA WHERE LEAKAGE FROM THE HEATER OR CONNECTIONS WILL NOT RESULT IN DAMAGE TO THE ADJACENT AREA OR TO LOWER FLOORS OF THE STRUCTURE.

WHEN SUCH LOCATIONS CANNOT BE AVOIDED, A SUITABLE DRAIN PAN SHOULD BE INSTALLED UNDER THE HEATER. Such pans should be fabricated with sides at least 2" deep, with length and width at least 2" greater than the diameter of the heater and must be piped to an adequate drain. The pan must not restrict combustion air flow.

## CLEARANCES

This water heater is approved for installation on combustible flooring (with NSF Leg Kit #9003425205) in an alcove when the minimum clearance from any combustible construction is as indicated in Figure 6 and Table 4.

In all installations the minimum combustible clearances from vent piping shall be 6" (15.2 cm). Vent piping passing through a combustible wall or ceiling must be a continuous run (no joints) and retain the 6" (15.2 cm) clearance unless an approved reducing thimble is used.

A service clearance of 24" (61 cm) should be maintained from serviceable parts, such as relief valves, flue baffles, thermostats, cleanout openings or drain valves.

The units are approved for installation with side, rear and ceiling clearances as indicated below:

MODEL	"A" RIGHT SIDE	"B" LEFT SIDE	"C" BACK	"D" CEILING
(A)BCG385T500-8N/ (A)BCG385T500-8P	5" (12.7 cm)	5" (12.7 cm)	5" (12.7 cm)	20" (50.8 cm)

MODEL	"A" RIGHT SIDE	"B" LEFT SIDE	"C" BACK	"D" CEILING
(A)BCG385T500-8N/ (A)BCG385T500-8P	0	0	0	12" (30.5 cm)

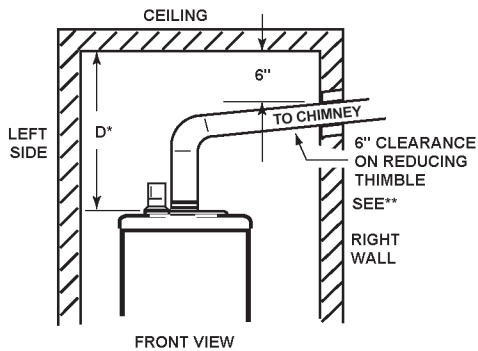

NOTES:  
 \* INCLUDES 6" FROM VENTING AND FLUE BAFFLE SERVICE CLEARANCE.  
 \*\* ALL HORIZONTAL VENT PIPING SHALL HAVE A RISE OF 1/4" PER FOOT MINIMUM, SEE "VENTING".

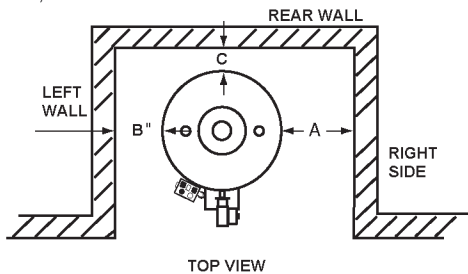

ILLUSTRATION OF MINIMUM COMBUSTIBLE CLEARANCES IN AN ALCOVE

FIGURE 6

## INSTALLATION ON COMBUSTIBLE FLOORING

The (A)BCG385T500-8N/(A)BCG385T500-8P is approved for installations on combustible flooring when installed with NSF Leg Kit number 9003425205

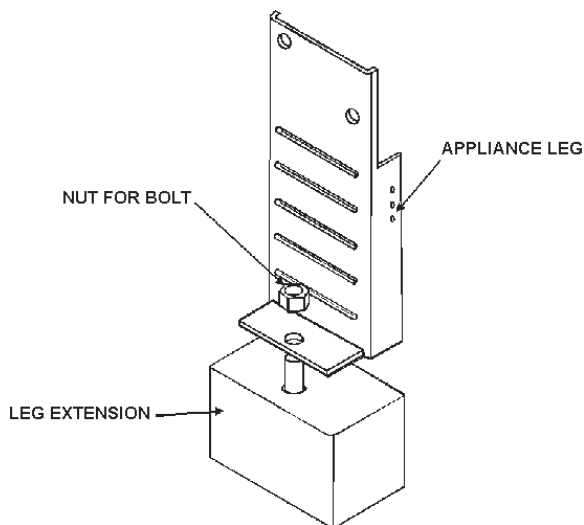

FIGURE 7

1. Unit needs to be lifted in a way not to damage unit or laid on it's side to access the bottom of the legs.
2. Slide leg extension under leg and the bolt up through the bottom hole located in the bottom of the leg.
3. Once in place, screw nut down and secure.
4. Front of leg should line up with front of leg extension as shown in Figure 7 to make sure weight of unit is distributed through the leg extension.

## INSULATION BLANKET

<b>⚠ WARNING</b>	
<b>Breathing Hazard - Carbon Monoxide Gas</b>	
	<ul style="list-style-type: none"> <li>• Do not obstruct water heater air intake with insulating blanket.</li> <li>• Gas and carbon monoxide detectors are available.</li> <li>• Install water heater in accordance with the instruction manual.</li> </ul>
Breathing carbon monoxide can cause brain damage or death. Always read and understand instruction manual.	

Insulation blankets are available to the general public for external use on gas water heaters but are not necessary with these products. The purpose of an insulation blanket is to reduce the standby heat loss encountered with storage tank heaters. The water heaters covered by this manual meet or exceed the Energy Policy Act standards with respect to insulation and standby heat loss requirements, making an insulation blanket unnecessary.

Should you choose to apply an insulation blanket to this heater, you should follow these instructions. See the Features and Components section of this manual for identification of components mentioned below. Failure to follow these instructions can restrict the air flow required for proper combustion, potentially resulting in fire, asphyxiation, serious personal injury or death.

- **DO NOT** apply insulation to the top of the water heater, as this will interfere with safe operation of the exhaust inducer.
- **DO NOT** cover the gas valve, thermostat or the Temperature-Pressure Relief Valve.
- **DO NOT** allow insulation to come within 2" (5 cm) of the burners, to prevent blockage of combustion air flow to the burners.
- **DO NOT** allow insulation to come within 9 inches (23 cm) of floor, (within 2 inches (5 cm) of bottom cover) to prevent blockage of combustion air flow to the burners..
- **DO NOT** cover the instruction manual. Keep it on the side of the water heater or nearby for future reference.
- **DO** obtain new warning and instruction labels from the manufacturer for placement on the blanket directly over the existing labels.
- **DO** inspect the insulation blanket frequently to make certain it does not sag, thereby obstructing combustion air flow.

## HARD WATER

Where hard water conditions exist, water softening or the threshold type of water treatment is recommended. This will protect the dishwashers, coffee urns, water heaters, water piping and other equipment.

See the Maintenance Section in this manual for sediment and lime scale removal procedures.

## CIRCULATION PUMPS

A circulating pump is used when a system requires a circulating loop or there is a storage tank used in conjunction with the water heater. See Water Piping Diagrams in this manual for installation location of circulating pumps.

See the Circulation Pump Wiring Diagrams (Figure 8, Figure 9) in this manual for electrical hookup information. Install in accordance with the current edition of the National Electrical Code, NFPA 70 or the Canadian Electrical Code, CSA C22.1.

All-bronze circulators are recommended for used with commercial water heaters.

Some circulating pumps are manufactured with sealed bearings and do not require further lubrication. Some circulating pumps must be periodically oiled. Refer to the pump manufacturer's instructions for lubrication requirements.

CIRCULATING PUMP WIRING DIAGRAM  
STORAGE TANK OR BUILDING RECIRCULATION

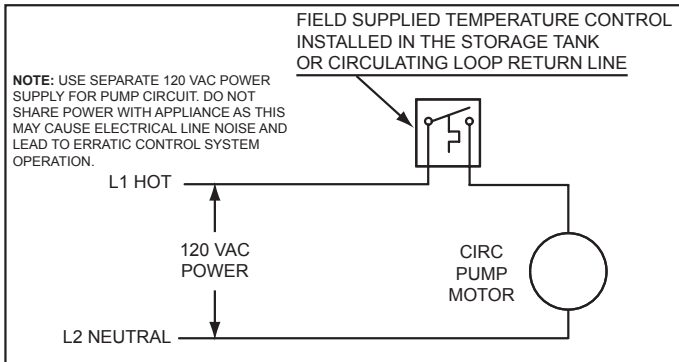

FIGURE 8.

CIRCULATING PUMP WIRING DIAGRAM  
DISHWASHER LOOP WITH TOGGLE SWITCH

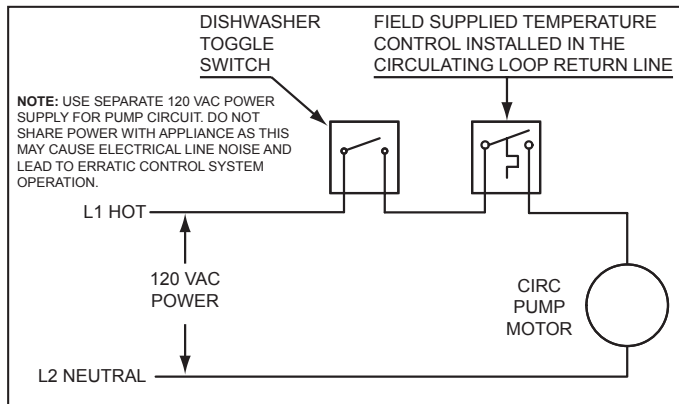

FIGURE 9.

## HIGH ALTITUDE INSTALLATIONS



### WARNING

#### Fire and Explosion Hazard

- Under no circumstances should the input exceed the rate shown on the water heater's rating label.
- Overfiring could result in fire or explosion.
- Gas and carbon monoxide detectors are available.

### WARNING

#### Breathing Hazard - Carbon Monoxide Gas

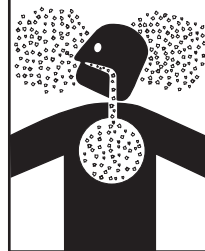

- Under no circumstances should the input exceed the rate shown on the water heater's rating label.
- Overfiring could result in damage to the water heater and sooting.
- Gas and carbon monoxide detectors are available.

Breathing carbon monoxide can cause brain damage or death. Always read and understand instruction manual.

## PROPANE INSTALLATIONS

INSTALLATIONS ABOVE 2000 FEET (610 METERS) REQUIRE REPLACEMENT OF BURNER ORIFICES IN ACCORDANCE WITH CURRENT EDITION OF THE NATIONAL FUEL GAS CODE (ANSI Z223.1). FOR CANADIAN INSTALLATIONS CONSULT CANADIAN INSTALLATIONS CODE CAN/CSAB149.1. FAILURE TO REPLACE ORIFICES WILL RESULT IN IMPROPER AND INEFFICIENT OPERATION OF THE APPLIANCE RESULTING IN THE PRODUCTION OF INCREASED LEVELS OF CARBON MONOXIDE GAS IN EXCESS OF SAFE LIMITS WHICH COULD RESULT IN SERIOUS PERSONAL INJURY OR DEATH.

You should contact your gas supplier for any specific changes which may be required in your area.

As elevation above sea level is increased, there is less oxygen per cubic foot of air. Therefore, the heater input rate should be reduced at high altitudes for satisfactory operation with the reduced oxygen supply. Failure to make this reduction would result in an over firing of the heater causing sooting, poor combustion and/or unsatisfactory heater performance.

Ratings specified by manufacturers for most appliances apply for elevations up to 2000 feet (610m). For elevations above 2000 feet (610), ratings must be reduced at the rate of 4% for each 1000 feet (305m) above sea level. For example, if a heater is rated at 78,000 Btuh (22.9 Kwh) at sea level, to rate the heater at 4000 feet (1219m), you subtract 4 (once for each thousand feet) x .04 (4% input reduction) x 78,000 (original rating) from the original rating.

Therefore, to calculate the input rating at 4,000 feet (1219m):  $4 \times .04 \times 78,000 = 12,480$  Btuh (3.7 Kwh),  $78,000 (22.9 \text{ Kwh}) - 12,480 (3.7 \text{ Kwh}) = 65,520$  Btuh (19.2 Kwh). At 6000 feet (1829m) the correct input rating should be 59,280 Btuh (17.4 Kwh).

## NATURAL GAS INSTALLATIONS

The natural gas fired version of the water heater covered by this manual is certified for use without modification for altitudes up to 10,100 feet.

For installations above 10,100 feet call the technical support phone number listed on the back cover of this manual for further technical assistance. Call the local gas or utility company to verify Btu per cubic foot content before calling for technical assistance and have that information available.

Note: The actual firing rate of the water heater must not exceed the input rating on the water heater's rating label under any circumstances.

Note: Due to the input rating reduction at high altitudes, the output rating of the appliance is also reduced and should be compensated for in the sizing of the equipment for applications.

# INSTALLATION REQUIREMENTS

## GAS PRESSURE REQUIREMENTS

Natural gas models require a minimum gas supply pressure of 4.5" W.C. Propane gas models require a minimum gas supply pressure of 11" W.C. The minimum supply pressure is measured while gas is not flowing (static pressure) AND while gas is flowing (dynamic pressure). The supply pressure (static and dynamic) should never fall below the specified minimum supply pressure. The supply pressure should be measured with all gas fired appliances connected to the common main firing at full capacity. If the supply pressure drops more than 1.5" W.C. as gas begins to flow to the water heater then the supply gas system including the gas line and/or the gas regulator may be restricted or undersized. See Supply Gas Regulator section and Gas Piping section of this manual.

The gas valve on all models has a maximum gas supply pressure limit of 14" W.C. The maximum supply pressure is measured while gas is not flowing (static pressure) AND while gas is flowing (dynamic pressure).

## SUPPLY GAS REGULATOR

The water heater covered by this manual may require the installation of a supply gas regulator. If the supply gas pressure exceeds 14 inches W.C. a supply gas regulator must be used. If the gas supply pressure exceeds 14" W.C. in a multiple water heater installation, each water heater must have its own supply gas regulator. If required, the supply gas regulator shall be rated at or above the Btu/hr input rating of the water heater it supplies.

Supply gas regulators shall have inlet and outlet connections not less than the minimum supply gas line size for the water heater they serve as shown in Table 9. The Maxitrol 325-7L or equivalent is recommended.

## POWER SUPPLY

The water heaters covered in this manual require a 120 VAC, 1Ø (single phase), 60Hz, 15 amp power supply and must also be electrically grounded in accordance with local codes or, in the absence of local codes, with the National Electrical Code, ANSI/NFPA 70 or the Canadian Electrical Code, CSA C22.1.

## WATER TEMPERATURE CONTROL AND MIXING VALVES

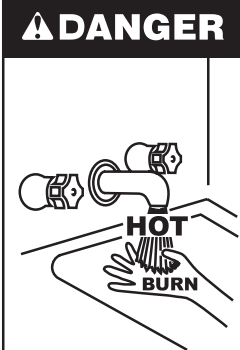

Water temperature over 125°F (52°C) can cause severe burns instantly resulting in severe injury or death.

Children, the elderly and the physically or mentally disabled are at highest risk for scald injury.

Feel water before bathing or showering.

Temperature limiting devices such as mixing valves must be installed when required by codes and to ensure safe temperatures at fixtures.

Water heated to a temperature which will satisfy clothes washing, dish washing, and other sanitizing needs can scald and cause permanent injury upon contact. Short repeated heating cycles caused by small hot water uses can cause temperatures at the point of use to exceed the water heater's temperature setting by up to 20°F (11°C).

Some people are more likely to be permanently injured by hot water than others. These include the elderly, children, the infirm and the physically/mentally disabled. Table 6 shows the approximate time-to-burn relationship for normal adult skin. If anyone using hot water provided by the water heater being installed fits into one of these groups or if there is a local code or state law requiring a certain water temperature at the point of use, then special precautions must be taken.

In addition to using the lowest possible temperature setting that satisfies the demand of the application a Mixing Valve should be installed at the water heater (see Figure 10) or at the hot water taps to further reduce system water temperature.

Mixing valves are available at plumbing supply stores. Consult a Qualified Installer or Service Agency. Follow mixing valve manufacturer's instructions for installation of the valves.

**TABLE 6.**

Water Temperature	Time to Produce 2nd & 3rd Degree Burns on Adult Skin
180°F (82°C)	Nearly instantaneous
170°F (77°C)	Nearly instantaneous
160°F (71°C)	About 1/2 second
150°F (66°C)	About 1-1/2 seconds
140°F (60°C)	Less than 5 seconds
130°F (54°C)	About 30 seconds
120°F (49°C)	More than 5 minutes

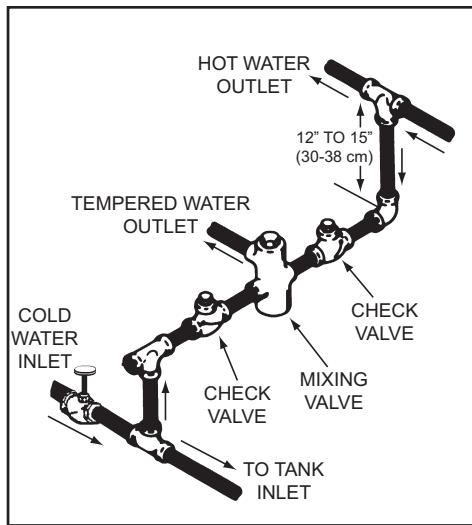

FIGURE 10

## DISHWASHING MACHINES

All dishwashing machines meeting the National Sanitation Foundation requirements are designed to operate with water flow pressures between 15 and 25 pounds per square inch (103 kPa and 173 kPa). Flow pressures above 25 pounds per square inch (173 kPa), or below 15 pounds per square inch (103 kPa), will result in improperly sanitized dishes. Where pressures are high, a water pressure reducing or flow regulating control valve should be used in the 180°F (82°C) line to the dishwashing machine and should be adjusted to deliver water pressure between these limits.

The National Sanitation Foundation also recommends circulation of 180°F (82°C) water. Where this is done, the circulation should be very gentle so that it does not cause any unnecessary turbulence inside the water heater. The circulation should be just enough to provide 180°F (82°C) water at the point of take-off to the dishwashing machine.

Adjust flow by throttling a full port ball valve installed in the circulating line on the outlet side of the pump. Never throttle flow on the suction side of a pump. See Water Piping Diagrams in this manual.

## CLOSED WATER SYSTEMS

Water supply systems may, because of code requirements or such conditions as high line pressure, among others, have installed devices such as pressure reducing valves, check valves, and back flow preventers. Devices such as these cause the water system to be a closed system.

## THERMAL EXPANSION

As water is heated, it expands (thermal expansion). In a closed system the volume of water will grow when it is heated. As the volume of water grows there will be a corresponding increase in water pressure due to thermal expansion. Thermal expansion can cause premature tank failure (leakage). This type of failure is not covered under the limited warranty. Thermal expansion can also cause intermittent Temperature-Pressure Relief Valve operation: water discharged from the valve due to excessive pressure build up. This condition is not covered under the limited warranty. The Temperature-Pressure Relief Valve is not intended for the constant relief of thermal expansion.

A properly sized thermal expansion tank must be installed on all closed systems to control the harmful effects of thermal expansion. Contact a local plumbing service agency to have a thermal expansion tank installed.

See Water Line Connections on page 19 and the Water Piping Diagrams beginning on page 34.

## TEMPERATURE-PRESSURE RELIEF VALVE

	<h1>! WARNING</h1>
	<h3>Explosion Hazard</h3>
	<ul style="list-style-type: none"> <li>• Temperature-Pressure Relief Valve must comply with ANSI Z21.22- CSA 4.4 and ASME code.</li> <li>• Properly sized temperature-pressure relief valve must be installed in opening provided.</li> <li>• Can result in overheating and excessive tank pressure.</li> <li>• Can cause serious injury or death.</li> </ul>

This water heater is provided with a properly rated/sized and certified combination Temperature-Pressure Relief Valve (T&P valve) by the manufacturer. The valve is certified by a nationally recognized testing laboratory that maintains periodic inspection of production of listed equipment of materials as meeting the requirements for Relief Valves for Hot Water Supply Systems, ANSI Z21.22 • CSA 4.4, and the code requirements of ASME.

If replaced, the new T&P valve must meet the requirements of local codes, but not less than a combination Temperature-Pressure Relief Valve rated/sized and certified as indicated in the above paragraph. The new valve must be marked with a maximum set pressure not to exceed the marked hydrostatic working pressure of the water heater (150 psi = 1,035 kPa) and a discharge capacity not less than the water heater Btu/hr or kW input rate as shown on the water heater's model rating label.

NOTE: In addition to the factory installed Temperature-Pressure Relief Valve on the water heater, each remote storage tank that may be installed and piped to a water heating appliance must also have its own properly sized, rated and approved Temperature-Pressure Relief Valve installed. Call the toll free technical support phone number listed on the back cover of this manual for technical assistance in sizing a Temperature-Pressure Relief Valve for remote storage tanks.

For safe operation of the water heater, the Temperature-Pressure Relief Valve must not be removed from its designated opening nor plugged. The Temperature-Pressure Relief Valve must be installed directly into the fitting of the water heater designed for the relief valve. Install discharge piping so that any discharge will exit the pipe within 6 inches (15.2 cm) above an adequate floor drain, or external to the building. In cold climates it is recommended that it be terminated at an adequate drain inside the building. Be certain that no contact is made with any live electrical part. The discharge opening must not be blocked or reduced in size under any circumstances. Excessive length, over 30 feet (9.14 m), or use of more than four elbows can cause restriction and reduce the discharge capacity of the valve.

No valve or other obstruction is to be placed between the Temperature-Pressure Relief Valve and the tank. Do not connect discharge piping directly to the drain unless a 6" (15.2 cm) air gap is provided. To prevent bodily injury, hazard to life, or property damage, the relief valve must be allowed to discharge water in adequate quantities should circumstances demand. If the discharge pipe is not connected to a drain or other suitable means, the water flow may cause property damage.

<b>CAUTION</b>
<b>Water Damage Hazard</b>
<ul style="list-style-type: none"> <li>• Temperature-Pressure Relief Valve discharge pipe must terminate at adequate drain.</li> </ul>

**T&P Valve Discharge Pipe Requirements:**

- Shall not be smaller in size than the outlet pipe size of the valve, or have any reducing couplings or other restrictions.
- Shall not be plugged or blocked.
- Shall not be exposed to freezing temperatures.
- Shall be of material listed for hot water distribution.
- Shall be installed so as to allow complete drainage of both the Temperature-Pressure Relief Valve and the discharge pipe.
- Must terminate a maximum of six inches above a floor drain or external to the building. In cold climates, it is recommended that the discharge pipe be terminated at an adequate drain inside the building.
- Shall not have any valve or other obstruction between the relief valve and the drain.

<b>⚠ DANGER</b>	<ul style="list-style-type: none"> <li>• Burn hazard.</li> <li>• Hot water discharge.</li> <li>• Keep clear of Temperature-Pressure Relief Valve discharge outlet.</li> </ul>

The Temperature-Pressure Relief Valve must be manually operated at least twice a year. Caution should be taken to ensure that (1) no one is in front of or around the outlet of the Temperature-Pressure Relief Valve discharge line, and (2) the water manually discharged will not cause any bodily injury or property damage because the water may be extremely hot. If after manually operating the valve, it fails to completely reset and continues to release water, immediately close the cold water inlet to the water heater, follow the draining instructions in this manual, and replace the Temperature-Pressure Relief Valve with a properly rated/sized new one.

**NOTE:** The purpose of a Temperature-Pressure Relief Valve is to prevent excessive temperatures and pressures in the storage tank. The T&P valve is not intended for the constant relief of thermal expansion. A properly sized thermal expansion tank must be installed on all closed systems to control thermal expansion, see Closed Water Systems and Thermal Expansion on page 13.

If you do not understand these instructions or have any questions regarding the Temperature-Pressure Relief Valve call the toll free number listed on the back cover of this manual for technical assistance.

**CONTAMINATED AIR**

<b>⚠ WARNING</b>	
<b>Breathing Hazard - Carbon Monoxide Gas</b>	
	<ul style="list-style-type: none"> <li>• Install water heater in accordance with the Instruction Manual and NFPA 54 or CAN/CSA-B149.1.</li> <li>• To avoid injury, combustion and ventilation air must be taken from outdoors.</li> <li>• Do not place chemical vapor emitting products near water heater.</li> </ul>
Breathing carbon monoxide can cause brain damage or death. Always read and understand instruction manual.	

Corrosion of the flue ways and vent system may occur if air for combustion contains certain chemical vapors. Such corrosion may result in failure and risk of asphyxiation.

Combustion air that is contaminated can greatly diminish the life span of the water heater and water heater components such as hot surface igniters and burners. Propellants of aerosol sprays, beauty shop supplies, water softener chemicals and chemicals used in dry cleaning processes that are present in the combustion, ventilation or ambient air can cause such damage.

Do not store products of this sort near the water heater. Air which is brought in contact with the water heater should not contain any of these chemicals. If necessary, uncontaminated air should be obtained from remote or outdoor sources. The limited warranty is voided when failure of water heater is due to a corrosive atmosphere. (See limited warranty for complete terms and conditions).

**AIR REQUIREMENTS**

<b>⚠ WARNING</b>	
<b>Breathing Hazard - Carbon Monoxide Gas</b>	
	<ul style="list-style-type: none"> <li>• Install water heater in accordance with the Instruction Manual and NFPA 54 or CAN/CSA-B149.1.</li> <li>• To avoid injury, combustion and ventilation air must be taken from outdoors.</li> <li>• Do not place chemical vapor emitting products near water heater.</li> </ul>
Breathing carbon monoxide can cause brain damage or death. Always read and understand instruction manual.	

For safe operation an adequate supply of fresh uncontaminated air for combustion and ventilation must be provided.

An insufficient supply of air can cause recirculation of combustion products resulting in contamination that may be hazardous to life. Such a condition often will result in a yellow, luminous burner flame, causing sooting of the combustion chamber, burners and flue tubes and creates a risk of asphyxiation.

Do not install the water heater in a confined space unless an adequate supply of air for combustion and ventilation is brought in to that space using the methods described in the Confined Space section that follows.

Never obstruct the flow of ventilation air. If you have any doubts or questions at all, call your gas supplier. Failure to provide the proper amount of combustion air can result in a fire or explosion and cause property damage, serious bodily injury or death.

### UNCONFINED SPACE

An Unconfined Space is one whose volume IS NOT LESS THAN 50 cubic feet per 1,000 Btu/hr (4.8 cubic meters per kW) of the total input rating of all appliances installed in the space. Rooms communicating directly with the space, in which the appliances are installed, through openings not furnished with doors, are considered a part of the unconfined space.

Makeup air requirements for the operation of exhaust fans, kitchen ventilation systems, clothes dryers and fireplaces shall also be considered in determining the adequacy of a space to provide combustion, ventilation and dilution air.

### UNUSUALLY TIGHT CONSTRUCTION

In unconfined spaces in buildings, infiltration may be adequate to provide air for combustion, ventilation and dilution of flue gases. However, in buildings of unusually tight construction (for example, weather stripping, heavily insulated, caulked, vapor barrier, etc.) additional air must be provided using the methods described in the Confined Space section that follows.

### CONFINED SPACE

A Confined Space is one whose volume IS LESS THAN 50 cubic feet per 1,000 Btu/hr (4.8 cubic meters per kW) of the total input rating of all appliances installed in the space.

Openings must be installed to provide fresh air for combustion, ventilation and dilution in confined spaces. The required size for the openings is dependent on the method used to provide fresh air to the confined space AND the total Btu/hr input rating of all appliances installed in the space.

### EXHAUST FANS

Where exhaust fans are installed, additional air shall be provided to replace the exhausted air. When an exhaust fan is installed in the same space with a water heater, sufficient openings to provide fresh air must be provided that accommodate the requirements for all appliances in the room and the exhaust fan. Undersized openings will cause air to be drawn into the room

through the water heater's vent system causing poor combustion. Sooting, serious damage to the water heater and the risk of fire or explosion may result. It can also create a risk of asphyxiation.

### LOUVERS AND GRILLES

The free areas of the fresh air openings in the instructions that follow do not take in to account the presence of louvers, grilles or screens in the openings.

The required size of openings for combustion, ventilation and dilution air shall be based on the "net free area" of each opening. Where the free area through a design of louver or grille or screen is known, it shall be used in calculating the size of opening required to provide the free area specified. Where the louver and grille design and free area are not known, it shall be assumed that wood louvers will have 25% free area and metal louvers and grilles will have 75% free area. Non motorized louvers and grilles shall be fixed in the open position.

### VENT ADAPTER

The (A)BCG385T500-8N/(A)BCG385T500-8P model is shipped with a 6" to 8" diameter vent adapter (Fig. 11). The vent adapter fits on top of the installed blower exhaust. Use only vent adapters supplied with the unit. The venting must comply with the NATIONAL FUEL GAS CODE, ANSI Z223.1/NFPA 54 and for Canadian installations consult the Canadian Installation Code CAN/CSA B149.1-00.

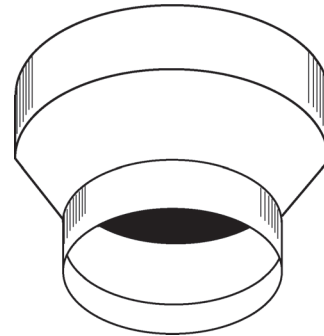

FIGURE 11

## VENTING INSTALLATION

### VENTING

THE INSTRUCTIONS IN THIS SECTION ON VENTING MUST BE FOLLOWED TO AVOID CHOKED COMBUSTION OR RECIRCULATION OF FLUE GASES. SUCH CONDITIONS CAUSE SOOTING OR RISKS OF FIRE AND ASPHYXIATION.

Heater must be protected from freezing downdrafts.

Remove all soot or other obstructions from the chimney that will retard a free draft.

Type B venting is recommended with these heaters. For typical venting application see TECHNICAL DATA VENTING on page 18.

This water heater must be vented in compliance with all local codes, the current revision of the National Fuel Gas Code (ANSI-Z223.1) and with the Category I Venting Tables.

If any part of the vent system is exposed to ambient temperatures below 40°F it must be insulated to prevent condensation.

- Do not connect the heater to a common vent or chimney with solid fuel burning equipment. This practice is prohibited by many local building codes as is the practice of venting gas fired equipment to the duct work of ventilation systems.

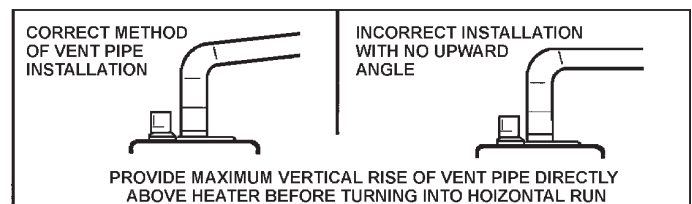

FIGURE 12

- Where a separate vent connection is not available and the vent pipe from the heater must be connected to a common

vent with an oil burning furnace, the vent pipe should enter the smaller common vent or chimney at a point above the large vent pipe.

### MULTIPLE HEATER MANIFOLD

Figure 13 and Table 7 should be used for horizontally manifolding two or more heaters.

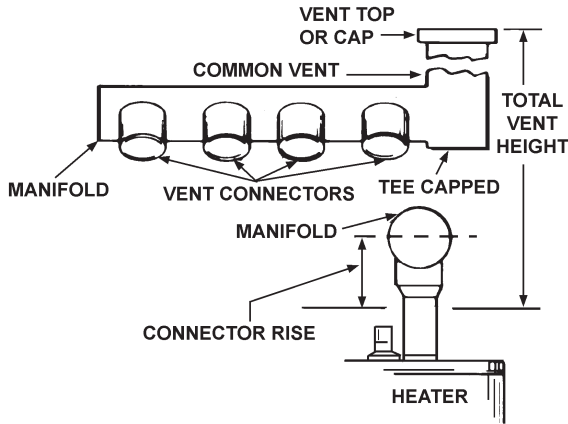

FIGURE 13

### FRESH AIR OPENINGS FOR CONFINED SPACES

The following instructions shall be used to calculate the size, number and placement of openings providing fresh air for combustion, ventilation and dilution in confined spaces. The illustrations shown in this section of the manual are a reference for the openings that provide fresh air into confined spaces only. DO NOT refer to these illustrations for the purpose of vent installation. See Venting Installation on page 15 for complete venting installation instructions.

### OUTDOOR AIR THROUGH TWO OPENINGS

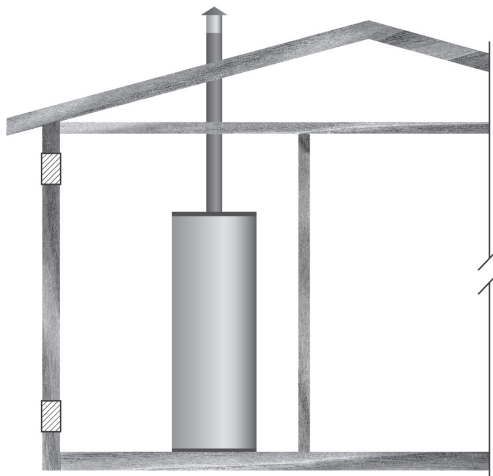

FIGURE 14

The confined space shall be provided with two permanent openings, one commencing within 12 inches (300 mm) of the top and one commencing within 12 inches (300 mm) of the bottom of the enclosure. The openings shall communicate directly with the outdoors. See Figure 14.

Each opening shall have a minimum free area of 1 square inch per 4,000 Btu/hr (550 mm<sup>2</sup> per kW) of the aggregate input rating of all appliances installed in the enclosure. Each opening shall not be less than 100 square inches (645 cm<sup>2</sup>).

### OUTDOOR AIR THROUGH ONE OPENING

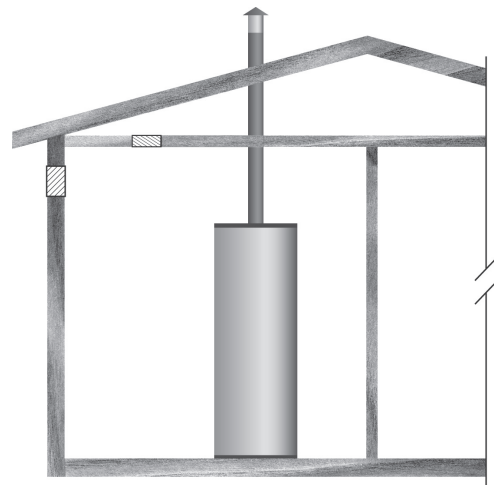

FIGURE 15

Alternatively a single permanent opening, commencing within 12 inches (300 mm) of the top of the enclosure, shall be provided. See Figure 15. The water heater shall have clearances of at least 1 inch (25 mm) from the sides and back and 6 inches (150 mm) from the front of the appliance. The opening shall directly communicate with the outdoors or shall communicate through a vertical or horizontal duct to the outdoors or spaces that freely communicate with the outdoors and shall have a minimum free area of the following:

- 1 square inch per 3000 Btu/hr (733 mm<sup>2</sup> per kW) of the total input rating of all appliances located in the enclosure, and
- Not less than the sum of the areas of all vent connectors in the space.

### OUTDOOR AIR THROUGH TWO HORIZONTAL DUCTS

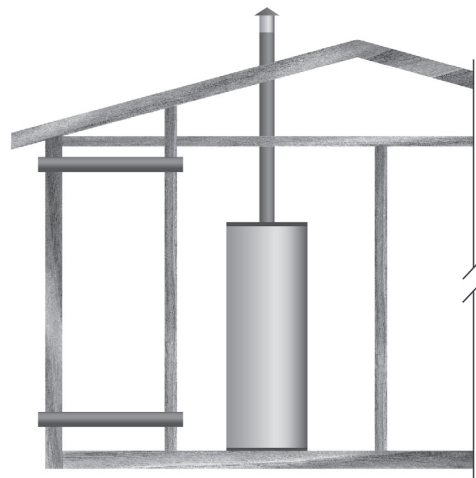

FIGURE 16

The confined space shall be provided with two permanent horizontal ducts, one commencing within 12 inches (300 mm) of the top and one commencing within 12 inches (300 mm) of the bottom of the enclosure. The horizontal ducts shall communicate directly with the outdoors. See Figure 16.

Each duct opening shall have a minimum free area of 1 square inch per 2,000 Btu/hr (1100 mm<sup>2</sup> per kW) of the aggregate input rating of all appliances installed in the enclosure.

When ducts are used, they shall be of the same cross sectional area as the free area of the openings to which they connect. The minimum dimension of rectangular air ducts shall be not less than 3 inches.



## OUTDOOR AIR THROUGH TWO VERTICAL DUCTS

The illustrations shown in this section of the manual are a reference for the openings that provide fresh air into confined spaces only.

**DO NOT** refer to these illustrations for the purpose of vent installation. See Venting Installation on page 15 for complete venting installation instructions.

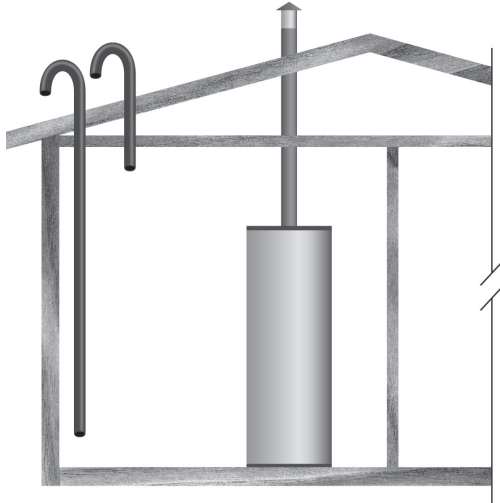

**FIGURE 17**

The confined space shall be provided with two permanent vertical ducts, one commencing within 12 inches (300 mm) of the top and one commencing within 12 inches (300 mm) of the bottom of the enclosure. The vertical ducts shall communicate directly with the outdoors. See Figure 17.

Each duct opening shall have a minimum free area of 1 square inch per 4,000 Btu/hr (550 mm<sup>2</sup> per kW) of the aggregate input rating of all appliances installed in the enclosure.

When ducts are used, they shall be of the same cross sectional area as the free area of the openings to which they connect. The minimum dimension of rectangular air ducts shall be not less than 3 inches.

## AIR FROM OTHER INDOOR SPACES

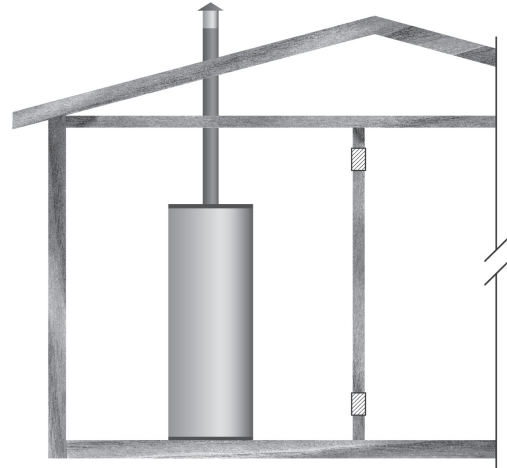

**FIGURE 18**

The confined space shall be provided with two permanent openings, one commencing within 12 inches (300 mm) of the top and one commencing within 12 inches (300 mm) of the bottom of the enclosure. See Figure 18.

Each opening shall communicate directly with an additional room(s) of sufficient volume so that the combined volume of all spaces meets the criteria for an Unconfined Space.

Each opening shall have a minimum free area of 1 square inch per 1,000 Btu/hr (2200 mm<sup>2</sup> per kW) of the aggregate input rating of all appliances installed in the enclosure. Each opening shall not be less than 100 square inches (645 cm<sup>2</sup>).

**TABLE 7. TECHNICAL DATA VENTING**

**TYPE B GAS VENT  
Multiple Gas Fired Tank-Type Heaters**

When venting multiple tank type heaters using Type B vent pipe, follow the installation diagram (figure 13) and tables below which give sizing and data based upon NFPA 54/ANSI Z223. 2006.

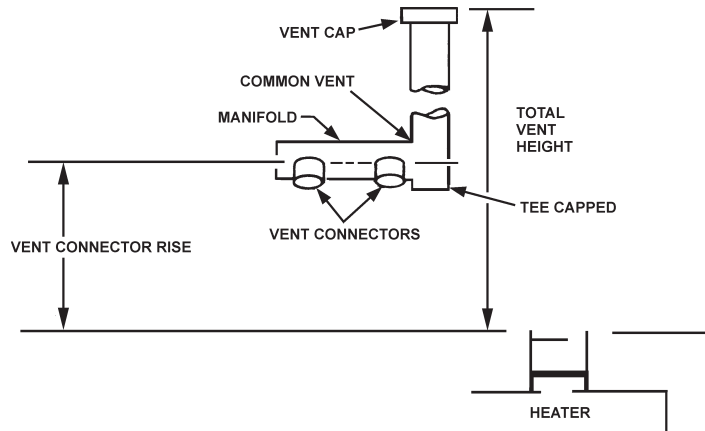

**Model 500  
Input: 500,000 btu/hr**

		Total Vent Height (Feet)							
Vent connector size: 8 inches		6	8	10	15	20	30	50	100
Input (btu/hr)	Rise	Vent Connector Diameter (Inches)							
500,000	1 Ft.	-	10	10	10	9	8	8	7
500,000	2 Ft.	10	10	10	9	9	8	8	7
500,000	3 Ft.	10	10	9	9	9	8	7	7

**Multiple Fan Assisted Water Heaters**

		Total Vent Height (Feet)							
Number of 500 Heaters	Combined Input (btu/hr)	6	8	10	15	20	30	50	100
		Manifold and Common Vent Diameter (Inches)							
2	1,000,000	14	14	12	12	10	10	9	8
3	1,500,000	16	16	14	14	14	12	12	10
4	2,000,000	18	18	16	16	14	14	12	12

**Combination of Multiple Fan Assisted and Natural Draft Water Heaters**

		Total Vent Height (Feet)							
Number of 500 Heaters	Combined Input (btu/hr)	6	8	10	15	20	30	50	100
		Manifold and Common Vent Diameter (Inches)							
2	1,000,000	16	14	14	14	12	12	10	9
3	1,500,000	18	18	16	16	14	14	12	10
4	2,000,000	20	20	18	18	16	16	14	12

# WATER HEATER INSTALLATION

## WATER LINE CONNECTIONS

This manual provides detailed installation diagrams (see pages 34-48 of this manual) for typical methods of application for the water heater(s).

## WATER (POTABLE) HEATING AND SPACE HEATING

1. All piping components connected to this unit for space heating applications shall be suitable for use with potable water.
2. Toxic chemicals, such as those used for boiler treatment, shall NEVER be introduced into this system.
3. This unit may NEVER be connected to any existing heating system or component(s) previously used with a non-potable water heating appliance.
4. When the system requires water for space heating at temperatures higher than required for domestic water purposes, a tempering valve must be installed. Please refer to installation diagrams on pages 34-48 of this manual for suggested piping arrangements.

## THERMOMETERS (NOT SUPPLIED)

Thermometers should be obtained and field installed as shown in the installation diagrams.

Thermometers are installed in the system as a means of detecting the temperature of the outlet water supply.

## WATER PIPING DIAGRAMS

This manual provides detailed water piping diagrams for typical methods of application for the water heaters, see Water Piping Diagrams beginning on page 34.

The water heater may be installed by itself, or with a separate storage tank, on both single and two-temperature systems. When used with a separate storage tank, the circulation may be either by gravity or by means of a circulating pump. When a circulating pump is used it is important to note that the flow rate should be slow so that there will be a minimum of turbulence inside the heater.

Adjust flow by throttling a full port ball valve installed in the circulating line on the outlet side of the pump. Never throttle flow on the suction side of a pump.

## T&P VALVE DISCHARGE PIPE

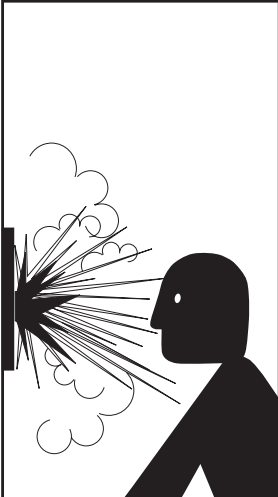
	<b>⚠ WARNING</b>
	<b>Explosion Hazard</b> <ul style="list-style-type: none"><li>• Temperature-Pressure Relief Valve must comply with ANSI Z21.22-CSA 4.4 and ASME code.</li><li>• Properly sized temperature-pressure relief valve must be installed in opening provided.</li><li>• Can result in overheating and excessive tank pressure.</li><li>• Can cause serious injury or death.</li></ul>

This water heater is provided with a properly rated/sized and certified combination temperature - pressure (T&P) relief valve by the manufacturer. See Temperature-Pressure Relief Valve on pages 13-14 for information on replacement and other requirements.

## CAUTION

### Water Damage Hazard

- Temperature-Pressure Relief Valve discharge pipe must terminate at adequate drain.

Install a discharge pipe between the T&P valve discharge opening and a suitable floor drain. Do not connect discharge piping directly to the drain unless a 6" (15.2 cm) air gap is provided. To prevent bodily injury, hazard to life, or property damage, the relief valve must be allowed to discharge water in adequate quantities should circumstances demand. If the discharge pipe is not connected to a drain or other suitable means, the water flow may cause property damage.

### T&P Valve Discharge Pipe Requirements:

- Shall not be smaller in size than the outlet pipe size of the valve, or have any reducing couplings or other restrictions.
- Shall not be plugged or blocked.
- Shall not be exposed to freezing temperatures.
- Shall be of material listed for hot water distribution.
- Shall be installed so as to allow complete drainage of both the Temperature-Pressure Relief Valve and the discharge pipe.
- Must terminate a maximum of six inches above a floor drain or external to the building. In cold climates, it is recommended that the discharge pipe be terminated at an adequate drain inside the building.
- Shall not have any valve or other obstruction between the relief valve and the drain.

The type, size and location of the relief valves must be in accordance with local codes. The locations of the relief valves shown in the installation diagrams are typical. See pages 34-48. The heater has a factory installed high temperature limit switch and temperature and pressure relief valve.

Cold water lines to heater should be installed as shown in order to minimize gravity circulation of hot water to building cold water lines.

A listed temperature and pressure relief valve of adequate capacity is installed on the heater. The locations shown in the installation diagrams on pages 34-48 are typical.

The discharge opening of the temperature and pressure relief valve must be piped to an open drain and should not be subject to freezing temperatures.

Install in accordance with all local codes.

## **INSTALLATION DIAGRAMS - TOP INLET/OUTLET USAGE**

Use of the top inlet water connection requires installation of an inlet dip tube (refer to figure 19). The tube is supplied in the heater. Follow caution labels if applying heat to this fitting. Do not allow pipe dope to contact the plastic tube during installation.

### **TUBE INLET INSTALLATION**

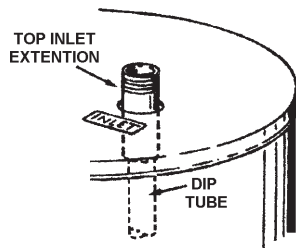

**FIGURE 19**

## **CODE RESTRICTIONS**

Use of the top inlet water connection is not permitted on installations in the state of North Carolina, due to the material of the tube (Polypropylene). Where such code restrictions exist, use only lower inlet tank connection. This may also require a heat trap - check local codes. The "Top Outlet" connection may still be used on these applications. Plug or cap all unused openings in the tank before filling with water.

**TEMPERATURE SETTING SHOULD NOT EXCEED SAFE USE TEMPERATURE AT FIXTURES. SEE WATER TEMPERATURE CONTROL AND MIXING VALVE WARNING ON PAGE 12. IF HIGHER PREHEAT TEMPERATURES ARE NECESSARY TO OBTAIN ADEQUATE BOOSTER OUTPUT, ADD AN ANTI-SCALD VALVE FOR HOT WATER SUPPLIED TO FIXTURES.**

## HEATER WIRING

All electrical work must be installed in accordance with the latest version of the National Electrical Code ANSI/NFPA No. 70 and must conform to all local code authority having jurisdiction. AN ELECTRICAL GROUND IS REQUIRED TO REDUCE RISK OF ELECTRICAL SHOCK OR POSSIBLE ELECTROCUTION.

If any of the original wire as supplied with the appliance must be replaced, use only type 105°C thermoplastic or equivalent and 250°C type F must be used for the flame sensor and igniter leads.

The controls of this water heater are polarity sensitive. Be certain to properly wire the hot and neutral connections.

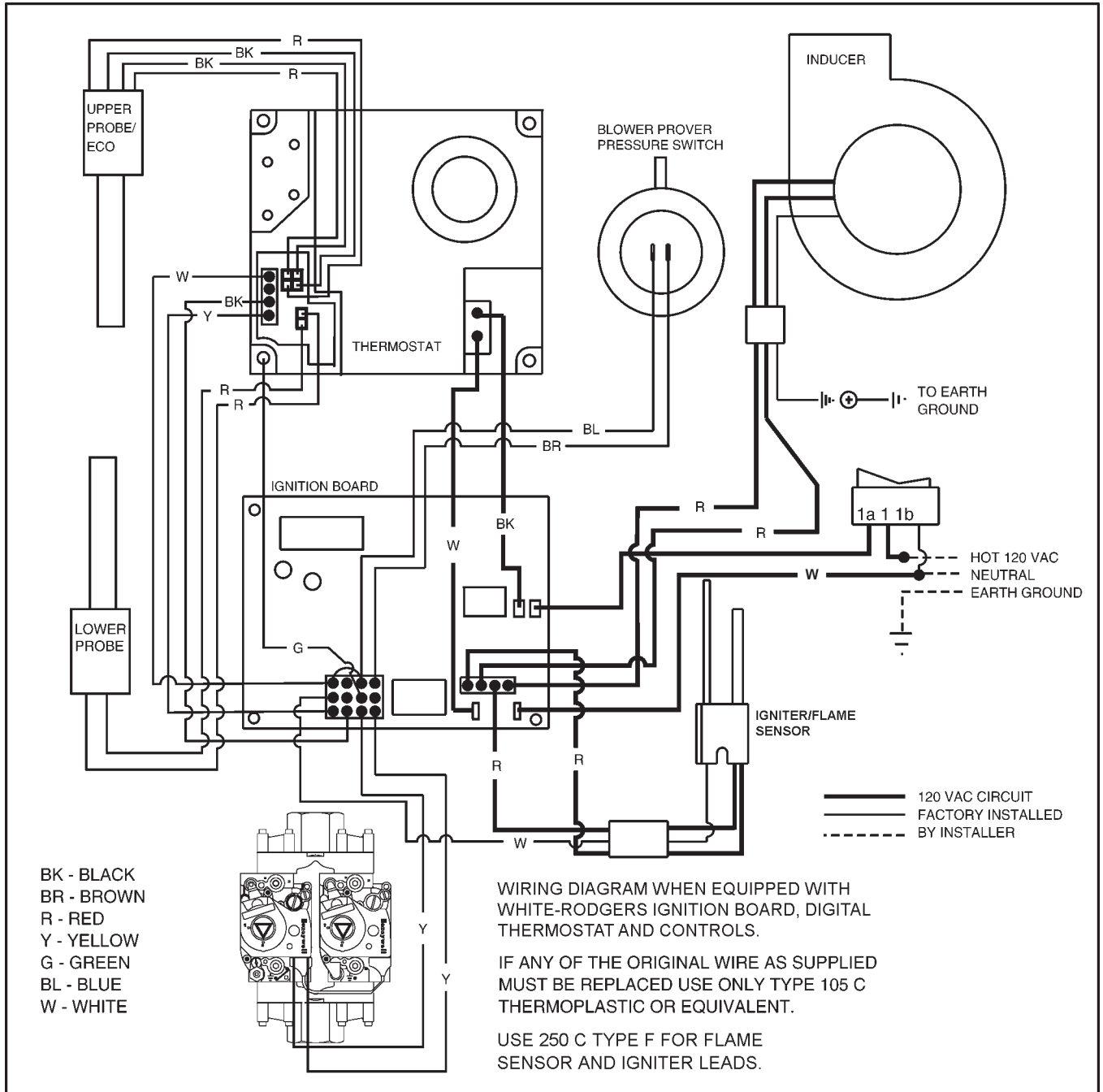

FIGURE 20

## GAS PIPING

Contact your local gas service company to ensure that adequate gas service is available and to review applicable installation codes for your area.

Size the main gas line in accordance with Table 9. The figures shown are for straight lengths of pipe at 0.5 in. W.C. pressure drop, which is considered normal for low pressure systems. Note: Fittings such as elbows, tees and line regulators will add to the pipe pressure drop. Also refer to the latest version of the National Fuel Gas Code.

Schedule 40 Metallic Pipe is the preferred material for the gas line of this water heater. It is imperative to follow the sizing recommendations in the latest version of the National Fuel Gas Code if Corrugated Stainless Steel Tubing (CSST) is used as the gas line for this water heater.

THE HEATER IS NOT INTENDED FOR OPERATION AT HIGHER THAN 14.0" W.C.- NATURAL GAS, (1/2 POUND PER SQUARE INCH GAGE) SUPPLY GAS PRESSURE. EXPOSURE TO HIGHER SUPPLY PRESSURE MAY CAUSE DAMAGE TO THE GAS VALVE WHICH COULD RESULT IN FIRE OR EXPLOSION. IF OVERPRESSURE HAS OCCURRED SUCH AS THROUGH IMPROPER TESTING OF GAS LINES OR EMERGENCY MALFUNCTION OF THE SUPPLY SYSTEM, THE GAS VALVE MUST BE CHECKED FOR SAFE OPERATION. MAKE SURE THAT THE OUTSIDE VENTS ON THE SUPPLY REGULATORS AND THE SAFETY VENT VALVES ARE PROTECTED AGAINST BLOCKAGE. THESE ARE PARTS OF THE GAS SUPPLY SYSTEM, NOT THE HEATER. VENT BLOCKAGE MAY OCCUR DURING ICE STORMS.

**TABLE 9 - GAS SUPPLY PIPE LENGTH (FEET)**

Schedule 40 metallic pipe nominal dia.	500,000 btu/hr input rate MAXIMUM EQUIVALENT PIPE LENGTH (FEET)	
	Natural Gas	Propane
3/4"	-	10
1"	10	40
1 1/4"	60	150
1 1/2"	150	350
2"	200	400
2 1/2"	200	400

Natural Gas: 0.60 Specific Gravity, 0.50"W.C. pressure drop  
Propane Gas: 1.50 Specific Gravity, 0.50"W.C. pressure drop

IT IS IMPORTANT TO GUARD AGAINST GAS VALVE FOULING FROM CONTAMINANTS IN THE GAS WAYS. SUCH FOULING MAY CAUSE IMPROPER OPERATION, FIRE OR EXPLOSION.

IF COPPER SUPPLY LINES ARE USED THEY MUST BE INTERNALLY TINNED AND CERTIFIED FOR GAS SERVICE. BEFORE ATTACHING THE GAS LINE, BE SURE THAT ALL GAS PIPE IS CLEAN ON THE INSIDE.

TO TRAP ANY DIRT OR FOREIGN MATERIAL IN THE GAS SUPPLY LINE, A DIRT LEG (SOMETIMES CALLED SEDIMENT TRAP OR DRIP LEG) MUST BE INCORPORATED IN THE PIPING (SEE FIG. 21). THE DIRT LEG MUST BE READILY ACCESSIBLE AND NOT SUBJECT TO FREEZING CONDITIONS. INSTALL IN ACCORDANCE WITH RECOMMENDATIONS OF SERVING GAS SUPPLIERS. REFER TO THE LATEST VERSION OF THE NATIONAL FUEL GAS CODE.

To prevent damage, care must be taken not to apply too much torque when attaching gas supply pipe to gas valve inlet.

Apply joint compounds (pipe dope) sparingly and only to the male threads of pipe joints. Do not apply compounds to the first two threads. Use compounds resistant to the action of liquefied petroleum gases.

BEFORE PLACING THE HEATER IN OPERATION, CHECK FOR GAS LEAKAGE. Use soap and water solution or other material acceptable for the purpose in locating the leaks. DO NOT USE MATCHES, CANDLES, FLAME OR OTHER SOURCES OF IGNITION FOR THIS PURPOSE.

DISCONNECT THE HEATER AND ITS MANUAL GAS SHUTOFF VALVE FROM THE GAS SUPPLY PIPING SYSTEM DURING ANY SUPPLY PRESSURE TESTING EXCEEDING 1/2 PSIG. GAS SUPPLY LINE MUST BE CAPPED WHEN DISCONNECTED FROM THE HEATER. FOR TEST PRESSURES OF 1/2 PSIG OR LESS THE APPLIANCE NEED NOT BE DISCONNECTED, BUT MUST BE ISOLATED FROM THE SUPPLY PRESSURE TEST BY CLOSING THE MANUAL GAS SHUTOFF VALVE.

**GAS PIPING AND DIRT LEG INSTALLATION**

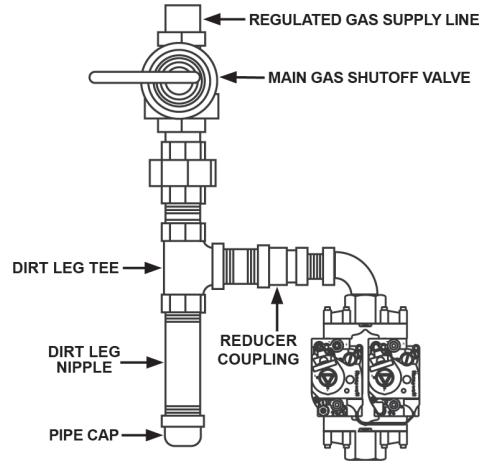

**FIGURE 21**

## PURGING

Gas line purging is required with new piping or systems in which air has entered.

PURGING SHOULD BE PERFORMED BY PERSONS EXPERIENCED IN THIS TYPE GAS SERVICE. TO AVOID RISK OF FIRE OR EXPLOSION, PURGE DISCHARGE MUST NOT ENTER CONFINED AREAS OR SPACES WHERE IGNITION CAN OCCUR. THE AREA MUST BE WELL VENTILATED AND ALL SOURCES OF IGNITION MUST BE INACTIVATED OR REMOVED.

## GAS METER SIZE — NATURAL GASES ONLY

Be sure the gas meter has sufficient capacity to supply the full rated gas input of the water heater as well as the requirements of all other gas fired equipment supplied by the meter. If gas meter is too small, ask the gas company to install a larger meter having adequate capacity.

## GAS PRESSURE REGULATOR

The gas pressure regulator is built into the gas valve and is equipped to operate on the gas specified on model and rating plate. The regulator is factory adjusted to deliver gas to burner at correct water column pressure allowing for a nominal pressure drop through the controls.

The minimum gas supply pressure for input adjustment must not be less than 4.5" W.C. (1.12 kPa) for natural gas or 11.0"W.C. (2.74 kPa) for propane gas.

Do not subject the combination gas valve to inlet gas pressures of more than 14.0" W.C. (3.48 kPa). A service regulator is necessary if higher gas pressures are encountered.

The manifold gas pressure specified in Table 10 refers to the gas pressure measured at the pressure tap of the automatic gas valve when the burners are firing.

**TABLE 10 - MANIFOLD GAS PRESSURE IN INCHES OF WATER COLUMN (ALL MODELS\*)**

TYPE OF GAS	
NATURAL	PROPANE
3.5 (0.87 kPa)	10.0 (2.49 kPa)

# OPERATION

## IMPORTANT

A qualified person must perform the initial firing of the heater. At this time the user should not hesitate to ask the individual any questions which they may have in regard to the operation and maintenance of the unit.

An Operational Checklist is included on page 33 of this manual. By using this checklist the user may be able to make minor operational adjustments and avoid unnecessary service calls. However, the user should not attempt repairs which are not listed under the USER column.

## GENERAL

NEVER OPERATE THE HEATER WITHOUT FIRST BEING CERTAIN IT IS FILLED WITH WATER AND A TEMPERATURE AND PRESSURE RELIEF VALVE IS INSTALLED IN THE RELIEF VALVE OPENING OF THE HEATER.

SHOULD OVERHEATING OCCUR OR THE GAS SUPPLY FAIL TO SHUT OFF, TURN OFF THE MANUAL GAS CONTROL VALVE TO THE APPLIANCE.

Before proceeding with the operation of the unit make sure the water heater and system are filled with water and all air is expelled.

## FILLING

1. Close the heater drain valve by turning handle clockwise.
2. Open a nearby hot water faucet to permit the air in the system to escape.
3. Fully open the cold water inlet pipe valve allowing the heater and piping to be filled.
4. Close the hot water faucet as water starts to flow.
5. The heater is ready to be operated.

THE GAS VALVE MUST HAVE BEEN IN THE OFF POSITION FOR AT LEAST 5 MINUTES. This waiting period is an important safety step. Its purpose is to permit gas that may have accumulated in the combustion chamber to clear. IF YOU DETECT GAS ODOR AT THE END OF THIS PERIOD DO NOT PROCEED WITH LIGHTING. RECOGNIZE THAT GAS ODOR, EVEN IF IT SEEMS WEAK, MAY INDICATE PRESENCE OF ACCUMULATED GAS SOMEPLACE IN THE AREA WITH RISK OF FIRE OR EXPLOSION. SEE THE FRONT PAGE FOR STEPS TO BE TAKEN.

All gas and water lines must be leak tested and open.

Read SEQUENCE OF OPERATION section of this manual prior to lighting and operating this appliance.

With above conditions satisfied, start the unit in accordance with the instructions on the operating label attached to the heater. For your convenience a copy of the instructions are shown on page 24. Each heater is equipped with an ignition control board. The controller will try three times to light the main burner before going into lockout. After the controller tries three times, it will wait one hour before trying to light the unit again. This cycle will continue until the main burners are ignited or the unit is shut down.

## ADJUSTMENTS

ON INITIAL STARTUP SOME ADJUSTMENTS ARE NECESSARY.

1. CHECK MANIFOLD AND INLET GAS PRESSURES.
2. CYCLE CHECK - CHECK AT LEAST ONE BURNER OPERATION - WHEN THERMOSTAT IS SATISFIED, BURNER WILL SHUT OFF AND INDUCER WILL STOP RUNNING. ON CALL FOR HEAT - THE INDUCER WILL COME ON AND CLOSE THE PRESSURE SWITCH AND THE IGNITION SEQUENCE DESCRIBED ABOVE WILL BEGIN, SEE "SEQUENCE OF OPERATION".

# SEQUENCE OF OPERATION

The following information will describe the Sequence of Operation for this appliance.

1. Switch power on to unit.
2. Thermostat calls for heat.
3. Ignition Control Board performs diagnostic check on system components.
4. On completion of diagnostics check, the Ignition Control Board sends signal to Exhaust Inducer.
5. Exhaust Inducer begins drawing air through appliance closing the Prover Switch.
6. On completion of Prover Switch engagement, the Ignition Control Board begins the ignition cycle.
7. The Ignition Control Board provides power to the Silicon Nitride Ignitor.
8. The Silicon Nitride Ignitor heats up for approximately 17 to 20 seconds.
9. At the end of Silicon Nitride Ignitor's warm-up, the Ignition Control Board opens the Gas Valve.
10. From the time the Gas Valve opens, the Ignition Control

Board waits 3 seconds and then shuts off power to the Silicon Nitride Ignitor.

11. From the time the Silicon Nitride Ignitor's power is shut off, the Ignition Control Board waits 3 more seconds to monitor the Flame Sensor.
12. If the Flame Sensor does not detect a strong enough flame, the Ignition Control Board shuts off the Gas Valve and allows the Exhaust Inducer to purge the unit for 20 seconds. At that time, the Ignition Control Board restarts with step 7. It will try and ignite the main burners 2 more times. If the unit does not light, the Ignition Control Board will wait one hour and then restart at step 3. This cycle will continue until the unit lights or the power is shutoff to the unit.
13. If the Flame Sensor detects a strong flame, the Ignition Control Board will allow the unit to operate until the thermostat is satisfied.
14. Once the unit is satisfied, the Ignition Control Board will shut off the Gas Valve and the unit will be in standby mode until another call for heat is initiated by the thermostat.

See the flow chart on page 32 for more information.

## LIGHTING & OPERATION LABEL

### FOR YOUR SAFETY READ BEFORE OPERATING



**WARNING** If you do not follow these instructions exactly, a fire or explosion may result causing property damage, personal injury, or loss of life.



- A. This appliance does not have a pilot. It is equipped with an ignition device which automatically lights the burner. Do **not** try to light the burner by hand.
- B. BEFORE OPERATING smell all around the appliance area for gas. Be sure to smell next to the floor because some gas is heavier than air and will settle on the floor.

#### "WHAT TO DO IF YOU SMELL GAS"

- Do not try to light any appliance.
- Do not touch any electric switch; do not use any telephone in your building.
- Immediately call your gas supplier from a neighbor's telephone. Follow the gas suppliers instructions.

- If you cannot reach your gas supplier, call the fire department.

- C. Use only your hand to push in or turn the gas control knob. Never use tools. If the knob will not push in or turn by hand, don't try to repair it. Call a qualified service technician. Force or attempted repair may result in a fire or explosion.

- D. Do not use this appliance if any part has been under water. Immediately call a qualified service technician to inspect the appliance and to replace any part of the control system and any gas control which has been under water.

### OPERATING INSTRUCTIONS

1. STOP! Read the safety information above on this label.
2. Set thermostat to lowest setting.
3. Turn off all electric power to the appliance.
4. This appliance is equipped with an ignition device which automatically lights the burner. Do **not** try to light the burner by hand.
5. Push in gas control knobs slightly and turn clockwise to off.
6. Wait five(5) minutes to clear out any gas. If you then smell gas, Follow "B" in the safety information above on this label. If you smell gas, go on to next step. STOP! don't
7. Turn gas control knobs counterclockwise to "ON".
8. Turn on all electric power to the appliance.
9. Set thermostat to desired setting.
10. If the appliance will not operate, follow the instructions "To Turn Off Gas To Appliance" and call your service technician or gas supplier.

#### GAS CONTROL KNOBS

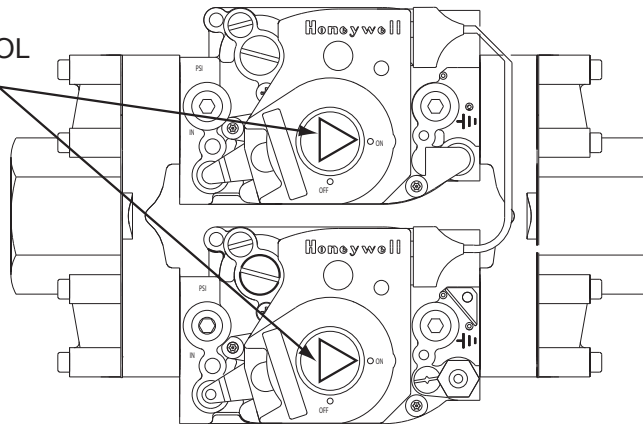

### FOR YOUR SAFETY READ BEFORE OPERATING

1. Set the thermostat to lowest setting.
2. Turn off all electric power to appliance if service is to be performed.
3. Push in gas control knobs slightly and turn clockwise to "OFF". Do not force.

FIGURE 22



## CHECK VENTING

The following steps shall be followed with each appliance connected to the venting system placed in operation, while any other appliances connected to the venting system are not in operation.

1. Seal any unused openings in the venting system.
2. Inspect the venting system for proper size and horizontal pitch, as required in the National Fuel Gas Code, ANSI Z223.1 or the CAN/CGA B149 Installation Codes and these instructions. Determine that there is no blockage or restriction, leakage, corrosion and other deficiencies which could cause an unsafe condition.
3. So far as is practical, close all building doors and windows and all doors between the space in which the water heater(s) connected to the venting system are located and other spaces of the building. Turn on all appliances not connected to the venting system. Turn on all exhaust fans, such as range hoods and bathroom exhausts, so they shall operate at maximum speed. Close fireplace dampers.
4. Follow the lighting instruction. Place the water heater being inspected in operation. Adjust thermostat so appliance shall operate continuously.
5. Test for spillage at the burner level after 5 minutes of main burner operation.
6. After it has been determined that each water heater connected to the venting system properly vents when tested as outlined above, return doors, windows, exhaust fans, fireplace dampers and any other gas burning appliance to their previous conditions of use.
7. If improper venting is observed during any of the above tests, the venting system must be corrected.

FAILURE TO CORRECT BACK DRAFTS MAY CAUSE AIR CONTAMINATION AND UNSAFE CONDITIONS.

- If the back draft cannot be corrected by the normal method or if a suitable draft cannot be obtained, a blower type flue gas exhauster must be employed to assure proper venting and correct combustion.

## CHECK THE IGNITER ASSEMBLY

At least once a year, check the igniter assembly, Figure 23, and the main burner, Figure 24, for proper operation. Refer to the following igniter assembly and main burner sections.

### IGNITER ASSEMBLY

For access to igniter assembly, unfasten two screws to burner cover and remove. Locate the burner with the igniter assembly and remove screw holding burner to manifold. Slide burner out to access igniter assembly.

Servicing of the igniter assembly includes keeping the igniter free of lint, scale or any other foreign debris.

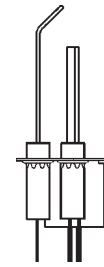

FIGURE 23

## MAIN BURNER

The main burner, figure 24, should display the following characteristics:

- Cause rapid ignition and carry across entire burner.
- Give reasonably quiet operation during ignition, burning, and extinction.
- Cause no excessive lifting of flame from burner ports.



FIGURE 24

If the preceding burner characteristics are not evident, check for accumulation of lint, scale or other foreign debris that restricts or blocks the air openings to the burner or heater.

NOTE:

1. Remove main burners from unit.
2. Check that burner venturi and ports are free of foreign debris.
3. Clean burners with bristle brush and/or vacuum cleaner - DO NOT distort burner ports or pilot location.
4. Reinstall burners in unit. Make sure front and rear of burners are installed correctly in burner support brackets.

Also check for good flow of combustion and ventilating air to the unit. Maintain a clear area around the heater at all times.

## GAS VALVES

Figure 25 shows the type of combination manual gas control valve and regulator used on these heaters.

If the gas valve becomes defective, repairs should not be attempted. A new valve should be installed in place of the defective one.

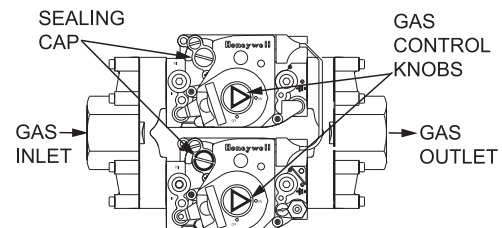

FIGURE 25

## CHECKING THE INPUT

For appliance installation locations with elevations above 2000 feet, refer to HIGH ALTITUDE INSTALLATIONS section of this manual for input reduction procedure.

1. Attach a pressure gauge or a manometer to the manifold pressure tap on the gas valve and refer to Table 3, page 8 for correct manifold pressure.
2. Use this formula to "clock" the meter. Be sure that other gas consuming appliances are not operating during this interval.

$$(3600/T) \times H = \text{Btuh}$$

T = Time in seconds to burn one cubic foot of gas.

H = Btu's per cubic foot of gas.

Btuh = Actual heater input.

Example: (Using BCG385T500-8N heater)

T = 7.56 seconds

H = 1050 Btu

Btuh = ?

$(3600/7.56) \times 1050 = 500,000 \text{ Btuh}$  (Compare with the BCG385T500-8N model and rating.)

Should it be necessary to adjust the gas pressure to the burners to obtain the full input rate, the steps below should be followed:

3. Remove the regulator adjustment sealing cap, fig. 25, and adjust the pressure by turning the adjusting screw with a screwdriver.



Clockwise to increase gas pressure and input rate.



Counterclockwise to decrease gas pressure and input rate.

4. "Clock" the meter as in step 2 above.
5. Repeat steps 3 and 4 until the specified input rate is achieved.
6. Turn the gas control knob to PILOT. Remove the pressure gauge and replace the sealing cap and the threaded plug in the pressure tap opening.

UNDER NO CIRCUMSTANCES SHOULD THE GAS INPUT EXCEED THE INPUT SHOWN ON THE HEATER MODEL AND RATING PLATE. OVERFIRING COULD RESULT IN DAMAGE OR SOOTING OF THE HEATER.

## MAINTENANCE

### VENTING SYSTEM

Examine the venting system every six months for obstructions and/or deterioration of the vent piping.

Remove all soot or other obstructions from chimney which will retard free draft.

### REMOTE STORAGE TANK TEMPERATURE CONTROL

The water temperature in the remote storage tank (if used) is controlled by the storage tank temperature control. The sensing element is mounted in the hot water storage tank, see Water Piping Diagram section.

A change in water temperature in the storage tank lower than the tank temperature control setting will cause the sensor to activate the circulating pump. The pump then circulates the water through the heater where the thermostat senses the drop in water temperature and activates main burner operation of the appliance.

If the storage tank temperature control is out of calibration, replace with new control.

SHOULD OVERHEATING OCCUR OR THE GAS SUPPLY FAIL TO SHUT OFF, TURN OFF THE MANUAL GAS CONTROL VALVE TO THE APPLIANCE.

### TEMPERATURE-PRESSURE RELIEF VALVE TEST

**⚠ DANGER**

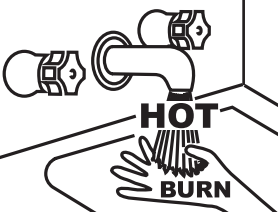

- Burn hazard.
- Hot water discharge.
- Keep clear of Temperature-Pressure Relief Valve discharge outlet.

It is recommended that the Temperature-Pressure Relief Valve should be checked to ensure that it is in operating condition every 6 months.

When checking the Temperature-Pressure Relief Valve operation, make sure that (1) no one is in front of or around the outlet of the Temperature-Pressure Relief Valve discharge line, and (2) that the water discharge will not cause any property damage, as the water may be extremely hot. Use care when operating valve as the valve may be hot.

To check the relief valve, lift the lever at the end of the valve several times, see Figure 26. The valve should seat properly and operate freely.

If after manually operating the valve, it fails to completely reset and continues to release water, immediately close the cold water inlet to the water heater and drain the water heater according to the Draining and Flushing instructions on page 27. Replace the Temperature-Pressure Relief Valve with a properly rated/sized new one, see Temperature-Pressure Relief Valve on pages 13-14 for instructions on replacement.

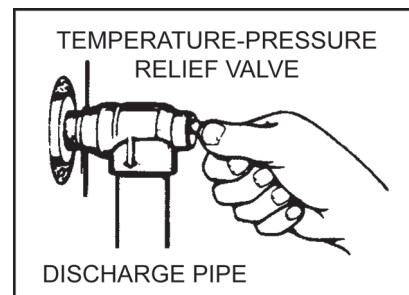

FIGURE 26

If the Temperature-Pressure Relief Valve on the water heater weeps or discharges periodically, this may be due to thermal expansion.

NOTE: Excessive water pressure is the most common cause of Temperature-Pressure Relief Valve leakage. Excessive water system pressure is most often caused by "thermal expansion" in a "closed system." See Closed Water Systems and Thermal

Expansion on page 13. The Temperature-Pressure Relief Valve is not intended for the constant relief of thermal expansion.

Temperature-Pressure Relief Valve leakage due to pressure build up in a closed system that does not have a thermal expansion tank installed is not covered under the limited warranty. Thermal expansion tanks must be installed on all closed water systems.

**DO NOT PLUG THE TEMPERATURE-PRESSURE RELIEF VALVE OPENING. THIS CAN CAUSE PROPERTY DAMAGE, SERIOUS INJURY OR DEATH.**

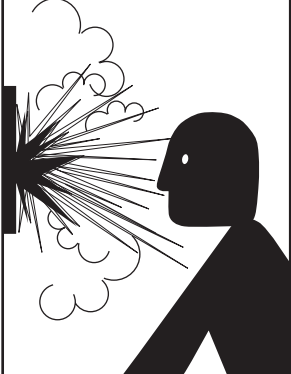
	<b>⚠ WARNING</b>
	<b>Explosion Hazard</b> <ul style="list-style-type: none"><li>• Temperature-Pressure Relief Valve must comply with ANSI Z21.22- CSA 4.4 and ASME code.</li><li>• Properly sized temperature-pressure relief valve must be installed in opening provided.</li><li>• Can result in overheating and excessive tank pressure.</li><li>• Can cause serious injury or death.</li></ul>

### HOT WATER ODOR

On occasion, hot water may develop a strong odor. If this occurs drain the heater completely, flush thoroughly, and refill. If the problem persists, chlorination of the heater and replacement of magnesium anodes with aluminum anodes may correct the condition.

Occasionally water softener companies recommend removal of heater anodes for odor reasons.

Unauthorized removal of the anode(s) will void the warranty. For further information contact your dealer.

### ANODE ROD INSPECTION

<b>CAUTION</b>
<b>Property Damage Hazard</b>
<ul style="list-style-type: none"><li>• Avoid water heater damage.</li><li>• Inspection and replacement of anode rod required.</li></ul>

The heater tank is equipped with anode rods to provide corrosion control. At least once a year the anode rods should be checked to determine if replacement is necessary. Initially the anode rods are approximately 7/8" in diameter with a 1/8" diameter steel core wire running down the center of the anode material. **THE ANODES SHOULD BE REPLACED** when the 1/8" diameter core wire is visible as this means that the anode material has been expended in the control of corrosion.

For models with top inlet and outlet, it is recommended that, before removing the inner cover for cleaning, inspection or removal of inner parts, you obtain two new nipple collars, part no. 9005783205. The nipple collars on the heater will usually be damaged when removed. New nipple collars will insure that the seal is such as to prevent leakage of flue products when properly installed.

**NOTE:** Anode rod inspection may need to be made more frequently in areas subject to acid rain that obtains their water supply from surface water as the low pH will accelerate anode activity.

**CAUTION:** Close cold water inlet valve serving heater and open nearby hot water faucet to relieve the pressure in the heater before attempting to remove anode(s) for inspection.

### DRAINING AND FLUSHING

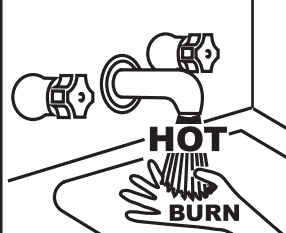
<b>⚠ DANGER</b> 	<ul style="list-style-type: none"><li>• Burn hazard.</li><li>• Hot water discharge.</li><li>• Keep hands clear of drain valve discharge.</li></ul>
---	--

It is recommended that the water heater storage tank be drained and flushed every 6 months to reduce sediment buildup. The water heater should be drained if being shut down during freezing temperatures.

#### TO DRAIN THE WATER HEATER STORAGE TANK:

1. Turn off the electrical supply to the water heater.
2. Turn off the gas supply at the Main Gas Shutoff Valve if the water heater is going to be shut down for an extended period.
3. Ensure the cold water inlet valve is open.
4. Open a nearby hot water faucet and let the water run until the water is no longer hot.
5. Close the cold water inlet valve to the water heater.
6. Connect a hose to the water heater drain valve and terminate it to an adequate drain.
7. Open the water heater drain valve and allow all the water to drain from the storage tank.
8. Close the water heater drain valve when all water in the storage tank has drained.
9. Close the hot water faucet opened in Step 4.
10. If the water heater is going to be shut down for an extended period, the drain valve should be left open.

#### TO FLUSH THE WATER HEATER STORAGE TANK:

1. Turn off the electrical supply to the water heater.
2. Ensure the cold water inlet valve is open.
3. Open a nearby hot water faucet and let the water run until the water is no longer hot. Then close the hot water faucet.
4. Connect a hose to the drain valve and terminate it to an adequate drain.
5. Ensure the drain hose is secured before and during the entire flushing procedure. Flushing is performed with system water pressure applied to the water heater.
6. Open the water heater drain valve to flush the storage tank.
7. Flush the water heater storage tank to remove sediment and allow the water to flow until it runs clean.
8. Close the water heater drain valve when flushing is completed.
9. Remove the drain hose.
10. Fill the water heater - see Filling The Water Heater in this manual.
11. Turn on the electrical supply to place the water heater back in operation.
12. Allow the water heater to complete several heating cycles to ensure it is operating properly.

## RECOMMENDED PROCEDURE FOR PERIODIC REMOVAL OF LIME DEPOSITS FROM TANK TYPE COMMERCIAL WATER HEATERS

The amount of calcium carbonate (lime) released from water is in direct proportion to water temperature and usage, see chart. The higher the water temperature or water usage, the more lime deposits are dropped out of the water. This is the lime scale which forms in pipes, heaters and on cooking utensils.

Lime accumulation not only reduces the life of equipment but also reduces efficiency of the heater and increases fuel consumption.

The usage of water softening equipment greatly reduces the hardness of the water. However, this equipment does not always remove all of the hardness (lime). For this reason it is recommended that a regular schedule for deliming be maintained.

The time between cleaning will vary from weeks to months depending upon water conditions and usage.

The depth of lime buildup should be measured periodically. Heaters equipped with cleanouts will have about 2" of lime buildup when the level of lime has reached the bottom of the cleanout opening. A schedule for deliming should then be set up, based on the amount of time it would take for a 1" buildup of lime. It is recommended that the water heater initially be inspected after 6 months.

### Example 1:

The initial inspection after 6 months shows 1/2" of lime accumulation. Therefore, the heater should be delimed once a year.

### Example 2:

The initial inspection after 6 months shows 2" of lime accumulation. Therefore, the heater should be delimed every 3 months.

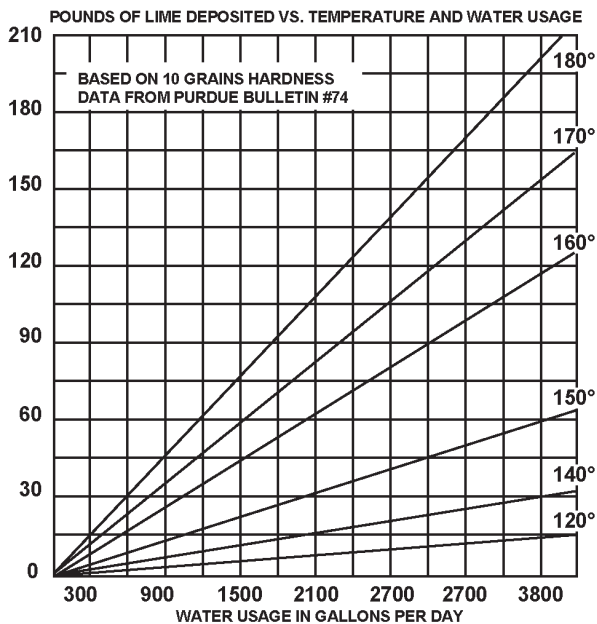

FIGURE 27.

## DELIMING SOLVENTS

A. O. Smith recommends the use of UN•LIME for deliming. UN•LIME is a patented food grade acid which is safe to handle and does not create the harmful fumes which are associated with other products.

UN•LIME may be obtained from your dealer, distributor or A. O. Smith Product Service Division. Order Part Number 9005416105, 1 gallon, packed 4 gallons per case or Part Number 9005417105, 5 gallon container.

NOTE: Un•Lime is not available for use in Canada.

Hydrochloric base acids are not recommended for use on glass lined tanks.

Observe handling instructions on label of product being used.

## TANK CLEANOUT PROCEDURE

The following practices will ensure longer life and enable the unit to operate at its designed efficiency:

1. Once a month the heater should be flushed. Open the drain valve and allow two gallons of water to drain from the heater. Inlet water valve should remain open to maintain pressure in tank.
2. A cleanout opening is provided for periodic cleaning of the tank. Gas must be shut off and heater drained before opening cleanout.

**To clean heater through cleanout opening, proceed as follows:**

3. Drain heater.
4. Remove outer cover plate from lower side of heater jacket.
5. Remove six (6) hex head screws securing tank cleanout plate and remove plate.
6. Remove lime, scale, or sediment using care not to damage the glass lining.
7. Inspect cleanout plate gasket, if new gasket is required, replace with part no. 9004099215.
8. Install cleanout plate. Be sure to draw plate up tight by tightening screws securely.
9. Replace outer jacket cover plate.

In some water areas the sediment might not be removed by this method and may result in the water heater making rumbling or boiling noises. To dissolve and remove these more stubborn mineral deposits, A. O. Smith UN•LIME Professional Delimer should be used.

## DELIMING USING FLO-JUG METHOD

UN•LIME in the 5 gallon size is recommended for deliming of all models. Contact your local A.O. Smith dealer, distributor or, A.O. Smith Water Products Company:

Telephone: (800) 433-2545

Fax: (800) 433-2515

Website: [www.hotwater.com/parts](http://www.hotwater.com/parts)

### Prepare the Water Heater

To delime the water heater using the Flo-Jug method, first prepare the heater for deliming.

**WARNING**

**Explosion Hazard**

- Flammable hydrogen gases may be present.
- Keep all ignition sources away from faucet when turning on hot water.

Do not smoke or have open flame or sparks in vicinity of heater. Do not mix UN•LIME with other chemicals. Do not allow contact with magnesium, aluminum or galvanized metals.

<b>CAUTION</b>	
<b>Chemical Hazard</b>	
	<ul style="list-style-type: none"> <li>• Product contains phosphoric acid.</li> <li>• Keep out of reach of children.</li> <li>• Use rubber or neoprene gloves.</li> </ul>

UN•LIME contains phosphoric acid. In case of external contact, flush with cool water. If irritation persists, get medical attention. If swallowed, give 1 or 2 glasses of water or milk and call physician.

Get immediate medical attention for contact with eyes. Keep out of reach of children.

**NOTE: THE USE OF RUBBER OR NEOPRENE GLOVES IS RECOMMENDED, ESPECIALLY IF YOU HAVE ANY OPEN SORES OR CUTS TO AVOID UNNECESSARY IRRITATION OR DISCOMFORT.**

1. Turn off fuel and/or power supply to heater. Also, turn off power to any electrical device or equipment, which is attached, or part of the system.
2. Open hot water side of faucet closest to heater and allow water to run until it is cool enough to handle safely.
3. Close cold water inlet valve to heater.
4. Connect hose to drain valve at bottom of heater and start draining heater into suitable floor drain area.
5. Remove relief valve while heater is draining. NOTE: Do not replace relief valve until deliming is completed. Relief valve opening will also act as a vent in case of possible contact between the delimer and the anode rod(s), which may produce flammable hydrogen-air mixtures.
6. If relief valve appears to be limed-up, place it in a clean glass or plastic container adequate in size so that you can pour enough UN•LIME® into the container to cover the valve and allow space for foaming. When foaming stops, run fresh cool water into the container and rinse the relief valve for a few minutes.
7. If heater does not drain completely after a reasonable length of time, turn off the main water supply valve to stop water from entering the tank due to a by-pass problem or defective cold water inlet valve. Also, check for clogged drain valve opening. Heater must be completely drained before introducing UN•LIME.
8. Remove the cleanout cover and place a clean plastic bucket next to the cleanout opening.

Partially open the cold water inlet valve to allow time to accomplish the following and then close the valve.

While the water is being run through the tank, insert a stiff wire, copper tube flattened at one end or an opened wire coat hanger through the cleanout opening and scrape out any loose deposits of scale or sediment. This is an economical way to avoid unnecessary usage of the deliming solution.

Repeat the opening and closing of the cold water inlet valve as necessary but be sure the heater is completely drained when ready to introduce the UN•LIME.

Upon completion, reinstall the cleanout cover and use a new cleanout cover gasket (part number 9004099215).

Remove the drain valve.

9. Install the long plastic male adapter insert fitting into the drain valve opening of heater after applying Teflon tape or paste to threads. Tighten firmly by hand and use wrench or adjustable pliers to check for secure connection. Do not over tighten to avoid damage to threads and fittings.

#### Prepare the Up-N-Down Transfer Kit

The next step is the preparation of the Up-N-Down Transfer Kit, if you have not already done so:

1. With the 5 gallon Up-N-Down container in the vertical position, unscrew the plastic vent cap in the handle and pierce the plastic membrane over the vent boss under the cap to allow the container to vent.
 

**Note:** If your container does not have the vent cap and vent boss, drill a 3/16" hole in the handle. When you have finished deliming you will be able to plug this drilled vent with the stainless steel screw that is supplied with the kit.
2. Remove the container's cap and cut the plastic membrane located in the 3/4" IPT opening in the cap. Take care to not damage the threads.
3. Find the 3/4" male adapter, apply teflon tape to the threaded end and screw it into the 3/4" IPT opening in the cap.
4. Put cap with male adapter back on the container and slide 3/4" hose over end of male adapter and fasten in place using hose clamp provided.

#### Delime using Flo-Jug Method

5. Slide the hose clamp over end of hose and slide hose over the male adapter in the water heater drain opening and secure in place using hose clamp.
6. Lift container to the "Pour" Position, see Figure 28, being careful to keep the vent in the handle above the liquid level and pour the UN•LIME into the heater.
7. Lower container, you may have to place the container on its empty carton to prevent the UN•LIME from flowing back into the container.
8. Let UN•LIME remain in the heater for 5 minutes and then lower the container to the "Drain" Position, see Figure 28.
9. Deliming activity is indicated by foaming on the surface of the UN•LIME. If there is deliming activity, repeat steps 6 thru 8.

Normally, lime removal will be completed within one hour. Severe build-up of lime may take longer than an hour to complete descaling.

Note: To check UN•LIME for continued use, place some scale or white chalk in a glass with a small amount of UN•LIME. If the material is vigorously dissolved by the UN•LIME, it can be reused; if not, the UN•LIME should be replaced.

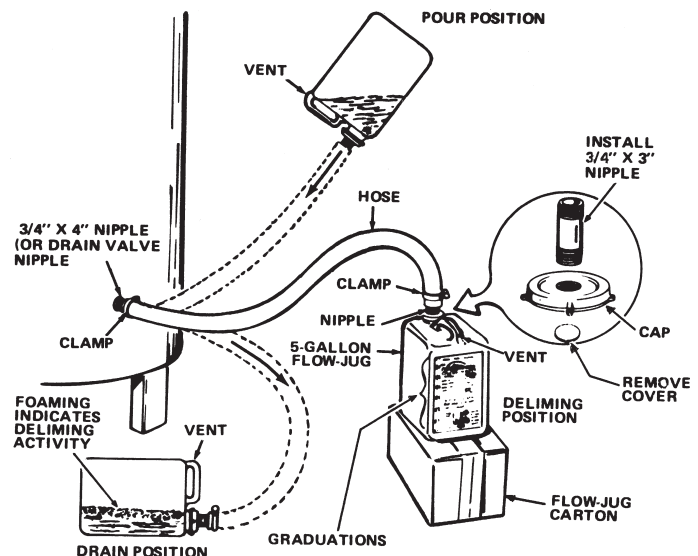

FIGURE 28.

## IGNITION MODULE SYSTEM

Before calling your service agent, the following checklist should be examined to eliminate obvious problems from those requiring replacement or servicing.

- Check that “main manual gas shutoff valve” is fully open and that gas service has not been interrupted.
- Check that after following the appliance OPERATING INSTRUCTIONS, the “Top Knob” of the appliance gas valve is in “ON” position.
- Check electrical supply to the appliance for possible blown (or tripped) fusing or power interruption. Also check the 3 amp fuse on the front of the digital thermostat (Fig. 2).
- Is the water temperature in tank below the thermostat dial setting on the appliance thermostat (calling for heat)?
- It is possible that the high limit (E.C.O.) has functioned to shut off the appliance. See High Limit page 7 - High Limit Switch for reset procedure. Contact your service agent if limit continues to function to shut off appliance.

## SYSTEM DIAGNOSTICS

Your water heater is equipped with an ignition module that incorporates a diagnostic system to assist in troubleshooting the appliance. The indicator codes on the ignition module are as follows:

**TABLE 11:**

1 FLASH	System lockout (retries or cycles exceeded)
2 FLASHES	Pressure switch stuck close
3 FLASHES	Pressure switch stuck open
4 FLASHES	Open on high temperature limit switch (eco)
6 FLASHES	115 volt AC power reversed (check polarity)
7 FLASHES	Low flame sense signal (make sure flame sensor is in burner flame)
8 FLASHES	Check ignitor

continuous flash -> continuous flame sensed > 5 seconds without gas valve

continuous on -> internal control failure - replace ignition control module.

Use this diagnostic system in conjunction with the “OPERATIONAL CHECKLIST” and the “SEQUENCE OF OPERATION” to troubleshoot the appliance.

## SERVICE

The installer may be able to observe and correct certain problems which may arise when the unit is put into operation. HOWEVER, it is recommended that only qualified service agents, using appropriate test equipment, be allowed to service the heater.

As preliminary step, check wiring against diagram, check for grounded, broken or loose wires. Check all wire ends to be sure that they are making good contact.

### ELECTRICAL SERVICING

LABEL ALL WIRES PRIOR TO DISCONNECTION WHEN SERVICING CONTROLS. WIRING ERRORS CAN CAUSE IMPROPER AND DANGEROUS OPERATION.

VERIFY PROPER OPERATION AFTER SERVICING.

## FOR YOUR INFORMATION

### START UP CONDITIONS

#### SMOKE/ODOR

It is not uncommon to experience a small amount of smoke and odor during the initial start-up. This is due to burning off of oil from metal parts, and will disappear in a short while.

#### STRANGE SOUNDS

Possible noises due to expansion and contraction of some metal parts during periods of heat-up and cool-down do not necessarily represent harmful or dangerous conditions.

Condensation causes sizzling and popping within the burner area during heating and cooling periods and should be considered normal. See “Condensation” in this manual.

#### CONDENSATION

Whenever the water heater is filled with cold water, some condensate will form while the burner is on. A water heater may appear to be leaking when in fact the water is condensation. This usually happens when:

- a. A new water heater is filled with cold water for the first time.
- b. Burning gas produces water vapor in water heaters, particularly high efficiency models where flue temperatures are lower.
- c. Large amounts of hot water are used in a short time and the refill water in the tank is very cold.

Moisture from the products of combustion condense on the cooler tank surfaces and form drops of water which may fall onto the burner or other hot surfaces to produce a “sizzling” or “frying” noise.

### OPERATIONAL CONDITIONS

#### SMELLY WATER

The water heater has at least one anode rod for corrosion protection of the tank. Certain water conditions will cause a reaction between this rod and the water. The most common complaint associated with the anode rod is one of a “rotten egg smell” in the hot water. The smell is a result of four factors which must all be present for the odor to develop:

- a. A concentration of sulfate in the supply water.
- b. Little or no dissolved oxygen in the water.
- c. A sulfate reducing bacteria which has accumulated within the water heater (this harmless bacteria is nontoxic to humans).
- d. An excess of active hydrogen in the tank. This is caused by the corrosion protective action of the anode.

Smelly water may be eliminated or reduced in some water heater models by replacing the anode(s) with one of less active material, and then chlorinating the water heater tank and all water lines.

Contact the local water heater supplier or service agency for

further information regarding anode replacement and this chlorination treatment.

If the smelly water persists after the anode replacement and chlorination treatment, we can only suggest that chlorination or aeration of the water supply be considered to eliminate the water problem.

Do not remove the anode leaving the tank unprotected. By doing so, all warranty on the water heater tank is voided.

#### **“AIR” IN HOT WATER FAUCETS**

**HYDROGEN GAS:** Hydrogen gas can be produced in a hot water system that has not been used for a long period of time (generally two weeks or more). Hydrogen gas is extremely flammable and explosive. To prevent the possibility of injury under these conditions, we recommend the hot water faucet, located farthest away, be opened for several minutes before any electrical appliances which are connected to the hot water

system are used (such as a dishwasher or washing machine). If hydrogen gas is present, there will probably be an unusual sound similar to air escaping through the pipe as the hot water faucet is opened. There must be no smoking or open flame near the faucet at the time it is open.

#### **HIGH WATER TEMPERATURE SHUT OFF SYSTEM**

This water heater is equipped with an automatic reset type high limit (Energy Cutoff) sensor. The high limit switch interrupts the main burner gas flow should the water temperature reach 203°F (95°C).

The high limit will automatically reset when the water temperature drops below 120°F (49°C). After cooling the tank temperature, turn off the water heater for at least 10 seconds by using the switch on front of the control box. Turn on the water heater. If this fails to correct the problem, contact your plumber or service representative.

## SEQUENCE OF OPERATION FLOW CHART

Description of this flow chart can be found in the "SEQUENCE OF OPERATION" section found on page 23.

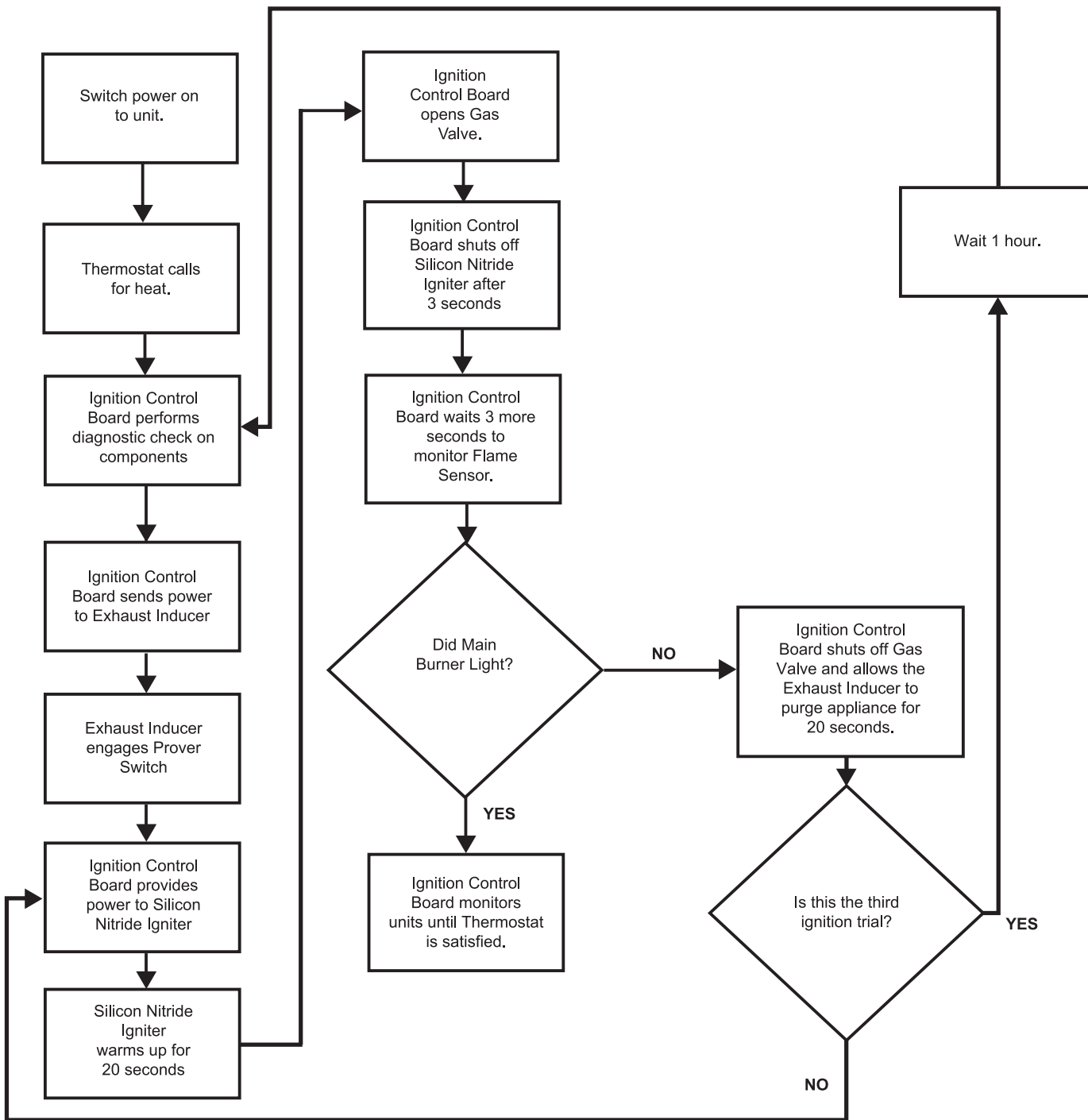

FIGURE 29











# OPERATIONAL CHECKLIST

COMPLAINT	CAUSE	REMEDY	
		USER	SERVICE AGENT
*Water not hot enough	Thermostat set too low.	Set thermostat dial to a higher temperature	
	Upper and/or lower temperature probe out of calibration.	Call service agent	Check continuity and resistance (Ohms) of upper and lower temperature probes. Replace probes if out of specification.
*Insufficient hot water *See WATER TEMPERATURE CONTROL WARNING (on page 12).	Thermostat set too low.	Set thermostat dial to a higher temperature	
	Upper and/or lower temperature probe out of calibration.	Call service agent	Check continuity and resistance (Ohms) of upper and lower temperature probes. Replace probes if out of specification.
	Main manual gas shutoff valve partially closed.	Open main manual gas shutoff valve to fullest extent.	
	Heater too small for demand.	Space usage to give heater time to restore water temperature.	
	Heater recovery is slower.	Call service agent	Check gas input. If incorrect, adjust gas pressure or replace burner orifices.
Water temperature too hot.	Thermostat set too high.	Set thermostat to a lower setting.	
Heater makes sounds: sizzling.	Condensation on outside of tank, normal.		
Rumbling.	Sediment accumulation on bottom of tank.	Drain a quantity of water through drain valve. If rumbling persists, call a service agent.	Delime heater.
Ticking or metallic sounds.	Expansion and contraction - normal.		
Pounding.	Air chambers in piping have become waterlogged.	Drain piping system and refill. Heater must be off while this is being done.	
Combustion noises.	Too much primary air.	Call service agent.	
	Overfired heater; Incorrect burners or orifice for type of gas used.	Call service agent.	Check and correct as necessary.
Water leaks.	Drain valve not closed tightly.	If drain valve cannot be closed tightly, replace.	
	Possible condensation if tank is undersized or stored water is below 110 degrees.	Increase tank temperature setting (have service agent add a mixing valve if setting will be above 120 degrees).	
	If leakage source cannot be corrected or identified, call service agent.	Shut off gas supply to heater and close cold water inlet valve to heater.	Repair or in case of suspected tank leakage, be certain to confirm before replacing heater.
Gas odors.	Heater is over fired	Shut off gas supply to heater and call a service agent.	Check for sooted flue passage.
			Check for obstructed vent line.
			Check backdraft or lack of draft
	Possible gas leaks.	Shut off gas supply to heater and call gas company at once	

# WATER PIPING DIAGRAMS

## LEGEND

	TEMPERATURE & PRESSURE RELIEF VALVE		FULL PORT BALL VALVE
	PRESSURE RELIEF VALVE		CHECK VALVE
	CIRCULATING PUMP		TEMPERATURE GAGE
	TANK TEMPERATURE CONTROL		WATER FLOW SWITCH
	DRAIN		

### MULTI FLUE - (1 UNIT) WITH VERTICAL STORAGE TANK



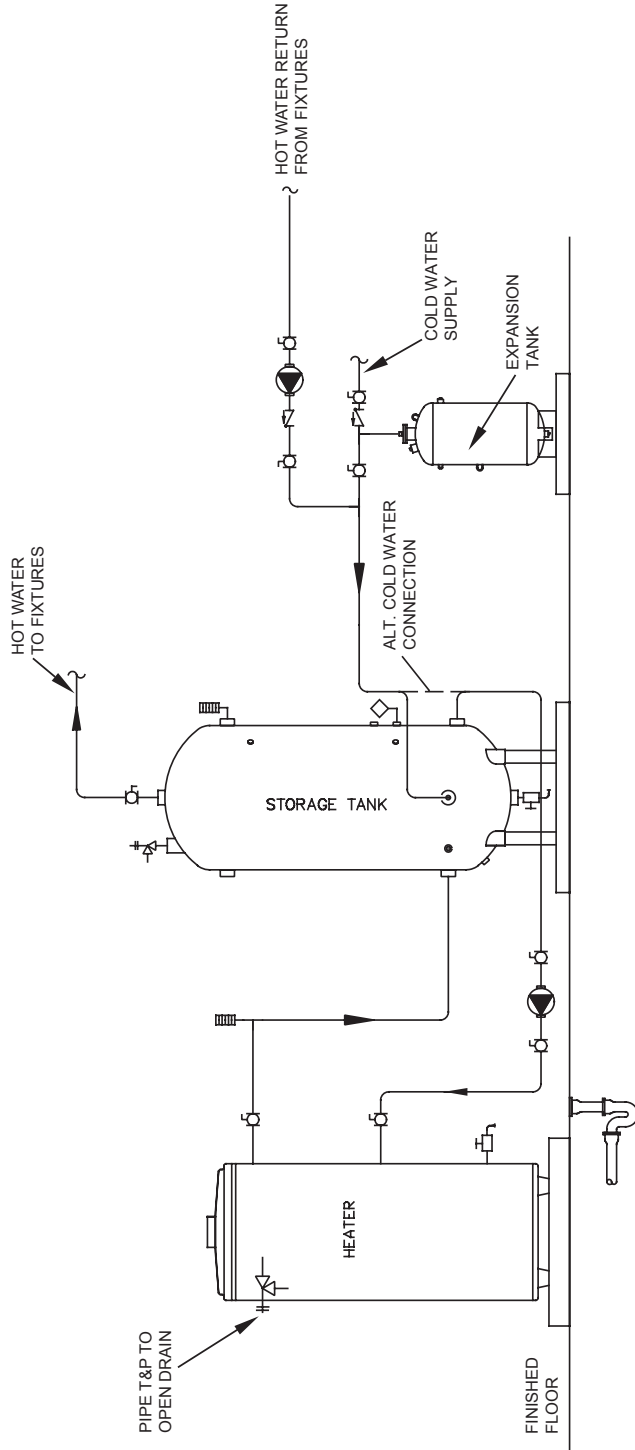





**WARNING: THIS DRAWING SHOWS SUGGESTED PIPING CONFIGURATION AND OTHER DEVICES; CHECK WITH LOCAL CODES AND ORDINANCES FOR ADDITIONAL REQUIREMENTS.**



#### NOTES:

1. Preferred piping diagram.
2. The temperature and pressure relief valve setting shall not exceed pressure rating of any component in the system.
3. Service valves are shown for servicing unit. However, local codes shall govern their usage.
4. The Tank Temperature Control should be wired to and control the pump between the water heater(s) and the storage tank(s).
5. The water heater's operating thermostat should be set 5 degrees F higher than the Tank Temperature Control.

# LEGEND

	TEMPERATURE & PRESSURE RELIEF VALVE		FULL PORT BALL VALVE
	PRESSURE RELIEF VALVE		CHECK VALVE
	CIRCULATING PUMP		TEMPERATURE GAGE
	TANK TEMPERATURE CONTROL		WATER FLOW SWITCH
	DRAIN		

## MULTI FLUE - (1 UNIT) WITH HORIZONTAL STORAGE TANK

**WARNING: THIS DRAWING SHOWS SUGGESTED PIPING CONFIGURATION AND OTHER DEVICES; CHECK WITH LOCAL CODES AND ORDINANCES FOR ADDITIONAL REQUIREMENTS.**

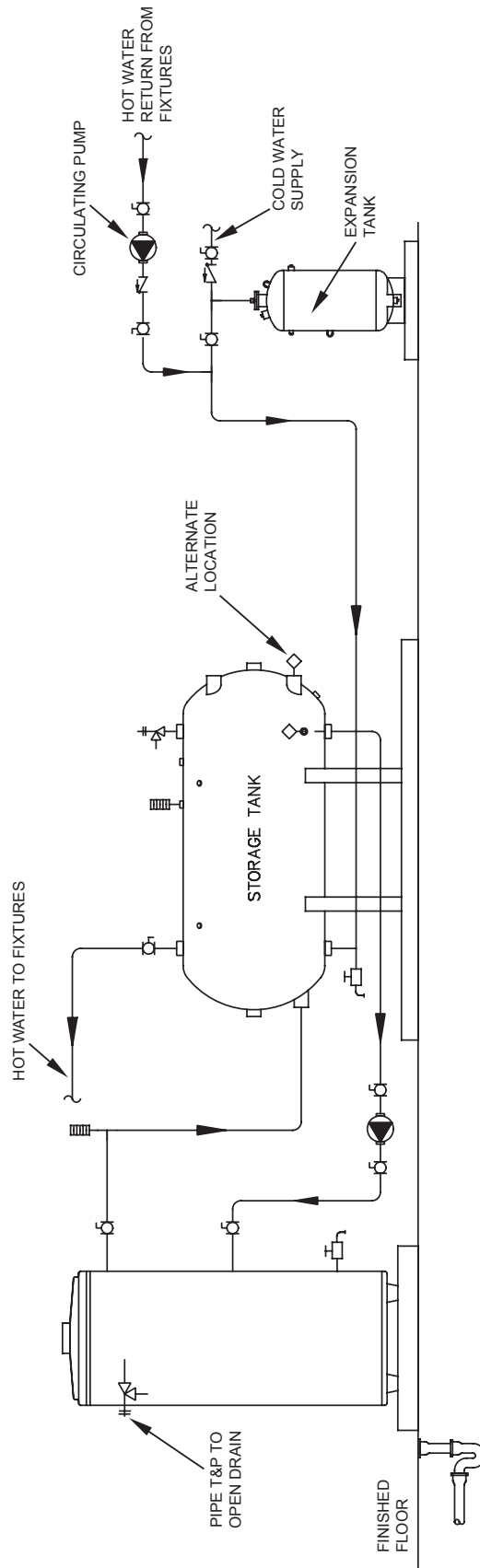









### NOTES:

1. Preferred piping diagram.
2. The temperature and pressure relief valve setting shall not exceed pressure rating of any component in the system.
3. Service valves are shown for servicing unit. However, local codes shall govern their usage.
4. The Tank Temperature Control should be wired to and control the pump between the water heater(s) and the storage tank(s).
5. The water heater's operating thermostat should be set 5 degrees F higher than the Tank Temperature Control.

**MULTI FLUE - (1 UNIT) WITH MIXING VALVE TWO TEMPERATURE**

**WARNING: THIS DRAWING SHOWS SUGGESTED PIPING CONFIGURATION AND OTHER DEVICES; CHECK WITH LOCAL CODES AND ORDINANCES FOR ADDITIONAL REQUIREMENTS.**

**LEGEND**

	TEMPERATURE & PRESSURE RELIEF VALVE		FULL PORT BALL VALVE
	PRESSURE RELIEF VALVE		CHECK VALVE
	CIRCULATING PUMP		TEMPERATURE GAGE
	TANK TEMPERATURE CONTROL		WATER FLOW SWITCH

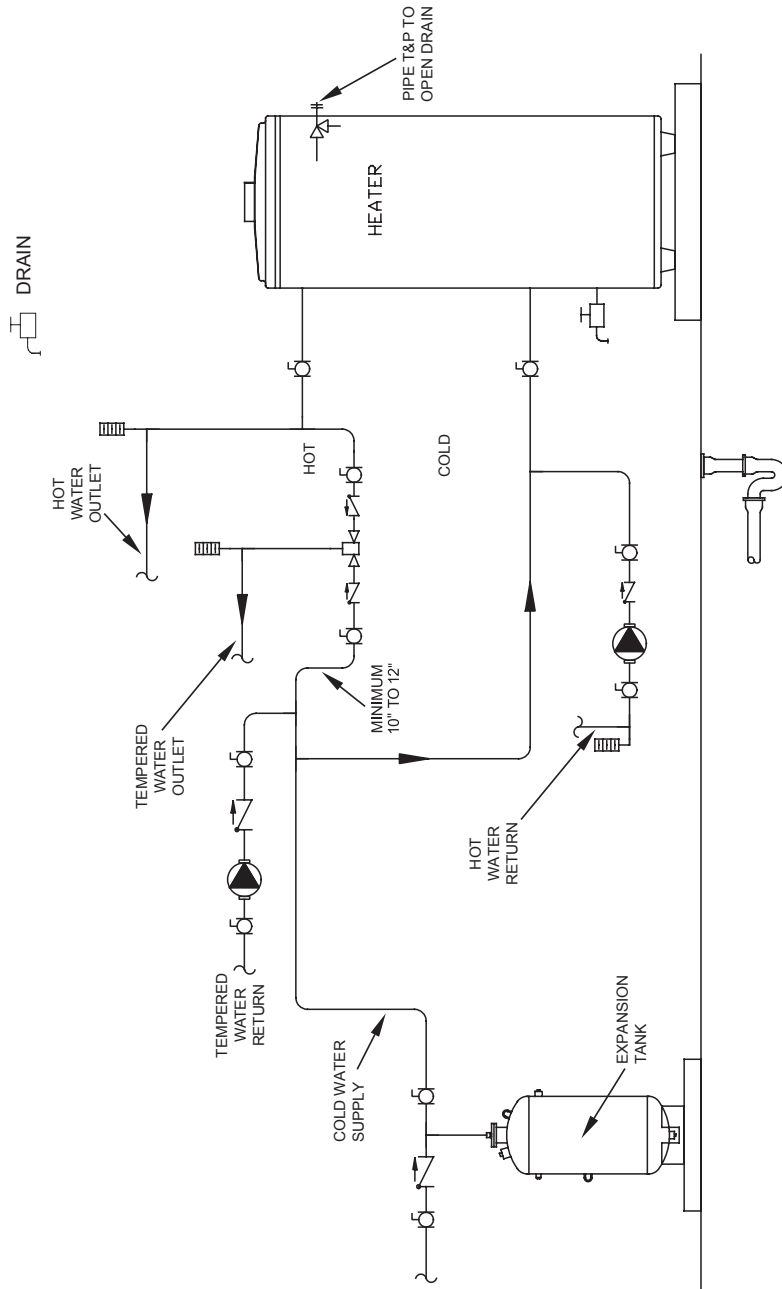









- NOTES:**
1. Preferred piping diagram.
  2. The temperature and pressure relief valve setting shall not exceed pressure rating of any component in the system.
  3. Service valves are shown for servicing unit. However, local codes shall govern their usage.

**MULTI FLUJE - (2 UNITS)**

**WARNING: THIS DRAWING SHOWS SUGGESTED PIPING CONFIGURATION AND OTHER DEVICES; CHECK WITH LOCAL CODES AND ORDINANCES FOR ADDITIONAL REQUIREMENTS.**

**LEGEND**

	TEMPERATURE & PRESSURE RELIEF VALVE		FULL PORT BALL VALVE
	PRESSURE RELIEF VALVE		CHECK VALVE
	CIRCULATING PUMP		TEMPERATURE GAGE
	TANK TEMPERATURE CONTROL		WATER FLOW SWITCH
	DRAIN		

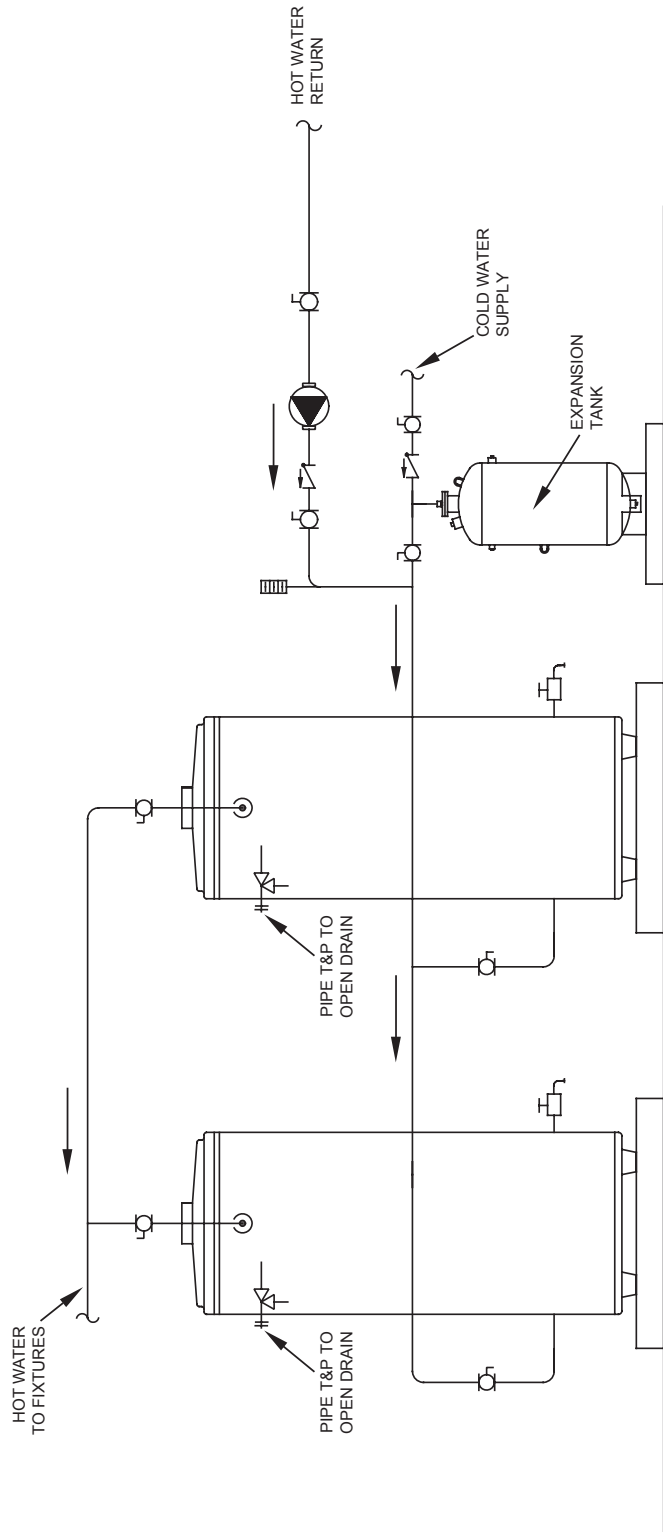









**NOTES:**

1. Preferred piping diagram.
2. The temperature and pressure relief valve setting shall not exceed pressure rating of any component in the system.
3. Service valves are shown for servicing unit. However, local codes shall govern their usage.

**MULTI FLUE - (2 UNITS) WITH VERTICAL STORAGE TANK**

**WARNING: THIS DRAWING SHOWS SUGGESTED PIPING CONFIGURATION AND OTHER DEVICES; CHECK WITH LOCAL CODES AND ORDINANCES FOR ADDITIONAL REQUIREMENTS.**

**LEGEND**

	TEMPERATURE & PRESSURE RELIEF VALVE		FULL PORT BALL VALVE
	PRESSURE RELIEF VALVE		CHECK VALVE
	CIRCULATING PUMP		TEMPERATURE GAGE
	TANK TEMPERATURE CONTROL		WATER FLOW SWITCH
	DRAIN		

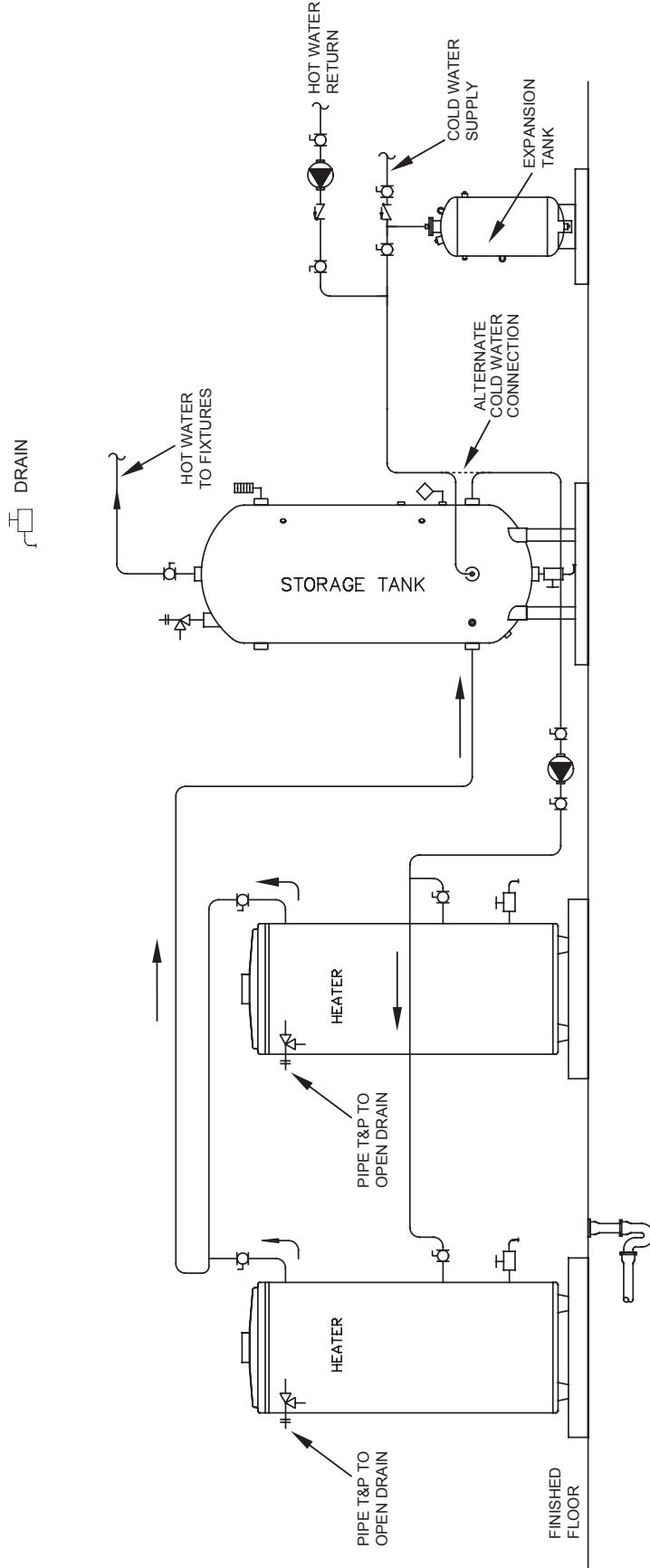









**NOTES:**

1. Preferred piping diagram.
2. The temperature and pressure relief valve setting shall not exceed pressure rating of any component in the system.
3. Service valves are shown for servicing unit. However, local codes shall govern their usage.
4. The Tank Temperature Control should be wired to and control the pump between the water heater(s) and the storage tank(s).
5. The water heater's operating thermostat should be set 5 degrees F higher than the Tank Temperature Control.

**MULTI FLUE - (2 UNITS) WITH VERTICAL STORAGE TANK**

**WARNING: THIS DRAWING SHOWS SUGGESTED PIPING CONFIGURATION AND OTHER DEVICES; CHECK WITH LOCAL CODES AND ORDINANCES FOR ADDITIONAL REQUIREMENTS.**

**LEGEND**

	TEMPERATURE & PRESSURE RELIEF VALVE		FULL PORT BALL VALVE
	PRESSURE RELIEF VALVE		CHECK VALVE
	CIRCULATING PUMP		TEMPERATURE GAGE
	TANK TEMPERATURE CONTROL		WATER FLOW SWITCH
	DRAIN		

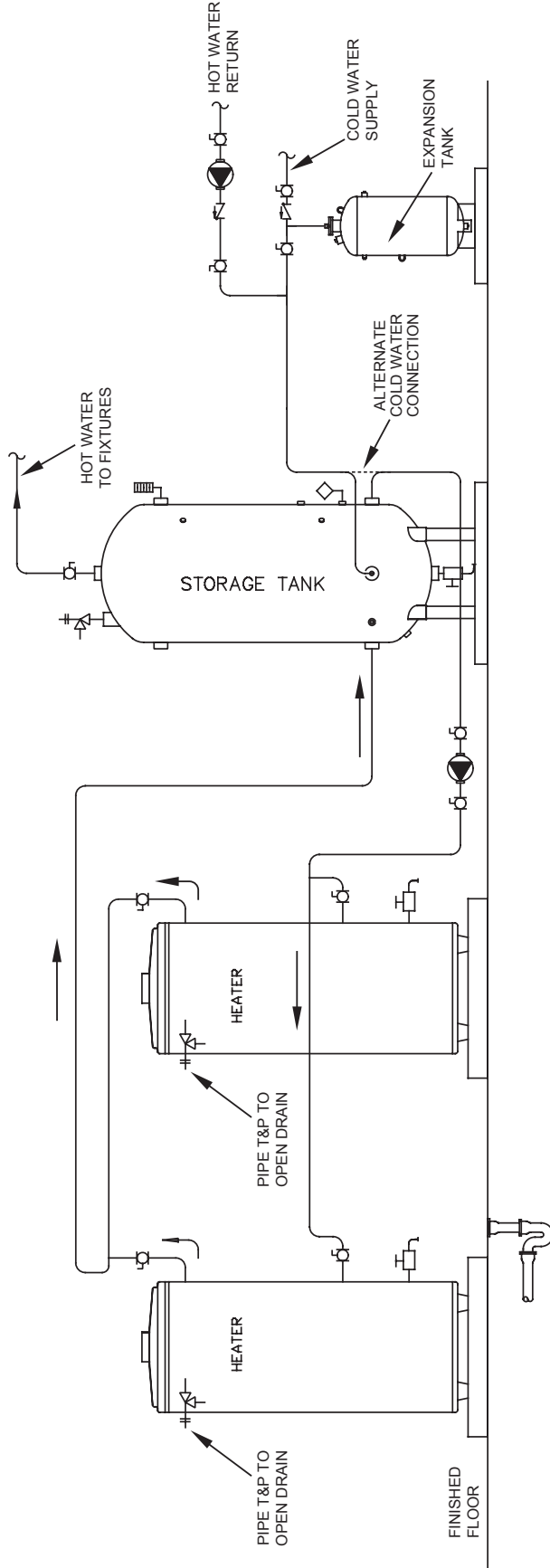









**NOTES:**

1. Preferred piping diagram.
2. The temperature and pressure relief valve setting shall not exceed pressure rating of any component in the system.
3. Service valves are shown for servicing unit. However, local codes shall govern their usage.
4. The Tank Temperature Control should be wired to and control the pump between the water heater(s) and the storage tank(s).
5. The water heater's operating thermostat should be set 5 degrees F higher than the Tank Temperature Control.

**MULTI FLUE - (2 UNITS) WITH HORIZONTAL STORAGE TANK**

**WARNING: THIS DRAWING SHOWS SUGGESTED PIPING CONFIGURATION AND OTHER DEVICES; CHECK WITH LOCAL CODES AND ORDINANCES FOR ADDITIONAL REQUIREMENTS.**

**LEGEND**

	TEMPERATURE & PRESSURE RELIEF VALVE		FULL PORT BALL VALVE
	PRESSURE RELIEF VALVE		CHECK VALVE
	CIRCULATING PUMP		TEMPERATURE GAGE
	TANK TEMPERATURE CONTROL		WATER FLOW SWITCH
	DRAIN		

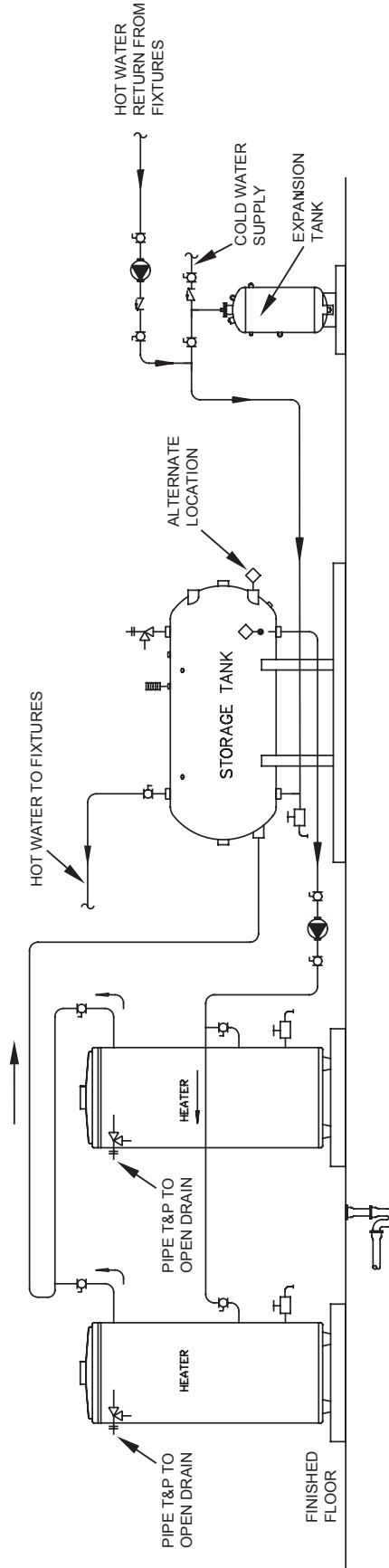

**NOTES:**









1. Preferred piping diagram.
2. The temperature and pressure relief valve setting shall not exceed pressure rating of any component in the system.
3. Service valves are shown for servicing unit. However, local codes shall govern their usage.
4. The Tank Temperature Control should be wired to and control the pump between the water heater(s) and the storage tank(s).
5. The water heater's operating thermostat should be set 5 degrees F higher than the Tank Temperature Control.



## MULTI FLUE (2 UNITS) TWO TEMPERATURE

**WARNING:** THIS DRAWING SHOWS SUGGESTED PIPING CONFIGURATION AND OTHER DEVICES; CHECK WITH LOCAL CODES AND ORDINANCES FOR ADDITIONAL REQUIREMENTS.

## LEGEND

	TEMPERATURE & PRESSURE RELIEF VALVE		FULL PORT BALL VALVE
	PRESSURE RELIEF VALVE		CHECK VALVE
	CIRCULATING PUMP		TEMPERATURE GAGE
	TANK TEMPERATURE CONTROL		WATER FLOW SWITCH
	DRAIN		

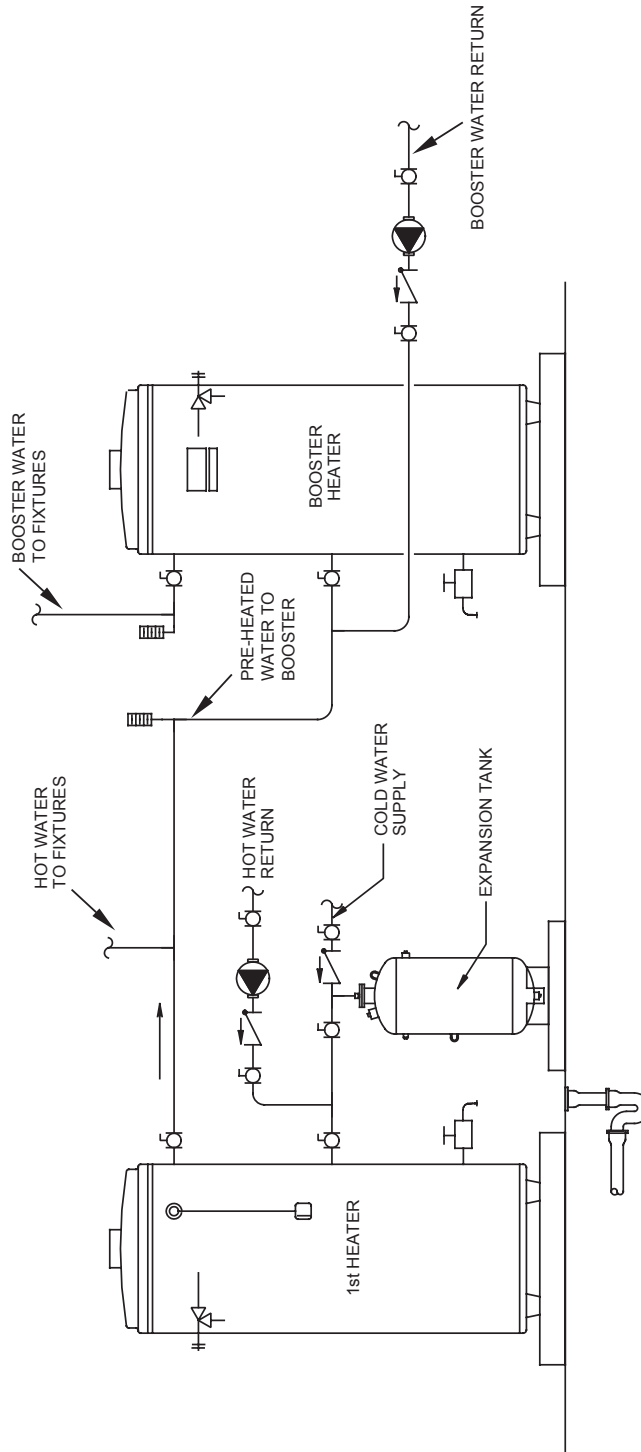

### NOTES:

1. Preferred piping diagram.
2. The temperature and pressure relief valve setting shall not exceed pressure rating of any component in the system.
3. Service valves are shown for servicing unit. However, local codes shall govern their usage.

## MULTI FLUE (2 UNITS) WITH BOOSTER TWO TEMPERATURE

**WARNING: THIS DRAWING SHOWS SUGGESTED PIPING CONFIGURATION AND OTHER DEVICES; CHECK WITH LOCAL CODES AND ORDINANCES FOR ADDITIONAL REQUIREMENTS.**

## LEGEND

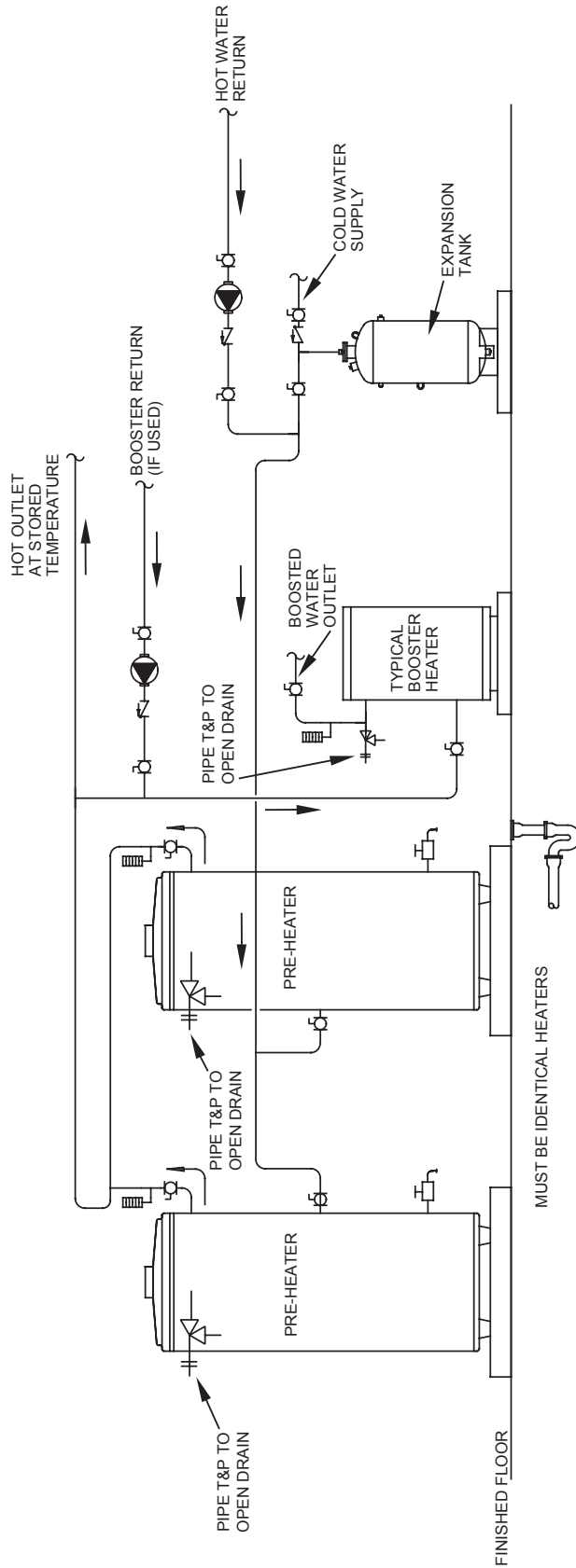
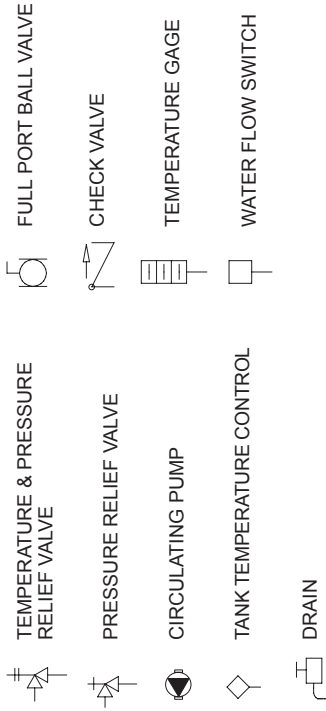









### NOTES:

1. Preferred piping diagram.
2. The temperature and pressure relief valve setting shall not exceed pressure rating of any component in the system.
3. Service valves are shown for servicing unit. However, local codes shall govern their usage.

**MULTI-FLUE (3 UNITS)**

**WARNING:** THIS DRAWING SHOWS SUGGESTED PIPING CONFIGURATION AND OTHER DEVICES; CHECK WITH LOCAL CODES AND ORDINANCES FOR ADDITIONAL REQUIREMENTS.

**LEGEND**

	TEMPERATURE & PRESSURE RELIEF VALVE		FULL PORT BALL VALVE
	PRESSURE RELIEF VALVE		CHECK VALVE
	CIRCULATING PUMP		TEMPERATURE GAGE
	TANK TEMPERATURE CONTROL		WATER FLOW SWITCH
	DRAIN		

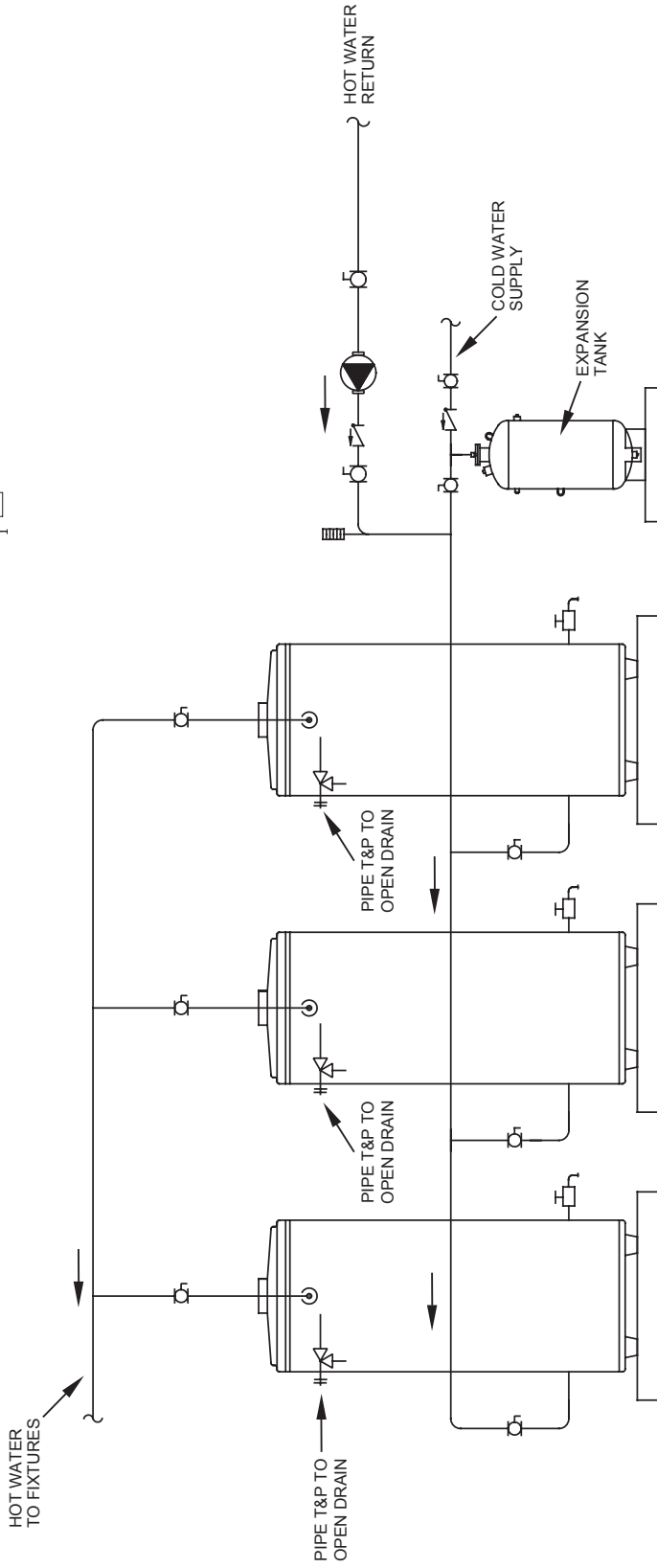

**NOTES:**

1. Preferred piping diagram.
2. The temperature and pressure relief valve setting shall not exceed pressure rating of any component in the system.
3. Service valves are shown for servicing unit. However, local codes shall govern their usage.

# LEGEND

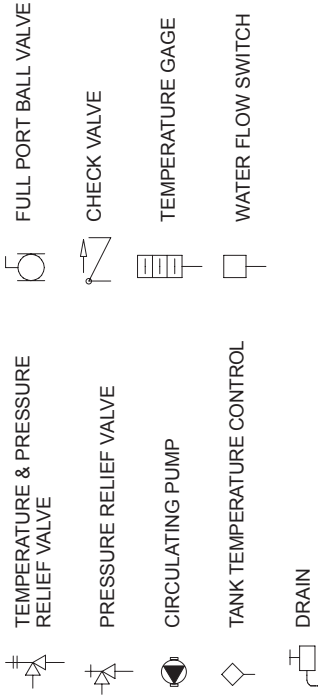

## MULTI-FLUE (3 UNITS) WITH VERTICAL STORAGE TANK

**WARNING: THIS DRAWING SHOWS SUGGESTED PIPING CONFIGURATION AND OTHER DEVICES; CHECK WITH LOCAL CODES AND ORDINANCES FOR ADDITIONAL REQUIREMENTS.**

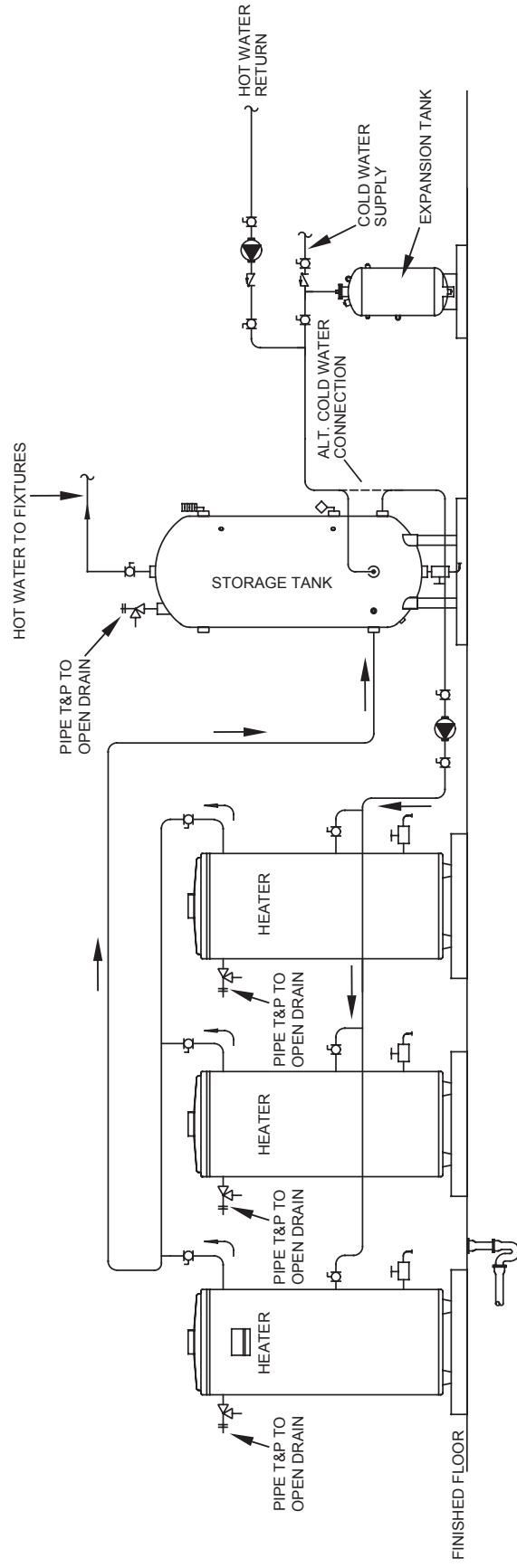

### NOTES:

1. Preferred piping diagram.
2. The temperature and pressure relief valve setting shall not exceed pressure rating of any component in the system.
3. Service valves are shown for servicing unit. However, local codes shall govern their usage.
4. The Tank Temperature Control should be wired to and control the pump between the water heater(s) and the storage tank(s).
5. The water heater's operating thermostat should be set 5 degrees F higher than the Tank Temperature Control.

**MULTI-FLUE (3 UNITS) WITH HORIZONTAL STORAGE TANK**

**WARNING:** THIS DRAWING SHOWS SUGGESTED PIPING CONFIGURATION AND OTHER DEVICES; CHECK WITH LOCAL CODES AND ORDINANCES FOR ADDITIONAL REQUIREMENTS.

**LEGEND**

- TEMPERATURE & PRESSURE RELIEF VALVE
- PRESSURE RELIEF VALVE
- CIRCULATING PUMP
- TANK TEMPERATURE CONTROL
- DRAIN
- FULL PORT BALL VALVE
- CHECK VALVE
- TEMPERATURE GAGE
- WATER FLOW SWITCH

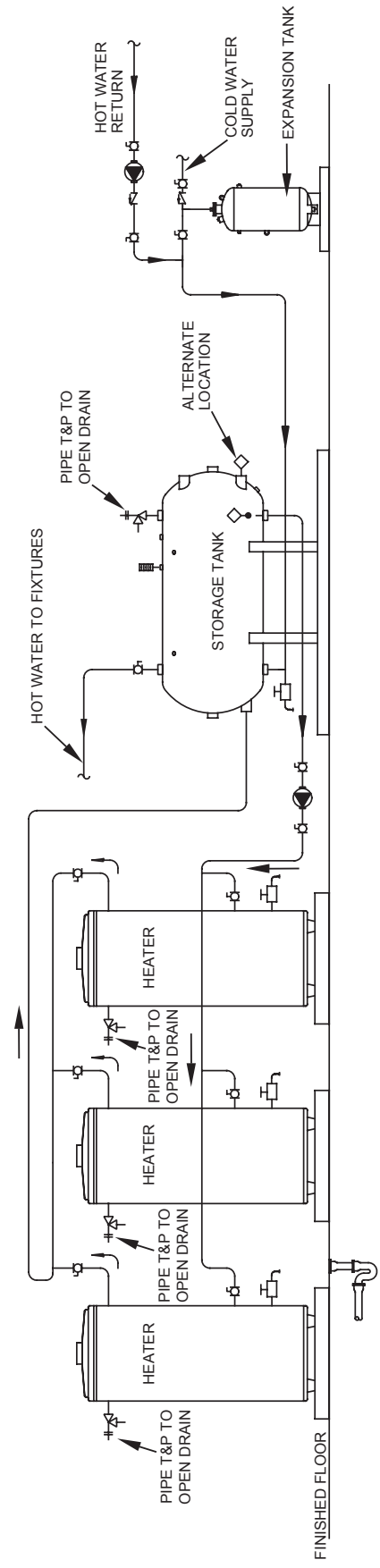









- NOTES:**
1. Preferred piping diagram.
  2. The temperature and pressure relief valve setting shall not exceed pressure rating of any component in the system.
  3. Service valves are shown for servicing unit. However, local codes shall govern their usage.
  4. The Tank Temperature Control should be wired to and control the pump between the water heater(s) and the storage tank(s).
  5. The water heater's operating thermostat should be set 5 degrees F higher than the Tank Temperature Control.

## MULTI FLUE FLUE (4 UNITS)

**WARNING: THIS DRAWING SHOWS SUGGESTED PIPING CONFIGURATION AND OTHER DEVICES; CHECK WITH LOCAL CODES AND ORDINANCES FOR ADDITIONAL REQUIREMENTS.**

## LEGEND

	TEMPERATURE & PRESSURE RELIEF VALVE		FULL PORT BALL VALVE
	PRESSURE RELIEF VALVE		CHECK VALVE
	CIRCULATING PUMP		TEMPERATURE GAGE
	TANK TEMPERATURE CONTROL		WATER FLOW SWITCH
	DRAIN		

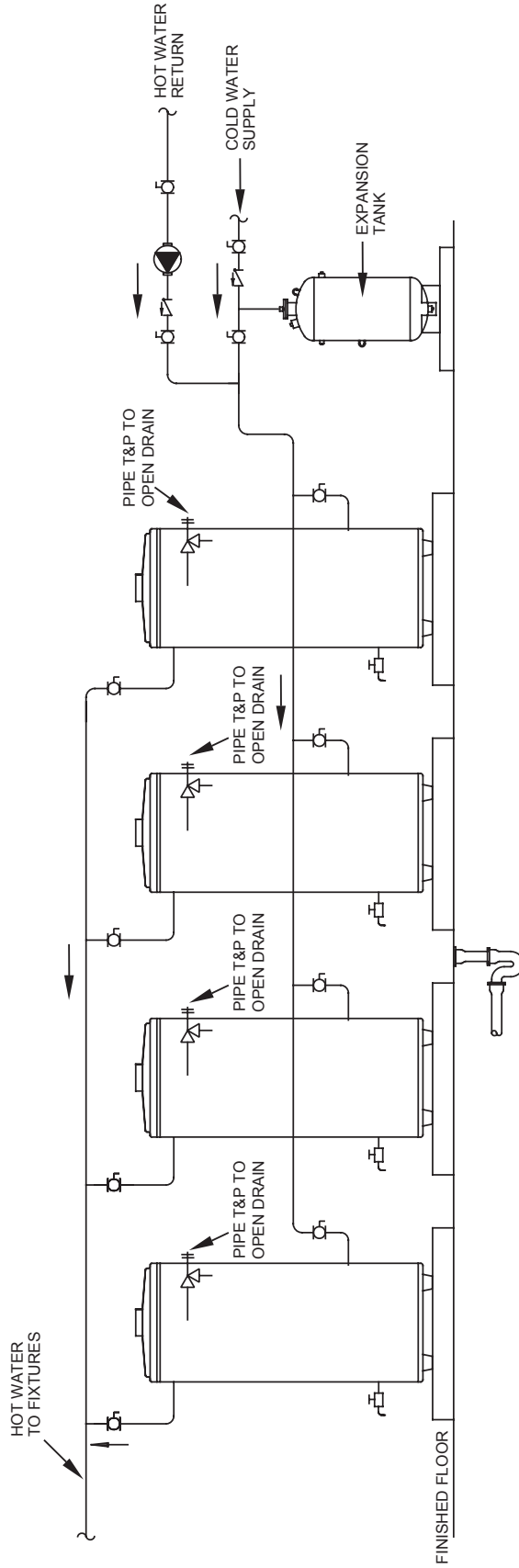









### NOTES:

1. Preferred piping diagram.
2. The temperature and pressure relief valve setting shall not exceed pressure rating of any component in the system.
3. Service valves are shown for servicing unit. However, local codes shall govern their usage.

## MULTI-FLUE (4 UNITS) WITH VERTICAL STORAGE TANK

**WARNING:** THIS DRAWING SHOWS SUGGESTED PIPING CONFIGURATION AND OTHER DEVICES; CHECK WITH LOCAL CODES AND ORDINANCES FOR ADDITIONAL REQUIREMENTS.

### LEGEND

	TEMPERATURE & PRESSURE RELIEF VALVE		FULL PORT BALL VALVE
	PRESSURE RELIEF VALVE		CHECK VALVE
	CIRCULATING PUMP		TEMPERATURE GAGE
	TANK TEMPERATURE CONTROL		WATER FLOW SWITCH
	DRAIN		

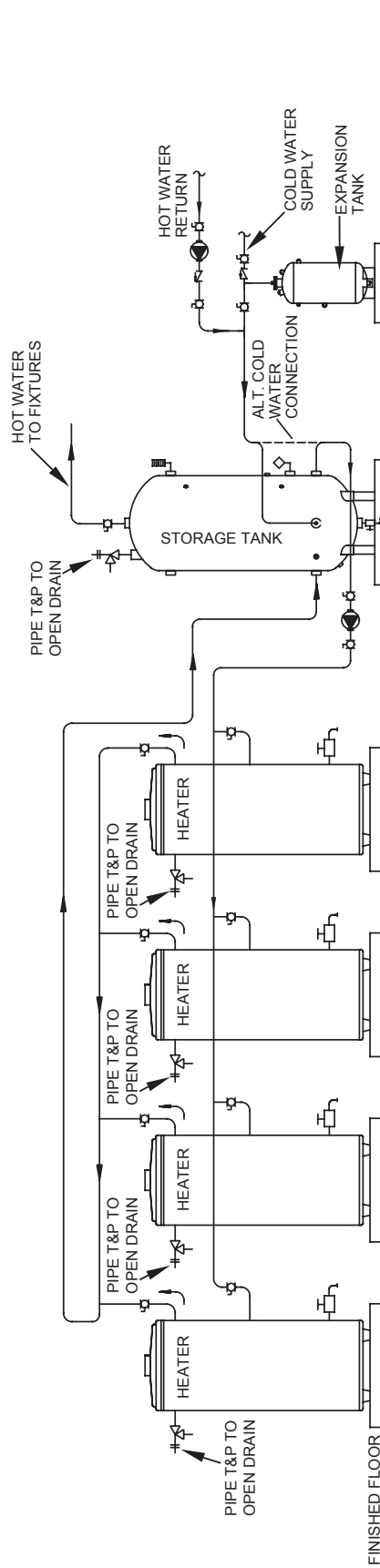

#### NOTES:

1. Preferred piping diagram.
2. The temperature and pressure relief valve setting shall not exceed pressure rating of any component in the system.
3. Service valves are shown for servicing unit. However, local codes shall govern their usage.
4. The Tank Temperature Control should be wired to and control the pump between the water heater(s) and the storage tank(s).
5. The water heater's operating thermostat should be set 5 degrees F higher than the Tank Temperature Control.

**MULTI-FLUE (4 UNITS) WITH HORIZONTAL STORAGE TANK**

**WARNING:** THIS DRAWING SHOWS SUGGESTED PIPING CONFIGURATION AND OTHER DEVICES; CHECK WITH LOCAL CODES AND ORDINANCES FOR ADDITIONAL REQUIREMENTS.

**LEGEND**

- TEMPERATURE & PRESSURE RELIEF VALVE
- PRESSURE RELIEF VALVE
- CIRCULATING PUMP
- TANK TEMPERATURE CONTROL
- DRAIN
- FULL PORT BALL VALVE
- CHECK VALVE
- TEMPERATURE GAGE
- WATER FLOW SWITCH

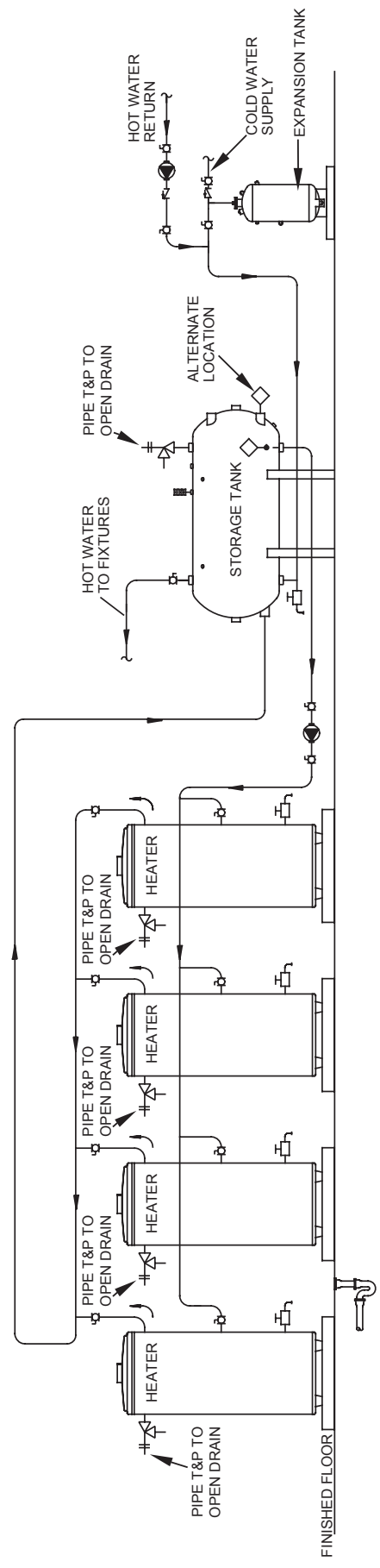

- NOTES:**
1. Preferred piping diagram.
  2. The temperature and pressure relief valve setting shall not exceed pressure rating of any component in the system.
  3. Service valves are shown for servicing unit. However, local codes shall govern their usage.
  4. The Tank Temperature Control should be wired to and control the pump between the water heater(s) and the storage tank(s).
  5. The water heater's operating thermostat should be set 5 degrees F higher than the Tank Temperature Control.



# MANIFOLD KITS

## TWO UNIT MANIFOLD KIT (PART NO. 9003426205)

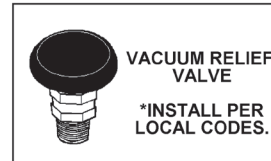
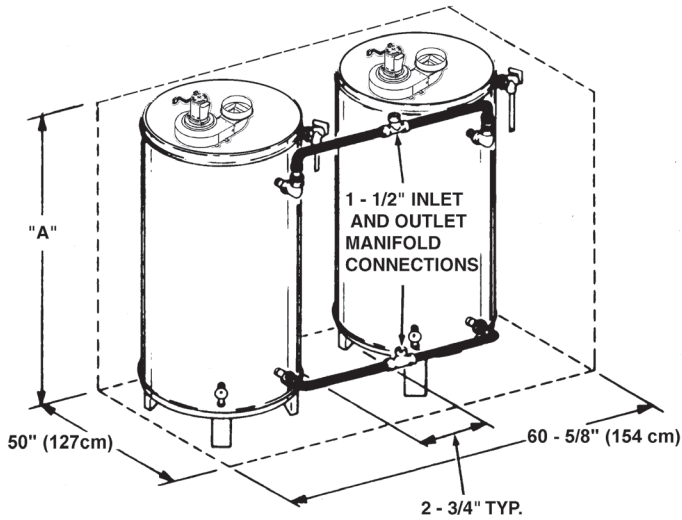

MODEL	DIMENSION "A"
(A)BCG385T500-8N/ (A)BCG385T500-8P	81.5"

## THREE UNIT MANIFOLD KIT (PART NO. 9003427205)

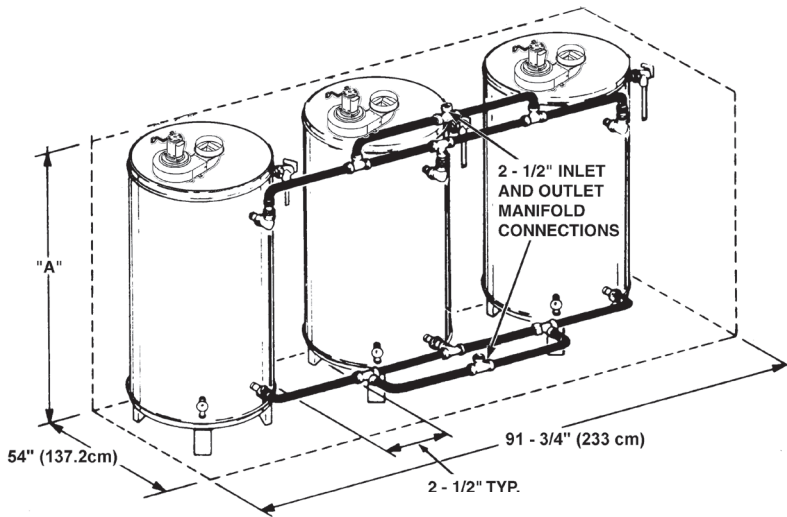

## FOUR UNIT MANIFOLD KIT (PART NO. 9003428205)

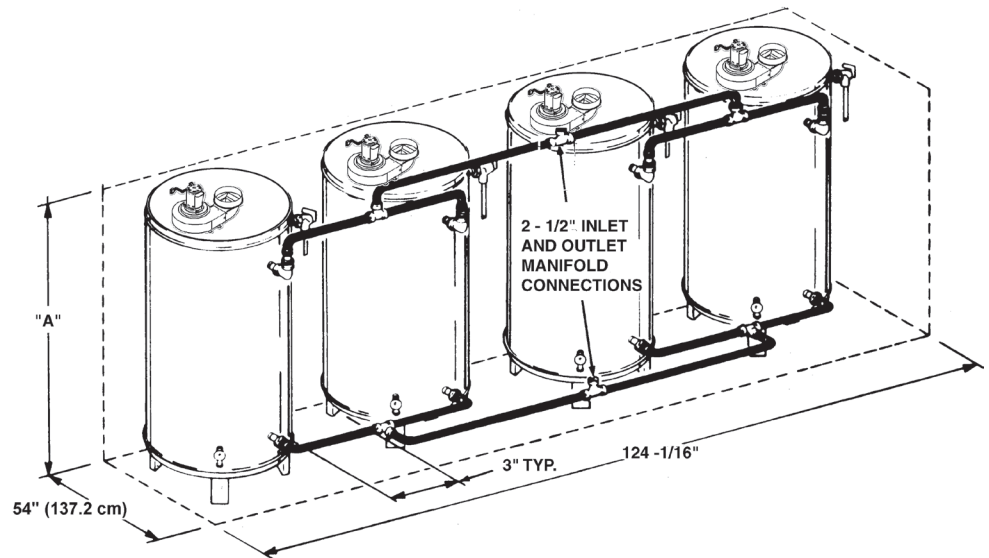

## COMMERCIAL STORAGE TANK WARRANTY

### A. WHO IS COVERED

AMERICAN WATER HEATER COMPANY, (herein collectively referred to as "Manufacturer") warrants only to the original purchaser (hereinafter "Owner") of the storage tank for the period specified below. This warranty is not transferable. The warranty is restricted to the storage tank used in a commercial application in the United States of America.

### B. WHEN IT IS COVERED

The storage tank is warranted only when it is installed, operated and maintained in accordance with the printed instructions accompanying the storage tank. A storage tank should be installed in such a manner that, if the tank or any connection thereto should leak, the resulting flow of water will not cause damage to the area in which it is installed. A systems temperature and pressure relief valve must be piped to the nearest drain to avoid damage in the event the valve is actuated. For detailed instructions read the manual accompanying the water heater and review drawings in the manual.

### C. WHAT THE MANUFACTURER WILL DO AND THE PERIOD OF COVERAGE

1. **The Inner Tank** - If the inner tank leaks within three years after the original installation, Manufacturer will furnish a new storage tank of Manufacturer's then prevailing comparable model. If industry standards, product improvements or product obsolescence prohibits Manufacturer from furnishing an identical model replacement water heater under this warranty, the Owner will be furnished with a new storage tank of comparable capacity; however, the Owner will be charged for the additional value of the item(s) which Manufacturer has incorporated in the replacement storage tank. A prior authorization number must be obtained from the Manufacturer before replacing the storage tank. This warranty is limited to one replacement storage tank at the original installation site.
2. **Component Part** - If any component part other than the inner tank proves to Manufacturer's satisfaction to be defective in material or workmanship within one year after original installation, the Manufacturer will furnish the Owner with a replacement for the defective part(s). This warranty is limited to one replacement component part for each original part.
3. **Return of Defective Storage Tank and Component Parts** - Manufacturer reserves the right to examine the alleged defect in the storage tank or component part(s), and it will be the Owner's obligation (see paragraph D.5) to return the storage tank and/or component part(s) to the Manufacturer.
  - a. When returning a storage tank it must include all component parts and the data plate label.
  - b. When returning component part(s), they must be individually tagged and identified with the storage tank's product number, model number, serial number, date of purchase and date of installation.

### D. WHAT THIS WARRANTY DOES NOT COVER

1. THE LIMITED WARRANTY STATED HEREIN IS IN LIEU OF ANY AND ALL WARRANTIES, EXPRESS OR IMPLIED (WHETHER WRITTEN OR ORAL), INCLUDING, BUT NOT LIMITED TO, THE IMPLIED WARRANTIES OF MERCHANTABILITY AND FITNESS FOR A PARTICULAR PURPOSE.
2. MANUFACTURER SHALL NOT BE LIABLE FOR ANY INCIDENTAL, CONSEQUENTIAL, SPECIAL OR CONTINGENT DAMAGES OR EXPENSES, ARISING, DIRECTLY OR INDIRECTLY, FROM ANY DEFECT IN THE STORAGE TANK OR THE USE OF THE STORAGE TANK.
3. Manufacturer shall not be liable for any water damage arising, directly or indirectly, from any defect in the storage tank or component part(s) or from its use.
4. Manufacturer shall not be liable under this warranty and this warranty shall be void and have no effect if the following events occur:
  - a. The storage tank or any of its component parts have been subject to misuse, alteration, neglect or accident; or
  - b. The storage tank has not been installed in accordance with the applicable local plumbing and/or building code(s) and/or regulations; or
  - c. The storage tank is not installed, operated and maintained in accordance with the printed Manufacturers instructions; or
  - d. The storage tank or any part has been under water; or
  - e. The storage tank is exposed to highly corrosive atmospheric conditions; or
  - f. The storage tank is not continuously supplied with potable water; or
  - g. The storage tank replacement is requested for reasons of noise, taste, odor, discoloration and/or rust; or
  - h. The storage tank is not operated within the factory calibrated temperature limits; or
  - i. The storage tank is supplied or operated with desalinated (deionized) water; or
  - j. The storage tank is removed from its original installation location; or
  - k. The storage tank is installed outdoors (this storage tank is intended only for indoor installation); or
  - l. The storage tank or any of its component parts fail due to lime and/or sediment build-up; or
  - m. The storage tank does not have installed a temperature and pressure relief valve, certified to ANSI Z21.22 and approved by the American Society of Mechanical Engineers; or
  - n. The storage tank or any of its component parts fail because of fire, floods, lightening, or any other act of God; or
  - o. The storage tank is installed in a closed system without adequate provision for thermal expansion.
5. Except when specifically prohibited by the applicable state law, the Owner, and not the Manufacturer, shall be liable for and shall pay for all charges for labor or other expenses incurred in the removal, repair or replacement of the water heater or any component part(s) claimed to be defective or any expense incurred to remedy any defect in the product. Such charges may include, but are not necessarily limited to:
  - a. All freight, shipping, handling and delivery costs of forwarding a storage tank or replacement part(s) to the owner.
  - b. All costs necessary or incidental in removing the defective storage tank or component part(s) and installing a new storage tank or component part(s).
  - c. Any material required to complete, and/or permits required for, installation of a new storage tank or replacement part(s), and
  - d. All costs necessary or incidental in returning the defective storage tank or component part(s) to a location designated by the manufacturer.
6. The terms of this Limited Warranty cannot be modified by any person, whether or not he/she claims to represent or act on behalf of the Manufacturer.

### E. HOW STATE LAW MAY RELATE TO THIS WARRANTY

Some States do not allow limitations on how long an implied warranty lasts so the above limitation may not apply to you. Similarly, some States do not allow the exclusion or limitation of incidental or consequential damages, so the above limitation or exclusion may not apply to you. Further, this warranty gives you specific legal rights and you may also have other rights, which may vary from State to State.

### F. HOW THE ORIGINAL OWNER CAN MAKE A WARRANTY CLAIM

1. The Owner should submit the warranty claim directly to Manufacturer's Service Department, at the address or phone number listed below, and Manufacturer will arrange for the handling of the claim and if valid, will give the Owner an authorization number which must appear on any document presented for warranty exchange.
2. Whenever any inquiry or request is made, be sure to include the storage tank's product number, model number, serial number, date of purchase, date of installation, maintenance records, and location of installation.

**FOR TECHNICAL ASSISTANCE, SERVICE OR WARRANTY INFORMATION**  
**PHONE TOLL FREE: 1-800-456-9805**  
**MONDAY THROUGH FRIDAY 8:00 AM to 8:00 PM EASTERN STANDARD TIME**  
**OR Write to:**  
**American Water Heater Company ATTN.: PRODUCT SERVICES COMMERCIAL DEPARTMENT**  
**P.O. BOX 1597 JOHNSON CITY, TN 37605-1597**

# NOTES



P.O. Box 1597, Johnson City, TN 37605  
Phone: 800-456-9805 • Fax: 800-999-5210  
[www.americanwaterheater.com](http://www.americanwaterheater.com)

Copyright © 2010 American Water Heater Company. All rights reserved.

Download from [Www.Somanuals.com](http://Www.Somanuals.com). All Manuals Search And Download.

## Free Manuals Download Website

<http://myh66.com>

<http://usermanuals.us>

<http://www.somanuals.com>

<http://www.4manuals.cc>

<http://www.manual-lib.com>

<http://www.404manual.com>

<http://www.luxmanual.com>

<http://aubethermostatmanual.com>

Golf course search by state

<http://golfingnear.com>

Email search by domain

<http://emailbydomain.com>

Auto manuals search

<http://auto.somanuals.com>

TV manuals search

<http://tv.somanuals.com>