



ne 4250

ne 8250

ne 4200.25

ne 8200.25

ne 4200.70

ne 8200.70

ne 4200.10

ne 8200.10

**Network Enabled
Multi Channel Power Amplifiers**

Operating Manual

ASHLY AUDIO INC.

847 Holt Road Webster, NY 14580-9103 Phone: (585) 872-0010

Toll-Free: (800) 828-6308 Fax: (585) 872-0739 www.ashly.com

Table Of Contents

1 INTRODUCTION	4
2 UNPACKING	4
3 THE NE MULTICHANNEL AMP SERIES	5
Overview	5
Protection	5
Physical Description	6
Front Panel Features	6
Rear Panel Features	7
Installation Requirements	7
Constant Voltage Models (25V, 70V, and 100V) and High Pass Filters	7
4 REMOTE CONTROL	8
On/Off Remote Standby	8
Preset Recall	8
Data Control (WR-5, RD-8C)	9
Remote Level Control (WR-1)	9
5 PROTEA^{ne} SOFTWARE	10
Overview	10
Amplifier Control Surface	11
The DSP Window	12
6 SPECIFICATIONS	14
7 WARRANTY INFORMATION	15



TO REDUCE THE RISK OF ELECTRIC SHOCK, DO NOT REMOVE COVER. NO USER SERVICEABLE PARTS INSIDE. REFER SERVICING TO QUALIFIED SERVICE PERSONNEL.

TO REDUCE THE RISK OF FIRE OR ELECTRICAL SHOCK, DO NOT EXPOSE THIS APPIANCE TO RAIN OR MOISTURE.

TO REDUCE THE RISK OF FIRE, REPLACE ONLY WITH SAME TYPE FUSE. REFER REPLACEMENT TO QUALIFIED SERVICE PERSONNEL.

**WARNING:
THIS APPARATUS MUST BE EARTHED**

1. INTRODUCTION

Thank you for your purchase of this **NE** (network enabled) multi channel power amplifier. The **NE** power amplifiers combine lightweight, state of the art, high efficiency switching technology with integrated Ethernet control, and use optional modular expansion cards to provide comprehensive internal DSP processing, AES/EBU input, and networked digital audio (Cobranet) input. Please read the entire manual to fully understand the features and capabilities of this product.

About Ashly

Ashly Audio was founded in 1974 by a group of recording engineers, concert sound professionals, and electronics designers. The first products were elaborate custom consoles for friends and associates, but business quickly spread to new clients and the business grew. The philosophy we established from the very beginning holds true today: to offer only the highest quality audio tools at an affordable cost to the professional user – ensuring reliability and long life. More than thirty years later, Ashly remains committed to these principles.

Ashly's exclusive Five Year, Worry- Free Warranty remains one of the most liberal policies available on any commercial- grade product. The warranty covers every product with the Ashly brand name, and is offered at no extra cost to you, our customer.

FCC Compliance

This device complies with part 15 of the FCC Rules. Operation is subject to the following two conditions:

1. This device may not cause harmful interference
2. This device must accept any interference received, including interference that may cause undesired operation.

2. UNPACKING

As a part of our system of quality control, every Ashly product is carefully inspected before leaving the factory to ensure flawless appearance. After unpacking, please inspect for any physical damage. Save the shipping carton and all packing materials , as they were carefully designed to reduce to minimum the possibility of transportation damage should the unit again require packing and shipping. In the event that damage has occurred, immediately notify your dealer so that a written claim to cover the damages can be initiated.

The right to any claim against a public carrier can be forfeited if the carrier is not notified promptly and if the shipping carton and packing materials are not available for inspection by the carrier. Save all packing materials until the claim has been settled.

3. THE NE MULTICHANNEL AMP SERIES

Model:

ne4250 - Four Channels, 250W per channel into 4 ohms

ne8250 - Eight Channels, 250W per channel into 4 ohms

ne4200.70 - Four Channels, 70 volt output, 200W per channel

ne8200.70 - Eight Channels, 70 volt output, 200W per channel

The basic NE multichannel amplifiers come in either four channel or eight channel configurations, with Euroblock input connectors standard or optional XLR connectors. Output connectors are Euroblock only. Standard features on all models include balanced analog inputs, bridge mono mode per channel pair, full ethernet control using **Protea^{ne}** software, remote standby for power up, contact closure preset recall, remote control through microprocessor based devices such as the Ashly WR-5, RD-8C, or other custom control, and DC remote level control using an Ashly WR-1.

Additional hardware options for the **NE** multichannel power amplifiers include the following:

1) Internal DSP Processing - With this factory installed option, and using **Protea^{ne}** (network enabled) software, each amplifier input channel can be configured with pluggable DSP blocks to have its own dynamics control, gain functions, graphic and/or parametric EQ, Hi-pass/Lo-pass filters, time delay, metering, and test signal generator. A mixer section with assignable routing allows any input to drive any or all amplifier outputs. Outputs have the same DSP functions as inputs, with the addition of a fast, automated crossover setup. Both inputs and outputs can copy/paste their settings to other channels, or can link with one or more other channels to track their settings.

Presets can be used to store and retrieve global parameters of an entire amplifier's control surface and DSP section from a file. In addition, Sub Presets allow for a collection of individual DSP function parameters within and across multiple channels of an amplifier to be stored and recalled as a set, affecting only those parameters and channels which have been tagged. Up to 35 presets/subpresets can be stored within the amplifier, and can be recalled in real time from a computer, WR-5 remote control, or contact closure switches (up to four).

2) AES/EBU Input - Using an optional four or eight channel input card, NE multichannel amplifiers can accept AES/EBU digital inputs. This protocol allows 2 channels of digital audio to be transmitted over a single cable, thus maintaining a completely digital signal path until just before the power amplification stage. 48kHz & 96kHz data rates are supported.

3) MIC Inputs - In conjunction with the factory installed DSP option, four analog MIC inputs can be installed (instead of AES/EBU) for full gain, mixing, and dsp processing capabilities using Proteane software.

4) Network Digital Audio (Cobranet) - This option allows the NE multichannel amplifier to be part of a networked audio distribution system. CobraNet is a technology developed and supported by Cirrus Logic (www.cirrus.com). It is a combination of software, hardware and network protocol which allows distribution of multiple channels of real-time, high quality digital audio over a standard Ethernet Network. For detailed information about CobraNet or its implementation or installation please visit www.cobranet.info.

Protection

Ashly **NE** multichannel amplifiers come standard with several protection circuits:

Over Current Protection - Is controlled in the output stage.

Thermal Protection - When the internal temperature is below 40°C the fan runs at its slowest speed. Above 40°C the speed is increased until it reaches its maximum value. If the temperature exceeds 100°C, the input on that channel is reduced. If the temperature exceeds 120°C, the power supply is switched off.

Mains Protections – protection within the power supply includes: Inrush Current Limitation during power up, Mains Over Voltage Detection, and internal Mains Fuse Protection. To protect the Mains fuse against AC overcurrent due to excessive audio output current, there is a protection scheme controlled in **Protea^{ne}** software and indicated on the amplifier front panel which reduces audio output level until the overcurrent condition is no longer present.

Physical Description

Each model in the NE Multichannel series is 2RU, and weighs 22 pounds (10kg) or less. The model number is indicated in the lower left corner of the front panel.

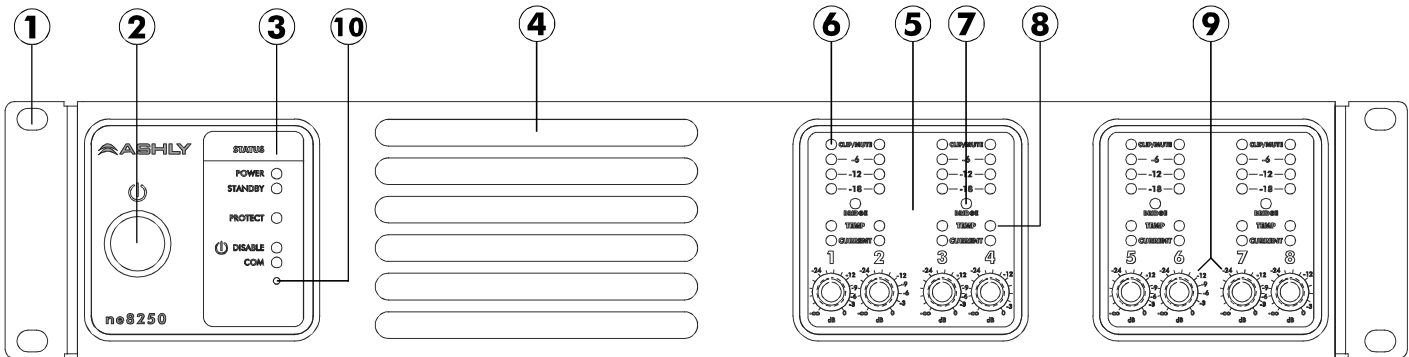

Amplifier Front Panel

1. **Mounting Holes** – For rack mounting.
2. **Power Switch** – Switches the unit on or off. *Note: The power switch can be disabled from Protea^{ne} Software*
3. **Status LEDs** – Indicate status of: Power, Standby, Protect, Power Switch Disable, and Comm activity
4. **Air Inflow Vents** – Cool air enters here
5. **Channel Controls** – Channel control area
6. **Signal LEDs** – The lowest LED will begin to light when the output voltage reaches -18dBu below rated output. The Clip LEDs will begin to flash when output voltage is 1/2 volt below the output power supply voltage.
7. **Bridge** – This LED indicates that the channel pair is selected to BRIDGE mode from the back panel switch, and that only the odd input channel level control is active
8. **Temp and Current LEDs** – The Temp LED indicates that the amplifier has reached an excessively high operating temperature. The Current LED confirms that the amplifier output is delivered to a speaker load.
9. **Channel Attenuators** – These control the input signal level to the amp, and can be disabled from software.
10. **Factory Reset** – To reset all internal configurations (including passwords) back to their original factory settings, press and hold this recessed front panel tact switch during power up until all channel LEDs are lit. Upon reset completion, the LEDs will turn off and the amp will be in normal operating mode.

Amplifier Rear Panel

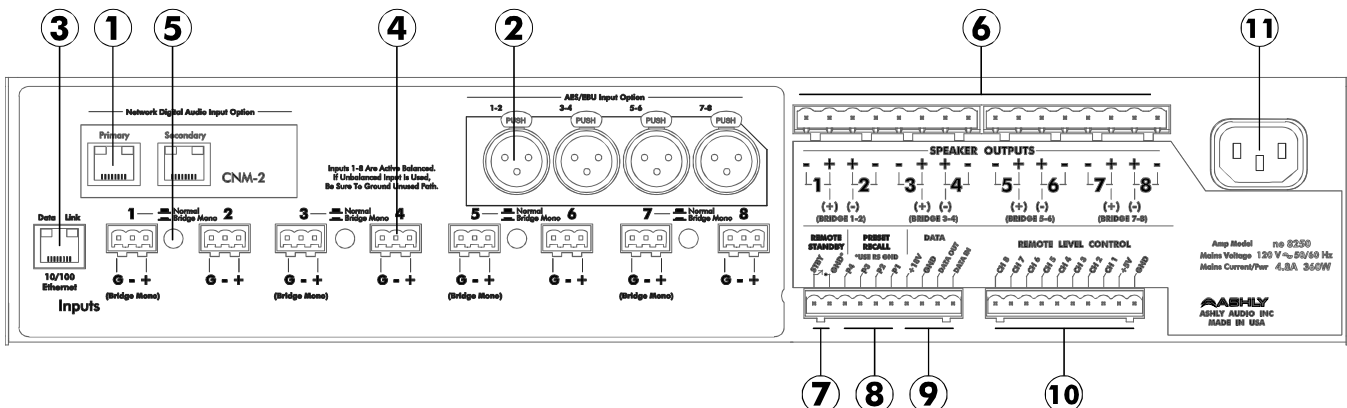

Amplifier Rear Panel

1. **Optional Cobranet Card CNM-2** – Installation of this option allows this amplifier to be part of a Cobranet audio network.
2. **Optional AES/EBU Input** - Installation of this option allows for AES/EBU digital input.
3. **Ethernet Port** - This jack offers ethernet control and monitoring of basic amplifier functions using **Protea^{ne}** software.
4. **Input Connector** - This is used for a three wire (G, +, -) balanced input. Standard connectors are two-piece euroblock, with XLR connectors optional equipment.
5. **Normal/Bridge Switch** - This switches the channel pair to Bridge Mode
6. **Euroblock Speaker Connectors** - Used to connect the speakers
7. **Remote Standby** - These two contact closure pins are wired to a switch to remotely place the amp in standby.
8. **Preset Recall** - These four pins (and GND) can be wired to remote contact closure switches to recall up to four amplifier presets.
9. **Data** - These four pins can be wired to remote microprocessor based controllers such as the WR-5 or RD-8C.
10. **Remote Level Control** - These pins can be wired to remote potentiometers such as the WR-1 for level control of individual channels
11. **AC Inlet** - Used for the detachable AC cord.

WARNING: Do not remove or lift the mains connector ground.

Installation

Before connecting to mains power, make sure that the switches and wiring are all set to the configuration needed for your particular application. Failure to do so could result in damage to the unit or other components in your system. **CAUTION:** When mounting or connecting the amplifier, always disconnect it from the mains. Use four screws and washers when mounting the amplifier to the front rack rails. Rear support is also recommended, especially for mobile or touring use. To reduce the risk of fire or electric shock, do not expose this apparatus to rain or moisture.

Requirements

NE-series multichannel amplifiers have specific physical, electrical and signal requirements for proper operation. These requirements will vary depending on your specific application, setup, and the settings on the amplifier. When setting up and testing your system, please take special care to double check all connections and settings. Please refer to the specifications section of this manual for specific input, output and other figures.

Constant Voltage Models (25V, 70V, and 100V) and High Pass Filters

The 25V, 70V, and 100V amplifiers include internal, factory installed High Pass Filter hardware. This allows for software selectable filters on each channel that prevent low frequency energy from saturating the core of low cost speaker tap transformers. Available settings are 80Hz (12dB/oct), 400Hz (6dB/oct), and OFF. The 400Hz setting is commonly used in paging systems with horn speakers. *Note that with the HPF hardware installed, that amplifier can not have any of the optional AES/EBU input, MIC input, or DSP hardware.*

The DSP option can be factory installed in lieu of the HPF hardware, with HPF frequencies set in software to any value from 20Hz to 20kHz with a slope of 12dB/oct to 48dB/oct and various response options. In order to have AES/EBU capability in a constant voltage amplifier, the DSP option must be installed.

4. REMOTE AMPLIFIER CONTROL

ON/OFF/Remote Standby

The NE multichannel amplifiers have three possible states, OFF, ON, and STANDBY, each with a status LED on the front panel. Control for these three states is managed by the following:

1) **Power Switch** - When the power switch is turned off the amplifier is completely off, UNLESS the power switch has been disabled from within **Protea^{ne}** software, in which case the power switch on the amplifier has no effect at all. If the power switch has been disabled from software, the front panel DISABLE LED will be lit. *Even if the AC power is removed, the amplifier's internal memory will maintain the <power switch disabled> status until changed again from **Protea^{ne}** software. Performing a factory reset will clear and restore all internal amplifier memory to factory settings.*

2) **Remote Standby Contact Closure** - When these two euroblock pins on the back of the amplifier are wired to a switch and *connected*, the amp will go into Standby mode, whereby the amp is active but not fully powered up. For Remote Standby to work, the power switch must be turned on OR be disabled through **Protea^{ne}** software.

3) **Protea^{ne} Software On/Standby** - On/Standby in the **Protea^{ne}** PE multichannel amp software functions the same as the hardware based Remote Standby Contact Closure on the back panel. Clicking on STANDBY places the amp in standby mode. The On/Standby in software does not override the hardware Remote Standby, they both remain active.

4) **Protea Software Power Switch Enable/Disable** - Use this software feature to disallow use of the front panel power switch. If the power switch has been disabled from software, the front panel DISABLE LED will light. The power switch will remain inactive until enabled again from software, even if the amp is removed from power.

Preset Recall

The four contact closure connections on the back panel euroblock allow for four different amplifier stored presets to be loaded at the instant a remote switch is closed. Presets are configured from **Protea^{ne}** software and can include gain settings, mute status, polarity, as well as the full set of DSP functions if the amp has the DSP option installed.

The NE amplifier will store up to 35 named internal presets, each preset storing control data for all channels and audio functions. While working in **Protea^{ne}** software, changes to an individual preset can be saved to the amplifier using <Preset Options/Save Preset To Protea>, or saved to the PC using <Preset Options/Save To Disk>. Sub Presets (collections of DSP parameters individually selected from software) are saved in a similar fashion. Individual preset files use the extension (*.pmc).

The only way to load presets to an amplifier is by using **Protea^{ne}** software to recall files saved on either the PC or the amplifier itself, through the use of contact closures, or with a WR-5 wall-mounted remote control. Contact closures can load presets 1-4 from the amplifier memory using switches wired to the rear panel contact closure euroblock connector.

Caution: A new preset may have dramatically different settings capable of damaging sound system components, so be careful not to recall the wrong preset while the system is on.

Data Control

The Data Control euroblock connector on the back of the amplifier is used for the Ashly WR-5 programmable zone controller and Ashly RD-8C remote level controller. The Data Control interface provides data and phantom power for these devices in remote installations, using four conductor wire.

The **WR-5** is a microprocessor based remote control unit which can be used with the NE multi-channel amplifiers. The WR-5 is designed to fit into a standard electrical wall box. Up to four WR-5 remotes can be phantom powered from one amplifier, and adding more remotes is possible using an external power supply. Each of six buttons on the WR-5 can be programmed to engage one of the following functions:

- 1) Preset recall
- 2) Preset scroll
- 3) Channel volume
- 4) Channel mute
- 5) Zone input source selection (requires DSP)

Programming of each button is done from Protea Software when the WR-5 is wired to its host NE amplifier, and the amplifier is connected to a PC via ethernet. Up to four WR-5 units can be daisy-chained from the same amplifier. See your Ashly dealer or visit the Ashly web site at www.ashly.com for more WR-5 details.

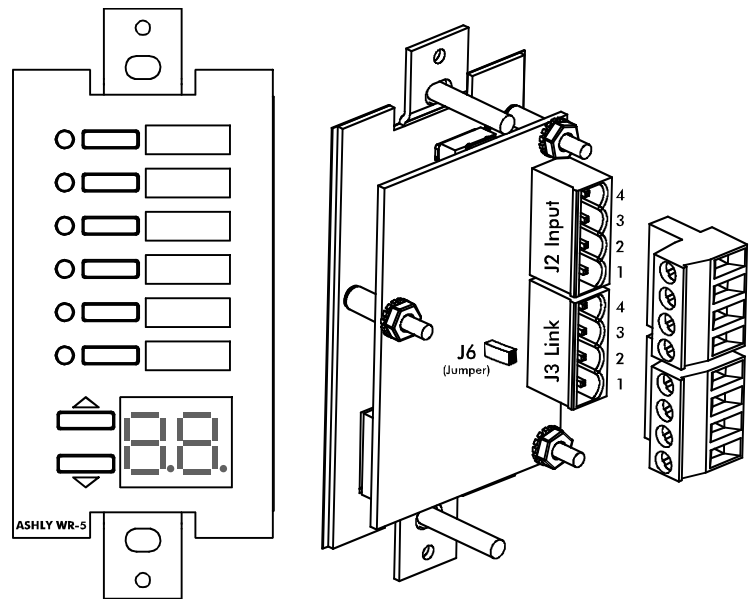

Ashly WR-5 Remote Control

RD-8C or RW-8C Remote Control

A second microprocessor based controller, the Ashly RD-8C, is an eight channel wall mount level controller that uses slide faders for individual channel and master level control and mute. **NOTE:** When an RD-8C is used, no other microprocessor based remotes can be used.

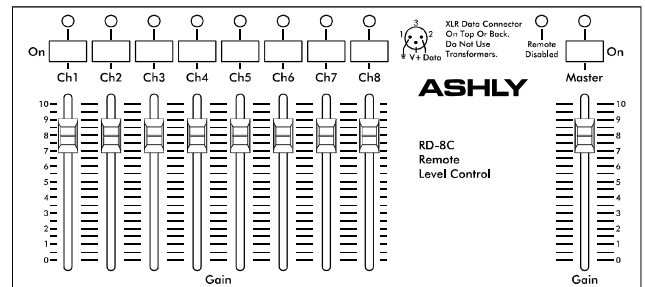

Ashly WR-1 Remote Attenuator

WR-1 Remote Level Control

Individual amplifier channels can have remote level control using a potentiometer assembly such as the Ashly WR-1 and four conductor wire. The WR-1 is a dual potentiometer remote volume control designed to fit in a standard wall electrical box. Each volume control is connected to a terminal block on the WR-1 circuit board, which in turn must be wired to the amplifier back panel euroblock connector labeled "Remote Level Control" as shown. *Do not connect the WR-1 remote level control ground to any other external grounds.*

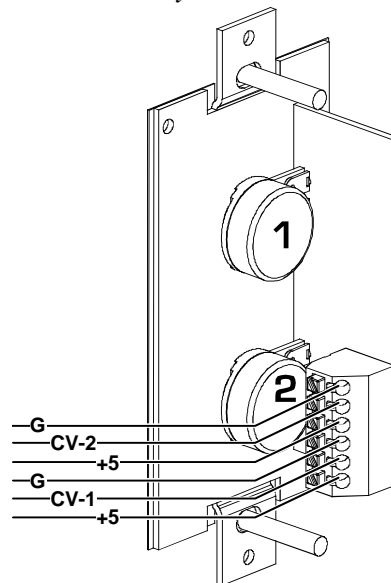

5. PROTEA^{ne} SOFTWARE

Protea^{ne} software offers a comprehensive suite of tools for controlling Ashly NE multichannel amplifiers as well as other Ashly products. The standard NE multichannel amplifiers allow for ethernet control and monitoring of power functions, level, mute, and polarity. With the DSP option installed, software control and monitoring of major audio functions can be custom configured on a per channel basis, as well as through linked channels. *More in depth discussion of software features can be found in the Protea^{ne} software online help.*

The base amplifier comes with software provisions for an audio control surface, password protected security functions, and network property management. Furthermore, Link Group Configuration and Power On Delay are set up under the Device Options menu tab. In addition, provisions for implementing DSP modes, AES/EBU Inputs, and Cobranet inputs are made available, presuming the necessary hardware has been installed in the amplifier. Protea^{ne} software will auto-detect the installed amplifier hardware options and display the resultant menu items as soon as it recognizes the amp on the network.

Link Group Configuration - Linking allows the controls for multiple signal processing function “blocks” to track each other. For example - if two graphic equalizers are “linked”, any change made to a control within either of the equalizers will result in an identical change to the other. Blocks may be linked within a Protea^{ne} device, or across multiple devices (assuming that devices are networked). Linking of multiple devices is managed through LINK GROUPS.

Each Protea^{ne} device will support up to eight Link Groups. DSP function “blocks” may be assigned to these groups through Protea^{ne} Software. Once assigned to a group all LIKE functions within the group will track parameter changes. However more than one function type may be assigned to a group. Each LINK GROUP may be assigned a name by the user, and also be assigned a color for easy identification. For further details about linking, see the online help in Protea^{ne} Software.

Preset Options - The Preset Options tab in the main amplifier window allows amplifier setups to be saved to and recalled from the amplifier as well as a computer. Presets are a snapshot of all current settings on a given amplifier.

Sub Presets - Sub Presets are user defined groups of DSP functions within one channel or across multiple channels. Sub Presets allow the end user to instantly recall a pre-determined set of DSP parameters to quickly address changing environmental conditions, without the risk of making undesirable or irrecoverable system changes.

The Amplifier Control Surface

This is the main user interface for the NE multichannel amplifier. Key features of this window include:

- 1) Channel/Offset Link Group Faders - The level control provides up to 40dB of analog input attenuation. More than 40dB of cumulative attenuation causes the channel to mute. If a channel has been assigned to an offset link group, a colored triangular marker appears on the left side of the fader graticule for secondary level control of all channels in that group. The main level control faders can not be linked to a group.
- 2) Mute button - This mutes the input channel
- 3) Polarity button - This inverts the phase of the input channel

The Amplifier Control Surface

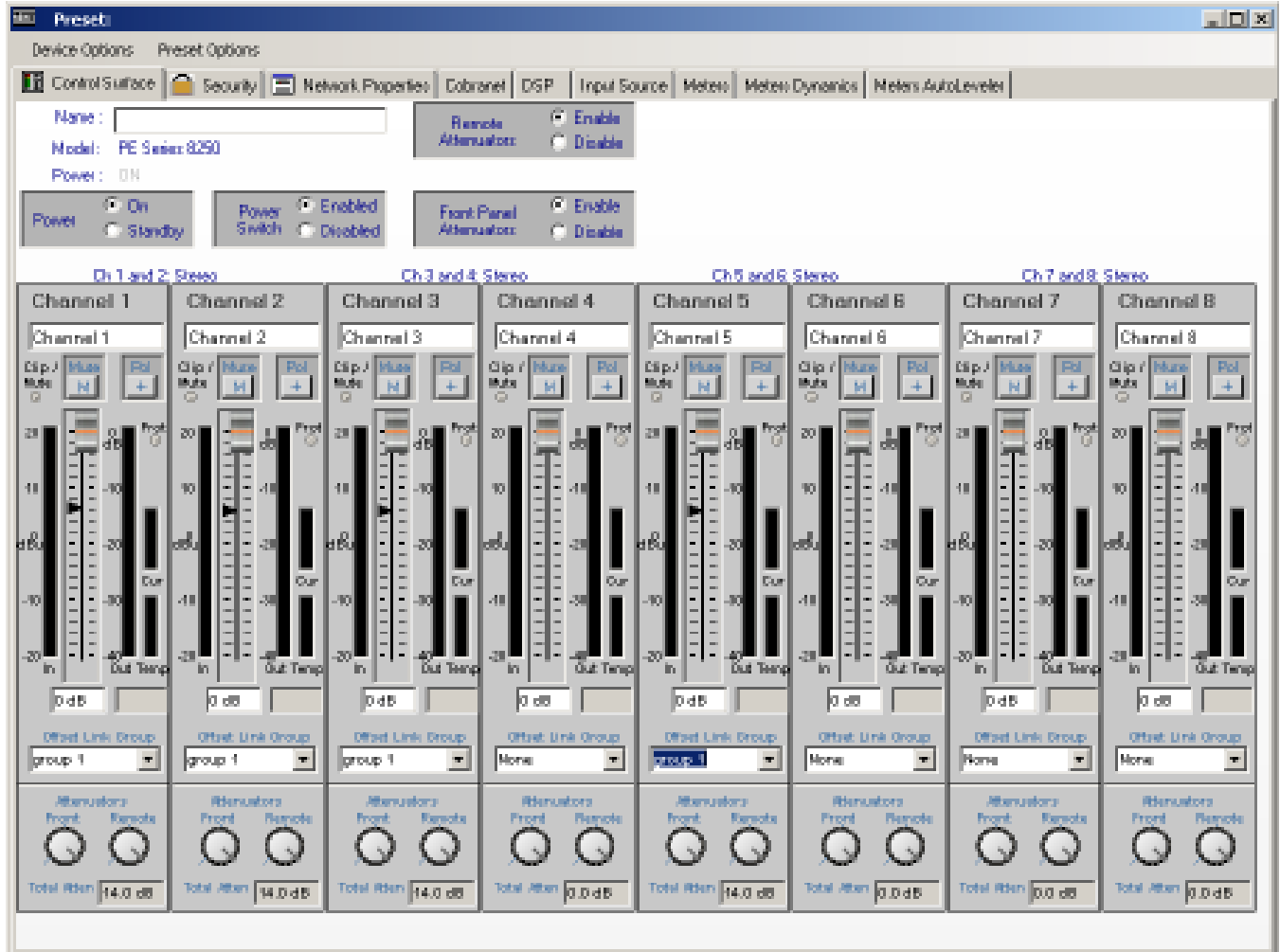

- 4) Offset link group - Up to eight groups are available for the purpose of linking similar function parameters across multiple channels. In addition to the control surface secondary level control (not the main fader), most DSP functions have a link group check box in their work window to assign a specific parameter to one of the eight link groups if desired. Link groups can be renamed by clicking on any group name and entering the new name then pressing <enter> on the keyboard.
- 5) Attenuators - These two dials indicate the physical position of hardware controls on either the amp front panel or the remote level control (if present). Note that these will display the position of attenuators even when DISABLED in software.
- 6) Total Attenuation - This indicates the total amount of attenuation being applied to the channel. This is the sum of the following attenuators: main fader, offset link group attenuation, front panel and remote attenuators (if enabled).
- 7) Meters - Input and Output meters display the real time activity per channel, in dB below rated output. Also, the amplifier's operating temperature and output current are shown. Output current shows that the amplifier channel is actually delivering output to a connected speaker load.

The DSP Window

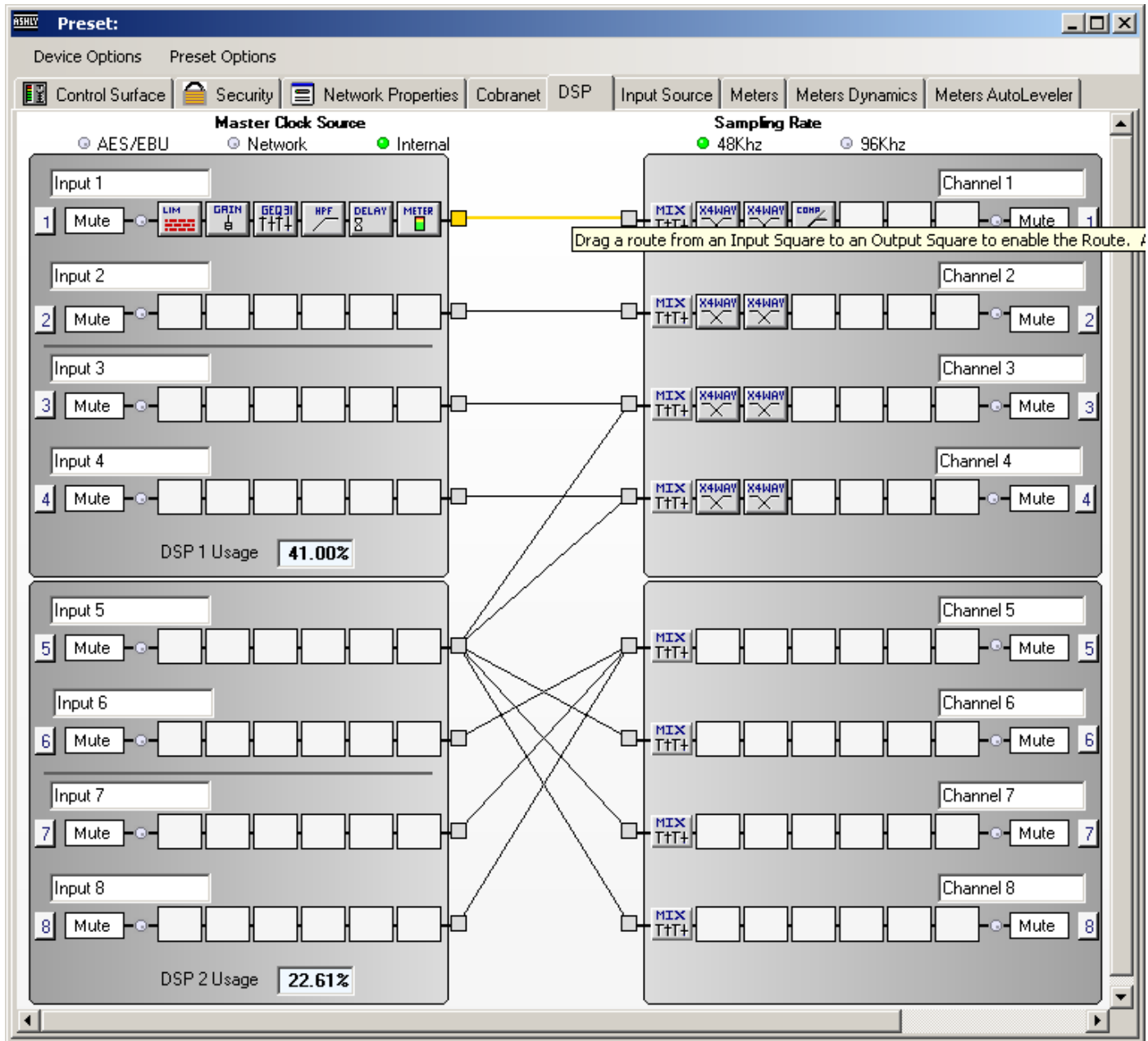

Extensive online help information is available for all DSP blocks. Look in the Protea^{ne} Software Help Menu/Contents and Index/Contents/Protea NE Products/PE Multichannel Amplifiers/DSP Control for details of all DSP functions. The key features include:

- 1) Input Channel Number - Right click on this to bring up Clear, Copy, Link, and Sub Preset functions for that input channel.
- 2) Input Channel Name - The user can name each input channel.
- 3) Input Mute Button - Mutes the input.

- 4) Pluggable Input DSP Tools - Six boxes are available for custom configuration of pluggable DSP processing blocks. Available DSP blocks include Dynamics controls, Gain functions, Graphic and Parametric EQ, Cross over functions, Delay, Metering, and a signal generator.
- 5) Input/Output Matrix Router - Any input can be routed to any or all outputs. Click and drag from the input to output to assign routing. To delete a route, right click on the routing line and delete.
- 6) Output Mixer - For a given amplifier output channel, all inputs that have been routed in the matrix router are mixed together here.
- 7) Pluggable Output DSP Tools - Output DSP tools are the same as those available to the inputs.
- 8) Output Mute Button - Mutes the output.
- 9) Output Channel Name - The user can name each output channel.
- 10) Output Channel Number - Right click on this to bring up Clear, Copy, Link, and Sub Preset functions for that output channel.

6. SPECIFICATIONS

General Power Amplifier Specifications *0dBu = 0.775V rms*

Base Model	4250		8250	
	120VAC	230VAC	120VAC	230VAC
<i>Continuous Average Power Output Per Channel</i>				
<i>Low Z models, Stereo Mode, all channels driven</i>				
<i>8Ω, 20Hz-20kHz 1%THD</i>	<i>150W</i>	<i>150W</i>	<i>150W</i>	<i>150W</i>
<i>4Ω, 20Hz-20kHz 1%THD</i>	<i>250W</i>	<i>250W</i>	<i>250W</i>	<i>250W</i>
<i>Low Z models, Bridge Mode, all channels driven</i>				
<i>8Ω, 20Hz-20kHz 1%THD</i>	<i>500W</i>	<i>500W</i>	<i>500W</i>	<i>500W</i>
<i>25V, 70V, 100V distributed output models,</i>				
<i>20Hz-20kHz 1%THD, per channel</i>	<i>250W</i>	<i>250W</i>	<i>250W</i>	<i>250W</i>
<i>Line Current Draw (all channels driven)</i>				
<i>Line Current, Standby mode</i>	<i>190mA</i>	<i>95mA</i>	<i>290mA</i>	<i>145mA</i>
<i>Line Current, Idle (no signal)</i>	<i>540mA</i>	<i>270mA</i>	<i>565mA</i>	<i>283mA</i>
<i>Line Current, Typical (1/8 power pink noise)</i>	<i>2.85A</i>	<i>1.43A</i>	<i>5.00A</i>	<i>2.50A</i>
<i>Line Current, Maximum (1/3 power sine wave)</i>	<i>6.00A</i>	<i>3.00A</i>	<i>11.0A</i>	<i>5.50A</i>
<i>Thermal Dissipation (all channels driven)</i>				
<i>BTU/hr, Standby mode,</i>	<i>46.7</i>	<i>46.7</i>	<i>63.8</i>	<i>63.8</i>
<i>BTU/hr, Idle (no signal)</i>	<i>123</i>	<i>123</i>	<i>187</i>	<i>187</i>
<i>BTU/hr, Typ (1/8 power pink noise)</i>	<i>341</i>	<i>341</i>	<i>700</i>	<i>700</i>
<i>BTU/hr, Max (1/3 power sine wave)</i>	<i>378</i>	<i>378</i>	<i>775</i>	<i>775</i>

Operating Manual - NE Multi Channel Power Amplifier

Signal to Noise (20Hz-20KHz, unweighted)	>105dB
Distortion (SMPTE, typical) - 8 ohm load, 10dB below rated power:	<0.5%
Distortion (THD-N, typical) - 8 ohm load, 10dB below rated power, 20Hz-20kHz:	<0.5%
Frequency Response	20Hz-20kHz, +/-1dB
Damping Factor (8 ohm load, <1kHz)	>250
Input Impedance	20K Ohm, balanced
Maximum Input Level	+21dB
Cooling	temperature dependent speed-controlled axial fan
Control Network	onboard, compatible with standard 100MB Ethernet hardware
Front Panel Indicators	per channel: Clip/Mute, -6dB, -12dB, -18dB, Temp, Current, Bridge (per pair) overall: Power, Standby, Protect, Power Switch Disable, Comm Control Surface and Amp LEDs: Level meters are dB below RATED output
Attenuators:	per channel: front panel, software, offset link group, and remote
Input Connections	Euroblock
Output Connections	Euroblock
Amplifier Protection	inrush current limitation, temperature monitoring, output over-current protection, mains fuses
Power Cable Connector	15A Edison
Dimensions	19"W x 3.5"H x 15.5"D (483 x 89 x 394mm)
Weight	21 lbs (9.53kg)
Environmental:	40-120 deg. F, (4-49 deg. C) noncondensing

DSP Specifications

Input: Active Balanced, 10 kohms
Max Input Level: +21 dBu

Dynamics

Brick Wall Limiter

Threshold: -20dBu to +20dBu
Ratio: infinite
Attack: 0.2ms/dB to 50 ms/dB
Release: 5ms/dB to 1000ms/dB

Compressor

Threshold: -20dBu to +20dBu
Ratio: 1.2:1 to infinite
Attack: 0.2 to 50ms
Release: 5ms/dB to 1000ms/dB
Detector: Peak/Average

Autoleveler

Target Level: -40dBu to +20dBu
Action: gentle, normal, aggressive, user defined
Maximum Gain: 0dB to +15dB
Ratio: 1.2:1 to 10:1
Threshold Below Target: -30dB to 0dB
Gain Increase Rate: 5ms/dB to 1000ms/dB
Hold Time: 0-6 sec

Ducker

Ducking Type: high/low priority, trigger, filibuster, ducked program
Trigger Threshold: -80dBu to +20 dBu
Ducking Release: 5ms/dB to 1000ms/dB
Ducking Depth: 0dB to -30dB

Gate

Threshold: -80dBu to +20dBu
Range: off, 100dB to 0dB
Attack: 0.2ms/dB to 50 ms/dB
Release: 5ms/dB to 1000ms/dB

Gain

Gain: off, -50dB to +12dB
Gain w/VCA: off, -50dB to +12dB
WR-5 Remote Gain: off, -50dB to +12dB

Equalization

31 Band Graphic

Filter Type: constant Q or proportional
Bandwidth: 0.499oct to 0.25oct

2, 4, 6, or 10 Band Parametric

Filter Types

Parametric:

Frequency: 20-20kHz
Level: -30dB to +15dB
Q Value: 0.016oct to 4oct

Hi/Low Shelf 6/12 dB

Frequency: 20Hz-20kHz
Level: -15dB to +15dB

All Pass

Frequency 20Hz-20kHz

Variable Q HP/LP

Frequency: 20Hz-20kHz
Q Value: 3.047 to 0.267

Notch/Bandpass

Frequency: 20Hz-20kHz
Q Value: 92.436 to 0.267

Crossover

2 Way, 3 Way, 4 Way Crossover

High Pass/Low Pass Filters

Filter Types:

Bessel: 12/18/24/48 dB/oct
Butterworth: 12/18/24/48 dB/oct
Linkwitz: 12/24/48 dB/oct
Frequency: off, 20Hz-20KHz

Delay

@ 48kHz Sampling Rate

Base Delay: 0-256ms
Extra Delay: 0-682 ms

@ 96kHz Sampling Rate

Base Delay: 0-128ms
Extra Delay: 0-341 ms

Tools

Audio Meter

Range: -60dBu to +20dBu
Increments: 1dB
Peak Hold Indicator: ... yes
Signal Generator: pink noise, white noise, sine wave
Sine Wave Frequency: .. 20Hz-12kHz
Signal Level: off, -50dBu to +20dBu

Cross Point Mixer

Gain: Off., -50 to +12dB, 0.5dB increments with Mute

Linking

All functions can be linked to 1 of 8 link groups

Processors

Input A/D: 24 bit (Burr Brown PCM4204)
Output D/A: 24 bit (Burr Brown PCM4104)
DSP Processors: 32-bit floating point (Sharc ADSP-21262)
Sample Rates: 48kHz, 96kHz
Propagation Delay @ 48kHz: ... 1.42 ms
Propagation Delay @ 96kHz: ... 0.71 ms

AES/EBU Digital Audio Input

Type: 110 ohm transformer balanced XLR
Sample Rates: 48kHz, 96kHz
Max Cable Length: 100 meters

7. WARRANTY INFORMATION

The unit you have just purchased is protected by a limited five-year warranty, which is transferrable and valid only in the United States. Fill out the information below for your records.

Serial Number _____

Dealer _____

Date of Purchase _____

Dealer's Address _____

Dealer's Phone _____



ASHLY AUDIO INC. 847 Holt Road Webster, NY 14580

Phone: (585) 872-0010 Fax: (585) 872-0739

Toll Free (800) 828-6308 www.ashly.com

Free Manuals Download Website

<http://myh66.com>

<http://usermanuals.us>

<http://www.somanuals.com>

<http://www.4manuals.cc>

<http://www.manual-lib.com>

<http://www.404manual.com>

<http://www.luxmanual.com>

<http://aubethermostatmanual.com>

Golf course search by state

<http://golfingnear.com>

Email search by domain

<http://emailbydomain.com>

Auto manuals search

<http://auto.somanuals.com>

TV manuals search

<http://tv.somanuals.com>