

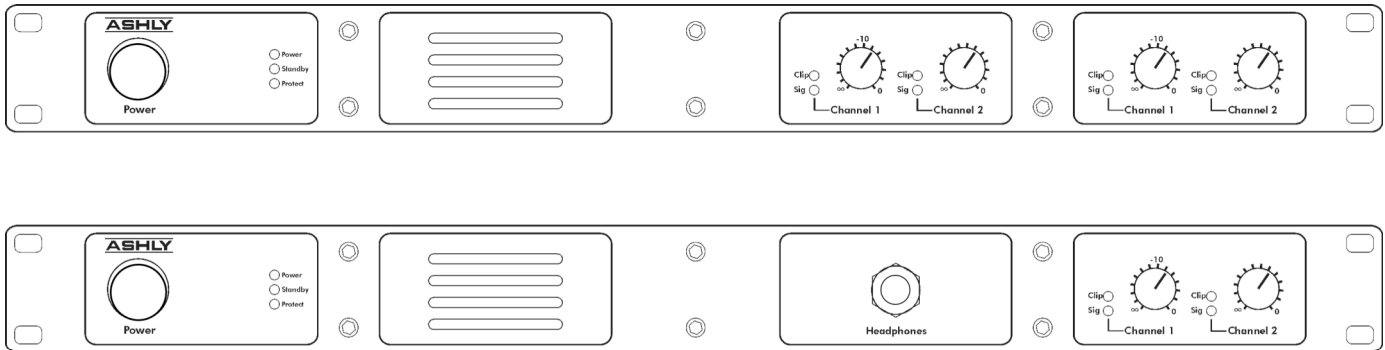

SRA-Series Amplifier

Operating Manual



Ashly Audio Inc.

847 Holt Road, Webster, NY 14580-9103
Toll Free (800) 828-6308, Telephone (585) 872-0010, FAX (585) 872-0739
www.ashly.com

All Trademarks referred to herein, are the property of their respective owners. R-042707

All Rights Reserved

Rev 1.4 0306

Important Safety
Instructions - 2

Introduction - 3

The SRA Series - 4

Physical Description - 5

Installation - 6

Operation - 8

Troubleshooting - 9

Spec Table - 10

Dimensions - 11

Warranty - 12

This manual uses a *Perpetual Table Of Contents*. Each page has a copy of the manual's contents in a gray box just like this one. The section you are in will always be bold with the other sections "grayed out." The feature allows you to jump directly to another section without having to return to a Table Of Contents page.

Important Safety Instructions Consignes de sécurité à lire attentivement

This power amplifier can produce dangerous output voltage, power and sound pressure levels. In order to minimize the risk of injury, damage, or hearing loss, please read the entire owner's manual.

Cet amplificateur de puissance peut produire un voltage et une pression acoustique qui pourrait être dangereuse ou pourrait même causer des problèmes ou perte d'acuité auditive. Consultez le manuel d'instruction et observez les consignes.



The lightning flash with arrowhead symbol, within an equilateral triangle, is intended to alert the user to the presence of uninsulated "dangerous voltage" within the product's enclosure that may be of sufficient magnitude to constitute a risk of electric shock to persons. The exclamation point within an equilateral triangle is intended to alert the user to the presence of important operating and maintenance instructions in the literature accompanying the device.

Le symbole de la foudre dans un triangle équilatéral symbolisant la foudre est prévu pour sensibiliser l'utilisateur à la présence de tension de voltage non isolée à l'intérieur de l'appareil. Elle pourrait constituer un danger de risque de décharge électrique pour les utilisateurs. Le point d'exclamation dans le triangle équilatéral alerte l'utilisateur de la présence de consignes qu'il doit d'abord consulter avant d'utiliser l'appareil.

- | | |
|---|--|
| <ol style="list-style-type: none"> 1. Read these instructions. 2. Keep these instructions. 3. Heed all warnings. 4. Follow all instructions. 5. To reduce the risk of fire or electric shock, do not expose this apparatus to rain or moisture. 6. Do not use this apparatus near water. 7. Clean only with dry cloth. 8. Do not block any ventilation openings. Install in accordance with the manufacturer's instructions. 9. Do not install near any heat sources such as radiators, heat registers, stoves, or other apparatus (including amplifiers) that produce heat. 10. Do not defeat the safety purpose of the polarized or grounding-type plug. A polarized plug has two blades with one wider than the other. A grounding type plug has two blades and a third grounding prong. The wide blade or the third prong are provided for your safety. If the provided plug does not fit into your outlet, consult an electrician for replacement of the obsolete outlet. 11. Protect the power cord from being walked on or pinched particularly at plugs, convenience receptacles, and the point where they exit from the apparatus. 12. Only use attachments/accessories specified by the manufacturer. 13. Use only with the cart, stand, tripod, bracket, or table specified by the manufacturer, or sold with the apparatus. When a cart is used, use caution when moving the cart/apparatus combination to avoid injury from tip-over. 14. Unplug this apparatus during lightning storms or when unused for long periods of time. 15. Refer all servicing to qualified service personnel. Servicing is required when the apparatus has been damaged in any way, such as power-supply cord or plug is damaged, liquid has been spilled or objects have fallen into the apparatus, the apparatus has been exposed to rain or moisture, does not operate normally, or has been dropped. | <ol style="list-style-type: none"> 1. Lisez ces instructions. 2. Conservez ces instructions. 3. Observez les avertissements. 4. Suivez ces instructions. 5. Pour réduire le risque de feu ou la décharge électrique, ne pas exposer cet appareil pour pleuvoir ou l'humidité. 6. Ne pas utiliser l'appareil près de l'eau. 7. Le nettoyer à l'aide d'un tissu sec. 8. Ne pas bloquer les ouvertures de ventilation, installer selon les consignes du fabricant. 9. Eloigner des sources de chaleur tel: radiateurs, fourneaux ou autres appareils qui produisent de la chaleur. 10. Ne pas modifier ou amputer le système de la mise à terre. Une prise avec mise à terre comprend deux lames dont une plus large ainsi qu'une mise à terre: ne pas la couper ou la modifier. Si la prise murale n'accepte pas la fiche, consulter un électricien pour qu'il remplace la prise désuète. 11. Protéger le cordon de secteur contre tous bris ou pincement qui pourraient l'endommager, soit à la fiche murale ou à l'appareil. 12. N'employer que les accessoires recommandés par le fabricant. 13. N'utiliser qu'avec les systèmes de fixation, chariots, trépied ou autres, approuvés par le fabricant ou vendus avec l'appareil. 14. Débrancher l'appareil lors des orages électriques ou si inutilisé pendant une longue période de temps. 15. Un entretien effectué par un centre de service accrédité est exigé si l'appareil a été endommagé de quelque façon: si il a été exposé à la pluie, l'humidité ou s'il ne fonctionne pas normalement ou qu'il a été échappé. |
|---|--|

Introduction

Congratulations on your purchase of an Ashly SRA-Series amplifier. The SRA-Series is made up of powerful, high-efficiency, lightweight amplifiers incorporating the latest technologies. We are confident that you will be pleased with the high performance, superb sound quality, reliability, and more.

About Ashly

Ashly Audio was founded in 1974 by a group of recording engineers, concert sound professionals, and electronics designers. The first products were elaborate custom consoles for friends and associates, but business quickly spread to new clients and the business grew. The philosophy we established from the very beginning holds true today: to offer only the highest quality audio tools at an affordable cost to the professional user – ensuring reliability and long life. More than thirty years later, Ashly remains committed to these principles.

Ashly's exclusive Five Year, Worry- Free Warranty remains one of the most liberal policies available on any commercial- grade product. The warranty covers every product with the Ashly brand name, and is offered at no extra cost to you, our customer.

FCC Compliance

This device complies with part 15 of the FCC Rules. Operation is subject to the following two conditions:

1. This device may not cause harmful interference
2. This device must accept any interference received, including interference that may cause undesired operation.

Important Safety
Instructions - 2

Introduction - 3
About Ashly
Safety
FCC Compliance

The SRA Series - 4

Physical Description - 5

Installation - 6

Operation - 8

Troubleshooting - 9

Spec Table - 10

Dimensions - 11

Warranty - 12

Important Safety
Instructions – 2

Introduction - 3

The SRA Series - 4
Protection

Physical Description - 5

Installation - 6

Operation - 8

Troubleshooting - 9

Spec Table - 10

Dimensions - 11

Warranty - 12

The SRA Series

SRA-Series amplifiers are high-efficiency, lightweight amplifiers incorporating the latest amplifier technologies.

The series provides a power range of 75 to 150 watts per channel at 4 ohms (20Hz-20kHz, 1% THD). The SRA series is available in 2 and 4 channel versions at two power points. All models will drive 4 or 8 ohm loads. All models are 1RU, with the two and four channel versions weighing 9 pounds and 10 pounds respectively. All SRA amplifiers utilize a state-of-the-art, efficient, high speed switched mode power supply and offer remote power on/off among the many standard features.

SRA-Series Power Ratings (per channel)			
	Stereo		Mono Bridged
Model	8Ω	4Ω	8Ω
SRA-2075	40 W	75 W	150 W
SRA-4075	40 W	75 W	150 W
SRA-2150	80 W	150 W	300 W
SRA-4150	80 W	150 W	300 W

- Input connections are via 3-pin Euroblock connectors.
- Output connectors are screw terminal strips.
- Rear panel switches include: selectable High Pass Filters, Gain and Operation Mode.

Protection

SRA-Series Amplifiers come standard with several protection circuits:

- ✦ **Output over-current protection** - The output current is limited to safe levels regardless of load.
- ✦ **DC output protection** - The amplifier is switched off if more than 2 volts of dc is present on the output. The amplifier will automatically restart after 5 seconds (if no fault remains). The protect LED is lit as well as the clip LED of the affected channel(s).
- ✦ **Main supply rail overvoltage protection** - The amplifier is switched off if the main supply rails have too high of a voltage. The amplifier will automatically restart after 5 seconds (if no fault remains). The protect LED is lit as well as the clip LED of the affected channel(s).
- ✦ **Chassis internal temperature monitoring** - The amplifier is switched off when the internal ambient temp reaches 70° C. The amplifier will again switch on when the internal ambient temp reaches 55° C. The protect LED is lit as well as the clip LED of ALL channels.
- ✦ **Inrush limiting** - The turn-on current is limited. This is active during initial startup as well as when exiting standby mode.
- ✦ **Mains fuse** - There is a 5 amp time delay fuse.

Physical Description

Each model in the SRA-Series is 1RU, and weighs 9 pounds (2 Ch) or 10 pounds (4 Ch). They have the same physical design, though there are obvious differences between two and four channel versions. The model number is indicated on the left side of the front panel

Amplifier Front Panel

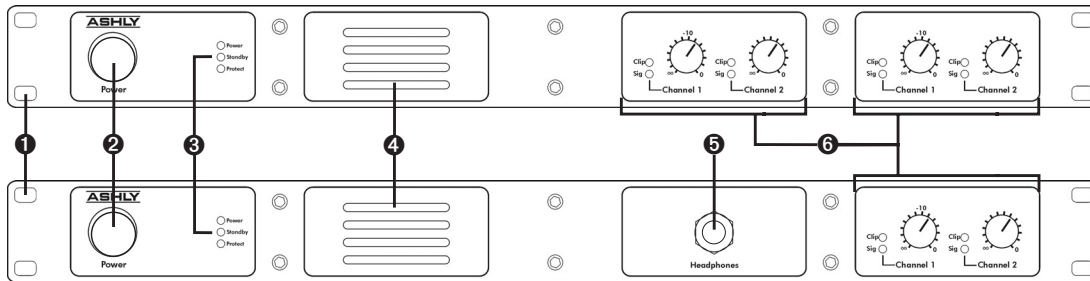

1. **Mounting Holes** – For rack mounting.
2. **Power Switch** – Switches the unit on or off
3. **Status LEDs** – Indicate status of: Power, Standby, and Protect
4. **Air Inflow Vents** – Cool air enters here
5. **Headphone Jack** – 2075 & 2150 only
6. **Channel Attenuators & LEDs** – These knobs adjust the attenuation of the input signal of each channel from ∞ to 0. The Sig LED will begin to light when the output voltage reaches approximately 0.3 volts. When clipping occurs the Clip LED will light.

Amplifier Rear Panel

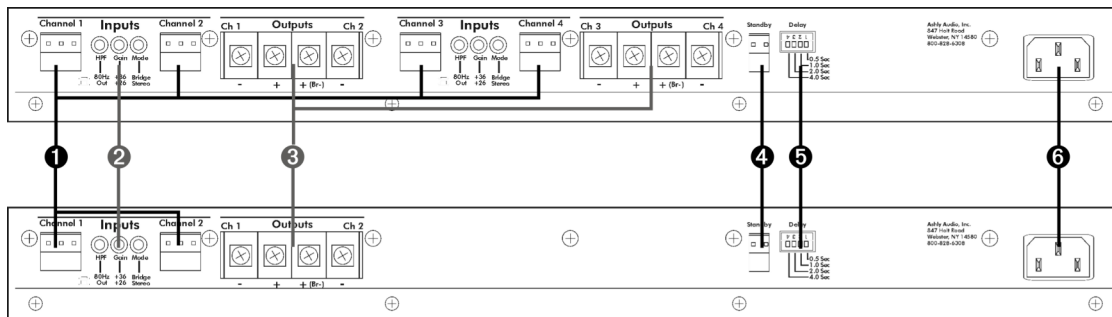

1. **3-Pin Euroblock Input Connectors** – These connectors are used for all input signals.
2. **Input Switches** – The HPF switch sets the High Pass Filter for each pair of channels channel to 80Hz or Off. The Gain switch sets the amplifier gain to +36dB or +26dB sensitivity. The Mode switch selects the amplifier's operating mode (Bridge or Stereo).
3. **Screw Terminal Output Connectors** – These connectors provide the amplifiers output signal. In Bridge Mode, the even channel (+) connector becomes the Bridged Channel (-).
4. **Standby Connector** – This 2-Pin Euroblock connector provides for remote standby switching. The Power switch must be in the On position for the Standby connector to be active. This feature includes a 0.5 second turn-on delay.
5. **Delay Switches** – These switches provide additional turn-on delay when the Standby connector is used. The switches are additive, providing as much as 7.5 seconds of delay to the 0.5 second Standby delay.
6. **Mains Connector** - Connection to the mains is via this 3-Prong IEC connector

WARNING: Do not remove the mains connector ground. It is illegal and dangerous.

- Important Safety Instructions – 2
- Introduction - 3
- The SRA Series - 4
- Physical Description - 5
 - Front Panel
 - Rear Panel
- Installation - 6
- Operation - 8
- Troubleshooting - 9
- Spec Table - 10
- Dimensions - 11
- Warranty - 12

Terminals marked with are HAZARDOUS LIVE. External wiring to these terminals/ connectors requires installation by trained personnel, or pre-manufactured cables

Important Safety Instructions – 2

Introduction - 3

The SRA Series - 4

Physical Description - 5
 Front Panel
 Rear Panel

Installation – 6
 Requirements
 Installation Density
 Typical Applications
 Connectors & Polarity

Operation - 8

Troubleshooting - 9

Spec Table - 10

Dimensions - 11

Warranty - 12

Installation

SRA-Series amplifiers are designed for use in both fixed and mobile sound systems. Each amplifier is shipped (unless otherwise specified) with the following factory settings:

Front panel:	Rear panel:
On/Off Switch = Off Attenuators = ∞	High Pass Filter(s) = Off Gain Selector = +26 dB Mode Selector = Stereo

Before connecting to mains power, make sure that the switches are set to the configuration needed for your particular application. Always switch the amplifier off before making any changes to the settings. Failure to do so could result in damage to the unit or other components in your system. **CAUTION:** When mounting or connecting the amplifier, always disconnect it from the mains. Use four screws and washers when mounting the amplifier to the front rack rails. Rear support is also recommended, especially for mobile or touring use. To reduce the risk of fire or electric shock, do not expose this apparatus to rain or moisture.

Requirements

SRA-Series amplifiers have specific physical, electrical and signal requirements for proper operation. These requirements will vary depending on your specific application, setup, and the settings on the amplifier. When setting up and testing your system, please take special care to double check all connections and settings. Please refer to the specifications section of this manual for specific input, output and other figures.

Installation Density

SRA-Series amplifiers produce substantial power output from a very small chassis. When driven at the higher-end of their potential, they do produce heat that must be dissipated. In cases where multiple SRA amplifiers are mounted together (or a single SRA with other equipment), it is recommended that a 1RU space is left between units to allow for proper air circulation. If the amplifier overheats, it will go into 'thermal' protect mode to prevent damage to itself and any connected components and speakers.

Typical Applications

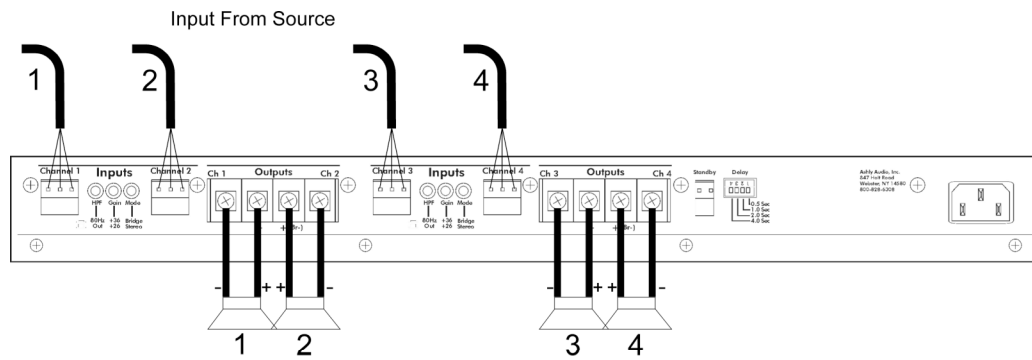

The most common use of a SRA-Series amplifier is a 2-channel source driving 2 speaker channels. In this illustration, the 4-channel amplifier is receiving two stereo signals and is driving two pairs of stereo speakers. The amplifier is in STEREO mode.

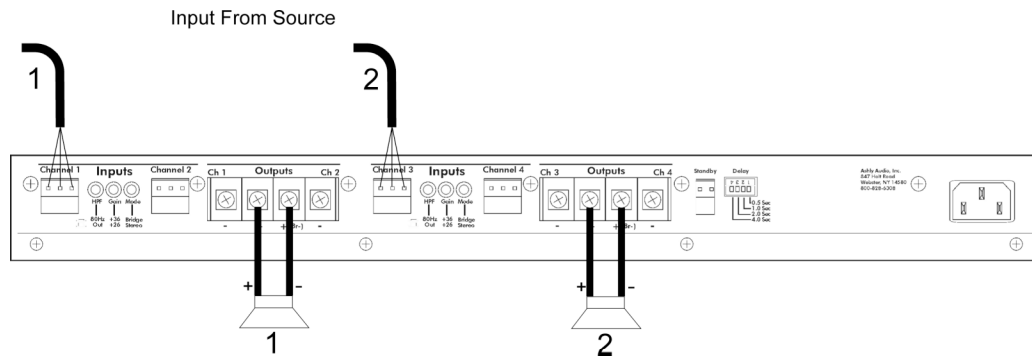

SRA-Series amplifiers are well suited to BRIDGED operation to drive a speaker load such as a subwoofer or a more powerful stereo output on a 4-channel model. This illustration shows a 4-channel SRA driving a Stereo signal in BRIDGED mode.

Connectors & Polarity

SRA-Series amplifiers utilize two types of professional audio connectors. For the inputs 3-pin Euroblock connectors are utilized with their polarity clearly marked on the amplifier's rear panel. Outputs are via screw terminal connectors. The polarity for these connectors is also clearly marked on the unit's chassis. However, polarity changes when the unit is operated in BRIDGED mode. Be sure to read the Operation section of this manual for important information on the two operating modes.

- Important Safety Instructions – 2
- Introduction - 3
- The SRA Series - 4
- Physical Description - 5
- Installation – 6
- Requirements
- Typical Applications**
- Connectors & Polarity**
- Operation - 8
- Troubleshooting - 9
- Spec Table - 10
- Dimensions - 11
- Warranty - 12

Important Safety
Instructions – 2

Introduction - 3

The SRA Series - 4

Physical Description - 5

Installation – 6

Operation – 8

 2 Channel Mode

 Bridged Mode

Troubleshooting - 9

Spec Table - 10

Dimensions - 11

Warranty - 12

Operation

The amplifier's On/Off Switch is a rocker-type switch located on the left side of the front panel. Turning on the amplifier initiates start-up by activating the inrush current limiter.

When using the remote On/Off function, the main On/Off switch must remain in the On position. See page 11 for more information on remote On/Off connections.

NOTE: The power switch does NOT isolate the appliance from mains. Make sure the mains power socket or an alternative disconnect device is near by and easily accessible. When the product is connected to mains, the line-filter and the input of the fuse are energized.

2 Channel (Stereo) Mode

In this mode, the amplifier's channels operate fully independent of each other. Each signal enters the unit and is amplified separately.

Bridged (Mono) Mode

In this mode, a single input is connected to channel 1 (or 1 & 3 in 4 channel models) and is connected to the two output channels that have been "Bridged" together.

Each output channel processes the signal, but the polarity of channel 2 (and channel 4, in 4 channel models) is reversed. The (single) load is connected between the two positive channel outputs. While the total output of the amplifier remains the same, both the available output voltage and the minimum impedance that can be connected are doubled, as compared with stereo operation.

Only Channel 1 (or 1 & 3) is active. A signal feeding Channel 2 (or 4) will have no effect on the output.

Troubleshooting

Situation	Indication	Action
No Sound	Signal LED not lit Clip LEDs not lit	Check AC plug. Confirm that AC outlet works by plugging in another device.
	Signal LED not lit	Make sure the signal source is operating and try another cable. Check position of Volume Pots.
	Signal LEDs responding to signal level	Check the speaker wiring for breaks. Try another speaker and cable.
	Protect LED is lit	Overheating will cause protective muting. Check for proper ventilation.
No Channel Separation	No Channel Separation	Check the mode indicators on the front panel and make sure the mode selector on the rear panel is in the two channel (stereo) position. Make sure other equipment in the signal path such as mixers and preamps are set for stereo, not mono
Distorted Sound	Power LED is lit	A faulty speaker or a loose connection could cause this. Check the wiring and try another speaker.
	Signal LEDs responding to signal level	The signal source might be clipping. Keep the volume pots at least halfway up so that the source does not have to be overdriven.
	Clip LEDs not lit	Keep the volume pots at least halfway up and try changing input sensitivity with the gain selector on the rear.
Hiss	Hiss	Unplug the amplifier input to confirm that the hiss is coming from the source or from a device upstream. Erratic or popping noises indicate an electronic fault in the offending unit. To keep the noise floor low, operate the primary signal source at full level, without clipping. Avoid boosting the signal further between the source and the amplifier.
Squeals and Feedback	Squeals and Feedback	Microphone feedback should be eliminated with mixer controls. If noise continues to build up with no microphone gain, there is a serious fault in the signal processors or cables. Working in succession from the signal source towards the amplifier and check each device in the signal path by reducing its gain or by unplugging it.

- Important Safety Instructions – 2
- Introduction - 3
- The SRA Series - 4
- Physical Description - 5
- Installation – 6
- Operation – 8
- Troubleshooting - 9
- Spec Table - 10
- Dimensions - 11
- Warranty - 12

Important Safety
Instructions – 2

Introduction - 3

The SRA Series - 4

Physical Description - 5

Installation – 6

Operation – 8

Troubleshooting - 9

Spec Table - 10

Dimensions - 11

Warranty - 12

Spec Table

	SRA-2075	SRA-4075	SRA-2150	SRA-4150
Power Output Per Channel				
Stereo Mode, all channels driven				
8 ohms, 20 Hz - 20 kHz, 1% THD	2 x 40W	4 x 40W	2 x 80W	4 x 80W
4 ohms, 20 Hz - 20 kHz, 1% THD	2 x 75 W	4 x 75 W	2 x 150 W	4 x 150 W
Bridged Mono Mode				
8 ohms, 20 Hz - 20 kHz, 1% THD	1 x 150 W	2 x 150 W	1 x 300 W	2 x 300 W
Signal to Noise (20 Hz-20 kHz, unweighted):	>98 dB	>98 dB	>105 dB	>105 dB
Voltage Gain:	26 dB, 36 dB sensitivity (selectable)			
Output Circuitry:	Class D	Class D	Class D	Class D
Power Consumption (Pink Noise @ 4 Ohm):				
1/8 th Output	18.75W	37.5W	37.5W	75.0W
1/8 th Draw	39.0W	74.0W	64.0W	125W
1/8 th Current	0.69A	1.24A	1.10A	1.98A
Idle Power	17.0W	30.0W	20.0W	36.0W
Idle Current	0.30A	0.52A	0.35A	0.62A
Frequency Response	20 Hz - 20 kHz, +/- 1.0 dB			
Damping Factor - 8 ohm load, < 1 kHz	> 200 into 8Ω			
Input Impedance	20 kOhm, balanced			
Maximum Input Level:	+21 dBu			
Input Impedance	20kΩ balanced			
Cooling	Convection			
Front Panel Indicators per channel	Clip & Signal			
Front Panel Indicators overall	power, standby, protect			
Attenuators	Per channel: front panel			
Input Connectors, each channel	3- Pin Euroblock			
Output connectors, each channel	Screw terminals			
Amplifier Protection	Output Overcurrent, DC Output, Mail Supply Rail Overvoltage Chassis Temperature, Inrush Limiting, Mains Fuse			
Power Cable Connector	3-Prong IEC			
Dimensions	19" x 1.75" x 11"			
Weight	9.0 lbs	10.0 lbs	9.0 lbs	10.0 lbs

All Specifications Subject to Change or Improvement Without Notice.

Amplifier Dimensions

All SRA Series amplifiers share the same dimensional measurements:

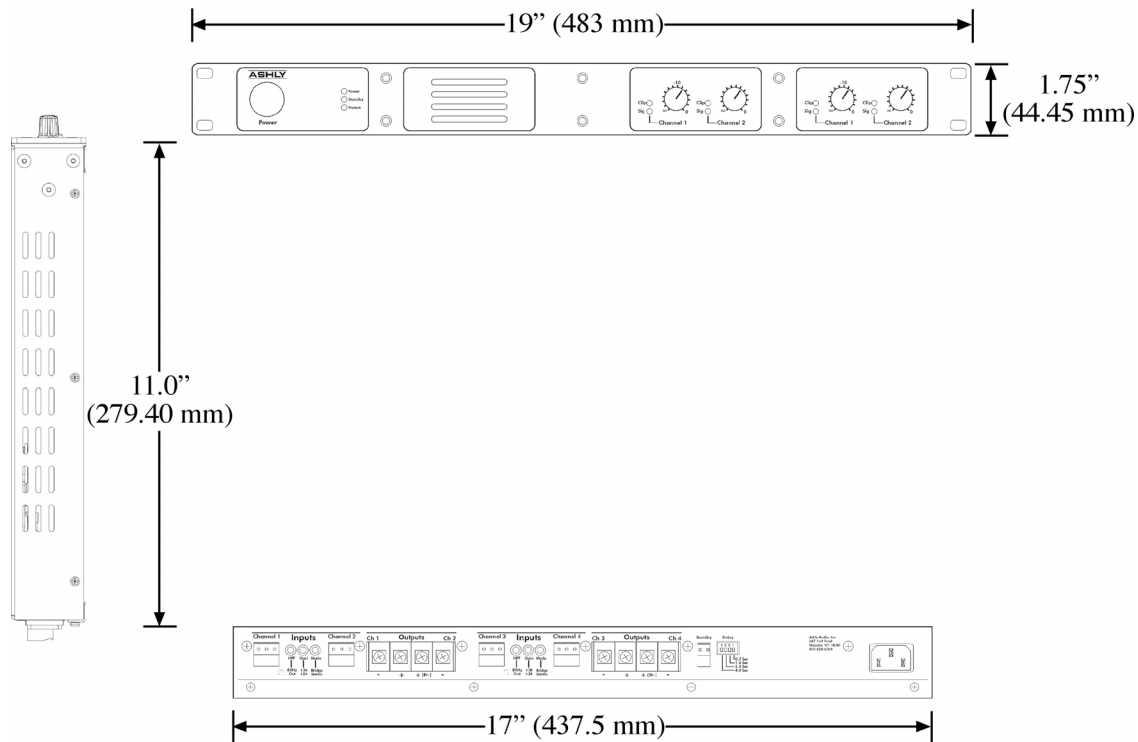

- Important Safety Instructions - 2
- Introduction - 3
- The SRA Series - 4
- Physical Description - 5
- Installation - 6
- Operation - 8
- Troubleshooting - 9
- Spec Table - 10
- Dimensions - 11
- Warranty - 12

Remote Power Connections

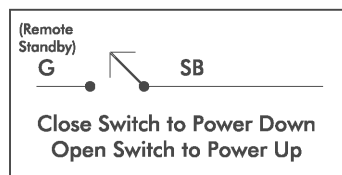
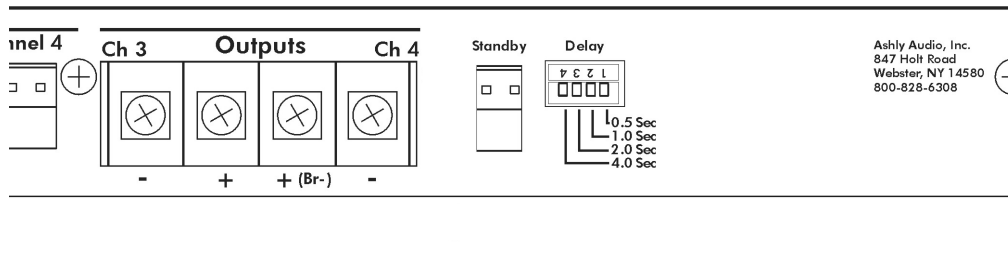

Remote Standby

Important Safety
Instructions – 2

Introduction - 3

The SRA Series - 4

Physical Description - 5

Installation – 6

Operation – 8

Troubleshooting - 9

Spec Table - 10

Dimensions - 11

Warranty - 12

Limited Warranty

Warranty service for this unit will be provided by ASHLY AUDIO, INC. in accordance with the following warranty statement.

ASHLY AUDIO, INC. warrants to the owner of this product that this product and the components thereof, will be free from defects in workmanship and materials for a period of FIVE years from the date of purchase. ASHLY AUDIO INC. (ASHLY AUDIO) will, without charge, repair or replace, at its option, defective product or component parts upon prepaid delivery to the factory service department or authorized service center, accompanied by proof of purchase date in the form of a valid sales receipt. This warranty gives you specific legal rights, and you may also have other rights, which vary from state to state.

EXCLUSIONS: This warranty does not apply in the event of misuse, neglect or as a result of unauthorized alterations or repairs. This warranty is void if the serial number is altered, defaced, or removed. ASHLY AUDIO reserves the right to make changes in design or make additions to or improvements upon this product without any obligation to install the same on products previously manufactured.

Any implied warranties which may arise under the operation of State law shall be effective only for FIVE years from the date of purchase of the product. Ashly Audio shall be liable only to correct defects in the product itself, and not for any damage or injury which may result from or be incidental to or a consequence of such defect. Some states do not allow either limitations on how long an implied warranty lasts, or the exclusion or limitation of incidental or consequential damages, so the above limitations or exclusions may not apply to you.

OBTAINING WARRANTY SERVICE:

For warranty service in the United States, please follow this procedure:

- 1.) Return the product to Ashly, freight prepaid, with a written statement describing the defect and application the product is used in. Ashly Audio will examine the product and perform any necessary service, including replacement of defective parts, at no further cost to you.
- 2.) Ship your product to:
Ashly Audio Inc.
Attn: Service Department
847 Holt Road
Webster, NY 14580-9103

For units purchased outside The United States of America, service will be provided by an authorized distributor of ASHLY AUDIO, INC.

Free Manuals Download Website

<http://myh66.com>

<http://usermanuals.us>

<http://www.somanuals.com>

<http://www.4manuals.cc>

<http://www.manual-lib.com>

<http://www.404manual.com>

<http://www.luxmanual.com>

<http://aubethermostatmanual.com>

Golf course search by state

<http://golfingnear.com>

Email search by domain

<http://emailbydomain.com>

Auto manuals search

<http://auto.somanuals.com>

TV manuals search

<http://tv.somanuals.com>