

ASUS[®]

P320

User Manual

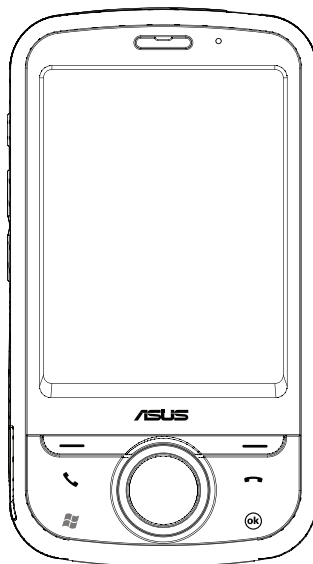

E3592

First Edition

May 2008

Copyright © 2008 ASUSTeK Computers, Inc. All Rights Reserved.

No part of this manual, including the products and software described in it, may be reproduced, transmitted, transcribed, stored in a retrieval system, or translated into any language in any form or by any means, except documentation kept by the purchaser for backup purposes, without the express written permission of ASUS Telecom ("ASUS").

Product warranty or service will not be extended if: (1) the product is repaired, modified or altered, unless such repair, modification of alteration is authorized in writing by ASUS; or (2) the serial number of the product is defaced or missing.

ASUS PROVIDES THIS MANUAL "AS IS" WITHOUT WARRANTY OF ANY KIND, EITHER EXPRESS OR IMPLIED, INCLUDING BUT NOT LIMITED TO THE IMPLIED WARRANTIES OR CONDITIONS OF MERCHANTABILITY OR FITNESS FOR A PARTICULAR PURPOSE. IN NO EVENT SHALL ASUS, ITS DIRECTORS, OFFICERS, EMPLOYEES OR AGENTS BE LIABLE FOR ANY INDIRECT, SPECIAL, INCIDENTAL, OR CONSEQUENTIAL DAMAGES (INCLUDING DAMAGES FOR LOSS OF PROFITS, LOSS OF BUSINESS, LOSS OF USE OR DATA, INTERRUPTION OF BUSINESS AND THE LIKE), EVEN IF ASUS HAS BEEN ADVISED OF THE POSSIBILITY OF SUCH DAMAGES ARISING FROM ANY DEFECT OR ERROR IN THIS MANUAL OR PRODUCT.

SPECIFICATIONS AND INFORMATION CONTAINED IN THIS MANUAL ARE FURNISHED FOR INFORMATIONAL USE ONLY, AND ARE SUBJECT TO CHANGE AT ANY TIME WITHOUT NOTICE, AND SHOULD NOT BE CONSTRUED AS A COMMITMENT BY ASUS. ASUS ASSUMES NO RESPONSIBILITY OR LIABILITY FOR ANY ERRORS OR INACCURACIES THAT MAY APPEAR IN THIS MANUAL, INCLUDING THE PRODUCTS AND SOFTWARE DESCRIBED IN IT.

Products and corporate names appearing in this manual may or may not be registered trademarks or copyrights of their respective companies, and are used only for identification or explanation and to the owners' benefit, without intent to infringe.

Table of Contents

Safety information	12
Mobile phone etiquette.....	18
Mobile manners.....	18
P320 specifications	19
Package contents	20

Chapter 1: Getting started

Getting to know your device.....	22
Layout	22
Getting your device ready.....	26
Installing the SIM card and battery.....	26
Charging the battery.....	28
Installing and removing a microSD card	28
Starting up	30
Powering your device.....	30
Using the stylus.....	30
Calibrating your device.....	31
Locking the keys and buttons.....	31
The Home screen.....	32
ASUS Today.....	33
The Today screen.....	39

ASUS Launcher.....	43
Searching for information	44
Getting Help	44

Chapter 2: Entering data

Using the Input Panel.....	46
Using the Block Recognizer	46
Using the Onscreen Keyboard.....	47
Using the Letter Recognizer.....	47
Using the Transcriber	48
Writing and drawing on the screen.....	49
Recording voice.....	50

Chapter 3: Device Synchronization

Synchronizing your device	54
Microsoft® ActiveSync.....	54
Synchronizing via mini-USB.....	56
Synchronizing via Bluetooth®	57
Synchronizing with an Exchange Server.....	58

Chapter 4: Phone features

Using the phone	60
Phone pad.....	60
Smart dialer.....	60
Turning off phone function.....	61
Adjusting the volume.....	61
Making a call	62
Using the phone pad	62
Making calls from Contacts.....	64
Making calls from Call History.....	64
Calling using the Speed Dial	65
Calling using the Voice Commander.....	66
Making emergency calls.....	67
Making international calls.....	67
Receiving a call	67
Options during a call	68
Managing multiple calls.....	69
ASUS Call Filter	70
Launching the shortcut menu.....	70
Managing the Accept list	71
Managing the Reject list.....	72

Chapter 5: Messaging

E-mail messaging	74
Setting up an e-mail account.....	74
Sending an e-mail message.....	76
Threaded SMS	79
Sending a threaded SMS.....	79
MMS messaging	80
Accessing MMS	80
Sending an MMS message.....	81
Windows® Live	83
Using Hotmail®	83
Using Windows® Live Messenger	84

Chapter 6: Organizing your life

Using Contacts	86
Viewing Contacts	86
Using Calendar	88
Scheduling an appointment.....	88
Viewing an appointment.....	89
Viewing your schedule	89
Using Tasks	90
The Tasks list	90

Chapter 7: Customizing your device

Customizing the Start menu	92
Using the Profile Manager	92
Using the Theme Manager	94
Customizing the Today screen	95
Entering your contact information	95
Setting up sounds and notifications	96
Setting the date, time, and alarm	96
Setting the ring tone	97
Adding ring tone to selection.....	97
Changing the ring tone.....	97
Wake up settings	98

Chapter 8: Getting connected

Using the Wireless Manager	100
Using Bluetooth®	101
Activating Bluetooth in your device	101
Adding Bluetooth devices.....	102
Pairing with a Bluetooth headset.....	102
Using Wi-Fi	103
Turning on Wi-Fi.....	103
Configuring wireless networks	103

Adding a wireless network	104
Using Wi-Fi Manager	105
Setting a GPRS connection	106
Connecting GPRS.....	107
Disconnecting GPRS	108
Using the GPRS Tool	108
Setting the network	109
Configuring the network	109
Setting your preferred network.....	109

Chapter 9: GPS features

GPS Catcher.....	112
Updating GPS data	112
Setting GPS Catcher.....	112
External GPS.....	113
Setting an external GPS device	113

Chapter 10: Multimedia features

Using the camera.....	116
Launching the camera.....	116
Camera mode	118
Taking photos	122

Video mode	123
Recording videos	126
Viewing pictures and videos	127
Viewing pictures and videos.....	127
Editing pictures.....	127
Streaming Player	129
Using the Streaming Player	130

Chapter 11: Business features

Ur Time	132
Setting the time	132
Setting the alarm	132
Setting the World Clock.....	133
Remote Calendar	134
Synchronizing your calendar.....	134
Setting the Remote Calendar.....	135

Chapter 12: ASUS Special features

ASUS status icon.....	138
USB setting	139
LCD Brightness.....	139
Battery	139
Memory	139

Storage card memory.....	139
Program memory	139
Settings	139
ASUS Zip	140
Backup.....	141
Backing up files.....	141
Backup Setting.....	142
Restoring files	142
Newstation.....	143
Using Newstation	143
Using Newstation menus	144
Auto Cleaner	146
Setting the Auto Cleaner	146

Chapter 13: Other features

Restoring default factory settings	148
System information	148
Task Manager	149

Appendices

Notices	152
Federal Communications Commission (FCC) Regulations.....	152
Canadian Department of Communications Statement.....	153
Replaceable batteries	153
Operator access with a tool.....	154
Specific Absorption Rate (SAR)	154
Bodyworn operation	154
Exposure to radio waves.....	154
ASUS Contact information	159

Safety information

Phone care

Do not attempt to open the phone casing. There are no user serviceable parts inside and you might damage sensitive electronic circuits and components. Unauthorized disassembly will void the warranty.

Do not leave your phone exposed to strong sunlight or excessive heat for a prolonged period. This may damage it.

Do not handle your phone with wet hands or expose it to moisture or liquids of any kind. Continuous changes from a cold to a warm environment may lead to condensation inside the phone, resulting in corrosion and possible damage.

If you pack your phone in your suitcase during travel, beware of damage. Cramming a suitcase may crack the LCD display. Remember to switch off your wireless connections during air travel.

As with all other radio devices, touching the built-in antenna area during telephone conversation may impair the quality and lead to shorter standby time due to increased power consumption.

The battery

Your phone is equipped with a high performance Li-Ion battery. Optional battery types may be available, check with your local retailer. Observe the maintenance guidelines for a longer battery life.

- Do not overcharge the Li-Ion battery, as this can result in a reduction in battery performance and lifespan. The recommended maximum charge time is three hours.
- Avoid repeated short charging. It is preferable to let the battery go fully discharged and then recharge it completely.
- Avoid charging in extremely high or low temperature. The battery has its optimum performance in an ambient temperature of +5 °C to +50 °C.
- Do not store the battery near a fire or heat source.
- Use only the battery approved by the manufacturer.
- Never replace the battery with a non-approved battery.

- Never soak the battery in water or any other liquid.
- Never try to open the battery as it contains substances that might be harmful if swallowed or allowed to come into contact with unprotected skin.
- Never short-circuit the battery, as it may overheat and cause a fire. Keep it away from jewellery and other metal objects.
- Never dispose of the battery in fire. It could explode and release harmful substances into the environment.
- Never dispose of the battery with your regular household waste. Take it to a hazardous material collection point.
- Do not touch the battery terminals.

The charger

- Avoid using the phone while charging.
- Use only the charger supplied with your phone.
- Never pull the charger cord to release it from the mains – pull the charger itself.

WARNING!

There is a risk of explosion if the battery is replaced by an incorrect type.

Memory card

- Do not remove or insert a memory card or turn off the handset while data on the card is being read.
- Do not touch the metal terminals with your hands or metal objects.
- Do not bend the memory card or subject it to violent impacts. Keep it away from water and high temperatures.
- Keep all memory cards out of the reach of small children.

- Do not short circuit the contact points or expose it to liquids or moisture. When not in use, keep it in an antistatic container.
- Do not use force when inserting or handling the card, and do not expose it to excessive heat or strong magnetic fields.

Cleaning and storing

- Your phone should always be handled with care and protected from dirt, dust and dampness. To avoid scratches, never place your phone face down.
- If cleaning is necessary, switch the phone off and wipe carefully with a soft, slightly damp (not wet) cloth. Use a cotton swab to clean the camera lens. Allow the phone to dry completely before switching it on. Never use solvents for cleaning.
- If you are not going to use your phone for some time, fully charge the battery and store the phone in a dry place away from direct sunlight. Your phone should be switched off during storage. Recharge every 6 to 12 months.
- Never expose your phone to heat or strong sunlight.
- Never expose your phone to moisture or liquids of any kind.
- Do not paint your phone or otherwise block the keypad, microphone or earpiece function.
- Do not place stickers that may block the keypad or disturb other functions such as microphone, earpiece, or camera lens.

WARNING! Failure to follow these instructions may lead to serious personal injury and possible property damage.

Driving safely

Never use handheld phones while driving. It is an offence, that while driving, to hold a phone or cradle it in your neck at any point, during the setup, making or taking of a phone call, text message or any other data related mobile communication. Use of fully installed car kits are still permitted, as are the use of alternate handsfree accessories.

In the interest of safety, we would recommend the use of a cradle while using any form of handsfree accessory.

While driving, we recommend that you use voicemail wherever possible, and that you listen to your messages when you are not in the car. If you must make a handsfree call when driving, keep it brief.

Do not place objects, including both installed or portable wireless equipment, in the area over the airbag or in the airbag deployment area. An airbag inflates with great force. If the airbag inflates, serious injury could result.

Electronic devices

Most modern electronic equipment is shielded from RF energy.

However, certain electronic equipment may not be shielded against the RF signals from your device.

Pacemakers

The Health Industry Manufacturers' Association recommends that a minimum separation of six (6") inches be maintained between a phone and a pacemaker to avoid potential interference with the pacemaker. These recommendations are consistent with the independent research by and recommendations of Wireless Technology Research.

If you have a pacemaker:

- Always keep your phone more than six inches (15cm) from your pacemaker when turned on.
- Do not carry your phone in your breast pocket.
- Use the ear opposite the pacemaker to minimize the potential for interference
- If you have any reason to suspect that interference is taking place, turn your phone off immediately.

Hearing aids

Some digital phones may interfere with some hearing aids. In the event of such interference, call ASUS Customer Service to discuss alternatives.

Other medical devices

If you use any other personal medical device, consult the manufacturer of your device to determine if it is adequately shielded from external RF energy. Your physician may be able to assist you in obtaining this information.

Turn your phone off in healthcare facilities when any regulations posted in these areas instruct you to do so.

Hospitals or healthcare facilities may be using equipment that could be sensitive to external RF energy.

Vehicles

RF signals may affect improperly installed or inadequately shielded electronic systems in motor vehicles. Check with the manufacturer or its representative regarding your vehicle. You should also consult the manufacturer of any equipment added to your vehicle.

Posted facilities

Turn your phone off where posted notices so require.

Magnetic media

Magnetic fields generated by mobile devices may damage data on magnetic storage media, such as credit cards, computer discs or tapes. Do not place your phone next to such media.

You should never expose your phone to strong magnetic fields as this may cause temporary malfunction.

Other Safety Guidelines

Aircraft

Regulations prohibit using your phone while in the air. Switch off your phone before boarding an aircraft or turn off the wireless connections.

Blasting areas

To avoid interfering with blasting operations, turn your phone off when in a 'blasting area' or in areas posted: "Turn off two-way radio." Obey all signs and instructions.

Potentially explosive environments

Turn your phone off when in any area with a potentially explosive environment and obey all signs and instructions.

Sparks in such areas could cause an explosion or fire resulting in bodily injury or even death.

Areas with a potentially explosive environment are often, but not always, clearly marked. They include fuelling areas such as gas stations, below decks on boats, fuel or chemical transfer or storage facilities, vehicles using liquified petroleum gas (such as propane or butane), areas where the air contains chemicals or articles, such as grain, dust, or metal powders, and any other area where you would normally be advised to turn off your vehicle's engine.

Choking

Keep your phone away from children as the SIM card and other small parts present a choking hazard.

Cautions

Your device is a high quality piece of equipment. Before operating, read all instructions and cautionary markings on (1) AC Adapter (2) Battery and (3) Product Using Battery.

- Do not use this device in an extreme environment where high temperature or high humidity exists.
- Do not abuse the device. Avoid striking, shaking or giving it a shock. When not using the unit, lay it down to avoid possible damage due to instability.
- Do not expose this device to rain or other liquid.
- Do not use unauthorized accessories.
- Do not disassemble the phone or its accessories. If service or repair is required, return the unit to an authorized service center. If the unit is disassembled, a risk of electric shock or fire may result.
- Do not short-circuit the battery terminals with metal items.

Mobile phone etiquette

As mobile phone usage rises, there is now a need to create a set of manners in using a mobile phone in professional and social settings. This section provides you with basic tips with regards to respecting others while using your mobile phone.

Mobile manners

- Avoid talking on your mobile phone when in enclosed public places such as theaters, libraries, museums, places of worship, elevators, or auditoriums.
- Avoid using your mobile phone while doing other tasks such as driving, shopping, banking, waiting in line, or conducting other personal business.
- Avoid using annoying ring tones.
- Avoid taking a call on your mobile phone during business meetings, appointments, or interviews.
- Look for a private place to take a call, and keep your phone conversations brief.
- Talk on your mobile phone quietly, and do not shout.
- Put your mobile phone on silent or vibrator mode to avoid disturbing others.
- Ask permission before taking a picture or a video clip of another person.
- Avoid using capital letters when sending SMS messages as this can be interpreted as shouting.
- When making a call, introduce yourself to the person at the other end of the line, and do not hang up without saying goodbye.

P320 specifications

Processor	TI OMAP 850 200MHz
Operating System	Microsoft® Windows Mobile™ 6.1 Professional
Memory	128 MB Flash ROM 64 MB DDR RAM
Display	2.6-inch, 240 x 320 TFT Touchscreen Liquid Crystal Display (LCD) with 65,536 color and LED backlighting
Frequency band	Quadband GSM (850/900/1800/1900 MHz) Integrated GSM/GPRS/EDGE and GPS with internal antenna
GPS	Built-in SiRF Star III chipset
GPRS	Class B, Multi-slot class 10
Camera	2.0 megapixel Auto Focus camera
Connectivity	Bluetooth : V2.0+EDR USB : USB Client 1.1 WLAN : IEEE 802.11b+g
Battery capacity	1100 mAh Lithium Ion (Manufacturer: Welldone; Model: SBP-17 LION HARD-PACK)
Expansion slot	MicroSD card slot
Audio	Built-in microphone and stereo output speaker
Weight	105g (with battery)
Dimension	99 mm (L) x 54.5 mm (W) x 13.35 mm (T)
Talk time*	4 hrs (*vary with different networking environment and scenario)
Standby time*	200 hrs (*Vary with different networking environment and scenario)

NOTE: Specifications are subject to change without notice.

Download from Www.Somanuals.com. All Manuals Search And Download.

Package contents

Check your device package for the following items:

Standard Items

- ASUS P320 PDA phone
- Battery
- AC adapter
- Mini-USB sync cable
- Headset
- Stylus
- Bonus CD (User Manual included)
- Quick Start Guide
- Protection case
- External GPS antenna connector
- Warranty Card
- Getting Started CD
- Car kit (PDA holder and windshield suction pedestal)*
- Car cell phone charger*
- microSD card*
- Navigation CD & manual*

*Optional

NOTES:

- The Protection case is only for protective usage and not a bodyworn accessory.
 - The external GPS antenna connector is MMCX compatible.
 - If any of the above items is damaged or missing, contact your retailer.
-

Chapter 1

Getting started

- Getting to know your device
- Getting your device ready
- Starting up
- The Home screen
- ASUS Launcher
- Searching for information
- Getting Help

Getting to know your device

Layout

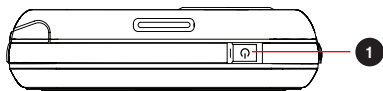

Top feature

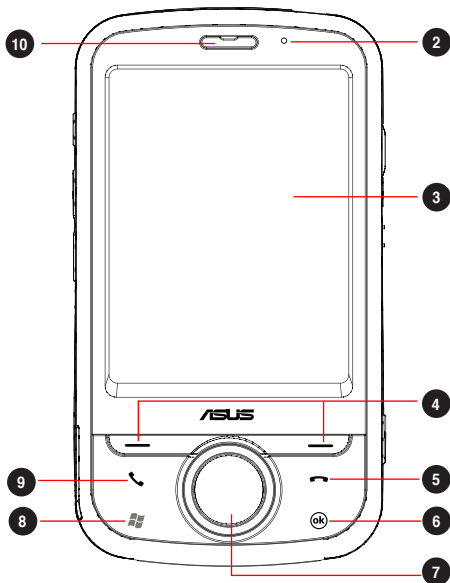

Front features

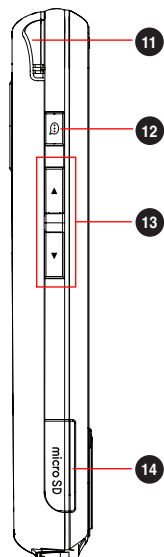

Left features

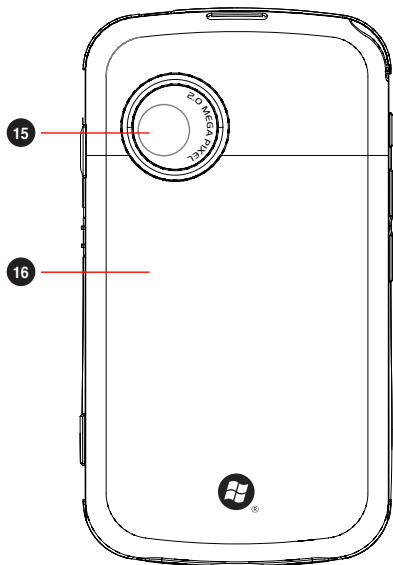

Back features

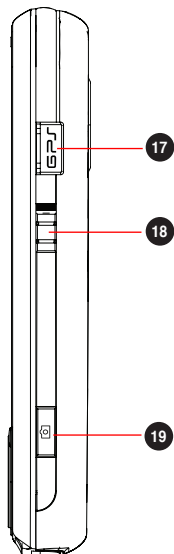

Right features

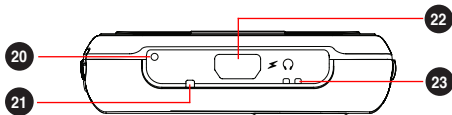

Bottom features

No.	Item	Description
1	Power button	Press and hold to turn the power ON or OFF. Press once to set suspend mode or to wake device from sleep mode.
2	Power indicator LED	This multicolor LED notifies the following: <ul style="list-style-type: none"> • Green: Phone fully charged. • Flashing green: Network detected. • Red: Phone is charging. • Flashing red: Event notification. • Flashing blue: Bluetooth[®], Wi-Fi, or GPS is ON.
3	LCD touch screen	This 2.6-inch, 65,536 color, 240 x 320 resolution, touchscreen TFT LCD allows you to write, draw, or make selections using the stylus.
4	Left and Right Soft keys	Perform the command indicated above the button.
5	End key	Press to end a call.
6	OK key	Press to confirm a command or press to close/exit an open application.
7	Navigation key	This five-direction navigation key allows you to navigate through menus. Press center to confirm a command.
8	Start key	Press to launch the Start menu.
9	Call key	Press to receive an incoming call or to make a call.
10	Earpiece receiver	Allows you to listen to an active call.
11	Stylus	Use the stylus to write, draw, or select items on the touch screen.

No.	Item	Description
12	Record key	Press and hold to launch voice recording.
13	Volume key	Allows you to adjust the volume.
14	microSD slot	Insert a microSD storage card into this slot.
15	Camera lens	This 2.0 megapixel camera comes with auto focus lens for taking pictures and video clips.
16	Battery compartment	Contains the battery that supplies power to the device.
17	GPS antenna connector	Allows you to install an external GPS antenna for better signal reception. An MMCX compatible connector is included in the package.
18	Hold key	Slide to enable or disable all keys including the LCD touch screen.
19	Camera key	Press to take pictures or video.
20	Reset button	Using the stylus, press reset button to soft reset your device.
21	Microphone	The built-in microphone enables you to make or receive phone calls, record sounds and voice, or give voice commands.
22	Mini-USB connector	Use this connector to synchronize your data, to charge the battery, or to insert the headset.
23	Carrying strap hole	Allows you to attach a strap to the device.

Getting your device ready

Installing the SIM card and battery

Before you can make a phone call using your device, you need to install a Subscriber Identity Module (SIM) card. A SIM card contains your phone number, subscriber details, phonebook, and additional phone memory.

Your device comes with a rechargeable Lithium Ion (Li-Ion) battery.

New batteries come partially discharged and should be fully charged before using them.

CAUTION: Use only an ASUS qualified battery.

To install a SIM card and battery:

1. Remove the battery compartment cover.

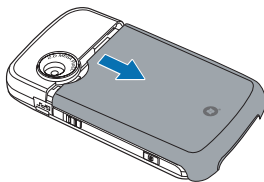

2. Insert the SIM card with its gold contacts facing down and the notched corner oriented to the lower left corner of the slot.

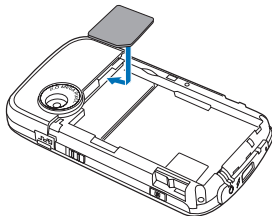

- Put the battery into the compartment with its copper contacts properly aligned to the copper conductor on the device.

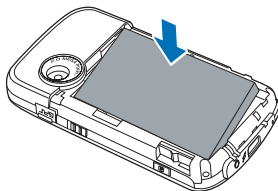

- Replace the battery compartment cover.

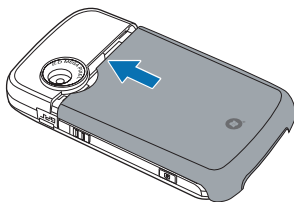

Charging the battery

The bundled battery pack is shipped partially charged. Charge the battery up to four hours before using for the first time.

To charge the battery:

1. Connect the AC adapter plug to the mini-USB connector at the bottom of the device.
2. Connect the AC power plug to a grounded wall socket or power strip.

NOTES:

- The notification LED turns red and charging battery icon appears on the status bar indicating that the battery is charging.
 - If your battery gets totally discharged, you need to recharge it for at least twenty minutes before you can turn it back on.
-

Installing and removing a microSD card

Your device is equipped with a microSD card slot. A microSD card provides you with extra memory space to store your files.

To install the microSD card:

1. Remove the battery compartment cover.

NOTE: There is no need to remove the battery.

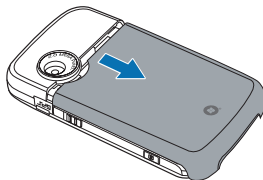

2. Locate the microSD card slot at the left side of the device. Lift and slightly rotate the slot cover to open.
3. With the golden fingers facing up, insert the microSD card into the slot until it snaps properly.
4. Push back the slot cover cover to close.
5. Replace the battery compartment cover.

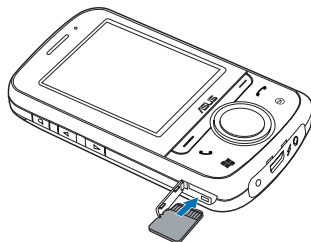

To remove the microSD card:

1. Remove the battery compartment cover.
2. Open the slot cover, push the card until it ejects out, then remove the card safely.
3. Push back the cover to close.
4. Replace the battery compartment cover.

Starting up

Powering your device

Ensure that your device is fully charged before starting the device for the first time.

To turn power on:

1. Press and hold the power button.

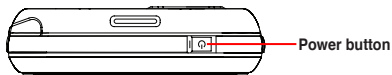

2. Follow the onscreen instructions to align the screen and set the local time zone.

Using the stylus

The stylus is a pen-like device found behind the upper left corner of your device.

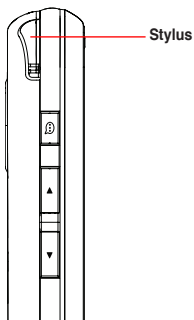

- Use the stylus to write, draw, select, or drag an item on the screen.
- Single tap an item to select it.
- Tap and hold an item to see a menu.

Calibrating your device

Calibrating your device ensures that the item you tap on the screen is activated. This involves tapping in the center of targets that appear in various locations on the screen.

To calibrate your device:

1. Tap  > **Settings** > **System** tab > **Screen**.
2. On the **General** tab, tap **Align Screen**, then follow the succeeding calibration screen instructions.

Locking the keys and buttons

You can lock the keys and buttons of your device to avoid inadvertently dialing numbers or launching any application.

To lock the keys and buttons:

1. Locate the Hold button on the right side of your device.
 2. Slide the hold button downward to lock.
- To unlock, slide the hold button upward.

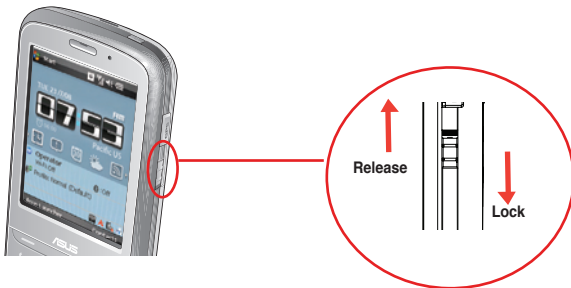

The Home screen

The Home screen on your device displays two parts: the ASUS Today and the Today screens.

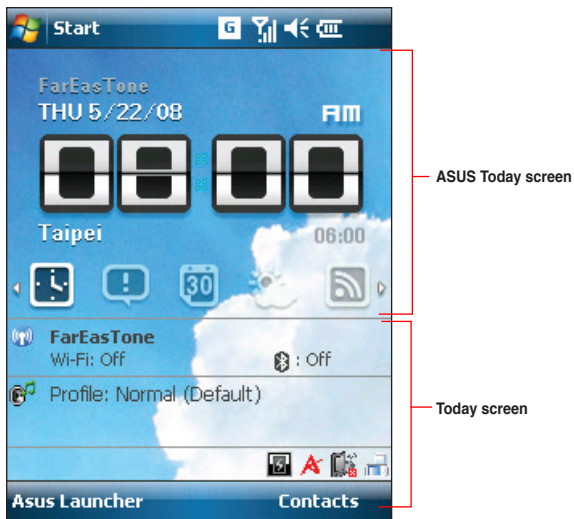



ASUS Today

ASUS Today on your device's home screen enables you to view or change your time/date settings, notifies you of your missed calls and SMS/MMS/e-mail messages, displays your day's appointments, updates you on the current weather and latest news, and enables you to add and play media files on your device.













NOTE: You can disable the ASUS Today from your Home screen following the instructions below.

To disable the ASUS Today:

1. Tap  > **Settings** > **Today** > **Items** tab.
2. Deselect the check box of **Asus Today**, then tap .

Icons





Refer to the table below for the ASUS Today icons.

Icon		Description
Date/time icon		Displays your date/time settings.
Alert icon		Alerts you on your missed calls, and new SMS/MMS/e-mail messages.
		Alerts you on your missed calls.
		Alerts you on your new SMS messages.
		Alerts you on your new MMS messages.
		Alerts you on your new e-mail messages.
Calendar icon		Displays your appointment for the day.
Weather icon		Displays the current weather.
News icon		Displays the latest news.
Media icon		Enables you to add and play media files.

Viewing alerts

ASUS Today notifies you of your missed calls, and new SMS/MMS/e-mail messages.

To view alerts:

1. Tap , then tap any of the icons for the information that you want to view.
 - Tap  to view your missed calls.
 - Tap  to view/read your new SMS messages.
 - Tap  to view/read your new MMS messages.
 - Tap  to view/read your new e-mail messages.

NOTE:

To read your e-mail messages, ensure that you are connected to the Internet via Wi-Fi or GPRS connection. Refer to the Wi-Fi or GPRS sections in this user guide for more details.

Viewing your day's appointment

To view your day's appointment:

- Tap  to view your day's appointment on the display screen. If you want to change the information, just click the display screen, then make the necessary changes on the Calendar screen.

NOTE:

You may also enter your calendar of activities or appointments from the ASUS Today screen. Tap , then tap the display screen, and enter the information for your appointments. You will be notified of your appointment on the day itself.



Obtaining the current weather data

ASUS Today enables you to obtain and view the latest weather data of any place around the world.

NOTES:

- Ensure that you are connected to the Internet via Wi-Fi or GPRS connection. Refer to the Wi-Fi or GPRS sections in this user guide for more details.
 - Before using this feature, ensure that you have configured the weather and network settings. For more details on configuring the network settings, refer to the section **Setting the network** in Chapter 8 of this user guide.
-

To configure the weather settings:

1. To launch the Weather Settings page, you may either:
 - Tap the weather icon on the ASUS Today screen.
 - Tap  > **Settings** > **Asus Today**.
2. Select **Enable Weather Update**.
3. Select the **Country** and **City** that you want to obtain the latest weather data for.
4. Tap  when done.

To obtain the current weather data:

1. From the ASUS Today screen, tap , then tap the display screen to retrieve the latest weather updates from the server.

Downloading the latest news updates

To download the latest news updates:

NOTE: Before downloading news updates, ensure that you are connected to the Internet via Wi-Fi or GPRS connection. Refer to the Wi-Fi or GPRS sections in this user guide for more details.

1. Tap , then tap the display screen. The Newstation screen is displayed.
2. From the Categories list, select the channel that you want to obtain the latest news updates from.

NOTE: Ensure that you are connected to the Internet to get the latest news updates.

3. Tap **Menu > Update**. Your news downloads are stored as RSS news feeds on your device and displayed on the ASUS Today screen.

NOTES:



- You may read these stored RSS news feeds from the ASUS Today screen even without Internet connection.
 - You may also access the Newstation application and download news updates through tapping  > **Programs > Newstation**. Refer to the **Newstation** section in this user guide for more details on the Newstation application.
-

Playing audio files

ASUS Today gives you quick access to the Windows® Media Player, enabling you to play digital audio files stored on your device or in a storage card. You can listen to audio files through the speaker of your device or through a headset.

NOTE: Your device may run low on memory and slow down if you store files on your device. We recommend that you store audio and video files in a storage card.

To play an audio file:

1. Tap , then tap the display screen. The Windows® Media Player is launched.
2. Select a file to play from the Library list, a storage card, or from your favorite website.
 - To select a file from the Library list, tap **Menu > Library**, then locate the file.
 - To select a file that is not on the Library list, tap **Menu > Open File**.
 - To select a file from your favorite website, tap **Menu > Open URL**, then key in the web address, or select from the **History** list.
3. Tap  to play your selected audio file.

The Today screen





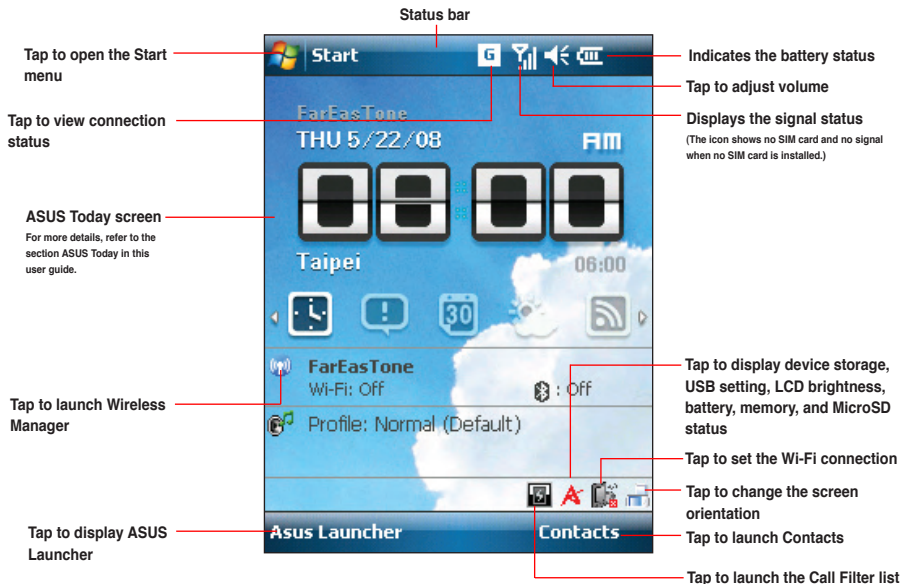





The Today screen displays information useful to you. You can configure the Today screen to have all the important information that you need.

NOTE: To know more about customizing the Today screen, refer to the section **Customizing the Today screen** in Chapter 7 of this user guide.















Status indicators

Refer to the table below for the status indicators.

Icon	Description
Call status	 Call in progress
	 Call forwarded
	 Call on hold
	 Missed call
General Packet Radio Service (GPRS) connection status*	 GPRS available
	 Connecting via GPRS
	 Connected via GPRS
Bluetooth connection	 Connecting with Bluetooth
	 Bluetooth headset connected
	 Bluetooth headset connected with sound

NOTE: *The icon displayed for your Packet Service connection will depend on your location and mobile service provider.

Icon		Description
ActiveSync connection status		ActiveSync synchronization in progress
		Connecting with ActiveSync
		ActiveSync connection not active
		Synchronization error
Wi-Fi connection status		Wi-Fi is not connected
		Wi-Fi connected
Sound status		Sound ON
		Sound OFF
		Vibrate or Meeting mode on
Roaming service		This icon appears if your device has roaming service subscription with your mobile service provider.
Alarm status		Appears when you set the alarm
SIM card status		No SIM card installed
Notification status		Notice indicator

Screen orientation

You can set the screen to two different orientations:

- 1 Portrait
2. Landscape

Set to Portrait mode to get a better view or better operation of certain applications on your device. Set to Landscape when viewing pictures, video or viewing longer text files.

To change the screen orientation, tap  > **Settings** > **System** tab > **Screen** then select the orientation you want.

You can also change the orientation by tapping the  icon.

Start menu

The Start menu contains various programs and applications that you commonly use. Tap  to display the start menu items.

You can also customize the items that appear in the Start menu. To do this:

1. Tap  > **Settings** > **Personal** tab > **Menus**.
2. Select the check boxes of the items you want to appear in the Start menu. You can select up to seven items.

ASUS Launcher

ASUS Launcher is an alternative program that allows you to conveniently and quickly launch applications, perform tasks, and change device settings.

To launch the ASUS Launcher:

- Tap  > Programs > **ASUS Launcher**.
- Tap **ASUS Launcher** from the Today screen.
- From the Today screen, press the left soft key.

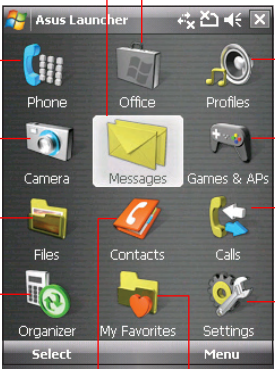

The screenshot shows the ASUS Launcher application window with a grid of icons. Red lines connect text callouts to specific icons:

- Tap to access messaging tools that allows you to write/read email, MMS, or text messages.** (Points to the Messages icon)
- Tap to use the phone feature.** (Points to the Phone icon)
- Tap to launch camera.** (Points to the Camera icon)
- Tap to launch File Explorer and view pictures/video, or search for files.** (Points to the Files icon)
- Tap to launch Calculator or ActiveSync.** (Points to the Organizer icon)
- Tap to display the Contacts list.** (Points to the Contacts icon)
- Tap to access MS Office, list tasks, set appointments, or jot notes.** (Points to the Office icon)
- Tap to modify your device profile. You can also adjust the device audio and sound.** (Points to the Profiles icon)
- Tap to launch games and applications menu.** (Points to the Games & APs icon)
- Tap to display your call history list. You can also make a call, send a message, delete call history, and check or reset call timer from this section.** (Points to the Calls icon)
- Tap to access submenus and modify the Audio, Personal, System, and Connection settings. You can also display your device information or restore the default settings of your device from this option.** (Points to the Settings icon)
- Tap to display items of My favorite web links.** (Points to the My Favorites icon)

NOTE: Install **ASUS Launcher** from the Bonus CD that comes with your device package.

Searching for information

Using the search tool, you can search for files and other items stored in your device or the external microSD card. You can search by file name or by words located in various applications including the Calendar, Contacts, Excel Mobile, Word Mobile, Help, Messaging, Notes, and Tasks. You can also filter your search to files larger than 64 KB.

To search for a file or an item:

1. Tap  > **Programs** > **Search**.
2. In **Search for** field, enter the file name, word, or other information you want to search.
3. In **Type** field, select the data type to help you filter your search.
4. Tap **Search**. Found items are listed in Results.
5. In the Results list, tap the item with the information you need.

Getting Help

To get help for a program:

- From the Today screen or any application, tap  > **Help**. A page will open with links to topics that explain how to use the program.

Chapter 2

Entering data

- Using the Input Panel
- Writing and drawing on the screen
- Recording voice

Using the Input Panel

When you start an application or select a field that requires text, symbols, or numbers, the Input Panel icon appears on the menu bar. The Input Panel allows you to select various input methods including: **Block Recognizer**, **Keyboard**, **Letter Recognizer**, and **Transcriber**.

Using the Block Recognizer

The Block Recognizer allows you to use a single stroke to write letters, numbers, symbols, or punctuations, which are converted into typed text.

To use the Block Recognizer:

1. From an application, tap the Input Panel arrow, then tap **Block Recognizer**.
2. Write letters, numbers, symbols, or punctuations in the designated writing area.
 - Write letters on the **abc** (left) area of the box.
 - Write numbers on the **123** (right) area of the box.
 - Tap the special symbols button to input symbols, punctuations and other special characters.
 - Tap Help  button for help on how to write characters.

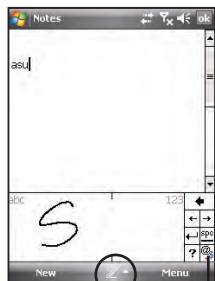

Input panel

Tap for special characters

Using the Onscreen Keyboard

With the onscreen keyboard, you can input text, symbols, numbers, or other special characters when input is possible.

To enter text using the onscreen keyboard:

1. From an application, tap the Input Panel arrow, then tap **Keyboard**.
2. Input text by tapping keys on the onscreen keyboard.

To enlarge the onscreen keyboard:

1. Tap the Input Panel arrow, then tap **Option**.
2. Select **Keyboard** from the Input Method list.
3. Tap **Large Keys**.

Using the Letter Recognizer

With the Letter Recognizer you can write individual letters, numbers, or special characters, which are converted into typed text.

To use the Letter Recognizer:

1. From an application, tap the Input Panel arrow, then tap **Letter Recognizer**.
2. Write letters, numbers, symbols, or punctuations in the designated writing area.
 - Write capital letters on the **ABC** (left) area of the box.
 - Write lower case letters on the **abc** (middle) area of the box.
 - Write numbers on the **123** (right) area of the box.
 - Tap the special symbols button to input symbols, punctuations and other special characters.
 - Tap Help  button for help on how to write characters.

Using the Transcriber

Transcriber is a handwriting recognition program that allows you to write in cursive, print, or mixed styles. It reliably recognizes not only written text but also numbers and symbols. Make sure to write legibly. See Help for more information on the Transcriber.

To use the Transcriber:

1. Start an application that accepts user input, such as Notes or Word Mobile.
2. Tap the Input Panel arrow, then tap **Transcriber**.

To write using Transcriber (using Notes):

1. Tap screen to position the cursor where you want the text to appear.
2. Use the stylus to write on the screen. The handwriting will be converted to text after you lift the stylus from the screen.



To edit text:

1. Draw a line across the text you want to edit. After you lift the stylus from the screen, the line will disappear and the selected text will be highlighted.
2. You can now rewrite the text or use the Transcriber gestures to edit your selected text. See Help  for the Transcriber gestures.

Writing and drawing on the screen

You can write or draw directly on the screen and save notes in your own handwriting. If you prefer to use your own handwriting or use drawings in your notes, set the default input mode to **Writing**. If you prefer text, set the default mode to **Typing**.

To set the default input mode for Notes:

1. Tap  > **Programs** > **Notes**.
2. From the Notes list, tap **Menu** > **Options**.
3. In the **Default mode:** box, tap the down arrow and select any of the following:
 - **Writing** if you want to draw or enter handwritten text in a note.
 - **Typing** if you want to create a typed note.
4. Set the other options according to your preference.
5. Tap  when finished.

To write a note:

1. Tap  > **Programs** > **Notes**.
2. From the Notes list, tap **New**.

If you set the **Default mode** to **Typing**, a blank page appears for typed text.

If you set the **Default mode** to **Writing**, a page with horizontal lines appears for handwritten text.



You can also tap **Menu** and then select/deselect **Draw** option to switch between typing and writing mode.

3. Write/Draw on the screen.
4. When finished, tap  to save the note and return to the Notes list.

Recording voice

At any time, whether your phone is on standby or active mode, you can record sound, voice, or add a recording to a note while using your device.



To create a voice recording:

1. Tap  > **Programs** > **Notes**.
2. From the Notes list, tap **New**.
3. If you do not see the recording toolbar, tap **Menu** > **View Recording Toolbar**.
4. Tap  to begin recording.
5. Place the receiver near your mouth or source of sound.
6. Tap the stop icon when finished recording. A recording icon appears on the note to indicate saved note.
7. Tap .

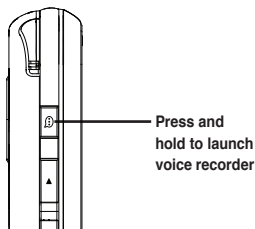
NOTE: You may also press and hold the Voice Commander button to begin recording.



To add a recording to a saved note:

1. Tap  > **Programs > Notes**.
2. From the Notes list, tap to open a saved note.
3. If you do not see the recording toolbar, tap **Menu > View Recording Toolbar**.
4. Tap  to begin recording.
5. Place the receiver near your mouth or source of sound.
6. Tap the stop icon when recording is finished. A recording icon appears on the note.
7. Tap .



Chapter 3

Device Synchronization

- Synchronizing your device
- Microsoft® ActiveSync

Synchronizing your device

Your device enables you to synchronize data in your device with the data on your computer. You can synchronize contents and transfer data between your device and your computer using Microsoft® ActiveSync on Windows XP™ platform, or Windows Mobile Device Center on Windows Vista™ platform.

NOTE: For synchronizing on Windows Vista™ platform, refer to the Windows Mobile Device Center's website at <http://www.microsoft.com/windowsmobile/devicecenter.mspx>

Microsoft® ActiveSync

ActiveSync allows you to synchronize data in your device with data in your computer. ActiveSync can also synchronize over a wireless or mobile network with Microsoft Exchange Server, provided that your mobile phone service or company is running Microsoft Exchange Server with Exchange ActiveSync. When synchronized directly with Exchange Server, you can stay up to date even when your computer is turned off.

During synchronization, ActiveSync compares the data in your device with the data in your computer or Exchange Server, and updates all data with recent changes.

You can select and synchronize data in the following locations using ActiveSync:

- Contacts
- Calendar
- Email
- Tasks
- Notes
- Favorites
- Files
- Media

You can also exchange data between your computer and device without synchronizing.

ActiveSync is already installed in your device, but before you can synchronize data with your computer, you must first install ActiveSync in your computer. You can download the latest ActiveSync program from www.microsoft.com.

After you have installed ActiveSync, set up a sync relationship between your device and your computer. ActiveSync recognizes your device and automatically transfers the synchronization settings you have in your device.

If you wish to synchronize your device with Exchange Server through your company or service provider, obtain the name of the Exchange Server, user name, password, and domain name from your network administrator before starting the Sync Setup Wizard.

To install and configure ActiveSync in your computer:

1. Insert the Getting Started CD that came with your device package.
2. Follow the screen instructions.
3. After the setup is complete, the Sync Setup Wizard automatically starts when you connect your device to your computer. Follow screen instructions to complete the wizard.
4. From the Sync Setup Wizard, you can:
 - Configure an Exchange Server connection to synchronize directly with an Exchange Server. Acquire from your network administrator the required parameters for input.
 - Create a synchronization relationship between your computer and your device.
5. Select the information type that you want to synchronize.

6. After you finish the wizard, ActiveSync automatically synchronizes your device. You can disconnect the device after the synchronization is complete.

NOTES:

- When connected, your device is automatically synchronized with your computer. ActiveSync synchronizes everytime you make a change on either the device or computer.
 - You cannot use WLAN to synchronize database.
 - Refer to your Windows® Mobile Help, for more information about ActiveSync synchronization.
 - Wireless connection may require separately purchased equipment (eg. Wireless router or Access Point).
-

Synchronizing via mini-USB

You can connect to your device using the bundled mini-USB cable to synchronize to your computer.

To synchronize your device via mini-USB:

1. After installing ActiveSync to your computer, connect the mini-USB plug to the mini-USB connector at the bottom of the device.
2. Connect the other end of the USB cable to your computer. Upon connection, ActiveSync automatically synchronizes your device.

Synchronizing via Bluetooth®

NOTE: Ensure that Bluetooth is turned on both on your device and your computer.



To synchronize your device via Bluetooth:

1. Configure the settings of ActiveSync and Bluetooth on your computer.

NOTE: Refer to the Microsoft® ActiveSync Help on your computer for details.

2. Connect your device with your computer using Bluetooth.

NOTE: Refer to the section **Using Bluetooth®** in this user guide for more details.

3. From the list of connected devices, tap the name of the computer you want to synchronize with.
4. Select **ActiveSync**, then tap **Save**.
5. Tap  to exit the Bluetooth settings.
6. From your device, tap  > **Programs > ActiveSync > Menu > Connect via Bluetooth**. The device starts to connect to your computer.
7. When connected, tap **Sync** to synchronize data.

NOTE: Media files, such as music and video files, can be synchronized only via a USB cable.

Synchronizing with an Exchange Server

To synchronize your device with Exchange Server:

1. From the ActiveSync menu, tap **Menu > Add Server Source**.
2. Enter your email address, then tap **Next**. If you prefer the device to detect the Exchange Server Settings automatically, tap the check box **Attempt to detect Exchange Server Settings automatically**.
3. In the **Server Address** field, enter the name of the server running Exchange Server then tap **Next**. If necessary, tap the check box **This server requires an encrypted (SSL) connection**.
4. Enter your name, password, and domain then tap **Next**.
5. Tap the check boxes to select the data items that you want to synchronize with Exchange Server. To change the available synchronization settings, select a data item then tap **Settings**. Tap **Finish** when done.
6. Start the sync process.

Setting the synchronization schedule

To set the synchronization with Exchange Server:

1. From the ActiveSync screen, tap **Menu > Schedule**.
2. Refer to the table for input details.

Volume	Recommended setup
High	Select a shorter interval in the Peak times list.
Low	Select As items arrive option or a longer interval in the Offpeak times list.
While roaming	Check Use above settings while roaming .
Sending messages	Check Send/Receive when I click Send .

Chapter 4

Phone features

- Using the phone
- Making a call
- Receiving a call
- Options during a call
- ASUS Call Filter



Using the phone

Like a standard mobile phone, you can use your device to make and receive calls. You can also keep a history of calls made and received, send SMS or MMS messages, take notes while talking, call from Contacts, and copy data from an installed SIM card to your device.

Phone pad

The phone pad allows you to easily dial and access the Contacts, Call History, Speed Dial, and Phone settings.



To launch the phone pad, do any of the following:

- Tap  > **Phone**.
- Press the Call key .

Smart dialer



The Smart dialer feature in your device enables you to find a contact more quickly. Just key in the first letters of the contact you want to call. Your device smartly matches it with your Contacts list and displays the possible matches.

To use Smart dialer:

1. On the phone pad, key in the first letters of the contact name.
2. From the list displayed, tap the contact you want to call.
3. Tap **Call** or press .
4. To end the call, tap  or press the End key .

Turning off phone function

To turn off phone function:

1. Tap the signal icon , or tap  > **Settings** > **Connections**.
2. Tap **Wireless Manager**.
3. Tap **Phone** to turn on/off the phone connection.

NOTE: You may still use other functions even when your device's phone function is turned off.

Adjusting the volume

To adjust the phone or device volume:

1. Tap  from the status bar.
2. From the volume menu, you can:
 - Move the slider to adjust device or phone volume.
 - Tap **On**, **Vibrate**, or **Off** to change the system and ringer volume settings.

NOTE: You can also press the volume controller keys at the left side of the device to adjust the volume.

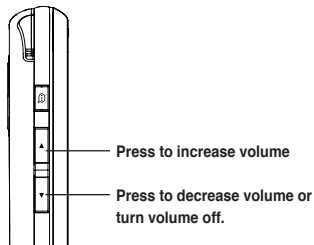







Making a call

You can make a phone call using the phone pad. You can also make calls directly from the Contacts, Call History, Speed Dial, or Voice Commander.

Using the phone pad

To make a call using the phone pad:

1. To launch the phone pad, do either of the following:
 - Tap  > **Phone**.
 - Press .
2. From the phone screen, tap the number or choose a contact or a recently dialed number from the list above the phone pad.
If you tapped the wrong number, tap the back arrow to erase number to the left.
3. Tap  or press  to make the call.
4. When finished, tap  or press  to end the call.

Phone pad features

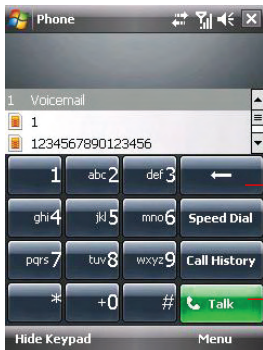

Back arrow

Talk button

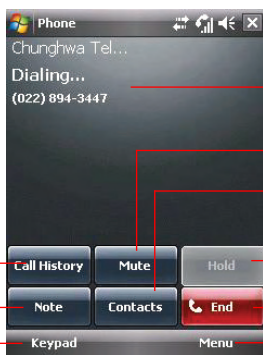

Displays the current call status

Tap to put an active call on mute mode

Tap to launch Contacts list

Tap to turn speaker ON/OFF

During an active call, tap to put call on hold

Tap to take notes





Tap to end call

Tap to launch keypad

Tap to launch Menu

Making calls from Contacts



To make a call directly from Contacts:

1. Press the Right Soft key or from the Today screen, tap **Contacts**.
2. You can do any of the following to make a call:
 - Tap name of contact, then from the Contacts screen, tap **Call**.
 - Tap name of contact, then press .
 - You can also tap and hold the contact, and from the shortcut menu tap **Call Work**, **Call Home**, or **Call Mobile**.
 - Tap **Enter a name...** then enter the name or number you want to call from Contacts. Press  to dial the highlighted item.
3. Tap  or press  to end the call.

Making calls from Call History

Your device saves your call logs such as your missed, incoming, or outgoing calls.

To make a call from call history:

1. To launch Call History, you may either:
 - Tap  > **Phone**, then tap  from the phone pad.
 - Tap **Asus Launcher**, then tap the Call History icon .

The Call History screen displays the following tabs:

- **All**: This is the default tab. It displays all calls made, received, or missed.
- **Missed**: Displays all missed calls.
- **Outgoing**: Displays all the calls you made.
- **Incoming**: Displays all the calls you received.

2. Scroll to the desired contact or phone number, then tap **Call** or press .



Tap **Menu** to do other tasks such as saving a caller's phone information to your Contacts list, send a text message to a caller, delete a call log, or filter call logs.

3. Tap  or press  to end the call.

Calling using the Speed Dial

The Speed Dial function enables you to quickly and conveniently call frequently-called numbers. You may assign speed dial entries from 2 to 99.



To create a Speed Dial entry:

1. Ensure that the entry you want to create is already in the Contacts list.
2. Tap  > **Phone**.
3. Tap  on the phone pad.
4. Tap **Menu** > **New**.
5. Tap to select a contact from the list.
6. In the **Location** box, select an available key then tap .

To delete a Speed Dial entry:

- In the Speed Dial list, tap and hold an entry then tap **Delete**.

To call a Speed Dial entry:

1. Tap  > **Phone**, then key in the assigned speed dial for the contact you want to call.
2. Tap  or press  to end the call.

Calling using the Voice Commander



To make a phone call using the Voice Commander:

1. Tap  > **Programs > Voice Commander.**
2. From the prompt screen, your device asks you to “Say command.”
3. Audibly say “Call” then the name to call from your Contact list.
4. Say “Yes” or “No” after the confirmation question.

If you said “Yes”, the application proceeds and dials the number. Otherwise, it returns to the Voice Commander menu.

5. Say “Goodbye” or tap  to exit the Voice Commander.

To assign a shortcut button for the Voice Commander:

1. Tap  > **Settings > Personal tab > Buttons.**
2. On **Select a button** field, select the button that you want to assign to the Voice Commander.
3. On **Assign program** field, select **Voice Commander** from the list.
4. Tap  when done.

NOTE: Depending on the button that you have selected, you may short-press or long-press the Record button at the left side of the device to launch the Voice Commander.

Making emergency calls

Calls to emergency service numbers can be made under any circumstances, even if you have locked the SIM card or your phone.

To place an emergency call:

Enter the emergency number appropriate for your location, and press .

Making international calls



To place an international call:

1. Press and hold **+** on the keypad to enter a (+) plus sign.
2. Enter the full phone number with the country code, area code, and phone number, and then press .

Receiving a call

When you receive a call, a message prompts and allows you to answer or reject the incoming call.

To answer or reject an incoming call:

- To answer a call tap **Answer**, or press .
- To reject an incoming call, tap **Ignore**, or press .

NOTE: Press and hold the Call key  to switch receiver to speakerphone mode.

To terminate a call:

- Tap  or press  to terminate an incoming or outgoing call.

Options during a call

Listed in the table below are the possible menu options when a call is in progress. Some of these options are available only when multiple calls are in progress.

IN-CALL MENU OPTION	DESCRIPTION
Hold	Places the active call on hold.
Unhold	Activates the call that is on hold. You can also press  to activate the call that is on hold.
Mute	Switches off the microphone for the active call (you can hear the caller but the caller cannot hear you).
Unmute	Turns the microphone for the active call back on.
Speakerphone On/Off	Activates/deactivates the speakerphone.
View Contact	Opens the Contacts list.
Save to Contacts	Save the caller to the Contacts list.
Create Note	Allows you to create a note during an active call.
Call History	Opens the Call History list.
Speed Dial	Opens the Speed Dial list.
Options	Opens the phone settings.

Managing multiple calls

To answer another call:

1. Tap **Hold** to place the first call on hold and answer the second call.
2. To end the second call and return to the first call, press .

To hold a call to make a second call:

- Tap **Menu > Hold** to place the first call on hold and call a second number. When you have finished the second call, press  to take you back to the first call.

To switch between calls:

- To switch between two calls, press **Swap**.

ASUS Call Filter

The ASUS Call Filter is a utility that allows you to control all your incoming calls. Using this utility, you can manage a list of telephone numbers from your Contacts list, call log, message log, or any unlisted telephone number that you want to accept or reject.

Launching the shortcut menu

The shortcut menu allows you to conveniently activate either the Accept or Reject list.

To launch the shortcut menu:

- Tap  from the ASUS Today screen.



From the shortcut menu, do any of the following:

- Tap **Accept List** to receive only incoming calls whose numbers are in the Accept list.
- Tap **Reject List** to reject all incoming calls whose numbers are in the Reject list.
- Tap **Edit** to open the Call Filter utility screen.
- Tap **Close** to deactivate Call Filter.

Managing the Accept list

The Accept list allows you to select telephone numbers you only want to accept. Incoming calls that are not included in the Accept list will automatically be rejected.

To add items in the Accept list:

1. From the ASUS Call Filter shortcut menu, select **Edit**.
2. Select **Accept List** from the Edit List box.
3. Select your source of data. You can get data from your Contacts, Call log, Message sender number, or you can add an unlisted number and key in new numbers.
4. From your data source, select an item then tap **Add** or  to add a new Accept list item.
5. Tap  to exit.

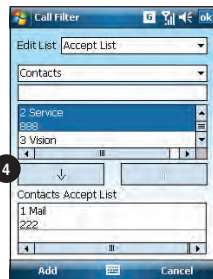
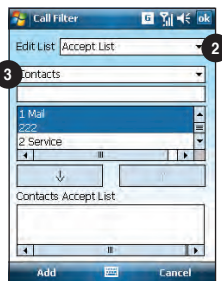

To remove items from the Accept list, select a contact from the Accept list then tap **Remove** or



Managing the Reject list

The Reject list allows you to select telephone numbers you want to reject. Incoming calls that are in the Reject list will be rejected.

To add items in the Reject list:

1. From the ASUS Call Filter shortcut menu, select **Edit**.
2. Select **Reject List** from the Edit List box.
3. Select source of data. You can get data from your Contacts, Call log, Message sender number, or you can add an unlisted number and key in new numbers.
4. From the list (e.g. Contacts), select an item then tap **Add** or  to add a new Reject list item.
5. Tap  to exit.

To remove items from the Reject list, select a contact from the Reject list then tap **Remove** or

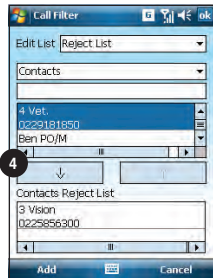
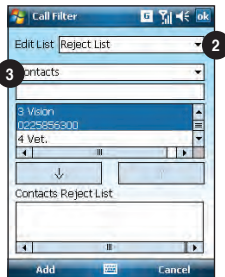

Chapter 5

Messaging

- E-mail messaging
- Threaded SMS
- MMS messaging
- Windows® Live

E-mail messaging

Setting up an e-mail account

Before you can send and receive e-mail messages, you need to set up an e-mail account that you have with an Internet Service Provider (ISP) or an account that you access using a VPN server connection (typically a work account). You can send e-mail messages by synchronizing or by connecting directly to an e-mail server through your Internet service provider or a corporate network.

NOTE: Before you set up an e-mail address on your device, you must have an Internet or an e-mail account.

To set up an e-mail account:

1. Tap  > **Messaging** > **Setup E-mail**.
2. Key in your **E-mail address** and **Password**, then tap **Next**.

NOTE: By default, your device automatically attempts to obtain your e-mail settings from the Internet, particularly for Internet e-mail accounts such as Yahoo or Hotmail accounts.





3. If you want to manually enter your e-mail settings, clear the **Try to get e-mail settings automatically from the Internet** checkbox. Otherwise, tap **Next**.

NOTE: Obtain the e-mail server information from your mobile service provider.

4. Key in **Your name** and **Account display name**, then tap **Next**.

5. From the dropdown list, select the time interval that you want to automatically send/receive e-mail messages. If you want to view more download settings, tap **Review all download settings**, and select your preferred download settings.
6. When done, tap **Finish**.

Managing e-mail accounts

TO	DO THIS
View a list of accounts	Tap  > Messaging . A list of accounts is displayed with the number of unread messages in the Inbox of each account shown in parenthesis.
Send/receive Internet e-mail messages	Tap  > Messaging . Select the Internet e-mail account for which you want to send and receive messages and tap Menu > Send/Receive . To stop this process, tap Menu > Stop Send/Receive .
Delete an account	Tap  > Messaging . Select an account and tap Menu > Delete .
Switch between accounts	With an account open, tap Menu > Go To , then tap the account you want to switch to.
Changing account options	Tap  > Messaging . Select an e-mail account and tap Select . Tap Menu > Tools > Options and then select the type of option you want to change. Select Done to confirm.

Sending an e-mail message

To send an e-mail message:

1. Tap  > **Messaging**.
2. Tap an e-mail account.
3. Tap **Menu** > **New** .
4. In **To:** field, enter the mobile phone number or e-mail address of the person to which you want to send the message or tap **Menu** > **Add Recipient** to select from your Contacts list.

NOTE: If you are sending a message to more than one recipient, separate them with a semicolon (;). You can only send text messages to contacts with a mobile phone number.

5. Key in your message in the message text field.
6. When finished, tap **Send** .

NOTE: If you are working offline, e-mail messages are saved to the Outbox folder and sent the next time you connect.

TO	DO THIS
Insert a picture into an e-mail message	While composing your message, tap Menu > Insert > Picture .
Insert a voice recording into an e-mail message	While composing your message, tap Menu > Insert > Voice Note .
Set the priority, security, and language of an e-mail message	While composing your message, tap Menu > Message Options .
Cancel a message	While composing your message, tap Menu > Cancel Message .
Save a message	While composing your message, tap Menu > Save to Drafts .
Delete a message	With the message you want to delete selected, tap Delete .
Move a message to another folder	With the message you want to move selected, tap Menu > Move . Scroll to the new folder and press Select .
Sort messages	On any account screen, tap Menu > Tools > Sort By , and select your desired sorting method.
Insert a signature	On any account screen, tap Menu > Tools > Options > Signatures .
Change message options	On any account screen, press Menu > Tools > Options .

Downloading e-mail messages

Use Messaging to send and receive e-mail messages in one of two ways:

- Synchronize e-mail messages with Microsoft Exchange or Microsoft Outlook on your computer.
- Send and receive e-mail messages by connecting directly to an e-mail server through an Internet Service Provider (ISP) or a network.

Synchronizing e-mail messages



You can include e-mail messages as part of the general synchronization process. On Windows® XP platform, you need to enable mail synchronization in Microsoft® ActiveSync. For more information on enabling mail synchronization, see the ActiveSync online help on your computer. On Windows® Vista platform, you can synchronize your e-mail messages via the Windows® Mobile Device Center.

NOTES:

- For synchronizing on Windows Vista™ platform, refer to the Windows® Mobile Device Center's website at <http://www.microsoft.com/windowsmobile/devicecenter.mspx>
 - To connect directly to an e-mail server, see **Synchronizing with an Exchange Server** in this user guide.
-

Managing folders

Each e-mail account has a set of five folders: **Deleted Items**, **Drafts**, **Inbox**, **Outbox**, and **Sent Items**. These folders store messages that you send and receive through the account. You can move a message to a different folder within the same account.

TO	DO THIS
View message folder contents	Tap  > Messaging . Select the account that you want to view. Tap Menu > Go To > Folders and select the folder that you want to view.
Moving a message to a different folder	Tap  > Messaging . Select the account with the message that you want to move. Scroll to the message you want to move and tap Menu > Move . Select the folder into which to move the message.

Threaded SMS

Your device organizes your SMS messages from a single contact or number into a single thread of conversation, making it easier for you to follow the messaging flow and send the appropriate responses.

Sending a threaded SMS

To send a threaded SMS message:

1. Tap  > **Messaging** > **Text Messages** > **Menu** > **New**
2. Key in your recipient's phone number or tap **To:** to select a recipient from the Contacts list. Separate multiple recipients with a semicolon (;).
3. Key in your message.
4. When finished, tap **Send** to send out the message.

NOTE: Once your recipient replies to your message, your device displays the message thread, making it easier for you to follow the mobile conversation with your recipient.

MMS messaging

Multimedia Messaging System (MMS) allows you to send text messages with multiple slides. Each slide may include a picture, video or audio, or text. MMS messages are sent by General Packet Radio Service (GPRS) to e-mail accounts or other MMS-enabled mobile devices.

NOTES:

- You need to subscribe to the GPRS and MMS services with your service provider before you can send and receive MMS messages. Ask your mobile service provider on how to activate the MMS feature. Only mobile phones with MMS feature can send/receive MMS messages.
 - Depending on the service that you subscribe to, you may not be able to send and receive MMS messages to users using a different mobile phone network.
-

Accessing MMS

To access MMS:

- Tap  > **Messaging** > **MMS**.
- After capturing a picture or video clip, tap **Menu** > **Send**.

Editing MMS settings

1. From the MMS main screen, tap **Menu** > **Tools** > **Options**.
2. From the list of accounts, tap **MMS**.
3. On the **MMSC Settings** tab, select your Internet Service Provider from the list. Tap **Edit** to access Multimedia Messaging Service Center (MMSC) settings.

NOTE: Contact your mobile service provider for detailed settings.

Sending an MMS message

To send an MMS message:

1. Tap  > **Messaging** > **MMS** > **Menu** > **New**.
2. In the **To:** field, key in the mobile phone number or e-mail of your recipient. You can enter it using the phone pad or tap **Menu** > **Add Recipient** to select from your Contacts. If you have more than one recipient, separate them with a semicolon (;).
3. In the **Subject** field, enter the subject for the message.
4. Tap the **Insert Picture/Video** field.
5. Tap to select a picture or video clip displayed in thumbnail view.
6. Tap the **Insert Audio** field.
7. Tap to select the audio clip you want to attach, then tap **Select**.

NOTE: You will not be able to attach an audio file to a slide with a video clip.

8. Tap the **Insert Text** field and enter your message.
9. Tap **Send** to send the message.

The following assumes that you are on the MMS message screen.

TO	DO THIS
Copy the message to other recipients	Using the stylus, move the scroll bar to display the Cc field. Enter the recipient's phone number or e-mail address or tap Menu > Add Recipient to select a recipient from your Contacts list.
Hide a recipient's contact information from other message recipients	Using the stylus, move the scroll bar to display the Bcc field. Enter the recipient's phone number or e-mail address or tap Menu > Add Recipient to select a recipient from your Contacts list.
Hide sender information	Tap Menu > Options > Send Options . Select the Hide Sender check box.
Create an MMS message from a template	Tap Menu > Template > New from Template to compose a message using a predefined template.
Create an MMS message template	Create a message or open an existing message, and tap Menu > Template > Save as Template .
Add preset or frequently used text strings to a message	In the text field, tap Menu > My Text . Select the text string that you want to add.
Edit a preset message	Tap Menu > My Text to open the text string you want to edit.
Request message delivery notification	Tap Menu > Options > Send Options . Select the Delivery Report check box.

Windows® Live

Windows® Live provides a set of services including e-mail, messaging, and search that brings all your online necessities together. With Windows® Live, you can conveniently do the following on your device:

- Access your Hotmail, MSN, or Microsoft Exchange account and send or receive e-mail messages.
- Start a chat with your friends who are online.
- Search the web using the Windows® Live search engine.

To use Windows® Live, you must have a Passport account. If you have a Hotmail® or an MSN® account, you already have a Passport. Once you have obtained either a Microsoft® Passport or Microsoft® Exchange Server account, you are ready to set up your account.

NOTE: You need a Microsoft® Passport account to use Windows Live® application. If you do not have a passport account, go to www.passport.com to obtain one.

Using Hotmail®

To sign in Hotmail®:

1. Tap  > **Programs > Windows Live.**
2. On the Windows Live - Sign In screen, tap **Sign in to Windows Live** to enter Windows Live Setup session.
3. Tap **Accept**, then enter the e-mail address and password for your Hotmail® account.
4. Select **Save password** and tap **Next**.
5. Tap the check boxes to show or hide Windows® Live items on the Today screen, then tap **Next**.
6. Select the items you want to synchronize on your device, then tap **Next**. Wait for a few minutes for the synchronization process to finish.

The next time you sign in to Windows® Live, your username and password is displayed.

Using Windows® Live Messenger

To sign in and out of Windows® Live Messenger:

1. Set e-mail address and password in Windows® Live.
2. When you have set up your account, tap  > **Programs** > **Messenger**.
3. On the Windows® Live Messenger main screen, tap **Sign In**.
4. To sign out, tap **Menu** > **Sign out**.

NOTE: If you do not sign out of the Windows® Live Messenger application, you will remain connected. This may result in additional charges from your service provider.

Chapter 6

Organizing your life

- Using Contacts
- Using Calendar
- Using Tasks

Using Contacts

Contacts contains your list of contact information such as mobile or work numbers and e-mail addresses. Using Bluetooth® on the device, you can quickly share Contacts information with other device users. If you use Outlook on your computer, you can synchronize Contacts between your device and computer.



Viewing Contacts

To view the Contacts list, do one of the following:

- On the Today screen, tap **Contacts**.
- Tap  > **Contacts**.
- On the Today screen, press the right soft key.

The contact list displays the names of your contacts alphabetically. Beside each name in the contact list is an abbreviation for the default communication method, such as the person's work phone number (w) or home phone number (h). Your device automatically sets a contact's mobile number as the contact's default number.

If there are phone numbers stored in your SIM card, the entries will be displayed at the end of the list, with a SIM card icon following the name.



TO	DO THIS
Create a new contact	Tap Contacts > New > Outlook Contact . Enter information for the new contact and tap  .
Create a new contact on the SIM card	Tap Contacts > New > SIM Contact . Enter information for the new contact and tap  NOTE: You can only store one phone number for a SIM contact.
Edit a contact's information	Tap Contacts . Select the contact whose information you want to edit, and tap Menu > Edit . When you have finished making the changes, tap  .
Call a contact from the contact list	Tap Contacts . Tap the contact to call and tap Call . To call a phone number other than the default, select the contact, use the stylus to scroll to the number you want to call, and tap Call .

TO	DO THIS
Send a text message to a contact	Tap Contacts . Tap the contact to which you want to send a text message, and tap Send Text Message .
Send an MMS message to a contact	Tap Contacts . Select the contact to which you want to send an MMS message and tap Menu > Send MMS .
Beam a contact's information to another device	Tap Contacts . Select the contact to beam and press Menu > Send Contact > Beam . Select the device and press Beam .
Find a contact by name	Tap Contacts . If you are not in Name view, tap Menu > View By > Name . Enter the first few letters of the contact's name until the contact is displayed.
Find a contact by company	Tap Contacts . Tap Menu > View By > Company . Tap the company to view all the contacts listed under it.
Find a contact using filter	From the Contacts list, tap Menu > Filter . Select the filter category. To show all contacts again, select All Contacts .
Assign a ring tone to a contact	Tap Contacts . Tap the contact to which you want to assign a custom ring tone to. Tap Menu > Edit and scroll to Ring tone . Select a ring tone and tap ok . NOTE: You can only assign a ring tone to contacts who are in your Outlook Contact list.
Add a picture to a contact	Tap Contacts . Tap the contact to which you want to add a picture to. Tap Menu > Edit and scroll to Picture . In the Picture field, tap Select a picture and choose the picture to use. NOTE: You can only add a picture to contacts who are in your Outlook Contact list.
Copy a contact to your SIM card	Tap Contacts . From the list, tap the contact, then tap Menu > Copy to SIM . Select the contact you want to copy, then tap Copy . Tap ok when done.

Using Calendar



Use Calendar to schedule appointments, including meetings and other events. Your appointments for the day can be displayed on the Today screen. You can also set Calendar to remind you of your appointments. If you use Outlook on your computer, you can synchronize appointments between your phone and computer.

To open the Calendar program, do one of the following:

- Tap  > **Calendar**.
- On the ASUS Today screen, tap .

Scheduling an appointment

To schedule an appointment:

1. Tap  > **Calendar**.
2. Tap **Menu > New Appointment**.
3. Enter information about the appointment.
To schedule an all-day event, in **All Day**, select **Yes**.
4. Tap .

TO	DO THIS
Make a recurring appointment	Select the appointment and tap Menu > Edit . Scroll to Occurs and select one of the recurrence options.
Delete an appointment	Select the appointment to delete and tap Menu > Delete Appointment .
Beam an appointment	Select the appointment to beam and tap Menu > Beam Appointment .

Viewing an appointment

To view an appointment:

1. Tap  > **Calendar**.
2. Tap the appointment to view.

Viewing your schedule

To view your schedule:

1. Tap  > **Calendar**.
2. Tap **Menu** and then select one of these views:
 - **Agenda**
 - **Day**
 - **Week**
 - **Month**
 - **Year**

TO	DO THIS
View today's agenda	From any Calendar view, tap Menu > Go to Today .
View your agenda for a specific date	From any Calendar view, tap Menu > Go to Date . Tap the date to view.
Show week numbers	From any Calendar view, tap Menu > Tools > Options . Select Show week numbers checkbox.
Change the display of the work week	In any Calendar view, tap Menu > Tools > Options and do the following: <ul style="list-style-type: none">• To specify the first day of the week, in 1st day of week, select Sunday or Monday.• To specify the number of days you want to appear in a week, in Week view, select 5-day week, 6-day week, or 7-day week.





Using Tasks

Use Tasks to keep track of what you have to do.

The Tasks list

The task list is your “things to do” list. When you create or edit tasks with Outlook on your computer and then synchronize it with your device, additional information, such as due date, priority, and category, may show. A task that has been marked as high priority is preceded by an exclamation mark, and a low priority task is marked by a downward-pointing arrow. Overdue tasks are displayed in bold red.

NOTE: You can synchronize information on your phone with your computer to keep your task list up to date in both locations.

TO	DO THIS
Create a task	Tap  > Programs > Tasks . Enter the task name in the Tap here to add a new task field.
Mark a task as completed	Tap  > Programs > Tasks . Select the task to mark as completed, then tap Complete .
Delete a task	Tap  > Programs > Tasks . Select the task to delete, then tap Menu > Delete Task . Tap Yes to confirm.
Change a completed task to incomplete	Tap  > Programs > Tasks . Select the completed task, then tap Activate to change the status to incomplete.
Find a task	Tap  > Programs > Tasks . Tap Menu > Sort by and select a sort option. You may also tap Menu > Filter and select a category.

Chapter 7



Customizing your device

- Customizing the Start menu
- Using the Profile Manager
- Using the Theme Manager
- Customizing the Today screen
- Entering your contact information
- Setting up sounds and notifications
- Setting the date, time, and alarm
- Setting the ring tone
- Wake up settings

Customizing the Start menu

You can choose up to seven programs to appear in the Start  menu.

To customize the Start menu:

1. Tap  > **Settings** > **Personal** tab > **Menus**.
2. Select up to seven programs that you want on the Start menu.
3. Tap .



Using the Profile Manager

Profile Manager provides you with a convenient way to customize the ring tone and notification settings of your device to suit different scenarios.



There are four profile modes that you can choose from:

- **Normal:** This mode allows you to customize the ring tone for incoming calls, messages, and alert notifications.
- **Meeting:** In this mode, the volume is turned off and your phone vibrates to alert you about an incoming call.
- **Silent:** This mode puts both the volume and ring tone of your device on mute mode.
- **Automatic:** When set to this mode, your device's sound and alert settings are automatically switched from Normal to Meeting mode based on your Calendar.



To change to Normal mode:

1. Tap  > **Settings** > **Personal** tab > **Profile Manager**.
2. Select **Normal**, then select one of these options from the dropdown list: **Default**, **Outdoor**, and **Personal**. If you want to change the settings of an option, tap **Edit**.
3. Tap **Tone**, **Volume**, or **Name** tabs and make the necessary changes.
4. When done, tap .

To change to Meeting mode:

1. Tap  > **Settings** > **Personal** tab > **Profile Manager**.
2. Select **Meeting**.
3. If you want to change the settings, tap **Edit**.
4. Tap the slider to adjust the speech volume setting.
5. When done, tap .

To change to Silent mode:

1. Tap  > **Settings** > **Personal** tab > **Profile Manager**.
2. Select **Silent**.
3. If you want to change the settings, tap **Edit**.
4. Tap the slider to adjust the speech volume setting.
5. When done, tap .

To change to Automatic mode:

1. Tap  > **Settings** > **Personal** tab > **Profile Manager**.
2. Select **Automatic**.



NOTE:: If the system detects that you are currently busy based on your Calendar, the sound and alert settings in your device automatically switch from Normal to Meeting mode.

3. Tap .



Using the Theme Manager

Theme Manager allows you to change the appearance of your device such as the background, items shown on the Today screen, and the skin of the Windows® Media Player.

To customize the theme:



1. Tap  > **Settings** > **Personal** tab > **Theme Manager**.
2. On the **Theme** tab, select any of the themes.
3. On the **Schedule** tab, you may set the theme to automatically change on workdays and weekends.
To do this:
 - Select **Enable Theme Switcher**, and select the themes for **Workday Theme** and **Weekend Theme**.
4. Tap .

To edit the theme:



1. Tap  > **Settings** > **Personal** tab > **Theme Manager**.
2. On the **Theme** tab, select the theme you want to edit.
3. Tap **Menu** > **Edit**. Select the items that you want to edit from these four tabs:
 - On the **Today** tab, select the appearance for the Today screen from the dropdown list. To change the theme from 6:00 p.m. to 6:00 a.m., enable **Night Theme**. You may also select **Wallpaper** to add a wallpaper to the Today screen.
 - On the **Items** tab, select the items that you want to display on the Today screen.
 - On the **Skin** tab, select the skins for the dialer and Windows® Media Player.
 - On the **Name** tab, enter the name for the theme.
4. Tap  when finished.

Customizing the Today screen

To customize your Today screen:

1. Tap  > **Settings** > **Today**.
2. On the **Appearance** tab, select the background for the Today screen.
If you want to use a picture as your Today background, select **Use this picture as the background** and tap **Browse** to locate the picture you want to use.
3. On the **Item** tab, select the items you want displayed on the Today screen.
4. When done, tap .

To customize the Today screen with your own image:

1. Tap  > **Programs** > **Pictures & Videos**.
2. Tap the image to use as the background image
3. Tap **Menu** > **Set as Today Background**.
4. Adjust the transparency level and tap .



Entering your contact information

The Owner Information feature allows you to enter and display your personal contact information, such as your name, alternative contact numbers, and e-mail address, on your device.

NOTE: We recommend that you enter your contact information so you can easily be contacted in case of loss.

To enter owner information:



1. To launch the Owner Information screen, do either of the following:
 - On the Today screen, tap the **Tap here to enter owner information** field.

- Tap  > **Settings** > **Owner Information**.
2. Enter your details and tap .

Setting up sounds and notifications



Use the Sound and Notifications settings to enable sounds and to customize the ring tones for incoming calls, reminders, alerts, and messages.

To set sounds and notifications:



1. Tap  > **Settings** > **Sounds & Notifications**.
2. On the **Notifications** tab, select an event, and set the **Ring type** and **Ring tone**.
3. Tap .

Setting the date, time, and alarm

To set the date and time:

1. Tap  > **Settings** > **System** tab > **Clock & Alarms**.
2. On the **Time** tab, enter the time zone, date, and time settings.
3. Tap .

To set the alarm:

1. Tap  > **Settings** > **System** tab > **Clock & Alarms**.
2. On the Alarm tab, enter the necessary alarm settings.
3. Tap .

NOTE: You can also configure the date/time settings directly from the ASUS Today screen. Tap  and enter the necessary settings.





Download from [Www.Somanuals.com](http://www.Somanuals.com). All Manuals Search And Download.

Setting the ring tone

With your device you can add and configure your favorite music as your phone ring tone. You can easily configure your favorite song or sound as your ring tone with the following compatible audio formats: aac, amr, .mp3, .wav, .wma, and .mid.





Adding ring tone to selection

To add a ring tone to the selection category under phone setting:

1. Tap  > **Settings** > **Ring tones**.
2. Select a specific file extension from the list box.
3. Tap to check a ring tone file that you want to add.
Tap  to play ring tone sound and tap  to stop.
4. Tap  when finished.

Changing the ring tone

To change the ring tone:

1. Tap  > **Settings** > **Phone**.
2. On the **Phone** tab, select a ring tone from the **Ring tone** list box. The songs or sounds that you added as ring tone appears on this list along with the default ring tones that came with the device.
Tap  to play ring tone sound and tap  to stop.
3. Tap  when finished.

Wake up settings

You can set the wake-up actions whenever your device is in sleep mode.

To set the wake-up action:

1. Tap  > **Settings** > **Personal** tab > **Wakeup Source**.

2. Select from the available wake-up actions.

Tap **Select All** to select all actions or tap **Select None** to deselect all available actions.

3. Tap  when finished.

Chapter 8



Getting connected

- Using the Wireless Manager
- Using Bluetooth®
- Using Wi-Fi
- Setting a GPRS connection
- Setting the preferred network

Using the Wireless Manager

The Wireless Manager allows you to enable or disable your wireless connections in a single location. This is a quick way to preserve battery power or to turn off the functions in your device such as phone or Bluetooth function.

To use the Wireless Manager:

1. Tap  > **Settings** > **Connections** tab.
2. Tap **Wireless Manager**.
3. From the Wireless Manager screen, do any of the following:
 - Tap the button for a desired wireless connection type to turn it on or off.
 - Tap  to turn off all wireless connections.
 - Tap **Settings** to change settings for one of the displayed wireless connection types.
4. Tap **Exit** or  to exit Wireless Manager.

Using Bluetooth®

Bluetooth® is a short range wireless communications technology that allows devices with Bluetooth capabilities to exchange data within a radius of about 10 meters (30 feet) without requiring a physical connection. With Bluetooth enabled in your device, you can:

- Connect and communicate, such as beam files, tasks, contacts, with other devices with Bluetooth features.
- Use Bluetooth service. After you connect to another device or computer using Bluetooth, you can use the services available on that device.

NOTE: Bluetooth and Wi-Fi share the same frequency band depending on the environment and wireless equipments being connected. Hence, performance may vary if both the device's Bluetooth and Wi-Fi features are used simultaneously.

Activating Bluetooth in your device

Use the Wireless Manager to enable or disable Bluetooth in your device. You can access the Wireless Manager by performing any of the following:



1. Launch the Wireless Manager. To do this, you can either:
 - Tap **Start > Settings > Connections** tab > **Wireless Manager**.
 - Tap the Wireless Manager icon from the Today screen.
2. From the Wireless Manager screen, tap **Bluetooth**.

NOTE: When not in use, deactivate Bluetooth in your device to conserve battery power.

Adding Bluetooth devices

1. Ensure that Bluetooth is enabled on the device you want to add and the device is set as Discoverable.
2. Tap  > **Settings** > **Connections** tab > **Bluetooth**.
3. Tap **Add new device...** to search for available Bluetooth devices. The search may take a while.
4. Select the device you want to connect with then tap **Next** or press the Right Soft key.
5. Enter the alphanumeric passcode of the device you want to connect then tap **Next** or press the Right Soft key. You can find the passcode in the documentation that came with the other device.
6. Enter the display name for this connection.
7. Repeat steps 3 - 6 to connect more devices.

Pairing with a Bluetooth headset

1. Tap  > **Settings** > **Connections** > **Wireless Manager**.
2. Tap **Bluetooth** to activate the Bluetooth connection.
3. Turn on your Bluetooth headset and bring it to within five to ten meters of your device.
4. Put your Bluetooth headset into pairing mode. Refer to your Bluetooth headset's user manual for instructions.
5. On your device, tap  > **Settings** > **Bluetooth**, then tap **Add new device....** Your device searches for Bluetooth-enabled devices within its reach.
6. Select your Bluetooth headset on the Add Devices list and press **Next**.
7. Enter the passkey provided in the headset user manual. Your device will now pair with the headset.
8. The Bluetooth icon  appears on the status bar indicating that you can now talk handsfree.

NOTE: To ensure a better signal reception, DO NOT shield the keypad or battery compartment cover with your hand while talking handsfree on your device using a Bluetooth headset.

Using Wi-Fi

The Wi-Fi icon on the Today screen gives you easy access to the Wi-Fi feature on your device. Tapping the icon displays a menu that allows you to: **Turn Wi-Fi on/off** and open **Wi-Fi Manager**.



Turning on Wi-Fi

To turn on Wi-Fi:

1. From the Today screen, tap  > **Turn on Wi-Fi**.
The Device then automatically scans for all available wireless networks within the Wi-Fi range.
2. From the list of detected wireless networks, select a wireless network that you want to connect the device to.
3. Select whether the wireless network connects to **The Internet** or **Work** network.
4. Tap **Connect**.

Configuring wireless networks

To configure a wireless network:

1. To launch the Wi-Fi settings page, do either of the following:
 - Tap **Settings** after selecting a wireless network to connect your device to.
 - Tap  > **Settings** > **Connections** tab > **Wi-Fi**.
2. From the Configure Wireless Networks screen, tap an available wireless network, then make the necessary changes.
If the wireless network you want is not on the list, tap **Add New...**
3. Tap the **Network Adapters** tab and select an adapter. Tap an adapter to set it if necessary.
4. Tap  when done.

Adding a wireless network

If the device fails to automatically detect the wireless network you want to connect to, you can manually add the network. Ask for the wireless network settings from your network administrator.

To add a wireless network:

1. To launch the Wi-Fi settings page, do either of the following:
 - Tap **Settings** after selecting a wireless network to connect your device to.
 - Tap  > **Settings** > **Connections** tab > **Wi-Fi**.
2. Tap **Wireless** > **Add New...**
3. Enter a name for the network and select an item from the **Connects to:** dropdown menu, then tap **Next**.

NOTE: You can get the authentication, data encryption, and network key from your network administrator.

4. Set authentication, data encryption, and network key, then tap **Next**.
5. If you need to change the EAP type, check the adapter box, then change the EAP type.
6. Tap **Finish** when done.

Using Wi-Fi Manager

The Wi-Fi Manager shows the connection status and information on a wireless network, and allows you to manually scan your area for available wireless networks.

To open the Wi-Fi Manager, you can do any of the following:

- Tap  > **Wi-Fi Manager**.
- Tap **Start** > **Settings** > **Connections** tab > **Wi-Fi Manager**.

There are four tabs in the Wi-Fi Manager:

- **Wi-Fi Status:** This page shows the current connection status and link information.
- **Setting:** This page allows you to define settings for establishing a device-to-device wireless connection as well as power saving settings.

NOTE: We recommend to set the Power Save to Enable.

- **IP Info:** This page shows the network information and provides a way to get the new IP address from the DHCP server.
The **Renew** button enables you to request the DHCP server for a new IP address. This function would take several seconds to get the new IP address.
This **Ping** button serves as the network's diagnostic tool. It enables you to detect if your device is connected to the network.
- **Site Survey:** This page shows the nearest available wireless network.
Each wireless network is preceded by an icon for easy identification. The network channel, RSSI, and BSSID are also displayed in columns.

Setting a GPRS connection

Your device allows you to connect via General Packet Radio Service (GPRS). GPRS is a wireless communication standard that runs at speeds of up to 115 kbps, compared to 9.6 kbps of the current Global System for Mobile Communications (GSM). It supports a wide range of bandwidths that allows sending and receiving small bursts of data, such as e-mail messages and web browsing.

To set a GPRS connection in your device:



1. From the Today screen, tap **G** on the status bar.
2. Tap **Settings** on the message prompt.
3. From the Settings screen, select the Connections tab then tap **Connections** icon.
4. From the Connections screen, tap **Add a new modem connection**.
5. Enter a unique name for the connection then select **Cellular Line (GPRS)** from the modem list.
6. Enter the Access point name.
7. Enter your user name, password, and domain then tap **Finish**. Contact your network administrator for assistance.

NOTES:

- The network connection may vary with different locations and mobile service providers. Consult your mobile service provider for the applicable network connection in your area.
 - The charge of GPRS services and the GPRS connection settings might vary with different operators. Consult your service provider for suitable solution.
 - The GPRS and USB connections cannot be used at the same time.
-

Connecting GPRS

To connect GPRS:

1. Tap  > **Settings** > **Connections** tab > **Connections**.
2. From the Connections screen, tap **Manage existing connections**.
3. Tap and hold on an existing connection then from the popup menu tap **Connect**.
Tap **Delete** if you want to delete the selected connection setting.
4. When connected, tap  to exit.

NOTES:

- When WLAN is used simultaneously with the GPRS, the latter will get signal priority.
 - We recommend not to use WLAN and GPRS at the same time.
-

Browsing the Internet

If you have set a default GPRS connection, it automatically connects when you launch an application that connects to the Internet.

To browse the Internet:

1. Launch any application that connects to the Internet such as Internet Explorer.
The device will automatically connect your default GPRS connection. A popup callout appears to display the connection status.
2. When connected, you can start browsing the Internet. If you are using Internet Explorer, the default site will be displayed.

Disconnecting GPRS

To disconnect GPRS:

1. Tap  from the status bar.
2. From the popup callout, tap **Disconnect**.



NOTES:

- If your ActiveSync is set to sync with Exchange Server automatically, synchronization will occur after you connect again.
 - GPRS will automatically reconnect everytime you launch an application that requires GPRS connection such as Internet Explorer and Windows® Live.
-

Using the GPRS Tool

The GPRS Tool allows you to conveniently select and connect to your GPRS service provider.

To connect via GPRS Tool:

1. Tap  > **Settings** > **Connections** tab > **Network Setting**.
You can also tap  on the status bar then tap **Settings** from the popup callout.
2. From the Network Setting screen, select your GPRS provider from the list.

NOTES:



- Operators vary in different regions.
 - The GPRS and USB connections cannot be used at the same time.
-

Setting the network

Your device enables you to configure your device's network connection as well as set multiple networks in the order that you want to access them.

Configuring the network

To configure the network settings:

1. Tap  > **Settings** > **Connections** tab > **Network Setting**.
2. Select the **Country** and **Operator** from the dropdown lists. If your mobile service operator is not on the list, tap the **Auto Detect** button.
3. When done, tap .

Setting your preferred network

To set your preferred network:

1. From the phone pad, tap **Menu** > **Options** > **Network** tab.
2. Tap **Set Networks** and follow the onscreen instructions.
3. When you have set your preferred networks, tap  to return to the **Network** tab. In the **Network selection** list, tap **Automatic**.

Chapter 9

GPS features

- **GPS Catcher**
- **External GPS**

GPS Catcher

GPS Catcher allows you to update the Global Positioning System (GPS) data in your device. The GPS data contains important information about the status of satellite, and the current date and time for determining the satellite position.

NOTE: All functions about GPS or similar are not intended to be used for location of persons, especially for “life-safety” and “non-life-safety” applications.

Updating GPS data

To update GPS data:

1. Tap **Start > Programs > GPS Catcher**.
2. Tap **Update** to start update.
3. Tap  when finished.

NOTES:

- To make a successful update, ensure your device is connected to the Internet.
 - GPS data expires in three days. You need to update it again when it expires. You can also set GPS Catcher to update automatically.
-

Setting GPS Catcher

To set GPS Catcher:

1. From the GPS Catcher screen, tap **Menu > Setting**.
2. Set the options according to your preference.
3. Tap  when finished.

External GPS

Your device allows you to use an external GPS device to receive GPS data. To use an external device, you need to set the connection between your device and your external GPS device.

NOTE: An MMCX compatible external GPS antenna connector is included in the package. Insert this connector to an external GPS antenna.

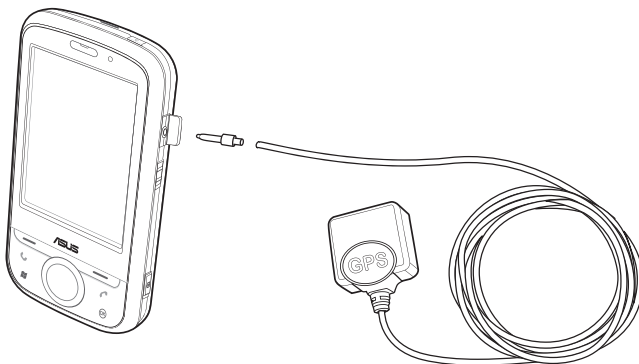

Setting an external GPS device

To set an external GPS device:

1. Tap  > **Settings** > **System** tab > **External GPS**.
2. From the **Programs** tab, select a program port.

NOTE: Other GPS applications in your device will use the same COM Port as you set here. Ensure that this port is also available in the other GPS applications.

3. From the **Hardware** tab, specify a hardware port and baud rate for your external GPS device to use.

NOTE: Refer to the user guide of your external GPS device for details.

4. From the **Access** tab, select the **Manage GPS automatically (recommended)** box.

IMPORTANT: If you clear this check box, some GPS related application in your device may not be able to obtain GPS data.

Chapter 10

Multimedia features

- Using the camera
- Viewing pictures and videos
- Streaming Player

Using the camera

The built-in 2.0 megapixel camera allows you to take photos and record audio/video clips.

Launching the camera

To launch the camera:

- Tap  > Programs > Pictures & Videos > Camera.
- Press and hold the Camera key on the right side of your device.

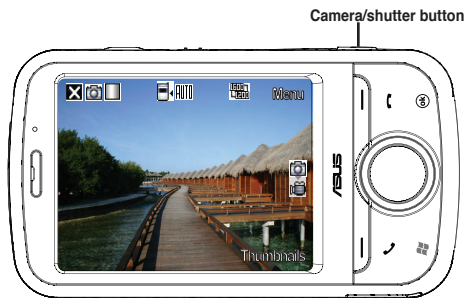

NOTES:

- By default, the preview screen is set to landscape.
 - After launching the camera, your device is set to camera mode by default.
 - In camera mode, the camera button functions as the shutter button.
-

To exit the Camera:

- Tap the exit  icon on the camera screen.

Available capture modes

Your device camera can be set to two capture modes:

- **Camera mode** Camera mode allows you to take photos, and save them to your device or microSD. You can also configure the camera to match an environment, set picture size, select magnification, adjust the picture quality, apply effects, and modify other advanced settings.
- **Video mode** Video mode enables you to record audio/video clips. Like in camera mode, it also allows you to select the magnification, set the video size, apply some effects, select target storage, and modify advanced video settings.

Supported formats

Using the camera mode or video mode, the images or video clip captured are stored in the following formats:

- **Still image (Camera mode):** JPEG (.jpg)
- **Video (Video mode):** 3GP (.3gp), MPEG4 (.mp4)





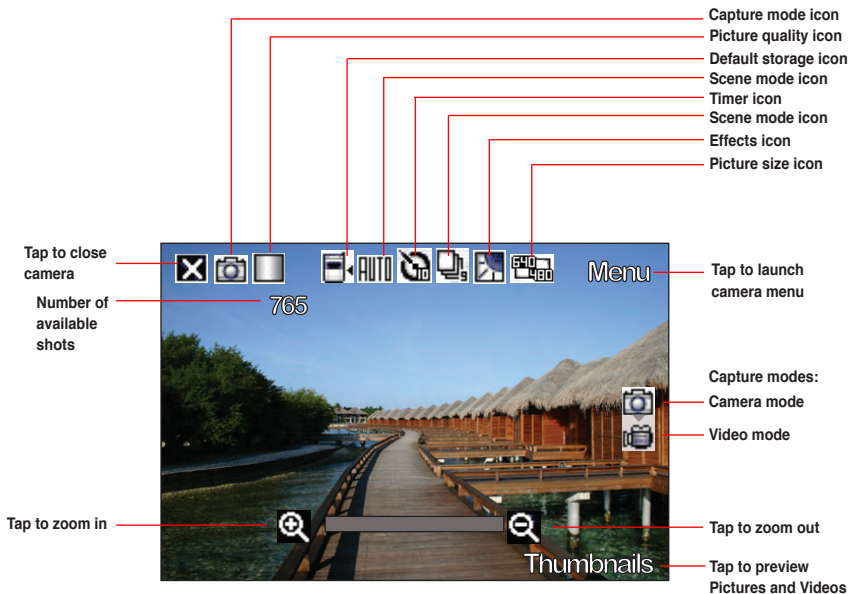



Camera mode





The following describes the screen icons in Camera mode:



Camera mode icons

Refer to the table below for the camera mode icons.

Icon		Description
Capture mode		Indicates the current capture mode.
Picture quality		Indicates the picture quality used.
Default storage		Indicates default storage for captured images and videos clips.
Scene mode		Indicates the scene mode used.
Timer		When the camera timer is enabled (5 seconds or 10 seconds), the corresponding timer icon appears. When you press the shutter button or the navigation button to take a picture, the count down begins and picture is taken after the time set.
Burst mode		Indicates the number of frames in burst mode.
Effects		Indicates the effects used.
Picture Size		Shows the resolution used. When set to 1600x1200 resolution, the zoom in/zoom out function is disabled.
Exit		Tap to exit camera.

Icon		Description
Zoom In		Tap to zoom in view of subject on screen.
Zoom Out		Tap to zoom out view of subject on screen.
Thumbnails		Tap to launch Pictures and Video application and preview your images in thumbnails.
Menu		Tap to launch camera menu options.

Camera options menu

The camera options menu allows you to change various camera and picture settings.

To launch options menu:

1. Tap **Menu** from the camera screen.
2. From the shortcut menu, tap an icon to display contents.

Change Mode

The Change Mode option allows you to set capture mode into Camera or Video mode.

Scene

The Scene option allows you to select presets appropriate for a night scene or sports event. Select **Auto** to use best setting for any scene.

Picture Size

Allows you to set the frame size of picture.

Picture Quality

This option provides three picture quality presets: **Normal**, **Fine**, and **Super Fine**. The picture quality is set to Super Fine by default.

Zoom

Allows you to change the maximum magnification allowed.

Self Timer

Sets the delay of shutter release to 5 or 10 seconds after you have pressed the camera/shutter button.

Burst

Allows you to take 4 or 9 pictures in succession with one press of the camera/shutter button.

Frame

Allows you to set a frame.

NOTE: Ensure that you have set the screen resolution to 320 x 240 before setting frame.

Effect

The Effect option allows you to apply some effects to the subject. Select from the following configuration options: **Black-White**, **Negative**, **Sepia**, and **Solarize**. Set to **Normal** for no effect.

Save to

Allows you to select the default storage for captured pictures.

NOTE: Prepare a microSD card before setting default storage to **Storage Card**.

Advanced

This option allows you to set the following: **Filename prefix format**, **Filename prefix**, **File number**, **Date and time stamp**, **Shutter sound**, and **Burst interval**.

Taking photos

After launching the camera, your device is set to Camera mode by default. If set otherwise, tap **Menu > Change Mode > Camera Mode** then tap **Exit**.

You can also tap the camera mode icon to set the camera mode.

To take a photo:

1. Aim your device at your subject then press camera/shutter button.
2. When the  icon appears, ensure that your device is stable.
3. Repeat steps 1 to 2 to take more photos.



NOTE: The image is automatically saved to the default storage location and can be viewed using the Pictures and Videos application.





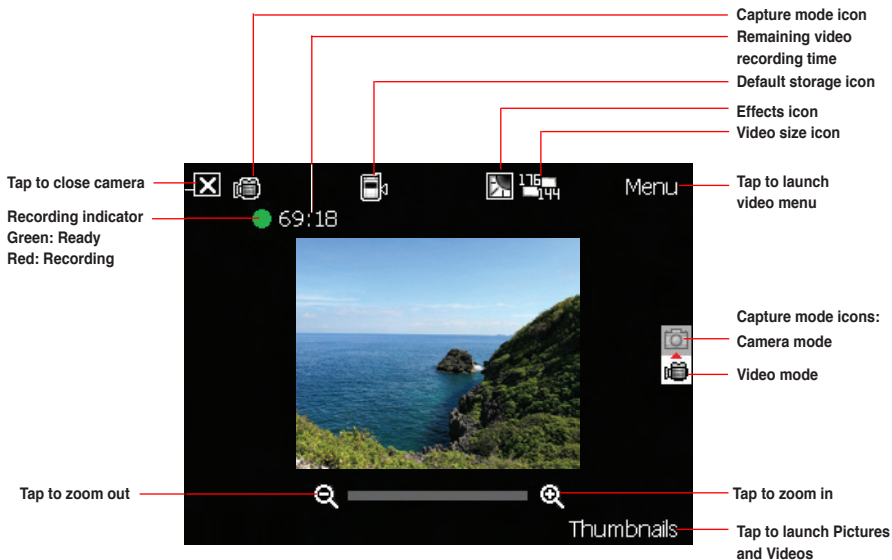



Video mode

The following describes the screen icons in Video mode:



Video mode icons

Refer to the table below for the video mode icons.

Icon		Description
Capture mode		Indicates the current capture mode.
Default storage		Indicates default storage for captured images and videos clips.
Effects		Indicates the effects used.
Video Size		Shows the resolution used.
Exit		Tap to exit video.
Zoom In		Tap to zoom in view of subject on screen.
Zoom Out		Tap to zoom out view of subject on screen.
Thumbnails		Tap to launch Pictures and Video application and play your video.
Menu		Tap to launch video menu options.

Video options menu

The video options menu allows you to change various video and playback settings.

To launch video options menu:

1. Tap **Menu** from the video screen.
2. From the shortcut menu, tap an icon to display contents.

Change Mode

The Change Mode option allows you to set your device into Camera or Video capture mode.

Zoom

Allows you to change the maximum magnification allowed.

Video Size

Allows you to set the frame size of video.

Save to

Allows you to select the default storage location for captured pictures.

NOTE: Prepare a microSD card before setting default storage to **Storage Card**.

Effect

The Effect option allows you to apply some effects to the subject. Select from the following configuration options: **Black-White**, **Negative**, **Sepia**, and **Solarize**. Set to **Normal** for no effect.

Advanced

This option allows you to set the following: **Video file type**, **Filename prefix format**, **Filename prefix**, **File number**, and **Enable or disable audio when recording**.

Recording videos

Set the device to video capture mode to record videos.

To set video mode:

- Tap **Menu > Change Mode > Video Mode** then tap **Exit**.
- Tap the video mode icon on the screen.

To record video:

1. Aim your device at your subject then press camera/shutter button to begin recording. The record indicator turns from green to red while video is recording.
2. Press the camera/shutter button again to stop recording.

NOTES:

- The video clip is automatically saved to the default storage location.
 - Use Windows Media Player Mobile to playback video clip in your device.
 - Use Apple® QuickTime™ player, if you wish to play video clips in your computer. You can download QuickTime™ installer from www.apple.com/quicktime.
-

Viewing pictures and videos

Use the Pictures and Video Application to preview stored images and playback video clips.

Viewing pictures and videos

To view pictures and videos:

1. Tap  > **Programs** > **Pictures & Videos**.
2. Tap the picture or video clip you want to see.
 - To view pictures or launch video clips stored in microSD card, tap the folder list (labeled **My Pictures**), and tap **microSD Card**.
 - To view pictures stored in **My Pictures** folder on your device, tap **My Pictures** then tap picture thumbnail.
 - To playback video clips in **My Videos** folder on your device, tap **My Videos** then tap video thumbnail.









Editing pictures

To edit pictures:

1. Tap  > **Programs** > **Pictures & Videos**. Tap the picture you want to edit.
2. Tap **Menu** > **Make Big Face**.
3. Edit the image.

Refer to the tool icons and their descriptions on the next page.

Tool bar

Icons	Description	Icons	Description
	Tap to hide the tool bar		Tap to erase some parts in the picture
	Tap to select the color of your editing stroke		Tap to undo editing
	Tap to select the size of the pencil stroke		Tap to save the image
	Tap to add some stamps in the picture		Tap to exit editing
	Tap to add text		

NOTES:

- This image editor function can only be applied to the pictures or photos with 320 x 240 resolution.
- The image bigger than 320 x 240 resolution will be zoomed into 320 x 240 resolution.

-
4. Tap  to save the picture, then tap **Yes** to confirm.

NOTE: In this option, the original picture is replaced by the edited file.

You can also tap  in the Tool bar and choose **Save as** to save the edited picture as another file name.

Streaming Player

Streaming Player allows you to play audio or video files streamed to your device from the Internet. Supported formats include 3gp, 3g2, mp4, and sdp.

NOTE: Before using Streaming Player, ensure that you are connected to the Internet via Wi-Fi, or GPRS connection. Refer to the sections on Wi-Fi, or GPRS in this user guide for activating any of these connections on your device.

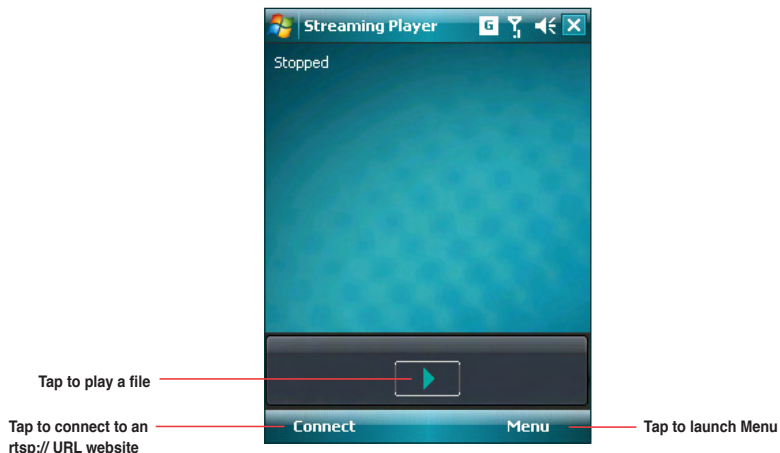

NOTE: A Real Time Streaming Protocol (RTSP) website provides multimedia data streams such as audio or video clips.

Using the Streaming Player

To play a streaming file:

1. Tap  > **Programs** > **Streaming Player**, then tap **Connect**.
2. Key in the web address then tap **Connect**.

NOTE: Streaming Player only recognizes an **rtsp:// URL** web address.

3. Tap  to play a streaming file from your preferred rtsp website.
You may also tap **Menu** to display the menu list and apply other operations.

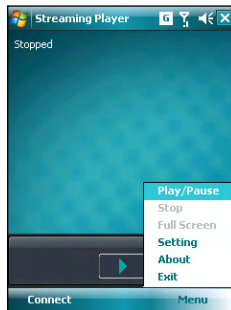

Chapter 11

Business features

- **Ur Time**
- **Remote Calendar**



Ur Time

Ur Time allows you to set the time and alarm at your current location as well set up the time for up to four cities.

NOTE: Install **Ur Time** from the Bonus CD that comes with your device package.



Setting the time

To set the time:

1. Tap  > **Programs** > **Ur Time**.
2. Tap **Menu** > **Time**. Set the local time at your current location.
3. Tap  when finished.



Setting the alarm

To set the alarm:

1. Tap  > **Programs** > **Ur Time**.
2. Tap **Menu** > **Alarm**, then tap **New** to add a new alarm, or select an existing alarm and tap **Edit**.
3. Set the alarm details. To activate anti-snooze feature, check the **Snooze** box and set snooze interval.
4. Tap  when finished.

Setting the World Clock

To set the World Clock:

1. Tap  > **Programs** > **Ur Time**.
2. Tap **Menu** > **World Clock**. You can set the time for up to four cities.
3. Tap . The World Clock appears on the Today screen.

Remote Calendar

Remote Calendar allows you to access your Google Calendar from your device. You can either view the calendar or synchronize events and agenda with your Google Calendar in bidirectional way. Download events from Google calendar, or upload events to Google Calendar with your device.

IMPORTANT:

- Obtain a Google account before using this function. Visit www.google.com/calendar to register for a Google account.
 - Ensure that your device is connected to the Internet via GPRS.
-

Synchronizing your calendar

Downloading events from Google Calendar

To download agenda or events form your Google Calendar:

1. Tap  > **Programs** > **Remote Calendar**
2. Key in the username and password, then tap **Sync** to start synchronizing.
3. When the calendar is synchronized successfully, a popup message appears. Tap **Yes** to open the calendar or tap **No** to exit.

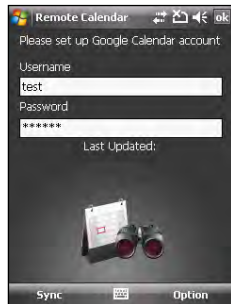

Uploading events to Google Calendar



To upload new events or modified events to your Google Calendar:

1. Tap  > **Calendar**.
2. Select the event you want to upload to Google Calendar, then tap **Menu > Upload to Google**.

Setting the Remote Calendar

The Remote Calendar allows you to set the synchronization mode.

To set your Remote Calendar:

1. Tap  > **Programs > Remote Calendar > Option > Setting**.
2. Set your desired synchronization mode, then tap  to apply changes or tap **Cancel** to quit.

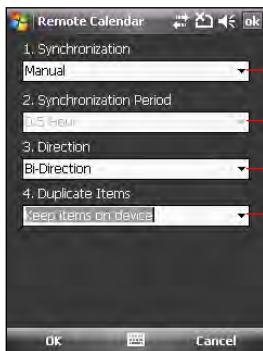

Tap to select sync mode.

Tap to select sync interval.

This item is inactive when the sync mode is set to Manual.

Tap to select sync direction.

Tap to select priority when event conflict happens.

Chapter 12

ASUS Special features

- **ASUS status icon**
- **ASUS Zip**
- **Backup**
- **Newstation**
- **Auto Cleaner**

ASUS status icon

The ASUS status icon allows you to easily check and see the current status of the following device components: **USB**, **LCD Brightness**, **Battery power**, **Memory**, and **microSD card**.

To check the status of these components, tap the ASUS Status icon  on the Today screen.

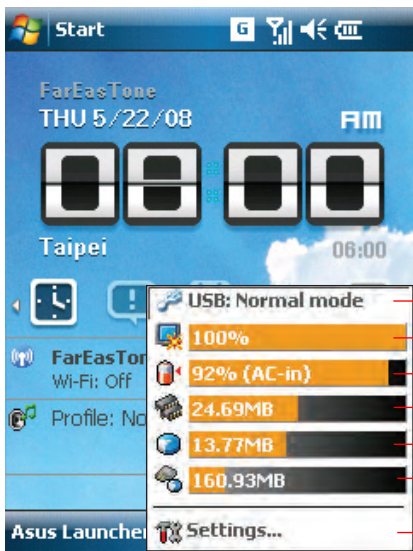

USB: Allows you to set the USB connection mode.

Brightness: Tap to adjust the LCD brightness on battery power or external power.

Power: Displays the remaining battery power and allows you to set advanced power saving features.

Program Memory: Displays the total, currently used, and remaining program storage memory.

Storage memory: Displays the total, currently used, and remaining storage memory.

MicroSD card: Tap to display the contents of the MicroSD card installed.

Settings: Allows you to select the items to display in this ASUS Status popup menu.

USB setting

Allows you to set the USB connection mode.

LCD Brightness

Adjusts the LCD brightness on battery power and external power.

Battery

Displays the battery power status.

The Advanced settings allows you to set a time when to turnoff the device if not used.

Memory

Displays the total, in use and free memory.

Storage card memory

Displays the total, in use, and available storage card memory.

Program memory

Displays the total, in use, and available program memory.

Settings

Allows you to select the items to display in the ASUS Settings popup menu.

ASUS Zip

ASUS Zip allows you to compress files and save space in your memory card or device.

NOTE: Install **ASUS Zip** from the Bonus CD that comes with your device package.

To compress files:

1. Tap  > **Programs** > **ASUS Zip**.
2. Select the radio button before **New compress file**, then tap **Next**.
3. Select files or folders and tap **Add** button, then tap **Next**.
4. Rename the file and select the location and compression mode. Check the **Password** box if you want to set password for the file. Tap **Next**.
5. Tap **Done** to exit. Check the **Exit and open folder** box if you want to open the folder where the compressed files are stored.

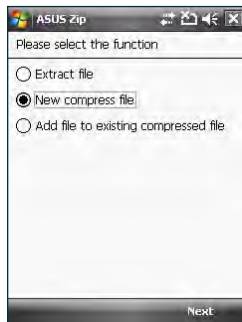

To add files to an existing compressed file:

1. Tap  > **Programs** > **ASUS Zip**.
2. Select the radio button before **Add file to existing compressed file**, then tap **Next**.
3. Select a compressed file, then tap **Next**.
4. Select files or folders you want to add and tap **Add** button, then tap **Next**.
5. Tap **Done** to exit. Check the **Exit and open folder** box if you want to open the folder where the compressed files are stored.

To extract files from a compressed file:

1. Tap  > **Programs** > **ASUS Zip**.
2. Select the radio button before **Extract file**, then tap **Next**.
3. Select a compressed file, then tap **Next**.
4. Select a folder to save the extracted files, then tap **Next**.
5. Tap **Done** to exit. Check the **Exit and open folder** box if you want to open the folder where the compressed files are stored.

Backup

Backup allows you to back up or restore your files and data to your device or storage card.

NOTE: Install **Backup** from the Bonus CD that comes with your device package.

Backing up files

To back up files:

1. Tap  > **Programs** > **Backup** > **Backup**.
2. Select the items you want to backup, then tap **Next**.
3. Rename the file and select the storage location for the backup, then tap **Next**.
4. Key in a four-digit number as your password to encrypt the backup file, then tap **Next**.
5. Tap **Start** to begin backup. Tap **Back** if you want to return to the previous screen.

NOTE: The system will turn off all processing applications when backing up files.

6. Tap **Reset** to reset the device.

Restoring files

To restore files:

1. Tap  > **Programs** > **Backup** > **Restore**.
2. Select a file you want to restore, then tap **Next**.
3. Key in the four-digit password to decrypt the backup file, then tap **Next**.
4. Select the items you want to restore, then tap **Next**.
5. Tap **Start** to begin restore, or tap **Back** to return to the last screen.

NOTE: The system will turn off all processing applications when restoring files.

Backup Setting

To set Backup:

1. Tap  > **Programs** > **Backup**, then tap **Option**.
2. Check the box if you want to reset the device after backup, then tap  to finish.

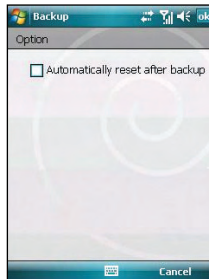
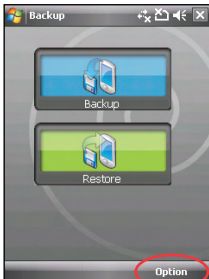

Newstation

With the Newstation in your device, you can conveniently browse news and blogs anywhere and anytime.

NOTE: Ensure that your device is connected to Internet when using Newstation.

Using Newstation

To read RSS news:

1. Tap  > **Programs** > **Newstation**.
2. Tap a category folder to open.
3. Tap a channel name to open.
4. Browse your favorite subjects.

To create a new category folder:

1. Tap  > **Programs** > **Newstation**.
2. Tap **Menu** > **New Category** then edit the category name.

To add a channel:

1. Tap  > **Programs** > **Newstation**, then tap a category folder to open.
2. Tap **Menu** > **New Channel**. You can add a channel either from the Internet or an existing file.
 - **Input from URL**
Select the radio button of **Input from URL** and enter the URL address, then tap **Next**.
Select a category where you want to add the channel, then tap **Finish**.

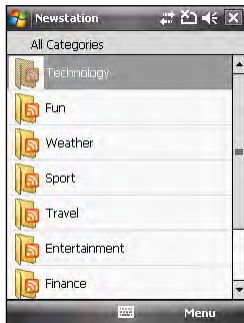

- **Import from a file**

Select the radio button of **Import from a file**, then tap **Next**.

Select a folder and choose a file from the list.

Choose channels from the list, then tap **Next**.

Select a category where you want to add the channel, then tap **Finish**.

NOTE: You may also tap  from the ASUS Today screen to access the Newstation application and download news updates.

Using Newstation menus

Category Menu

To use the category menu:

1. Tap  > **Programs** > **Newstation**.
2. Select a category folder. Then tap **Menu**. The menu list pops up.
3. Tap an option that you need.

Channel Menu

To use the channel menu:

1. Tap  > **Programs** > **Newstation**.
2. Tap a category folder, then select a channel and tap **Menu**.
3. Tap an option that you need.

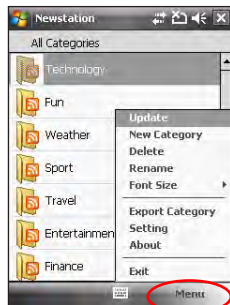

Subject Menu

To use the subject menu:

1. Tap  > **Programs** > **Newstation**.
2. Tap a category folder. Then tap a channel to open. Select a subject and tap **Menu**. The menu list pops up.
3. Tap an option that you need.

Auto Cleaner

To free the memory in your device, you can use this function to conveniently close the running applications that you are not using.

Setting the Auto Cleaner

To set the Auto Cleaner:

1. Tap **Start > Settings > System tab > Auto Cleaner**.
2. Select the check box to activate the Auto Cleaner function. Then select either **Short** or **Long press X** to close the program.
3. Tap **Set** button to set the **Exception** and the **Force-closed List**.
4. Tap **ok** when finished.

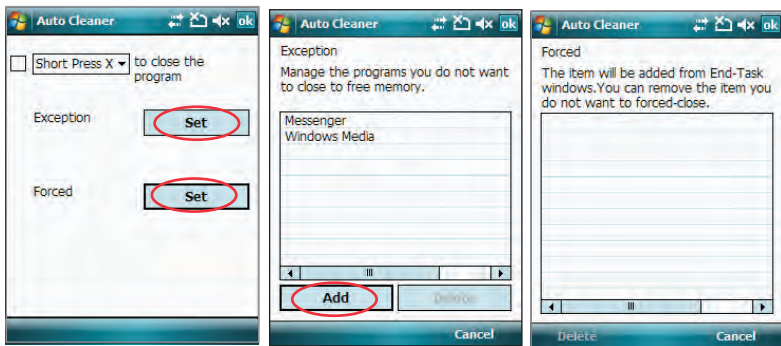

Chapter 13



Other features

- Restoring default factory settings
- System information
- Task Manager

Restoring default factory settings

This option allows you to restore the default factory settings.

To restore default settings:

1. Tap  > **Settings** > **System** tab > **Default Settings**.
2. Key in '1234' in the Password field to confirm that you want to restore to default settings.
3. Tap .

WARNING: This option will delete all files stored in this device.

System information

The System Information contains important device information including the current device settings and version.

To launch the System Information:

1. Tap  > **Settings** > **System** tab > **System Information**.
2. Tap the **Device Info** tab for device hardware information.
3. Tap **Version** tab to display the ROM, Boot, Radio, MP and Battery version.

Task Manager

The Task Manager allows you to monitor the currently running programs, memory and CPU occupancy. You can use this function to end these programs easily. You can also switch to any of the listed programs from the Task Manager screen.

To use Task Manager:

- To launch the Task Manager, tap  > **Programs** > **Task Manager**.
- To end a program, select the program you want to end and tap **End Task**.
- To end all tasks, tap **Menu** > **End All Tasks**.
- To switch to a program, select a program and press down the Navigation key, or tap **Menu** > **Switch To**.

Appendices

Appendices

- Notices
- Specific Absorption Rate (SAR)
- ASUS Contact information

Notices

Federal Communications Commission (FCC) Regulations

This device complies with part 15 of the FCC Rules. Operation is subject to the following two conditions:

1. This device may not cause harmful interference; and
2. This device must accept any interference received, including interference that may cause undesired operation.

This device has been tested and found to comply with the limits for a Class B digital device, pursuant to Part 15 of the FCC Rules. These limits are designed to provide reasonable protection against harmful interference in a residential installation. This equipment generates, uses and can radiated radio frequency energy and, if not installed and used in accordance with the instructions, may cause harmful interference to radio communications. However, there is no guarantee that interference will not occur in a particular installation. If this equipment does cause harmful interference to radio or television reception, which can be determined by turning the equipment off and on, the user is encouraged to try to correct the interference by one or more of the following measures:

- Reorient or relocate the receiving antenna.
- Increase the separation between the equipment and receiver.
- Connect the equipment into an outlet on a circuit different from that to which the receiver is connected.
- Consult the dealer or an experienced radio/TV technician for help.

Changes or modifications not expressly approved by the party responsible for compliance could void the user's authority to operate the equipment.

Canadian Department of Communications Statement

Country Code selection feature to be disabled for products marketed to the US/CANADA Operation is subject to the following two conditions:

1. This device may not cause interference; and
2. This device must accept any interference, including interference that may cause undesired operation of the device.

This Class [B] digital apparatus complies with Canadian ICES-003.

Cet appareil numérique de la classe [B] est conforme à la norme NMB-003 du Canada.

This Category II radiocommunication device complies with Industry Canada Standard RSS-310.

Ce dispositif de radiocommunication de catégorie II respecte la norme CNR-310 d'Industrie Canada.

Replaceable batteries

If an equipment is provided with a replaceable battery and if replacement by an incorrect type could result in an explosion (e.g. with some lithium batteries), the following applies:

- if the battery is placed in an OPERATOR ACCESS AREA, there shall be a marking close to the battery or a statement in both the operating and the servicing instructions;
- if the battery is placed elsewhere in the equipment, there shall be a marking close to the battery or a statement in the servicing instructions.

The marking or statement shall include the following or similar text:

CAUTION:

- RISK OF EXPLOSION IF BATTERY IS REPLACED BY AN INCORRECT TYPE.
 - DISPOSE USED BATTERIES ACCORDING TO THE INSTRUCTIONS.
-

Operator access with a tool

If a TOOL is necessary to gain access to an OPERATOR ACCESS AREA, either all other compartments within that area containing a hazard shall be inaccessible to the OPERATOR by the use of the same TOOL, or such compartments shall be marked to discourage OPERATOR access.

An acceptable marking for an electric shock hazard is (ISO 3864, No. 5036).

Equipment for restricted access locations

For equipment intended only for installation in a RESTRICTED ACCESS LOCATION, the installation instructions shall contain a statement to this effect.

WARNING: The user needs to switch off the device when exposed to areas with potentially explosive atmospheres such as petrol stations, chemical storage depots and blasting operations.

Specific Absorption Rate (SAR)

Bodyworn operation

For bodyworn operation, this device has been tested and meets the FCC RF exposure guidelines for use with an accessory that contains no metal and the positions the handset a minimum of 1.5 cm from the body. Use of other enhancements may not ensure compliance with FCC RF exposure guidelines. If you do not use a body-worn accessory and are not holding the device at the ear, position the handset a minimum of 1.5 cm from your body when the device is switched on.

Exposure to radio waves

THIS MODEL MEETS INTERNATIONAL GUIDELINES FOR EXPOSURE TO RADIO WAVES

Your mobile device is a radio transmitter and receiver. It is designed not to exceed the limits for exposure to radio waves recommended by international guidelines. These guidelines were developed by the

independent scientific organization ICNIRP and include safety margins designed to assure the protection of all persons, regardless of age and health.

The guidelines use a unit of measurement known as the Specific Absorption Rate, or SAR. The ICNIRP SAR limit for mobile devices used by the general public is 2 W/kg and the highest SAR value for this in device when tested were 0.319 W/kg* at the ear, and 0.86 W/kg* on the body.

As SAR is measured utilizing the device's highest transmitting power, the actual SAR of this device while operating is typically below that indicated above. This is due to automatic changes to the power level of the device to ensure it only uses the minimum level required to reach the network.

While there may be differences between the SAR levels of various phones and at various positions, they all meet the governmental requirements for safe exposure. Please note that improvements to this product model could cause differences in the SAR value for later products; in all cases, products are designed to be within the guidelines.

The World Health Organization has stated that present scientific information does not indicate the need for any special precautions for the use of mobile devices. They note that if you want to reduce your exposure then you can do so by limiting the length of calls or using a 'handsfree' device to keep the mobile phone away from the head and body.

Additional Information can be found on the websites of the World Health Organization (<http://www.who.int/emf>).

* The tests are carried out in accordance with international guidelines for testing. The limit incorporates a substantial margin for safety to give additional protection for the public and to account for any variations in measurements. Additional related information includes the ASUS testing protocol, assessment procedure, and measurement uncertainty range for this product.

Declaration of Conformity

We, Manufacturer/Importer
(full address)

**ASUS COMPUTER GmbH HARKORT STR. 25
40880 RATINGEN, BRD. GERMANY**

declare that the product
(description of the apparatus, system, installation to which it refers)

PDA Phone P320

is in conformity with

(reference to the specification under which conformity is declared)
in accordance with 2004/108/EC-EMC Directive and 1995/5 EC-R &TTE Directive

- EN 300328** Electromagnetic compatibility and Radio spectrum Matters (ERM); wideband transmission equipment operating in the 2.4Ghz ISM band and using spread spectrum modulation techniques; Part 1: technical characteristics and test conditions Part2: Harmonized EN covering essential requirements under article 3.2 of the R&TTE
- EN 300440-2** Electromagnetic compatibility and Radio spectrum Matters(ERM); Short range devices; Radio equip-ment to be used in the 1 GHZ to 40 GHZ frequency range; Part2: Harmonized EN under article 3.2 of the R&TTE Directive
- EN 301489** Electromagnetic compatibility and Radio spectrum Matters(ERM); Electromagnetic compatibility(EMC) standard for radio equipment and services; Part 17: Specific conditions for wideband data and HIPER-LAN equipment
- EN 301511** Global System for Mobile communications(GSM) Harmonized EN for mobile stations in the GSM 900 And GSM 1800 bans covering essential requirements of article 3.2 of article 3.2 of the R&TTE directive(1999/5EC)

- EN 301908-1
EN 301908-2 Electromagnetic compatibility and Radio spectrum Matters(ERM); Base Stations(BS), Repeaters and User Equipment(UE)for IMT-2000 Third-Generation cellular Networks,-Part1:Harmonized EN for IMT-2000, Introduction and common requirements, covering Essential requirements of article 3.2 of the R&TTE Directive Part2:Harmonized EN for IMT-2000,CDMA Direct Spread (UTRD FDD) (UE)covering essential requirements of article 3.2 of the R&TTE Directive.
- EN 55002:2006 Limits and methods of measurement of radio disturbance characteristics of information technology equipment
- EN 55024:1998+A1:2001+A2:2003 Information Technology equipment-Immunity characteristics-Limits and methods of measurement
- EN 50360
EN 50361 the limitation of exposure of the general public to electromagneticnetwork fields (0 Hz to 300 GHz) International Commission on Non-Ionising Radiation Protection (1998), Guidelines for limiting exposure in time-varying electric, magnetic, and electromagnetic fields
- EN 61000-3-2 : 2000+A2:2005 Disturbances in supply systems caused
- EN 61000-3-3 : 1995+A1:2001 Disturbances in supply systems caused
- EN 55013 Limits and methods of measurement of radio disturbance characteristics of broadcast receivers and associated equipment
- EN 55020 Immunity from radio interference of broadcast receivers and associated equipment
- EN 50332-1 Sound system equipment-Headphones and earphones associated with portable audio equipment-Maximum sound pressure level measurement methodology and limit considerations-Part1:General method for "one package equipment"
- CE marking
-  (EC conformity marking)
- The manufacturer also declares the conformity of above mentioned product with the actual required safety standards in accordance with LVD 2006/95 EC**
- EN 60065 Safety requirements for mains operated electronic and related apparatus for household and similar general use
- EN 60335 Safety of household and similar electrical appliances
- EN 60950-1 Safety for information technology equipment including electrical business equipment
- EN 50091-1 General and Safety requirements for uninterruptible power systems (UPS)

Date : Mar. 26 , 2008

ASUSTek COMPUTER INC.

Address: 15 Li-Te Road, Peitou, Taipei, Taiwan

Tel: 886228943447; Fax: 886228907698

Declaration

We declare that the International Mobile Equipment Identity (IMEI) codes for this product, P320, are unique to each unit and only assigned to this model. The IMEI of each unit is factory set and cannot be altered by the user and that it complies with the relevant IMEI integrity related requirements expressed in the GSM standards.

Should you have any questions or comments regarding this matter, please contact us.

Sincerely yours,

ASUSTek COMPUTER INC.

Tel: 886228943447

Fax: 886228907698

Email: <http://vip.asus.com/eservice/techserv.aspx>

ASUS Contact information

ASUSTeK COMPUTER INC. (AsiaPacific)

Address 15 Li-Te Road, Peitou, Taipei, Taiwan 11259
Website www.asus.com.tw

Technical Support

Telephone +886228943447
Support Fax +886228907698
Software download [support.asus.com*](http://support.asus.com)

ASUS COMPUTER INTERNATIONAL (America)

Address 44370 Nobel Drive, Fremont, CA 94538, USA
Telephone +15029550883
Fax +15029338713
Website usa.asus.com
Software download [support.asus.com*](http://support.asus.com)

ASUS COMPUTER GmbH (Germany and Austria)

Address Harkort Str. 25, D40880 Ratingen, Germany
Telephone +49210295990
Fax +492102959911
Online contact www.asus.com.de/sales

Technical Support

Telephone +49210295990
Fax +492102959911
Online support www.asus.com.de/support
Website www.asus.com.de/news

* Available on this site is an online Technical Inquiry Form that you can fill out to contact technical support.

Free Manuals Download Website

<http://myh66.com>

<http://usermanuals.us>

<http://www.somanuals.com>

<http://www.4manuals.cc>

<http://www.manual-lib.com>

<http://www.404manual.com>

<http://www.luxmanual.com>

<http://aubethermostatmanual.com>

Golf course search by state

<http://golfingnear.com>

Email search by domain

<http://emailbydomain.com>

Auto manuals search

<http://auto.somanuals.com>

TV manuals search

<http://tv.somanuals.com>