

# A8N-E

**ASUS**<sup>®</sup>

# Motherboard

**E2500**  
**V2**  
**March 2006**

**Copyright © 2006 ASUSTeK COMPUTER INC. All Rights Reserved.**

No part of this manual, including the products and software described in it, may be reproduced, transmitted, transcribed, stored in a retrieval system, or translated into any language in any form or by any means, except documentation kept by the purchaser for backup purposes, without the express written permission of ASUSTeK COMPUTER INC. ("ASUS").

Product warranty or service will not be extended if: (1) the product is repaired, modified or altered, unless such repair, modification or alteration is authorized in writing by ASUS; or (2) the serial number of the product is defaced or missing.

ASUS PROVIDES THIS MANUAL "AS IS" WITHOUT WARRANTY OF ANY KIND, EITHER EXPRESS OR IMPLIED, INCLUDING BUT NOT LIMITED TO THE IMPLIED WARRANTIES OR CONDITIONS OF MERCHANTABILITY OR FITNESS FOR A PARTICULAR PURPOSE. IN NO EVENT SHALL ASUS, ITS DIRECTORS, OFFICERS, EMPLOYEES OR AGENTS BE LIABLE FOR ANY INDIRECT, SPECIAL, INCIDENTAL, OR CONSEQUENTIAL DAMAGES (INCLUDING DAMAGES FOR LOSS OF PROFITS, LOSS OF BUSINESS, LOSS OF USE OR DATA, INTERRUPTION OF BUSINESS AND THE LIKE), EVEN IF ASUS HAS BEEN ADVISED OF THE POSSIBILITY OF SUCH DAMAGES ARISING FROM ANY DEFECT OR ERROR IN THIS MANUAL OR PRODUCT.

SPECIFICATIONS AND INFORMATION CONTAINED IN THIS MANUAL ARE FURNISHED FOR INFORMATIONAL USE ONLY, AND ARE SUBJECT TO CHANGE AT ANY TIME WITHOUT NOTICE, AND SHOULD NOT BE CONSTRUED AS A COMMITMENT BY ASUS. ASUS ASSUMES NO RESPONSIBILITY OR LIABILITY FOR ANY ERRORS OR INACCURACIES THAT MAY APPEAR IN THIS MANUAL, INCLUDING THE PRODUCTS AND SOFTWARE DESCRIBED IN IT.

Products and corporate names appearing in this manual may or may not be registered trademarks or copyrights of their respective companies, and are used only for identification or explanation and to the owners' benefit, without intent to infringe.

# Contents

Notices .....	vi
Safety information .....	vii
About this guide .....	viii
How this guide is organized .....	viii
Where to find more information .....	viii
Conventions used in this guide .....	ix
Typography .....	ix
A8N-E specifications summary .....	x

## Chapter 1: Product introduction

1.1	Special features .....	1-2
1.1.1	Product highlights .....	1-2
1.1.2	Innovative ASUS features .....	1-4
1.2	Before you proceed .....	1-5
1.3	Motherboard overview .....	1-6
1.3.1	Placement direction .....	1-6
1.3.2	Screw holes .....	1-6
1.3.3	Motherboard layout .....	1-7
1.4	Central Processing Unit (CPU) .....	1-8
1.4.1	Overview .....	1-8
1.4.2	Installing the CPU .....	1-8
1.4.3	Installing the heatsink and fan .....	1-10
1.5	System memory .....	1-13
1.5.1	Overview .....	1-13
1.5.2	Memory Configurations .....	1-13
1.5.3	Installing a DIMM .....	1-15
1.5.4	Removing a DIMM .....	1-15
1.6	Expansion slots .....	1-16
1.6.1	Installing an expansion card .....	1-16
1.6.2	Configuring an expansion card .....	1-16
1.6.3	Interrupt assignments .....	1-17
1.6.4	PCI slots .....	1-17
1.6.5	PCI Express x16 slot .....	1-18
1.6.6	PCI Express x1 slot .....	1-18

# Contents

1.7	Jumpers .....	1-18
1.8	Connectors .....	1-20
1.8.1	Rear panel connectors .....	1-20
1.8.2	Internal connectors .....	1-22

## Chapter 2: BIOS setup

2.1	Managing and updating your BIOS .....	2-2
2.1.1	Creating a bootable floppy disk .....	2-2
2.1.2	Updating the BIOS .....	2-3
2.1.3	Saving the current BIOS file .....	2-5
2.1.4	ASUS EZ Flash utility .....	2-6
2.2	BIOS setup program .....	2-7
2.2.1	BIOS menu screen .....	2-8
2.2.2	Menu bar .....	2-8
2.2.3	Legend bar .....	2-9
2.2.4	Menu items .....	2-9
2.2.5	Sub-menu items .....	2-9
2.2.6	Configuration fields .....	2-9
2.2.7	Pop-up window .....	2-10
2.2.8	General help .....	2-10
2.3	Main menu .....	2-11
2.3.1	System Time .....	2-11
2.3.2	System Date .....	2-11
2.3.3	Language .....	2-11
2.3.4	Legacy Diskette A .....	2-11
2.3.5	Primary and Secondary IDE Master/Slave .....	2-12
2.3.6	First, Second, Third, Fourth SATA Master .....	2-14
2.3.7	HDD SMART Monitoring .....	2-15
2.3.8	Installed Memory .....	2-15
2.4	Advanced menu .....	2-16
2.4.1	CPU Configuration .....	2-16

## Contents

2.4.2	PCI/PnP .....	2-19
2.4.3	Onboard Devices Configuration .....	2-20
2.5	Power menu .....	2-24
2.5.1	ACPI Suspend Type .....	2-24
2.5.2	ACPI APIC Support .....	2-24
2.5.3	APM Configuration .....	2-25
2.5.4	Hardware Monitor .....	2-27
2.6	Boot menu .....	2-28
2.6.1	Boot Device Priority .....	2-28
2.6.2	Removable Drives .....	2-29
2.6.3	Hard Disk Drives .....	2-29
2.6.4	CDROM Drives .....	2-29
2.6.5	Boot Settings Configuration .....	2-30
2.6.6	Security .....	2-31
2.7	Exit menu .....	2-33

# Notices

## Federal Communications Commission Statement

This device complies with Part 15 of the FCC Rules. Operation is subject to the following two conditions:

- This device may not cause harmful interference, and
- This device must accept any interference received including interference that may cause undesired operation.

This equipment has been tested and found to comply with the limits for a Class B digital device, pursuant to Part 15 of the FCC Rules. These limits are designed to provide reasonable protection against harmful interference in a residential installation. This equipment generates, uses and can radiate radio frequency energy and, if not installed and used in accordance with manufacturer's instructions, may cause harmful interference to radio communications. However, there is no guarantee that interference will not occur in a particular installation. If this equipment does cause harmful interference to radio or television reception, which can be determined by turning the equipment off and on, the user is encouraged to try to correct the interference by one or more of the following measures:

- Reorient or relocate the receiving antenna.
- Increase the separation between the equipment and receiver.
- Connect the equipment to an outlet on a circuit different from that to which the receiver is connected.
- Consult the dealer or an experienced radio/TV technician for help.



---

The use of shielded cables for connection of the monitor to the graphics card is required to assure compliance with FCC regulations. Changes or modifications to this unit not expressly approved by the party responsible for compliance could void the user's authority to operate this equipment.

---

## Canadian Department of Communications Statement

This digital apparatus does not exceed the Class B limits for radio noise emissions from digital apparatus set out in the Radio Interference Regulations of the Canadian Department of Communications.

**This class B digital apparatus complies with Canadian ICES-003.**

# Safety information

## Electrical safety

- To prevent electrical shock hazard, disconnect the power cable from the electrical outlet before relocating the system.
- When adding or removing devices to or from the system, ensure that the power cables for the devices are unplugged before the signal cables are connected. If possible, disconnect all power cables from the existing system before you add a device.
- Before connecting or removing signal cables from the motherboard, ensure that all power cables are unplugged.
- Seek professional assistance before using an adapter or extension cord. These devices could interrupt the grounding circuit.
- Make sure that your power supply is set to the correct voltage in your area. If you are not sure about the voltage of the electrical outlet you are using, contact your local power company.
- If the power supply is broken, do not try to fix it by yourself. Contact a qualified service technician or your retailer.

## Operation safety

- Before installing the motherboard and adding devices on it, carefully read all the manuals that came with the package.
- Before using the product, make sure all cables are correctly connected and the power cables are not damaged. If you detect any damage, contact your dealer immediately.
- To avoid short circuits, keep paper clips, screws, and staples away from connectors, slots, sockets and circuitry.
- Avoid dust, humidity, and temperature extremes. Do not place the product in any area where it may become wet.
- Place the product on a stable surface.
- If you encounter technical problems with the product, contact a qualified service technician or your retailer.

## About this guide

This user guide contains the information you need when installing and configuring the motherboard.

## How this guide is organized

This manual contains the following parts:

- **Chapter 1: Product introduction**

This chapter describes the features of the motherboard and the new technology it supports. It also lists the hardware setup procedures that you have to perform when installing system components. It includes description of the jumpers and connectors on the motherboard.

- **Chapter 2: BIOS setup**

This chapter tells how to change system settings through the BIOS Setup menus. Detailed descriptions of the BIOS parameters are also provided.

## Where to find more information

Refer to the following sources for additional information and for product and software updates.

1. **Websites**

Visit the TARGA® website ([www.targa-online.com](http://www.targa-online.com)) to download the latest BIOS for this motherboard. Use ONLY the TARGA® OEM BIOS when updating the motherboard BIOS. Other BIOS updates may corrupt the BIOS ROM.

2. **Optional documentation**

Your product package may include optional documentation, such as warranty flyers, that may have been added by your dealer. These documents are not part of the standard package.



## Conventions used in this guide

To make sure that you perform certain tasks properly, take note of the following symbols used throughout this manual.



**DANGER/WARNING:** Information to prevent injury to yourself when trying to complete a task.



**CAUTION:** Information to prevent damage to the components when trying to complete a task.



**IMPORTANT:** Instructions that you **MUST** follow to complete a task.



**NOTE:** Tips and additional information to help you complete a task.

## Typography

**Bold text**

Indicates a menu or an item to select

*Italics*

Used to emphasize a word or a phrase

<Key>

Keys enclosed in the less-than and greater-than sign means that you must press the enclosed key

Example: <Enter> means that you must press the Enter or Return key

<Key1+Key2+Key3>

If you must press two or more keys simultaneously, the key names are linked with a plus sign (+)

Example: <Ctrl+Alt+D>

**Command**

Means that you must type the command exactly as shown, then supply the required item or value enclosed in brackets

Example: At the DOS prompt, type the command line:

**awdflash A8NE.ROM**

## A8N-E specifications summary

<b>CPU</b>	Socket 939 for AMD Athlon™ 64FX/AMD Athlon™ 64 processor Supports AMD 64 architecture that enables simultaneous 32-bit and 64-bit architecture Supports AMD® Cool 'n' Quiet! Technology
<b>Chipset</b>	NVIDIA® nForce™ 4 standard
<b>Memory</b>	Dual-channel memory architecture 4 x 184-pin DIMM sockets support non-ECC unbuffered 400/333 MHz DDR memory modules Supports up to 4 GB system memory
<b>Expansion slots</b>	1 x PCI Express x16 slots 2 x PCI Express x1 slots 1 x PCI Express x4 slot 3 x PCI slots
<b>Storage</b>	NVIDIA® nForce™ 4 standard chipset supports: <ul style="list-style-type: none"> <li>- 2 x Ultra DMA 133/100/66/33</li> <li>- 4 x Serial ATA 1.5Gb/s drives</li> <li>- RAID 0, RAID 1, RAID 1+0</li> </ul>
<b>Special features</b>	ASUS Q-Fan ASUS Multi-language BIOS
<b>Internal connectors</b>	1 x Floppy disk drive connector 2 x IDE connectors 4 x Serial ATA connectors 1 x CPU fan connector 1 x Power fan connector 2 x Chassis fan connector 1 x Serial port connector (COM port) 1 x 24-pin ATX power connector 1 x 4-pin ATX 12 V power connector 3 x USB 2.0 connectors for 6 additional USB 2.0 ports 1 x Internal audio connectors (CD\AUX) 1 x GAME/MIDI connector 1 x Chassis intrusion connector 1 x Front panel audio connector Intel panel connector 1 x IEEE 1394a connector (Optional)

*(continued on the next page)*

## A8N-E specifications summary

<b>LAN</b>	NVIDIA® nForce™ 4 built-in Gigabit MAC with external Marvell® PHY supports
<b>AI Audio</b>	Realtek® ALC850 8-channel CODEC 1 x Coaxial S/PDIF out port 1 x Optical S/PDIF out port
<b>USB</b>	Supports up to 10 USB 2.0 ports
<b>IEEE 1394</b>	Optional T1 controller supports: - 2 x IEEE 1394a port
<b>Rear panel</b>	1 x Parallel port 1 x LAN (RJ-45) port 4 x USB 2.0 ports 1 x Optical S/PDIF out port 1 x Coaxial S/PDIF out port 1 x PS/2 keyboard port 1 x PS/2 mouse port 8-channel audio ports 1 x IEEE 1394a port (Optional)
<b>BIOS features</b>	4 Mb Flash ROM, Phoenix-Award BIOS, PnP, DMI2.0, WfM2.0, SM BIOS 2.3
<b>Power Requirement</b>	ATX power supply (with 24-pin and 4-pin 12 V plugs) ATX 12 V 2.0 compliant
<b>Form Factor</b>	ATX form factor: 12 in x 9.6 in (30.5 cm x 24.4 cm)

*\*Specifications are subject to change without notice.*



This chapter describes the motherboard features and the new technologies it supports.

# 1 Product introduction

## 1.1 Special features

### 1.1.1 Product highlights

#### Latest processor technology



The AMD Athlon™ 64FX and Athlon™ 64 desktop processors are based on AMD's 64-bit and 32-bit architecture, which represents the landmark introduction of the industry's first x86-64 technology. These processors provide a dramatic leap forward in compatibility, performance, investment protection, and reduced total cost of ownership and development. See page 1-10.

#### AMD Cool 'n' Quiet!™ Technology



The motherboard supports the AMD Cool 'n' Quiet!™ Technology that dynamically and automatically changes the CPU speed, voltage and amount of power depending on the task the CPU performs. See pages 2-22, 3-31.

#### HyperTransport™ Technology



HyperTransport™ Technology is a high-speed, low latency, point-to-point link designed to increase the communication speed between integrated circuits in computers, networking and telecommunications equipment up to 48 times faster than other existing technologies.

#### Dual Channel DDR memory support



Employing the Double Data Rate (DDR) memory technology, the motherboard supports up to 4GB of system memory using DDR400/333/266 DIMMs. The ultra-fast 400MHz memory bus delivers the required bandwidth for the latest 3D graphics, multimedia, and Internet applications. See page 1-15.

#### Serial ATA 1.5Gb/s technology



The motherboard supports the next-generation Serial ATA 1.5Gb/s technology through the Serial ATA interfaces and the NVIDIA® nForce™ 4 standard chipset. Additionally, Serial ATA allows thinner, more flexible cables with lower pin count, and reduced voltage requirement. See pages 1-25.

## RAID solution

The NVIDIA® nForce™ 4 standard RAID controller onboard provides the motherboard with RAID 0, RAID 1, RAID 1+0 and JBOD configuration for four SATA and two PATA connectors. See page 3-21 for details.

## PCI Express™ interface

The motherboard fully supports PCI Express, the latest I/O interconnect technology that speeds up the PCI bus. PCI Express features point-to-point serial interconnections between devices and allows higher clockspeeds by carrying data in packets. This high speed interface is software compatible with existing PCI specifications. See page 1-20 for details.

## S/PDIF digital sound ready

The motherboard supports the S/PDIF Out function through the S/PDIF interfaces on the rear panel. The S/PDIF technology turns your computer into a high-end entertainment system with digital connectivity to powerful audio and speaker systems. See page 1-23 for details.

## USB 2.0 technology

The motherboard implements the Universal Serial Bus (USB) 2.0 specification, dramatically increasing the connection speed from the 12 Mbps bandwidth on USB 1.1 to a fast 480 Mbps on USB 2.0. USB 2.0 is backward compatible with USB 1.1. See page 1-23 and 1-27 for details.

## Temperature, fan, and voltage monitoring

The CPU temperature is monitored by the ASIC (integrated in the Winbond Super I/O) to prevent overheating and damage. The system fan rotations per minute (RPM) is monitored for timely failure detection. The ASIC monitors the voltage levels to ensure stable supply of current for critical components. See section “2.5.4 Hardware Monitor” on page 2-35.

## 1.1.2 Innovative ASUS features

### ASUS Q-Fan technology



The ASUS Q-Fan technology smartly adjusts the fan speeds according to the system loading to ensure quiet, cool, and efficient operation. See page 2-35 for details.

### ASUS Multi-language BIOS



The multi-language BIOS allows you to select the language of your choice from the available options. The localized BIOS menus allow you to configure easier and faster. See page 2-16 for details.



## 1.2 Before you proceed

Take note of the following precautions before you install motherboard components or change any motherboard settings.



- Unplug the power cord from the wall socket before touching any component.
- Use a grounded wrist strap or touch a safely grounded object or to a metal object, such as the power supply case, before handling components to avoid damaging them due to static electricity
- Hold components by the edges to avoid touching the ICs on them.
- Whenever you uninstall any component, place it on a grounded antistatic pad or in the bag that came with the component.
- **Before you install or remove any component, ensure that the ATX power supply is switched off or the power cord is detached from the power supply.** Failure to do so may cause severe damage to the motherboard, peripherals, and/or components.

### Onboard LEDs

The motherboard comes with a green standby power LED that lights up to indicate that the system is ON, in sleep mode, or in soft-off mode. This is a reminder that you should shut down the system and unplug the power cable before removing or plugging in any motherboard component.

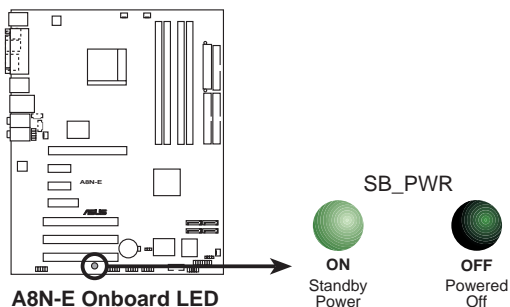

## 1.3 Motherboard overview

Before you install the motherboard, study the configuration of your chassis to ensure that the motherboard fits into it.



Make sure to unplug the power cord before installing or removing the motherboard. Failure to do so can cause you physical injury and damage motherboard components.

### 1.3.1 Placement direction

When installing the motherboard, make sure that you place it into the chassis in the correct orientation. The edge with external ports goes to the rear part of the chassis as indicated in the image below.

### 1.3.2 Screw holes

Place nine (9) screws into the holes indicated by circles to secure the motherboard to the chassis.



Do not overtighten the screws! Doing so can damage the motherboard.

Place this side towards  
the rear of the chassis

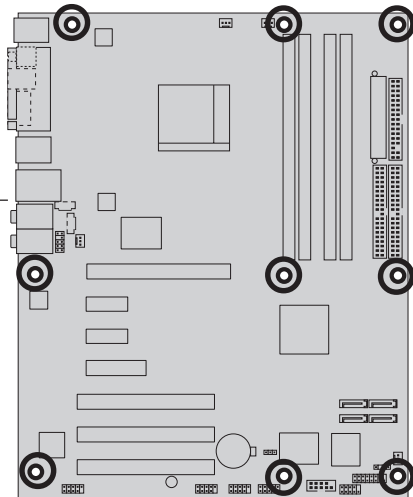

### 1.3.3 Motherboard layout

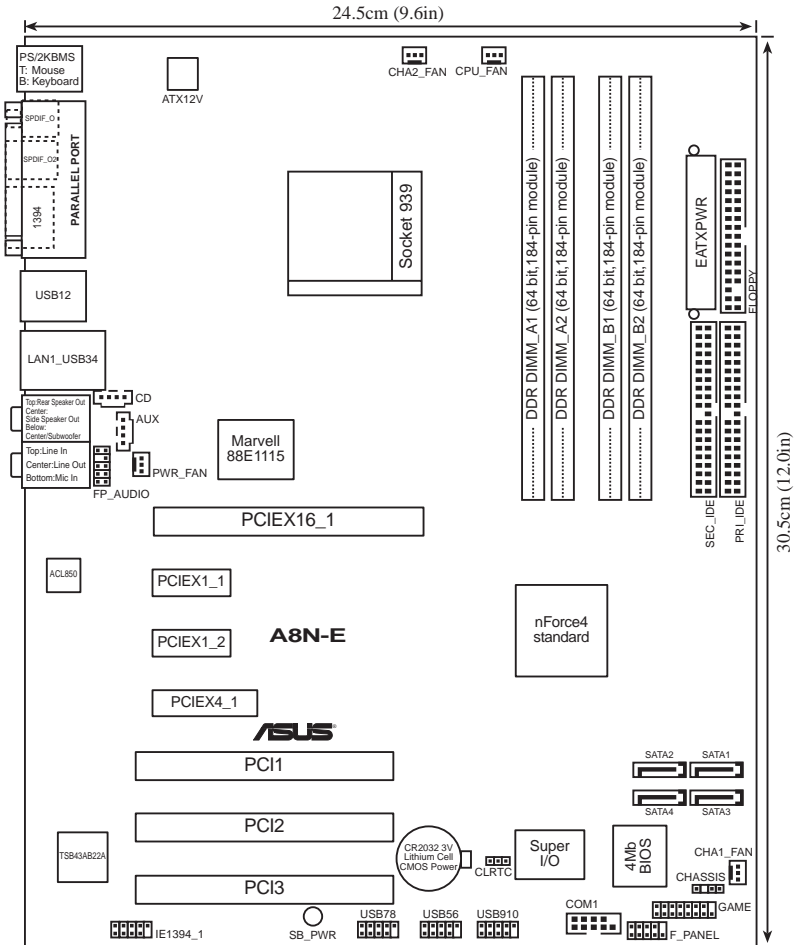

## 1.4 Central Processing Unit (CPU)

### 1.4.1 Overview

The motherboard comes with a surface mount 939-pin Zero Insertion Force (ZIF) socket designed for the AMD Athlon™ 64FX, AMD Athlon 64™ or AMD Sempron™ processor.

The 128-bit-wide data paths of these processors can run applications faster than processors with only 32-bit or 64-bit wide data paths.

Take note of the marked corner (with gold triangle) on the CPU. This mark should match a specific corner on the socket to ensure correct installation.

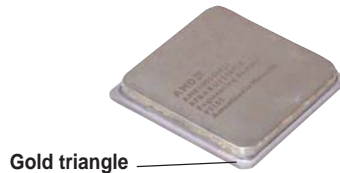

### 1.4.2 Installing the CPU

To install a CPU:

1. Locate the CPU socket on the motherboard.

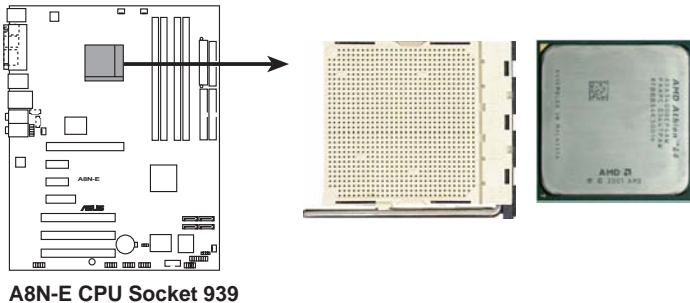

Before installing the CPU, make sure that the socket box is facing towards you and the load lever is on your left.

2. Unlock the socket by pressing the lever sideways, then lift it up to a 90°-100° angle.

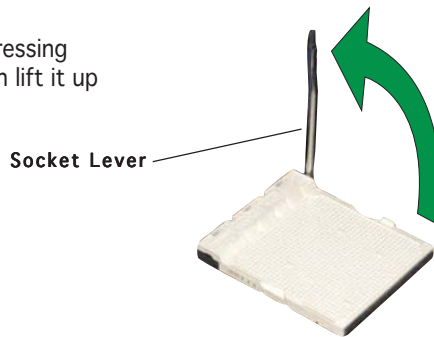

---

Make sure that the socket lever is lifted up to 90°-100° angle, otherwise the CPU does not fit in completely.

---

3. Position the CPU above the socket such that the CPU corner with the gold triangle matches the socket corner with a small triangle.
4. Carefully insert the CPU into the socket until it fits in place.

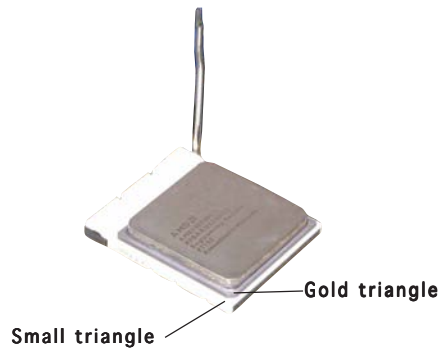

---

The CPU fits only in one correct orientation. DO NOT force the CPU into the socket to prevent bending the pins and damaging the CPU!

---

5. When the CPU is in place, push down the socket lever to secure the CPU. The lever clicks on the side tab to indicate that it is locked.



### 1.4.3 Installing the heatsink and fan

The AMD Athlon™ 64FX or AMD Athlon 64™ processor require a specially designed heatsink and fan assembly to ensure optimum thermal condition and performance.



---

Make sure that you use only qualified heatsink and fan assembly.

---

Follow these steps to install the CPU heatsink and fan.

1. Place the heatsink on top of the installed CPU, making sure that the heatsink fits properly on the retention module base.



- The retention module base is already installed on the motherboard upon purchase.
  - You do not have to remove the retention module base when installing the CPU or installing other motherboard components.
  - If you purchased a separate CPU heatsink and fan assembly, make sure that a Thermal Interface Material is properly applied to the CPU heatsink or CPU before you install the heatsink and fan assembly.
- 

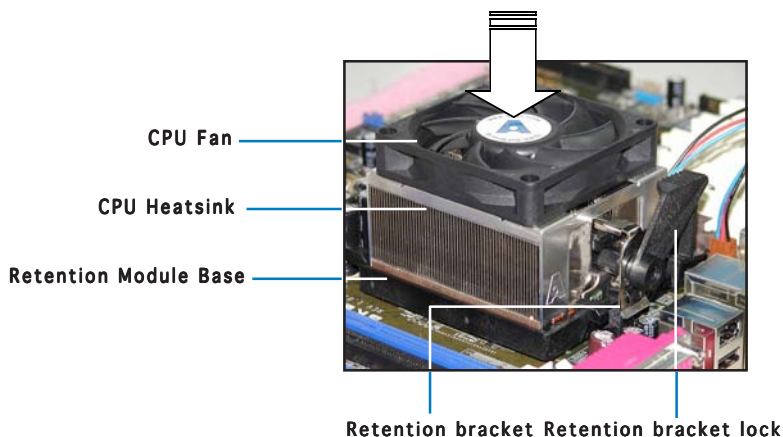

---

Your boxed CPU heatsink and fan assembly should come with installation instructions for the CPU, heatsink, and the retention mechanism. If the instructions in this section do not match the CPU documentation, follow the latter.

---

2. Attach one end of the retention bracket to the retention module base.

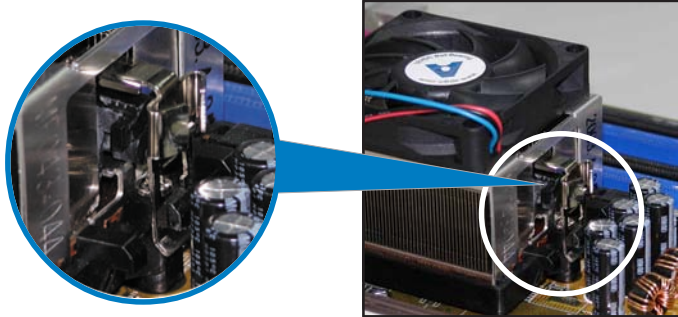

3. Align the other end of the retention bracket (near the retention bracket lock) to the retention module base. A clicking sound denotes that the retention bracket is in place.



Make sure that the fan and heatsink assembly perfectly fits the retention mechanism module base, otherwise you cannot snap the retention bracket in place.



4. Push down the retention bracket lock on the retention mechanism to secure the heatsink and fan to the module base.

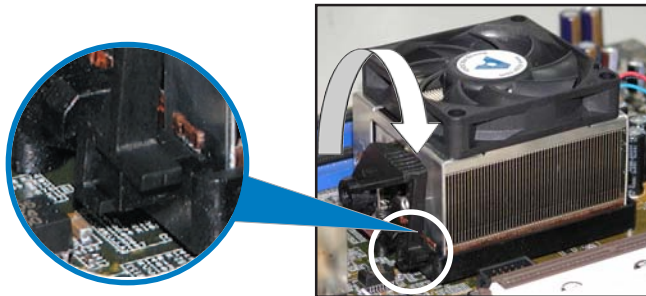

3. When the fan and heatsink assembly is in place, connect the CPU fan cable to the connector on the motherboard labeled CPU\_FAN.

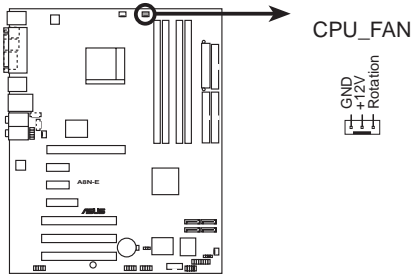

**A8N-E CPU fan connector**



---

Do not forget to connect the CPU fan connector! Hardware monitoring errors can occur if you fail to plug this connector.

---



## 1.5 System memory

### 1.5.1 Overview

The motherboard comes with four 184-pin Double Data Rate (DDR) Dual Inline Memory Modules (DIMM) sockets.

The following figure illustrates the location of the sockets:

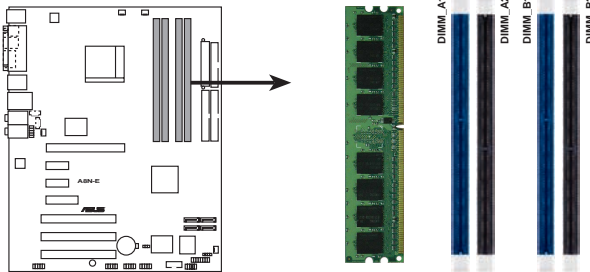

A8N-E 184-pin DDR DIMM sockets

Channel	Sockets
Channel A	DIMM_A1 and DIMM_A2
Channel B	DIMM_B1 and DIMM_B2

### 1.5.2 Memory Configurations

You may install 256 MB, 512 MB and 1 GB unbuffered or non-ECC DDR DIMMs into the DIMM sockets using the memory configurations in this section.



- For dual-channel configuration, the total size of memory module(s) installed per channel must be the same for better performance (DIMM\_A1+DIMM\_A2=DIMM\_B1+DIMM\_B2).
- When using one DDR DIMM module, install into DIMM\_B1 slot only.
- When using two DDR DIMM modules, install into DIMM\_A1 and DIMM\_B1 slots only.
- Always install DIMMs with the same CAS latency. For optimum compatibility, it is recommended that you obtain memory modules from the same vendor. Refer to the DDR400 Qualified Vendors List on the next page for details.
- Due to chipset resource allocation, the system may detect less than 4 GB of system memory when you installed four 1 GB DDR memory modules.
- Due to CPU limitation, DIMM modules with 128 Mb memory chips or double-sided x16 memory chips are not supported in this motherboard.

## DDR400 Qualified Vendors List

Size	Vendor	Model	Brand	Side(s)	Component	DIMM support		
						A	B	C
256MB	KINGSTON	KVR400X64C3A/256	Hynix	SS	HY5DU56822BT-D43	•	•	•
512MB	KINGSTON	KVR400X64C3A/512	Hynix	DS	HY5DU56822BT-D43	•	•	•
256MB	KINGSTON	KVR400X72C3A/256	Mosel	SS	V58C2256804SAT5(ECC)	•	•	•
512MB	KINGSTON	KVR400X72C3A/512	Mosel	DS	V58C2256804SAT5(ECC)	•	•	•
256MB	KINGSTON	KVR400X64C3A/256	Infineon	SS	HYB25D256800BT-5B	•	•	•
512MB	KINGSTON	KVR400X64C3A/512	Infineon	DS	HYB25D256800BT-5B	•	•	•
256MB	KINGSTON	KVR400X64C3A/256	KINGSTON	SS	D3208DL2T-5	•	•	•
512MB	KINGSTON	KVR400X64C3A/512	KINGSTON	DS	D328DIB-50	•	•	•
1024MB	KINGSTON	HYB25D512800BE-5B	N/A	DS	KVR400X64C3A/1G	•	•	•
256MB	SAMSUNG	M381L3223ETM-CCC	SAMSUNG	SS	K4H560838E-TCCC(ECC)	•	•	•
512MB	SAMSUNG	M381L6423ETM-CCC	SAMSUNG	DS	K4H560838E-TCCC(ECC)	•	•	•
256MB	SAMSUNG	M368L3223ETM-CCC	SAMSUNG	SS	K4H560838E-TCCC	•	•	•
256MB	SAMSUNG	M368L3223FTN-CCC	SAMSUNG	SS	K4H560838F-TCCC	•	•	•
512MB	SAMSUNG	M368L6423FTN-CCC	SAMSUNG	DS	K4H560838F-TCCC	•	•	•
512MB	SAMSUNG	M368L6523BTM-CCC	SAMSUNG	SS	K4H510838B-TCCC	•	•	•
256MB	MICRON	MT18VDDT3264AG-40BCB	MICRON	SS	MT46V32M8TG-5BC	•	•	•
512MB	MICRON	MT16VDDT6464AG-40BCB	MICRON	DS	MT46V32M8TG-5BC	•	•	•
256MB	Infineon	HYS64D32300HU-5-C	Infineon	SS	HYB25D256800CE-5C	•	•	•
512MB	Infineon	HYS64D64320HU-5-C	Infineon	DS	HYB25D256800CE-5C	•	•	•
256MB	CORSAIR	CMX256A-3200C2PT	Winbond	SS	W942508BH-5	•	•	•
512MB	CORSAIR	VS512MB400	VALUE seLecT	DS	VS32M8-5	•	•	•
1024MB	CORSAIR	TWINK2048-3200C2	N/A	DS	N/A	•	•	•
256MB	Hynix	HYMD232645D8J-D43	Hynix	SS	HY5DU56822DT-D43	•	•	•
512MB	Hynix	HYMD264646D8J-D43	Hynix	DS	HY5DU56822DT-D43	•	•	•

**Side(s):** SS - Single-Sided

DS - Double-Sided

### DIMM Support:

- A** - supports one module inserted into either the blue slots, in a Single-channel memory configuration.
- B** - supports on pair of modules inserted into either the blue slots or the black slots as one pair of Dual-channel memory configuration.
- C** - support for 4 modules inserted into the blue and black slots as two pairs of Dual-channel memory configuration.

### 1.5.3 Installing a DIMM



Make sure to unplug the power supply before adding or removing DIMMs or other system components. Failure to do so may cause severe damage to both the motherboard and the components.

1. Unlock a DIMM socket by pressing the retaining clips outward.
2. Align a DIMM on the socket such that the notch on the DIMM matches the break on the socket.

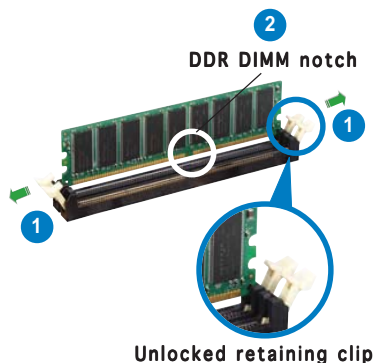

A DDR DIMM is keyed with a notch so that it fits in only one direction. DO NOT force a DIMM into a socket to avoid damaging the DIMM.

3. Firmly insert the DIMM into the socket until the retaining clips snap back in place and the DIMM is properly seated.

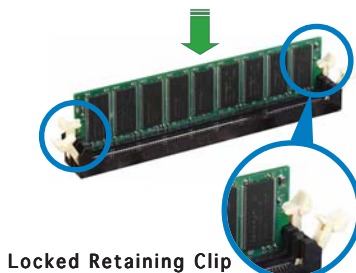

### 1.5.4 Removing a DIMM

Follow these steps to remove a DIMM.

1. Simultaneously press the retaining clips outward to unlock the DIMM.

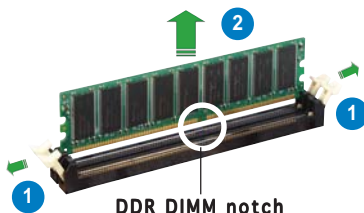

Support the DIMM lightly with your fingers when pressing the retaining clips. The DIMM might get damaged when it flips out with extra force.

2. Remove the DIMM from the socket.

## 1.6 Expansion slots

In the future, you may need to install expansion cards. The following sub-sections describe the slots and the expansion cards that they support.



---

Make sure to unplug the power cord before adding or removing expansion cards. Failure to do so may cause you physical injury and damage motherboard components.

---



---

We recommended to install the memory modules first before installing a PCI Express x16 card.

---

### 1.6.1 Installing an expansion card

To install an expansion card:

1. Before installing the expansion card, read the documentation that came with it and make the necessary hardware settings for the card.
2. Remove the system unit cover (if your motherboard is already installed in a chassis).
3. Remove the bracket opposite the slot that you intend to use. Keep the screw for later use.
4. Align the card connector with the slot and press firmly until the card is completely seated on the slot.
5. Secure the card to the chassis with the screw you removed earlier.
6. Replace the system cover.

### 1.6.2 Configuring an expansion card

After installing the expansion card, configure the it by adjusting the software settings.

1. Turn on the system and change the necessary BIOS settings, if any. See Chapter 2 for information on BIOS setup.
2. Assign an IRQ to the card. Refer to the tables on the next page.
3. Install the software drivers for the expansion card.

## 1.6.3 Interrupt assignments

### Standard interrupt assignments

IRQ	Priority	Standard Function
0	1	System Timer
1	2	Keyboard Controller
2	-	Re-direct to IRQ#9
4	12	Communications Port (COM1)*
5	13	IRQ holder for PCI steering*
6	14	Floppy Disk Controller
7	15	Printer Port (LPT1)*
8	3	System CMOS/Real Time Clock
9	4	IRQ holder for PCI steering*
10	5	IRQ holder for PCI steering*
11	6	IRQ holder for PCI steering*
12	7	PS/2 Compatible Mouse Port*
13	8	Numeric Data Processor
14	9	Primary IDE Channel
15	10	Secondary IDE Channel

\* These IRQs are usually available for ISA or PCI devices.

### IRQ assignments for this motherboard

	A	B	C	D	E	F	G	H
PCI slot 1	shared	—	—	—	—	—	—	—
PCI slot 2	—	shared	—	—	—	—	—	—
PCI slot 3	—	—	shared	—	—	—	—	—
Onboard USB 1.0 controller	shared	—	—	—	—	—	—	—
Onboard USB 2.0 controller	shared	—	—	—	—	—	—	—
Onboard LAN1	shared	—	—	—	—	—	—	—



When using PCI cards on shared slots, ensure that the drivers support “Share IRQ” or that the cards do not need IRQ assignments. Otherwise, conflicts will arise between the two PCI groups, making the system unstable and the card inoperable.

## 1.6.4 PCI slots

The PCI slots support cards such as a LAN card, SCSI card, USB card, and other cards that comply with PCI specifications. The figure shows a LAN card installed on a PCI slot.

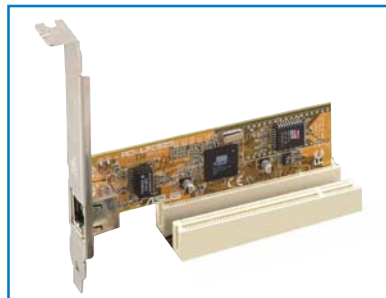

## 1.6.5 PCI Express x16 slot

This motherboard supports PCI Express x16 graphic cards that comply with the PCI Express specifications. The following figure shows a graphics card installed on the PCI Express x16 slot.

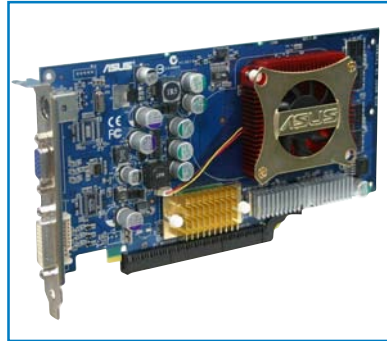

In Normal mode, only the PCI Express blue slot can be used for PCI Express x16 graphics cards. The PCI Express black slot functions as a PCI Express x1 slot.

## 1.6.6 PCI Express x1 slot

This motherboard supports PCI Express x1 network cards, SCSI cards and other cards that comply with the PCI Express specifications. The figure shows a network card installed on the PCI Express x1 slot.

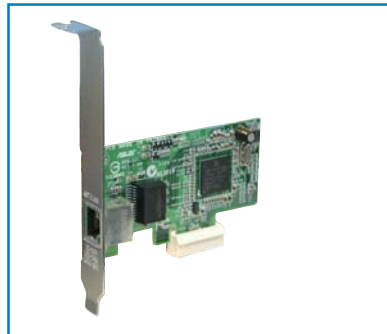

## 1.6.7 Universal PCIe slot (PCI Express x4 slot)

This motherboard provides a PCI Express x4 slot that can support PCI Express x1, x4, x8, or x16 cards. This ASUS proprietary slot allows you to use additional PCI Express cards (e.g. graphics card) for twice the speed of a PCI Express x1 slot.



The Universal PCIe slot supports a total bandwidth of 1GB/s.

## 1.7 Jumpers

### 1. Clear RTC RAM (CLRTC)

This jumper allows you to clear the Real Time Clock (RTC) RAM in CMOS. You can clear the CMOS memory of date, time, and system setup parameters by erasing the CMOS RTC RAM data. The onboard button cell battery powers the RAM data in CMOS, which include system setup information such as system passwords.

To erase the RTC RAM:

1. Turn OFF the computer and unplug the power cord.
2. Remove the onboard battery.
3. Move the jumper cap from pins 1-2 (default) to pins 2-3. Keep the cap on pins 2-3 for about 5~10 seconds, then move the cap back to pins 1-2.
4. Re-install the battery.
5. Plug the power cord and turn ON the computer.
6. Hold down the <Del> key during the boot process and enter BIOS setup to re-enter data.



Except when clearing the RTC RAM, never remove the cap on CLRTC jumper default position. Removing the cap will cause system boot failure!

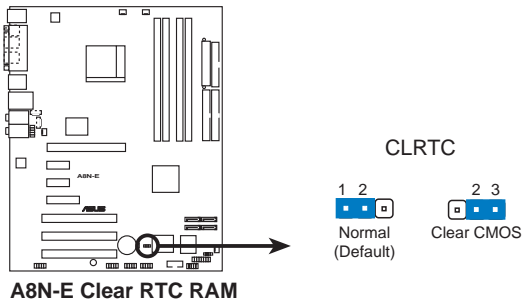

## 1.8 Connectors

### 1.8.1 Rear panel connectors

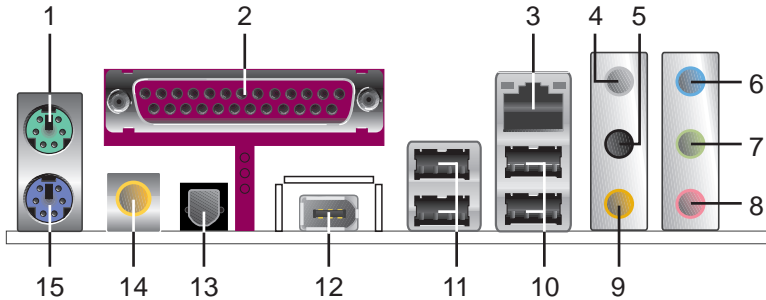

1. **PS/2 mouse port (green).** This port is for a PS/2 mouse.
2. **Parallel port.** This 25-pin port connects a parallel printer, a scanner, or other devices.
3. **LAN (RJ-45) port.** Supported by the NVIDIA® nForce™ 4 Gigabit MAC with external Marvell® PHY, this port allows Gigabit connection to a Local Area Network (LAN) through a network hub. Refer to the table below for the LAN port LED indications.

#### LAN port LED indications

ACT/LINK LED		SPEED LED	
Status	Description	Status	Description
OFF	No link	OFF	10 Mbps connection
GREEN	Linked	ORANGE	100 Mbps connection
BLINKING	Data activity	GREEN	1 Gbps connection

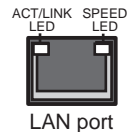

4. **Rear Speaker Out port (gray).** This port connects the rear speakers on a 4-channel, 6-channel, or 8-channel audio configuration.
5. **Side Speaker Out port (black).** This port connects the side speakers in an 8-channel audio configuration.
6. **Line In port (light blue).** This port connects the tape, CD, DVD player, or other audio sources.
7. **Line Out port (lime).** This port connects a headphone or a speaker. In 4-channel, 6-channel, and 8-channel configuration, the function of this port becomes Front Speaker Out.
8. **Microphone port (pink).** This port connects a microphone.
9. **Center/Subwoofer port (yellow orange).** This port connects the center/subwoofer speakers.





Refer to the audio configuration table below for the function of the audio ports in 2, 4, 6, or 8-channel configuration.

## Audio 2, 4, 6, or 8-channel configuration

Port	Headset 2-channel	4-channel	6-channel	8-channel
Light Blue	Line In	Line In	Line In	Line In
Lime	Line Out	Front Speaker Out	Front Speaker Out	Front Speaker Out
Pink	Mic In	Mic In	Mic In	Mic In
Gray	•	Rear Speaker Out	Rear Speaker Out	Rear Speaker Out
Black	•	•	•	Side Speaker Out
Yellow Orange	•	•	Center/Subwoofer	Center/Subwoofer

- 10. USB 2.0 ports 3 and 4.** These two 4-pin Universal Serial Bus (USB) ports are available for connecting USB 2.0 devices.
- 11. USB 2.0 ports 1 and 2.** These two 4-pin Universal Serial Bus (USB) ports are available for connecting USB 2.0 devices.
- 12. IE1394\_2 port.** This 6-pin IEEE 1394a port provides high-speed connectivity for audio/video devices, storage peripherals, PCs, or portable devices.
- 13. Optical S/PDIF Out port.** This port connects an external audio output device via an optical S/PDIF cable.
- 14. Coaxial S/PDIF Out port.** This port connects an external audio output device via a coaxial S/PDIF cable.
- 15. PS/2 keyboard port (purple).** This port is for a PS/2 keyboard.

## 1.8.2 Internal connectors

### 1. Floppy disk drive connector (34-1 pin FLOPPY)

This connector is for the provided floppy disk drive (FDD) signal cable. Insert one end of the cable to this connector, then connect the other end to the signal connector at the back of the floppy disk drive.



The Pin 5 on the connector is removed to prevent incorrect cable connection when using an FDD cable with a covered Pin 5.

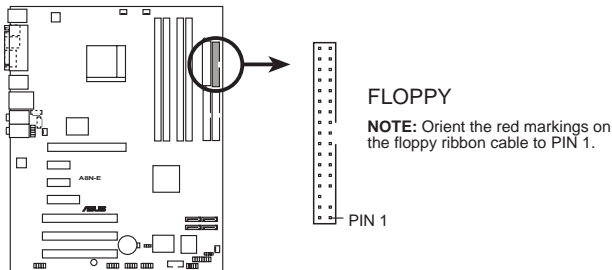

**A8N-E Floppy disk drive connector**

### 2. IDE connectors (40-1 pin PRI\_IDE, SEC\_IDE)

These connectors are for Ultra DMA 133/100/66 signal cables. The Ultra DMA 133/100/66 signal cable has three connectors: a blue connector for the primary IDE connector on the motherboard, a black connector for an Ultra DMA 133/100/66 IDE slave device (optical drive/hard disk drive), and a gray connector for an Ultra DMA 133/100/66 IDE master device (hard disk drive). If you install two hard disk drives, you must configure the second drive as a slave device by setting its jumper accordingly. Refer to the hard disk documentation for the jumper settings.



- The Pin 20 on the IDE connector is removed to match the covered hole on the Ultra DMA cable connector. This prevents incorrect insertion when you connect the IDE cable.
- Use the 80-conductor IDE cable for UltraDMA133/100/66 IDE devices.

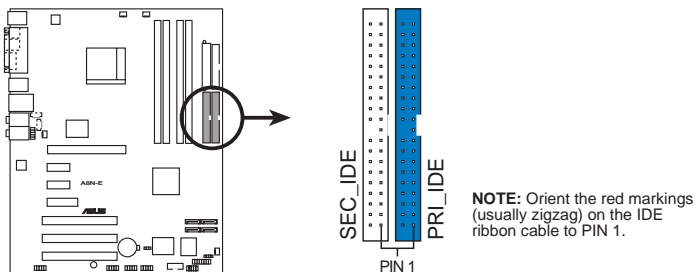

**A8N-E IDE connectors**

### 3. Serial ATA connectors (7-pin SATA1, SATA2, SATA3, SATA4)

Supported by the NVIDIA® nForce™ 4 standard chipset, these connectors are for the Serial ATA signal cables for Serial ATA hard disk drives that allows up to 1.5Gb/s of data transfer rate.

If you installed Serial ATA hard disk drives, you can create a RAID 0, RAID 1, RAID 1+0, or JBOD configuration that span across the Parallel ATA drives. Refer to Chapter 5 for details on how to set up RAID configurations.



These connectors are set to **SATA** by default. In SATA mode, you can connect Serial ATA boot or data hard disk drives to these connectors. If you intend to create a Serial ATA RAID set using these connectors, enable the RAID function of each port from the **NVRAID Configuration** sub-menu item in the BIOS. See section “2.4.3 Onboard Devices Configuration” on pages 2-24 and 2-25 for details.

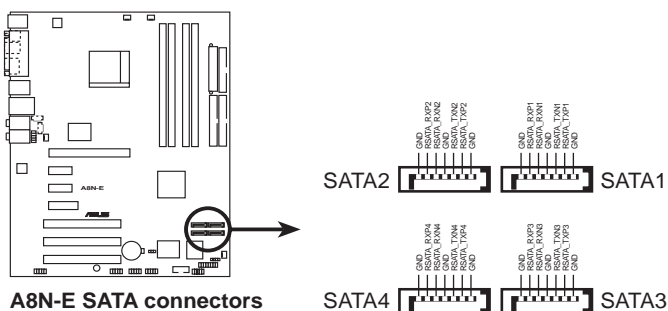

#### Important notes on Serial ATA

- The actual data transfer rate depends on the speed of Serial ATA hard disks installed.
- See Appendix for instructions on how to install the Serial ATA extension module.

#### 4. CPU, Chassis and Power fan connectors (3-pin CPU\_FAN, 3-pin CHA2\_FAN, 3-pin PWR\_FAN, 3-pin CHA1\_FAN)

The fan connectors support cooling fans of 350mA~2000mA (24 W max.) or a total of 1A~3.48A (41.76 W max.) at +12V. Connect the fan cables to the fan connectors on the motherboard, making sure that the black wire of each cable matches the ground pin of the connector.



- Do not forget to connect the fan cables to the fan connectors. Lack of sufficient air flow inside the system may damage the motherboard components. These are not jumpers! DO NOT place jumper caps on the fan connectors!
- The ASUS Q-Fan function is supported using the CPU Fan (CPU\_FAN) and Chassis Fan 1 (CHA1\_FAN) connectors only.

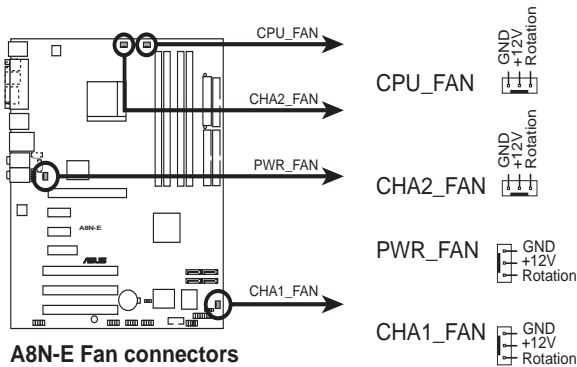

## 5. Serial port connector (10-1 pin COM1)

This connector is for a serial (COM) port. Connect the serial port module cable to this connector, then install the module to a slot opening at the back of the system chassis.

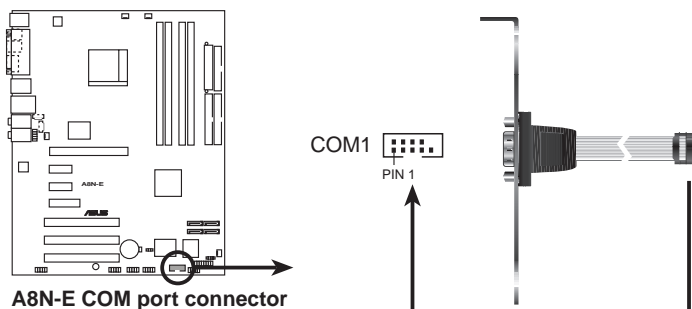

## 6. USB connectors (10-1 pin USB56, USB78, USB910)

These connectors are for USB 2.0 ports. Connect the USB/GAME module cable to any of these connectors, then install the module to a slot opening at the back of the system chassis. These USB connectors comply with USB 2.0 specification that supports up to 480 Mbps connection speed.

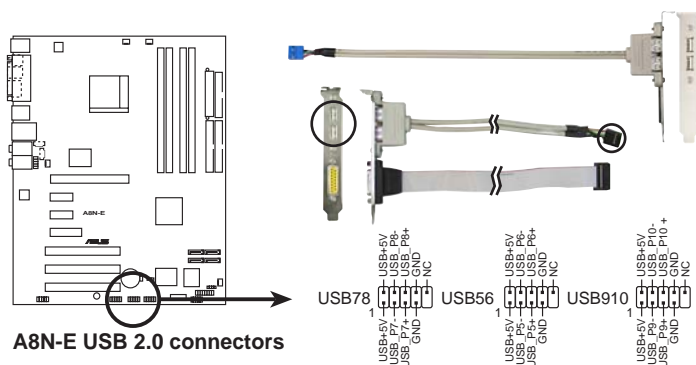

Never connect a **1394 cable** to the USB connectors. Doing so will damage the motherboard!

## 7. IEEE 1394a connector (10-1 pin IE1394\_1 [orange])

This connector is for an additional IEEE 1394a port. Connect the IEEE 1394a module cable (orange) to this connector, then install the module to a slot opening at the back of the system chassis.

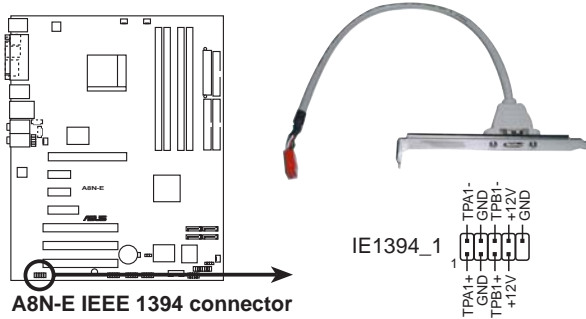

Never connect a **USB port module cable** to the IEEE 1394a connector. Doing so will damage the motherboard!

## 8. ATX power connectors (24-pin EATXPWR1, 4-pin ATX12V1)

These connectors are for an ATX power supply plugs. The power supply plugs are designed to fit these connectors in only one orientation. Find the proper orientation and push down firmly until the connectors completely fit.



- Use of a power supply unit (PSU) with a higher power output is recommended when configuring a system with more power-consuming devices. The system may become unstable or may not boot up if the power is inadequate.
- Make sure that your PSU can provide at least the minimum power required by your system.

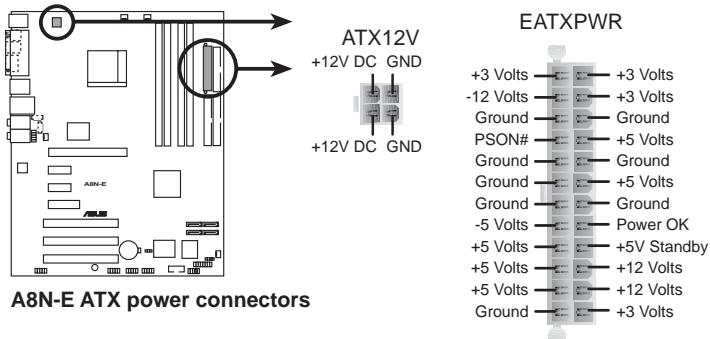

## 9. Internal audio connectors (4-pin CD, AUX)

These connectors allow you to receive stereo audio input from sound sources such as a CD-ROM, TV-tuner, or MPEG card.

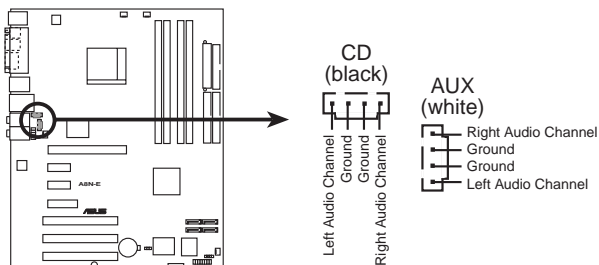

**A8N-E Internal audio connectors**



The function of these connectors are disabled under 8-channel mode.

## 10. GAME/MIDI port connector (16-1 pin GAME)

This connector is for a GAME/MIDI port. Connect the USB/GAME module cable to this connector, then install the module to a slot opening at the back of the system chassis. The GAME/MIDI port connects a joystick or game pad for playing games, and MIDI devices for playing or editing audio files.

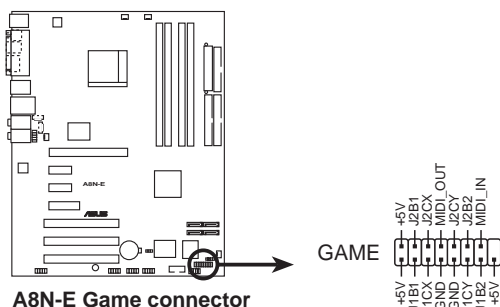

## 11. Chassis intrusion connector (4-1 pin CHASSIS)

This connector is for a chassis-mounted intrusion detection sensor or switch. Connect one end of the chassis intrusion sensor or switch cable to this connector. The chassis intrusion sensor or switch sends a high-level signal to this connector when a chassis component is removed or replaced. The signal is then generated as a chassis intrusion event.

By default, the pins labeled “Chassis Signal” and “Ground” are shorted with a jumper cap. Remove the jumper caps only when you intend to use the chassis intrusion detection feature. See related BIOS item in page 2-42.

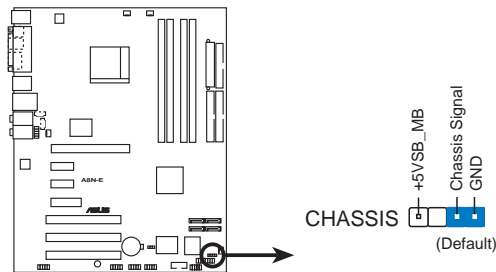

**A8N-E Chassis intrusion connector**

## 12. Front panel audio connector (10-1 pin FP\_AUDIO)

This connector is for a chassis-mounted front panel audio I/O module that supports legacy AC '97 audio standard. Connect one end of the front panel audio I/O module cable to this connector.

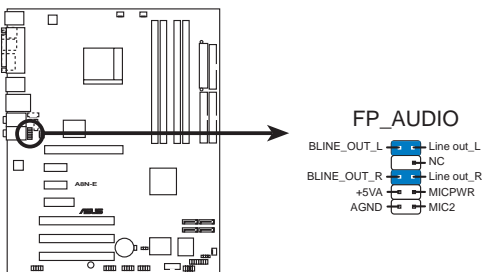

**A8N-E Front panel audio connector**



### 13. System panel connector (10-1 pin F\_PANEL1)

This connector supports several chassis-mounted functions.

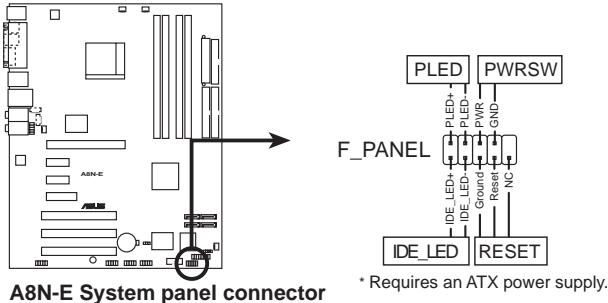

A8N-E System panel connector

- **System power LED (2-pin PLED)**  
This 2-pin connector is for the system power LED. Connect the chassis power LED cable to this connector. The system power LED lights up when you turn on the system power, and blinks when the system is in sleep mode.
- **ATX power button/soft-off button (2-pin PWRSW)**  
This connector is for the system power button. Pressing the power button turns the system on or puts the system in sleep or soft-off mode depending on the BIOS settings. Pressing the power switch for more than four seconds while the system is ON turns the system OFF.
- **Hard disk drive activity LED (2-pin IDELED)**  
This 2-pin connector is for the HDD Activity LED. Connect the HDD Activity LED cable to this connector. The IDE LED lights up or flashes when data is read from or written to the HDD.
- **Reset button (2-pin RESET)**  
This 2-pin connector is for the chassis-mounted reset button for system reboot without turning off the system power.



This chapter tells how to change the system settings through the BIOS Setup menus. Detailed descriptions of the BIOS parameters are also provided.

# BIOS setup

## 2.1 Managing and updating your BIOS

The following utilities allow you to manage and update the motherboard Basic Input/Output System (BIOS) setup.

1. **Award BIOS Flash Utility** (Updates the BIOS in DOS mode using a bootable floppy disk.)
2. **ASUS EZ Flash** (Updates the BIOS in DOS using a floppy disk.)

Refer to the corresponding sections for details on these utilities.



---

Save a copy of the original motherboard BIOS file to a bootable floppy disk in case you need to restore the BIOS in the future. Copy the original motherboard BIOS using the AwardBIOS Flash utilities.

---

### 2.1.1 Creating a bootable floppy disk

1. Do either one of the following to create a bootable floppy disk.

#### DOS environment

- a. Insert a 1.44MB floppy disk into the drive.
- b. At the DOS prompt, type `format a: /s` then press <Enter>.

#### Windows® XP environment

- a. Insert a 1.44 MB floppy disk to the floppy disk drive.
- b. Click **Start** from the Windows® desktop, then select **My Computer**.
- c. Select the 3 1/2 Floppy Drive icon.
- d. Click **File** from the menu, then select **Format. A Format 3 1/2 Floppy Disk** window appears.
- e. Select **Create an MS-DOS startup disk** from the format options field, then click **Start**.

#### Windows® 2000 environment

To create a set of boot disks for Windows® 2000:

- a. Insert a formatted, high density 1.44 MB floppy disk into the drive.
- b. Insert the Windows® 2000 CD to the optical drive.

- c. Click **Start**, then select **Run**.
  - d. From the Open field, type  
     **D:\bootdisk\makeboot a:**  
     assuming that D: is your optical drive.
  - e. Press <Enter>, then follow screen instructions to continue.
2. Copy the original or the latest motherboard BIOS file to the bootable floppy disk.

## 2.1.2 Updating the BIOS

The Basic Input/Output System (BIOS) can be updated using the AwardBIOS Flash Utility. Follow these instructions to update the BIOS using this utility.

1. Download the latest BIOS file from the Targa web site. Rename the file to **A8N-E.BIN** and save it to a floppy disk.



---

Save only the updated BIOS file in the floppy disk to avoid loading the wrong BIOS file.

---

2. Copy the AwardBIOS Flash Utility (awdfash.exe) to the floppy disk with the latest BIOS file.
3. Boot the system in DOS mode using the bootable floppy disk you created earlier.
4. When the **A:>** appears, replace the bootable floppy disk with the floppy disk containing the new BIOS file and the Award BIOS Flash Utility.
5. At the prompt, type **awdfash** then press <Enter>. The Award BIOS Flash Utility screen appears.

```

AwardBIOS Flash Utility for ASUS V1.01
(C) Phoenix Technologies Ltd. All Rights Reserved

For NF-KC804-A8N-E-00      DATE: 11/18/2004
Flash Type - SST 49LF004A/B /3.3V

File Name to Program: 

Message: Please input File Name!

```



### 2.1.3 Saving the current BIOS file

You can use the AwardBIOS Flash Utility to save the current BIOS file. You can load the current BIOS file when the BIOS file gets corrupted during the flashing process.



Make sure that the floppy disk has enough disk space to save the file.

To save the current BIOS file using the AwardBIOS Flash Utility:

1. Follow steps 1 to 6 of the previous section.
2. Press <Y> when the utility prompts you to save the current BIOS file. The following screen appears.

```
AwardBIOS Flash Utility for ASUS V1.01
(C) Phoenix Technologies Ltd. All Rights Reserved

For NF-KC804-A8N-E-00      DATE: 11/18/2004
Flash Type - SST 49LF004A/B /3.3V

File Name to Program: 1001.bin
Save current BIOS as:

Message:
```

3. Type a filename for the current BIOS file in the **Save current BIOS as** field, then press <Enter>.

```
AwardBIOS Flash Utility for ASUS V1.01
(C) Phoenix Technologies Ltd. All Rights Reserved

For NF-KC804-A8N-E-00      DATE: 11/18/2004
Flash Type - SST 49LF004A/B /3.3V

File Name to Program: 1001.bin
Checksum: DAD6H
Save current BIOS as: old.bin

Message: Please Wait!
```

4. The utility saves the current BIOS file to the floppy disk, then returns to the BIOS flashing process.

```
AwardBIOS Flash Utility for ASUS V1.01
(C) Phoenix Technologies Ltd. All Rights Reserved

For NF-KC804-A8N-E-00      DATE: 11/18/2004
Flash Type - SST 49LF004A/B /3.3V

File Name to Program: 1001.bin
Now Backup System BIOS to
File:
Message: Please Wait!
```

## 2.1.4 ASUS EZ Flash utility

The ASUS EZ Flash feature allows you to update the BIOS without having to go through the long process of booting from a floppy disk and using a DOS-based utility. The EZ Flash utility is built-in the BIOS chip so it is accessible by pressing <Alt> + <F2> during the Power-On Self Tests (POST).

To update the BIOS using EZ Flash:

1. Visit the Targa website ([www.targa-online.com](http://www.targa-online.com)) to download the latest BIOS file for the motherboard.
2. Save the BIOS file to a floppy disk, then restart the system.
3. Press <Alt> + <F2> during POST to display the following.

```
Insert Disk then press Enter or ESC to continue POST
```

4. Insert the floppy disk that contains the BIOS file to the floppy disk drive then press <Enter>. The following screen appears.

```
AwardBIOS Flash Utility for ASUS V1.01
(C) Phoenix Technologies Ltd. All Rights Reserved

For NF-KC804-A8N-E-00      DATE: 11/18/2004
Flash Type - SST 49LF004A/B /3.3V

File Name to Program: _____

Message: Please wait...
```

5. When the correct BIOS file is found, EZ Flash performs the BIOS update process and automatically reboots the system when done.



Do not shutdown or reset the system while updating the BIOS to prevent system boot failure!



## 2.2 BIOS setup program

This motherboard supports a programmable Low-Pin Count (LPC) chip that you can update using the provided utility described in section “2.1 Managing and updating your BIOS.”

Use the BIOS Setup program when you are installing a motherboard, reconfiguring your system, or prompted to “Run Setup”. This section explains how to configure your system using this utility.

Even if you are not prompted to use the Setup program, you can change the configuration of your computer in the future. For example, you can enable the security password feature or change the power management settings. This requires you to reconfigure your system using the BIOS Setup program so that the computer can recognize these changes and record them in the CMOS RAM of the LPC chip.

The LPC chip on the motherboard stores the Setup utility. When you start up the computer, the system provides you with the opportunity to run this program. Press <Del> during the Power-On Self-Test (POST) to enter the Setup utility; otherwise, POST continues with its test routines.

If you wish to enter Setup after POST, restart the system by pressing <Ctrl+Alt+Delete>, or by pressing the reset button on the system chassis. You can also restart by turning the system off and then back on. Do this last option only if the first two failed.

The Setup program is designed to make it as easy to use as possible. Being a menu-driven program, it lets you scroll through the various sub-menus and make your selections from the available options using the navigation keys.



- 
- The default BIOS settings for this motherboard apply for most conditions to ensure optimum performance. If the system becomes unstable after changing any BIOS settings, load the default settings to ensure system compatibility and stability. Select the **Load Default Settings** item under the Exit Menu. See section “2.7 Exit Menu.”
  - The BIOS setup screens shown in this section are for reference purposes only, and may not exactly match what you see on your screen.
  - Visit the Targa website ([www.targa-online.com](http://www.targa-online.com)) to download the latest BIOS file for this motherboard and .
-

## 2.2.1 BIOS menu screen

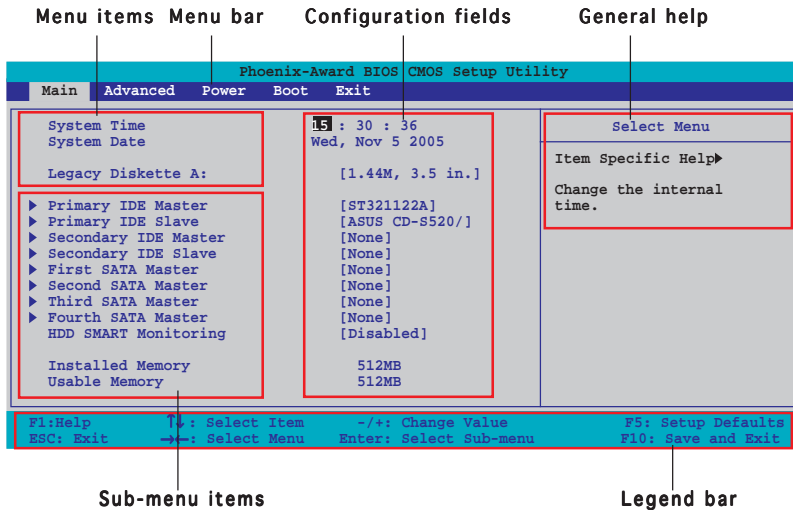

## 2.2.2 Menu bar

The menu bar on top of the screen has the following main items:

- Main** For changing the basic system configuration
- Advanced** For changing the advanced system settings
- Power** For changing the advanced power management (APM) configuration
- Boot** For changing the system boot configuration
- Exit** For selecting the exit options and loading default settings

To select an item on the menu bar, press the right or left arrow key on the keyboard until the desired item is highlighted.



- The BIOS setup screens shown in this chapter are for reference purposes only, and may not exactly match what you see on your screen.
- Visit the Targa website ([www.targa-online.com](http://www.targa-online.com)) to download the latest BIOS.

### 2.2.3 Legend bar

At the bottom of the Setup screen is a legend bar. The keys in the legend bar allow you to navigate through the various setup menus. The following table lists the keys found in the legend bar with their corresponding functions.

Navigation Key	Function
<F1>	Displays the General Help screen
<F5>	Loads setup default values
<Esc>	Exits the BIOS setup or returns to the main menu from a sub-menu
Left or Right arrow	Selects the menu item to the left or right
Up or Down arrow	Moves the highlight up or down between fields
Page Down or - (minus)	Scrolls backward through the values for the highlighted field
Page Up or + (plus)	Scrolls forward through the values for the highlighted field
<Enter>	Brings up a selection menu for the highlighted field
<F10>	Saves changes and exit

### 2.2.4 Menu items

The highlighted item on the menu bar displays the specific items for that menu. For example, selecting **Main** shows the Main menu items.

The other items (Advanced, Power, Boot, and Exit) on the menu bar have their respective menu items.

### 2.2.5 Sub-menu items

A solid triangle before each item on any menu screen means that the item has a sub-menu. To display the sub-menu, select the item and press <Enter>.

### 2.2.6 Configuration fields

These fields show the values for the menu items. If an item is user-configurable, you can change the value of the field opposite the item. You cannot select an item that is not user-configurable.

A configurable field is enclosed in brackets, and is highlighted when selected. To change the value of a field, select it then press <Enter> to display a list of options. Refer to “2.2.7 Pop-up window.”

## 2.2.7 Pop-up window

Select a menu item then press <Enter> to display a pop-up window with the configuration options for that item.

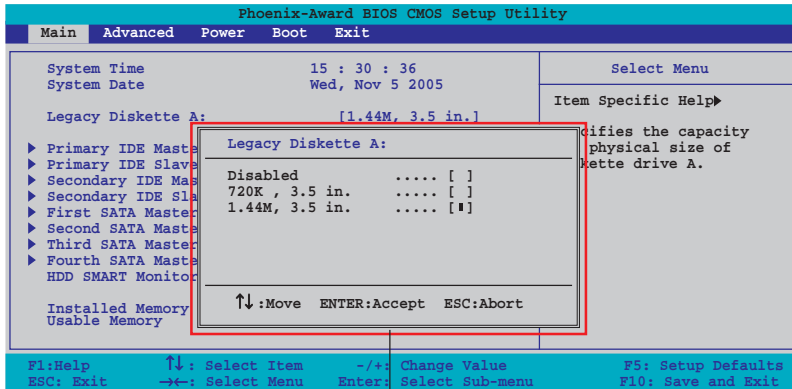

Pop-up menu

## 2.2.8 General help

At the top right corner of the menu screen is a brief description of the selected item.

## 2.3 Main menu

When you enter the BIOS Setup program, the Main menu screen appears, giving you an overview of the basic system information.



Refer to section “2.2.1 BIOS menu screen” for information on the menu screen items and how to navigate through them.

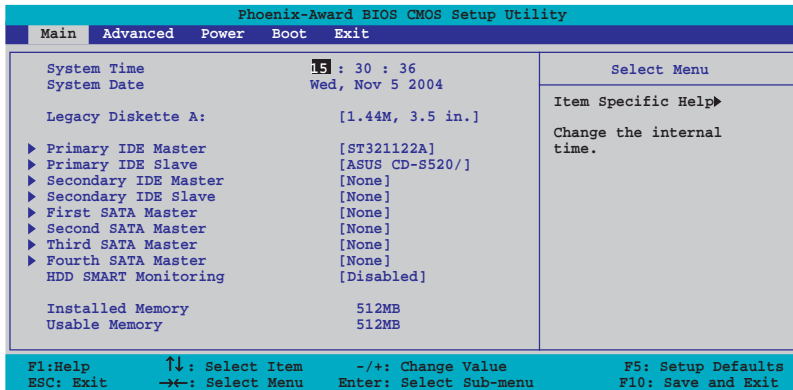

### 2.3.1 System Time [xx:xx:xxxx]

Allows you to set the system time.

### 2.3.2 System Date [Day xx/xx/xxxx]

Allows you to set the system date.

### 2.3.3 Language [English]

Allows you to choose the BIOS language version from the options.  
Configuration options: [Français] [German] [English]

### 2.3.4 Legacy Diskette A [1.44M, 3.5 in.]

Sets the type of floppy drive installed. Configuration options: [Disabled] [360K, 5.25 in.] [1.2M, 5.25 in.] [720K, 3.5 in.] [1.44M, 3.5 in.] [2.88M, 3.5 in.]

## 2.3.5 Primary and Secondary IDE Master/Slave

While entering Setup, the BIOS automatically detects the presence of IDE devices. There is a separate sub-menu for each IDE device. Select a device item then press <Enter> to display the IDE device information.

Phoenix-Award BIOS CMOS Setup Utility			
Main			
Primary IDE Master		Select Menu	
Primary IDE Master	[Auto]	Item Specific Help▶▶ Press [Enter] to select	
Access Mode	[Auto]		
Capacity	82 GB		
Cylinder	39420		
Head	16		
Sector	255		
PIO Mode	[Auto]		
UDMA Mode	[Auto]		
Transfer Mode	UDMA 6		
F1:Help	↑↓: Select Item	-/+ : Change Value	F5: Setup Defaults
ESC: Exit	→←: Select Menu	Enter: Select Sub-menu	F10: Save and Exit

The BIOS automatically detects the values opposite the dimmed items (Capacity, Cylinder, Head, Sector and Transfer Mode). These values are not user-configurable. These items show N/A if no IDE device is installed in the system.

### PIO Mode

Sets the PIO mode for the IDE device.

Configuration options: [Auto] [Mode 0] [Mode 1] [Mode 2] [Mode 3] [Mode 4]

### UDMA Mode

Disables or sets the UDMA mode. Configuration options: [Disabled] [Auto]

### IDE Primary Master/Slave [Auto]; IDE Secondary Master/Slave [Auto]

Select [Auto] to automatically detect an IDE hard disk drive. If automatic detection is successful, the BIOS automatically fills in the correct values for the remaining fields on this sub-menu. If the hard disk was already formatted on a previous system, the setup BIOS may detect incorrect parameters. Select [Manual] to manually enter the IDE hard disk drive parameters. If no drive is installed select [None].

Configuration options: [None] [Auto] [Manual]

## Access Mode [Auto]

The default [Auto] allows automatic detection of an IDE hard disk drive. Select [CHS] for this item if you set the IDE Primary Master/Slave to [Manual]. Configuration options: [CHS] [LBA] [Large] [Auto]



---

Before attempting to configure a hard disk drive, make sure you have the correct configuration information supplied by the drive manufacturer. Incorrect settings may cause the system to fail to recognize the installed hard disk.

---

## Capacity

Displays the auto-detected hard disk capacity. This item is not configurable.

## Cylinder

Shows the number of the hard disk cylinders. This item is not configurable.

## Head

Shows the number of the hard disk read/write heads. This item is not configurable.

## Sector

Shows the number of sectors per track. This item is not configurable.

## Transfer Mode

Shows the Transfer mode. This item is not configurable.



---

After entering the IDE hard disk drive information into BIOS, use a disk utility, such as FDISK, to partition and format new IDE hard disk drives. This is necessary so that you can write or read data from the hard disk. Make sure to set the partition of the Primary IDE hard disk drives to active.

---

## 2.3.6 First, Second, Third, Fourth SATA Master

While entering Setup, the BIOS automatically detects the presence of Serial ATA devices. There is a separate sub-menu for each SATA device. Select a device item then press <Enter> to display the SATA device information.

Phoenix-Award BIOS CMOS Setup Utility			
Main			
Primary IDE Master		Select Menu	
Extended IDE Drive	[Auto]	Item Specific Help▶▶ Selects the type of fixed disk connected to the system.	
Access Mode	[Auto]		
Capacity	0 MB		
Cylinder	0		
Head	0		
Precomp	0		
Landing Zone	0		
Sector	0		
F1:Help	↑↓: Select Item	-/+ : Change Value	F5: Setup Defaults
ESC: Exit	→←: Select Menu	Enter: Select Sub-menu	F10: Save and Exit

The BIOS automatically detects the values opposite the dimmed items (Capacity, Cylinder, Head, Precomp, Landing Zone and Sector). These values are not user-configurable. These items show 0 if no SATA device is installed in the system.

### Extended Drive

Selects the type of fixed disk connected to the system.

Configuration options: [None] [Auto]

### Access Mode

Sets the sector addressing mode. Configuration options: [Large] [Auto]



Before attempting to configure a hard disk drive, make sure you have the correct configuration information supplied by the drive manufacturer. Incorrect settings may cause the system to fail to recognize the installed hard disk.

### Capacity

Displays the auto-detected hard disk capacity. This item is not configurable.

### Cylinder

Shows the number of the hard disk cylinders. This item is not configurable.



## Head

Shows the number of the hard disk read/write heads. This item is not configurable.

## Precomp

Shows the number of precomp per track. This item is not configurable.

## Landing Zone

Shows the number of landing zone per track. This item is not configurable.

## Sector

Shows the number of sectors per track. This item is not configurable.



---

After entering the IDE hard disk drive information into BIOS, use a disk utility, such as FDISK, to partition and format new IDE hard disk drives. This is necessary so that you can write or read data from the hard disk. Make sure to set the partition of the Primary IDE hard disk drives to active.

---

## 2.3.7 HDD SMART Monitoring

Allows you to enable or disable the HDD Self-Monitoring Analysis and Reporting Technology (SMART) feature.  
Configuration options: [Disabled] [Enabled]

## 2.3.8 Installed Memory

Shows the size of installed memory.

## 2.4 Advanced menu

The Advanced menu items allow you to change the settings for the CPU and other system devices.



Take caution when changing the settings of the Advanced menu items. Incorrect field values can cause the system to malfunction.

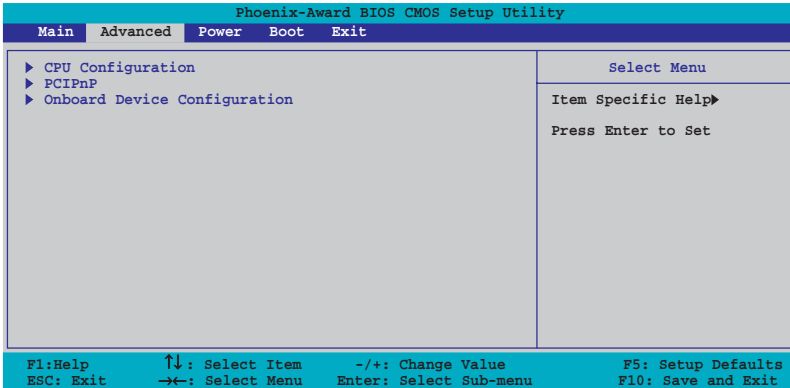

### 2.4.1 CPU Configuration

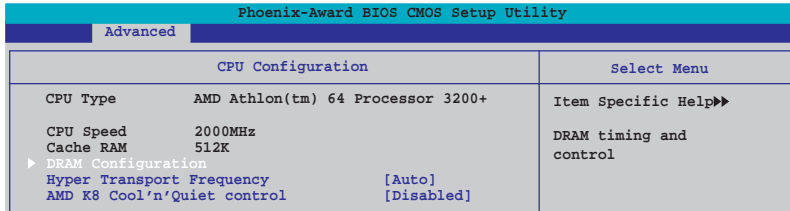

## DRAM Configuration

The items in this sub-menu show the DRAM-related information auto-detected by the BIOS.

Phoenix-Award BIOS CMOS Setup Utility	
Advanced	
DRAM Configuration	Select Menu
Timing Mode	[Auto]
x Memclock index value (Mhz)	166Mhz
x CAS# latency (Tcl)	2.5
x Min RAS# active time (Tras)	7T
x RAS# to CAS# delay (Trcd)	3T
x Row precharge Time (Trp)	3T
x Row cycle Time (Trc)	10T
x Row refresh cyc Time (Trfc)	12T
x Read-to Write Time (Trwt)	4T
x Write Recovery Time (Twr)	3T
x 1T/2T Memory Timing	2T
S/W DRAM Over 4C Remapping	[Enabled]
	Item Specific Help▶▶▶
	<Enter> to select DRAM configuration by Auto] is recommended. [Manual] allows you to set each configuration on your own.

### Timing Mode [Auto]

Configuration options: [Auto] [Manual]



The following items are user-configurable only when Timing Mode item is set to [Manual].

### Memclock index value (Mhz) [200Mhz]

Set DRAM Frequency. Configuration options: [100Mhz] [133Mhz] [166Mhz][200Mhz]

### CAS# latency (Tcl) [3]

Set the latency between the DRAM command and the time the data actually becomes available. Configuration options: [2.0] [2.5] [3.0]

### Min RAS# active time (Tras) [8T]

Controls the number of DRAM clocks used for DRAM parameters. Configuration options: [5] [6] [7] [8] [9] [10] [11] [12] [13] [14] [15]

### RAS# to CAS# delay (Trcd) [3T]

Controls the latency between the DRAM active command and the R/W command. Configuration options: [2] [3] [4] [5] [6] [7]

Row precharge Time (Trp) [3T]

Controls the idle clocks after issuing a precharge command to the DRAM. Configuration options: [2] [3] [4] [5] [6][7]

Row cycle Time (Trc) [11T]

Set Row cycle timing. Configuration options: [7] [8] [9] [10] [11] [12] [13] [14] [15] [16][17][18] [19] [20] [21] [22]

Row refresh cyc Time (Trfc) [14T]

Set Row refresh cycle timing. Configuration options: [9] [10] [11] [12] [13] [14] [15] [16][17][18] [19] [20] [21] [22] [23] [24]

Read-to-Write Time (Trwt) [5T]

Set Write to Read delay timing. Configuration options: [1] [2] [3] [4] [5] [6]

Write Recovery time (Twr) [3T]

Set Write Recovery timing. Configuration options: [2] [3]

1T/2T Memory Timing [2T]

Select DRAM commands and adress will be driven for 1 clock or 2 clock cycles. 2 clock cycles should only be set with unbuffered DIMMs. Configuration options: [Auto] [1T] [2T]

S/W DRAM Over 4G Remapping [Enabled]

When 4G or More DRAM is installed. Memory block just below 4GB and move it to above 4GB. Thus All 4GB can be used for OS supporting PAE. Otherwise, some memory range are reserved for PCI. Configuration options: [Disabled] [Enabled]

## **Hyper Transport Frequency [Auto]**

Sets the Hyper Transport frequency. Configuration options: [Auto] [1x] [2x] [3x] [4x] [5x] [Auto]

## **AMD K8 Cool'n'Quiet control [Auto]**

Enables or disables the AMD Cool 'n' Quiet! technology. Configuration options: [Disabled] [Enabled]

## 2.4.2 PCIPnP

Phoenix-Award BIOS CMOS Setup Utility		
Advanced		
PCIPnP		Select Menu
Plug & Play O/S	[No]	Item Specific Help▶▶▶
Primary Display Adapter	[PCI]	
Resources Controlled By x IRQ Resources	[Auto]	Select Yes if you are using a Plug and Play capable operating system Select No if

### Plug & Play O/S [No]

When set to [No], the BIOS configures all the devices in the system. When set to [Yes] and if you install a Plug and Play operating system, the operating system configures the Plug and Play devices not required for boot. Configuration options: [No] [Yes]

### Resources Controlled By [Auto]

When set to [Auto], the BIOS automatically configures all the boot and Plug and Play compatible devices. Set to [Manual] if you want to assign the IRQ DMA and memory base address fields.

Configuration options: [Auto] [Manual]



When the item Resources Controlled By is set to [Auto], the item IRQ Resources is grayed out and not user-configurable. Refer to the section "IRQ Resources" for information on how to enable this item.

### IRQ Resources

This sub-menu is activated only when the **Resources Controlled By** item is set to Manual.

Phoenix-Award BIOS CMOS Setup Utility		
Advanced		
IRQ Resources		Select Menu
IRQ-3 assigned to	[PCI Device]	Item Specific Help▶▶▶
IRQ-4 assigned to	[PCI Device]	
IRQ-5 assigned to	[PCI Device]	Legacy ISA for devices compliant with the original PC AT bus specification, PCI/ISA
IRQ-7 assigned to	[PCI Device]	PnP for devices compliant with the
IRQ-9 assigned to	[PCI Device]	
IRQ-10 assigned to	[PCI Device]	
IRQ-11 assigned to	[PCI Device]	
IRQ-12 assigned to	[PCI Device]	
IRQ-14 assigned to	[PCI Device]	
IRQ-15 assigned to	[PCI Device]	

#### *IRQ-xx assigned to*

When set to [PCI Device], the specific IRQ is free for use of PCI/PnP devices. When set to [Reserved], the IRQ is reserved for legacy ISA devices. Configuration options: [PCI Device] [Reserved]

## PCI/VGA Palette Snoop [Disabled]

When set to [Enabled], the palette snooping feature informs the PCI devices that an ISA graphics device is installed in the system so that the latter can function correctly. Configuration options: [Disabled] [Enabled]

### 2.4.3 Onboard Devices Configuration

Phoenix-Award BIOS CMOS Setup Utility	
Advanced	
Onboard Device Configuration	Select Menu
▶ IDE Function Setup	Item Specific Help▶▶
▶ NVRAID Configuration	Press [Enter] to set.
▶ USB Configuration	
Onboard NV LAN	[Enabled]
Onboard LAN Boot ROM	[Disabled]
AC97 Audio	[Enabled]
PCI IEEE 1394a	[Enabled]
Serial Port1 Address	[3F8/IRQ4]
Parallel Port Address	[378/IRQ7]
Parallel Port Mode	[ECP+EPP]
ECP Mode Use DMA	[3]
Game Port Address	[201]

F1: Help      ↑↓: Select Item      -/+ : Change Value      F5: Setup Defaults  
ESC: Exit      →←: Select Menu      Enter: Select Sub-menu      F10: Save and Exit

## IDE Function Setup

This sub-menu contains IDE function-related items. Select an item then press <Enter> to edit.

Phoenix-Award BIOS CMOS Setup Utility		
Advanced		
Onboard Device Configuration	Select Menu	
OnChip IDE Channel0	<b>[Enabled]</b>	Item Specific Help▶▶
OnChip IDE Channel1	[Enabled]	Disable/Enable OnChip
IDE DMA transfer access	[Enabled]	IDE Channel0
SATA Port 1, 2	[Enabled]	
SATA DMA transfer	[Enabled]	
SATA Port 3, 4	[Enabled]	
SATA2 DMA transfer	[Enabled]	
IDE Prefetch Mode	[Enabled]	

## OnChip IDE Channel0 [Enabled]

Allows you to enable or disable the onchip IDE channel 0 controller .  
Configuration options: [Disabled] [Enabled]

## OnChip IDE Channel1 [Enabled]

Allows you to enable or disable the onchip IDE channel 1 controller .  
Configuration options: [Disabled] [Enabled]

## IDE DMA transfer access [Enabled]

Allows you to enable or disable the IDE DMA transfer access.  
Configuration options: [Disabled] [Enabled]

## SATA Port 1, 2 [Enabled]

Allows you to enable or disable the SATA 1 and 2 ports.  
Configuration options: [Disabled] [Enabled]

## SATA DMA access [Enabled]

Allows you to enable or disable the SATA DMA transfer access.  
Configuration options: [Disabled] [Enabled]

## SATA Port 3, 4 [Enabled]

Allows you to enable or disable the SATA 3 and 4 ports.  
Configuration options: [Disabled] [Enabled]

## SATA2 DMA transfer [Enabled]

Allows you to enable or disable the SATA2 DMA transfer access.  
Configuration options: [Disabled] [Enabled]

## IDE Prefetch Mode [Enabled]

Allows you to enable or disable the IDE prefetch mode.  
Configuration options: [Disabled] [Enabled]

## NVRAID Configuration

This sub-menu contains NVRAID function-related items. Select an item then press <Enter> to edit.

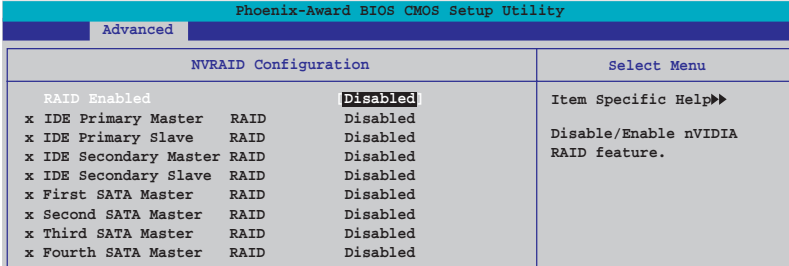

The screenshot shows the Phoenix-Award BIOS CMOS Setup Utility. The 'Advanced' menu is selected. The 'NVRAID Configuration' sub-menu is displayed, showing the following options:

NVRAID Configuration				Select Menu
RAID Enabled			<b>Disabled</b>	Item Specific Help▶▶
x IDE Primary Master	RAID		Disabled	Disable/Enable nVIDIA
x IDE Primary Slave	RAID		Disabled	RAID feature.
x IDE Secondary Master	RAID		Disabled	
x IDE Secondary Slave	RAID		Disabled	
x First SATA Master	RAID		Disabled	
x Second SATA Master	RAID		Disabled	
x Third SATA Master	RAID		Disabled	
x Fourth SATA Master	RAID		Disabled	

## RAID Enabled [Disabled]

Enables or disables the onboard RAID controller. When Enabled, the succeeding items becomes user-configurable.  
Configuration options: [Enabled] [Disabled]

## IDE Primary, Secondary Master/Slave RAID [Disabled]

Enables or disables the RAID function of the primary or secondary master or slave IDE. Configuration options: [Enabled] [Disabled]

## First, Second, Third, Fourth SATA Master RAID [Disabled]

Enables or disables the RAID function of the first, second, third or fourth SATA master drive. Configuration options: [Enabled] [Disabled]

## USB Configuration

The items in this menu allows you to change the USB-related features. Select an item then press <Enter> to display the configuration options.

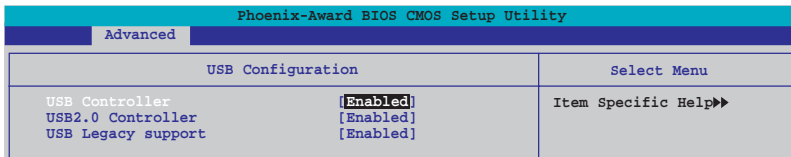

## USB Controller [Enabled]

Allows you to enable or disable the onchip USB controller. Configuration options: [Disabled] [Enabled]

## USB 2.0 Controller [Enabled]

Allows you to enable or disable the USB 2.0 controller. Configuration options: [Disabled] [Enabled]

## USB Legacy Support [Enabled]

Allows you to enable or disable support for USB devices on legacy operating systems (OS). Configuration options: [Disabled] [Enabled]

## Onboard NV LAN [Enabled]

Enables or disables the onboard NVIDIA® Gigabit LAN controller. Configuration options: [Enabled] [Disabled]

## OnBoard LAN Boot ROM [Disabled]

Allows you to enable or disable the onboard LAN boot ROM. Configuration options: [Disabled] [Enabled]

## AC97 Audio [Enabled]

Allows you to disable or enabled the onboard AC97 audio controller. Configuration options: [Disabled] [Enabled]



### **Serial Port1 Address [3F8/IRQ4]**

Allows you to select the Serial Port1 base address.

Configuration options: [Disabled] [3F8/IRQ4] [3E8/IRQ4] [2E8/IRQ3]

### **Parallel Port Address [378/IRQ7]**

Allows you to select the Parallel Port base addresses.

Configuration options: [Disabled] [378/IRQ7] [278/IRQ5] [3BC/IRQ7]

### **Parallel Port Mode [ECP+EPP]**

Allows you to select the Parallel Port mode.

Configuration options: [Normal] [Bi-directional] [EPP] [ECP]

### **ECP Mode Use DMA [3]**

Allows selection of ECP Mode. Configuration options: [1] [3]

### **Game Port Address [201]**

Allows you to select the Game Port address or to disable the port.

Configuration options: [Disabled] [201] [209]

### **Midi Port Address [Disabled]**

Allows you to select the Game Port address or to disable the port.

Configuration options: [Disabled] [330] [300]

### **Midi Port IRQ [10]**

Allows you to set the Midi port IRQ address. Configuration options: [5] [10]

## 2.5 Power menu

The Power menu items allow you to change the settings for the Advanced Configuration and Power Interface (ACPI) and the Advanced Power Management (APM). Select an item then press <Enter> to display the configuration options.

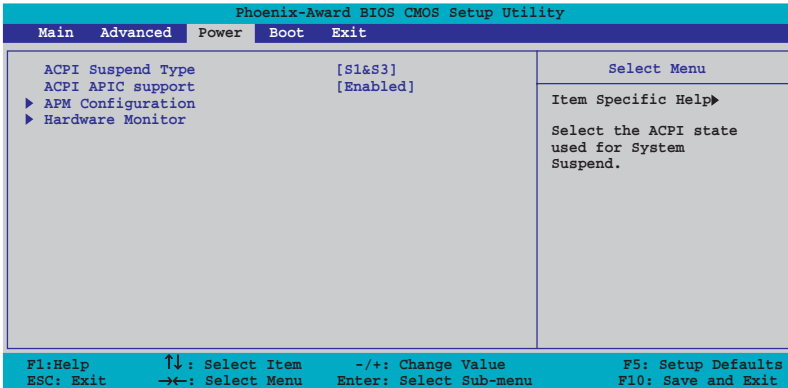

### 2.5.1 ACPI Suspend Type [S1&S3]

Allows you to select the Advanced Configuration and Power Interface (ACPI) state to be used for system suspend.

Configuration options: [S1 (POS)] [S3(STR)] [S1&S3]

### 2.5.2 ACPI APIC Support [Enabled]

Allows you to enable or disable the Advanced Configuration and Power Interface (ACPI) support in the Application-Specific Integrated Circuit (ASIC). When set to Enabled, the ACPI APIC table pointer is included in the RSDT pointer list. Configuration options: [Disabled] [Enabled]

## 2.5.3 APM Configuration

Phoenix-Award BIOS CMOS Setup Utility		
Power		
APM Configuration		Select Menu
Restore on AC Power Loss	[Disabled]	Item Specific Help▶▶
PWR Button < 4 secs	[Instant Off]	
Power On By PCI Devices	[Disabled]	
Power On By External Modems	[Disabled]	
Power-On by RTC Alarm	[Disabled]	
x Date (of Month)	0	
x Time (hh:mm:ss)	0 : 0	
Power Up By PS/2 Mouse	[Disabled]	Press [ENTER] to select whether or not to restart the system after AC power loss.
Power Up By PS/2 Keyboard	[Disabled]	

F1: Help	↑↓: Select Item	-/+ : Change Value	F5: Setup Defaults
ESC: Exit	→←: Select Menu	Enter: Select Sub-menu	F10: Save and Exit

### Restore on AC Power Loss [Disabled]

Allows you to enable or disable the Restore on AC Power Loss function. Configuration options: [Disabled] [Enabled]

### PWR Button < 4 secs [Instant-Off]

Allows you to set the event after the power button is pressed for more than 4 seconds. Configuration options: [Suspend] [Instant-Off]

### Power On By PCI Devices [Disabled]

When set to [Enabled], this parameter allows you to turn on the system through a PCI LAN or modem card. This feature requires an ATX power supply that provides at least 1A on the +5VSB lead. Configuration options: [Disabled] [Enabled]

### Power On By External Modems [Disabled]

This allows either settings of [Enabled] or [Disabled] for powering up the computer when the external modem receives a call while the computer is in Soft-off mode. Configuration options: [Disabled] [Enabled]



The computer cannot receive or transmit data until the computer and applications are fully running. Thus, connection cannot be made on the first try. Turning an external modem off and then back on while the computer is off causes an initialization string that turns the system power on.

### **Power On By RTC Alarm [Disabled]**

Allows you to enable or disable RTC to generate a wake event. When this item is set to Enabled, the items Date of Month Alarm and Time (hh:mm:ss) Alarm items become user-configurable with set values.

Configuration options: [Disabled] [Enabled]

### **Day of Month Alarm [Disabled]**

To set the date of alarm, highlight this item and press <Enter> to display the Day of Month Alarm pop-up menu. Key-in a value within the specified range then press <Enter>. Configuration options: [Min=0] [Max=31]

### **Time (hh:mm:ss) Alarm [Disabled]**

To set the time of alarm:

1. Highlight this item and press <Enter> to display a pop-up menu for the hour field.
2. Key-in a value (Min=0, Max=23), then press <Enter>.
3. Press <TAB> to move to the minutes field then press <Enter>.
4. Key-in a minute value (Min=0, Max=59), then press <Enter>.
5. Press <TAB> to move to the seconds field then press <Enter>.
6. Key-in a value (Min=0, Max=59), then press <Enter>.

### **Power Up By PS/2 Mouse [Disabled]**

When set to [Enabled], this parameter allows you to use the PS/2 mouse to turn on the system. This feature requires an ATX power supply that provides at least 1A on the +5VSB lead.

Configuration options: [Disabled] [Enabled]

### **Power On By PS/2 Keyboard [Disabled]**

Allows you to disable the Power On by PS/2 keyboard function or set specific keys on the PS/2 keyboard to turn on the system. This feature requires an ATX power supply that provides at least 1A on the +5VSB lead.

Configuration options: [Disabled] [Space Bar] [Ctrl-ESC] [Power Key]

## 2.5.4 Hardware Monitor

The items in this sub-menu displays the hardware monitor values automatically detected by the BIOS. It also allows you to change CPU Q-Fan feature-related parameters. Select an item then press <Enter> to display the configuration options.

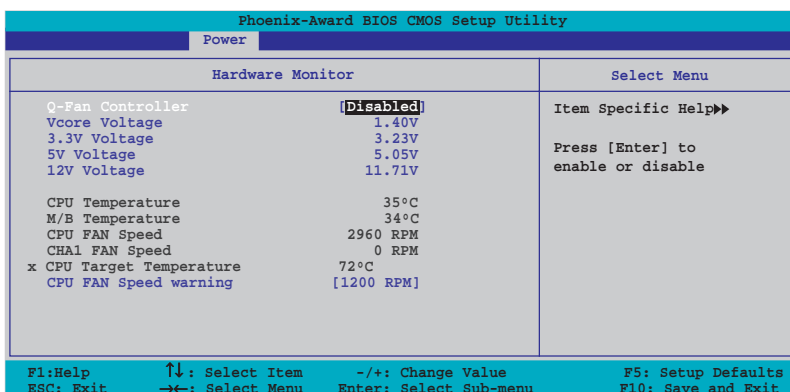

### Q-Fan Controller [Disabled]

Allows you to enable or disable the Q-Fan controller.  
Configuration options: [Disabled] [Enabled]

### VCORE Voltage, +12V Voltage, 3.3V Voltage, 5VCC Voltage

The onboard hardware monitor automatically detects the voltage output through the onboard voltage regulators. These items are not user-configurable.

### CPU Temperature, M/B Temperature

The onboard hardware monitor automatically detects and displays the motherboard and CPU temperatures. These items are not user-configurable.

## CPU Target Temperature

Allows you to set the temperature threshold before the CPU fan rotates at full speed. Configuration options: [51°C] [54°C] [57°C] [60°C] [63°C] [66°C] [69°C] [72°C] [75°C] [78°C] [81°C]

## 2.6 Boot menu

The Boot menu items allow you to change the system boot options. Select an item then press <Enter> to display the sub-menu.

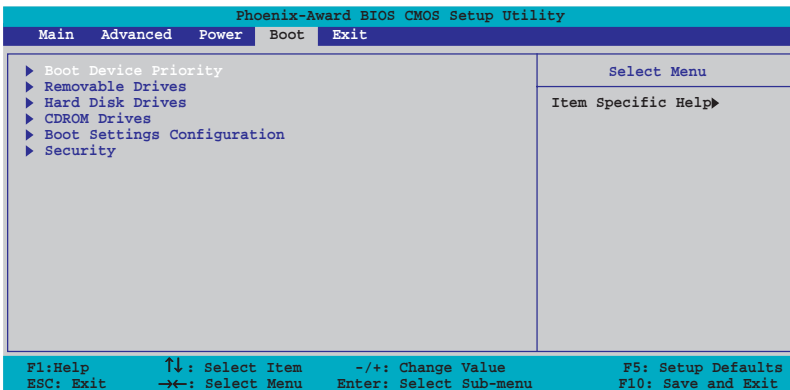

### 2.6.1 Boot Device Priority

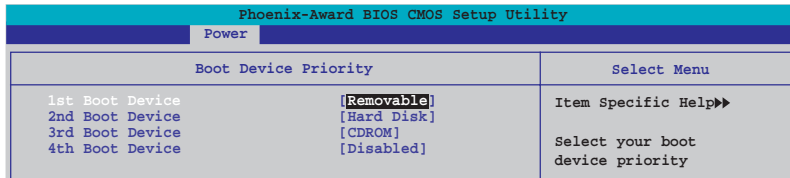

#### 1st ~ xxth Boot Device [Removable]

These items specify the boot device priority sequence from the available devices. The number of device items that appears on the screen depends on the number of devices installed in the system.

Configuration options: [Removable] [Hard Disk] [CDROM] [Legacy LAN] [Disabled]

## 2.6.2 Removable Drives

Phoenix-Award BIOS CMOS Setup Utility	
Boot	
Removable Drives	Select Menu
1. Floppy Disks	Item Specific Help▶▶

### 1. Floppy Disks

Allows you to assign a removable drive attached to the system.

## 2.6.3 Hard Disk Drives

Phoenix-Award BIOS CMOS Setup Utility	
Boot	
Hard Disk Drives	Select Menu
1. 1st Master: XXXXXXXXX 2. Bootable Add-in Cards	Item Specific Help▶▶

### 1. 1st Master: XXXXXXXXX

Allows you to assign hard disk drives attached to the system.

## 2.6.4 CDROM Drives

Phoenix-Award BIOS CMOS Setup Utility	
Boot	
CDROM Drives	Select Menu
1. 1st Slave: XXXXXXXXX	Item Specific Help▶▶

### 1. 1st Slave: XXXXXXXXX

Allows you to assign optical drives attached to the system.

## 2.6.5 Boot Settings Configuration

Phoenix-Award BIOS CMOS Setup Utility			
Boot			
Boot Settings Configuration		Select Menu	
Case Open Warning	[Enabled]	Item Specific Help▶  Press [Enter] to enable or disable.	
Quick Boot	[Enabled]		
Boot Up Floppy Seek	[Enabled]		
Bootup Num-Lock	[On]		
Typematic Rate Setting	[Disabled]		
x Typematic Rate (Chars/Sec)	6		
x Typematic Delay (Msec)	250		
OS Select For DRAM > 64MB	[Non-OS2]		
Full Screen LOGO	[Enabled]		
Halt On	[All Errors]		
F1:Help	↑↓: Select Item	-/+ : Change Value	F5: Setup Defaults
ESC: Exit	→←: Select Menu	Enter: Select Sub-menu	F10: Save and Exit

### Case Open Warning [Enabled]

Enables or disables the chassis open status feature. Setting to Enabled, clears the chassis open status. Refer to section “2.7 Internal connectors” for setting details. Configuration options: [Disabled] [Enabled]

### Quick Boot [Enabled]

Allows you to enable or disable the system quick boot feature. When Enabled, the system skips certain tests while booting. Configuration options: [Disabled] [Enabled]

### Boot Up Floppy Seek [Enabled]

Enables or disables the chassis open status feature. Setting to Enabled, clears the chassis open status. Configuration options: [Disabled] [Enabled]

### Bootup Num-Lock [On]

Allows you to select the power-on state for the NumLock. Configuration options: [Off] [On]

### Typematic Rate Setting [Disabled]

Allows you to set the keystroke rate. Enable this item to configure the **Typematic Rate (Chars/Sec)** and the **Typematic Delay (Msec)**. Configuration options: [Disabled] [Enabled]



The items **Typematic Rate (Chars/Sec)** and **Typematic Delay (Msec)** becomes user-configurable only when the item Typematic Rate Setting is enabled.



### Typematic Rate (Chars/Sec) [6]

Allows you to select the rate at which a character repeats when you hold a key. Configuration options: [6] [8] [10] [12] [15] [20] [24] [30]

### Typematic Delay (Msec) [250]

Allows you to set the delay before keystrokes begin to repeat. Configuration options: [250] [500] [750] [1000]

### OS Select for DRAM > 64MB [Non-OS2]

Set this item to OS2 only when you are running on an OS/2 operating system with an installed RAM of greater than 64 KB. Configuration options: [Non-OS2] [OS2]

### Full Screen LOGO [Enabled]

Allows you to enable or disable the full screen logo display feature. Configuration options: [Disabled] [Enabled]

### Halt On [All Errors]

Allows you to error report type. Configuration options: [All Errors] [No Errors] [All, But Keyboard] [All, But Diskette] [All, But Disk/Key]

## 2.6.6 Security

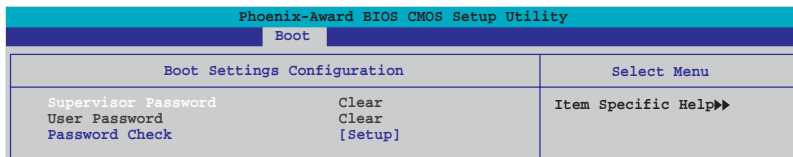

Phoenix-Award BIOS CMOS Setup Utility	
Boot	
Boot Settings Configuration	Select Menu
Supervisor Password	Clear
User Password	Clear
Password Check	[Setup]
	Item Specific Help▶▶

### Supervisor Password User Password

These fields allow you to set passwords:

To set a password:

1. Select an item then press <Enter>.
2. Type in a password using a combination of a maximum of eight (8) alpha-numeric characters, then press <Enter>.

3. When prompted, confirm the password by typing the exact characters again, then press <Enter>. The password field setting is changed to Set.

To clear the password:

1. Select the password field and press <Enter> twice. The following message appears:

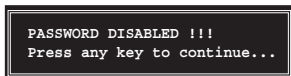

```
PASSWORD DISABLED !!!  
Press any key to continue...
```

2. Press any key to continue. The password field setting is changed to Clear.

#### **A note about passwords**

The Supervisor password is required to enter the BIOS Setup program preventing unauthorized access. The User password is required to boot the system preventing unauthorized use.

#### **Forgot your password?**

If you forget your password, you can clear it by erasing the CMOS Real Time Clock (RTC) RAM. The RAM data containing the password information is powered by the onboard button cell battery. If you need to erase the CMOS RAM, refer to section “2.6 Jumpers” for instructions.

### **Password Check**

This field requires you to enter the password before entering the BIOS setup or the system. Select [Setup] to require the password before entering the BIOS Setup. Select [System] to require the password before entering the system. Configuration options: [Setup] [System]

## 2.7 Exit menu

The Exit menu items allow you to load the optimal or failsafe default values for the BIOS items, and save or discard your changes to the BIOS items.

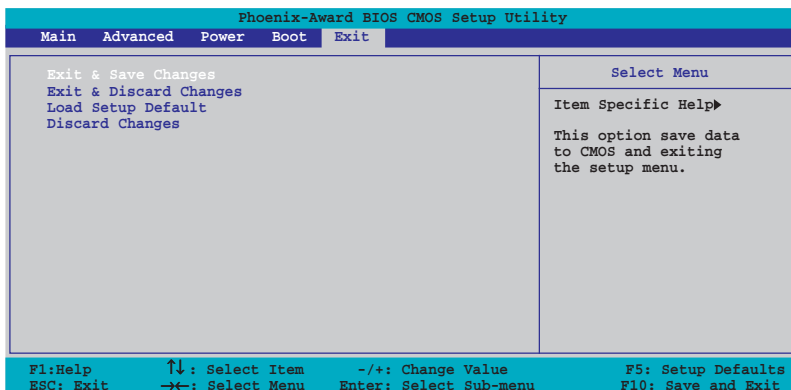

Pressing <Esc> does not immediately exit this menu. Select one of the options from this menu or <F10> from the legend bar to exit.

### Exit & Save Changes

Once you are finished making your selections, choose this option from the Exit menu to ensure the values you selected are saved to the CMOS RAM. An onboard backup battery sustains the CMOS RAM so it stays on even when the PC is turned off. When you select this option, a confirmation window appears. Select **Yes** to save changes and exit.



If you attempt to exit the Setup program without saving your changes, the program prompts you with a message asking if you want to save your changes before exiting. Press <Enter> to save the changes while exiting.

### Exit & Discard Changes

Select this option only if you do not want to save the changes that you made to the Setup program. If you made changes to fields other than System Date, System Time, and Password, the BIOS asks for a confirmation before exiting.

## Load Setup Defaults

This option allows you to load the default values for each of the parameters on the Setup menus. When you select this option or if you press <F5>, a confirmation window appears. Select **Yes** to load default values. Select **Exit & Save Changes** or make other changes before saving the values to the non-volatile RAM.

## Discard Changes

This option allows you to discard the selections you made and restore the previously saved values. After selecting this option, a confirmation appears. Select **Yes** to discard any changes and load the previously saved values.

## Free Manuals Download Website

<http://myh66.com>

<http://usermanuals.us>

<http://www.somanuals.com>

<http://www.4manuals.cc>

<http://www.manual-lib.com>

<http://www.404manual.com>

<http://www.luxmanual.com>

<http://aubethermostatmanual.com>

Golf course search by state

<http://golfingnear.com>

Email search by domain

<http://emailbydomain.com>

Auto manuals search

<http://auto.somanuals.com>

TV manuals search

<http://tv.somanuals.com>