

M2N68-AM SE2



Motherboard

E4438

First Edition V1

January 2009

Copyright © 2009 ASUSTeK Computer Inc. All Rights Reserved.

No part of this manual, including the products and software described in it, may be reproduced, transmitted, transcribed, stored in a retrieval system, or translated into any language in any form or by any means, except documentation kept by the purchaser for backup purposes, without the express written permission of ASUSTeK Computer Inc. ("ASUS").

Product warranty or service will not be extended if: (1) the product is repaired, modified or altered, unless such repair, modification or alteration is authorized in writing by ASUS; or (2) the serial number of the product is defaced or missing.

ASUS PROVIDES THIS MANUAL "AS IS" WITHOUT WARRANTY OF ANY KIND, EITHER EXPRESS OR IMPLIED, INCLUDING BUT NOT LIMITED TO THE IMPLIED WARRANTIES OR CONDITIONS OF MERCHANTABILITY OR FITNESS FOR A PARTICULAR PURPOSE. IN NO EVENT SHALL ASUS, ITS DIRECTORS, OFFICERS, EMPLOYEES OR AGENTS BE LIABLE FOR ANY INDIRECT, SPECIAL, INCIDENTAL, OR CONSEQUENTIAL DAMAGES (INCLUDING DAMAGES FOR LOSS OF PROFITS, LOSS OF BUSINESS, LOSS OF USE OR DATA, INTERRUPTION OF BUSINESS AND THE LIKE), EVEN IF ASUS HAS BEEN ADVISED OF THE POSSIBILITY OF SUCH DAMAGES ARISING FROM ANY DEFECT OR ERROR IN THIS MANUAL OR PRODUCT.

SPECIFICATIONS AND INFORMATION CONTAINED IN THIS MANUAL ARE FURNISHED FOR INFORMATIONAL USE ONLY, AND ARE SUBJECT TO CHANGE AT ANY TIME WITHOUT NOTICE, AND SHOULD NOT BE CONSTRUED AS A COMMITMENT BY ASUS. ASUS ASSUMES NO RESPONSIBILITY OR LIABILITY FOR ANY ERRORS OR INACCURACIES THAT MAY APPEAR IN THIS MANUAL, INCLUDING THE PRODUCTS AND SOFTWARE DESCRIBED IN IT.

Products and corporate names appearing in this manual may or may not be registered trademarks or copyrights of their respective companies, and are used only for identification or explanation and to the owners' benefit, without intent to infringe.

Contents

Notices.....	v
Safety information	vi
About this guide	vi
M2N68-AM SE2 specifications summary.....	viii

Chapter 1: Product introduction

1.1	Before you proceed	1-1
1.2	Motherboard overview	1-2
	1.2.1 Motherboard layout	1-2
	1.2.2 Layout contents.....	1-2
1.3	Central Processing Unit (CPU)	1-3
1.4	System memory	1-3
	1.4.1 Overview	1-3
	1.4.2 Memory configurations.....	1-4
1.5	Expansion slots.....	1-6
	1.5.1 Installing an expansion card	1-6
	1.5.2 Configuring an expansion card	1-7
	1.5.3 PCI slot	1-7
	1.5.4 PCI Express x1 slot.....	1-7
	1.5.5 PCI Express x16 slot.....	1-7
1.6	Jumpers	1-7
1.7	Connectors	1-9
	1.7.1 Rear panel ports	1-9
	1.7.2 Internal connectors	1-10
1.8	Software support.....	1-15
	1.8.1 Installing an operating system	1-15
	1.8.2 Support DVD information	1-15

Chapter 2: BIOS information

2.1	Managing and updating your BIOS	2-1
	2.1.1 ASUS Update utility	2-1
	2.1.2 ASUS EZ Flash 2 utility.....	2-2
	2.1.3 ASUS CrashFree BIOS 3 utility	2-3
2.2	BIOS setup program	2-4

Contents

2.3	Main menu	2-4
2.3.1	System Time	2-4
2.3.2	System Date	2-4
2.3.3	IDE Configuration.....	2-5
2.3.4	Primary IDE Master/Slave.....	2-5
2.3.5	SATA 1-2.....	2-6
2.3.6	System Information.....	2-6
2.4	Advanced menu	2-7
2.4.1	JumperFree Configuration	2-7
2.4.2	CPU Configuration	2-9
2.4.3	Chipset.....	2-10
2.4.4	Onboard Devices Configuration.....	2-11
2.4.5	PCI PnP	2-11
2.4.6	USB Configuration	2-11
2.5	Power menu.....	2-12
2.5.1	Suspend Mode.....	2-12
2.5.2	ACPI 2.0 Support	2-12
2.5.3	ACPI APIC Support.....	2-13
2.5.4	APM Configuration.....	2-13
2.5.5	Hardware Monitor	2-13
2.6	Boot menu	2-14
2.6.1	Boot Device Priority	2-14
2.6.2	Boot Settings Configuration	2-14
2.6.3	Security	2-15
2.7	Tools menu	2-16
2.7.1	ASUS EZ Flash 2.....	2-16
2.8	Exit menu.....	2-16

Notices

Federal Communications Commission Statement

This device complies with Part 15 of the FCC Rules. Operation is subject to the following two conditions:

- This device may not cause harmful interference, and
- This device must accept any interference received including interference that may cause undesired operation.

This equipment has been tested and found to comply with the limits for a Class B digital device, pursuant to Part 15 of the FCC Rules. These limits are designed to provide reasonable protection against harmful interference in a residential installation. This equipment generates, uses and can radiate radio frequency energy and, if not installed and used in accordance with manufacturer's instructions, may cause harmful interference to radio communications. However, there is no guarantee that interference will not occur in a particular installation. If this equipment does cause harmful interference to radio or television reception, which can be determined by turning the equipment off and on, the user is encouraged to try to correct the interference by one or more of the following measures:

- Reorient or relocate the receiving antenna.
- Increase the separation between the equipment and receiver.
- Connect the equipment to an outlet on a circuit different from that to which the receiver is connected.
- Consult the dealer or an experienced radio/TV technician for help.



The use of shielded cables for connection of the monitor to the graphics card is required to assure compliance with FCC regulations. Changes or modifications to this unit not expressly approved by the party responsible for compliance could void the user's authority to operate this equipment.

Canadian Department of Communications Statement

This digital apparatus does not exceed the Class B limits for radio noise emissions from digital apparatus set out in the Radio Interference Regulations of the Canadian Department of Communications.

This class B digital apparatus complies with Canadian ICES-003.



DO NOT throw the motherboard in municipal waste. This product has been designed to enable proper reuse of parts and recycling. This symbol of the crossed out wheeled bin indicates that the product (electrical and electronic equipment) should not be placed in municipal waste. Check local regulations for disposal of electronic products.



DO NOT throw the mercury-containing button cell battery in municipal waste. This symbol of the crossed out wheeled bin indicates that the battery should not be placed in municipal waste.

Safety information

Electrical safety

- To prevent electric shock hazard, disconnect the power cable from the electric outlet before relocating the system.
- When adding or removing devices to or from the system, ensure that the power cables for the devices are unplugged before the signal cables are connected. If possible, disconnect all power cables from the existing system before you add a device.
- Before connecting or removing signal cables from the motherboard, ensure that all power cables are unplugged.
- Seek professional assistance before using an adapter or extension cord. These devices could interrupt the grounding circuit.
- Ensure that your power supply is set to the correct voltage in your area. If you are not sure about the voltage of the electrical outlet you are using, contact your local power company.
- If the power supply is broken, do not try to fix it by yourself. Contact a qualified service technician or your retailer.

Operation safety

- Before installing the motherboard and adding devices on it, carefully read all the manuals that came with the package.
- Before using the product, ensure that all cables are correctly connected and the power cables are not damaged. If you detect any damage, contact your dealer immediately.
- To avoid short circuits, keep paper clips, screws, and staples away from connectors, slots, sockets, and circuitry.
- Avoid dust, humidity, and temperature extremes. Do not place the product in any area where it may become wet.
- Place the product on a flat and stable surface.
- If you encounter technical problems with the product, contact a qualified service technician or your retailer.

About this guide

This user guide contains the information you need when installing and configuring the motherboard.

How this guide is organized

This guide contains the following parts:

- **Chapter 1: Product introduction**
This chapter describes the features of the motherboard and the new technology it supports.
- **Chapter 2: BIOS information**
This chapter tells how to change system settings through the BIOS setup menus. Detailed descriptions of the BIOS parameters are also provided.

Conventions used in this guide

To ensure that you perform certain tasks properly, take note of the following symbols used throughout this manual.



DANGER/WARNING: Information to prevent injury to yourself when trying to complete a task.



CAUTION: Information to prevent damage to the components when trying to complete a task.



IMPORTANT: Instructions that you **MUST** follow to complete a task.



NOTE: Tips and additional information to help you complete a task.

Where to find more information

Refer to the following sources for additional information and for product and software updates.

1. ASUS websites

The ASUS website provides updated information on ASUS hardware and software products.

2. Optional documentation

Your product package may include optional documentation, such as warranty flyers, that may have been added by your dealer. These documents are not part of the standard package.

Typography

Bold text

Indicates a menu or an item to select.

Italics

Used to emphasize a word or a phrase.

<Key>

Keys enclosed in the less-than and greater-than sign means that you must press the enclosed key.

Example: <Enter> means that you must press the Enter or Return key.

<Key1>+<Key2>+<Key3>

If you must press two or more keys simultaneously, the key names are linked with a plus sign (+).

Example: <Ctrl>+<Alt>+<D>

Command

Means that you must type the command exactly as shown, then supply the required item or value enclosed in brackets. Example: At the DOS prompt, type the command line:

```
afudos /i [filename]
```

```
afudos /iM2NAMSE2.ROM
```

M2N68-AM SE2 specifications summary

CPU	AMD® Socket AM2+ / AM2 for AMD Phenom™ FX / Phenom / Athlon™ / Sempron™ processors AMD Cool 'n' Quiet™ Technology AMD64 architecture enables simultaneous 32-bit and 64-bit computing
Chipset	NVIDIA® GeForce 7025/nForce 630a (MCP68 SE)
System bus	2000 / 1600MT/s
Memory	Dual-channel memory architecture 2 x 240-pin DIMM slots support unbuffered ECC and non-ECC DDR2 1066/800/667MHz memory modules Supports up to 4GB system memory * DDR2 1066 is supported by AM2+ CPU only. Refer to www.asus.com for the AM2+ CPU models. ** Refer to www.asus.com for the latest Memory QVL (Qualified Vendors List). *** When you install a total memory of 4GB or more, Windows® 32-bit operating system may only recognize less than 3GB. Hence, a total installed memory of less than 3GB is recommended if you are using a Windows 32-bit operating system.
Graphics	Integrated programmable Shader model 3.0 DirectX 9 graphics processor Maximum shared memory of 256MB Supports RGB with max. resolution 1920 x 1440 @ 75MHz*32bpp
Expansion slots	1 x PCIe x16 slot 1 x PCIe x1 slot 1 x PCI slot
Storage	1 x UltraDMA 133/100/66 connector 2 x Serial ATA 3Gb/s connectors support RAID 0, 1, and JBOD configurations on Windows® Vista OS
Audio	ALC662 High Definition Audio 6-channel CODEC Supports Jack-detect and Multi-streaming
USB	Supports up to 10 USB 2.0/1.1 ports (6 ports at mid-board, 4 ports at the back panel)
LAN	Realtek RTL8201CP Phy 10/100 LAN

(continued on the next page)

M2N68-AM SE2 specifications summary

ASUS special features	ASUS Quiet Thermal Solution <ul style="list-style-type: none">- ASUS Q-Fan ASUS EZ DIY <ul style="list-style-type: none">- ASUS CrashFree BIOS3- ASUS EZ Flash2 ASUS MyLogo2
Back panel I/O ports	1 x PS/2 Keyboard port 1 x PS/2 Mouse port 1 x RJ45 port 1 x VGA port 4 x USB 2.0/1.1 ports 6-channel audio I/O ports 1 x COM port
Internal I/O connectors	3 x USB 2.0/1.1 connectors support additional 6 USB 2.0/1.1 ports 1 x IDE connector 2 x SATA connectors 1 x system panel connector 1 x CD audio-in connector 1 x Internal speaker connector 1 x Front panel audio connector 1 x CPU fan connector 1 x 24-pin EATX power connector 1 x 4-pin ATX 12V power connector
BIOS	8Mb Flash ROM, AMI BIOS, PnP, DMI2.0, WfM2.0, ACPI2.0, SM BIOS 2.5
Accessories	1 x Serial ATA cable 1 x UltraDMA 133/100/66 cable 1 x IO shield User Manual
Form Factor	MicroATX form factor: 9.6 in x 8.0 in
Support DVD	Drivers ASUS Update ASUS PC Probe II Anti-Virus software (OEM version)

**Specifications are subject to change without notice.*

Chapter 1

Product introduction

Thank you for buying an ASUS® M2N68-AM SE2 motherboard!

Before you start installing the motherboard, and hardware devices on it, check the items in your motherboard package. Refer to page ix for the list of accessories.



If any of the items is damaged or missing, contact your retailer.

1.1 Before you proceed

Take note of the following precautions before you install motherboard components or change any motherboard settings.



- Unplug the power cord from the wall socket before touching any component.
 - Before handling components, use a grounded wrist strap or touch a safely grounded object or a metal object, such as the power supply case, to avoid damaging them due to static electricity
 - Hold components by the edges to avoid touching the ICs on them.
 - Whenever you uninstall any component, place it on a grounded antistatic pad or in the bag that came with the component.
 - Before you install or remove any component, switch off the ATX power supply and detach its power cord. Failure to do so may cause severe damage to the motherboard, peripherals, or components.
-

Onboard LED

This motherboard comes with a standby power LED that lights up to indicate that the system is ON, in sleep mode, or in soft-off mode. This is a reminder that you must shut down the system and unplug the power cable before removing or plugging in any motherboard component. The illustration below shows the location of the onboard LED.

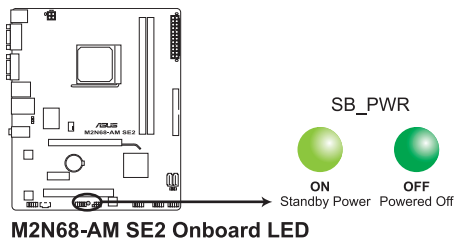

1.2 Motherboard overview

1.2.1 Motherboard layout



Ensure that you install the motherboard into the chassis in the correct orientation. The edge with external ports goes to the rear part of the chassis.

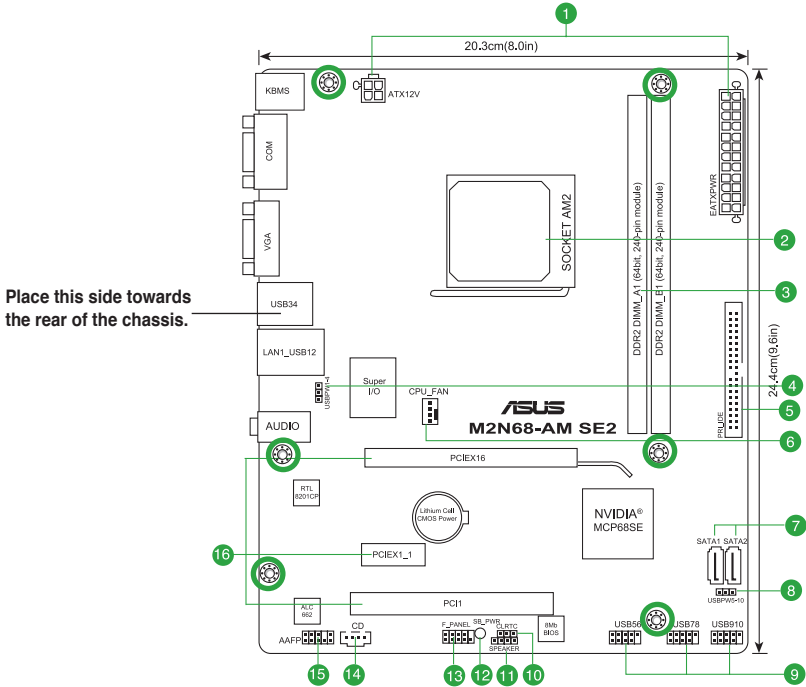

Place six screws into the holes indicated by circles to secure the motherboard to the chassis. DO NOT overtighten the screws! Doing so can damage the motherboard.

1.2.2 Layout contents

Connectors/Jumpers/Slots/LED	Page	Connectors/Jumpers/Slots/LED	Page
1. ATX power connectors (24-pin EATXPWR, 4-pin ATX12V)	1-13	9. USB connectors (10-1 pin USB56, USB 78, USB910)	1-12
2. AM2 CPU Socket	1-3	10. Clear RTC RAM (3-pin CLRTC)	1-7
3. DDR2 DIMM slots	1-3	11. Internal speaker connector (4-pin SPEAKER)	1-13
4. Keyboard/mouse power (3-pin PS2_USBPW 1-4)	1-9	12. Standby power LED (SB_PWR)	1-1
5. IDE connector (40-1 pin PRI_IDE)	1-11	13. System panel connector (10-1 pin F_PANEL)	1-14
6. CPU fan connector (4-pin CPU_FAN)	1-12	14. Optical drive audio connector (4-pin CD)	1-11
7. Serial ATA connectors (7-pin SATA1, SATA2)	1-10	15. Front panel audio connector (10-1 pin AAFP)	1-14
8. USB device wake-up (3-pin USBPW 5-10)	1-8	16. PCIe x16/PCIe x1/PCI slots	1-7

1.3 Central Processing Unit (CPU)

This motherboard comes with a 940-pin AM2+ / AM2 socket designed for AMD® Phenom™ FX / Phenom™ / Athlon™ / Sempron™ processors.



The AM2+ / AM2 socket has a different pinout from the 940-pin socket designed for the AMD Opteron™ processor. Use a CPU that is designed for the AM2+ / AM2 socket.

1.4 System memory

1.4.1 Overview

This motherboard comes with two Double Data Rate 2 (DDR2) Dual Inline Memory Modules (DIMM) sockets. A DDR2 DIMM has the same physical dimensions as a DDR DIMM but has a 240-pin footprint compared to the 184-pin DDR DIMM. DDR2 DIMMs are notched differently to prevent installation on a DDR DIMM socket. The figure illustrates the location of the DDR2 DIMM sockets:

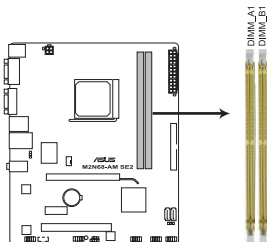

M2N68-AM SE2 240-pin DDR2 DIMM sockets

Channel	Sockets
Channel A	DIMM_A1
Channel B	DIMM_B1

1.4.2 Memory configurations

You may install 256MB, 512MB, 1GB, and 2GB unbuffered ECC and non-ECC DDR2 DIMMs into the DIMM sockets.



-
- You may install varying memory sizes in Channel A and Channel B. The system maps the total size of the lower-sized channel for the dual-channel configuration. Any excess memory from the higher-sized channel is then mapped for the single-channel operation.
 - Always install DIMMs with the same CAS latency. For optimum compatibility, we recommend that you obtain memory modules from the same vendor.
 - Due to the memory address limitation on the 32-bit Windows® OS, when you install 4GB or more memory on the motherboard, the actual usable memory for the OS can be about 3GB or less. For effective use of memory, we recommend that you do either of the following:
 - Install a maximum of 3GB system memory if you are using a 32-bit Windows® OS.
 - Use a 64-bit Windows® OS if you want to install 4GB or more memory on the motherboard.
 - This motherboard does not support DIMMs made up of 256 megabits (Mb) chips or less.
-



This motherboard supports up to 4GB memory modules on Windows® XP Professional x64 and Vista x64 editions. You may install a maximum of 2GB DIMMs on each slot.

M2N68-AM SE2 Motherboard Qualified Vendors List (QVL)

DDR2-667MHz capability

Vendor	Part No.	Size	SS/ DS	CL	Chip No.	Chip Brand	DIMM support	
							A*	B*
Kingston	KVR667D2N5/512	512MB	SS	N/A	SQ1237650821 SBP D6408TR4CGL25 USL074905PECNB	Kingston	*	*
Qimonda	HYS64T64000EU-3S-B2	512MB	SS	5	HYB18T512B00B2F3SFSS28171	Qimonda	*	*
Micron	MT8HTF12864AY-667E1	1G	SS	5	D9HNL 7ZE17	Micron	*	*
HY	HYMP512U64CP8-Y5 AB	1G	DS	5	HY5PS12521CFP-Y5	Hynix	*	*
Apacer	AU512E667C5KBGC	512MB	SS	5	AM4B5708GQJUS7E06332F	Apacer	*	*
Transcend	506010-4894	1G	DS	5	E5108AJBG-6E-E	Elpida	*	*
ADATA	M2OAD5G3H3160Q1C52	512MB	SS	N/A	AD29608A8A-3EG20813	ADATA	*	*
ADATA	M2OAD5G314170Q1C58	1G	DS	N/A	AD29608A8A-3EG80814	ADATA	*	*
ADATA	M2OAD5H3J4170H1C53	2G	DS	N/A	AD20908A8A-3EG 30724	ADATA	*	*
PSC	AL6E8E63J-6E1	512MB	SS	5	A3R12E3JFF717B9A00	PSC	*	*
PSC	AL7E8E63J-6E1	1G	DS	5	A3R12E3JFF717B9A01	PSC	*	*
GEIL	GX21GB5300SX	1G	DS	3	Heat-Sink Package	GEIL	*	*
G.SKILL	F2-5400PHU2-2GBNT	2G(kit of 2)	DS	5-5-5-15	D2 64M8CCF 0815 C7173S	G.SKILL	*	*
Twinmos	8D-A3JK5MPETP	512MB	SS	5	A3R12E3GEF633ACA0Y	PSC	*	*
ELIXIR	M2Y1G64TU8HA2B-3C	1G	DS	5	M2TU51280AE-3C717095R28F	ELIXIR	*	*
Leadmax	LRMP512U64A8-Y5	1G	DS	N/A	HY5PS12821CFP-Y5 C 702AA	Hynix	*	*

DDR2-800MHz capability

Vendor	Part No.	Size	SS/ DS	CL	Chip No.	Chip Brand	DIMM support	
							A*	B*
Kingston	KHX6400D2LLK2/1GN	512MB	SS	N/A	Heat-Sink Package	Kingston	*	*
Kingston	KVR800D2N5/1G	1G	DS	N/A	E5108AJBG-8E-E	Elpida	*	*
Samsung	M378T2863QZS-CF7	1G	SS	6	K4T1G084QQ-HCF7	Samsung	*	*
Samsung	M391T2863QZ3-CF7	1G	SS	6	K4T1G084QQ-HCF7(ECC)	Samsung	*	*
Samsung	M378T5263AZ3-CF7	4G	DS	N/A	K4T2G084QA-HCF7	Samsung	*	*
Qimonda	HYS64T64000EU-2.5-B2	512MB	SS	6	HYB18T512800B2F25FSS28380	Qimonda	*	*
Corsair	CM2X2048-6400C5DHX	2G(Kit of 2)	DS	5	Heat-Sink Package	Corsair	*	*
Crucial	BL12864AA804.8FE5	2G(Kit of 2)(EPP)	SS	N/A	Heat-Sink Package	N/A	*	*
HY	HYMP564U64CP8-S5 AB	512MB	SS	5	HY5PS12821CFP-S5	Hynix	*	*
Kingmax	KLDC28F-A8K15	512MB	SS	N/A	KK8AFF1XF-JFS-25A	Kingmax	*	*
Apacer	78.91G91.9K5	512MB	SS	5	AM4B5708JQJUS8E0751C	Apacer	*	*
Apacer	78.A1GA0.9K4	2G	DS	5	AM4B5808CQJUS8E0747D	Apacer	*	*
VDATA	M2GVD6G3H3160Q1E52	512MB	SS	N/A	VD29608A8A-25EG20813	VDATA	*	*
ADATA	M2OAD6G314170Q1E58	1G	DS	N/A	AD29608A8A-25EG80810	ADATA	*	*
PSC	AL7E8E63H-10E1K	2G	DS	5	A3R1GE3CFF750RABBP(ECC)	PSC	*	*
GEIL	GX22GB6400LX	2G	DS	5	Heat-Sink Package	GEIL	*	*
G.SKILL	F2-6400CL4D-2GBHK	1G	DS	4	Heat-Sink Package	G.SKILL	*	*
G.SKILL	F2-6400CL4D-4GBPK	2G	DS	4	Heat-Sink Package	G.SKILL	*	*
OCZ	OCZ2VU8004GK	1G	DS	6	Heat-Sink Package	OCZ	*	*
Century	28V0H8	1G	DS	5	HY5PS12821CFP-S5	Hynix	*	*

DDR2-1066MHz capability

Vendor	Part No.	Size	SS/ DS	CL	Chip No.	Chip Brand	DIMM support	
							A*	B*
Corsair	CM2X1024-8500C5	1G	DS	N/A	Heat-Sink Package	N/A	-	-
GEIL	GB24GB8500C5QC	1G	SS	5	GL2L128M88BA25AB	GEIL	-	-



- DDR2 1066 is supported by AM2+ CPU only.
- The default DIMM frequency depends on its Serial Presence Detect (SPD), which is the standard way of accessing information from a memory module. Under the default state, some memory modules for overclocking may operate at a lower frequency than the vendor-marked value.



SS: Single-sided / DS: Double-sided

DIMM support:

- **A***: Supports one module inserted into either slot as the single-channel memory configuration.
- **B***: Supports one pair of modules inserted into both the yellow slots as one pair of dual-channel memory configuration.



Visit the ASUS website at www.asus.com for the latest QVL.

1.5 Expansion slots

In the future, you may need to install expansion cards. The following sub-sections describe the slots and the expansion cards that they support.



Unplug the power cord before adding or removing expansion cards. Failure to do so may cause you physical injury and damage motherboard components.

1.5.1 Installing an expansion card

To install an expansion card:

1. Before installing the expansion card, read the documentation that comes with it and make the necessary hardware settings for the card.
2. Remove the chassis cover (if your motherboard is already installed in a chassis).
3. Remove the bracket opposite the slot that you intend to use.
4. Align the card connector with the slot and press firmly until the card is completely seated on the slot.
5. Secure the card to the chassis with the screw.
6. Replace the chassis cover.

1.5.2 Configuring an expansion card

After installing the expansion card, configure it by adjusting the software settings.

1. Turn on the system and change the necessary BIOS settings, if any. See Chapter 2 for information on BIOS setup.
2. Assign an IRQ to the card.
3. Install the software drivers for the expansion card.



When using PCI cards on shared slots, ensure that the drivers support “Share IRQ” or that the cards do not need IRQ assignments; otherwise, conflicts will arise between the two PCI groups, making the system unstable and the card inoperable.

1.5.3 PCI slot

The PCI slots support cards such as LAN cards, SCSI cards, USB cards, and other cards that comply with the PCI specifications.

1.5.4 PCI Express x1 slot

This motherboard supports PCI Express x1 network cards, SCSI cards, and other cards that comply with the PCI Express specifications.

1.5.5 PCI Express x16 slot

This motherboard supports PCI Express x16 graphics cards that comply with the PCI Express specifications.

1.6 Jumpers

1. Clear RTC RAM (3-pin CLRRTC)

This jumper allows you to clear the Real Time Clock (RTC) RAM in CMOS. You can clear the CMOS memory of date, time, and system setup parameters by erasing the CMOS RTC RAM data. The onboard button cell battery powers the RAM data in CMOS, which include system setup information such as system passwords.

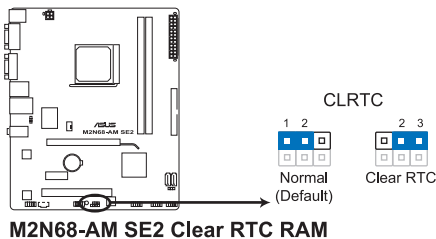

To erase the RTC RAM:

1. Turn OFF the computer and unplug the power cord.
2. Move the jumper cap from pins 1-2 (default) to pins 2-3. Keep the cap on pins 2-3 for about 5-10 seconds, then move the cap back to pins 1-2.
3. Plug the power cord and turn ON the computer.
4. Hold down the **** key during the boot process and enter BIOS setup to reenter data.



Except when clearing the RTC RAM, never remove the cap on CLRRTC jumper default position. Removing the cap will cause system boot failure!



- If the steps above do not help, remove the onboard battery and move the jumper again to clear the CMOS RTC RAM data. After clearing the CMOS, reinstall the battery.
 - You do not need to clear the RTC when the system hangs due to overclocking. For system failure due to overclocking, use the CPU Parameter Recall (C.P.R.) feature. Shut down and reboot the system, then the BIOS automatically resets parameter settings to default values.
-

2. USB device wake-up (3-pin USBPW5-10)

Set these jumpers to +5V to wake up the computer from S1 sleep mode (CPU stopped, DRAM refreshed, system running in low power mode) using the connected USB devices. Set to +5VSB to wake up from S3 and S4 sleep modes (no power to CPU, DRAM in slow refresh, power supply in reduced power mode). The USBPW5-10 jumper is for the internal USB connectors that you can connect to additional USB ports.

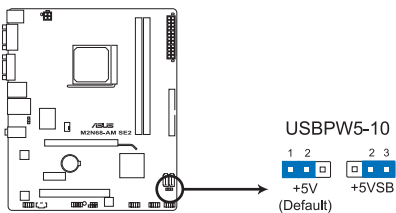

M2N68-AM SE2 USB Device Wake Up

3. Keyboard/mouse power (3-pin PS2_USBPW1-4)

This jumper allows you to enable or disable the keyboard/mouse and USB port 1-4 wake-up feature. When you set this jumper to pins 2-3 (+5VSB), you can wake up the computer by pressing a key on the keyboard (the default is the Space Bar), clicking the mouse, or using a USB device. This feature requires an ATX power supply that can supply at least 1A on the +5VSB lead, and a corresponding setting in the BIOS. The PS2_USBPW1-4 jumper is for the rear USB ports.

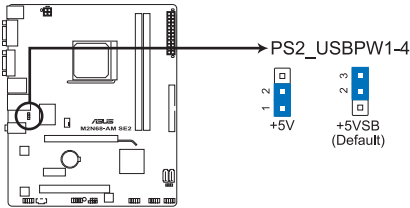

M2N68-AM SE2 Keyboard/mouse power

1.7 Connectors

1.7.1 Rear panel ports

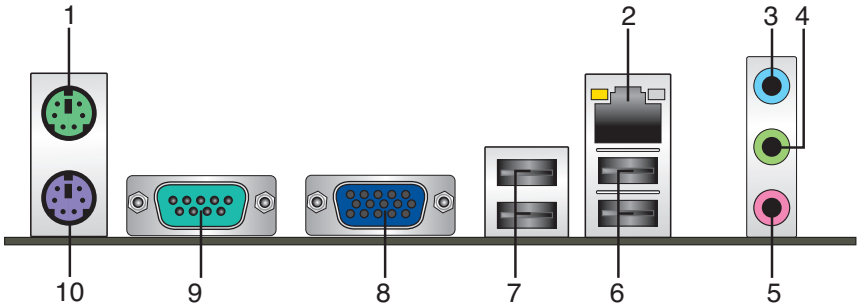

1. **PS/2 Mouse port.** This port is for a PS/2 mouse.
2. **LAN (RJ-45) port.** This port allows 10/100 PHY connection to a Local Area Network (LAN) through a network hub.

LAN port LED indications

LED (Orange)		LED (Green)	
Status	Description	Status	Description
OFF	No link	OFF	No link
ORANGE	100Mbps connection	Green	10Mbps connection

LED (Orange) LED (Green)

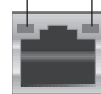

LAN port

3. **Line In port (light blue).** This port connects to the tape, CD, DVD player, or other audio sources.
4. **Line Out port (lime).** This port connects to a headphone or a speaker. In 4-channel and 6-channel configurations, the function of this port becomes Front Speaker Out.
5. **Microphone port (pink).** This port connects to a microphone.



Refer to the audio configuration table below for the function of the audio ports in 2, 4, or 6-channel configuration.

Audio 2, 4, 6-channel configuration

Port	Headset 2-channel	4-channel	6-channel
Light Blue	Line In	Rear Speaker Out	Rear Speaker Out
Lime	Line Out	Front Speaker Out	Front Speaker Out
Pink	Mic In	Mic In	Bass/Center

6. **USB 2.0 ports 1 and 2.** These two 4-pin Universal Serial Bus (USB) ports connect to USB 2.0 devices.
7. **USB 2.0 ports 3 and 4.** These two 4-pin Universal Serial Bus (USB) ports connect to USB 2.0 devices.
8. **Video Graphics Adapter (VGA) port.** This 15-pin port is for a VGA monitor or other VGA-compatible devices.
9. **COM port.** This 9-pin COM1 port is for pointing devices or other serial devices.
10. **PS/2 Keyboard port.** This port is for a PS/2 keyboard.

1.7.2 Internal connectors

1. Serial ATA connectors (7-pin SATA1, SATA2)

These connectors are for the Serial ATA signal cables for Serial ATA 3Gb/s hard disk and optical disk drives. The Serial ATA 3Gb/s is backward compatible with Serial ATA 1.5Gb/s specification. The data transfer rate of the Serial ATA 3Gb/s is faster than the standard parallel ATA with 133MB/s (Ultra DMA133).

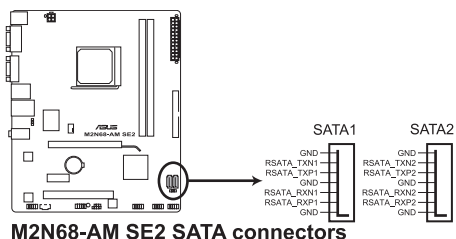

Install the Windows® XP Service Pack 1 before using Serial ATA.

2. IDE connector (40-1 pin PRI_IDE)

The onboard IDE connector is for an Ultra DMA 133/100/66 signal cable. There are three connectors on each Ultra DMA 133/100/66 signal cable: blue, black, and gray. Connect the blue connector to the motherboard's IDE connector, then select one of the following modes to configure your devices.

	Drive jumper setting	Mode of device(s)	Cable connector
Single device	Cable-Select or Master	-	Black
Two devices	Cable-Select	Master	Black
		Slave	Gray
	Master	Master	Black or gray
		Slave	



Pin 20 on the IDE connector is removed to match the covered hole on the Ultra DMA cable connector. This prevents incorrect insertion when you connect the IDE cable.



- If any device jumper is set as "Cable-Select", ensure that all other device jumpers have the same setting.
- Use the 80-conductor IDE cable for Ultra DMA 133/100/66 IDE devices.

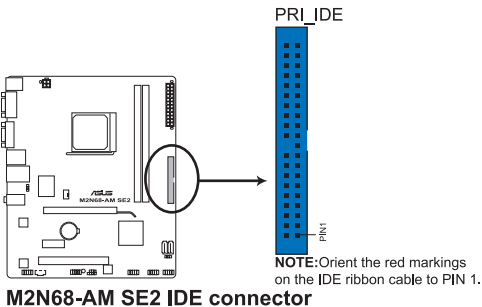

3. Optical drive audio in connector (4-pin CD)

This connector allows you to receive stereo audio input from sound sources such as a CD-ROM, TV tuner, or MPEG card.

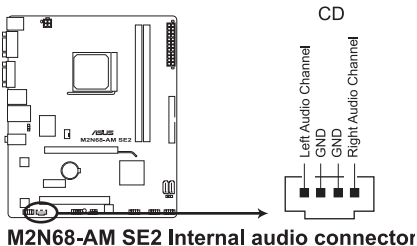

4. USB connectors (10-1 pin USB56, USB78, USB910)

These connectors are for USB 2.0 ports. Connect the USB module cable to any of these connectors, then install the module to a slot opening at the back of the system chassis. These USB connectors comply with the USB 2.0 specification that supports up to 480Mbps connection speed.

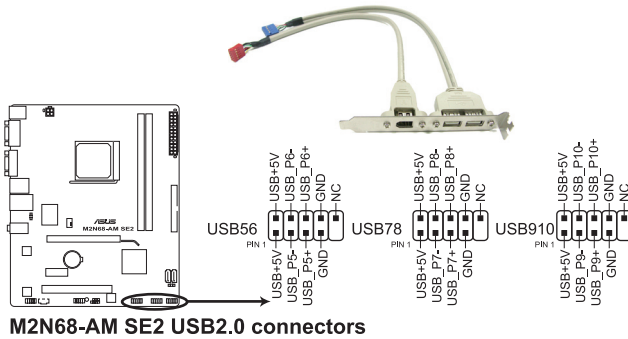

Never connect a 1394 cable to the USB connectors. Doing so will damage the motherboard!



The USB 2.0 module is purchased separately.

5. CPU fan connector (4-pin CPU_FAN)

The CPU fan connector supports cooling fans of 350mA~740mA (8.88W max.) or a total of 1A~2.22A (26.64W max.) at +12V. Connect the CPU fan cable to the CPU fan connector on the motherboard, ensuring that the black wire of each cable matches the ground pin of the connector.



DO NOT forget to connect the CPU fan cable to the CPU fan connector. Insufficient air flow inside the system may damage the motherboard components. It is not a jumper! DO NOT place a jumper cap on the CPU fan connector.



Only the CPU fan supports the ASUS Q-Fan feature.

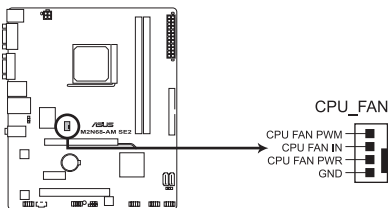

6. ATX power connectors (24-pin EATXPWR, 4-pin ATX12V)

These connectors are for an ATX power supply. The plugs from the power supply are designed to fit these connectors in only one orientation. Find the proper orientation and push down firmly until the connectors completely fit.

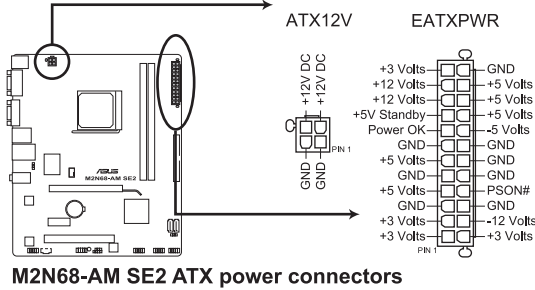

- We recommend that you use an ATX 12V Specification 2.0-compliant power supply unit (PSU) with a minimum of 300W power rating. This PSU type has 24-pin and 4-pin power plugs.
- If you intend to use a PSU with 20-pin and 4-pin power plugs, make sure that the 20-pin power plug can provide at least 15 A on +12 V and that the PSU has a minimum power rating of 300 W. The system may become unstable or may not boot up if the power is inadequate.
- DO NOT forget to connect the 4-pin ATX +12 V power plug; otherwise, the system will not boot up.
- We recommend that you use a PSU with higher power output when configuring a system with more power-consuming devices or when you intend to install additional devices. The system may become unstable or may not boot up if the power is inadequate.
- If you are uncertain about the minimum power supply requirement for your system, refer to the Recommended Power Supply Wattage Calculator at <http://support.asus.com/PowerSupplyCalculator/PSCalculator.aspx?SLanguage=en-us> for details.

7. Speaker connector (4- pin SPEAKER)

This 4-pin connector is for the chassis-mounted system warning speaker. The speaker allows you to hear system beeps and warnings.

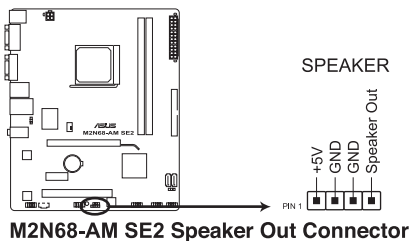

8. System panel connector (10-1 pin F_PANEL)

This connector supports several chassis-mounted functions.

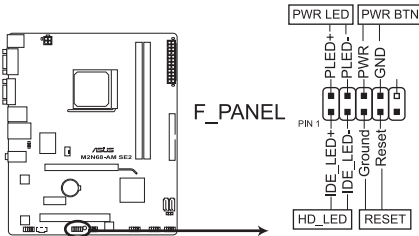

M2N68-AM SE2 System panel connector

- **System power LED (2-pin PWRLED)**

This 2-pin connector is for the system power LED. Connect the chassis power LED cable to this connector. The system power LED lights up when you turn on the system power, and blinks when the system is in sleep mode.

- **Hard disk drive activity LED (2-pin HDLED)**

This 2-pin connector is for the HDD Activity LED. Connect the HDD Activity LED cable to this connector. The IDE LED lights up or flashes when data is read from or written to the HDD.

- **Power/Soft-off button (2-pin PWRBTN)**

This 2-pin connector is for the system power button. Pressing the power button turns the system ON or puts the system in SLEEP or SOFT-OFF mode depending on the BIOS settings. Pressing the power switch for more than four seconds while the system is ON turns the system OFF.

- **Reset button (2-pin RESET)**

This 2-pin connector is for the chassis-mounted reset button for system reboot without turning off the system power.

9. Front panel audio connector (10-1 pin AAFP)

This connector is for a chassis-mounted front panel audio I/O module that supports either High Definition Audio or AC`97 audio standard. Connect one end of the front panel audio I/O module cable to this connector.

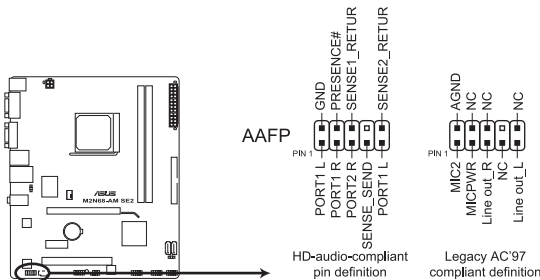

M2N68-AM SE2 Analog front panel connector



If you want to connect a high-definition front panel audio module to this connector, ensure that the **Front Panel Select** item in the BIOS is set to **[HD Audio]**. If you want to connect an AC97 front panel audio module to this connector, set the item to **[AC97]**. See page 2-10 for details.

1.8 Software support

1.8.1 Installing an operating system

This motherboard supports Windows® XP/Vista Operating Systems (OS). Always install the latest OS version and corresponding updates to maximize the features of your hardware.



- Motherboard settings and hardware options vary. Refer to your OS documentation for detailed information.
- Ensure that you install Windows® XP Service Pack 3 or later versions / Windows® Vista Service Pack 1 or later versions before installing the drivers for better compatibility and system stability.

1.8.2 Support DVD information

The Support DVD that comes with the motherboard package contains drivers, software applications, and utilities that you can install to get all motherboard features.

To run the Support DVD

Place the Support DVD into the optical drive. The DVD automatically displays the **Drivers** menu if the Autorun function is enabled on your computer.



The contents of the Support DVD are subject to change at any time without notice. Visit the ASUS website at www.asus.com for updates.

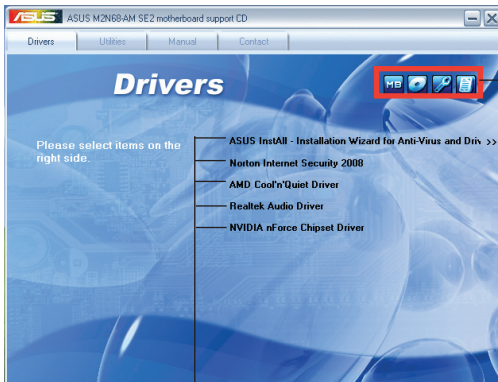

Click an icon to display Support DVD/motherboard information

Click an item to install



If the Autorun function is NOT enabled on your computer, browse the contents of the Support DVD to locate the file **ASSETUP.EXE** from the **BIN** folder. Double-click **ASSETUP.EXE** to run the DVD.

Chapter 2

BIOS information

2.1 Managing and updating your BIOS



Save a copy of the original motherboard BIOS file to a USB flash disk in case you need to restore the BIOS in the future. Copy the original motherboard BIOS using the ASUS Update utility..

2.1.1 ASUS Update utility

The ASUS Update is a utility that allows you to manage, save, and update the motherboard BIOS in Windows® environment.



- ASUS Update requires an Internet connection either through a network or an Internet Service Provider (ISP).
 - This utility is available in the Support DVD that comes with the motherboard package.
-

Installing ASUS Update:

1. Place the Support DVD into the optical drive. The **Drivers** menu appears.
2. Click the **Utilities** tab, then click **Install ASUS Update**.
3. Follow the onscreen instructions to complete the installation.



Quit all Windows® applications before you update the BIOS using this utility.

Updating the BIOS:

To update the BIOS:

1. From the Windows® desktop, Click **Start > Programs > ASUS > ASUS Update > ASUS Update** to launch the ASUS Update utility.
2. From the dropdown list, select either of the following methods:

Updating from the Internet

- a. Select **Update BIOS from the Internet**, then click **Next**.
- b. Select the ASUS FTP site nearest you to avoid network traffic, or click **Auto Select** then click **Next**.
- c. From the FTP site, select the BIOS version you want to download then click **Next**.



The ASUS Update utility is capable of updating itself through the Internet. Always update the utility to get all its features.

Updating from a BIOS file

- a. **Select Update BIOS from a file**, then click **Next**.
 - b. Locate the BIOS file from the **Open** window, then click **Open**.
3. Follow the onscreen instructions to complete the updating process.

2.1.2 ASUS EZ Flash 2 utility

The ASUS EZ Flash 2 feature allows you to update the BIOS without using an OS-based utility.



Download the latest BIOS file from the ASUS website at www.asus.com.

To update the BIOS using EZ Flash 2:

1. Insert the USB flash disk that contains the latest BIOS file to a USB port, then launch EZ Flash 2 in either of the following ways.
 - Press **<Alt> + <F2>** during POST to display the following:

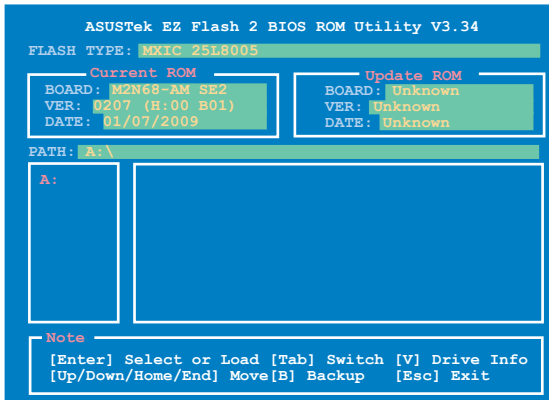

- Enter the BIOS setup program. Go to the **Tools** menu to select **EZ Flash 2** and press **<Enter>** to enable it.
2. Press **<Tab>** to locate the correct file. Press **<Enter>**.

When the correct BIOS file is found, EZ Flash 2 performs the BIOS updating process and automatically reboots the system when done.



-
- Only a USB flash disk with **FAT 32/16** format and single partition supports the ASUS EZ Flash 2 utility.
 - **DO NOT** shut down or reset the system while updating the BIOS to prevent system boot failure!
-

2.1.3 ASUS CrashFree BIOS 3 utility

The ASUS CrashFree BIOS 3 is an auto recovery tool that allows you to restore the BIOS file when it fails or gets corrupted during the updating process. You can update a corrupted BIOS file using the motherboard Support DVD or a USB flash disk that contains the updated BIOS file.



- Prepare the motherboard Support DVD or a USB flash disk containing the updated motherboard BIOS before using this utility.
- Always connect the SATA cable to the SATA1/2 connector; otherwise, the utility will not function.

Recovering the BIOS

To recover the BIOS:

1. Turn on the system.
2. Insert the Support DVD or USB flash disk containing the BIOS file to the optical disk drive or a USB port.

The utility displays the following message and automatically checks the Support DVD or the USB flash disk for the BIOS file.

```
Bad BIOS checksum. Starting BIOS recovery...  
Checking for CD-ROM...
```

When the BIOS file is found, the utility reads it and starts erasing the corrupted BIOS file.

```
Bad BIOS checksum. Starting BIOS recovery...  
Checking for CD-ROM...  
CD-ROM found!  
Reading file "M2NAMSE2.ROM". Completed.  
Start Erasing...  
Start Programming...
```

3. Restart the system after the utility completes the updating process.



- Only a USB flash disk with FAT 32/16 format and single partition supports ASUS CrashFree BIOS 3. The device size should be smaller than 8GB.
- DO NOT shut down or reset the system while updating the BIOS! Doing so can cause system boot failure!



The recovered BIOS may not be the latest BIOS version for this motherboard. Download the latest BIOS file from the ASUS website at www.asus.com.

2.2 BIOS setup program

Use the BIOS Setup program when you are installing a motherboard, reconfiguring your system, or prompted to “Run Setup.” This section explains how to configure your system using this utility.

If you want to enter Setup after POST, reboot the system by doing any of the following procedures:

- Restart using the OS standard shut-down procedure.
- Press <Ctrl>+<Alt>+ simultaneously.
- Press the reset button on the system chassis.
- Press the power button to turn the system off then back on.



Using the **power button**, **reset button**, or the <Ctrl>+<Alt>+ keys to force reset from a running operating system can cause damage to your data or system. We recommend that you always shut down the system properly from the operating system.



- The default BIOS settings for this motherboard apply to most conditions to ensure optimum performance. If the system becomes unstable after changing any BIOS settings, load the default settings to ensure system compatibility and stability. Select the **Load Setup Defaults** item under the **Exit** menu. See section 2.8 **Exit menu**.
- The BIOS setup screens in this section are for reference only. They may not exactly match what you see on your screen.
- Visit the ASUS website at www.asus.com to download the latest BIOS file for this motherboard.

2.3 Main menu

When you enter the BIOS Setup program, the **Main** menu screen appears, giving you an overview of the basic system information.

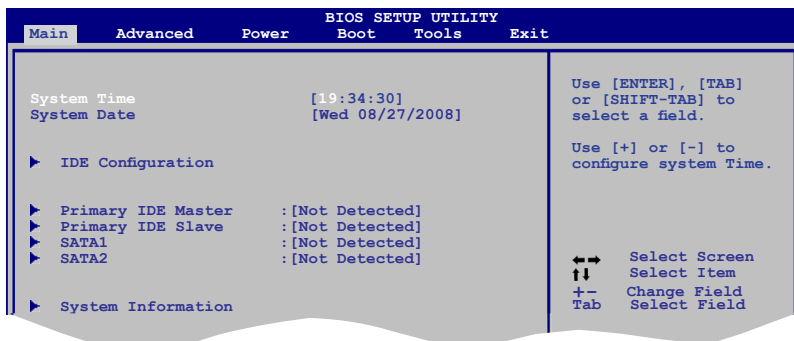

2.3.1 System Time [xx:xx:xx]

Allows you to set the system time.

2.3.2 System Date [Day xx/xx/xxxx]

Allows you to set the system date.

2.3.3 IDE Configuration

The items in this menu allow you to set or change the configurations for the IDE devices installed in the system. Select an item then press **<Enter>** if you want to configure the item.

Onboard IDE Controller [Enabled]

Enables or disables the onboard IDE controller. Configuration options: [Disabled] [Enabled]

Serial ATA Devices [Enabled]

Enables or disables the Serial ATA devices. Configuration options: [Enabled] [Disabled]

nVidia RAID Function [Disabled]

Enables or disables the NVIDIA RAID function. Configuration options: [Disabled] [Enabled]

2.3.4 Primary IDE Master/Slave

While entering Setup, the BIOS automatically detects the presence of IDE devices. There is a separate submenu for each IDE device. Select a device item then press **<Enter>** to display the IDE device information.

The BIOS automatically detects the values opposite the dimmed items (Device, Vendor, Size, LBA Mode, Block Mode, PIO Mode, Async DMA, Ultra DMA, and SMART monitoring). These values are not user-configurable. These items show **Not Detected** if no IDE device is installed in the system.

Type [Auto]

Selects the type of IDE drive. Setting to **[Auto]** allows automatic selection of the appropriate IDE device type. Select **[CDROM]** if you are specifically configuring a CD-ROM drive. Select **[ARMD]** (ATAPI Removable Media Device) if your device is either a ZIP, LS-120, or MO drive. Configuration options: [Not Installed] [Auto] [CDROM] [ARMD]

LBA/Large Mode [Auto]

Enables or disables the LBA mode. Setting to **[Auto]** enables the LBA mode if the device supports this mode, and if the device was not previously formatted with LBA mode disabled. Configuration options: [Disabled] [Auto]

Block (Multi-Sector Transfer) M [Auto]

Enables or disables data multi-sectors transfers. When set to **[Auto]**, the data transfer from and to the device occurs multiple sectors at a time if the device supports multi-sector transfer feature. When set to **[Disabled]**, the data transfer from and to the device occurs one sector at a time. Configuration options: [Disabled] [Auto]

PIO Mode [Auto]

Selects the PIO mode. Configuration options: [Auto] [0] [1] [2] [3] [4]

DMA Mode [Auto]

Selects the DMA mode. Configuration options: [Auto]

SMART Monitoring [Auto]

Sets the Smart Monitoring, Analysis, and Reporting Technology. Configuration options: [Auto] [Disabled] [Enabled]

32Bit Data Transfer [Enabled]

Enables or disables 32-bit data transfer. Configuration options: [Disabled] [Enabled]

2.3.5 SATA 1-2

While entering Setup, the BIOS automatically detects the presence of SATA devices. There is a separate submenu for each SATA device. Select a device item then press **<Enter>** to display the SATA device information.

The BIOS automatically detects the values opposite the dimmed items (Device, Vendor, Size, LBA Mode, Block Mode, PIO Mode, Async DMA, Ultra DMA, and SMART monitoring). These values are not user-configurable. These items show **Not Detected** if no SATA device is installed in the system.

LBA/Large Mode [Auto]

Enables or disables the LBA mode. Setting to **[Auto]** enables the LBA mode if the device supports this mode, and if the device was not previously formatted with LBA mode disabled. Configuration options: [Disabled] [Auto]

Block (Multi-Sector Transfer) M [Auto]

Enables or disables data multi-sectors transfers. When set to **[Auto]**, the data transfer from and to the device occurs multiple sectors at a time if the device supports multi-sector transfer feature. When set to **[Disabled]**, the data transfer from and to the device occurs one sector at a time. Configuration options: [Disabled] [Auto]

PIO Mode [Auto]

Selects the PIO mode. Configuration options: [Auto] [0] [1] [2] [3] [4]

DMA Mode [Auto]

Selects the DMA mode. Configuration options: [Auto]

SMART Monitoring [Auto]

Sets the Smart Monitoring, Analysis, and Reporting Technology. Configuration options: [Auto] [Disabled] [Enabled]

32Bit Data Transfer [Enabled]

Enables or disables 32-bit data transfer. Configuration options: [Disabled] [Enabled]

2.3.6 System Information

This menu gives you an overview of the general system specifications. The BIOS automatically detects the items in this menu.

AMI BIOS

Displays the auto-detected BIOS information

Processor

Displays the auto-detected CPU specification

System Memory

Displays the auto-detected system memory

2.4 Advanced menu

The **Advanced** menu items allow you to change the settings for the CPU and other system devices.



Take caution when changing the settings of the **Advanced** menu items. Incorrect field values can cause the system to malfunction.

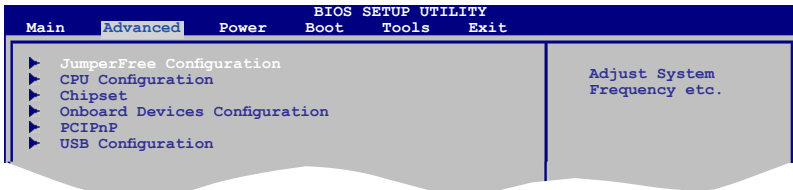

2.4.1 JumperFree Configuration

CPU Overclocking [Auto]

Selects the CPU overclocking options to achieve desired CPU internal frequency.

[Manual] - Allows you to manually set overclocking parameters.

[Auto] - Loads the optimal settings for the system.

[Overclock Profile] - Loads overclocking profiles with optimal parameters for stability when overclocking.

[Standard] - Load the standard settings for the system.



The following item appears only when the **CPU Overclocking** item is set to **[Manual]**.

CPU Frequency [200.0]

Allows you to set the CPU frequency. Configuration options: [200.0] [201.0] - [299.0] [300.0]



The following item appears only when the **CPU Overclocking** item is set to **[Overclock Profile]**.

Overclocking Options [Auto]

Allows you to select the overclocking profile. Configuration options: [Auto] [Overclock 3%] [Overclock 5%] [Overclock 7%]

PCIe Overclocking [Auto]

Configures the PCIe overclocking options. Configuration options: [Auto] [Manual]



The following item appears only when the **PCIe Overclocking** item is set to **[Manual]**.

PCIe Frequency [100]

Allows you to set the PCIe frequency. Configuration options: [100] [101] - [149] [150]

Processor Frequency Multiplier [Auto]

Allows you to select the processor frequency. Configuration options: [Auto] [x4.0 800MHz] [x5.0 1000MHz] [x6.0 1200MHz] [x7.0 1400MHz] [x8.0 1600MHz] [x9.0 1800MHz]

Processor Voltage [Standard]

Allows you to set the processor voltage. Configuration options: [Power Saving Mode] [Standard] [+50mv] [+100mv]

Memory Clock Mode [Auto]

Allows you to select the memory clock mode. Configuration options: [Auto] [Manual]



The following item appears only when the **Memory Clock Mode** item is set to **[Manual]**.

Memclock Value [200MHz]

Allows you to set the memory clock value.

Configuration options: [200MHz] [266MHz] [333MHz] [400MHz]

DRAM Timing Mode [Auto]

Allows you to set the DRAM timing mode. Configuration options: [Auto] [DCT 0]



The following sub-items appear only when you set the **DRAM Timing Mode** item to **[DCT 0]**.

CAS Latency (CL) [Auto]

Configuration options: [Auto] [3 CLK] ~ [6 CLK] [7 CLK DH_Only]

TRCD [Auto]

Configuration options: [Auto] [3 CLK] ~ [6 CLK]

TRP [Auto]

Configuration options: [3 CLK] ~ [6 CLK] **[Auto]**

tRTP [Auto]

Configuration options: [Auto] [2-4 CLK] [3-5 CLK]

TRAS [Auto]

Configuration options: [Auto] [5 CLK] ~ [18 CLK]

TRC [Auto]

Configuration options: [Auto]

tWR [Auto]

Configuration options: [Auto] [3 CLK] ~ [6 CLK]

TRRD [Auto]

Configuration options: [Auto] [2 CLK] ~ [5 CLK]

tBWTTO [Auto]

Configuration options: [Auto] [2 CLK] ~ [9 CLK]

tWBBD [Auto]

Configuration options: [Auto] [0 CLK] ~ [3 CLK]

tWTR [Auto]

Configuration options: **[Auto]** [1 CLK] [2 CLK] [3 CLK]

tWRWR [Auto]

Configuration options: [Auto] [1 CLK] [2 CLK] [3 CLK]

tRDRD [Auto]

Configuration options: [Auto] [2 CLK] ~ [5 CLK]

tRFO [Auto]

Configuration options: [Auto] [75ns] [105ns] [127.5ns] [195ns] [327.5ns]

tRFC1 [Auto]

Configuration options: [Auto] [75ns] [105ns] [127.5ns] [195ns] [327.5ns]

tRFC2 [Auto]

Configuration options: [Auto] [75ns] [105ns] [127.5ns] [195ns] [327.5ns]

tRFC3 [Auto]

Configuration options: [Auto] [75ns] [105ns] [127.5ns] [195ns] [327.5ns]

Memory Voltage [Auto]

Allows you to set the memory voltage. Configuration options: [Auto] [2.050V] [2.150V] [2.250V]

Chipset Voltage [Auto]

Allows you to set the chipset voltage. Configuration options: [Auto] [1.35V]

2.4.2 CPU Configuration

The items in this menu show the CPU-related information that the BIOS automatically detects.

GART Error Reporting [Disabled]

This option should remain disabled for the normal operation. The driver developer may enable it for testing purpose. Configuration options: [Disabled] [Enabled]

Microcode Updation [Enabled]

Allows you to enable or disable the microcode updation. Configuration options: [Disabled] [Enabled]

Secure Virtual Machine Mode [Disabled]

Allows you to enable or disable the AMD Secure Virtual Machine mode. Configuration options: [Disabled] [Enabled]

Cool 'n' Quiet [Disabled]

Allows you to enable or disable the generation of ACPI_PPC, _PSS, and _PCT objects. Configuration options: [Disabled] [Enabled]

CPU Prefetching [Enabled]

Enables or disables the CPU prefetching. Configuration options: [Enabled] [Disabled]

2.4.3 Chipset

The **Chipset** menu allows you to change the advanced chipset settings. Select an item then press **<Enter>** to display the sub-menu.

NorthBridge Configuration

Memory Configuration

Bank Interleaving [Disabled]

Allows you to enable the bank memory interleaving.

Configuration options: [Disabled] [Auto]

Channel Interleaving [Disabled]

Allows you to enable the channel memory interleaving.

Configuration options: [Disabled] [Address bits 6] [Address bits 12]

[XOR of Address bits [20:16, 6]] [XOR of Address bits [20:16, 9]]

Enable Clock to All DIMMs [Disabled]

Enables or disables clock to all DIMMs. Configuration options: [Disabled] [Enabled]

MemClk Tristate C3/ALTVID [Disabled]

Enables or disables the MemClk Tristate C3/ALTVID.

Configuration options: [Disabled] [Enabled]

Memory Hole Remapping [Enabled]

Enables or disables the memory remapping around memory hole.

Configuration options: [Disabled] [Enabled]

DCT Unganged Mode [Auto]

Allows you to enable or disable Unganged mode.

Configuration options: [Auto] [Always]

Power Down Enable [Enabled]

Enables or disables the DDR power down mode.

Configuration options: [Disabled] [Enabled]

ECC Configuration

ECC Mode [Disabled]

Enables or disables the DRAM ECC that allows the hardware to report and correct memory errors automatically. Configuration options: [Disabled] [Basic] [Good] [Super] [Max] [User]

SouthBridge Configuration

Primary Graphics Adapter [PCI-E -> PCI -> IGP]

Allows you to select the primary graphics adapter.

Configuration options: [PCI-E -> PCI -> IGP] [IGP -> PCI-> PCI-E]

OnChip VGA Frame Buffer Size [128MB]

Sets the onchip VGA frame buffer size. Configuration options: [32MB] [64MB] [128MB] [256MB]

AZALIA AUDIO [Auto]

Allows you to enable or disable the HD audio mode. Configuration options: [Disabled] [Auto]

Front Panel Select [HD Audio]

Allows you to set the HD audio mode. Configuration options: [AC97] [HD Audio]

MAC LAN [Auto]

Allows you to set or disable the onboard LAN. Configuration options: [Auto] [Disabled]
Onboard LAN Boot ROM [Disabled]

Allows you to enable or disable the Onboard LAN boot ROM.
Configuration options: [Enabled] [Disabled]

MCP68 SE ACPI HPET TABLE [Enabled]

Allows you to enable or disable the MCP68 SE ACPI HPET TABLE.
Configuration options: [Disabled] [Enabled]

2.4.4 Onboard Devices Configuration

Serial Port1 Address [3F8/IRQ4]

Allows you to select the Serial Port1 base address.
Configuration options: [Disabled] [3F8/IRQ4][2F8/IRQ3] [3E8/IRQ4] [2E8/IRQ3]

2.4.5 PCI PnP

The **PCI PnP** menu items allow you to change the advanced settings for PCI/PnP devices. The menu includes setting IRQ and DMA channel resources for either PCI/PnP or legacy ISA devices, and setting the memory size block for legacy ISA devices.



Take caution when changing the settings of the PCI PnP menu items. Incorrect field values can cause the system to malfunction.

Plug and Play O/S [No]

When set to **[No]**, BIOS configures all the devices in the system. When set to **[Yes]** and if you install a Plug and Play operating system, the operating system configures the Plug and Play devices not required for boot. Configuration options: [No] [Yes]

2.4.6 USB Configuration

The items in this menu allows you to change the USB-related features. Select an item then press **<Enter>** to display the configuration options.



The **Module Version** and **USB Devices Enabled** items show the auto-detected values. If no USB device is detected, the item shows **None**.

USB Functions [Enabled]

Enables or disables the USB functions. Configuration options: [Enabled] [Disabled]

USB 2.0 Controller [Enabled]

Enables or disables the USB 2.0 Controller. Configuration options: [Enabled] [Disabled]

Legacy USB Support [Auto]

Allows you to enable or disable support for Legacy USB storage devices, including USB flash drives and USB hard drives. Setting to **Auto** allows the system to detect the presence of USB devices at startup. If detected, the USB controller legacy mode is enabled. If no USB device is detected, the legacy USB support is disabled. Configuration options: [Disabled] [Enabled] [Auto]

USB 2.0 Controller Mode [HiSpeed]

Allows you to configure the USB 2.0 controller in HiSpeed (480 Mbps) or Full Speed (12 Mbps). Configuration options: [FullSpeed] [HiSpeed]

2.5 Power menu

The **Power** menu items allow you to change the settings for the Advanced Configuration and Power Interface (ACPI) and the Advanced Power Management (APM). Select an item then press **<Enter>** to display the configuration options.

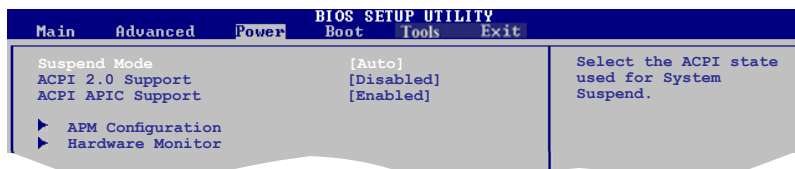

2.5.1 Suspend Mode [Auto]

Allows you to select the Advanced Configuration and Power Interface (ACPI) state to be used for system suspend. Configuration options: [S1 (POS) Only] [S3 Only] [Auto]

[S1(POS) Only] - Enables the system to enter the ACPI S1 (Power on Suspend) sleep state.

In S1 sleep state, the system appears suspended and stays in a low power mode. The system can be resumed at any time.

[S3 Only] - Enables the system to enter the ACPI S3 (Suspend to RAM) sleep state (default).

In S3 sleep state, the system appears to be off and consumes less power than in the S1 state. When signaled by a wake-up device or event, the system resumes to its working state exactly where it was left off.

[Auto] - Detected by OS.

2.5.2 ACPI 2.0 Support [Disabled]

Allows you to add additional tables as per Advanced Configuration and Power Interface (ACPI) 2.0 specifications. Configuration options: [Disabled] [Enabled]

2.5.3 ACPI APIC Support [Enabled]

Allows you to enable or disable the Advanced Configuration and Power Interface (ACPI) support in the Application-Specific Integrated Circuit (ASIC). When set to **Enabled**, the ACPI APIC table pointer is included in the RSDT pointer list. Configuration options: [Disabled] [Enabled]

2.5.4 APM Configuration

Restore on AC Power Loss [Power Off]

When set to **Power Off**, the system goes into off state after an AC power loss. When set to **Power On**, the system goes on after an AC power loss. Configuration options: [Power On] [Power Off]

Power On By PCI(-E) Device [Disabled]

When set to **[Enabled]**, this parameter allows you to turn on the system through a PCI/PCIE card. This feature requires an ATX power supply that provides at least 1A on the +5VSB lead. Configuration options: [Disabled] [Enabled]

Power On By Ring [Disabled]

Enable or disable RI to generate a wake event. Configuration options: [Disabled] [Enabled]

Power On By PS/2 KB/MS [Disabled]

Enable or disable PS/2 Keyboard/Mouse to generate a wake event. Configuration options: [Disabled] [Enabled]

Power On By RTC Alarm [Disabled]

Allows you to enable or disable RTC to generate a wake event. When this item is set to **Enabled**, the items RTC Alarm Date, RTC Alarm Hour, RTC Alarm Minute, and RTC Alarm Second appear with set values. Configuration options: [Disabled] [Enabled]

2.5.5 Hardware Monitor

CPU Temperature [xxx°C/xxx°F]

MB Temperature [xxx°C/xxx°F]

The onboard hardware monitor automatically detects and displays the motherboard and CPU temperatures. Select **Ignored** if you do not wish to display the detected temperatures.

CPU Fan Speed [xxxxRPM] or [Ignored]

The onboard hardware monitor automatically detects and displays the CPU fan speed in rotations per minute (RPM). If the fan is not connected to the motherboard, the field shows **N/A**. Select **Ignored** if you do not want the detected speed to be displayed.

VCORE Voltage, 3.3V Voltage, 5V Voltage, 12V Voltage

The onboard hardware monitor automatically detects the voltage output through the onboard voltage regulators.

Smart Q-Fan Function [Disabled]

Allows you to enable or disable the ASUS Q-Fan feature that smartly adjusts the CPU fan speeds for more efficient system operation. Configuration options: [Disabled] [Enabled]

2.6 Boot menu

The **Boot** menu items allow you to change the system boot options. Select an item then press **<Enter>** to display the sub-menu.

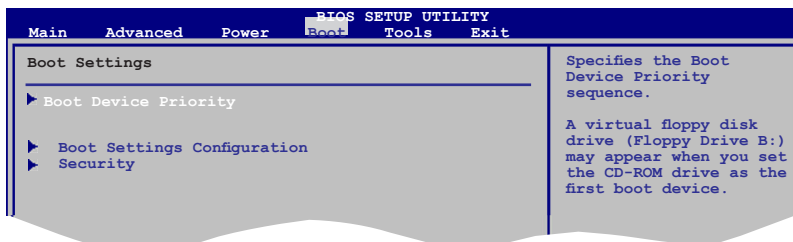

2.6.1 Boot Device Priority

1st ~ xxth Boot Device

These items specify the boot device priority sequence from the available devices. The number of device items that appears on the screen depends on the number of devices installed in the system. Configuration options: [Removable Device] [Hard Drive] [ATAPI CD-ROM] [Disabled]

2.6.2 Boot Settings Configuration

Quick Boot [Enabled]

Enabling this item allows the BIOS to skip some power on self tests (POST) while booting to decrease the time needed to boot the system. When set to **[Disabled]**, BIOS performs all the POST items. Configuration options: [Disabled] [Enabled]

Full Screen Logo [Enabled]

This allows you to enable or disable the full screen logo display feature. Configuration options: [Disabled] [Enabled]



Set this item to **[Enabled]** to use the ASUS MyLogo 2™ feature.

AddOn ROM Display Mode [Force BIOS]

Sets the display mode for option ROM. Configuration options: [Force BIOS] [Keep Current]

Bootup Num-Lock [On]

Allows you to select the power-on state for the NumLock. Configuration options: [Off] [On]

Wait for 'F1' If Error [Enabled]

When set to **Enabled**, the system waits for the F1 key to be pressed when error occurs. Configuration options: [Disabled] [Enabled]

Hit 'DEL' Message Display [Enabled]

When set to **Enabled**, the system displays the message **Press DEL to run Setup** during POST. Configuration options: [Disabled] [Enabled]

2.6.3 Security

The **Security** menu items allow you to change the system security settings. Select an item then press **<Enter>** to display the configuration options.

Change Supervisor Password

Select this item to set or change the supervisor password. The **Supervisor Password** item on top of the screen shows the default **Not Installed**. After you set a password, this item shows **Installed**.

To set a Supervisor Password:

1. Select the **Change Supervisor Password** item then press **<Enter>**.
2. From the password box, type a password composed of at least six letters and/or numbers, then press **<Enter>**.
3. Confirm the password when prompted.

The message **Password Installed** appears after you successfully set your password.

To change the supervisor password, follow the same steps in setting a supervisor password.

To clear the supervisor password, select the **Change Supervisor Password** then press **<Enter>** twice. The message **Password uninstalled** appears.



If you forget your BIOS password, you can clear it by erasing the CMOS Real Time Clock (RTC) RAM. See section 1.6 **Jumpers** for information on how to erase the RTC RAM.

After you have set a supervisor password, the other items appear to allow you to change other security settings.

User Access Level [Full Access]

This item allows you to select the access restriction to the Setup items.

Configuration options: [No Access] [View Only] [Limited] [Full Access]

[No Access] - prevents user access to the Setup utility.

[View Only] - allows access but does not allow change to any field.

[Limited] - allows changes only to selected fields, such as Date and Time.

[Full Access] - allows viewing and changing all the fields in the Setup utility.

Change User Password

Select this item to set or change the user password. The **User Password** item on top of the screen shows the default **Not Installed**. After you set a password, this item shows **Installed**.

To set a User Password:

1. Select the **Change User Password** item.
2. From the password box, type a password composed of at least six letters and/or numbers, then press **<Enter>**.
3. Confirm the password when prompted.

The message **Password Installed** appears after you set your password successfully.

To change the user password, follow the same steps in setting a user password.

Clear User Password

Select this item to clear the user password.

Password Check [Setup]

When set to [Setup], BIOS checks for user password when accessing the Setup utility. When set to [Always], BIOS checks for user password both when accessing Setup and booting the system. Configuration options: [Setup] [Always]

2.7 Tools menu

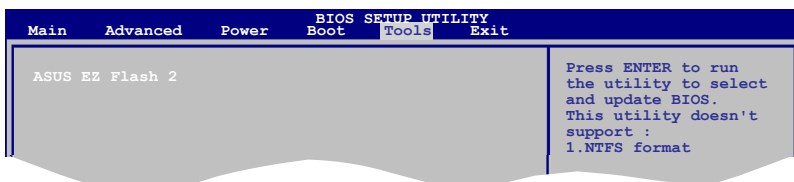

2.7.1 ASUS EZ Flash 2

Allows you to run ASUS EZ Flash 2. When you press <OK>, a confirmation message appears. Use the left/right arrow key to select between [Yes] or [No], then press <OK> to confirm your choice.

2.8 Exit menu

The **Exit** menu items allow you to load the optimal or failsafe default values for the BIOS items, and save or discard your changes to the BIOS items.

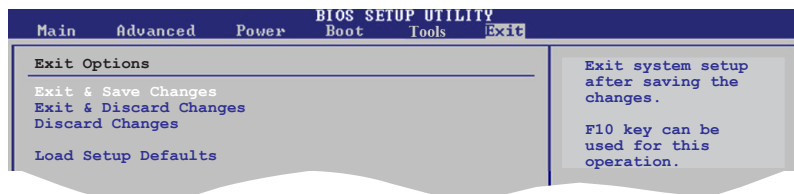

Pressing <Esc> does not immediately exit this menu. Select one of the options from this menu or <F10> from the legend bar to exit.

Free Manuals Download Website

<http://myh66.com>

<http://usermanuals.us>

<http://www.somanuals.com>

<http://www.4manuals.cc>

<http://www.manual-lib.com>

<http://www.404manual.com>

<http://www.luxmanual.com>

<http://aubethermostatmanual.com>

Golf course search by state

<http://golfingnear.com>

Email search by domain

<http://emailbydomain.com>

Auto manuals search

<http://auto.somanuals.com>

TV manuals search

<http://tv.somanuals.com>