



BILLY GOAT HIGH WHEEL MOWER Owner's Manual

HW651SP Accessories

Grass Catcher Kit
Easily convert your mower to bag grass and leaves.
P/N 510223



ABOUT THIS MANUAL

THANK YOU for purchasing a BILLY GOAT® *High Wheel Mower*. Your new machine has been carefully designed and manufactured to provide years of reliable and productive service. This manual provides complete operating and maintenance instructions that will help to maintain your machine in top running order. Read this manual carefully before assembling, operating, or servicing your equipment.

CONTENTS

SERIAL PLATE DATA AND SPECIFICATIONS _____	3
GENERAL SAFETY _____	4-5
SOUND AND VIBRATION _____	6
INSTRUCTION LABELS _____	7
PACKING CHECKLIST & ASSEMBLY _____	8
OPERATION _____	9-10
MAINTENANCE _____	11-12
TROUBLESHOOTING AND WARRANTY PROCEDURE _____	13
ILLUSTRATED PARTS & PARTS LISTS _____	14-15
MAINTENANCE RECORD _____	16



SERIAL PLATE DATA

Record the model number, serial number, date of purchase, and where purchased.

Purchase Date: _____

Purchased From: _____

		1803 S.W. Jefferson Lee's Summit, MO 64082 / USA Tel (816) 524-9696 Fax (816) 524-6983	
Model		Serial No.	
<input type="text"/>		<input type="text"/>	
Unit(Weight)		Engine Power	
<input type="text"/> lbs.	<input type="text"/> kg	<input type="text"/> kW	<input type="text"/> rpm

Specifications

HW651SP

Engine: HP	6.0 (4.5 kW)
Engine: Model	FJ180V
Engine: Type	Kawasaki OHV
Engine: Fuel Capacity	2.1 qt (2.0 L)
Engine: Oil Capacity	0.63 qt. (0.6 L)
Total Unit Weight:	156# (70.8 kg)
Max. operating slope	15°
Overall length	62"(1.57m)
Overall width	32"(0.81m)
Overall height	43"(1.09m)
Lwa at operator position	100.48dBa
Lpa at operator position	80.48dBa
Vibration at operator position	2.57g

GENERAL SAFETY INSTRUCTIONS and SYMBOLS

The safety symbols shown below are used throughout this manual. You should become familiar with them before assembling, operating, or servicing this equipment.



WARNING: This symbol indicates important information that will prevent injury to yourself or others.



This symbol indicates ear protection is recommended when operating this equipment.



This symbol indicates eye protection is recommended when operating this equipment.



This symbol indicates gloves should be worn when servicing this equipment.



This symbol indicates that this manual and the engine manufacturer's manual should be read carefully before assembling, operation, or servicing this equipment.



CAUTION: This symbol indicates important information that will prevent damage to your BILLY GOAT[®] HW Mower.



This symbol indicates the engine oil level should be checked before operating this equipment.

Read and make sure you thoroughly understand the following safety precautions before assembling, operating or servicing this equipment:



READ this manual and the engine manufacturer's manual carefully before assembling, operating, or servicing this equipment.



EAR PROTECTION is recommended when operating this equipment.



EYE PROTECTION is recommended when operating this equipment.



BREATHING PROTECTION is recommended when operating this equipment.





WARNING: **EXHAUST** from this product contains chemicals known to the State of California to cause cancer, birth defects or other reproductive harm.

DO NOT operate this equipment on any unimproved forested, brushy, or grass covered land unless a spark arrester is installed on the muffler as required by Section 4442 of the California Public Resources Code. The arrester must be maintained in good working order. Other states may have similar laws. Federal laws apply on federal lands.

DO NOT run engine in an enclosed area. Exhaust gases contain carbon monoxide, an odorless and possibly fatal poison.

**WARNING:**

-  **DO NOT** run this equipment indoors or in any poorly ventilated area. Refueling outdoors is recommended.
 -  **DO NOT** refuel this equipment while the engine is running. Allow engine to cool for at least two minutes before refueling.
 -  **DO NOT** store gasoline near an open flame.
 -  **DO NOT** remove gas cap while engine is running.
 -  **DO NOT** start or operate engine if strong odor of gasoline is present.
 -  **DO NOT** start or operate engine if gasoline is spilled. Move equipment away from spill until gasoline has completely evaporated.
 -  **DO NOT** smoke while filling the fuel tank.
 -  **DO NOT** check for spark with spark plug or spark plug wire removed. Use an approved spark tester.
 -  **DO NOT** operate engine without a muffler. Inspect muffler periodically and replace if necessary. If equipped with muffler deflector, inspect deflector periodically and replace if necessary.
 -  **DO NOT** operate engine with grass, leaves or other combustible material near the muffler.
 -  **DO NOT** touch muffler, cylinder, or cooling fins when hot. Contact with hot surfaces may cause severe burns.
 -  **DO NOT** leave equipment unattended while in operation.
 -  **DO NOT** park equipment on a steep grade or slope.
 -  **DO NOT** operate equipment with bystanders in or near the work area.
 -  **DO NOT** allow children to operate this equipment.
 -  **DO NOT** operate equipment with guards removed.
 -  **DO NOT** operate equipment near hot or burning debris or any toxic or explosive materials.
 -  **DO NOT** operate equipment on slopes greater than specified in Specifications section of this manual.
 -  **DO NOT** operate barefoot or wearing open sandals. Always wear substantial footwear
 -  **DO NOT** place hands or feet underneath unit, or near any moving parts.
 -  **DO NOT** pull mower backwards unless absolutely necessary
 -  **DO NOT** operate the mower while under the influence of alcohol or drugs.
 -  **DO NOT** operate mower in wet grass. Always be sure of your footing; keep a firm hold on the handle and walk; never run.
 -  **DO NOT** mow on wet grass. Reduced footing could cause slipping.
 -  **DO NOT** mow near drop-offs, ditches, or embankments. The operator could lose footing or balance
 -  **DO NOT** mow excessively steep slopes.
 -  **DO NOT** change the engine governor setting or overspeed the engine.
- ALWAYS** Stop the blade(s) when crossing gravel drives, walks, or roads.
- ALWAYS** Shut the engine (motor) off and wait until the blade comes to complete stop before removing grass catcher.
- ALWAYS** Mow only in daylight or good artificial light.
- ALWAYS** Disengage the self-propelled mechanism or drive clutch on mowers so equipped before starting the engine.
- ALWAYS** wear safety goggles or safety glasses with side shields
- ALWAYS** remove spark plug wire when servicing equipment to prevent accidental starting.
- ALWAYS** check fuel lines and fittings frequently for cracks or leaks. Replace if necessary.
- ALWAYS** store fuel in approved safety containers.

**WARNING: Important**

Remove all rocks, wire, string, etc. that can present a hazard during work prior to starting.



DO identify and mark all fixed objects to be avoided during work such as sprinkler heads, water valves, limbs, or clothes line anchors, etc.



SOUND



SOUND LEVEL 80 dB(a) at Operator Position

Sound tests were conducted in accordance with 2000/14/EEC, and were performed on 2-21-2002 under the conditions listed below.

⚠ Sound power level listed is the highest value for any model covered in this manual. Please refer to serial plate on the unit for the sound power level for your model.

General Conditions:	Sunny
Temperature:	49°F (9.4°C)
Wind Speed:	8 mph (12.8 kmh)
Wind Direction:	South East
Humidity:	53%
Barometric Pressure:	30.15Hg (102.1kpa)

VIBRATION DATA

VIBRATION LEVEL 2.57g (25.20m/s²)

Vibration levels at the operator's handles were measured in the vertical, lateral and longitudinal directions using calibrated vibration test equipment. Tests were performed on 5-26-2006 under the conditions listed below.

General Conditions:	Sunny
Temperature:	87.44°F (30.8°C)
Wind Speed:	3.1 mph (5.04kph)
Wind Direction:	South East
Humidity:	41.5%
Barometric Pressure:	29.89Hg (101.25kpa)

INTENDED USE

INTENDED USE: This unit is mainly designed for cutting grass. Some overgrown weeds, and taller grass may also be cut. Be sure to inspect work area and machine before operating. Make sure that all operators of this equipment are trained in general machine use and safety.

Do not operate if excessive vibration occurs. If excessive vibration occurs, shut engine off immediately and check for damaged or worn blade, loose blade jam nut, loose engine or lodged foreign objects. Note: See maintenance section for proper blade jam nut torque specifications.

INSTRUCTION LABELS

The labels shown below were installed on your BILLY GOAT® HW Mower. If any labels are damaged or missing, replace them before operating this equipment. Item numbers from the Illustrated Parts List and part numbers are provided for convenience in ordering replacement labels. The correct position for each label may be determined by referring to the Figure and Item numbers shown.



LABEL DANGER KEEP HANDS AND FEET AWAY
ITEM #61 P/N 400424



LABEL OILCHAIN #49
ITEM#62 P/N 830502



DANGER FLYING DEBRIS
ITEM #111 P/N 810736

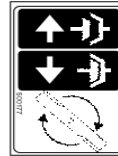

LABEL CLUTCH BLADE
ITEM #84 P/N 500177

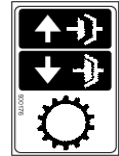

LABEL CLUTCH DRIVE
ITEM #101 P/N 500176



LABEL WARNING GUARDS
ITEM #63 P/N 900327



LABEL EXPLOSIVE FUEL
ITEM # 48 P/N 400268

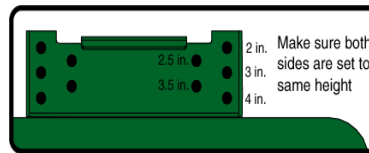

LABEL CUTTING HEIGHT
ITEM #58 P/N 510147



LABEL WARNING MOWER
ITEM #60 P/N 510206



LABEL MOWER INSTRUCT.
ITEM #59 P/N 510207

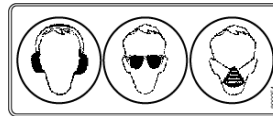

LABEL EAR EYE BREATHING
ITEM #110 P/N 890254



LABEL READ MANUAL
ITEM #109 P/N 890301

ENGINE LABELS

KAWASAKI

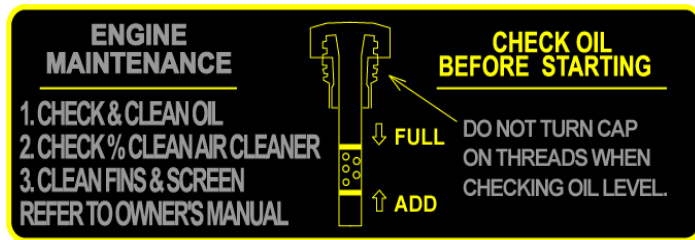

THROTTLE CONTROLS

FIXED THROTTLE
Engine speed is factory set.

SPEED CONTROL
Push forward for faster speed, pull back for slower speed

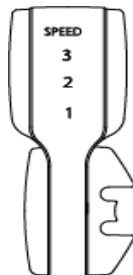



PACKING CHECKLIST

Your Billy Goat HW Mower is shipped from the factory in one carton, completely assembled except for the upper handle.



READ all safety instructions before assembling unit.

TAKE CAUTION when removing the unit from the box the Handle Assembly is attached and folded over



PUT OIL IN ENGINE BEFORE STARTING

PARTS BAG & LITERATURE ASSY

Warranty card P/N- 400972, Owner's Manual P/N-510267

Boxing Parts Checklist

Kawasaki 6HP

Literature Assy
P/N-510256

ASSEMBLY

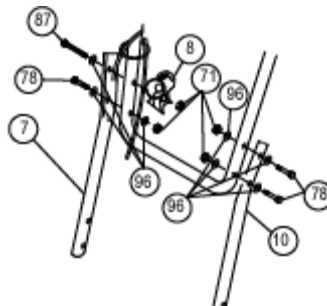
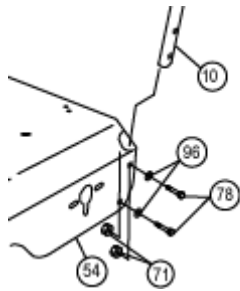

1. REMOVE unit from carton and allow upper handle (item 7) to lay on ground behind unit.
2. REMOVE hardware items 8, 71, 78, 87, 96, & 97 from temporary storage positions on lower handles (items 10).
3. ATTACH lower handle (item 10) to the main frame using hardware (items 71, 78, & 96) removed from the previous step (see figure above).
4. ATTACH upper handle to lower as shown in page 14, and securely tighten all fasteners.
Note: Be sure the engine starter rope is properly installed in the starter rope guide (item 8) before tightening the corresponding fasteners (see figure above).
5. CONNECT spark plug wire to spark plug.

OPERATION

 Like all mechanical tools, reasonable care must be used when operating machine.

Inspect machine work area and machine before operating. Make sure that all operators of this equipment are trained in general machine use and safety.

PUT OIL IN ENGINE BEFORE STARTING

Do not operate if excessive vibration occurs. If excessive vibration occurs, shut engine off immediately and check for damaged or worn blade, loose blade jam nut, loose engine or lodged foreign objects.

Note: See maintenance section for proper blade jam nut torque specifications.

STARTING

 **ENGINE:** See engine manufacturer's instructions for type and amount of oil and gasoline used. Engine must be level when checking and filling oil and gasoline.

ENGINE SPEED: Set at factory. The engine runs at a constant speed.

1. Select desired cutting height before starting engine.
2. Place mower on a sidewalk or driveway where the mower blade is in an unloaded condition. If it must be started on the lawn, move mower over previously cut grass.
3. Be sure drive lever (Yellow lever on the right hand side) is not engaged (fig. 1).
4. Prime to choke. Prime is located in front of the engine.
5. Pull down on operator presence control lever (Red lever on the left hand side - fig. 1.1), then pull back on starter rope slowly until resistance is felt. Then pull cord rapidly to start. Repeat if necessary.

HANDLING & TRANSPORTING:

 Using two people to lift machine is recommended. Lift holding the handle and front of deck. Secure in place during transport.

 Never lift the machine while the engine is running.

CUTTING OPERATION

 **CAUTION:** The mower blade will be rotating whenever engine is running.

 **CAUTION:** Shut down the engine when crossing gravel drives, walks or roads and under all conditions where thrown objects might be a hazard.

 **CLEARING A CLOGGED CUTTING DECK:** Turn engine off and wait for blade to stop completely. Disconnect spark plug wire.

 Wearing durable gloves, remove clog. **Danger**, the clog may contain sharp materials. Reconnect spark plug wire.

 **CAUTION:** Use extreme care when operating the blade. Inspect the work area for foreign objects that could cause damage to the unit or injure the operator if struck by the blade. Never operate the blade with bystanders in the work area

CUTTING HEIGHT ADJUSTMENT

 **CAUTION:** DO NOT make cutting height adjustment when engine is running. Cutting height can be adjusted from 2" to 4" by 1/2" increments by lowering or raising the deck. For easiest adjustment change the height from one side at a time. To change cutting height, remove lock pins, raise or lower deck to desired height, and then reinsert lock pins. Repeat this step on other side NOTE: Be sure that the deck is level. Running the deck out of level will result in poor cut quality and increased belt wear.

STOP POSITION



Fig. 1

OPERATING POSITION



Fig. 1.1

Fig. 2



PROPULSION

This unit is self-propelled, and is controlled by a lever control. To engage the wheel drive, pull up and squeeze it against operator's handle. The drive is disengaged by releasing this lever. (See Fig. 3 & 3.1)

GROUND SPEED can be varied by selecting a higher or lower gear using the gearshift lever on top of the handle (See Fig. 4). Under most conditions cutting should be done in first or second gear. Third gear should be reserved for conditions where weeds and brush are thinned out or not as tall. The quality of the cut produced is directly related to the unit's ground speed during cutting. If the quality of the cut is not satisfactory (i.e. material left standing) you should shift into a lower gear during cutting. For improved control in confined areas, this machine can be pushed forward or backward by releasing the drive lever located at the right side of the handle.

Fig. 3



Fig. 3.1



Fig. 4



HILLSIDE MOWING

⚠ WARNING! Never mow on any slope greater than 15 degrees. Always mow across the face of slopes; never up and down or diagonally see fig 5). DO NOT attempt sudden starts or stop when mowing on a slope. Avoid sudden turns and use extreme caution when changing direction on a slope.

Fig. 5

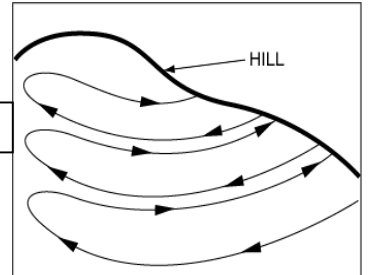

STORAGE

⚠ Never store engine indoors or in enclosed poorly ventilated areas with fuel in tank, where fuel fumes may reach an open flame, spark or pilot light, as on a furnace, water heater, clothes dryer or other gas appliance.

If engine is to be unused for 30 days or more, prepare as follows:

⚠ Be sure engine is cool. Do not smoke. Remove all gasoline from carburetor and fuel tank to prevent gum deposits from forming on these parts and causing possible malfunction of engine. Drain fuel outdoors, into an approved container, away from open flame. Run engine until fuel tank is empty and engine runs out of gasoline.

NOTE: Fuel stabilizer (such as Sta-Bil) is an acceptable alternative in minimizing the formation of fuel gum deposits during storage. Add stabilizer to gasoline in fuel tank or storage container. Always follow mix ratio found on stabilizer container. Run engine at least 10 min. after adding stabilizer to allow it to reach the carburetor.

CAUTION: Wheels must be chocked or blocked when unit is parked on a slope.

MAINTENANCE

PERIODIC MAINTENANCE

Periodic maintenance should be performed at the following intervals:

Maintenance Operation	Every Use (daily)	Every 5 hrs or (daily)	Every 25 Hours	Every 100 Hours
Inspect for loose, worn or damaged parts.	•			
Check for excessive vibration		•		
Inspect belt for wear			•	
Engine (See Engine Manual)				
Lubricate front wheels and height adjustment pins			•	
Sharpen Blade			•	
Replace blade and traction belts				•

BLADE Removal / Sharpening

⚠ NOTE: When sharpening the blade it is a good idea to check the balance of the blade. A properly balanced blade will increase life of the bearings and other components.

Tools required: 3/8 inch socket, 5/8 inch socket, torque wrench, blade block.

1. Disconnect spark plug wire.
 2. Remove 5 screws (item 76) then remove belt guard (19).
 3. Set the unit on its side to allow access to both pulley and the blade.
- Note: When tipping the unit on its side, keep the air cleaner side of engine up. Be sure the gas is drained out to prevent from spilling before tipping the unit on its side. Never tip the mower more than 90 degrees and do not leave the mower tipped for any length of time.
4. While protecting your hands with pair of gloves or heavy rag to hold the blade, loosen but do not remove the bolt (88) on the pulley side (fig. 6).
 5. Remove jam nut (68), blade washer (43), blade (44), blade spacer (39).
 6. Replace or sharpen the blade then install in the exact order they were removed (fig. 7).
 7. **Tighten the jam nut until it is flush with the end of the shaft** (fig 7). Then tighten the bolt on the pulley side - Torque it to 80 ft-lbs.

Note: When replacing the blade use B.G.I. Part no. 510107.

8. Reinstall belt guard then connect spark plug.

Note: Before installing the fasteners inspect them for wear and replace as necessary.

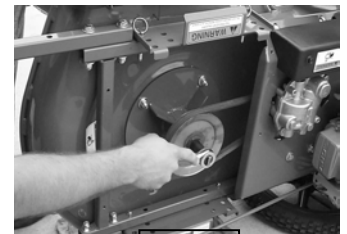

Fig. 6



Fig. 7

BELT REPLACEMENT

When replacing one belt the other should be inspected for wear and replaced if worn. It is good practice to change both belts when either is worn beyond use. Use only original equipment belts for replacement. Billy Goat uses only premium quality, Kevlar corded and coated belts in your unit. Substitute belts do not meet the design and performance requirements for your unit, and will greatly reduce machine performance and belt life.

Blade Drive Belt

Tools required: 3/8 inch socket, 1/2 inch socket, 3/8" torque wrench.

1. Disconnect spark plug wire.
2. Set the deck height to middle position (3 inches cutting height).
3. Remove 5 screws (item 76) then remove belt guard (19).
4. Loosen but do not remove the nut (71) at the top of the engine base located just front of the engine. This will release the tension on the blade drive belt (37). NOTE: It may be necessary to loosen bolt (85) in order to allow idler pulley bracket to pivot.
5. Replace the old belt with the new belt.

Note: Use only O.E.M. approved belt for this machine - B.G.I. Part no. 510139.

6. To adjust tension on the new belt, insert 3/8" torque wrench in the idler bracket, apply 10 lbs. of torque then tighten the nut (71) on top of the engine base (fig. 8).

Note: Belt requires very little tension to drive the blade. Over tensioning the belt will greatly reduce the life of the belt.

7. Install belt guard using 5 screws (76)

8. Reconnect spark plug wire.

Note: Start the unit up and cut grass to make sure the blade belt is not slipping.

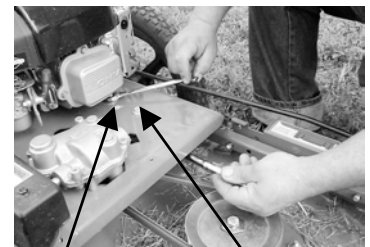
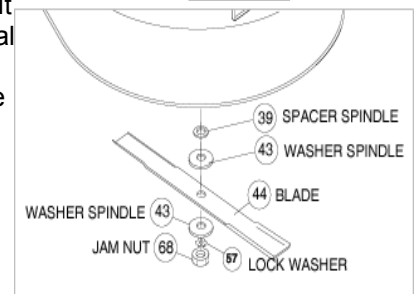

Nut (71) Fig. 8 Nut (85)

BELT REPLACEMENT continued
Drive Belt

Tools required: 3/8 inch socket, 1/2 inch socket, 3/8" torque wrench.

1. Follow steps 1 through 5 above to remove the blade drive belt.
2. Set the unit on its side to allow access to both pulley and the blade.
 Note: When tipping the unit on its side, keep the air cleaner side of engine up. Be sure the gas is drained out to prevent from spilling before tipping the unit on its side. Never tip the mower more than 90 degrees and do not leave the mower tipped for any length of time.
3. Swing over the drive belt idler to release tension on drive belt then remove it (fig. 9).
4. Install the new belt (fig. 10).
- Note: Use only O.E.M. approved belt for this machine - B.G.I. Part no. 510138.
5. Set the unit back down.
6. Follow steps 6 through 8 on previous section to reinstall the blade belt.

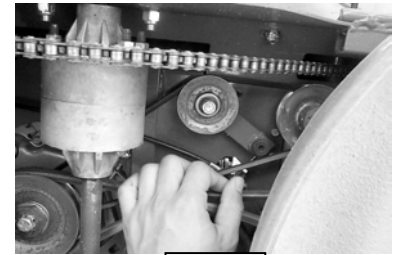

Fig. 9



Fig. 10

SELF PROPELLED DRIVE ADJUSTMENT

Tools required: two 1/2 wrenches.

As the clutch wears, adjustments may be required to maintain proper control cable tension, and clutch engagement (fig. 11). If the clutch begins slipping or squealing during normal operation it may require an adjustment to increase the clutch cable tension. A properly adjusted drive clutch should require a minimum of 3/8" of spring stretch when drive lever is engaged (fig. 12). Adjust by tightening or by loosening clutch cable adjusting nut as required, located at the clutch lever (fig. 12). If further adjustment is required, primary adjuster is located at the underneath the engine base (fig. 13). Replacement of cable may be necessary if adjustment will not allow for proper drive clutch engagement.

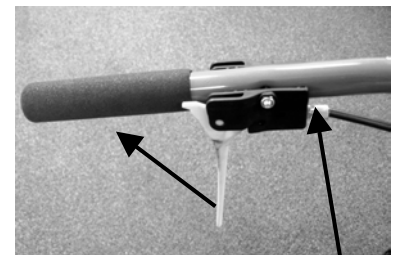

Fig. 11 Adjuster



Fig. 12

⚠ WARNING: If the drive clutch begins to squeal or slip, do not continue to operate your unit until adequate adjustment or repair has been performed. Improper adjustment can cause drive clutch to slip and overheat, greatly reducing machine performance and transmission life.

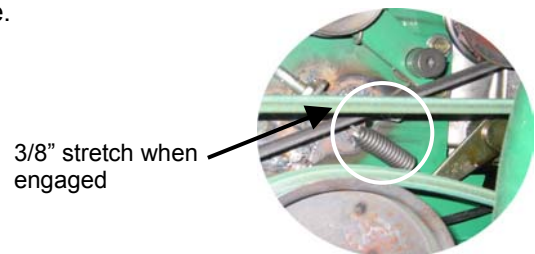

Fig. 13



Troubleshooting

Problem	Possible Cause	Solution
Engine will not start.	Operator presence control lever is not engaged. Engine not properly primed. Out of gasoline, bad or old gas. Spark plug wire disconnected. Dirty air cleaner. Blade is trying to cut grass while starting.	Engage operator presence control lever. Prime to choke. Check Gasoline. Check for spark with an approved tester. Clean or replace air cleaner. Start the mower on pavement or previously cut area.
Engine will not stop	Damaged operator presence control lever. Damaged control cable.	Replace operator presence control lever. Replace control cable
Engine runs poorly	Spark plug loose. Engine RPM set too low. Water or dirt in fuel system. Spark plug fouled, faulty or wrong gap	Sharpen or replace blade (pg 11). Check engine RPM (refer to engine manual). Drain or siphon then replace with fresh gasoline. Reset gap or replace spark plug (refer to engine manual).
Abnormal vibration.	Loose or out of balance blade. Bent blade. Loose engine bolts	Stop work immediately. Check blade mount and balance. Replace damaged or bent blade if required (pg 11). Check engine mount.
Uneven cut	Height adjust is not set correctly. Dull or bent blade	Be sure height adjust is set the same on both sides (pg 9). Sharpen or replace blade (pg 11).
Will not cut or has poor cutting performance	Dull or bent Blade. Clogged deck. Wet Grass. Excessively high grass.	Sharpen or replace blade (pg 11). Unclog deck (pg 9). Check engine RPM (refer to engine manual). Do not mow when grass is wet. Mow once at a high cutting setting then mow again at desired setting or make a narrower cutting path.
Belt slips or smokes	Belt tension too low. Belt worn or stretched. Pulleys worn or damaged.	Increase tension at idler (pg 11). Replace belt. Replace Pulleys.
No self propelling	Not set to gear. Out of adjustment clutch cable. Broken clutch cable. Worn or broken belt.	Shift lever to desired gear. Adjust clutch cable (pg 12). Replace with new cable. Replace belt (pg 12).
Self propelled drive will not release.	Clutch cable out of adjustment. Damaged operator presence control lever.	Adjust clutch cable (pg 12). Replace operator presence control bail.
Engine is locked, will not pull over.	Debris locked against blade. Operator presence control lever not engaged. Broken control cable.	Remove debris (pg 9). Engaged operator presence control lever (pg 9). Replace control cable.

When servicing engine refer to specific manufacturers engine owner's manual. All engine warranty is covered by the specific engine manufacturer. If your engine requires warranty or other repair work contact your local servicing engine dealer. When contacting a dealer for service it is a good idea to have your engine model number available for reference (See table page 3). If you cannot locate a servicing dealer in your area you can contact the manufacturers national service organization.

To reach:

Visit Kawasaki's website to locate dealers near you www.kawpower.com 1-949-460-5687

WARRANTY CLAIM PROCEDURE

Should a BILLY GOAT[®] machine fail due to a defect in material and/or workmanship, the owner should make a warranty claim as follows:

- The machine must be taken to the dealer from whom it was purchased or to an authorized Servicing BILLY GOAT Dealer.
- The owner must present the remaining half of the Warranty Registration Card, or, if this is not available, the invoice or receipt.
- The Warranty Claim will be completed by the authorized BILLY GOAT Dealer and submitted to their respective BILLY GOAT Distributor for their territory Attention: Service Manager. Any parts replaced under warranty must be tagged and retained for 90 days. The model number and serial number of the unit must be stated in the Warranty Claim.
- The distributor service manager will sign off on the claim and submit it to BILLY GOAT for consideration.
- The Technical Service Department at BILLY GOAT will study the claim and may request parts to be returned for examination. BILLY GOAT will notify their conclusions to the distributor service manager from whom the claim was received.
- The decision by the Technical Service Department at BILLY GOAT to approve or reject a Warranty Claim is final and binding.

For online product registration go to www.billygoat.com

PARTS DRAWING HW

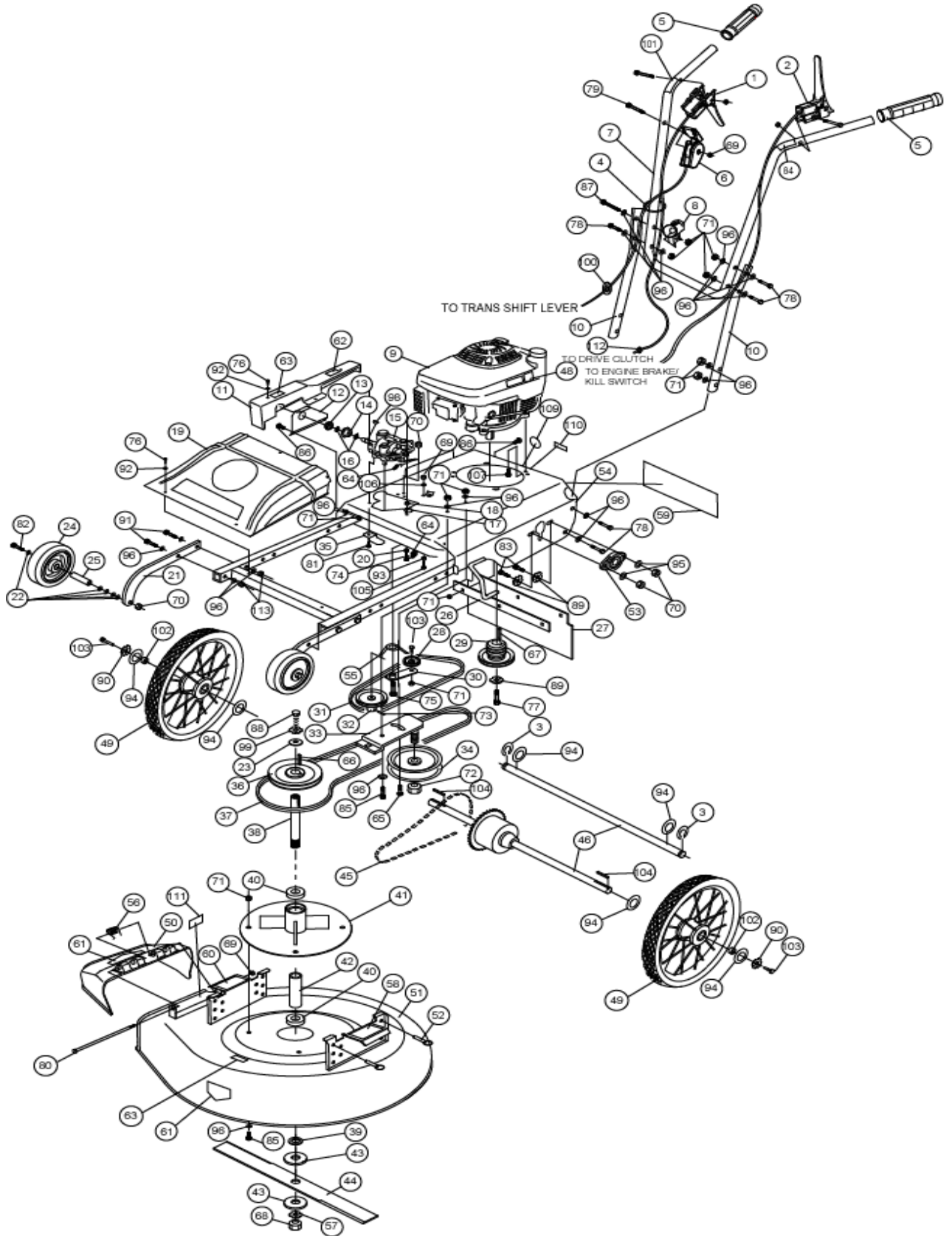



PARTS LIST

ITEM NO.	PART NO.	DESCRIPTION	QTY	ITEM NO.	PART NO.	DESCRIPTION	QTY
1	510263	LEVER DRIVE CLUTCH W/CABLE	1	58	510147	LABEL CUTTING HEIGHT	1
2	510262	LEVER ENGINE BRAKE W/CABLE	1	59	510207	LABEL INSTRUCTION	1
3				60	510206	LABEL WARNING MOWER	1
4	900407	TY WRAP	3	61	400424	LABEL OPEI	2
5	510274	GRIP HANDLE 1" ID X 5" BLACK	2	62	830502	LABEL OIL CHAIN	1
6	510127	CONTROL SHIFT 3 SPEED	1	63	900327	LABEL DANGER GUARDS	2
7	510261	HANDLE UPPER HW	1	64	400217	SPRING TENSION	1
8	830533	ROPE GUIDE	2	65	8024040	CARRIAGE BOLT 5/16"-18X1	1
9	510264	ENGINE 6.0 HP KAWASAKI	1	66	9201072	KEY SQ 3/16 X 5/8"	1
10	510265	HANDLE LOWER HW	2	67	9201071	KEY SQ 3/16 X 1 1/4"	1
11	510111	CHAIN GUARD HW	1	68	350155	NUT JAM 7/8" -14	1
12	510120	PLATE BEARING RIGHT	1	69	8160001	NUT LOCK 1/4-20 HEX ZP	3
13	510125	BEARING 1/2 CLIP	2	70	8160003	NUT LOCK 3/8-16	7
14	510126	8 TOOTH SPROCKET	1	71	8160002	NUT LOCK 5/16	20
15	510108	TRANSMISSION 3 SP	1	72	8160007	NUT LOCK 5/8-11	1
16	350146	C-CLIP 1/2	2	73	8195166	ROLL PIN 3/16 X 1.25	1
17	8172005	WASHER #10 SAE	1	74	8059136	SCREW MACHINE #10-24X 3/4	1
18	8155007	LOCK NUT #10	1	75	500144	BOLT SHOULDER 1/2" X 1"	1
19	510110	BELT GUARD HW	1	76	510208	SCREW SELF TAP 1/4 X 3/4"	8
20	8154007	NUT #10 HEX	1	77	400946	SCREW CAP 3/8-24 X 1 1/4"	1
21	510269	FRONT WHEEL BRACKET	2	78	8041031	SCREW CAP 5/16"-18X1 3/4	7
22	8172011	WASHER 1/2" ZP	10	79	8041011	SCREW CAP 1/4-20 X 2 1/4"	1
23	850443	WASHER 1/2" - 1 5/8" OD	1	80	8041023	SCREW CAP 1/4-20 X 7" ZP	1
24	510268	WHEEL FRONT 6"	2	81	510188	SCREW SELF TAP 6 X 16	3
25	900819	SPACER WHEEL FRONT	2	82	8041058	SCREW CAP 3/8-16 X 3"	2
26	510144	PLATE DEFLECTOR MOUNT	1	83	8041052	SCREWCAP 3/8-16 X 1 1/2"	4
27	510141	RUBBER DEFLECTOR	1	84	500177	LABEL CLUTCH BLADE	1
28	510137	PULLEY IDLER	1	85	8041028	SCREWCAP 5/16-18 X 1"	5
29	510237	PULLEY DOUBLE 2 1/4" W/INERTIA	1	86	8024039	CARRIAGE BOLT 5/16-18X3/4	5
30	510199	ARM IDLER TRANS WA HW	1	87	8041034	SCREWCAP 5/16-18 X 2 1/2"	1
31	510138	BELT 3L320	1	88	510213	SCREWCAP 7/16-20 X 1 GR8	1
32	510122	PULLEY 3" OD 10MM BORE	1	89	400502	TWISTED WASHER 3/8"	5
33	510191	PLATE ENGINE IDLER WA HW	1	90	430298	TWISTED WASHER 5/16"	2
34	510136	PULLEY IDLER	1	91	8041054	SCREW CAP 3/8-16 X2	4
35	510123	BRACKET TRANS LEVER	1	92	510193	WASHER 1/4 SAE BLACK	8
36	510118	PULLEY 5.5" OD X 7/8" BORE	1	93	8143001	NUT JAM 1/4 - 20	1
37	510139	BELT BLADE 5L560	1	94	8172015	WASHER 3/4 SAE	4
38	510114	SHAFT DRIVE BLADE	1	95	8171004	WASHER 3/8 FC	4
39	500232	SPACER SPINDLE BC2401	1	96	8171003	WASHER 5/16 FC	32
40	500101	BEARING 7/8" SEALED	2	97			
41	510105	SPINDLE BLADE WA HW	1	98	510180	KEY WOODRUFF 1/8 X 1/2	1
42	510116	TUBE SPACER SPINDLE	1	99	850132	WASHER LOCK 7/16 TWIST	1
43	510117	WASHER SPINDLE 2.5 OD	2	100	520087	RUBBER GROMMET	1
44	510107	BLADE 23 1/2 W 7/8 HOLE	1	101	500176	LABEL CLUTCH DRIVE	1
45	510132	CHAIN #41 75 PITCH	1	102	520045	SPACER NYLON BUSHING	2
46	510104	REAR AXLE ASSY	1	103	8041030	SCREWCAP 5/16-18 X 1 1/2	3
47				104	9201087	KEY SQ 3/16 X 2 1/8"	2
48	400268	LABEL DO NOT FILL	1	105	8041007	SCREW CAP 1/4-20 X 1 1/4	1
49	510266	WHEEL SPOKE 16"	2	106	8172007	WASHER 1/4 SAE	1
50	510197	GUARD EXHAUST CHUTE	1	107	510255	SCREW 3/8 X 1 TAPTITE	4
51	510160	DECK ASSY W/LABELS	1	108			
52	510130	PIN 3/8X 1 1/2	4	109	890301	LABEL READ MANUAL	1
53	510195	BEARING 3/4 CAST FLANGE	2	110	890254	LABEL EAR EYE BREATHING	1
54	510247	BASE ASY W/LABELS	1	111	810736	LABEL FLYING DEBRIS	1
55	510142	SPRING TRANS IDLER	1	112	510169	GROMMET 1" HOLE	1
56	510205	SPRING EXHAUST CHUTE	1	113	8161042	NUT LOCK 3/8-16 THIN	4
57	350154	WASHER LOCK 7/8 INT TOOTH	1				

Free Manuals Download Website

<http://myh66.com>

<http://usermanuals.us>

<http://www.somanuals.com>

<http://www.4manuals.cc>

<http://www.manual-lib.com>

<http://www.404manual.com>

<http://www.luxmanual.com>

<http://aubethermostatmanual.com>

Golf course search by state

<http://golfingnear.com>

Email search by domain

<http://emailbydomain.com>

Auto manuals search

<http://auto.somanuals.com>

TV manuals search

<http://tv.somanuals.com>