

BILLY GOAT KD VACUUM

Owner's Manual

KD612, KD512HC, KD512HCS

Accessories

Optional Debris bags

SHREDDER KIT	ON BOARD VACUUM HOSE KIT	NOZZLE WEAR PLATES	CASTER KIT	STANDARD TURF PRO DEBRIS BAG	DEBRIS BAG COVER	ZIPPERLESS QUICK BAG
Shreds leaves, reducing total volume.	4"(102mm) x 7' (2.13m) <i>For vacuuming in hard to reach areas.</i>	(STD. ON KD512HCS) Extends nozzle life when used along curbs and hard surfaces.	For use on hard surface.	For use in leaves and grass in non-dusty conditions.	Directs dust downward away from operator.	For non-dusty conditions that are damaging to zippers.
P/N 890209	P/N 890041	P/N 890413	P/N 890412	P/N 890028	P/N 900801	P/N 890309



ABOUT THIS MANUAL

THANK YOU for purchasing a BILLY GOAT® *KD Vacuum*. Your new machine has been carefully designed and manufactured to provide years of reliable and productive service. This manual provides complete operating and maintenance instructions that will help to maintain your machine in top running order. Read this manual carefully before assembling, operating, or servicing your equipment.

CONTENTS

SERIAL PLATE DATA AND SPECIFICATIONS _____	3
GENERAL SAFETY _____	4-5
SOUND AND VIBRATION _____	6
INSTRUCTION LABELS _____	7
PACKING CHECKLIST & ASSEMBLY _____	8
OPERATION _____	9-10
MAINTENANCE _____	11
TROUBLESHOOTING AND WARRANTY PROCEDURE _____	12
MAINTENANCE RECORD _____	13
ILLUSTRATED PARTS & PARTS LISTS _____	14-15

SERIAL PLATE DATA

Record the model number, serial number, date of purchase, and where purchased.

Purchase Date: _____

Purchased From: _____

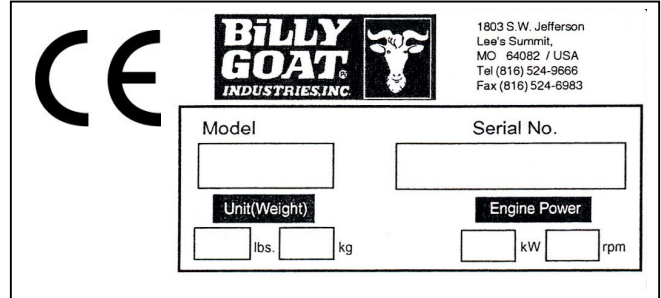

Specifications

	KD612	KD512HC	KD512HCS
Engine: HP	6.0 (4.47 kW)	5.5 (4.11 kW)	5.5 (4.11 kW)
Engine: Type	B & S QUANTUM	HONDA OHC	HONDA OHC
Engine: Model	112K020124E1	GCV160AN1A	GCV160AN1A
Engine: Fuel Capacity	1.5 qt. (1.4 L)	1.16 qt. (1.1 L)	1.16 qt. (1.1 L)
Engine: Oil Capacity	0.63 qt. (0.6 L)	0.58 qt. (0.6 L)	0.58 qt. (0.6 L)
Total Unit Weight:	98# (44.5 kg)	99# (45.0 kg)	99# (45.0 kg)
Overall Length	62" (1.57m)	62" (1.57m)	62" (1.57m)
Overall Width	26.75" (0.68 m)	26.75" (0.68 m)	26.75" (0.68 m)
Overall Height	42" (1.07m)	42" (1.07m)	42" (1.07m)
Max. operating slope	20°	20°	20°
Lwa at operator position	111 dBa	111 dBa	111 dBa
Lpa at operator position	97 dBa	97dBa	97dBa
Vibration at operator position	0.34 g (3.29m/s ²)	0.27 g (2.86m/s ²)	0.27 g (2.86m/s ²)

GENERAL SAFETY INSTRUCTIONS and SYMBOLS

The safety symbols shown below are used throughout this manual. You should become familiar with them before assembling, operating, or servicing this equipment.



WARNING: This symbol indicates important information that will prevent injury to yourself or others.



This symbol indicates ear protection is recommended when operating this equipment.



This symbol indicates eye protection is recommended when operating this equipment.



This symbol indicates gloves should be worn when servicing this equipment.



This symbol indicates that this manual and the engine manufacturer's manual should be read carefully before assembling, operation, or servicing this equipment.



CAUTION: This symbol indicates important information that will prevent damage to your BILLY GOAT[®] KD Vacuum.



This symbol indicates the engine oil level should be checked before operating this equipment.

Read and make sure you thoroughly understand the following safety precautions before assembling, operating or servicing this equipment:



READ this manual and the engine manufacturer's manual carefully before assembling, operating, or servicing this equipment.



EAR PROTECTION is recommended when operating this equipment.



EYE PROTECTION is recommended when operating this equipment.



BREATHING PROTECTION is recommended when operating this equipment.



WARNING: **EXHAUST** from this product contains chemicals known to the State of California to cause cancer, birth defects or other reproductive harm.

DO NOT operate this equipment on any unimproved forested, brushy, or grass covered land unless a spark arrester is installed on the muffler as required by Section 4442 of the California Public Resources Code. The arrester must be maintained in good working order. Other states may have similar laws. Federal laws apply on federal lands.



















DO NOT run engine in an enclosed area. Exhaust gases contain carbon monoxide, an odorless and possibly fatal poison.



KD Owner's Manual



WARNING:

-  **DO NOT** run this equipment indoors or in any poorly ventilated area. Refueling outdoors is recommended.
-  **DO NOT** refuel this equipment while the engine is running. Allow engine to cool for at least two minutes before refueling.
-  **DO NOT** store gasoline near an open flame.
-  **DO NOT** remove gas cap while engine is running.
-  **DO NOT** start or operate engine if strong odor of gasoline is present.
-  **DO NOT** start or operate engine if gasoline is spilled. Move equipment away from spill until gasoline has completely evaporated.
-  **DO NOT** smoke while filling the fuel tank.
-  **DO NOT** check for spark with spark plug or spark plug wire removed. Use an approved spark tester.
-  **DO NOT** operate engine without a muffler. Inspect muffler periodically and replace if necessary. If equipped with muffler deflector, inspect deflector periodically and replace if necessary.
-  **DO NOT** operate engine with grass, leaves or other combustible material near the muffler.
-  **DO NOT** touch muffler, cylinder, or cooling fins when hot. Contact with hot surfaces may cause severe burns.
-  **DO NOT** leave equipment unattended while in operation.
-  **DO NOT** park equipment on a steep grade or slope.
-  **DO NOT** operate equipment with bystanders in or near the work area.
-  **DO NOT** allow children to operate this equipment.
-  **DO NOT** operate equipment with guards removed.
-  **DO NOT** operate equipment near hot or burning debris or any toxic or explosive materials.
-  **DO NOT** operate equipment on slopes greater than specified in Specifications section of this manual.
-  **DO NOT** place hands or feet underneath unit, or near any moving parts.

ALWAYS remove spark plug wire when servicing equipment to prevent accidental starting.

ALWAYS check fuel lines and fittings frequently for cracks or leaks. Replace if necessary.

ALWAYS keep hands and feet away from moving or rotating parts.

ALWAYS store fuel in approved safety containers.



WARNING: Important

Remove all rocks, wire, string, plastic, etc. that can present a hazard during work prior to starting.



DO identify and mark all fixed objects to be avoided during work such as sprinkler heads, water valves, buried cables, or clothes line anchors, etc.



SOUND



111 dB

L_{wA} SOUND LEVEL 97 dB(a) at Operator Position

Sound tests were conducted in accordance with 2000/14/EEC, and were performed on 2-21-2002 under the conditions listed below.

⚠ Sound power level listed is the highest value for any model covered in this manual. Please refer to serial plate on the unit for the sound power level for your model.

General Conditions:	Sunny
Temperature:	45°F (7.2°C)
Wind Speed:	5 mph (8.1 kmh)
Wind Direction:	South West
Humidity:	60%
Barometric Pressure:	30.18"Hg (767 mm Hg)

VIBRATION DATA

VIBRATION LEVEL 0.34g (3.29m/s²)

Vibration levels at the operator's handles were measured in the vertical, lateral and longitudinal directions using calibrated vibration test equipment. Tests were performed on 5-25-2006 under the conditions listed below.

General Conditions:	Sunny
Temperature:	89°F (31.7°C)
Wind Speed:	13.6 mph (21.9kph)
Wind Direction:	East
Humidity:	22.8%
Barometric Pressure:	29.9Hg (101.3kpa)

INTENDED USE

INTENDED USE: This machine is designed for vacuuming leaves, grass clippings and other types of organic litter and for chipping brush, limbs, corn and sunflower stalks and palm fronds.

Debris mixed with cans, bottles and small amounts of sand can be vacuumed; however, it is not this machine's primary purpose. Vacuuming cans, bottles and sand will affect the longevity of your machine.

Do not operate if excessive vibration occurs. If excessive vibration occurs, shut engine off immediately and check for damaged or worn impeller, loose impeller bolt, loose impeller key, loose engine or lodged foreign objects. Note: See parts list for proper impeller bolt torque specifications. (See trouble shooting section on page 12).

INSTRUCTION LABELS

The labels shown below were installed on your BILLY GOAT® KD Vacuum. If any labels are damaged or missing, replace them before operating this equipment. Item numbers from the Illustrated Parts List and part numbers are provided for convenience in ordering replacement labels. The correct position for each label may be determined by referring to the Figure and Item numbers shown.



LABEL DANGER KEEP HANDS AND FEET AWAY
ITEM #29 P/N 400424

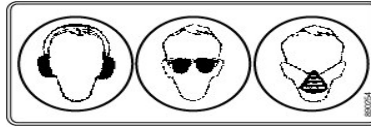

LABEL EAR EYE BREATHING ITEM #49
P/N 890254



DANGER FLYING DEBRIS
ITEM # 62 P/N 810736



LABEL READ MANUAL
ITEM #84 P/N 430363

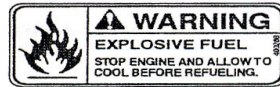

LABEL EXPLOSIVE FUEL
ITEM # 63 P/N 400268

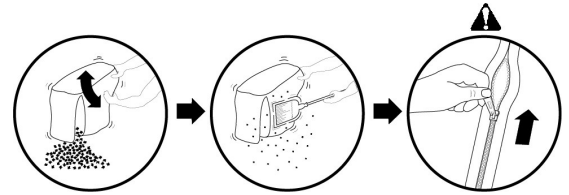

DEBRIS BAG LABEL
ITEM #1

ENGINE LABELS

HONDA

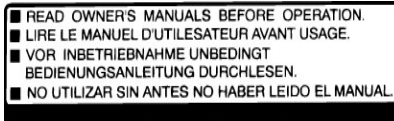

BRIGGS & STRATTON

Read Owner's Manual Before Operating.
Lire le manuel d'utilisation avant la mise en route.
Vor Inbetriebnahme Bedienungs- und Wartungsanleitung lesen.
Favor leer las instrucciones de operacion antes de operar el motor.
Consultare il Manuale Uso e Manutenzione prima dell'utilizzo.
Las Skotselinstruktionen Innan Start.

ENGINE CONTROLS

Honda

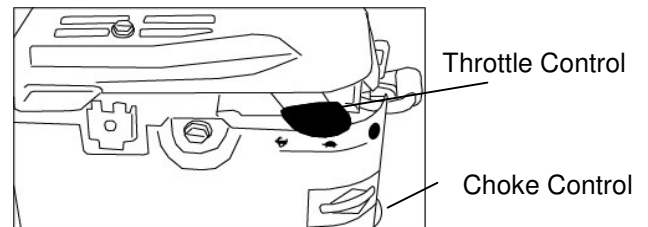
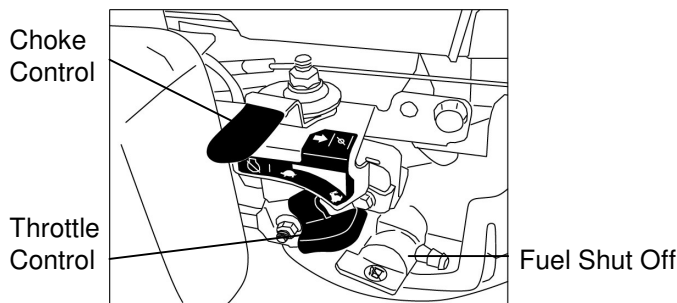

Briggs engines have a primer button carburetor rather than choke type carburetor.

PACKING CHECKLIST

Your Billy Goat KD Vacuum is shipped from the factory in one carton, completely assembled except for the upper handle, debris bag, and bag quick disconnect.



READ all safety instructions before assembling unit.

TAKE CAUTION when removing the unit from the box the Handle Assembly is attached by cables and folded over



PUT OIL IN ENGINE BEFORE STARTING

PARTS BAG & LITERATURE ASSY

Warranty card P/N- 400972, Owner's Manual P/N-890033, Declaration of Conformity P/N-890393.

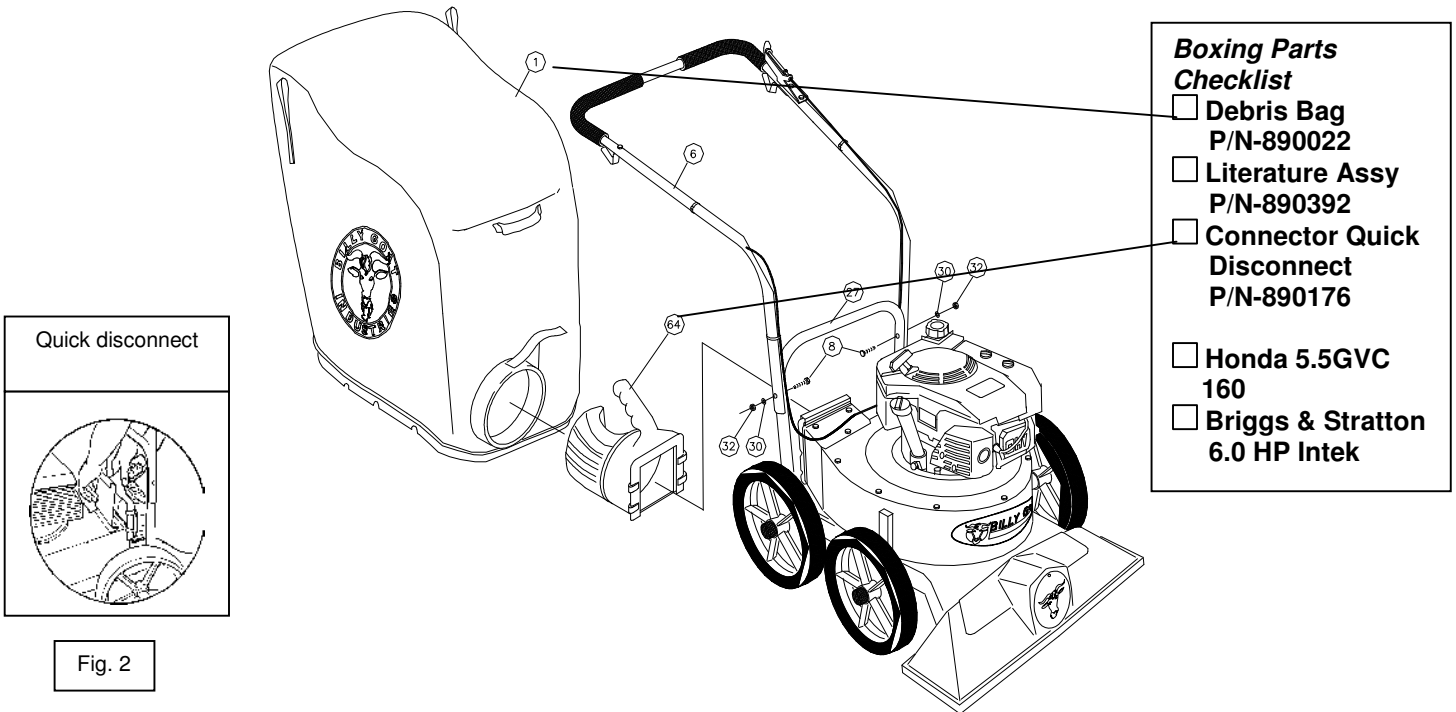

ASSEMBLY

1. **ASSEMBLE** Lift upper handle (item 6), remove items 8, 30, & 32 from lower handle (item 27). Attach and secure upper handle as shown using same hardware.
2. **UNFOLD** the debris bag (item 1) and fasten bag neck to bag quick disconnect (item 64). Attach firmly to housing exhaust (item 52) see fig. 2.
3. **ATTACH** bag hanger strap to bag supports (item 11), preassembled to upper handle.
4. **CONNECT** spark plug wire.

OPERATION

 Like all mechanical tools, reasonable care must be used when operating machine. **Inspect machine work area and machine before operating. Make sure that all operators of this equipment are trained in general machine use and safety.**

 **PUT OIL IN ENGINE BEFORE STARTING**

STARTING

 **ENGINE:** See engine manufacturer's instructions for type and amount of oil and gasoline used. Engine must be level when checking and filling oil and gasoline.

ENGINE SPEED: Controlled by throttle lever on the engine. Under normal conditions, operate at minimum throttle to accomplish your current cleaning task.

FUEL VALVE: Move fuel valve to "ON" position (when provided on engine).

CHOKE: Located on engine and must be controlled manually.

PRIMER: Push primer per engine instructions (B&S only).



THROTTLE: Located on engine and must be controlled manually.

IF YOUR UNIT FAILS TO START:

See Troubleshooting on page 12.

HANDLING & TRANSPORTING:

 This unit requires two people to lift it. With the handle in the folded position, lift holding the lower handle and belt/shaft guard one on each side of the machine. Secure the machine in place during transport. See page 3 for weight specifications

  Never lift the machine while the engine is running.

STORAGE

 Never store engine indoors or in enclosed poorly ventilated areas with fuel in tank, where fuel fumes may reach an open flame, spark or pilot light, as on a furnace, water heater, clothes dryer or other gas appliance.

If engine is to be unused for 30 days or more, prepare as follows:

 Remove all gasoline from carburetor and fuel tank to prevent gum deposits from forming on these parts and causing possible malfunction of engine. Drain fuel outdoors, into an approved container, away from open flame. Be sure engine is cool. Do not smoke. Run engine until fuel tank is empty and engine runs out of gasoline.



OPERATION

VACUUMING OPERATION

VACUUM NOZZLE HEIGHT ADJUSTMENT: is raised and lowered by pulling slightly upward on handle and pulling height adjust knob on the handle (item 23) up at left rear of machine.

FOR MAXIMUM PICKUP: Adjust nozzle close to debris, but without blocking airflow into the nozzle. *NOTE:* Never bury nozzle into debris.

CLEARING A CLOGGED NOZZLE & EXHAUST: Turn engine off and wait for impeller to stop completely and disconnect spark plug wire. Wearing durable gloves, remove clog. **Danger**, the clog may contain sharp materials. Reconnect spark plug wire.

DEBRIS BAG

Debris bags are normal replaceable wear items.

Note: Frequently empty debris to prevent bag overloading with more weight than you can lift.

An optional bag and dust cover is available for use where debris will be vacuumed in dusty conditions (**see Optional Accessories shown on page 1**).

DO NOT place bag on or near hot surface, such as engine. Run engine at 1/2 throttle for first 1/2 hour to condition new bag. Your new bag requires a break-in period to condition the pores of the material against premature blockage. The entire bag surface serves as a filter, and must be able to breath to have good vacuum performance. Be sure engine has come to a complete stop before removing or emptying bag.

This vacuum is designed for picking up trash, organic material and other similar debris (see Safety Warnings page 4-5).

However, many vacuums are used where dust is mixed with trash. Your unit can intermittently vacuum in dusty areas. Dust is the greatest cause of lost vacuum performance. However, following these rules will help maintain your machine's ability to vacuum in dusty conditions:

- Run machine at idle to quarter throttle.
- The debris bag must be cleaned more frequently. A vacuum with a clean, pillow soft bag will have good pickup performance. One with a dirty, tight bag will have poor pickup performance. If dirty, empty debris and vigorously shake bag free of dust.
- Pressure-wash debris bag if normal cleaning does not fully clean bag. Bag should be thoroughly dry before use.

***NOTE:** Having one or more spare debris bags is a good way to reduce down time while dirty bags are being cleaned.*

DO NOT leave debris in bag while in storage.

COMPOST

Vacuumed leaves, grass and other organic material from your own yard can be emptied into a pile or composter to provide enriched soil for later use as fertilizer in gardens and flower beds

NOTE: Allow green chips to dry before spreading around living plants.



MAINTENANCE

PERIODIC MAINTENANCE

Periodic maintenance should be performed at the following intervals:

Maintenance Operation	Every Use (daily)	Every 5 hrs (daily)	Every 25 Hours
Inspect for loose, worn or damaged parts.		•	
Clean Debris bag	•		
Check bag strap tightness	•		
Engine (See Engine Manual)			
Check for excessive vibration		•	
Lubricate wheels			•

IMPELLER REMOVAL

1. Wait for engine to cool and disconnect spark plug.
2. Drain fuel and oil from the engine.
3. Remove bag, quick release, and upper handle. Do not kink, stretch, or break control cables, control housings, or end fittings while removing handles.
4. Remove housing top plate by removing bolts around outside of housing.
5. Leaving engine fastened to top plate, turn it upside down so the impeller is on top.
6. Remove impeller bolt and lock washer.
7. Lift impeller upward. If impeller slides freely, proceed to (step 10).
8. Place two crowbars between impeller and housing on opposite sides. Pry impeller away from engine until it loosens. Using a penetrating oil can help loosen a stuck impeller.
9. If the impeller does not loosen, obtain a 1" (25.4mm) longer bolt of the same diameter and thread type as the impeller bolt. Thread longer bolt by hand into the crankshaft until bolt bottoms. Using a suitable gear or wheel puller against the bolt head and the impeller back-plate (near the blades), remove impeller from shaft.
10. Using a new impeller bolt and lockwasher, reinstall new impeller in reverse order.
11. Tighten impeller bolt. Torque impeller bolt to 50 Ft. Lbs. (68 N.m) (see item 51 on page 15).
12. Reinstall engine onto housing in reverse order of removal.
13. Gas and oil (0.69 quart).
14. Reinstall spark plug wire.



Troubleshooting

Problem	Possible Cause	Solution
Abnormal vibration.	· Loose or out of balance impeller or loose engine	· Check impeller and replace if required. Check engine
Will not vacuum or has poor vacuum performance	· dirty debris bag. Nozzle height set too high or low. Hose kit cap missing. Clogged nozzle or exhaust. Excessive quantity of debris.	· Clean debris bag. Shake bag clean or wash. Adjust nozzle height. Check for hose kit cap. Unclog nozzle or exhaust. Allow air to feed with debris
Engine will not start.	· Stop switch off. Throttle in off position. Engine not in full choke position. Out of gasoline. Bad or old gasoline. Sparkplug wire disconnected. Dirty air cleaner	· Check stop switches, throttle, choke position and gasoline. Connect spark plug wire. Clean or replace air filter. Or contact a qualified service person.
Engine is locked, will not pull over.	· Debris locked in impeller. Engine problem.	· See page 5. Contact a engine service dealer for engine problems
Nozzle scrapes ground in lowest height setting.	Nozzle height out of adjustment	Adjust nozzle height (See Nozzle height fine adjustment for hard surfaces on page 5

When servicing engine refer to specific manufacturers engine owner's manual. Engine warranty is covered by the specific engine manufacturer. If your engine requires warranty or other repair work contact your local servicing engine dealer. When contacting a dealer for service it is a good idea to have your engine model number available for reference (See table page 3). If you cannot locate a servicing dealer in your area you can contact the manufacturers national service organization.

To reach:

American Honda: 800-426-7701

WARRANTY CLAIM PROCEDURE

Should a BILLY GOAT[®] machine fail due to a defect in material and/or workmanship, the owner should make a warranty claim as follows:

- The machine must be taken to the dealer from whom it was purchased or to an authorized Servicing BILLY GOAT Dealer.
- The owner must present the remaining half of the Warranty Registration Card, or, if this is not available, the invoice or receipt.
- The Warranty Claim will be completed by the authorized BILLY GOAT Dealer and submitted to their respective BILLY GOAT Distributor for their territory Attention: Service Manager. Any parts replaced under warranty must be tagged and retained for 90 days. The model number and serial number of the unit must be stated in the Warranty Claim.
- The distributor service manager will sign off on the claim and submit it to BILLY GOAT for consideration.
- The Technical Service Department at BILLY GOAT will study the claim and may request parts to be returned for examination. BILLY GOAT will notify their conclusions to the distributor service manager from whom the claim was received.
- The decision by the Technical Service Department at BILLY GOAT to approve or reject a Warranty Claim is final and binding.

For online product registration go to www.billygoat.com

PARTS DRAWING KD

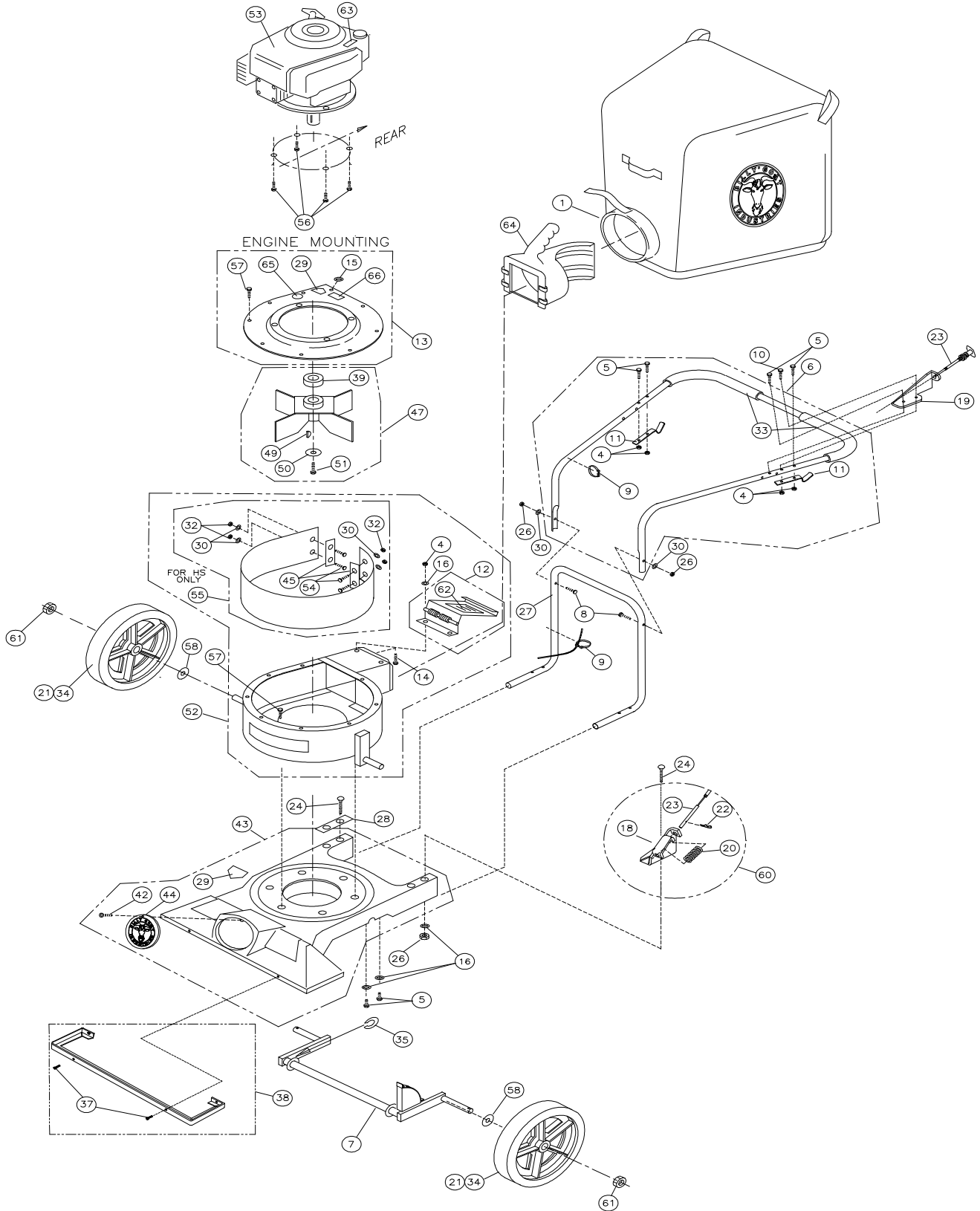



PARTS LIST

* Denotes standard hardware item that may be purchased locally.

ITEM NO.	DESCRIPTION	KD612 Part No.	QTY	KD512HC Part No.	QTY	KD512HCS Part No.	QTY
1	PRO DEBRIS BAG (service)	890305	1	890023	1	890023	1
2							
3							
4	NUT LOCK (1/4 - 20)	*8160001	7	*8160001	7	*8160001	7
5	SCREW CAP (1/4 - 20 x 1-1/2 HEX)	*8041008	8	*8041008	8	*8041008	8
6	HANDLE ASS'Y (incl. items 4(5),5(5),11(2),75(2),76)	900054	1	900054	1	900054	1
7	AXLE HEIGHT ADJUST	890389	1	890389	1	890389	1
8	SCREW HANDLE 5/16 - 18 x 1 - 3/4	*8041031	2	*8041031	2	*8041031	2
9	CLAMP CABLE	900407	2	900407	2	900407	2
10	SCREW CAP 1/4 - 20 x 1 3/4	*8041009	1	*8041009	1	*8041009	1
11	BAR BAG SUPPORT	900039	2	900039	2	900039	2
12	DOOR EXHAUST ASS'Y (incl. item 62)	890148	1	890148	1	890148	1
13	PLATE TOP ASS'Y (incl. items 29, 57, 65)	890402	1	890402	1	890402	1
14	BOLT-CARRIAGE 1/4x3/4	*8024021	2	*8024021	2	*8024021	2
15	WASHER FLAT 5/16	8172008	1	8172008	1	8172008	1
16	WASHER 1/4 FC ZP	*8171002	10	*8171002	10	*8171002	10
17							
18	BRACKET - HEIGHT ADJUSTMENT	890021	1	890021	1	890021	1
19	PLATE UPPER HEIGHT ADJUST	890005	1	890005	1	890005	1
20	SPRING	900136	1	900136	1	900136	1
21	TIRE - ONLY (PER ASSY)	900507	1	900507	1	900507	1
22	PIN - HAIR COTTER	900471	1	900471	1	900471	1
23	CABLE HEIGHT ADJUSTMENT	890019	1	890019	1	890019	1
24	BOLT - CARRIAGE 5/16 - 18 x 4 1/2	*8024054	4	*8024054	4	*8024054	4
25							
26	NUT LOCK 5/16 - 18 HEX	*8160002	6	*8160002	6	*8160002	6
27	HANDLE LOWER KD510	890346	1	890346	1	890346	1
28	PLATE HANDLE SUPPORT	900933	1 -2	900933	1 -2	900933	1 -2
29	LABEL DANGER CUT FINGER	400424	2	400424	2	400424	2
30	WASHER FLAT CUT 5/16	*8171003	2	*8171003	2	*8171003	6
31							
32	NUT LOCK 5/16 - 18 THIN HT.					*8161041	4
33	GRIP HANDLE			400570	2	400570	2
34	WHEEL ASS'Y (incl. items 21)	900509	4	900509	4	900509	4
35	WASHER 0.75 "C"	900997	0 -1	900997	0 -1	900997	0 -1
36							
37	SCREW SM 1/4x3/4 TYPE A	-	-	-	-	*8122082	4
38	PLATE SKID (incl. items 54)	-	-	-	-	890413	1
39	SPACER IMPELLER	-	-	890616	1	890616	1
40							
41							
42	SCREW SELF TAPPING 10 - 24 x 1/2	*8123086	1	*8123086	1	*8123086	1
43	NOZZLE MAINFRAME ASS'Y (incl. one of items 29,44,42)	890391	1	890391	1	890391	1
44	PLUG	900146	1	900146	1	900146	1
45	LINER HOLD PLATE	890618	2	890618	2	890618	2
46							
47	IMPELLER ASS'Y (incl. items 49, 50, 51)	900215	1	890615	1	890615	1
48							
49	KEY	900162	2	900162	2	900162	2
50	WASHER LOCK 3/8 TWISTED TOOTH	400502	1	400502	1	400502	1
51	SCREW CAP 3/8 -24 x 1 GR 8 (TORQ.50 FT-LBS)(68N.m)	900154	1	900154	1	900154	1
52	HOUSING ASS'Y (incl. items 12, 14, 15, 16, 66)	890371-S	1	890371-S	1	890417-S	1
53	ENGINE HONDA 5.5 H.P. GC160	-	-	890614	1	890614	1
54	ENGINE BRIGGS & STRATTON 6 H.P. QUANTUM IC	890622	1	-	-	-	-
55	BOLT CARRIAGE 5/16-18x3/4"	-	-	-	-	8024039	4
56	LINE PVC	-	-	-	-	900732-S	1
57	SCREW CAP 3/8 - 1-1/2 TAPTITE	890408	4	890408	4	890408	4
58	SCREW CAP 1/4 - 20 x 1/2 HWH	890359	15	890359	15	890359	15
59	WASHER FLAT 1/2 SAE	*8172011	8	*8172011	8	*8172011	8
60	SCREW SOCKET HD. 5/16 - 18 x 3/4 GR. 8						
61	HGT ADJUST ASSY (INCL. ITEMS 18, 20, 22, 23)	890013	1	890013	1	890013	1
62	1/2-13 CAP NUT NP W/PATCH	890530	4	890530	4	890530	4
63	LABEL DANGER FLYING MATERIAL	810736	1	810736	1	810736	1
64	LABEL DO NOT FILL WHEN ENGINE IS HOT	400268	1	400268	1	400268	1
65	CONNECTOR BAG QUICK	890176	1	890176	1	890176	1
66	LABEL READ OWNER'S MANUAL	890301	1	890301	1	890301	1
67	LABEL EAR/EYE BREATHING	890254	1	890254	1	890254	1

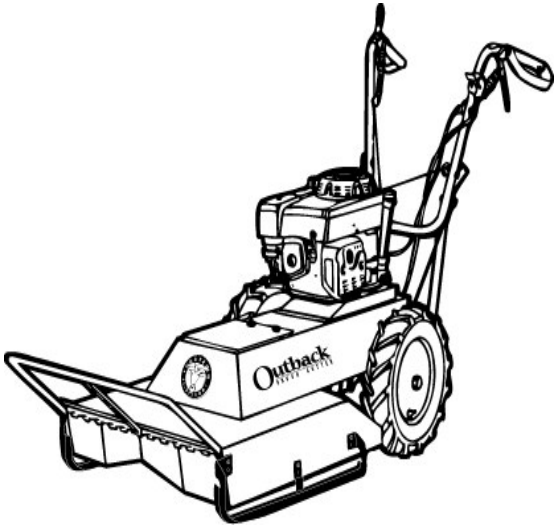

BRUSH CUTTER

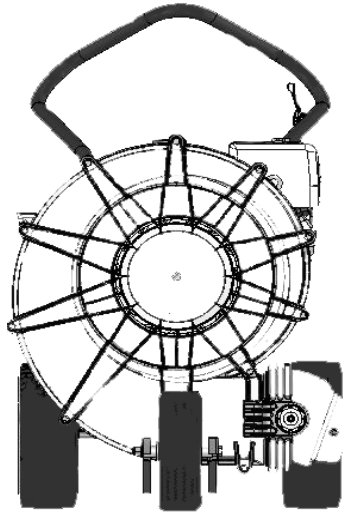

FORCE BLOWER

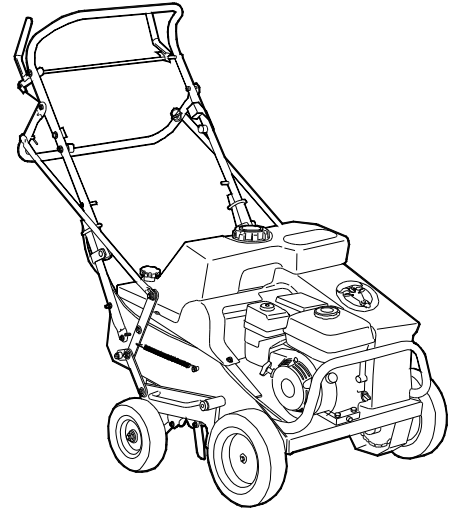

AERATOR

If you liked this product please feel free to view our full line of quality lawn care, renovation, and debris removal products at www.billygoat.com

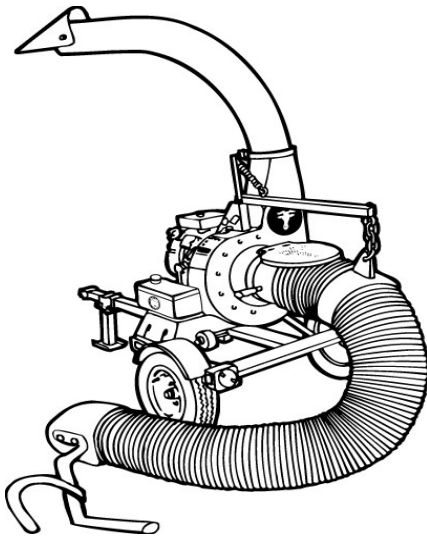

QL VACUUM

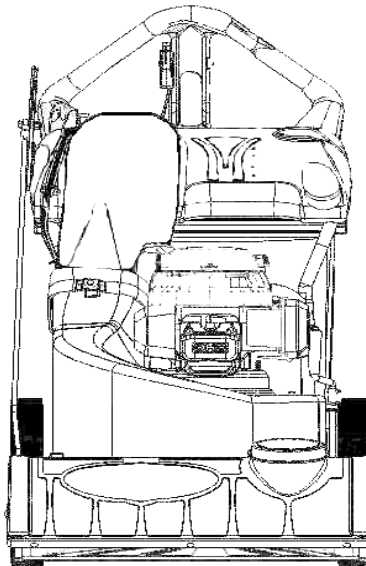

MULTI VACUUM

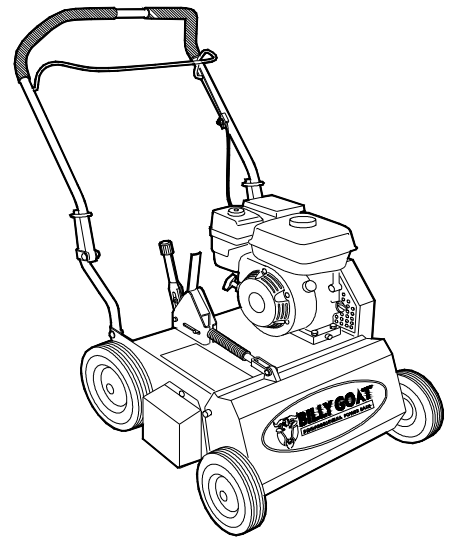

POWER RAKE



Free Manuals Download Website

<http://myh66.com>

<http://usermanuals.us>

<http://www.somanuals.com>

<http://www.4manuals.cc>

<http://www.manual-lib.com>

<http://www.404manual.com>

<http://www.luxmanual.com>

<http://aubethermostatmanual.com>

Golf course search by state

<http://golfingnear.com>

Email search by domain

<http://emailbydomain.com>

Auto manuals search

<http://auto.somanuals.com>

TV manuals search

<http://tv.somanuals.com>